

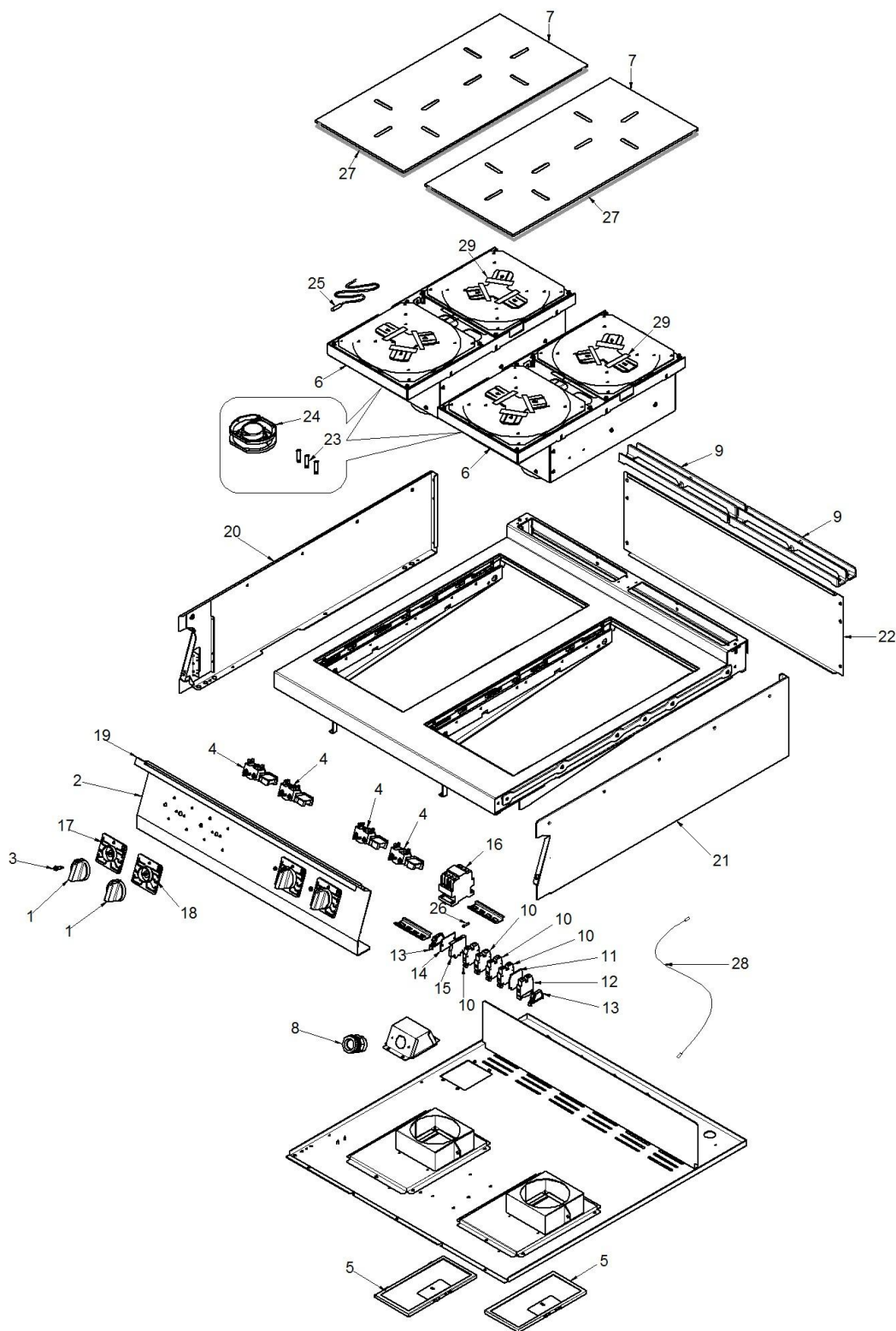











1  
HOME -> COTTURA -> ICON9000 -> 1NOVT2I -> 1



 Modifica	 Codice	 Opz.	Descrizione	 Cons.	Qtà Data validità
	1 3316250		MANOPOLA PERNO §6		4 01/04/2016-
	2 3311190		CRUSCOTTO		1 01/04/2016-
	3 3287790		SPIA VERDE		4 01/04/2016-
	4 3287800		REGOLATORE ENERGIA		4 01/04/2016-
	5 3283740		FILTRO		2 01/04/2016-
	6 3277860		GENERATORE INDUZIONE		2 01/04/2016-
	7 3307770		VETRO		2 01/04/2016-
	8 32D1780		PRESSACAVO + GHIERA		1 01/04/2016-

	9	3256600	MASCHERINA SCAR.FUMI-400 V.2	41,31	2 01/04/2016-	
	10	3210160	MORSETTO PASSANTE	6,60	4 01/04/2016-	
	11	3210150	PIASTRINA TERMINALE	0,00	1 01/04/2016-	
	12	3210190	MORSETTO TERRA	11,92	1 01/04/2016-	
	13	32D0870	BLOCCHETTO TERMINALE	4,09	2 01/04/2016-	
	14	32D1740	PIASTRINA TERMINALE	2,69	1 01/04/2016-	
	15	32D1730	MORSETTO P/FUSIB 5x20	10,54	1 01/04/2016-	
	16	3100910	TELERUTTORE BF12 230V-50/60Hz-28(12)A	60,64	1 01/04/2016-	
				X		
	17	3277811	BASE MANOPOLA	0,00	2 01/04/2016-	
	18	3277831	BASE MANOPOLA	0,00	2 01/04/2016-	
	19	3311690	STRISCIA ROSSA	9,53	1 01/04/2016-	
		20	3310890	FIANCO SX	0,00	1 01/04/2016-15/10/2017
		20	3360970	FIANCO SX	0,00	1 16/10/2017-
		21	3310900	FIANCO DX	0,00	1 01/04/2016-15/10/2017
		21	3360980	FIANCO DX	0,00	1 16/10/2017-
		22	3198740	RETRO	0,00	1 01/04/2016-15/10/2017
		22	3361680	RETRO	34,42	1 16/10/2017-
		23	3370380	FUSIBILE	18,41	1 01/04/2016-
		24	3370320	VENTOLA	387,01	1 01/04/2016-
		25	3370350	SENSORE DI TEMPERATURA	581,24	1 01/04/2016-
		26	3200020	FUSIBILE 5X20	1,29	1 01/04/2016-
		27	3370360	SIGILLANTE	141,90	1 01/04/2016-
		28	3370340	CAVO RJ45	354,76	1 01/04/2016-
		29	3370370	NASTRO ALTA TEMPERATURA	339,28	1 01/04/2016-