

Pos	Art.-Nr	-->	-->	deutsch	english
101	2002042		EB1BD0822	Aufhängung f. Handbrause	Holder for hand shower P1 P2 P3
101	2002042		ES1BD1352	Aufhängung f. Handbrause	Holder for hand shower P1 P2 P3
102	2004035			Halterung f. Kabel KTM-Fühler P2 P3	Mount for cable, core temperature sensor probe P2 P3
123	2012115			Kondensator Tischgerät m Überlauf links kpl. P3	Condenser, tabletop model with overflow on left complete P3
124	2012102			Halter Kondensator P3	Bracket, condenser P3
125	2012103			Einsatzdüse Kondensator P3	Nozzle, condenser P3
127	2013002			Vollkegeldüse 45° 1/8" P3	Full cone nozzle 45° 1/8" P3
128	2014003			Rastplatte Oberteil Tür P3	Retaining plate, upper part, door P3
129	2014005			Silikonfeder Tür P3	Silicon spring door P3
130	2014007			Scharnierplatte Unterteil kpl. P3	Lower hinge plate cpl. door P3
131	2619152			KD-Set Rasterklotz Schlitzenplatte P3	Customer service set retaining block, sliding plate P3
132	2614740			Führungsbügel Tischgeräte VST P3	Guide clip VST tabletop models P3
134	2016000			Silikonschlauch Bypass 6.10/10.10 P3	Silicon tube bypass 6.10/10.10 P3
139	2016007			Meßrohr P3	Measurement pipe P3
140	2016018			Rohrleitung Reiner Decke 6.10/10.10 geschw. P3	Pipeline cleaner cover x.10 welded 6.10/10.10 P3
142	2016020			Rohrleitung Wasser X.10 geschw. P3	Pipeline water X.10 welded P3
146	2016073			Rohrleitung IN X.10 geschw P3	Pipeline IN X.10 welded P3
147	2016111			Rohrleitung Handbrause 6.10/6.20 P3	Pipeline handshower 6.10/6.20 P3
157	2018000			Gerätetropfwanne 6.10/10.10 P3	Device drip pan 6.10/10.10 P3
163	2114799			Trägerblech KM geschw P3	Support KM welded P3
164	2114815			Verkleidungsblech VST 6.10 P3	Coating sheet VST 6.10 P3
173	2117280			KD-Set Anschlagpuffer VST P3	Customer service set for stop buffer VST P3
174	2117291			KD-Set Führungsrolle VST V-Form P3	Customer service set for guide roller VST P3
175	2117299			KD-Set Verschluss Abdeckung P3	Customer service set for cover seal P3
176	2117300			KD-Set Frontplatte OEB/OGP P3	Customer service set for front plate OEB/OGP P3
177	2117301			KD-Set Frontplatte OES/OGS P3	Customer service set for front plate OES/OGS P3
178	2117302			KD-Set Frontplatte OES/OGS Press & Go P3	Customer service set for front plate OES/OGS Press & Go P3
196	2214186			Einhängegestell 6.10 links geschw P3	Rack 6.10 left welded P3
197	2216181			Einhängegestell 6.10 rechts geschw P3	Rack 6.10 right welded P3
204	2216660			Einhängegestell 6.10 BN links geschw. P3	Rack 6.10, left side, for sheets 40x60 cm
205	2217060			Einhängegestell 6.10 BN rechts geschw. P3	Rack 6.10, right side, for sheets 40x60 cm
208	2216674		EB1BL1715	Ansaugblech EL DE 6.10 kpl P3	Suction panel EL DE 6.10 cpl P3
209	2216675		ES1BL2906	Ansaugblech EL IN 6.10 kpl P3	Suction panel EL IN 6.10 cpl P3
214	2216796			Abdeckung Entfeuchtungsrinne kpl P3	Cover dehumidification channel cpl P3
215	2217000			Einhängegestell 6.10 CCS links geschw P3	Rack 6.10 CCS left welded P3
216	2217061			Einhängegestell 6.10 CCS rechts geschw P3	Rack 6.10 CCS right welded P3
225	2217276			KD-Set Abschirmblech Garraumfühler 6.10 EL IN P3	Service set screen plate for oven chamber sensor 6.10 EL IN
229	2217281			KD-Set Bypass-Abdeckung P3	Customer service set for bypass cover P3
230	2217288			KD-Set Druckregulierungsventil IN P3	Customer service set for pressure regulating valve IN P3
231	2217289			KD-Set Einspritzverteiler 6.10 EL P3	Customer service set for G424 6.10 EL
233	6002100			Schnellverschluss-Ansaugblech	replacement quick fastener for suction panel
242	2217332			KD-Set Einspritzdüse 0,5 mm P3	Customer service set for fuel injection nozzle 0.5 mm P3
246	2314243			DE EL/GAS Aufhängung Tischgeräte u. 12.20 P3	Steam generator EL/GAS suspension countertop models and 12.2
250	2317306			KD-Set DE EL 6.10 P3	Customer service set DE EL 6.10 P3
259	2514350			Tür 6.10 kpl P3	Door 6.10 cpl P3
268	2518479			KD-Set Innentür 6.10 P3	Customer service set interior door 6.10 P3
276	2517292			KD-Set Innentürscharnier P3	Customer service set for interior door hinge P3
277	2517296			KD-Set Scharnier ob P3	Customer service set for upper hinge P3
278	2517297			KD-Set Scharnier unt P3	Customer service set for lower hinge P3
279	2608962			Unterdrucksicherung kpl	Suction relief device complete P2 P3
280	2609347			Kanister-Saugschlauch Reiniger kpl	Suction tube for detergent
281	2609349			Kanister-Saugschlauch Düsenpülung kpl	Suction tube for flushing agent
282	2611010			Sprinklerdüse geschweißt	Sprinkler head welded
283	2611184			Rotordüse kpl	Rotor nozzle complete
284	2614253			Gegenflansch für Rohrheizkörper Einzelring P3	Counterflange for tubular heating element, single ring
295	2616469			Türtropfwanne 6.10/10.10 kpl P3	Door drip tray 6.10/10.10 cpl P3
297	2617282			KD-Set Drehstrommotor 4/8pol 0,6kW 200-240V 60Hz/200V 50Hz P	Customer service set for 3-phase motor 4/8-pin 0.6kW 200-240
298	2617283			KD-Set Drehstrommotor 4/8pol 0,6kW 380-415V 50Hz / 380-480V	Customer service set for 3-phase motor 4/8-pin 0.6kW 380-415
301	2617286			KD-Set Drehstrommotor 4pol 0,6kW alle Spannungen P3	Customer service set for 3-phase motor 4-pin 0.6kW all volta
303	2617293			KD-Set Lüfterradbefestigung P3	Customer service set for fan wheel mounting P3
304	2617294			KD-Set Motorbefestigung P3	Customer service set for motor mounting P3
305	2617295			KD-Set Motorwelledichtung P3	Customer service set for motor shaft seal P3
315	2216090			Abdeckung Zuluftkasten mont P3	Cover, air inlet box assembled P3
318	3007061			Schmutzsieb für Convocare	Filter for Convocare
335	3416730			Wasserinstallationsset P3	Water installation set P3
336	3417275			Nachstellset Türdichtung P3	Kit for adjusting door gasket P3
337	4007087			Kabelbinder 140 x 3,6; hitzebeständig bis 220°C	Cable tie 140 x 3.6 heat resistant to 220°C
338	5001041			Sicherheits-Temperaturbegrenzer eigenbruchsicher 340°C	Safety temperature limiter, internal breakage-proof
339	5001059			Einfachmagnetventil 220/240V 50/60 Hz	Solenoid valve 220/240 V ODgas
340	5001080			Doppelmagnetventil 220-240V 50/60Hz	Double solenoid valve 220 - 240V 50Hz
341	5002061			KD-SET KTM-Dichtungssatz	Customer service seal set for CTS
342	2219137			KD-Set KTM-Fühler Sous-Vide P3	Customer service set CTS probe "sous vide" P3
344	5002094			Stecker X2 OSC, OSG, OSP P2 P3	Plug X2 OSC, OSG, OSP P2 P3
346	5002096			Stecker X11, X12 Picto "Press and Go" P2 P3	Plug Picto "Press and Go" P2 P3
347	5002100			Thermoelementfühler 3050 mm P2 P3	Thermocouple probe 3050 mm P2 P3
348	5002104			STB Thermoelementfühler 2,80 m P2 P3	Safety temperature limiter (STB) thermocouple sensor 2.80m P
349	5003075			Türkontaktschalter berührungslos:28,57x19,05x6,35,2Langlöch.	Door magnet switch
352	5008011			Pumpe für Garraumreinigung 200-240V P2 P3	Pump for auto cleaning 200-240V P2 P3
353	5008079			Entleerungspumpe mit Synchronmotor 200-240V	Drain pump with synchronous motor 200-2
354	5013051			Druckschalter für automatische Garraumreinigung P2 P3	Pressure switch for auto. oven cleaning P2 P3
355	5009301			Steuerung 5000 VM (Versorgungsmodul) P2 P3	Controller, 5000 supply module P2 P3
356	5009304			Verbindungskabel SM auf BM Steuerung 5000 P2 P3	Connection cable SM to BM electronic board 5000 P2 P3
357	5009306			Tasterkappe 8,7 mm weiß P2 P3	Cap for key 8.7 mm white electronic P2 P3
358	5009315			Anschlusskabel RS232 für P2 P3	Connection cable RS232 for P2 P3
359	5009320			Einstellwippe komplett P2 P3	Adjusting rocker complete P2 P3
360	5011000			Dreifachmagnetventil 220-240V 50/60 Hz 180° P3	Solenoid valve triple 220-240V 50/60 Hz 180° P3
362	5011002			Wasserverteiler DN 13 P3	Water distributor DN 13 P3
363	5011003			T-Verbindungsstück WA 2x3/4" 1x1/2" P3	T-joining piece WA 2x3/4" 1x1/2" P3
365	5012001			Stecker direkt 7pol. RM 5 mm P3	Plug direct 7pol. RM 5 mm P3
366	5012002			Stecker direkt 8pol. RM 5 mm P3	Plug direct 8pol. RM 5 mm P3
367	5012003			Stecker direkt 12pol. RM 3,5 mm P3	Plug, direct, 12-pin RM 3.5 mm P3 ZEC 1
368	5012004			Stecker direkt 10pol. RM 3,5 mm P3	Plug, direct, 10-pin RM 3.5 mm P3 ZEC 1
370	5013001			Kerntemperatur-Meßfühler Mehrpunkt kpl. P3	CTS, multipoint complete P3
372	5015002			Glas für Garraumleuchte P3	Glass for cooking space lamp P3
373	5015003			Rahmen für Garraumleuchte P3	Rahmen für Garraumleuchte P3
374	5018028			Schwingkolbenpumpe MOD CP6 230V P3	Piston pump MOD CP6 230V P3
378	2619179			KD-Set THK L420 Stern 9,9 kW 230V kpl P3	Customer service set, immersion heater L420 star 9.9 kW complete P3
386	2619186			KD-Set THK L420 Litze 9,9 kW 200V kpl P3	Customer service set, immersion heater L420 braid 9.9 kW 200 V complete
388	2619188			KD-Set THK L420 Litze 9,9 kW 230V kpl P3	Customer service set, immersion heater L420 braid 9.9 kW 230 V complete
392	2619192			KD-Set RHK Ø410 Stern 10,5 kW 230V kpl P3	Customer service set, tubular heating element Ø410 braid 10.5 kW 230 V complete
393	2619193			KD-Set RHK Ø410 Litze 10,5 kW 230V kpl P3	Customer service set, tubular heating element Ø410 braid 10.5 kW 230 V complete
394	2619194			KD-Set RHK Ø410 Litze 10,5 kW 200V kpl P3	Customer service set, tubular heating element Ø410 braid 10.5 kW 200 V complete
401	5018023			Zusatzlüfter Sunon KD1212 PMBX-6A IP 54/55 P3	Additional fan Sunon KD1212 PMBX-6A IP 54/55 P3
402	5019000			Doppelniveausonde P3 kpl	Double-level probe P3 complete
403	5019100			Steuerung 5010 Steuermodul SM P3	Controller, 5010 control module P3
404	5019101			Steuerung 5010 Bedienmodul BM P3	Controller, 5010 operating module P3
406	5019104			Steuerung 5010 Kommunikationsmodul KM P3	Electronic board 5010 KM (Communication module) P3

Pos	Art.-Nr	-->	-->	deutsch	english
407	5019105			Steuerung 5010 Press and Go-Modul P3	Controller, 5010 Press and Go-Modul P3
409	6004039			Stellfuß verstellbar 2" Schiffsausführung	Adjustable foot 2" Marine Version
410	6004044			Gerätefuß verstellbar 2" Metall	Device foot, adjustable 2" metal P2 P3
411	6005005			Handbrause 1/2" Außengewinde	Hand shower 1/2" outside thread
412	6005006			Brausekopf 3/8"	Shower head 3/8"
413	6005007			Winkel für Handbrause	Bracket for hand shower
414	6005016			Flachdichtung 10x19x2 mm Novapress 800F ODC	Flat seal 10x19x2mm ODC P2 P3
415	6005025			Flachdichtung 42,5 x 54 x 2 f. Dichtung 1 1/4"	Flat seal d=42,5x54x2 mm
416	6005048			Membrantülle Ø 60 (DG 48), Polychloropren-Kautschuk, Stanz-o60	Membrane grommet DG 48 Ø 60mm
418	6005055			Dichtring 14,5x20x2,best.geg.v.Wasser,Dampf,Gas; -55+300°C	Sealing ring 14x20 copper nickel plated for heating element
419	6005068			O-Ring 42,5x5,33mm, Silikon Gummi	O-ring 42,5x5,33mm
420	2619149			KD-Set Druckschalter REI P3	Customer service set, pressure switch REI P3
421	6005236			O-Ring 53x3 f. Dampferzeuger Entleerungspumpe P2	O-Ring 53x3 for steam generator emptying pump P2
422	6005254			Rändelmutter M3 P2	Knurled nut M3 P2 P3
423	6005260			Thermoelementfühler-Dichtung P2 P3	Thermocouple sensor seal P2 P3
424	6005299			Stützhülse DE-Pumpe P2 P3	Support bushing steam generator pump P2 P3
428	6005409			Mutter für Düsenhalterung P2	Nut for nozzle holder P2
429	6005412			Düse 0,7 P2	Nozzle 0,7 P2
430	6005413			Düse 1,5 P2	Nozzle 1,5 P2
431	6005414			Winkel-Schlauchverbindungsstutzen 6mm	Hose coupling (elbow) 6mm
432	6005416			Winkelanschlussstück 6x1/8" 90°	Angle connector 6x1/8" 90° P2 P3
433	2619150			KD-Set Schottverschraubung P3	Customer service set, bulkhead union P3
434	6005427			Membrantülle Ø83 (DG60)	Membrane grommet Ø83 (DG60)
435	6006086			Schlauchbinder 1/2" 12-20mm	Hose clip 1/2" 12-20mm
436	6006087			Schlauchbinder 25-40mm	Hose clamp 25-40 mm P2/P3
437	6006089			Schlauchbinder 40-60mm	Hose clamp 40-60 mm P2/P3
438	6006092			Sechskantmutter V2A R 1 1/4"	Hexagon nut R 1 1/4" A2 P2 P3
439	6006122			Schlauchbinder 7-11mm ODgas	Hose clamp 7-11 mm OD gas P2 P3
440	2519151			KD-Set Innentürscharnier AS P3	Customer service set for interior door hinge P3
442	6010001			Ventilatorrad Ø 350x110 P3	Fan wheel Ø 350x110 P3
444	6012000			Drehhebelverschluss kpl. P3	Rotating lever lock, complete P3
445	6012001			Kloben kpl. P3	Block, complete P3
446	2619153			KD-Set Türanschlag VST P3	Customer service set, door stop VST P3
447	2619154			KD-Set Stützleiste VST P3	Customer service set, support strip VST P3
448	2619155			KD-Set Führungsleiste un VST P3	Customer service set, guide strip, lower VST P3
449	6014000			Schlauchanschluss Pumpen Druckseite P3	Hose connection, pump pressure side P3
450	6014001			Schlauchanschluss Pumpen Saugseite P3	Hose connection, pump suction side P3
451	6014003			Eckventil 1/2" x 1/2" P3	Corner valve 1/2" x 1/2" P3
452	6014004			Eckventil Zierblende P3	Corner valve, ornamental cap P3
459	6015000			O-Ring 67x4 P3	O-ring 67x4 P3
460	6015020			Dichtung Garraumleuchte P3	Seal for oven lamp P3
462	6015023			Flachdichtung für Tauchheizkörper P3	Flat seal for immersion heating element P3
464	6015025			Flachdichtung f. Rohrheizkörper Einfachring P3	Flat seal for ring of heating element P3
465	6015026			Dichtung KTM-Durchführung P3 G	Seal, core temperature sensor feed-through P3 G
476	6015040			Flachdichtung für Doppelniveauaussonde P3	Flat seal for water level probe P3
478	6015042			Dichtungstülle Tropfwanne P3	Sealing socket for drip tray P3
479	6015060			Kupfer-Dichtring vernickelt 18x24x1,5 P3	Copper seal ring nickel-plated 18x24x1.5 P3
480	6015062			Kupfer-Dichtring 10x14 vernickelt P3	Copper seal ring 10x14 nickel-plated P3
481	6015100			Ablaufwinkel für Dampferzeuger P3	Elbow for steam generator drainage P3
482	6015200			Abstandshalter Tür P3	Spacer for door P3
484	6015248			Halteklammer Tür P3 Tischgerät	Retaining clamp, door P3 countertop model
487	6015205			Schlauchanschluss Entfeuchtung P3	Hose connection dehumidifier P3
489	6015212			Auflagegestift Ansaugeblech P3	Support pin, intake panel P3
490	6015213			Abstandsbochse Motor 33mm P3	Spacer bushing, motor 33 mm P3
491	6015215			Winkel-Schlauchanschluss 3/8" m. Dichtung P3	Elbow hose connection 3/8" with seal
492	6015216			Düse IN P3	Nozzle IN P3
493	2619156			KD-Set Sicherungsklotz VST P3	Customer service set, security block VST P3
494	6015227			Röhrmutter G 1/2" DIN 431 A2 P3	Hexagon inch nut G 1/2" DIN 431 A2 P3
495	6015229			Gewindehülse Druckschalter P3	Threaded bushing, pressure switch P3
501	6015241			Auflagegestift EHG P3	Support pin, EHG P3
514	6016500			Rücksaugabsicherung für DE kpl. P3	Back absorption safety device for steam generator cpl. P3
515	6016517			Tasterkappe grau Press and Go P3	Push button cap grey Press and Go P3
517	6019020			Press and Go Symbole P3	Symbols for Press and Go P3
520	6011010	EB1BD0823		Handbrause Tischgeräte P3	Hand shower, table top units P3
520	6011010	ES1BD1353		Handbrause Tischgeräte P3	Hand shower, table top units P3
521	6011012	EB1BD0823		Aufhängung Handbrause Tischgerät P3	Holder for hand shower, table top units P3
521	6011012	ES1BD1353		Aufhängung Handbrause Tischgerät P3	Holder for hand shower, table top units P3
522	7001066			Kantenschutzprofil 9+6 Klemmer.0.8-1,PVC m.Metallklemmb(nd.	Edge protector with metal insert P2 P3
524	7002006			PVC-Wasserschlauch ohne Einlagen Polyform 6/2	PVC hose without lining polyform 6/2
525	7002002			PVC-Wasserschlauch ohne Einlagen rot Polyform 6/2	PVC hose without lining, red polyform 6/2
527	7002033			Heisswasserschlauch 3/8" P2 P3	Water hose for hot water 3/8" P2 P3
528	3417550			Überlaufset P3	Overflow set P3
530	2617250			KD-Set Reinigerpumpeneinheit 230V P3	Customer service set, cleaner pump unit 230V P3
538	7011001			Türdichtung 6.10 P3	Door gasket 6.10 P3
545	7011010			Dichtung Frontplatte P3	Gasket front cover P3
553	7012010			Abluftschlauch 6.10 P3	Air outlet hose 6.10 P3
557	7012014			Kühlerschlauch für Pumpe 400 mm lang P3	Radiator hose for pump 330 mm long P3
564	7012070			Brauseschlauch 6.10/6.20 P3	Shower hose 6.10/6.20 P3
568	7012080			Heisswasserschlauch 1/2" P3	Hose 1/2" P3
573	7012300			Silikon Schlauch 450 mm D. 12x2 6.10/10.10 P3	Silicon tube 450 mm D. 12x2 6.10/10.10
575	7012302			EPDM-Schlauch ohne Einlage 6x2mm schwarz Pr P3	EPDM hose, unlined 6x2 mm black
576	7015200			Abzieher für Lüfterrad P3	Drawer for fan wheel P3
577	8001012			Linsenschraube M3x6 DIN7986 A2	Oval head screw M3 x 6 DIN7986 A2
579	8001024			Linsenschraube M4x10 DIN7985 A2	Oval head screw M4 x 10
585	8002043			Linsenschraube M6x12 DIN 966 A2 P2 P3	Rounded countersunk head screw M6x12 A2 P2 P3
587	8003029			MLF-Schraube M5x10 A2 P2 P3	MLF screw M5x10 A2 P2 P3
588	8003030			MLF-Schraube M5x15 A2	MLF-screw M5x15 A2
589	8003032			MLF-Schraube M6x20 A2	MLF Screw M6x20 A2
590	8003035			Sechskantschraube M5x10 A2 P2 P3	Hexagon bolt M5x10 A2 P2 P3
592	8003046			Sechskantschraube M6x30 DIN933 A2	Hexagon bolt M6x30 A2 P3
594	8004012			Sechskantmutter M3 DIN934 A2	Hexagon nut M3 A2 P2 P3
597	8005021			Scheibe 4,3 DIN125 A2	Washer 4.3 A2 DIN 125 P3
598	8005040			Scheibe 6,4 DIN125 A2	Washer 6.4 A2 DIN 125 P2/P3
600	8006011			Federring B3 DIN127 A2	Spring ring B3 A2 P2/P3
602	8006058			Schnorr-Sicherungscheibe S5 P2/P3	Schnorr lock washer S5 A2 P2/P3
606	8009030			Distanzhülse 11,3mm P2	Spacer sleeve 11.3 mm P2/P3
607	8009057			Drahtschelle D.36 schwarz P2/P3	Fixing clamp D.36 black P2/P3
608	8009058			Drahtschelle D. 10	Fixing clamp D. 10 P2/P3
609	8002015			Linsenschraube M3x10 A2	Flat oval head screw M3 x 10 A2
610	8017008			Sperrzahnmutter M3 A2 P3 KG	Toothed lock nut M3 A2 P3 SA
611	8010001			Insenschkantschraube DIN EN ISO 10642 M6x35 A2 P3	Hexagon socket screw DIN EN ISO 10642
614	8013003			Zylinderschraube DIN 7984 - M6x70 A2 P3	Fillister head screw like DIN 6912 - M6x70 A2 P3
615	8013004			Sechskantschraube M4x10 A2 P3	Hexagon screw M4x10 A2 P3
621	8015000			MLF-Schraube M6x8 A2 P3	Screw MLF M6x8 A2 P3
622	8016000			Schnorr-Sicherungscheibe Ø20mm P3	Conical lock washer Ø20mm P3
624	8016002			Schnorr-Sicherungscheibe S4 A2 P3	Conical lock washer S4 A2 P3
625	8017010			Sperrzahnmutter M5 A4 P3	Toothed lock washer M5 A4 P3

Pos	Art.-Nr	-->	-->	deutsch	english
626	8017011			Sperrzahnmutter M6 A4 P3	Toothed lock washer M6 A4 P3
628	8019004			Kappe Verschlusschraube P3	Cap screw plug P3
629	8019010			Drahtschelle D.16 P3	Wire clamp D.16 P3
632	6014006			Drehkappe für Eckventil 1/2" x 1/2" P3	Turncap for Corner Valve 1/2" x 1/2" P3
635	2618779			KD-Set Glühlampe 230V/25W P3	Customer service set, light bulb 230V/25W P3
636	2618780			KD-Set Garraumleuchte kpl P3	Customer service set, oven light complete P3
641	2618785			KD-Set Befestigung Steuerung P3	CS Set Controller attachment cP3
689	2619138			KD-Set Führungsschiene VST 30x16 6.10/10.10 P3	Customer service set, guide rail VST 30x16 6.10/10.10 P3
692	2619141			KD-Set Führungsrolle VST 30x16 P3	Customer service set, guide roller VST 30x16 P3
693	2619142			KD-Set VST 6.10 kpl P3	Customer service set, VST 6.10 complete P3
700	2114741	EB1BE0959		Abdeckung hi EL/GAS IN 6.10 kpl P3	Cover, rear EL/GAS IN 6.10 complete P3
700	2114741	ES1BE1517		Abdeckung hi EL/GAS IN 6.10 kpl P3	Cover, rear EL/GAS IN 6.10 complete P3
714	2114781	EB1BE0959		Abdeckung li 6.10 kpl P3	Cover, left 6.10 complete P3
714	2114781	ES1BE1517		Abdeckung li 6.10 kpl P3	Cover, left 6.10 complete P3
721	2115441			Frontteil 6.10 vormont P3	Front piece 6.10 preassembled P3
728	2114632			Eckteil hi li 6.10 P3	Corner piece, rear left 6.10 P3
733	2114700	EB1BL1719		Außendecke EL 6.10/10.10 P3	Outer cover EL 6.10/10.10 P3
733	2114700	ES1BL2998		Außendecke EL 6.10/10.10 P3	Outer cover EL 6.10/10.10 P3
751	2114508			Abdeckung Pumpenauschnitt P3	Cover pump cutout P3
757	2117411	EB1BE0960		Abdeckung li gesteckt 6.10 kpl P3	Cover, left inserted 6.10 complete P3
757	2117411	ES1BE1518		Abdeckung li gesteckt 6.10 kpl P3	Cover, left inserted 6.10 complete P3
764	2117431	EB1BE0960		Abdeckung hi gesteckt EL/GAS IN 6.10 kpl P3	Cover, rear inserted EL/GAS IN 6.10 complete P3
764	2117431	ES1BE1518		Abdeckung hi gesteckt EL/GAS IN 6.10 kpl P3	Cover, rear inserted EL/GAS IN 6.10 complete P3
781	2118227	EB1BL1720		Außendecke EL int 6.10/10.10 P3	Outer cover EL int 6.10/10.10 P3
781	2118227	ES1BL2999		Außendecke EL int 6.10/10.10 P3	Outer cover EL int 6.10/10.10 P3
783	2218078	EB1BL1716		Ansaugbl. RV EL DE 6.10 kpl P3	Suction panel RV EL DE 6.10 complete P3
784	2218075	ES1BL2907		Ansaugbl. RV EL IN 6.10 kpl P3	Suction panel RV EL IN 6.10 complete P3
801	8009022			Blechmutter 14x11 Gewinde 4,8	Plate nut 14x11 screw 4.8
802	8012003			Linien-Biegeschraube 4,8x32 DIN7981 A2 P3	Pan-headed tapping screw 4.8x32 DIN7981 A2 P3
803	2114627	app. 01/07		Bodenklappe Kondensator P3	Bottom flap, condenser P3
805	2119228	app. 01/07		Bodenklappe Kondensator m Überlauf links P3	Bottom flap, condenser with overflow left P3
902	3007029			Convocare Leerkanister 10 L	Convocare empty canister 10 L
903	6009016			Kunststoffbuchstabe "C" rot, 90x62x2mm,ABS-orange"PH-AT 337"	Plastic letter "C", red (Red C) P2
904	6019104			Aufkleber: Wasserqualität und Anschluss P3	Sticker: Water quality and connection, P3
905	6019106			Aufkleber: Gasdaten P3	Sticker: Gas data, P3
906	6019107			Aufkleber: manuelle Reinigung P3	Sticker: Manual Cleaning, P3
907	7002024			Fettablaufschauch 1" für Hähnchen-Ausführung	Grease drain hose 1" for chicken version
908	7003066			Dichtungsband 9x3 EPDM	Sealing tape 9x3 EPDM P2 P3
909	7003087			Fettkartusche 400gr. V-T)re OD	Grease cartridge 400 gr. front doors OD P2 P3
910	7004012			Sicherungsmittel Loctite Typ 243e	Loctite 243 10ml P3
911	7004013			Schraubensicherungslack	Screw lock varnish P2 P3
912	7004020			Silikonkleber E 43	Silicon adhesive E 43 90 ml P2 P3
914	7014003			Loctite 8001 - Schmiermittel P3	Loctite 8001 - lubricant P3
915	3019007			KD-Set Wasseranalysegerät	Customer service set, water analysis device
916	5019200			USB Konverter auf seriell RS232 P3	USB converter to serial RS232 P3

Technische Neuentwicklungen, Änderungen und Irrtümer vorbehalten.

New technical developments, changes and errors excepted.

Pos	Art.-Nr	-->	-->	français	español
407	5019105			Commande électronique 5010 Press and Go-Modul P3	Mando 5010 Press and Go-Modul P3
409	6004039			Pied réglable en hauteur 2" mital avec bride de fixation an	Pie regulable para versión de barco con placa de brida a ato
410	6004044			Pied réglable	Pie regulable
411	6005005			Douchette 1/2"	Ducha de mano 1/2"
412	6005006			Tête de douchette 3/8"	Cabezal rociador 3/8"
413	6005007			Angle pour douchette	Angulo para ducha de mano
414	6005016			Joint plat 10x19x2mm ODC	Junta plana 10x19x2mm ODC
415	6005025			Joint plat 42.5x54x2mm P3	Junta plana 42.5x54x2mm P3
416	6005048			Joint de cheminée Ø 60mm	Manguito de membrana Ø 60mm
418	6005055			Joint en cuivre nickelé pour resistance circulaire 14x20	Junta tórica para calefacción de aire caliente niquelada 14x
419	6005068			Joint torique 42.5x5.33mm	Anillo tórico 43.82x5.33 P2 P3
420	2619149			Kit SAV interrupteur manométrique	Juego serv. técnico interruptor pulsante REI P3
421	6005236			Joint torique 53x3 pour pompe d'évacuation P2	Junta tórica 53x3 para bomba evacuación P2
422	6005254			Ecrou moleté M3 P2	Tuerca moleteada M3 P2
423	6005260			Joint pour thermocouple sonde P2 P3	Obturation para termoelemento sonda P2 P3
424	6005299			Gaine de protection pompe GV P2 P3	Casquillo de apoyo bomba GV P2 P3
428	6005409			Ecrou pour fixation tuyère P2	Tuerca para fijación para hilera P2
429	6005412			Tuyère 0,7 P2	Tobera 0,7 P2
430	6005413			Tuyère 1,5 P2	Tobera 1,5 P2
431	6005414			Raccord pour tuyaux (angle) 6mm	Unión de mangueras (ángulo) 6mm
432	6005416			Embout coude 6x1/8" 90°	Codo de expalme 6x1/8" 90°
433	2619150			Kit SAV raccord passe-cloison P3	Juego serv. técnico racor de paso del mamparo P3
434	6005427			Joint de cheminée Ø83 (DG60)	Manguito de membrana Ø83 (DG60)
435	6006086			Collier de serrage 1/2" 12-20mm P2/P3	Cinta de sujeción para mangueras 1/2" 12-20mm P2/P3
436	6006087			Collier de serrage 25-40mm P2/P3	Cinta de sujeción para mangueras 25-40mm P2/P3
437	6006089			Collier de serrage 40-60mm P2/P3	Cinta de sujeción para mangueras 40-60mm P2/P3
438	6006092			Ecrou hexagonal R 1 1/4" A2 P2 P3	Tuerca hexagonal R 1 1/4" A2 P2 P3
439	6006122			Collier de serrage 7-11mm ODgas P2 P3	Cinta de sujeción para mangueras 7-11mm ODgas P2 P3
440	2519151			Kit SAV charnière de porte intérieure AS P3	Juego serv. técnico bisagra de puerta interior P3
442	6010001			Hélice de ventilateur Ø 350x110 P3	Rueda de ventilador Ø 350x110 P3
444	6012000			Poignée de porte P3 cpl.	Empuñadura P3 cpl.
445	6012001			Valet de porte P3 cpl.	Gozne de puerta P3 cpl.
446	2619153			Kit SAV cale-porte escamotable P3	Juego serv. técnico tope de puerta VST P3
447	2619154			Kit SAV listel de support porte escamotable P3	Juego serv. técnico regleta de apoyo VST P3
448	2619155			Kit SAV listel de guidage inf. porte escamotable P3	Juego serv. técnico regleta de guía VST P3
449	6014000			Raccord de tuyau pompe côté refoulement P3	Empalme de manguera lado de impulsión P3
450	6014001			Raccord de tuyau pompe côté admission P3	Empalme de manguera lado de succión P3
451	6014003			Soupape d'équerre 1/2" x 1/2" P3	Válvula angular 1/2" x 1/2" P3
452	6014004			Soupape d'équerre enjoliveur P3	Válvula angular, embellecedor P3
459	6015000			Joint torique 67x4 P3	Junta tórica 67x4 P3
460	6015020			Joint pour enceinte de cuisson P3	Junta para luz del horno P3
462	6015023			Joint plat pour thermoplongeur P3	Junta plana para calentador de inmersión P3
464	6015025			Joint plat pour chaînon d'élément de chauffe P3	Junta plana para anillo de radiador tubular P3
465	6015026			Joint version STC P3 G	Junta paso sonda de temperatura central P3 G
476	6015040			Joint plat pour sonde de niveau P3	Junta plana para sonda de nivel P3
478	6015042			Douille d'étanchéité bac de récupération P3	Boquilla de obturación cubeta recogedora de gotas P3
479	6015060			Joint en cuivre nickelé 18x24x1.5 P3	Junta en cobre niquelado 18x24x1.5 P3
480	6015062			Joint en cuivre 10x14 P3	Junta en cuivre 10x14 P3
481	6015100			Coude d'écoulement pour chaudière à vapeur P3	Codo de purga para generador de vapor P3
482	6015200			Ecartereur pour porte P3	Distanciadador para puerta P3
484	6015248			Etrier de retenue pour porte P3 modèle sur table	Grapa retén puerta P3 aparato sobremesa
487	6015205			Raccord de tuyau de déshumidification P3	Empalme de manguera deshumidificación P3
489	6015212			Appui tôle d'aspiration P3	Soporte lámina de aspiración P3
490	6015213			Douille d'écartement 33mm P3	Casquillo distanciadador motor 33mm P3
491	6015215			Angle raccord de tuyau 3/8"	Angulo empalme de manguera 3/8"
492	6015216			Injecteur IN P3	Boquilla IN P3
493	2619156			Kit SAV bloc de sécurité porte escamotable P3	Juego serv. técnico taco de seguridad VST P3
494	6015227			Ecrou hexagonal inch G 1/2" DIN 431 A2 P3	Tuerca hexagonal inch G 1/2" DIN 431 A2 P3
495	6015229			Douille Interrupteur manométrique P3	Casquillo roscado interruptor de presión P3
501	6015241			Broche d'appui EHG P3	Pasador de apoyo EHG P3
514	6016500			Absorption retour dispositif pour générateur de vapeur cpl.P	Reabsorción despositivo de seguridad para vaporizador P3
515	6016517			Capuchon pour insert, gris Press and Go P3	Capuchón de tecla, gris Press and Go P3
517	6019020			Symboles pour Press and Go P3	Symbolos para Press and Go P3
520	6011010	EB1BD0823		Douchette modèles sur table P3	Ducha de mano aparatos sobremesa P3
520	6011010	ES1BD1353		Douchette modèles sur table P3	Ducha de mano aparatos sobremesa P3
521	6011012	EB1BD0823		Porte douchette modèles sur table P3	Soporte ducha de mano aparatos sobremesa P3
521	6011012	ES1BD1353		Porte douchette modèles sur table P3	Soporte ducha de mano aparatos sobremesa P3
522	7001066			Protection de coin avec insert métallique P2 P3	Cantонера zona apriete 9+6, 0.8-1. PVC con inserto metálico
524	7002006			Tuyau d'eau PVC sans insert polyform 6/2	Manguera de agua en PVC sin pieza intercalada, poliform. 6/2
525	7002002			Tuyau d'eau PVC sans insert rouge polyform 6/2	Manguera de agua en PVC sin pieza intercalada, rojo, poliform. 6/2
527	7002033			Tuyau d'eau chaude 3/8" P2 P3	Manguera de agua caliente 3/8" P2 P3
528	3417550			Kit trop-plein P3	Juego de desbordamiento P3
530	2617250			Kit SAV pompe détergent 230V P3	Juego serv. técnico unidad limpiadora de la bomba 230 V P3
538	7011001			Joint de porte 6.10 P3	Junta de puerta 6.10 P3
545	7011010			Joint platine avant P3	Junta panel frontal P3
553	7012010			Tuyau d'évacuation d'air 6.10 P3	Manguera de salida de aire 6.10 P3
557	7012014			Tuyau de refroidissement de pompe 330mm de long P3	Manguera de refrigerador para bomba, largo 330 mm P3
564	7012070			Gaine douchette 6.10/6.20 P3	Manguera de ducha 6.10/6.20 P3
568	7012080			Tuyau 1/2" P3	Manguera 1/2" P3
573	7012300			Tube silicón 450 mm D. 12x2 6.10/10.1	Manguera de silicona 450 mm D. 12x2 6.10/10.1
575	7012302			Tube EPDM 6x2 mm	Manguera EPDM 6x2 mm
576	7015200			Démonteur poww ventilateur P3	Extractor para ventilador P3
577	8001012			Vis à tête bombée M3x6 A2 P3	Tornillo alomado M3x6 A2 P3
579	8001024			Vis à tête bombée M4x10	Tornillo alomado M4x10
585	8002043			Vis à tête conique bombée M6x12 A2 P2 P3	Tornillo con cabeza avellanada gota de sebo M6x12 A2 P2 P3
587	8003029			Vis MLF M5x10 A2 P2 P3	Tornillo MLF M5x10 A2 P2 P3
588	8003030			Vis MLF M5x15 A2	Tornillo MLF M5x15 A2
589	8003032			Vis MLF M6x20 A2	Tornillo MLF M6x20 A2
590	8003035			Vis à six pans creux M5x10 A2 P2 P3	Tornillo hexagonal M5x10 A2 P2 P3
592	8003046			Vis hexagonale M6 x 30	Tornillo de cabeza hexagonal M6 x 30
594	8004012			Ecrou hexagonal M3 A2 P2 P3	Tuerca hexagonal M3 A2 P2 P3
597	8005021			Rondelle 4,3 A2 DIN125 P2/P3	Arandela 4.3 A2 DIN125 P2/P3
598	8005040			Rondelle 6,4 A2 DIN 125 P2/P3	Arandela 6.4 A2 DIN125 P2/P3
600	8006011			Rondelle élastique B3 A2 P2/P3	Arandela elástica B3 A2 P2/P3
602	8006058			Rondelle de sécurité Schnorr S5 P2/P3	Disco Schnorr S5 P2/P3
606	8009030			Entretoise 11,3mm P2	Casquillo distanciadador 11,3mm P2
607	8009057			Bride de serrage pour fil D.36 noir P2/P3	Abrazadera de alambre D.36 negro P2/P3
608	8009058			Bride de serrage D. 10	Abrazadera D. 10
609	8002015			Vis à tête bombée M3x10 A2	Tornillo de cabeza avellanadaaa M3x10 A2
610	8017008			Cliquet écrou M3 A2 P3 PA	Tuerca con apoyo de dientes de bloqueo M3 A2 P3
611	8010001			Vis à six pans creux DIN EN ISO 10642 M6x35 A2 P3	Tornillo de hexagono int. DIN EN ISO 10642 M6x35 A2 P3
614	8013003			Vis à tête cylindrique DIN 7984 - M6x70 A2 P3	Tornillo cilíndrico DIN 7984 - M6x70 A2 P3
615	8013004			Vis à six pans creux M4x10 A2 P3	Tornillo hexagonal M4x10 A2 P3
621	8015000			Vis MLF M6x8 A2 P3	Tornillo MLF M6x8 A2 P3
622	8016000			Rondelle à éventail Ø20mm P3	Arandela de frenado Ø20mm P3
624	8016002			Rondelle à éventail S4 A2 P3	Arandela de frenado S4 A2 P3
625	8017010			Cliquet écrou M5 A4 P3	Tuerca con apoyo de dientes de bloqueo M5 A4 P3

Pos	Art.-Nr	-->	-->	français	español
626	8017011			Cliquet écrou M6 A4 P3	Tuerca con apoyo de dientes de bloqueo M6 A4 P3
628	8019004			Capuchon vis d'obturation P3	Caperuza tornillo de cierre P3
629	8019010			Bride métallique D.16 P3	Abrazadera metálica D.16 P3
632	6014006			Chape Soupape d'équerre 1/2" x 1/2" P3	Caperuza válvula angular 1/2" x 1/2" P3
635	2618779			Kit SAV ampoule électrique 230V/25W P3	Juego serv. técnico lámpara incandescente 230V/25W P3
636	2618780			Kit SAV éclairage enceinte de cuisson complet P3	Juego serv. técnico luz del área de cocción compl. P3
641	2618785			Kit SAV fixation commande P3	Juego serv. técnico sujeción del mando P3
689	2619138			Kit SAV guide rail porte escamotable 30x16 6.10/10.10 P3	Juego serv. técnico carril guía VST 30x16 6.10/10.10 P3
692	2619141			Kit SAV galet de guidage porte escamotable 30x16 P3	Juego serv. técnico rodillo guía VST 30x16 P3
693	2619142			Kit SAV porte escamotable 6.10 cpl. P3	Juego serv. técnico 6.10 cpl P3
700	2114741	EB1BE0959		Couvercle AR EL/GAZ IN 6.10 cpl. P3	Cubierta tras EL/GAS IN 6.10 cpl P3
700	2114741	ES1BE1517		Couvercle AR EL/GAZ IN 6.10 cpl. P3	Cubierta tras EL/GAS IN 6.10 cpl P3
714	2114781	EB1BE0959		Couvercle gauche 6.10 cpl. P3	Cubierta izq 6.10 cpl P3
714	2114781	ES1BE1517		Couvercle gauche 6.10 cpl. P3	Cubierta izq 6.10 cpl P3
721	2115441			Plaque frontale 6.10 présassemblée P3	Parte frontal 6.10 vormont P3
728	2114632			Pièce d'angle AR gauche 6.10 P3	Esquina tras izq 6.10 P3
733	2114700	EB1BL1719		Couvercle extérieur EL 6.10/10.10 P3	Cubierta externa EL 6.10/10.10 P3
733	2114700	ES1BL2998		Couvercle extérieur EL 6.10/10.10 P3	Cubierta externa EL 6.10/10.10 P3
751	2114508			Couvercle section de pompe P3	Cubierta sección de bomba P3
757	2117411	EB1BE0960		Couvercle gauche enfoncé 6.10 cpl. P3	Cubierta izq insertada 6.10 cpl P3
757	2117411	ES1BE1518		Couvercle gauche enfoncé 6.10 cpl. P3	Cubierta izq insertada 6.10 cpl P3
764	2117431	EB1BE0960		Couvercle AR enfoncé EL/GAZ IN 6.10 cpl. P3	Cubierta tras insertada EL/GAS IN 6.10 cpl P3
764	2117431	ES1BE1518		Couvercle AR enfoncé EL/GAZ IN 6.10 cpl. P3	Cubierta tras insertada EL/GAS IN 6.10 cpl P3
781	2118227	EB1BL1720		Couvercle extérieur EL int 6.10/10.10 P3	Cubierta externa EL int 6.10/10.10 P3
781	2118227	ES1BL2999		Couvercle extérieur EL int 6.10/10.10 P3	Cubierta externa EL int 6.10/10.10 P3
783	2218078	EB1BL1716		Grille de protection du ventilateur RV EL DE 6.10 cpl. P3	Chapa aspir. RV EL DE 6.10 cpl P3
784	2218075	ES1BL2907		Grille de protection du ventilateur RV EL IN 6.10 cpl. P3	Chapa aspir. RV EL IN 6.10 cpl P3
801	8009022			Ecrou de tôle 14x11 filetage 4,8	Tuerca de chapa 14x11 rosca 4,8
802	8012003			Vis autotaraudeuse à tête bombée 4,8x32 DIN7981 A2 P3	Tornillo de chapa avellanado 4,8x32 DIN7981 A2 P3
803	2114627	app. 01/07		Trappe au sol condensateur P3	Cubierta del fondo del condensador P3
805	2119228	app. 01/07		Trappe au sol condensateur avec trop-plein gauche P3	Cubierta del fondo condensador con rebose izq P3
902	3007029			Convocare bidon vide 10 L	Convocare bidón vacío 10 L
903	6009016			Logo "C" rouge 90x62x2mm	Letra "C" de plástico roja 90x62x2mm
904	6019104			Autocollant: Qualité de l'eau et raccord, P3	Etiqueta: Calidad de agua y conexión, P3
905	6019106			Autocollant: Données de gaz, P3	Etiqueta: Datos de gas, P3
906	6019107			Autocollant: Nettoyage manuel, P3	Etiqueta: Limpieza manual, P3
907	7002024			Tuyau d'évacuation des graisses 1" pour version petit robine	Manguera de salida de grasa 1" para la versión para pollos
908	7003066			joint pour carte électronique 9x3	Cinta de obturación 9x3
909	7003087			Cartouche à graisse 400 g portes frontales OD P2 P3	Cartucho de grasa 400g. Puerta V OD P2 P3
910	7004012			Loctite Typ 243	Loctite 243 10ml P2/P3
911	7004013			Vernis de sécurité pour vis	Laca de bloqueo P2 P3
912	7004020			Tube de colle Silicone E 43	Cola de silicona E 43
914	7014003			Loctite 8001 - graisse P3	Loctite 8001 - Lubricante P3
915	3019007			Kit SAV pour appareil d'analyse de l'eau	Juego serv. técnico para aparato de análisis de agua
916	5019200			Convertisseur USB à RS232 P3	Convertidor USB para RS232 P3

Sous réserve de modifications techniques, de nouveaux développements et d'erreurs.

Nos reservamos el derecho de nuevos desarrollos técnicos, modificaciones y errores.



Talstr. 35
 82436 Eglfing
 Tel. +49 8847 67-0
 Fax +49 8847 67-191
 www.convotherm.com

Elektro-Dokumentation
 electrical-documentation

Stromlaufplan wiring diagram	: 5315500
Montageplatte electric box	: 5115700
Gerätetyp type	: OEB 6.10
Spannung voltage	: 3/N/PE ~ 400V
Frequenz frequency	: 50/60Hz
Nennleistung power consumption	: 11,5kW
Nennstrom current	: 15,7A

Absicherung bauseits!
 Örtliche EVU-Vorschriften beachten!
 Please look at local supply regulations!
 fuses on site!

Schutzvermerk nach DIN 34 beachten !

Erstellt mit ELCAD/AUCOPLAN (R) 7.2.0

R. Änderung		Datum	Name	Norm	Ursprung	Ersatz für	Ersatz durch	Deckblatt / overlay	Stromlaufpläne 1	5315500	Blatt 1
										5315500	4 Bl.



Schutzvermerk nach DIN 34 beachten !

Alle Leitungen ohne Querschnittsangaben sind mm²

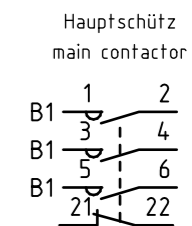
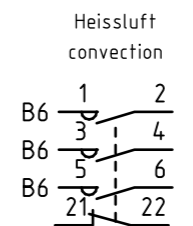
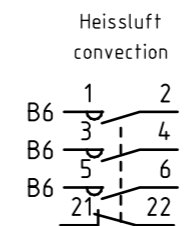
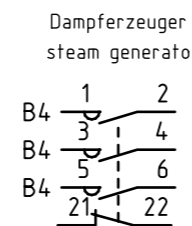
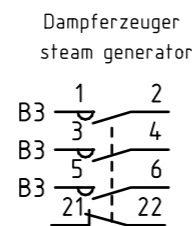
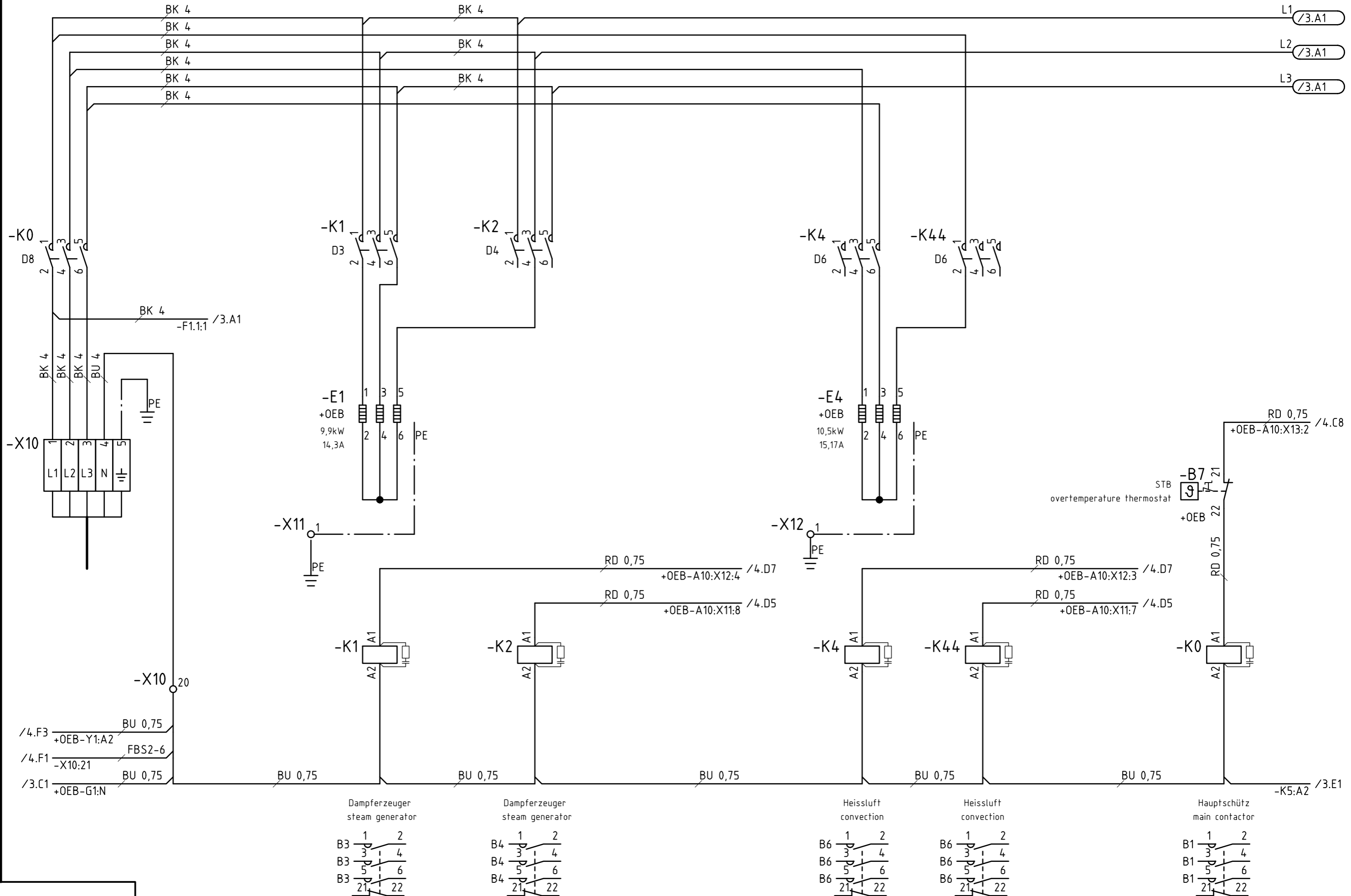

Datum		06.05.2004				Stromlaufpläne		5315500					
Bearbeiter		Böttinger				2				+MP			
Geprüft		Hu				Heizungen / heating elements				5315500		Blatt 2	
R. Änderung	Datum	Name	Norm	Ursprung	Ersatz für	Ersatz durch					4 Bl.		
1				2							8		

Schutzvermerk nach DIN 34 beachten !

Alle Leitungen ohne Querschnittsangaben sind mm²

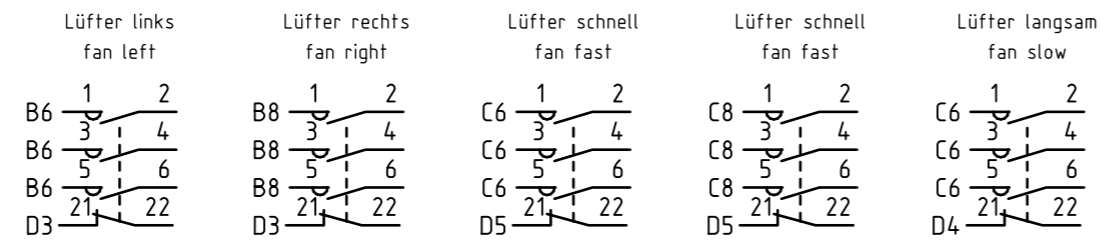
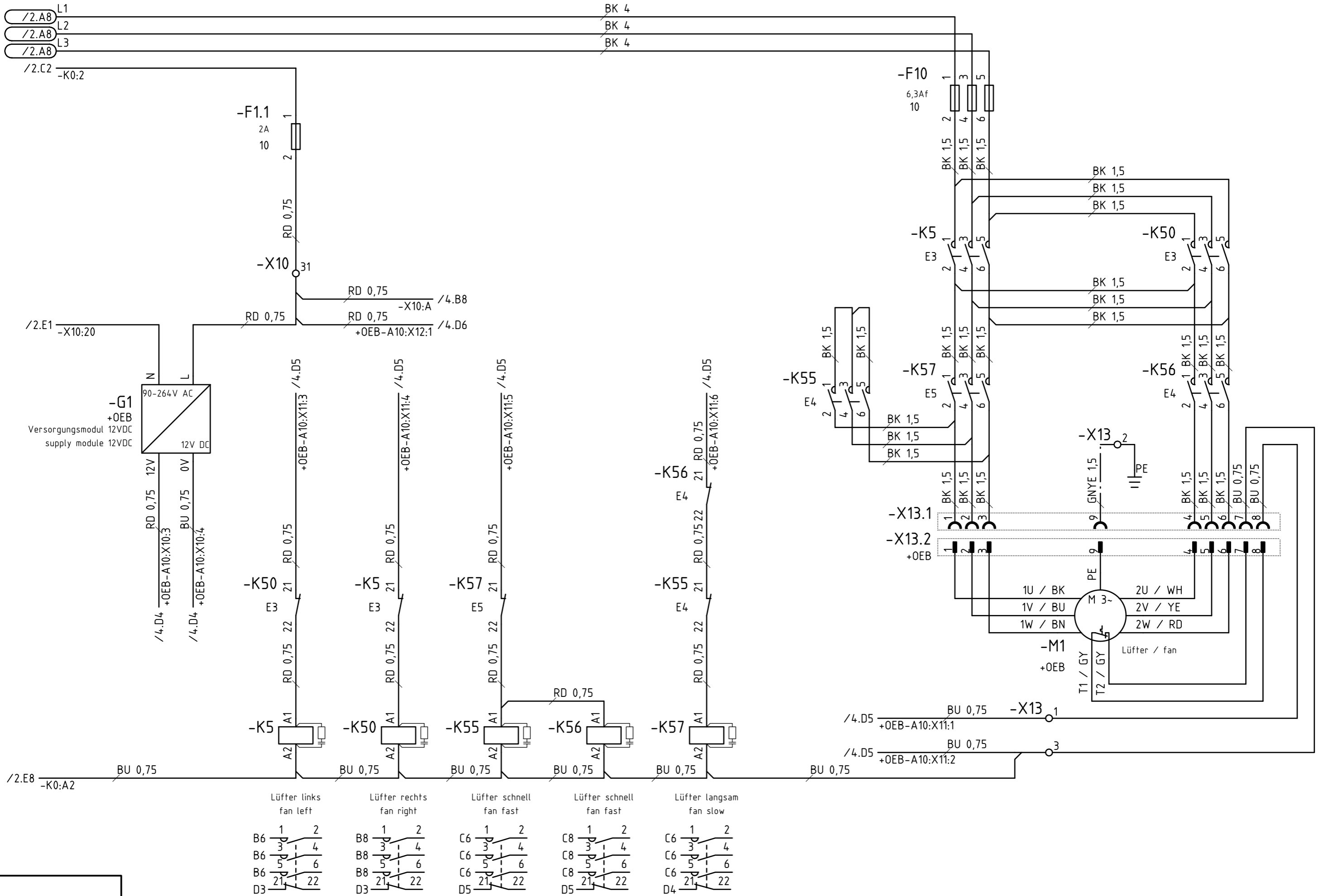

Datum		06.05.2004		Stromlaufpläne		5315500		+MP	
Bearbeiter		Böttinger		3					
Geprüft		Hu		Motore / motors		5315500		Blatt 3	
R. Änderung	Datum	Name	Norm	Ursprung	Ersatz für	Ersatz durch	4 Bl.		

Schutzvermerk nach DIN 34 beachten !

Alle Leitungen ohne Querschnittsangaben sind mm²

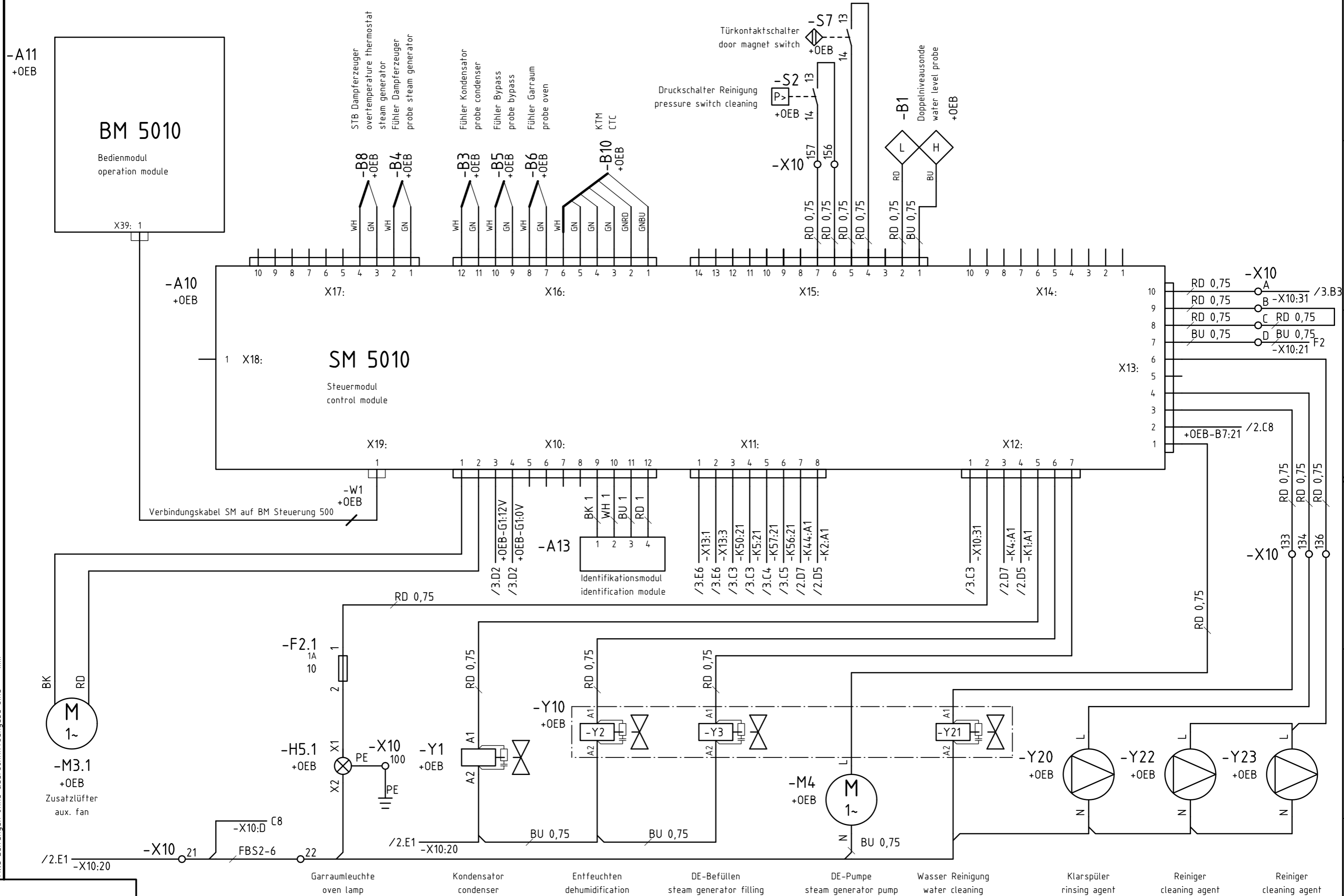

Datum		06.05.2004				Stromlaufpläne		5315500					
Bearbeiter		Böttlinger				4							
Geprüft		Hu				Steuerung / control				5315500		Blatt 4	
R. Änderung	Datum	Name	Norm	Ursprung	Ersatz für	Ersatz durch			5315500		4 Bl.		

Ersatzteilliste/spare parts list/Ersatzteilliste F/Ersatzteilliste S

Nr.	Betriebsmittel/operating material/Betriebsmittel F/Betriebsmittel S Artikelnummer/part number/Artikelnummer F/Artikelnummer S Darstellung/presentation/Darstellung F/Darstellung S	Bezeichnung	description	Bezeichnung F	Bezeichnung S
1	+OEB-A10 5019100 /4.D3	Steuerung 5010 Steuermodul SM P3	electronic board 5010 SM P3	commande électronique 5010 SM P3	commande électronique 5010 SM P3
2	+OEB-A11 5019101 /4.B2	Steuerung 5010 Bedienmodul BM P3	electronic board 5010 BM P3	commande électronique 5010 BM P3	commande électronique 5010 BM P3
3	+MP-A13 5019102 /4.D4	Steuerung 5010 Identifikationsmodul IDM	electronic board 5010 IDM P3	commande électronique 5010 IDM P3	commande électronique 5010 IDM P3
4	+OEB-B1 5019000 /4.B6	Doppelniveausonde P3 kpl	water level probe	sonde de niveau	sonde de niveau
5	+OEB-B3 5002100 /4.B3	Thermoelementfühler OSC/OSP 3050 mm P2	temperature probe PT100	sonde de temperature PT100	sonde de temperature PT100
6	+OEB-B4 5002100 /4.B3	Thermoelementfühler OSC/OSP 3050 mm P2	temperature probe PT100	sonde de temperature PT100	sonde de temperature PT100
7	+OEB-B5 5002100 /4.B4	Thermoelementfühler OSC/OSP 3050 mm P2	temperature probe PT100	sonde de temperature PT100	sonde de temperature PT100
8	+OEB-B6 5002100 /4.B4	Thermoelementfühler OSC/OSP 3050 mm P2	temperature probe PT100	sonde de temperature PT100	sonde de temperature PT100
9	+OEB-B7 5001041 /2.C8	Sicherheits-Temperaturbegrenzer	Safety thermostat self fracture	Thermostat sécurité resistant	Thermostat sécurité resistant
10	+OEB-B8 5002104 /4.B3	STB Thermoelementfühler 2.80m P2	temperature probe PT100	sonde de temperature PT100	sonde de temperature PT100
11	+OEB-B10 5002068 /4.B4	Kerntemperatur-Meßfühler 4 Pkt. Ni-Cr-Ni	multi point CTC probe	Sàc des multi points	Sàc des multi points
12	+OEB-E1 5017002 /2.C3	Tauchheizkörper P3 9,9 kW kpl.	immersion heating element P3 9,9 kW	thermoplongeur P3 9,9 kW	thermoplongeur P3 9,9 kW
13	+OEB-E4 5017005 /2.C6	Rohrheizkörper P3 10,5 kW kpl.	heating element P3 10,5 kW	resistance circulaire P3 10,5 kW	resistance circulaire P3 10,5 kW
14	+MP-F1.1 4005066 /3.A3	Feinsicherung 2A träge	glass fuse 2A	fusible 2A	fusible 2A
15	+MP-F1.1 4014038 /3.A3	Zackband flach unbedruckt	sticker flat not printed (8,2)	vignette plaine pas imprimée (8,2)	vignette plaine pas imprimée (8,2)
16	+MP-F1.1 4014036 /3.A3	Zugfeder-Drehsicherungsklemme	cage clamp terminal block (5x20)	pince ressort de traction (5x20)	pince ressort de traction (5x20)
17	+MP-F2.1 4005064 /4.D3	Feinsicherung 1A träge	glass fuse 1A	fusible 1A	fusible 1A
18	+MP-F2.1 4014038 /4.D3	Zackband flach unbedruckt	sticker flat not printed (8,2)	vignette plaine pas imprimée (8,2)	vignette plaine pas imprimée (8,2)
19	+MP-F2.1 4014036 /4.D3	Zugfeder-Drehsicherungsklemme	cage clamp terminal block (5x20)	pince ressort de traction (5x20)	pince ressort de traction (5x20)
20	+MP-F10 4005069 /3.A6	Feinsicherung 6.3A flink	glass fuse 6.3Af	fusible 6.3Af	fusible 6.3Af

Bemerkungen :

Schutzvermerk nach DIN 34 beachten !

Erstellt mit ELCAD/AUCOPLAN (R) 7.2.0

			Datum	19.07.2004				Listen Ersatzteilliste 1			5315500	
			Bearbeiter	Böttlinger								
			Geprüft									
R. Änderung	Datum	Name	Norm		Ursprung	Ersatz für	Ersatz durch				5315500	Blatt 1 4 Bl.



Ersatzteilliste/spare parts list/Ersatzteilliste F/Ersatzteilliste S

Nr.	Betriebsmittel/operating material/Betriebsmittel F/Betriebsmittel S		Bezeichnung	description	Bezeichnung F	Bezeichnung S
	Artikelnummer/part number/Artikelnummer F/Artikelnummer S					
	Darstellung/presentation/Darstellung F/Darstellung S					
21	+MP-F10 4014038 /3.A6		Zackband flach unbedruckt	sticker flat not printed (8,2)	vignette plaine pas imprimée (8,2)	vignette plaine pas imprimée (8,2)
22	+MP-F10 4014037 /3.A6		Zugfeder-Drehsicherungsklemme	cage clamp terminal block (6,3x32)	pince ressort de traction (6,3x32)	pince ressort de traction (6,3x32)
23	+MP-FK0 4011004 /2.D8		RC-Glied 110-240V	interference filter 110-240V	filtre antiparasite 110-240V	filtre antiparasite 110-240V
24	+MP-FK1 4011004 /2.D3		RC-Glied 110-240V	interference filter 110-240V	filtre antiparasite 110-240V	filtre antiparasite 110-240V
25	+MP-FK2 4011004 /2.D4		RC-Glied 110-240V	interference filter 110-240V	filtre antiparasite 110-240V	filtre antiparasite 110-240V
26	+MP-FK4 4011004 /2.D6		RC-Glied 110-240V	interference filter 110-240V	filtre antiparasite 110-240V	filtre antiparasite 110-240V
27	+MP-FK5 4011004 /3.E3		RC-Glied 110-240V	interference filter 110-240V	filtre antiparasite 110-240V	filtre antiparasite 110-240V
28	+MP-FK44 4011004 /2.D6		RC-Glied 110-240V	interference filter 110-240V	filtre antiparasite 110-240V	filtre antiparasite 110-240V
29	+MP-FK50 4011004 /3.E3		RC-Glied 110-240V	interference filter 110-240V	filtre antiparasite 110-240V	filtre antiparasite 110-240V
30	+MP-FK55 4011004 /3.E4		RC-Glied 110-240V	interference filter 110-240V	filtre antiparasite 110-240V	filtre antiparasite 110-240V
31	+MP-FK56 4011004 /3.E4		RC-Glied 110-240V	interference filter 110-240V	filtre antiparasite 110-240V	filtre antiparasite 110-240V
32	+MP-FK57 4011004 /3.E5		RC-Glied 110-240V	interference filter 110-240V	filtre antiparasite 110-240V	filtre antiparasite 110-240V
33	+MP-FY1 4001075 /4.E4		Entstörfilter-Magnetventil 240V	Interference filter f.solenoid valve	filtre antiparasite electrovanne	filtre antiparasite electrovanne
34	+OEB-G1 5009301 /3.C2		Steuerung 5000 VM (Versorgungsmodul) P	Electronic board 5000 VM (Supply module)	Commande électronique 5000 VM	Commande électronique 5000 VM
35	+OEB-H5.1 5015001 /4.E3		Reflektorgehäuse mit Lampe Garraumleucht			
36	+OEB-H5.1 5015002 /4.E3		Glas für Garraumleuchte P3			
37	+OEB-H5.1 5015003 /4.E3		Rahmen für Garraumleuchte P3			
38	+OEB-H5.1 6015020 /4.E3		Reflektorgehäuse mit Lampe Garraumleucht			
39	+MP-K0 4011013 /2.D8		Schütz 3-pol. 18 kW / 50 A	contactor 18 kW / 50 A	contacteur 18 kW / 50 A	contacteur 18 kW / 50 A
40	+MP-K1 4011001 /2.D3		Schütz 11kW/32A AC1	contactor 11kW/32A AC1	contacteur 11kW/32A AC1	contacteur 11kW/32A AC1

Bemerkungen :

Schutzvermerk nach DIN 34 beachten !

Erstellt mit ELCAD/AUCOPLAN (R) 7.2.0

Datum		19.07.2004				Listen		5315500	
Bearbeiter		Böttinger				Ersatzteilliste		2	
Geprüft									
R. Änderung	Datum	Name	Norm	Ursprung	Ersatz für	Ersatz durch	5315500		Blatt 2
									4 Bl.

Ersatzteilliste/spare parts list/Ersatzteilliste F/Ersatzteilliste S

Schutzvermerk nach DIN 34 beachten !

Nr.	Betriebsmittel/operating material/Betriebsmittel F/Betriebsmittel S Artikelnummer/part number/Artikelnummer F/Artikelnummer S Darstellung/presentation/Darstellung F/Darstellung S	Bezeichnung	description	Bezeichnung F	Bezeichnung S
41	+MP-K2 4011001 /2.D4	Schütz 11kW/32A AC1	contactor 11kW/32A AC1	contacteur 11kW/32A AC1	contacteur 11kW/32A AC1
42	+MP-K4 4011001 /2.D6	Schütz 11kW/32A AC1	contactor 11kW/32A AC1	contacteur 11kW/32A AC1	contacteur 11kW/32A AC1
43	+MP-K5 4011000 /3.E3	Schütz 9kW / 25A AC1	contactor 9kW / 25A AC1	contacteur 9kW / 25A AC1	contacteur 9kW / 25A AC1
44	+MP-K44 4011001 /2.D6	Schütz 11kW/32A AC1	contactor 11kW/32A AC1	contacteur 11kW/32A AC1	contacteur 11kW/32A AC1
45	+MP-K50 4011000 /3.E3	Schütz 9kW / 25A AC1	contactor 9kW / 25A AC1	contacteur 9kW / 25A AC1	contacteur 9kW / 25A AC1
46	+MP-K55 4011000 /3.E4	Schütz 9kW / 25A AC1	contactor 9kW / 25A AC1	contacteur 9kW / 25A AC1	contacteur 9kW / 25A AC1
47	+MP-K56 4011000 /3.E4	Schütz 9kW / 25A AC1	contactor 9kW / 25A AC1	contacteur 9kW / 25A AC1	contacteur 9kW / 25A AC1
48	+MP-K57 4011000 /3.E5	Schütz 9kW / 25A AC1	contactor 9kW / 25A AC1	contacteur 9kW / 25A AC1	contacteur 9kW / 25A AC1
49	+OEB-M1 5018002 /3.D7	Drehstrommotor 4/8 pol. P3	AC motor 4/8 pol. P3	moteur AC 4/8 pol. P3	moteur AC 4/8 pol. P3
50	+OEB-M1 4014072 /3.D7	ST-Combi-Stecker 9pol. P3			
51	+OEB-M3.1 5008083 /4.E1	Zusatzlüfter Sunon KDE 1212 PMB1-6A OS	aux. fan KDE 1212 PMB1-6A OS	ventilateur d'aération	ventilateur d'aération
52	+OEB-M4 5008079 /4.E6	Entleerungspumpe mit Synchronmotor	emptiing pump with synchronous motor	pompe d'evacuation avec moteur synchrone	pompe d'evacuation avec moteur synchrone
53	+OEB-S2 5009055 /4.A5	Druckschalter für automatische Garraumre	Manometric switch	Interrupteur manométrique	Interrupteur manométrique
54	+OEB-S7 5003075 /4.A6	Türkontaktschalter berührungslos	door magnet switch	interrupteur magnétique de porte	interrupteur magnétique de porte
55	+OEB-W1 5009304 /4.D3	Verbindungskabel SM auf BM Steuerung 500	connection cable SM to BM	cable d'alimentation SM-BM	cable d'alimentation SM-BM
56	+MP-X10 5012003 /4.C5	Stecker direkt 12pol. RM 3,5 mm P3	terminal block 12pol. RM 3,5 mm P3	connecteur 12pol. RM 3,5 mm P3	connecteur 12pol. RM 3,5 mm P3
57	+MP-X11 5012002 /4.C6	Stecker direkt 8pol. RM 5 mm P3	terminal block 8pol. RM 5 mm P3	connecteur 8pol. RM 5 mm P3	connecteur 8pol. RM 5 mm P3
58	+MP-X12 5012001 /4.C7	Stecker direkt 7pol. RM 5 mm P3	terminal block 7pol. RM 5 mm P3	connecteur 7pol. RM 5 mm P3	connecteur 7pol. RM 5 mm P3
59	+MP-X13 5002094 /4.B7	Stecker X2 OSC, OSG, OSP P2	terminal block X2 OSC, OSG, OSP P2	connecteur X2 OSC, OSG, OSP P2	connecteur X2 OSC, OSG, OSP P2
60	+MP-X15 5012003 /4.B5	Stecker direkt 12pol. RM 3,5 mm P3	terminal block 12pol. RM 3,5 mm P3	connecteur 12pol. RM 3,5 mm P3	connecteur 12pol. RM 3,5 mm P3

Bemerkungen :

Erstellt mit ELCAD/AUCOPLAN (R) 7.2.0

			Datum	19.07.2004			Listen Ersatzteilliste 3	5315500	
			Bearbeiter	Böttinger					
			Geprüft						
R. Änderung	Datum	Name	Norm		Ursprung	Ersatz für	Ersatz durch		5315500
								Blatt 3	4 Bl.

Ersatzteilliste/spare parts list/Ersatzteilliste F/Ersatzteilliste S

Nr.	Betriebsmittel/operating material/Betriebsmittel F/Betriebsmittel S Artikelnummer/part number/Artikelnummer F/Artikelnummer S Darstellung/presentation/Darstellung F/Darstellung S	Bezeichnung	description	Bezeichnung F	Bezeichnung S
61	+OEB-X16 5012003 /4.B3	Stecker direkt 12pol. RM 3,5 mm P3	terminal block 12pol. RM 3,5 mm P3	connecteur 12pol. RM 3,5 mm P3	connecteur 12pol. RM 3,5 mm P3
62	+OEB-X17 5012004 /4.B2	Stecker direkt 10pol. RM 3,5 mm P3	terminal block 10pol. RM 3,5 mm P3	connecteur 10pol. RM 3,5 mm P3	connecteur 10pol. RM 3,5 mm P3
63	+OEB-Y1 5001059 /4.E4	Einfachmagnetventil 220-240V 180° ODgas	solenoid valve	electrovanne simple	electrovanne simple
64	+OEB+MP-Y10-FY2 4001075 /4.E4	Entstörfilter-Magnetventil 240V	Interference filter f.solenoid valve	filtre antiparasite electrovanne	filtre antiparasite electrovanne
65	+OEB+MP-Y10-FY3 4001075 /4.E5	Entstörfilter-Magnetventil 240V	Interference filter f.solenoid valve	filtre antiparasite electrovanne	filtre antiparasite electrovanne
66	+OEB-Y10-FY21 4001075 /4.E6	Entstörfilter-Magnetventil 240V	Interference filter f.solenoid valve	filtre antiparasite electrovanne	filtre antiparasite electrovanne
67	+OEB-Y20 5008011 /4.E7	Pumpe für Garraumreinigung Standgeräte	Pump for inner oven cleaning floor units	Pompe pour nettoyage de l'enceinte	Pompe pour nettoyage de l'enceinte
68	+OEB-Y22 5008011 /4.E8	Pumpe für Garraumreinigung Standgeräte	Pump for inner oven cleaning floor units	Pompe pour nettoyage de l'enceinte	Pompe pour nettoyage de l'enceinte
69	+OEB-Y23 5008011 /4.E8	Pumpe für Garraumreinigung Standgeräte	Pump for inner oven cleaning floor units	Pompe pour nettoyage de l'enceinte	Pompe pour nettoyage de l'enceinte

Schutzvermerk nach DIN 34 beachten !

Bemerkungen :

Erstellt mit ELCAD/AUCOPLAN (R) 7.2.0

			Datum	19.07.2004			Listen Ersatzteilliste 4	5315500	
			Bearbeiter	Böttinger					
			Geprüft						
R. Änderung	Datum	Name	Norm		Ursprung	Ersatz für	Ersatz durch		Blatt 4 4 Bl.