



COMPONENTES GAS



COMPONENTES ELÉCTRICOS



TECNOLOGÍA DEL AGUA



COMPONENTES MECÁNICOS



HERRAMIENTAS

Repuestos adaptables a

ELOMA

Encuentre nuestra gama siempre actualizada en la tienda online de GEV



Catálogo de fabricantes

Las piezas de repuesto y accesorios más importantes de cada fabricante reunidas y ordenadas de manera práctica

- ✓ En la tienda online GEV encontrará el surtido completo y toda la información actualizada de máquinas y aparatos
- ✓ Índice alfabético al final del catálogo

Tienda online GEV

www.gev-online.es
www.gev-online.com





- 🔍 marcar artículos como favoritos
- 🔍 acceso mediante su e-mail y su contraseña habitual
- 🔍 ponga en la cesta de la compra, múltiples artículos a la vez
- 🔍 búsqueda de artículos inmediata sin necesidad conectarse

resistencias





resistencias para asadoras de pollos



			
código	415532	referencia	103691 E318012 EL0103691 ELE318012 R0210
descripción	resistencia 1000W 230V L 700mm An 64mm Hmm espirales 1 empalme conector Faston 6,3mm resistencia seca tubo ø 6.3mm distancia de empalme 59mm		

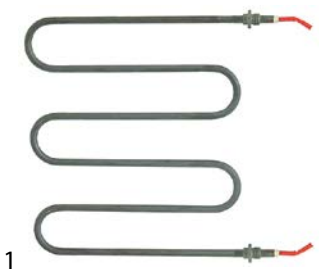





			
código	415531	referencia	530905 E318013 EL0530905 ELE318013 R0215
descripción	resistencia 1000W 230V L 725mm An 50mm Hmm espirales 1 empalme conector Faston 6,3mm resistencia seca tubo ø 6.3mm distancia de empalme 46mm		

			
código	415533	referencia	532177 E318014 EL0532177 ELE318014 R0220
descripción	resistencia 1100W 230V L 727mm An 50mm Hmm espirales 1 empalme M4 resistencia seca tubo ø 8.6mm longitud de empalme 19mm		

resistencias para barra caliente

			
código	416510	referencia	E318020 ELE318020 R0230
descripción	resistencia 1200W 230V espirales 1 L 260mm An 284mm longitud de empalme 46mm tubo ø 8.5mm longitud del cable 480mm resistencia seca barra caliente sujeción 2 orificios rosca M14x1,5 distancia de sujeción 275mm		
repuestos para	416510		
	código	550262	referencia —
	 junta plana cobre ø ext. 20mm int.ø 14mm espesor 2mm		
accesorios para	416510		
	código	510417	referencia —
	 junta plana fibra ø ext. 20mm int.ø 14mm espesor 2mm UE 1 pzs		
	código	520228	referencia —
	 arandela dentada int.ø 15.3mm ø ext. 24mm acero UE 1 pzs para rosca M14		

accesorios para	416510		
	código	520230	referencia —
	 tuerca rosca M14x1,5 H 5mm EC 19 acero zincado UE 1 pzs		
	código	521101	referencia —
	 tuerca rosca M14x1,5 H 5mm EC 19 inox UE 1 pzs		

			
código	416431	referencia	E318042 ELE318042 R0299
descripción	resistencia 1600W 230V espirales 1 L 212mm An 450mm longitud de empalme 38mm tubo ø 8.5mm empalme conector Faston 6,3mm resistencia seca barra caliente sujeción 2 orificios rosca M14x1,5 distancia de sujeción 442mm		
accesorios para	416431		
	código	510417	referencia —
	 junta plana fibra ø ext. 20mm int.ø 14mm espesor 2mm UE 1 pzs		
	código	520228	referencia —
	 arandela dentada int.ø 15.3mm ø ext. 24mm acero UE 1 pzs para rosca M14		
	código	520230	referencia —
	 tuerca rosca M14x1,5 H 5mm EC 19 acero zincado UE 1 pzs		
	código	521101	referencia —
	 tuerca rosca M14x1,5 H 5mm EC 19 inox UE 1 pzs		
	código	550262	referencia —
	 junta plana cobre ø ext. 20mm int.ø 14mm espesor 2mm		

			
código	416429	referencia	E318044 ELE318044 R0303
descripción	resistencia 1600W 230V espirales 1 L 300mm An 205mm B1 5mm B2 195mm tubo ø 8.5mm empalme conector Faston 6,3mm resistencia seca barra caliente L1 50mm L2 20mm L3 230mm sujeción 2 orificios rosca M14x1,5 distancia de sujeción 202mm		

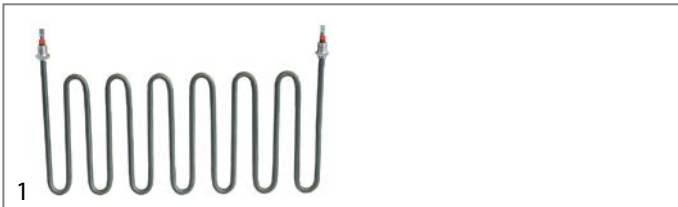
código	416430	referencia	E318043 ELE318043 R0301
descripción	resistencia 2000W 230V L 215mm An 415mm tubo ø 8.5mm empalme conector Faston 6,3mm resistencia seca barra caliente sujeción 2 orificios rosca M14x1,5 distancia de sujeción 409mm		

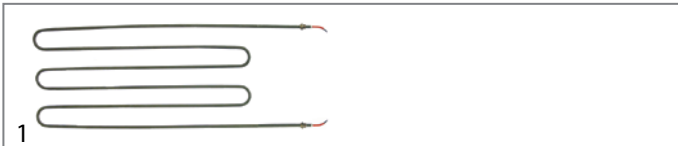

código	416512	referencia	E318022 ELE318022 R0240
descripción	resistencia 2700W 230V espirales 1 L 822mm An 300mm longitud de empalme 55mm tubo ø 8.6mm longitud del cable 440mm resistencia seca barra caliente sujeción 2 orificios rosca M14x1,5 distancia de sujeción 291mm		

accesorios para	416512			
	código	510417	referencia	—
	junta plana fibra ø ext. 20mm int.ø 14mm espesor 2mm UE 1 pzs			
	código	520228	referencia	—
	arandela dentada int.ø 15.3mm ø ext. 24mm acero UE 1 pzs para rosca M14			
	código	520230	referencia	—
	tuerca rosca M14x1,5 H 5mm EC 19 acero zincado UE 1 pzs			
	código	521101	referencia	—
	tuerca rosca M14x1,5 H 5mm EC 19 inox UE 1 pzs			
	código	550262	referencia	—
	junta plana cobre ø ext. 20mm int.ø 14mm espesor 2mm			







resistencias de máquinas de café













código	415436	referencia	E318036 ELE318036 R0285	
descripción	resistencia 1600W 220V L 240mm An 33mm H 30mm L1 65mm L2 175mm distancia de sujeción 25mm rosca M12x1 acero inoxidable empalme M4 tubo ø 8.5mm sujeción 2 orificios resistencia de inmersión			
accesorios para	415436			
	código	510413	referencia	—
	junta plana L 43mm An 19mm agujero ø 12mm dist. del agujero 24mm cobre espesor 2.3mm para resistencia			
	código	510901	referencia	—
	junta tórica EPDM espesor 2mm int.ø 13mm UE 1 pzs			
	código	520229	referencia	—
	tuerca rosca M12x1 H 4mm EC 16 acero zincado UE 1 pzs			

accesorios para	415436			
	código	521103	referencia	—
	tuerca rosca M4 H 3mm EC 7 latón UE 20 pzs			
	código	521104	referencia	—
	arandela int.ø 4.3mm ø ext. 8mm espesor 0.5mm latón UE 20 pzs para rosca M4			
	código	521110	referencia	—
	junta plana fibra ø ext. 20mm int.ø 13mm espesor 2mm UE 1 pzs			
	código	521131	referencia	—
	tuerca rosca M12x1 H 3.5mm EC 17 inox UE 1 pzs			
	código	560111	referencia	—
	arandela int.ø 4.3mm ø ext. 9mm espesor 0.8mm inox UE 20 pzs DIN 125A para rosca M4			
	código	560131	referencia	—
	tuerca hexagonal rosca M4 H 3.2mm EC 7 inox DIN/ISO DIN 934 / ISO 4032/8673 UE 20 pzs			









código	415439	referencia	E318039 ELE318039 R0296	
descripción	resistencia 2000W 230V espirales 1 L 342mm An 33mm H 26mm distancia de sujeción 25mm rosca M12x1 empalme M4 tubo ø 8.5mm sujeción 2 orificios resistencia de inmersión			
repuestos para	415439			
	código	532009	referencia	—
	junta tórica EPDM espesor 1.78mm int.ø 14mm UE 10 pzs			
accesorios para	415439			
	código	520228	referencia	—
	arandela dentada int.ø 15.3mm ø ext. 24mm acero UE 1 pzs para rosca M14			
	código	520229	referencia	—
	tuerca rosca M12x1 H 4mm EC 16 acero zincado UE 1 pzs			
	código	521103	referencia	—
	tuerca rosca M4 H 3mm EC 7 latón UE 20 pzs			
	código	521104	referencia	—
	arandela int.ø 4.3mm ø ext. 8mm espesor 0.5mm latón UE 20 pzs para rosca M4			
	código	560111	referencia	—
	arandela int.ø 4.3mm ø ext. 9mm espesor 0.8mm inox UE 20 pzs DIN 125A para rosca M4			
	código	560131	referencia	—
	tuerca hexagonal rosca M4 H 3.2mm EC 7 inox DIN/ISO DIN 934 / ISO 4032/8673 UE 20 pzs			

			
código	415438	referencia	E318038 ELE318038 R0295
descripción	resistencia 4000W 220V L 430mm An 30mm H 37mm distancia de sujeción 22mm rosca M12x1 empalme M4 tubo ø 8.5mm sujeción 2 orificios resistencia de inmersión		
accesorios para	415438		
	código	510413	referencia —
	junta plana L 43mm An 19mm agujero ø 12mm dist. del agujero 24mm cobre espesor 2.3mm para resistencia		
	código	520229	referencia —
	tuerca rosca M12x1 H 4mm EC 16 acero zincado UE 1 pzs		
	código	521103	referencia —
	tuerca rosca M4 H 3mm EC 7 latón UE 20 pzs		
	código	521104	referencia —
	arandela int.ø 4.3mm ø ext. 8mm espesor 0.5mm latón UE 20 pzs para rosca M4		
	código	521110	referencia —
	junta plana fibra ø ext. 20mm int.ø 13mm espesor 2mm UE 1 pzs		
	código	521131	referencia —
	tuerca rosca M12x1 H 3.5mm EC 17 inox UE 1 pzs		
	código	528110	referencia —
	junta tórica EPDM espesor 2.62mm int.ø 12.37mm UE 1 pzs		
	código	560111	referencia —
	arandela int.ø 4.3mm ø ext. 9mm espesor 0.8mm inox UE 20 pzs DIN 125A para rosca M4		
	código	560131	referencia —
	tuerca hexagonal rosca M4 H 3.2mm EC 7 inox DIN/ISO DIN 934 / ISO 4032/8673 UE 20 pzs		





			
código	415525	referencia	E318053 ELE318053 P0155
descripción	resistencia 1100W 380V L 716mm An 205mm rosca M15x1 distancia de sujeción 197mm longitud de empalme 40mm tubo ø 8mm longitud del cable 980mm espirales 1 resistencia seca sujeción 2 orificios		

			
código	415527	referencia	E318055 ELE318055 P0161
descripción	resistencia 1500W 220V L 720mm An 260mm rosca M14x1,5 distancia de sujeción 252mm tubo ø 8.5mm longitud del cable 1000mm espirales 1 resistencia seca sujeción 2 orificios		





			
código	415526	referencia	E318054 ELE318054 P0160
descripción	resistencia 1500W 380V L 720mm An 260mm rosca M14x1,5 distancia de sujeción 290mm empalme cable tubo ø 8.5mm longitud del cable 1000mm espirales 1 resistencia seca sujeción 2 orificios		

			
código	415528	referencia	E318050 ELE318050 P0150
descripción	resistencia 2000W 230V L 465mm An 450mm rosca M14x1,5 distancia de sujeción 441mm longitud de empalme 36mm tubo ø 8.5mm longitud del cable 430mm espirales 1 resistencia seca sujeción 2 orificios		
repuestos para	415528		
	código	510417	referencia —
	junta plana fibra ø ext. 20mm int.ø 14mm espesor 2mm UE 1 pzs		
accesorios para	415528		
	código	361182	referencia —
	tuerca rosca 1/4" H 5mm latón niquelado EC 17 UE 1 pzs		
	código	520228	referencia —
	arandela dentada int.ø 15.3mm ø ext. 24mm acero UE 1 pzs para rosca M14		
	código	550262	referencia —
	junta plana cobre ø ext. 20mm int.ø 14mm espesor 2mm		

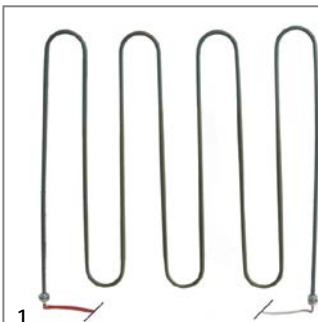
resistencias para hornos de pizza

			
código	415524	referencia	E318052 ELE318052 P0154
descripción	resistencia 1100W 230V L 720mm An 200mm rosca M14x1,5 distancia de sujeción 210mm longitud de empalme 40mm tubo ø 8.5mm longitud del cable 1000mm espirales 1 resistencia seca sujeción 2 orificios		
accesorios para	415524		
	código	361182	referencia —
	tuerca rosca 1/4" H 5mm latón niquelado EC 17 UE 1 pzs		
	código	510417	referencia —
	junta plana fibra ø ext. 20mm int.ø 14mm espesor 2mm UE 1 pzs		
	código	520228	referencia —
	arandela dentada int.ø 15.3mm ø ext. 24mm acero UE 1 pzs para rosca M14		
	código	550262	referencia —
	junta plana cobre ø ext. 20mm int.ø 14mm espesor 2mm		



código	416432	referencia	E318051 ELE318051 P0151
descripción	resistencia 2500W 230V L 575mm An 570mm rosca M14x1,5 distancia de sujeción 561mm longitud de empalme 37mm tubo ø 8.7mm longitud del cable 570mm espirales 1 resistencia seca sujeción 2 orificios		
accesorios para	416432		
	código	510417	referencia —
	junta plana fibra ø ext. 20mm int.ø 14mm espesor 2mm UE 1 pzs		
	código	520228	referencia —
	arandela dentada int.ø 15.3mm ø ext. 24mm acero UE 1 pzs para rosca M14		
	código	520230	referencia —
	tuerca rosca M14x1,5 H 5mm EC 19 acero zincado UE 1 pzs		
	código	521101	referencia —
	tuerca rosca M14x1,5 H 5mm EC 19 inox UE 1 pzs		
	código	550262	referencia —
	junta plana cobre ø ext. 20mm int.ø 14mm espesor 2mm		

resistencias para salamandras / tostadores

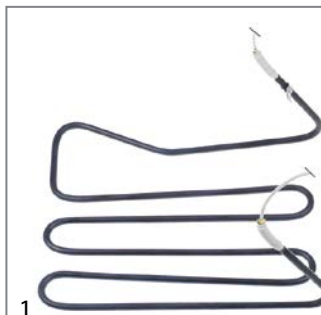

código	415540	referencia	318049 T0120
descripción	resistencia 2000W 230V espirales 1 pos. de montaje derecho L 250mm An 210mm H 120mm B2 170mm distancia de empalme 164mm tubo ø 6.5mm longitud del cable 500mm resistencia seca salamandra		

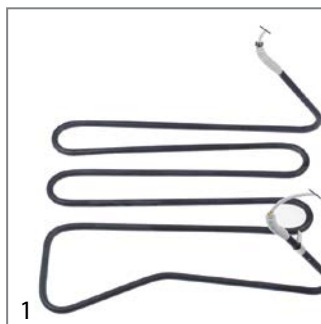

código	415541	referencia	318048 T0119
descripción	resistencia 2000W 230V espirales 1 pos. de montaje izquierdo L 250mm An 210mm H 120mm B2 170mm distancia de empalme 164mm tubo ø 6.3mm longitud del cable 500mm resistencia seca salamandra		





código	415539	referencia	127132 E318011 EL0127132 ELE318011 R0205
descripción	resistencia 2100W 220V espirales 1 L 470mm An 207mm empalme conector Faston 6,3mm distancia de empalme 201mm tubo ø 6.3mm resistencia seca H 6.3mm		



código	415538	referencia	102644 E318010 EL0102644 ELE318010 R0200
descripción	resistencia 2200W 230V espirales 1 L 365mm An 178mm empalme conector Faston 6,3mm distancia de empalme 172mm tubo ø 6.3mm resistencia seca H 6.3mm		

resistencias de inmersión



código	415438	referencia	E318038 ELE318038 R0295
descripción	resistencia 4000W 220V L 430mm An 30mm H 37mm distancia de sujeción 22mm rosca M12x1 empalme M4 tubo ø 8.5mm sujeción 2 orificios resistencia de inmersión		
accesorios para	415438		
	código	510413	referencia —
	junta plana L 43mm An 19mm agujero ø 12mm dist. del agujero 24mm cobre espesor 2.3mm para resistencia		
	código	520229	referencia —
	tuerca rosca M12x1 H 4mm EC 16 acero zincado UE 1 pzs		

Continúa en la página siguiente

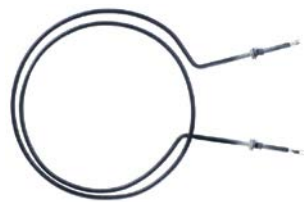

accesorios para	415438		
	código	521103	referencia —
	tuerca rosca M4 H 3mm EC 7 latón UE 20 pzs		
	código	521104	referencia —
	arandela int.ø 4.3mm ø ext. 8mm espesor 0.5mm latón UE 20 pzs para rosca M4		
	código	521110	referencia —
	junta plana fibra ø ext. 20mm int.ø 13mm espesor 2mm UE 1 pzs		
	código	521131	referencia —
	tuerca rosca M12x1 H 3.5mm EC 17 inox UE 1 pzs		
	código	528110	referencia —
	junta tórica EPDM espesor 2.62mm int.ø 12.37mm UE 1 pzs		
	código	560111	referencia —
	arandela int.ø 4.3mm ø ext. 9mm espesor 0.8mm inox UE 20 pzs DIN 125A para rosca M4		
	código	560131	referencia —
	tuerca hexagonal rosca M4 H 3.2mm EC 7 inox DIN/ISO DIN 934 / ISO 4032/8673 UE 20 pzs		



	
código	418897
referencia	318004 576344 E318004 E318090 EL0576344 EL0581984 ELE318004 ELE318090 R0188
descripción	resistencia 1600W 230V espirales 1 int.ø 220mm ø ext. 240mm L 330mm L1 90mm rosca M10x1 empalme conector Faston 6,3mm tubo ø 6.5mm resistencia circulación de aire para horno a vapor combinado
Para modelos:	ELH53, ELH5-3-McDonalds, MD523

			
código	419254	referencia	EL0501247
descripción	resistencia 600W 230V espirales 1 L 340mm An 45mm H 55mm L1 40mm L2 30mm L3 270mm rosca M10x1 distancia de sujeción 40mm tubo ø 6.5mm longitud de empalme 20mm sujeción 2 orificios empalme conector Faston 6,3mm		

			
código	419252	referencia	EL0584126 ELE318091
descripción	resistencia 2000W 230V espirales 1 int.ø 180mm ø ext. 193mm L 258mm H 25mm L1 60mm B1 30mm H1 7mm H2 18mm longitud brida 70mm anchura brida 22mm dist. del agujero 56mm empalme conector Faston 6,3mm longitud de empalme 55mm tubo ø 6.5mm resistencia circulación de aire agujero ø M4mm brida rectangular		

resistencias circulación de aire

			
código	418739	referencia	318105 742414 EL0742414 ELE318105
descripción	resistencia 10500W 230V espirales 3 int.ø 411mm ø ext. 428mm L 480mm H 110mm L1 52mm B1 99mm H1 18mm H2 92mm longitud brida 130mm anchura brida 54mm dist. del agujero 55mm empalme M5 longitud de empalme 96mm tubo ø 8.5mm resistencia circulación de aire rosca de sujeción M6 brida rectangular con pasador roscado		
Para modelos:	1011, 2011, 611, AUTOCLEAN, GENIUS, GENIUS6-11, MAKT, MB, MULTIMAXA, MULTIMAXB		
accesorios para	418739		
	código	551240	referencia 749451 E427064 EL0749451 ELE427064
	junta L 129mm An 87mm D1 ø 12mm D2 ø 7mm 12 orificios grafito espesor 1mm		

			
código	418959	referencia	742422 E318106 EL0742422 ELE318106
descripción	resistencia 21600W 230V espirales 6 int.ø 414mm ø ext. 466mm L 522mm H 121.5mm L1 88mm B1 97mm H1 30.5mm H2 91mm longitud brida 130mm anchura brida 88mm empalme M5 longitud de empalme 70mm tubo ø 6.5mm rosca de sujeción M6 brida con perno M6		
Para modelos:	1011, 2011, 611, AUTOCLEAN, GENIUS, MAKT, MB, MULTIMAXA, MULTIMAXB		
accesorios para	418959		
	código	519647	referencia E412169 EL0757993 ELE412169
	contrabrida ø 8mm ø perforación 13mm L 130mm An 88mm apto para resistencia circulación de aire 12 orificios		

Continúa en la página siguiente

accesorios para 418959					
	<table border="1"> <tr> <td>código</td> <td>551240</td> <td>referencia</td> <td>749451 E427064 EL0749451 ELE427064</td> </tr> </table>	código	551240	referencia	749451 E427064 EL0749451 ELE427064
código	551240	referencia	749451 E427064 EL0749451 ELE427064		
junta L 129mm An 87mm D1 ø 12mm D2 ø 7mm 12 orificios grafito espesor 1mm					

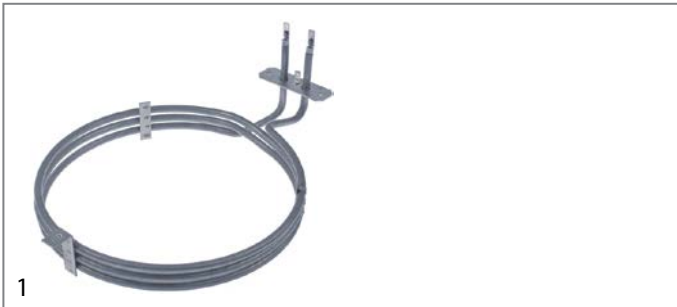



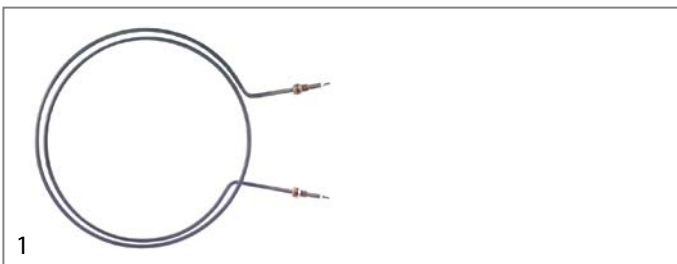

código	420300	referencia	318071 318087 590118 E318087 EL0318087 EL0590118 ELE318087
descripción	resistencia 3400W 230V espirales 1 int.ø 200mm ø ext. 212mm L 268mm H 33mm L1 50mm B1 30mm H1 5mm H2 30mm longitud brida 70mm anchura brida 22mm dist. del agujero 56mm empalme conector Faston 6,3mm tubo ø 6.5mm resistencia circulación de aire agujero ø 3.5mm brida		
Para modelos:	EB30, EB30XLDIGITAL, EBM3e-McDonalds		



código	418766	referencia	E318002 ELE318002 R0184
descripción	resistencia 4500W 230V espirales 1 int.ø 380mm ø ext. 405mm L 530mm L1 100mm H 17mm rosca M14x1,5 empalme M4 tubo ø 8.5mm		
Para modelos:	MD1011, MD2011, MMD1011, MMD2011		

repuestos para 418766			
	código 510417	referencia	—
junta plana fibra ø ext. 20mm int.ø 14mm espesor 2mm UE 1 pzs			



accesorios para 418766			
	código 520228	referencia	—
arandela dentada int.ø 15.3mm ø ext. 24mm acero UE 1 pzs para rosca M14			
	código 520230	referencia	—
tuerca rosca M14x1,5 H 5mm EC 19 acero zincado UE 1 pzs			
	código 521101	referencia	—
tuerca rosca M14x1,5 H 5mm EC 19 inox UE 1 pzs			
	código 550262	referencia	—
junta plana cobre ø ext. 20mm int.ø 14mm espesor 2mm			

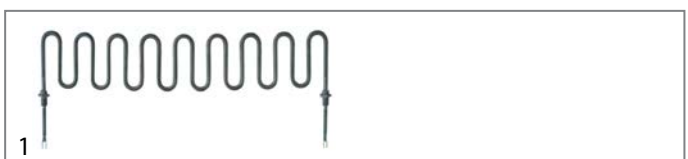

código	415805	referencia	693383 E318078 EL0693383 ELE318078
descripción	resistencia 5700W 230V espirales 3 int.ø 206mm ø ext. 245mm L 290mm H 42mm L1 45mm B1 97mm H1 2mm H2 40mm longitud brida 110mm anchura brida 20mm dist. del agujero 35mm empalme conector Faston 6,3mm longitud de empalme 58mm tubo ø 6.3mm resistencia circulación de aire agujero ø 6.5mm brida rectangular		
Para modelos:	EB30, JOKERB, JOKERC		



código	415133	referencia	318017 ELE318017
descripción	resistencia 1430W 230V espirales 1 L 85mm An 395mm empalme conector Faston 6,3mm tubo ø 6.3mm rosca M10x1 sujeción 2 orif- cios resistencia seca distancia de sujeción 389mm		
Para modelos:	EBM5, ELH61, MD2011, MD611, MMC2011, MMC611, MMD2011, MMD611		

accesorios para 415133			
	código 520231	referencia	—
tuerca rosca M10x1 H 6mm EC 14 acero zincado UE 1 pzs			
	código 521129	referencia	—
tuerca rosca M10 H 6mm inox EC 17 UE 1 pzs DIN/ISO DIN 439			

	código 528433	referencia	097071 217840 E427020 E427039 EL0097071 EL0217840 EL0571849 ELE427020 ELE427039 R0300
junta plana cobre ø ext. 14mm int.ø 10mm espesor 1mm			

código	415221	referencia	332429 E318045 EL0332429 ELE318045 R0305
descripción	resistencia 1430W 230V espirales 1 L 90mm An 390mm empalme conector Faston 6,3mm tubo ø 6.3mm rosca M10x1 sujeción 2 orificios resistencia seca distancia de sujeción 376mm		
Para modelos:	MD611, MMD611		
repuestos para	415221		
	código	510416	referencia —
	junta plana fibra ø ext. 19mm int.ø 10.5mm espesor 1.5mm para rosca M10 UE 1 pzs		
accesorios para	415221		
	código	510893	referencia —
	junta tórica EPDM espesor 2.62mm int.ø 9.92mm UE 1 pzs		
	código	520231	referencia —
	tuerca rosca M10x1 H 6mm EC 14 acero zincado UE 1 pzs		
	código	521129	referencia —
	tuerca rosca M10 H 6mm inox EC 17 UE 1 pzs DIN/ISO DIN 439		
	código	528433	referencia 097071 217840 E427020 E427039 EL0097071 EL0217840 EL0571849 ELE427020 ELE427039 R0300
	junta plana cobre ø ext. 14mm int.ø 10mm espesor 1mm		

código	418970	referencia	585726 EL0585726 ELO585726
descripción	resistencia 1450W 230V espirales 1 L 90mm An 315mm		

código	415222	referencia	318018 576581 E318082 EL0576581 ELE318082
descripción	resistencia 2300W 230V espirales 1 L 90mm An 395mm empalme M4 tubo ø 8.5mm rosca M14x1,5 sujeción 2 orificios resistencia seca		
Para modelos:	ELH101, MD1011, MD2011, MMC1011, MMC2011, MMD1011, MMD2011		
accesorios para	415222		
	código	521103	referencia —
	tuerca rosca M4 H 3mm EC 7 latón UE 20 pzs		
	código	521104	referencia —
	arandela int.ø 4.3mm ø ext. 8mm espesor 0.5mm latón UE 20 pzs para rosca M4		
	código	560111	referencia —
	arandela int.ø 4.3mm ø ext. 9mm espesor 0.8mm inox UE 20 pzs DIN 125A para rosca M4		
	código	560131	referencia —
	tuerca hexagonal rosca M4 H 3.2mm EC 7 inox DIN/ISO DIN 934 / ISO 4032/8673 UE 20 pzs		

código	415542	referencia	318047 E318084 ELE318047 ELE318084 R0321
descripción	resistencia 2500W 230V espirales 1 L 131mm An 485mm longitud de empalme 20mm empalme M4 tubo ø 8.5mm rosca M14x1,5 sujeción 2 orificios resistencia circulación de aire distancia de sujeción 480mm		
Para modelos:	MMC2021, MMD2021		
accesorios para	415542		
	código	510417	referencia —
	junta plana fibra ø ext. 20mm int.ø 14mm espesor 2mm UE 1 pzs		
	código	520228	referencia —
	arandela dentada int.ø 15.3mm ø ext. 24mm acero UE 1 pzs para rosca M14		
	código	520230	referencia —
	tuerca rosca M14x1,5 H 5mm EC 19 acero zincado UE 1 pzs		
	código	521101	referencia —
	tuerca rosca M14x1,5 H 5mm EC 19 inox UE 1 pzs		
	código	550262	referencia —
	junta plana cobre ø ext. 20mm int.ø 14mm espesor 2mm		





código	415543	referencia	E318083 ELE318083 R0320
descripción	resistencia 4000W 230V espirales 1 L 131mm An 485mm empalme M4 tubo ø 8.5mm rosca M14x1,5 sujeción 2 orificios resistencia seca		
Para modelos:	MMD2021		

reguladores de energía

EGO

a 1 circuito



código	380015	referencia	314544 E0180 E344009 EL0314544 ELE344009
descripción	regulador de energía 230V 13A circuito simple sentido de rotación derecho eje ø 6x4,6mm eje L 23mm rosca de sujeción M4 liberación potencia 6-100% N° 50.57021.010		

accesorios

pomos



código	110235	referencia	E0322
descripción	pomo reg. de energía 1-3 T máx°C°C ø 50mm eje ø 6x4,6mm parte plana arriba negro		

termostatos

termostatos de control y seguridad

EGO

termostatos de regulación

serie 55.10/19_



código	375070	referencia	091634 E0268 E334007 EL0091634 ELE334007
descripción	termóstato T máx 250°C margen de trabajo 55-250°C 1 polos 1CO 16A sonda ø 3.1mm sonda L 226mm capilar 1170mm aislamiento del capilar 1100mm prensaestopas M9x1 eje L 23mm posición del eje arriba ángulo de rotación 270°		
Para modelos:	1011, 611, AUTOCLEAN, JOKERB, JOKERC, MD1011, MD2011, MD523, MD611, MMD1011, MMD2011, MMD2021, MMD611, MULTIMAXA, WU14		



código	375462	referencia	E0250 E334002 ELE334002
descripción	termóstato T máx 250°C margen de trabajo 55-250°C 1 polos 1NO 16A sonda ø 3.1mm sonda L 226mm capilar 2420mm aislamiento del capilar 1100mm prensaestopas eje ø 6x4,6mm eje L 23mm posición del eje arriba ángulo de rotación 270°		

serie 55.13_



código	375179	referencia	E0260 E334006 ELE334006
descripción	termóstato T máx 131°C margen de trabajo 80-131°C 1 polos 1NO 16A sonda ø 6mm sonda L 98mm capilar 1730mm aislamiento del capilarmm prensaestopas eje ø 6x4,6mm eje L 23mm posición del eje arriba ángulo de rotación 270°		

serie 55.31_

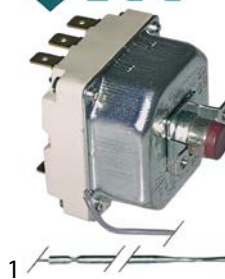

código	375072	referencia	E0160 E336001 ELE336001
descripción	termostato de seguridad temp. desconexión 170°C 3 polos 20A sonda ø 3.1mm sonda L 524mm capilar 350mm aislamiento del capilar 350mm prensaestopas bulbo inox		

serie 55.34_

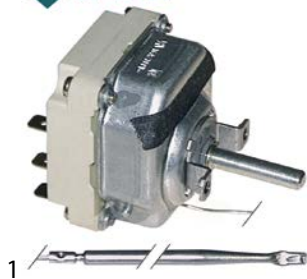

código	375101	referencia	E334008 ELE334008 P0180
descripción	termóstato T máx 360°C margen de trabajo 140-360°C 3 polos 3NO 16A sonda ø 4mm sonda L 292mm capilar 990mm aislamiento del capilar 500mm prensaestopas eje L 23mm posición del eje arriba ángulo de rotación 318°		

serie 55.32_

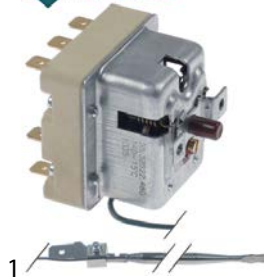

código	390921	referencia	336003 572705 EL0572705
descripción	termostato de seguridad temp. desconexión 305°C 3 polos 3NC 20A sonda ø 4mm sonda L 128mm capilar 890mm aislamiento del capilar 800mm prensaestopas bulbo		
Para modelos:	ELH101, ELH51, ELH53, ELH5-3-McDonalds, ELH61, MD1011, MD523, MD611		

termostatos de seguridad

serie 55.11_

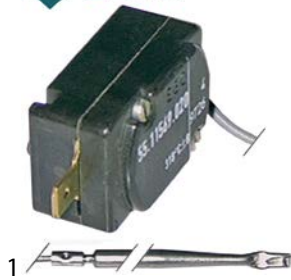

código	375093	referencia	E0232 E336004 ELE336004
descripción	termostato de seguridad temp. desconexión 318°C 1 polos 12A sonda ø 4mm sonda L 111mm capilar 530mm aislamiento del capilar 450mm prensaestopas M9x1 bulbo inox		
Para modelos:	MD1011, MD2011, MD523, MD611, MMD1011, MMD2011, MMD2021, MMD611		

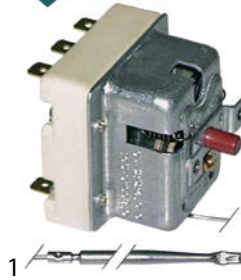

código	375065	referencia	E0234 E336005 ELE336005
descripción	termostato de seguridad temp. desconexión 500°C 3 polos 3NC 20A sonda ø 4mm sonda L 308mm capilar 890mm aislamiento del capilarmm prensaestopas bulbo inox		



serie 55.33_



código	375075	referencia	384429 E0240 E336017 EL0384429 ELE336017
descripción	termostato de seguridad temp. desconexión 305°C 3 polos bulbo		



código	375118	referencia	580457 E336027 EL0580457 ELE336027
descripción	termostato de seguridad temp. desconexión 360°C 3 polos 20A sonda ø 15mm sonda L 8mm capilar 1150mm aislamiento del capilar 1100mm prensaestopas bulbo con botón sensor		

serie 56_



código	375889	referencia	504602 E336029 EL0504602 ELE336029
descripción	termostato de seguridad temp. desconexión 360°C 1 polos 16A sonda ø 15mm sonda L 6.5mm capilar 1140mm aislamiento del capilar 1100mm prensaestopas bulbo		
Para modelos:	1011, 1221, 2011, 2021, 611, AUTOCLEAN, EB30, EB30XLDIGITAL, GENIUS, GENIUS6-11, GENIUS6-11GAS, GENIUSGAS, JOKERB, JOKERC, MAKT, MB, MULTIMAXA, MULTIMAXB, MULTIMAXB6-11AUTOCLEAN		
accesorios para	375889		
	código	518669	referencia 0373079 EL0373079
junta PTFE ø ext. 21mm int.ø 15mm espesor 3.5mm			

accesorios



código	518669	referencia	0373079 EL0373079
descripción	junta PTFE ø ext. 21mm int.ø 15mm espesor 3.5mm		
accesorios para	518669		
	código	375889	referencia 504602 E336029 EL0504602 ELE336029
termostato de seguridad temp. desconexión 360°C 1 polos 16A sonda ø 15mm sonda L 6.5mm capilar 1140mm aislamiento del capilar 1100mm prensaestopas bulbo			

termostatos de regulación con indicación





código	379034	referencia	E336015 ELE336015 P0183
descripción	termóstato T máx 450°C margen de trabajo 50-450°C 1 polos 1CO 5A sonda ø 6mm sonda L 30mm capilar 1150mm aislamiento del capilar 1100mm prensaestopas montaje ø 80mm medida de montaje 96x96mm		

interruptores y pulsadores
interruptores/pulsadores basculantes

30x22mm



código	301001	referencia	E320030 ELE320030 P0185
descripción	interruptor basculante medida de montaje 30x22mm rojo 2NO 250V 16A iluminado 0-I empalme conector Faston 6,3mm temperatura ambiente máx. 125/55°C protección IP65		
accesorios para	301001		
	código	301036	referencia —
cubierta protectora dimensión interior 30x22mm para interruptor basculante medida de montaje mm			

 <p>1</p>			
código	301003	referencia	E320032 ELE320032 P0187
descripción	interruptor basculante medida de montaje 30x22mm verde 2NO 250V 16A iluminado 0-I empalme conector Faston 6,3mm temperatura ambiente máx. 125/55°C protección IP65		
accesorios para	301003		
	código	referencia	—
	 <p>cubierta protectora dimensión interior 30x22mm para interruptor basculante medida de montaje</p>		

microinterruptores

universal



<p>1</p>			
código	345042	referencia	570540 E320055 EL0570540 ELE320055
descripción	microinterruptor con varilla 250V 16A 1CO empalme conector Faston 6,3mm L 28mm temperatura ambiente máx. 125°C distancia de sujeción 22mm tipo EF83161.3 fuerza de accionamiento: 75g azul/negro		
Para modelos:	EB30, EB30XLDIGITAL, JOKERB, JOKERC		
accesorios para	345042		
	código	referencia	—
	 <p>juego de palancas 5 piezas</p>		

accionados por pistón



<p>1</p>			
código	345042	referencia	570540 E320055 EL0570540 ELE320055
descripción	microinterruptor con varilla 250V 16A 1CO empalme conector Faston 6,3mm L 28mm temperatura ambiente máx. 125°C distancia de sujeción 22mm tipo EF83161.3 fuerza de accionamiento: 75g azul/negro		
Para modelos:	EB30, EB30XLDIGITAL, JOKERB, JOKERC		
accesorios para	345042		
	código	referencia	—
	 <p>juego de palancas 5 piezas</p>		

M16

 <p>1</p>			
código	345046	referencia	092444 E0290 E320036 EL0092444 ELE320036 V0600
descripción	microinterruptor con varilla rosca M16x1 rosca L 25mm 250V 5A 1NC/1NO empalme conector Faston 6,3mm carrera 6mm temperatura ambiente máx. 85°C fuerza de accionamiento: 400g		
Para modelos:	MD1011, MD2011, MD523, MD611, MMD1011, MMD2011, MMD2021, MMD611		

accesorios

 <p>1</p>			
código	347013	referencia	E320058 EL0587141
descripción	palanca para microinterruptor		
Para modelos:	JOKERB, JOKERC		

conmutadores de levas

4 posiciones

 <p>1</p>			
código	300016	referencia	E0185
descripción	conmutador de levas 4 posiciones de control 1NO/2CO secuencia de conmutación 0-1-2-3 16A eje ø 6x4,6mm eje L 23mm empalme conector Faston 6,3mm cerámica		



1

código	300104	referencia	532215 E0187 E320003 EL0532215 ELE320003
descripción	conmutador de levas 4 posiciones de control 3NO/1CO secuencia de conmutación 0-1-2-3 32A eje ø 6x4,6mm eje L 23mm empalme atornillado cerámica		

4 posiciones de conmutación



1

código	300033	referencia	E0190 E320005 ELE320005
descripción	conmutador de levas 4 posiciones de control 4NO secuencia de conmutación 0-1-2-3 16A eje ø 6x4,6mm eje L 23mm empalme conector Faston 6,3mm plástico		

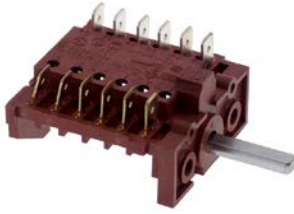

1

código	300057	referencia	292664 E0194 E320008 EL0292664 ELE320008
descripción	conmutador de levas 4 posiciones de control 6NO secuencia de conmutación 0-1-2-3 16A eje ø 6x4,6mm eje L 23mm empalme conector Faston 6,3mm 6CH/141 plástico		
Para modelos:	MD1011, MD523, MD611		



1

código	348195	referencia	320009 EL0553611
descripción	conmutador de levas 4 posiciones de control 9NO secuencia de conmutación 0-1-2-3 16A eje ø 6x4,6mm eje L 23mm empalme F6,3 interruptor auxiliar		
Para modelos:	ELH101, ELH53, ELH5-3-McDonalds, ELH61		



1

código	300034	referencia	E0193
descripción	conmutador de levas 4 posiciones de control mando de selección secuencia de conmutación 0-1-2-3 16A eje ø 6x4,6mm empalme conector Faston 6,3mm 4 polos		

5 posiciones de conmutación



1

código	345199	referencia	E320034 ELE320034 T0133
descripción	conmutador de levas 5 posiciones de control 2NO/1CO secuencia de conmutación 0-1-2-3-4 16A eje ø 6x4,6mm eje L 23mm empalme conector Faston 6,3mm		

interruptor auxiliar



1

código	345321	referencia	E0189 E320004 ELE320004
descripción	interruptor auxiliar 4 posiciones de control 5NO 16A secuencia de conmutación 0-1-2-3 eje ø 6x4,6mm eje L 23mm empalme conector Faston 6,3mm plástico 3 polos temperatura ambiente máx. 300°C		



interruptores magnéticos

∅ 5,22mm



1

código	347011	referencia	581038 E320072 EL0581038 ELE320072
descripción	interruptor magnético 250V 0.04A P máx. 10W sonda L 26mm 1NO longitud del cable 1000mm		
Para modelos:	1011, 1221, 2011, 2021, 611, AUTOCLEAN, GENIUS, GENIUS6-11, GENIUS6-11GAS, GENIUSGAS, MAKT, MB, MULTIMAXA, MULTIMAXB		

M12x1

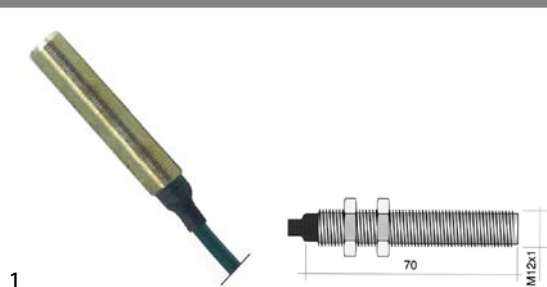

1

código	345135	referencia	372986 E1029 E320048 EL0372986 ELE320048
descripción	interruptor magnético rosca M12x1 1NO 250V 3A P máx. 100W empalme cable longitud del cable 2000mm L 72mm tipo 122		
Para modelos:	JOKERB, JOKERC		

aparatos de mando y aviso

SCHLEGEL

interruptor completo



1

código	359755	referencia	507684 EL0507684
descripción	interruptor medida de montaje ∅16/24x24mm blanco cuadrado 1NO/1NC/lámpara ángulo de rotación° secuencia de conmutación 0-1 completo tipo BFL5		
repuestos para	359755		
	código	346188	referencia
			580341 E320069 EL0580341 ELE320069
	unidad de pulsador medida de montaje ∅16/24x24mm tipo a impulso negro/blanco cuadrado		

repuestos para	359755		
	código	359591	referencia
			—
	bombilla incandescente casquillo T5.5K 48V 3W ∅ 5.5mm L 22mm claro		

teclas



1

código	359183	referencia	332712 E0586 E322022 EL0332712 ELE322022
descripción	unidad de pulsador medida de montaje ∅16/24x24mm tipo a impulso antracita/transparente cuadrado		
Para modelos:	MD1011, MD523, MD611		



1

código	346188	referencia	580341 E320069 EL0580341 ELE320069
descripción	unidad de pulsador medida de montaje ∅16/24x24mm tipo a impulso negro/blanco cuadrado		

tarjetas



1

código	359757	referencia	580368 E358046 EL0580368 ELE358046
descripción	tarjeta octagonal blanco CON.-DESC.		



bloques de contacto



1

código	359184	referencia	323535 E0786 E320024 EL0323535 ELE320024
descripción	bloque de contacto a impulso 1NC/1NO empalme conector Faston 2,8mm casquillo tipo AT		
Para modelos:	MD1011, MD523, MD611		

			
1			
código	359194	referencia	E0790 E320026 EL0590045 ELE320026
descripción	bloque de contacto con enclavamiento 1NC/1NO empalme conector Faston 2,8mm iluminable casquillo T5.5K tipo AFL		
Para modelos:	1011, 2011, 611, JOKERB, MULTIMAXA		

			
1			
código	359756	referencia	580384 E320070 EL0580384 ELE320070
descripción	bloque de contacto con enclavamiento 1NO/1NC empalme conector Faston 2,8mm iluminable casquillo T5.5K tipo BFL5		
accesorios para	359756		
	código	359593	referencia —
bombilla incandescente casquillo T5.5K 60V 0.02A			

accesorios

			
1			
código	359768	referencia	580376 E320068 EL0580376 ELE320068
descripción	tapa para pulsador transparente/sin color octagonal L 19.4mm An 19.4mm		

codificadores y potenciómetros

			
1			
código	300263	referencia	E340083 EL0340083 ELE340083
descripción	codificador ángulo de rotación 360° eje ø 6mm eje L 13mm 0.1W		

			
1			
código	300062	referencia	E606002 ELE606002
descripción	potenciómetro 2x2KOhm		

lámparas

lámparas de señalización

lámparas de señalización 3 piezas (casquillo, lente y bombilla)

ø16,2mm

			
1			
código	359070	referencia	E0275 E314003 ELE314003
descripción	casquillo para lámpara de señalización amarillo		

lámparas

lámparas de descarga

			
1			
código	359600	referencia	E0560 E312001 ELE312001
descripción	lámpara de neón casquillo E10 220V 0.35W claro ø 10mm L 28mm		
accesorios para	359600		
	código	359060	referencia —
portalámparas medida de montaje ø16,2mm casquillo E10 empalme atornillado			
	código	359063	referencia —
portalámparas medida de montaje ø19,2mm casquillo E14 empalme atornillado			
	código	359064	referencia —
portalámparas medida de montaje ø22,3mm casquillo E14 empalme atornillado 250/380V temperatura ambiente 1W 100°C temperature ambiente 2W 85°C			
	código	359685	referencia —
portalámparas medida de montaje ø16,2mm casquillo E10			
	código	359832	referencia —
portalámparas medida de montaje ø16,2mm casquillo Ba9s empalme conector Faston 6,3mm			
	código	359853	referencia —
portalámparas medida de montaje ø18,2mm casquillo Ba9s empalme conector Faston 6,3mm			
	código	359988	referencia —
portalámparas medida de montaje ø30,5mm 250V empalme F6,3 resis.a la temp. 55°C E14			

lámparas de señalización completas

ø 6mm



código	359005	referencia	314011 332798 E0961 E314011 EL0332798 ELE314011
descripción	lámpara de señalización ø 6mm 230V amarillo longitud del cable 400mm		
Para modelos:	EBM5, ELH101, ELH53, ELH5-3-McDonalds, ELH61, MD1011, MD2011, MD523, MD611		



código	359004	referencia	332771 E0960 E0960E E314010 EL0332771 ELE314010
descripción	lámpara de señalización ø 6mm 230V verde longitud del cable 400mm resis.a la temp. 106°C		
Para modelos:	MD1011, MD2011, MD523, MD611		

ø10mm

con casquillo enchufable



código	359140	referencia	E0278 E314002 E314018 EL0091642 ELE314018
descripción	lámpara de señalización ø 10mm amarillo 230V empalme conector Faston 6,3mm UE 1 pzs		

30x22mm



código	359156	referencia	E314020 ELE314020 P0190
descripción	lámpara de señalización medida de montaje 30x22mm 230V amarillo empalme conector Faston 6,3mm resis.a la temp. 125/55°C tipo RL2		



código	359157	referencia	E314021 ELE314021 P0191	
descripción	lámpara de señalización medida de montaje 30x22mm 230V verde empalme conector Faston 6,3mm resis.a la temp. 125/55°C tipo RL2			
accesorios para	359157			
	código	301036	referencia	—
	cubierta protectora dimensión interior 30x22mm para interruptor basculante medida de montajemm			

lámpade

lámparas de descarga



código	359600	referencia	E0560 E312001 ELE312001	
descripción	lámpara de neón casquillo E10 220V 0.35W claro ø 10mm L 28mm			
accesorios para	359600			
	código	359060	referencia	—
	portalámparas medida de montaje ø16,2mm casquillo E10 empalme atornillado			
	código	359063	referencia	—
	portalámparas medida de montaje ø19,2mm casquillo E14 empalme atornillado			
	código	359064	referencia	—
	portalámparas medida de montaje ø22,3mm casquillo E14 empalme atornillado 250/380V temperatura ambiente 1W 100°C temperature ambiente 2W 85°C			
	código	359685	referencia	—
	portalámparas medida de montaje ø16,2mm casquillo E10			
	código	359832	referencia	—
	portalámparas medida de montaje ø16,2mm casquillo Ba9s empalme conector Faston 6,3mm			
	código	359853	referencia	—
	portalámparas medida de montaje ø18,2mm casquillo Ba9s empalme conector Faston 6,3mm			
	código	359988	referencia	—
	portalámparas medida de montaje ø30,5mm 250V empalme F6,3 resis.a la temp. 55°C E14			



bombillas incandescentes

para hornos



1

código	359610	referencia	E0565 E312004 ELE312004
descripción	bombilla incandescente T máx 300°C casquillo E14 15W 230V ø 22mm L 47mm cristal L 20mm para lámpara de horno tipo Philips		



1

código	359612	referencia	354252 E0566 E312003 EL0354252 ELE312003
descripción	bombilla incandescente T máx 300°C casquillo E14 25W 230V ø 25mm L 56mm cristal L 30mm para lámpara de horno tipo Philips		
Para modelos:	MD1011, MD2011, MD523, MD611, MMD1011, MMD2011, MMD2021, MMD611		

otros



1

código	362023	referencia	581488 E0826 E312012 EL0581488 ELE312012
descripción	bombilla incandescente casquillo T5.5K 48V 1.2W 0,025A		
Para modelos:	1011, 2011, 611, EB30, EB30XLDIGITAL, JOKERB, MULTIMAXA		

lámparas halógenas

para portalámpara G4 / G6,35 / G9



1

código	359596	referencia	571954 E312023 EL0571954 ELE312023
descripción	lámpara halógena casquillo G4 12V 10W resis.a la temp. 500°C		
Para modelos:	EB30		



1

código	359599	referencia	570478 E312021 EL0570478 ELE312021
descripción	lámpara halógena casquillo G4 12V 20W resis.a la temp. 500°C		
Para modelos:	1011, 1221, 2011, 2021, 611, AUTOCLEAN, EB30XLDIGITAL, GENIUS, GENIUS6-11, GENIUS6-11GAS, GENIUSGAS, JOKERB, JOKERC, MAKT, MB, MULTIMAXA, MULTIMAXB		

lámparas tubulares

lámparas infrarrojas

con casquillo tipo R7s



1

código	359628	referencia	E0574 E312006 ELE312006
descripción	lámpara infrarroja casquillo R7s L 117.6mm 240V 300W IMPORT sin tubo de protección		



1

código	359622	referencia	EL0531332
descripción	lámpara infrarroja casquillo casquillo Li_R 230V 1000W L 428mm longitud del cable 100mm		

con casquillo tipo X lengüeta



1

código	359617	referencia	531332 E0575 E0577 E312007 E312008 ELE312007 ELE312008
descripción	lámpara infrarroja 1000W 220V L 365mm cristal L 340mm longitud total 480mm con abrazadera de montaje		

portalámparas para lámparas tubulares

X lengüeta



1

código	359710	referencia	E0576 E314007 ELE314007
descripción	portalámparas L 70mm An 70mm H 49mm distancia de sujeción 50mm lengüeta de sujeción		



lámparas fluorescentes

lámparas fluorescentes

2G11



código	359640	referencia	E1013 E312015 ELE312015
descripción	lámpara fluorescente casquillo 2G11 L 217mm 18W 230V		



código	359634	referencia	E1010 E312014 ELE312014
descripción	lámpara fluorescente casquillo 2G11 L 411mm 36W 230V		

accesorios

casquillos



código	381156	referencia	E1011 E314015 ELE314015
descripción	portalámparas casquillo 2G11 dist. del agujero 24mm T máx 140°C para lámparas fluorescentes		

lámparas para hornos



lámparas de horno universales

diámetro de montaje 35,5mm





código	359701	referencia	E0530 E314004 EL0527777 ELE314004
descripción	portalámparas casquillo E14 220-230V montaje ø 35.5mm empalme conector Faston 6,3mm 15W		
Para modelos:	MD1011, MD2011, MD523, MD611, MMD1011, MMD2011, MMD2021, MMD611		

accesorios para	359701			
	código	359705	referencia	092339 E0555 E460003 EL0092339 ELE460003
	cubierta para lámpara de horno r.ø 33.5mm ø 52mm vidrio duro resis.a la temp. 350°C			

accesorios para	359701			
	código	359709	referencia	E0532 E460002 ELE460002
	cubierta para lámpara de horno r.ø 33.5mm ø 42mm vidrio duro resis.a la temp. 350°C			
	código	359721	referencia	425132 693421 976024 E0556 E425005 E425132 EL0976024 ELE425005 ELE425132
	junta silicona ø ext. 48mm int.ø 39.5mm espesor 5mm UE 1 pzs			
	código	359942	referencia	—
	cubierta para lámpara de horno r.ø 33.5mm ø 41mm vidrio duro resis.a la temp. 350°C			

	código	359709	referencia	E0532 E460002 ELE460002
	cubierta para lámpara de horno r.ø 33.5mm ø 42mm vidrio duro resis.a la temp. 350°C			
Para modelos:	MD2011, MMD2011, MMD2021			

	código	359705	referencia	092339 E0555 E460003 EL0092339 ELE460003
	cubierta para lámpara de horno r.ø 33.5mm ø 52mm vidrio duro resis.a la temp. 350°C			

accesorios para	359705			
	código	359610	referencia	E0565 E312004 ELE312004
	bombilla incandescente T máx 300°C casquillo E14 15W 230V ø 22mm L 47mm cristal L 20mm para lámpara de horno tipo Philips			
	código	359700	referencia	—
	junta para horno de pizza fibra de vidrio int.ø 32.5mm ø ext. 55mm espesor 5mm			
	código	359721	referencia	425132 693421 976024 E0556 E425005 E425132 EL0976024 ELE425005 ELE425132
	junta silicona ø ext. 48mm int.ø 39.5mm espesor 5mm UE 1 pzs			
	código	359837	referencia	—
	junta int.ø 33mm ø ext. 46mm espesor 1mm grafito			

Continúa en la página siguiente



accesorios para	359705		
	código	359838	referencia
	junta int.ø 33mm ø ext. 45mm		

1 			
código	359721	referencia	425132 693421 976024 E0556 E425005 E425132 EL0976024 ELE425005 ELE425132
descripción	junta silicona ø ext. 48mm int.ø 39.5mm espesor 5mm UE 1 pzs		
Para modelos:	EBM3e-McDonalds, JOKERB, JOKERC		

lámparas de horno específicas del fabricante

ELOMA

1 			
código	359639	referencia	367664 B0382 E314001 EL0367664 ELE314001
descripción	portalámparas casquillo E14 con borne de sujeción		

1 			
código	357129	referencia	EL0510288
descripción	portalámparas casquillo E14 dist. del agujero 52x89mm medida de montaje 70x80mm		

1 			
código	359068	referencia	E314019 ELE314019 P0166
descripción	portalámparas con sujeción de 2 orificios casquillo E14 ø 25mm		

lámparas

bombillas incandescentes

1 			
código	359610	referencia	E0565 E312004 ELE312004
descripción	bombilla incandescente T máx 300°C casquillo E14 15W 230V ø 22mm L 47mm cristal L 20mm para lámpara de horno tipo Philips		

1 			
código	359612	referencia	354252 E0566 E312003 EL0354252 ELE312003
descripción	bombilla incandescente T máx 300°C casquillo E14 25W 230V ø 25mm L 56mm cristal L 30mm para lámpara de horno tipo Philips		
Para modelos:	MD1011, MD2011, MD523, MD611, MMD1011, MMD2011, MMD2021, MMD611		

lámparas halógenas

para portalámpara G4 / G6,35 / G9

1 			
código	359596	referencia	571954 E312023 EL0571954 ELE312023
descripción	lámpara halógena casquillo G4 12V 10W resis.a la temp. 500°C		
Para modelos:	EB30		

1 			
código	359599	referencia	570478 E312021 EL0570478 ELE312021
descripción	lámpara halógena casquillo G4 12V 20W resis.a la temp. 500°C		
Para modelos:	1011, 1221, 2011, 2021, 611, AUTOCLEAN, EB30XLDIGITAL, GENIUS, GENIUS6-11, GENIUS6-11GAS, GENIUSGAS, JOKERB, JOKERC, MAKT, MB, MULTIMAXA, MULTIMAXB		

casquillos

G4 / G5,3 / G6,35



1			
código	359646	referencia	577294 E314031 EL0577294 ELE314031
descripción	portalámparas casquillo G4/G5,3/G6,35 24V ø 17mm H 15mm empalme cable 130mm distancia de sujeción 26mm para lámpara halógena longitud del soporte 31mm longitud del cable 130mm		
Para modelos:	1011, 1221, 2011, 2021, 611, GENIUS, JOKERB, JOKERC, MAKT, MB		

temporizadores

temporizadores eléctricos





1			
código	350191	referencia	0157988
descripción	temporizador 1CO/1NO posición permanente presente accionamiento eléctrico eje ø 6x4,6mm eje L 23mm distancia de sujeción 28mm empalme lateral 2 polos tiempo de funcionamiento 120min		



1			
código	350001	referencia	E0205 E330006 ELE330006
descripción	temporizador 2CO a 250 V 16A posición permanente presente accionamiento eléctrico eje ø 6x4,6mm eje L 22mm distancia de sujeción 28mm empalme atrás 2 polos tiempo de funcionamiento 120min		
Para modelos:	MD1011, MD523, MD611		



1			
código	350059	referencia	871400 E598179 EL0871400 ELE598179
descripción	temporizador MS65 tiempo de funcionamiento 120min minuto por minuto hastamin 2CO/1NO a 250 V 16A posición permanente presente accionamiento eléctrico eje ø 6x4,6mm eje L 20mm distancia de sujeción 28mm rosca de sujeción M4 empalme lateral 3 polos		
accesorios para	350059		
	código	110366	referencia —
	pomo interruptor marca cero T máx°C°C ø 44mm eje ø 6x4,6mm parte plana arriba negro		
	código	110381	referencia —
	escala circular graduación 120min posición permanente presente ángulo de rotación 0-300° ø 60mm relojes temporizador pomo ø 45mm con posición permanente		

temporizadores mecánicos



1			
código	350203	referencia	592323 EL0505428 EL0592323
descripción	temporizador C20 2 polos tiempo de funcionamiento 15min accionamiento mecánico 2CO a 250 V 16A posición permanente no eje ø 6x4,6mm eje 6x4,6mm eje L 23mm distancia de sujeción 28mm empalme conector Faston 6,3mm temperatura ambiente máx. 125°C		

relojes temporizadores



1			
código	350014	referencia	E330016 ELE330016 T0142
descripción	reloje temporizador tiempo de funcionamiento 15min ø 56mm eje ø 6x4,6mm eje L 24mm distancia de sujeción 28mm		



señalizadores de alarma

zumbadores



código	350051	referencia	091472 E0225 E348002 EL0091472 ELE348002
descripción	zumbador 230VAC empalme conector Faston 6,3mm atornillado rosca M4 zumbador 62dB		
Para modelos:	MD1011, MD2011, MD523, MD611, MMD2011, MMD2021		

altavoces



código	350226	referencia	749877 E348018 EL0749877 ELE348018
descripción	altavoz ø 64mm profundidad de montaje 20mm 50Ohm 0.3W empalme conector Faston 2,8mm		

contactores

ABB

contactores de potencia



código	380112	referencia	EL0523895
descripción	contactor de potencia AC1 45A 230VAC (AC3/400V) 26A/11kW contactos principales 3NO contactos auxiliares 1NO empalme empalme atornillado tipo A26-30-10		
accesorios para	380112		
	código	381031	referencia —
	contacto auxiliar contactos 1NO/1NC AC1 16A AC15 3A empalme empalme atornillado para contactores B6/B7/VB7		



código	381547	referencia	5239090 E324044 EL0510675 EL0523909 ELE324044
descripción	contactor de potencia AC1 25A 100-250VAC (AC3/400V) 9A/4kW contactos principales 3NO contactos auxiliares 1NO empalme empalme atornillado tipo AF09-30-10-13		

ISKRA (FANAL)

contactores de potencia



código	380211	referencia	E0465 E324001 ELE324001
descripción	contactor de potencia 230VAC		
Para modelos:	1011, 2011, 611, AUTOCLEAN, GENIUS, GENIUS6-11, GENIUS6-11GAS, GENIUSGAS, JOKERB, JOKERC, MD523, MD611, MMD611		



código	380216	referencia	E0467 E324002 ELE324002
descripción	contactor de potencia 230VAC		
Para modelos:	1011, 2011, 611, AUTOCLEAN, GENIUS, GENIUS6-11, MD1011, MD2011, MMD1011, MMD2011, MMD2021, MULTIMAXA, MULTIMAXB, MULTIMAXB6-11AUTOCLEAN		



código	380214	referencia	332682 E0470 E324004 EL0332682 ELE324004
descripción	contactor de potencia AC1 20A 230VAC (AC3/400V) 8,5A/5,5kW contactos principales 3NO contactos auxiliares 1NO empalme empalme atornillado tipo FANAL DSL7 00 tipo ISKRA K07M 00		
Para modelos:	MD1011, MD2011, MD523, MD611, MMD2011, MMD2021		



			
1			
código	380213	referencia	324001 EL0324001 ELE324001
descripción	contactor de potencia AC1 20A 230VAC (AC3/400V) 8,5A/5,5kW contactos principales 3NO contactos auxiliares 1NO empalme empalme atornillado tipo FANAL DSL7 10 tipo ISKRA K07M 10		
Para modelos:	EBM3e-McDonalds, EBM5, EDC6-11, ELH101, ELH51, ELH53, ELH5-3-McDonalds, ELH61, HUD511, MD523, MD611, MMC1011, MMC611, MMD1011, MMD611		



			
1			
código	380217	referencia	584150 E0487 E324009 ELE324009
descripción	contactor de potencia AC1 75A 230VAC (AC3/400V) 32A/22kW contactos principales 3NO contactos auxiliares 1NO/1NC empalme empalme atornillado tipo FANAL DSL43 11 tipo ISKRA KNL43		
Para modelos:	MD2011, MMD2011, MMD2021		

			
1			
código	380306	referencia	580481 E324023 EL0580481 ELE324023
descripción	contactor de potencia AC3 4A		
Para modelos:	1011, 1221, 2011, 2021, 611, AUTOCLEAN, GENIUS, GENIUS6-11, GENIUS6-11GAS, GENIUSGAS, MAKT, MB, MULTIMAXA, MULTIMAXB, MULTIMAXB6-11AUTOCLEAN		

<p>contactos auxiliares</p> 			
1			
código	380225	referencia	332690 E0471 E324005 EL0873683 ELE324005
descripción	contacto auxiliar contactos 3NO/1NC AC15 6A para contactores K03C/K07C empalme empalme atornillado tipo FANAL SC4 31 tipo ISKRA ND4C 31		
Para modelos:	MD1011, MD2011, MD523, MD611, MMD2011, MMD2021		

<p>TELEMECANIQUE (Schneider Electric)</p> 			
1			
código	380987	referencia	751790 E324038 EL0751790 ELE324038
descripción	contacto auxiliar contactos 3NO/1NC AC15 10A para contactores LC1K empalme atornillado tipo LA1KN31		
Para modelos:	1011, 1221, 2011, 2021, 611, AUTOCLEAN, GENIUS, GENIUS6-11, MAKT, MB, MULTIMAXB, MULTIMAXB6-11AUTOCLEAN		

semiconductores de potencia

<p>CELDUC</p> 			
1			
código	402049	referencia	752401 E324033 EL0752401 ELE324033
descripción	semiconductor de potencia CELDUC fases 1 carga 60A carga 24-600V 3-32VDC L 58mm An 45mm atornillado tipo SO965460		
Para modelos:	1011, 2011, 611, AUTOCLEAN, GENIUS, GENIUS6-11, GENIUS6-11GAS, GENIUSGAS, MAKT, MB, MULTIMAXA, MULTIMAXB		
accesorios para	402049	código	401564
		referencia	—
	 <p>lámina térmica L 62mm An 45mm para semiconductor de potencia</p>		

<p>CRYDOM</p> 			
1			
código	402052	referencia	EL0752665 ELE324032
descripción	semiconductor de potencia CRYDOM fases 1 carga 90A carga 600V 4-32VDC L 58.6mm An 45mm atornillado tipo H12WD4890PG		



relés

relés de temporización

relés de temporización



1

código	381009	referencia	780421 E332013 EL0780421 ELE332013
descripción	relé de temporización ABB CT-AHE margen de tiempo 0,3-30s 220-240VAC 4A		
Para modelos:	1011, 2011, 611, EB30, EB30XLDIGITAL, GENIUS, MAKT, MB		



1

código	380288	referencia	332615 E0237 E332002 EL0332615 ELE332002
descripción	relé de temporización ELEKTRON VZE 806 margen de tiempo 60s 24-250 AC/DC 5A empalme cable medida de montaje riel DINmm		
Para modelos:	MD1011, MD2011, MD523, MD611, MMD2011, MMD2021		



1

código	350151	referencia	767344 E320080 EL0767344 ELE320080
descripción	relé de temporización FIBER 5A generador impulsos reloj 230V tensión AC margen de tiempo T1 4min T2 10s		

transformadores

transformadores encapsulados

conexiones múltiples



1

código	400252	referencia	570443 E310024 EL0570443 ELE310024
descripción	transformador		
Para modelos:	2011, 2021, AUTOCLEAN, GENIUS, GENIUSGAS, MULTIMAXA, MULTI-MAXB		



1

código	400251	referencia	572217 E310021 EL0572217 ELE310021
descripción	transformador 44VA		
Para modelos:	1011, 1221, 2021, 611, AUTOCLEAN, EB30, EB30XLDIGITAL, GENIUS, GENIUS6-11, GENIUS6-11GAS, GENIUSGAS, JOKERB, JOKERC, MAKT, MB, MULTIMAXA, MULTIMAXB		



1

código	402051	referencia	742775 E310031 EL0742775 ELE310031
descripción	transformador primaria 230VAC secundaria 16,5VAC 2x15VA empalme conector Faston 50/60Hz		
Para modelos:	1011, 1221, 2011, 2021, 611, AUTOCLEAN, GENIUS, GENIUS6-11, GENIUS6-11GAS, GENIUSGAS, MAKT, MB, MULTIMAXA, MULTIMAXB, MULTIMAXB6-11AUTOCLEAN		



PMA



1

código	379054	referencia	P0264
descripción	transformador primaria 230VAC secundaria 12VAC 3VA secundaria 0.25A H 40mm L 45mm An 50mm empalme atornillado 50/60Hz tipo 153/M		

accesorios para	379246			
	código	379053	referencia	—
	sensor de temperatura PTC 1kOhm cable PVC sonda -50 a +150°C cable -10 a 100°C bulbo ø6x30mm longitud de cable 3m sin racor de dos hilos			

controladores electrónicos

SHANGFANG

accesorios



1

código	379054	referencia	P0264
descripción	transformador primaria 230VAC secundaria 12VAC 3VA secundaria 0.25A H 40mm L 45mm An 50mm empalme atornillado 50/60Hz tipo 153/M		

termómetros electrónicos

versión empotrada



1

código	379203	referencia	E348010 ELE348010 P0260	
descripción	termómetro TECNOLOGIC K38VFC-----E---- medida de montaje 70x28mm profundidad de montaje 64mm aliment. 12V tensión AC/DC Pt100/TC (J,K) -200 a 1760°C display 3½ dígitos 1 TempAmbIn Pt100/TC (J,K) func. descon. no dimensiones frontales 35x78,5mm			
accesorios para	379203			
	código	379050	referencia	—
	sensor de temperatura Pt100 cable Vetrotex sonda -200 a +600°C cable -50 a +350°C bulbo ø6x100mm longitud de cable 2.7m sin racor de tres hilos			
	código	379054	referencia	P0264
	transformador primaria 230VAC secundaria 12VAC 3VA secundaria 0.25A H 40mm L 45mm An 50mm empalme atornillado 50/60Hz tipo 153/M			

TECNOLOGIC

controladores universales

versión empotrada



1

código	379246	referencia	329657 E0615 E336011 EL0329657 ELE336011	
descripción	controlador electrónico TECNOLOGIC tipo TLK96HCRR--S medida de montaje 90x90mm aliment. 100-240V tensión AC Pt100/TC (J,K) salidas de relé 2 CO-8A(3) CO-8A(3) Pt100/TC (J,K) dimensiones frontales 96x96mm profundidad de montaje 60mm protección IP65 versión empotrada presente func. descon. no -100 a +1600°C display 4 dígitos			
Para modelos:	MD2011			
accesorios para	379246			
	código	379052	referencia	—
	sensor de temperatura PTC 1kOhm cable silicona sonda -50 a +150°C cable -50 a +180°C bulbo ø6x40mm longitud de cable 1.5m sin racor de dos hilos			

otros

controladores universales



1

código	400206	referencia	332143 E0432 E336010 EL0332143 ELE336010
descripción	controlador electrónico aliment. 230V TempIn1 temporpar K (NiCr-Ni) regulador de temperatura		
Para modelos:	MD1011, MD2011, MD523, MD611, MMD2011, MMD2021		



sensores

sensores universales

sondas de temperatura



código	379062	referencia	E316009 ELE316009 P0268
descripción	sensor de temperatura termopar J (Fe-CuNi) cable Vetrotex sonda -50 a +750°C cable -50 a +350°C bulbo ø6x50mm longitud de cable 3m sin racor de dos hilos		

sensores específicos del fabricante

sensores



código	379117	referencia	316016 873241 E316016 EL0873241
descripción	sensor al corazón Pt100 cable PVC sonda -100 a 450°C cable -10 a 100°C empalme conector Faston 6,3mm rosca 1/4" bulbo ø4x82mm longitud de cable 1.4m		



código	379088	referencia	E0431
descripción	sensor de temperatura Pt100 cable silicona sonda -100 a 450°C cable -50 a +180°C empalme de dos hilos rosca bulbo ø3,2x28mm longitud de cable 1.1m		
Para modelos:	MD2011, MMD2011, MMD2021		



código	379087	referencia	E0436 E316004 EL0570621 ELE316004 ELO570621
descripción	sensor de temperatura termopar K (NiCr-Ni) cable silicona sonda -50 a 1150°C cable -50 a +180°C empalme conector Faston 2,8mm rosca bulbo ø1x30mm longitud de cable 1.6m		
Para modelos:	1011, 1221, 2011, 2021, 611, AUTOCLEAN, GENIUS, GENIUS6-11, GENIUS6-11GAS, GENIUSGAS, JOKERB, JOKERC, MD2011, MMD2021, MULTIMAXA, MULTIMAXB, WU14		



código	379086	referencia	E0433 E316003 ELE316003
descripción	sensor de temperatura termopar K (NiCr-Ni) cable silicona sonda -50 a 1150°C cable -50 a +180°C empalme conector Faston rosca bulbo ø1x30mm longitud de cable 1.2m		
Para modelos:	MD1011, MD2011, MD523, MD611, MMD1011, MMD2011, MMD611		

sondas al corazón



código	378358	referencia	747017 EL0747017
descripción	sensor al corazón		



código	379592 ¹	referencia	752363 E316024 EL0752363 ELE316024
descripción	sensor al corazón 3 puntos sensor cable PTFE sonda -40 a +250°C cable -40 a +250°C empalme de cinco hilos bulbo ø4x100mm rosca longitud de cable 4.5m asidero ø 12mm longitud de asidero 85mm		
Para modelos:	1011, 1221, 2011, 2021, 611, AUTOCLEAN, GENIUS, GENIUS6-11, GENIUS6-11GAS, GENIUSGAS, MAKT, MB, MULTIMAXA, MULTIMAXB		

¹sensor multipunto



código	379089	referencia	E316010 ELE316010 V0602
descripción	sensor al corazón Pt100 cable inox flexible ondulado sonda -40 a +250°C cable -40 a +250°C empalme de tres hilos bulbo ø4x100mm rosca longitud de cable 1.9m asidero ø 15mm longitud de asidero 85mm		
Para modelos:	MD2011, MMD1011, MMD2011, MMD2021, MMD611		



código	379692	referencia	783668 E316026 EL0783668 ELE316026
descripción	sensor al corazón Pt100 cable PTFE sonda -40 a +250°C cable -40 a +250°C empalme de dos hilos bulbo ø4x82mm rosca 1/4" longitud de cable 1.8m asidero ø 12mm longitud de asidero 90mm		



código	379116	referencia	316015 E316027 ELE316027
descripción	sensor al corazón Pt100 cable PTFE sonda -40 a +250°C cable -40 a +250°C empalme de dos hilos bulbo ø4x82mm rosca 1/4" longitud de cable 3m asidero ø 12mm longitud de asidero 90mm		
Para modelos:	EDC6-11		



electrónicas

convertidores de frecuencia

1



código	403178	referencia	EL0508588 EL0779393 EL2002608
descripción	convertidor de frecuencia Kit control de motor 230V 50/60 L 135mm An 110mm H 135mm		

rectificadores

1



código	400253	referencia	570532 E308056 EL0570532 ELE308056
descripción	rectificador		
Para modelos:	1011, 1221, 2011, 2021, 611, AUTOCLEAN, EB30, EB30XLDIGITAL, GENIUS, GENIUS6-11, GENIUS6-11GAS, GENIUSGAS, JOKERB, JOKERC, MAKT, MB, MULTIMAXB, MULTIMAXB6-11AUTOCLEAN		

placas electrónicas

1



código	403181	referencia	742457 EL0502031 EL0742457
descripción	kit de modificación horno a vapor combinado Genius T 6-11 10-11 L 155mm An 115mm longitud del cable 60mm display y placa electrónica		
Para modelos:	1011, 1221, 2011, 2021, 611, AUTOCLEAN, GENIUS, GENIUS6-11, GENIUS6-11GAS, GENIUSGAS, MULTIMAXB		

1



código	401937	referencia	344010 EL0344010
descripción	placa base		
Para modelos:	MMC1011, MMC611, MMD1011, MMD611		

1



código	401000	referencia	580740 E340040 EL0580740 ELE340040
descripción	placa de teclado apto para ELOMA con indicación		
Para modelos:	EDC6-11		

1

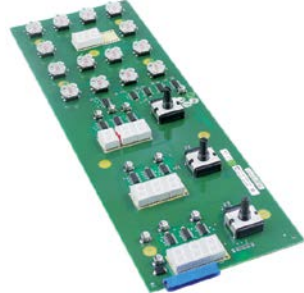

código	402619	referencia	742465 E340053 EL0742465 ELE340053
descripción	placa de teclado horno a vapor combinado 1121/2021 L 350mm An 121mm con Display		
Para modelos:	1011, 1221, 2011, 2021, 611, AUTOCLEAN, GENIUS, MB, MULTIMAXB, MULTIMAXB6-11AUTOCLEAN		

1



código	400016	referencia	593648 E0505 E332008 EL0593648 ELE332008
descripción	placa electrónica generador de impulsos para humidificación con escuadra de montaje		



1

código	400013	referencia	E0510 E344002 ELE344002
descripción	placa electrónica horno a vapor combinado 6x1/1 5x2/3 regulación de nivel		



1

código	403179	referencia	EL0791458
descripción	placa electrónica horno a vapor combinado Genius T 6-11 10-11 L 400mm An 155mm		



1

código	400015	referencia	332704 E0506 E332009 EL0332704 ELE332009
descripción	placa electrónica horno a vapor combinado MD 1011 sin escuadra de montaje generador de impulsos para humidificación		
Para modelos:	MD1011, MD2011, MD523, MD611, MMD2011, MMD2021		

válvulas magnéticas

válvulas magnéticas agua

INTERELEKTRIK

temperatura líquido: 90°C 90°C 60°C
temperatura ambiente: 60°C 25°C 60°C
ciclo de trabajo: 40% 100% 100%



1

código	370688	referencia	754463 EL0754463
descripción	válvula magnética 220-240VAC entrada 3/4" salida 13,5mm DN8 T máx 90°C plástico		
Para modelos:	1011, 1221, 2011, 2021, 611, GENIUS, MAKT, MB		

MÜLLER

temperatura líquido: 90°C
ciclo de trabajo: 100%

recambios y accesorios

filtros



1

código	371122	referencia	0249688 418017 EL0249688 H0421
descripción	filtro de válvula magnética ø 19mm H 10mm apto para MÜLLER		
Para modelos:	1011, 1221, 2011, 2021, 611, EB30, EB30XLDIGITAL, EBMS, EDC6-11, ELH101, ELH51, ELH53, ELH61, GENIUS, MAKT, MB, MD1011, MD2011, MD523, MD611, MMC1011, MMC1011G, MMC2011, MMC2021, MMC611, MMD1011, MMD1011G, MMD2011, MMD2021, MMD611		

RPE

JOHN GUEST



1

código	374113	referencia	EL0508945 EL0508982
descripción	válvula magnética triple recto entrada 3/4" salida 10mm reducción salida 0,07-0,14l/min T máx 60°C RPE		

válvulas magnéticas con reducciones

doble



1

código	374102 ¹	referencia	EL0508944 EL0508981
descripción	válvula magnética doble recto 220-240VAC entrada 3/4" salida 10mm reducción entrada A 10l/min DN10 RPE reducción salida B 0,32-0,42l/min		

¹salida cilíndrica

triple



1

código	374113	referencia	EL0508945 EL0508982
descripción	válvula magnética triple recto entrada 3/4" salida 10mm reducción salida 0,07-0,14l/min T máx 60°C RPE		

metal				
M&M				
2 vías				
serie D-265/266				
				
1				
código	370041	referencia	436003 E0150 ELE436003	
descripción	válvula magnética 2vías 230VAC empalme 3/8" L 54mm DN 10.5mm conector hembra DIN -10 a 130°C M&M serie D-265/266 tipo de bobina 7700 membrana FKM (agua) p máx. 16bar			
repuestos para	370041			
	código	371026	referencia	—
	bobina magnética M&M 230VAC 18VA 50Hz tipo de bobina 7700 soporte ø 15mm			
accesorios para	370041			
	código	371090	referencia	—
	enchufe tipo de conector DIN 43650A atornillado			

MÜLLER			
2 vías			
			
1			
código	370069 ¹	referencia	024775 374806 436004 436007 436033 436039 436040 754471 E0153 E0157 E436004 E436007 E436033 E436039 EL0024775 EL0374806 EL0436040 EL0754471 ELE436004 ELE436007 ELE436033 ELE436039
descripción	válvula magnética 2vías 230VAC entrada 1/8" F salida 1/8" F L 30mm agua MÜLLER DN10		
Para modelos:	1011, 1221, 2011, 2021, 611, AUTOCLEAN, EB30, EB30XLDIGITAL, EBM3e-McDonalds, EBM5, EDC6-11, ELH101, ELH51, ELH53, ELH61, GENIUS, GENIUSGAS, MAKT, MB, MD1011, MD2011, MD523, MD611, MMC1011, MMC1011G, MMC2011, MMC2021, MMC611, MMD1011, MMD1011G, MMD2011, MMD2021, MMD611, MULTIMAXB		

¹con tornillo de regulación

			
1			
código	370037 ¹	referencia	E0155
descripción	válvula magnética 2vías 230VAC entrada 1/8" F salida M16x1 exterior vapor MÜLLER		

¹con tornillo de regulación

Válvulas magnéticas - accesorios

filtros			
			
1			
código	371122	referencia	0249688 418017 EL0249688 H0421
descripción	filtro de válvula magnética ø 19mm H 10mm apto para MÜLLER		
Para modelos:	1011, 1221, 2011, 2021, 611, EB30, EB30XLDIGITAL, EBM5, EDC6-11, ELH101, ELH51, ELH53, ELH61, GENIUS, MAKT, MB, MD1011, MD2011, MD523, MD611, MMC1011, MMC1011G, MMC2011, MMC2021, MMC611, MMD1011, MMD1011G, MMD2011, MMD2021, MMD611		

			
1			
código	370863	referencia	502733 889555 EL0502733 EL0508595
descripción	soporte rosca 3/4" para válvula magnética L 100mm latón		

presostatos para aparatos de café

ø45mm			
			
1			
código	541015	referencia	E0159 E434001 ELE434001
descripción	presostato ø 45mm margen de presión 400/360mbar margen de presión 0,4/0,36bar p máx. 1.02bar conexión de presión vertical aparatos de café empalme 1/4" 1CO apto para Palux, Bremer empalme de presión 1/4"		



para regulación vapor



1

código	541015	referencia	E0159 E434001 ELE434001
descripción	presostato ø 45mm margen de presión 400/360mbar margen de presión 0,4/0,36bar p máx. 1.02bar conexión de presión vertical aparatos de café empalme 1/4" 1CO apto para Palux, Bremer empalme de presión 1/4"		

para hornos a vapor combinado



1

código	541526	referencia	772305 784028 E320083 EL0784028 ELE320083
descripción	presostato p máx. 0.5bar empalme de presión 1/8"		
Para modelos:	1011, 1221, 2011, 2021, 611, AUTOCLEAN, GENIUS, GENIUS6-11, GENIUS6-11GAS, GENIUSGAS, MAKT, MB, MULTIMAXB		

ventiladores

ventilador axial

ebm-papst



1

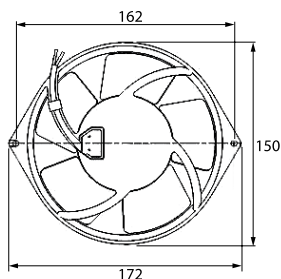



código	601806 ¹	referencia	0503226 EL0503226
descripción	ventilador axial L 172mm An 150mm H 55mm 230VAC 50/60Hz 45/39W cojinete rodamiento de bolas empalme cable 300mm N° fabricante W2S130-AB03-15 ebm-papst		

¹con rodamiento de bolas

importación



1

código	601080 ¹	referencia	693456 E390024 EL0693456 ELE390024
descripción	ventilador axial L 119mm An 119mm H 38mm 230VAC 50/60Hz 23/20W cojinete rodamiento de bolas empalme conector Faston 2,8mm metal ADDA rodete ventilador ø 110mm resis.a la temp. 70°C		
Para modelos:	1011, 2011, 611, EB30, EB30XLDIGITAL, GENIUS, JOKERB, JOKERC, MAKT, MB		
accesorios para	601080		
	código	550898	referencia —
	cable de conexión longitud del cable 2000mm empalme F 2,8 distancia de empalme 7.9mm para ventilador axial		
	código	692519	referencia —
	rejilla de protección L 120mm An 120mm plástico		

¹con rodamiento de bolas

ventiladores tangenciales

COPREL

con bobina estándar



1

código	601032	referencia	573469 E390023 EL0573469 ELE390023
descripción	ventilador tangencial COPREL TFL(FN) rodillo ø 60mm L rodillo 180mm espesor de núcleo laminado 15mm posición del motor izquierdo 230V/50Hz 19W cojinete goma empalme conector Faston 6,3mm tipo de bobina caudal 107m ³ /h -10 a +60°C refrigeración		
Para modelos:	1221, 2011, AUTOCLEAN, GENIUS, GENIUSGAS, MULTIMAXA, MULTIMAXB		



1

código	601452	referencia	573469
descripción	ventilador tangencial TFL 180 rodillo ϕ 60mm L rodillo 180mm espesor de núcleo laminado 20mm posición del motor izquierdo 230V/50Hz 19W universal cojinete silicona empalme conector Faston 6,3mm caudal 100m ³ /h -30 a +100°C 230V 50Hz		
Para modelos:	1011, 1221, 2011, 2021, 611, GENIUS, MAKT, MB		

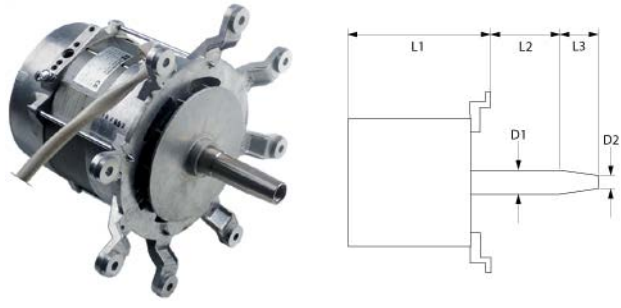

1

código	500171	referencia	E390012 ELE390012 M0129
descripción	motor de ventilador		
Para modelos:	MD1011, MD2011, MMD1011, MMD2011, MMD2021		

motores de aire caliente



1

código	510673	referencia	580600 E412089 EL0580600 ELE412089
descripción	brida para motor de ventilador ϕ ext. 60mm ϕ int. 1 43mm ϕ int. 2 29mm espesor 6mm acero inoxidable		
Para modelos:	1011, 1221, 2011, 2021, 611, AUTOCLEAN, GENIUS, GENIUS6-11, GENIUS6-11GAS, GENIUSGAS, MAKT, MB, MULTIMAXA, MULTIMAXB		

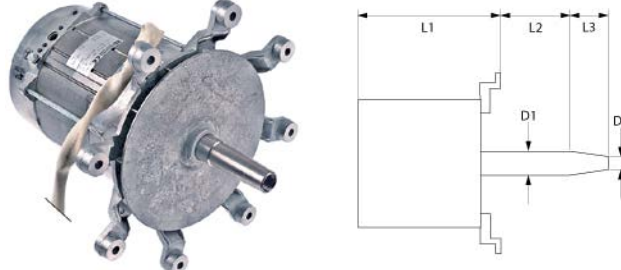

1

código	500172	referencia	E390053 ELE390053
descripción	motor de ventilador 220-240/380-415V fases 3 50Hz 1kW 1400rev/min velocidades 1 L1 220mm L2 34mm L3 31mm M12D F 4,5/2,6A consumo 1350W a 50 Hz 1400rev/min tipo L9FGw4D-363 N° N7 D1 ϕ 23mm D2 ϕ 20mm		



1

código	510675	referencia	373621 E412037 EL0373621 ELE412037
descripción	contrabrida para motor de ventilador ϕ ext. 60mm ϕ int. 2 30mm espesor 5mm acero inoxidable		
Para modelos:	1011, 1221, 2011, 2021, 611, AUTOCLEAN, GENIUS, GENIUS6-11, GENIUS6-11GAS, GENIUSGAS, MAKT, MB, MULTIMAXA, MULTIMAXB		

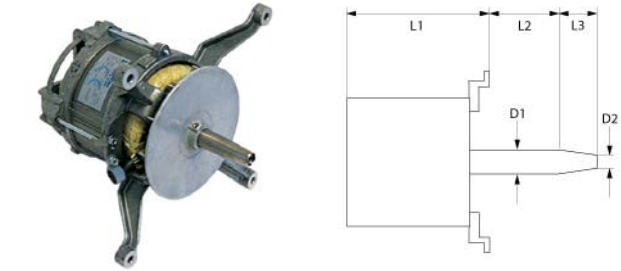

1

código	500102	referencia	332410 E390019 EL0332410 ELE390019 M0155
descripción	motor de ventilador 230-240V fases 1 50Hz 0.09kW 1390rev/min velocidades 1 L1 150mm L2 32mm L3 27mm ϕ 125mm M10D F 1.1A condensador apropiado 4 μ F/400V consumo 200W a 50 Hz 1390rev/min tipo L7yzw4B-207 N° X5 D1 ϕ 17mm D2 ϕ 14mm		
Para modelos:	MD1011, MD611, MMD1011, MMD611		



1

código	503149	referencia	E427010 ELE427010 H0312
descripción	junta fibra para motor de ventilador int. ϕ 32mm ϕ ext. 60mm espesor 1mm con 4 orificios roscados		
Para modelos:	MD1011, MD2011, MD523, MD611, MMD1011, MMD2011, MMD2021, MMD611		

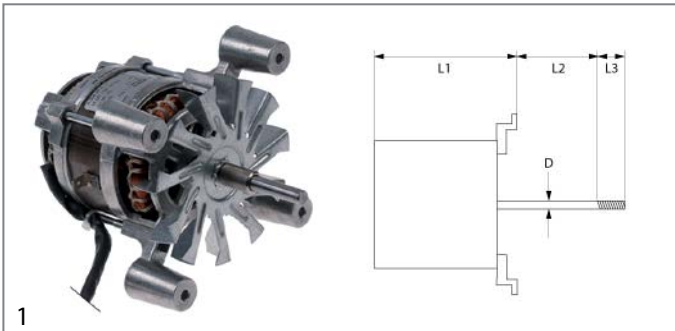

1

código	601474	referencia	693286 E390033 EL0693286 ELE390033
descripción	motor de ventilador 230V fases 1 50/60Hz 0.03kW 3600rev/min velocidades 1 L1 115mm L2 20mm L3 32mm ϕ 12mm longitud de la parte plana 23mm 7,5/8 0,35/0,56A condensador apropiado 3 μ F400V consumo 75/125W a 50 Hz 3600rev/min tipo L5ow2B-317 N° W9		
Para modelos:	EB30, EB30XLDIGITAL, JOKERB, JOKERC		
accesorios para	601474		
	código	602166	referencia
			0693375 E392020 EL0693375 ELE392020
	rodete ventilador palas 9 D1 ϕ 175mm D2 ϕ 8mm D3 ϕ 8mm H1 30mm H2 28mm ED 6-23		

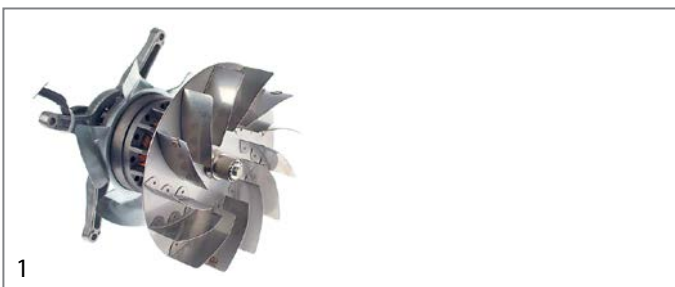

1

código	601871	referencia	302821 EL0302821 EL302821
descripción	motor de ventilador 230V fases 1 50Hz 85kW 2400rev/min velocidades 1 L1 85mm L2 40mm L3 33mm L4 133.5mm rodete ventilador ϕ 180mm a 50 Hz 230V a 60 Hz 230V a 50 Hz 2600rev/min a 60 Hz 2850rev/min tipo R2E180-AU01-09		
Para modelos:	ELH-3		

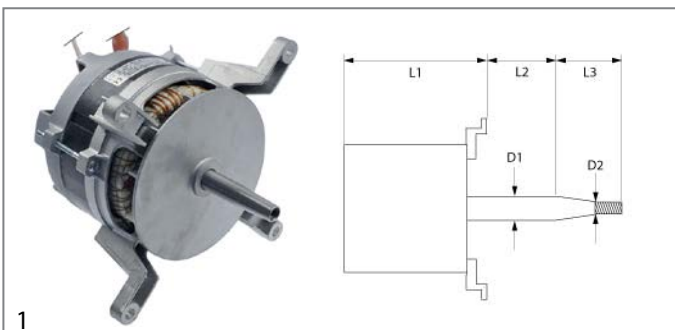

1

código	601864	referencia	509846 742740 EL0509846
descripción	motor de ventilador 380-415V fases 3 50Hz 0.21kW 700/1400rev/min velocidades 2 L1 160mm L2 25mm L3 40mm D1 ϕ 17mm D2 ϕ 13mm M10D F a 50 Hz 700/1400rev/min tipo 3081DH4052		
Para modelos:	1011, 2011, 611, AUTOCLEAN, GENIUS, GENIUS6-11, MAKT, MB, MULTIMAXB		

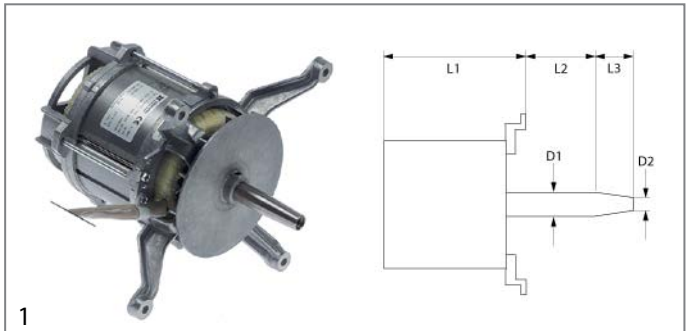

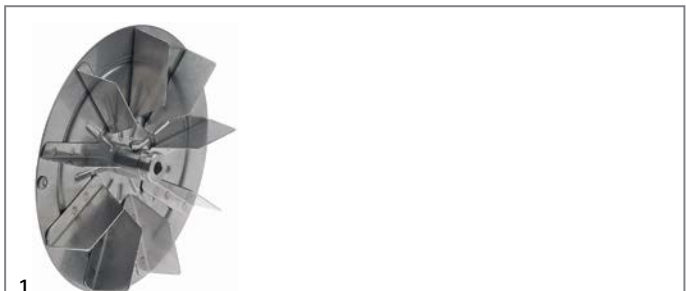

1

código	500170	referencia	580287 E390052 EL0580287 ELE390052
descripción	motor de ventilador fases 3		



1

código	602166	referencia	0693375 E392020 EL0693375 ELE392020
descripción	rodete ventilador palas 9 D1 ϕ 175mm D2 ϕ 8mm D3 ϕ 8mm H1 30mm H2 28mm ED 6-23		
Para modelos:	JOKERB, JOKERC		
accesorios para	602166		
	código	601474	referencia
			693286 E390033 EL0693286 ELE390033
	motor de ventilador 230V fases 1 50/60Hz 0.03kW 3600rev/min velocidades 1 L1 115mm L2 20mm L3 32mm ϕ 12mm longitud de la parte plana 23mm 7,5/8 0,35/0,56A condensador apropiado 3 μ F400V consumo 75/125W a 50 Hz 3600rev/min tipo L5ow2B-317 N° W9		



1

código	602168	referencia	E390077 EL0899992 ELE390077
descripción	rodete ventilador para refrigeración motor ϕ ext. 180mm H 20mm int. ϕ 25mm		
Para modelos:	1011, 1221, 2011, 2021, 611, AUTOCLEAN, GENIUS, GENIUS6-11, GENIUS6-11GAS, GENIUSGAS, MULTIMAXA, MULTIMAXB		

1			
código	694997	referencia	782939 E316025 ELO782939 ELE316025
descripción	sensor de velocidad para motor de aire caliente longitud del cable 450mm		
Para modelos:	1011, 1221, 2011, 2021, 611, AUTOCLEAN, GENIUS, GENIUS6-11, GENIUS6-11GAS, GENIUSGAS, MAKT, MB, MULTIMAXA, MULTIMAXB		

2			
código	500106	referencia	E390006 ELE390006 M0120
descripción	ventilador de aire caliente 230V fases 1 50Hz 0.12kW 2600rev/min velocidades 1 L1 100mm L2 34mm L3 33mm L4 178mm consumo 115W 0.51A rodete ventilador ø 180mm a 50 Hz 230V a 60 Hz 230V a 50 Hz 2600rev/min a 60 Hz 2850rev/min condensador apropiado 3µF400V tipo R2E180-AH05-06		
Para modelos:	MD523		
accesorios para	500106		
	código	100021	referencia —
	terminal Faston hembra tamaño 2,8x0,8mm 0,5-1,0mm ² CuZn T máx 125°C UE 20 pzs		
	código	365028	referencia —
	condensador de servicio capacidad 3µF 450V tolerancia 5% 50/60Hz temperatura ambiente máx. -25 a + 85°C ø 35.5mm L 75mm M8 plástico empalme conector Faston 6,3mm protección		

ventiladores de aire caliente

ebm-papst

1			
código	601059	referencia	E390021 ELE390021 W0320
descripción	ventilador de aire caliente 220-230V 36W 0.26A L1 60mm L2 10mm L3 20mm L4 87mm rodete ventilador ø 150mm tipo R2K150-AN27-17 ebm-papst		

motores

motorreductores

para expendedoras de bebidas

1			
código	499156	referencia	781894
descripción	motorreductor FIBER tipo G025JOB CD86 230V 50/60Hz 4rev/min árbol ø 5x6mm L 15mm tipo de motor M51BJ0R6400		
Para modelos:	EB30, EB30XLDIGITAL		



para hornos a vapor combinado

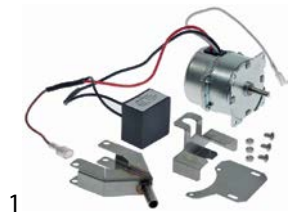

código	502293	referencia	2002236 EL2002236
descripción	motorreductor SYNCHRONOUS MOTOR tipo 60SM60-63-S 14W 230V tensión AC 50/60Hz 20/40rev/min árbol ø 6x5mm L 82mm An 60mm H 60mm Kit		



código	365002	referencia	292753 E0454 E308007 EL0292753 ELE308007
descripción	condensador de servicio capacidad 4µF 400V tolerancia 5% 50/60Hz temperatura ambiente máx. -25 a + 85°C ø 30mm L 75mm con cable M8 aluminio empalme cable 300mm MKP protección IP65		
Para modelos:	MD611, MMD611		

bombas

bombas de vibración



código	499010	referencia	501313 772550 E434022 EL0501313 EL0772550 ELE434022
descripción	bomba magnética tipo E512/B46 230V 60W 50/60Hz entrada ø 7 salida ø 1/8" F CEME L 125mm		
Para modelos:	1011, 1221, 2011, 2021, 611, AUTOCLEAN, GENIUS, GENIUS6-11, GENIUS6-11GAS, GENIUSGAS, MB, MULTIMAXA, MULTIMAXB		

fusibles

fusibles finos



código	358532	referencia	190756 E0173 E375007 EL0190756 ELE375007
descripción	fusible fino medida ø5x20mm 2A rápido nominal 250V UE 10 pzs		
Para modelos:	1011, 1221, 2011, 2021, 611, AUTOCLEAN, GENIUS, GENIUS6-11, GENIUS6-11GAS, GENIUSGAS, JOKERC, MAKT, MB, MD1011, MD2011, MD611, MMD1011, MMD2011, MMD2021, MMD611, MULTIMAXA, MULTIMAXB		

condensadores y filtros antiparasitarios

condensadores de servicio

metal



código	365191	referencia	EL0693480 ELE308035
descripción	condensador de servicio capacidad 3µF 400V tolerancia 5% 60Hz temperatura ambiente máx. -40 a +85°C ø 30mm L 85mm M8 aluminio empalme cable 400mm MLR25L40303063		



código	358699	referencia	572047 E0168 E375004 EL0572047 ELE375004
descripción	fusible fino medida ø5x20mm 10A semi retardado nominal 250V UE 10 pzs		
Para modelos:	JOKERC, MD2011, MMD1011, MMD2011, MMD2021, MMD611, WU14		





código	358697	referencia	E0167 E375003 ELE375003
descripción	fusible fino medida ø5x20mm 6.3A semi retardado nominal 250V UE 10 pzs		

			
1			
código	358608	referencia	578975 EL0578975
descripción	fusible fino medida ø5x20mm 10A retardado nominal 250V UE 10 pzs		
Para modelos:	1011, 1221, 2011, 2021, 611, GENIUS, MAKT, MB		

			
1			
código	358045	referencia	751863 E0970 E375013 EL0751863 ELE375013
descripción	fusible medida D02 35A nominal 250/400V E18 ø 15mm L 36mm UE 10 pzs		
Para modelos:	2011, AUTOCLEAN, GENIUS, MAKT, MB, MD2011, MMD2011, MMD2021, MULTIMAXA, MULTIMAXB		

portafusibles

			
1			
código	550105	referencia	326941 E0345 E373009 EL0326941 ELE373009
descripción	borne seccionable WIELAND tipo WK10/SIU 5X20 /V0 fusible adaptable ø5x20mm 1,0-16mm ² 10A nominal 250V		
Para modelos:	1011, 1221, 2011, 2021, 611, AUTOCLEAN, GENIUS, GENIUS6-11, GENIUS6-11GAS, GENIUSGAS, JOKERB, JOKERC, MAKT, MB, MD1011, MD2011, MD611, MMD2011, MMD2021, MULTIMAXA, MULTIMAXB, MULTIMAXB6-11AUTOCLEAN, WU14		

			
1			
código	358046	referencia	658286 E0969 E375012 EL0658286 ELE375012
descripción	fusible medida D02 50A nominal 250/400V E18 ø 15mm L 36mm UE 10 pzs		
Para modelos:	1221, 2021, AUTOCLEAN, GENIUS, MB, MD2011, MMD2011, MMD2021, MULTIMAXB		

			
1			
código	358049	referencia	751847 E0965 E373028 EL0751847 ELE373028
descripción	portafusibles		
Para modelos:	1221, 2011, 2021, AUTOCLEAN, GENIUS, MAKT, MB, MD2011, MMD2011, MMD2021, MULTIMAXA, MULTIMAXB		

<p>suplementos de ajuste (NEOZED)</p> 			
1			
código	358064	referencia	658308 E0976 E373023 EL0658308
descripción	suplemento de ajuste medida D02 apto para 16A		
Para modelos:	1221, 2021, AUTOCLEAN, GENIUS, MB, MD2011, MMD2011, MMD2021, MULTIMAXB		

fusibles de rosca

sistema D0 (NEOZED)

			
1			
código	358043	referencia	658294 E0974 E375015 EL0658294 ELE375015
descripción	fusible medida D01 16A nominal 250/400V E14 ø 11mm L 36mm UE 10 pzs		
Para modelos:	1221, 2021, AUTOCLEAN, GENIUS, MB, MD2011, MMD2011, MMD2021, MULTIMAXB		

			
1			
código	358067	referencia	751855 E0972 E373021 EL0751855 ELE373021
descripción	suplemento de ajuste medida D02 apto para 35A		
Para modelos:	2011, AUTOCLEAN, GENIUS, MAKT, MB, MD2011, MMD2011, MMD2021, MULTIMAXA, MULTIMAXB		

			
1			
código	358068	referencia	658278 E0971 E373020 ELE373020
descripción	suplemento de ajuste medida D02 apto para 50A		
Para modelos:	1221, 2021, AUTOCLEAN, GENIUS, MB, MD2011, MMD2011, MMD2021, MULTIMAXB		

accesorios eléctricos

terminales

bloques de bornes

WIELAND

bornes de fusibles

			
1			
código	550105	referencia	326941 E0345 E373009 EL0326941 ELE373009
descripción	borne seccionable WIELAND tipo WK10/SIU 5X20 /V0 fusible adaptable ø5x20mm 1,0-16mm ² 10A nominal 250V		
Para modelos:	1011, 1221, 2011, 2021, 611, AUTOCLEAN, GENIUS, GENIUS6-11, GENIUS6-11GAS, GENIUSGAS, JOKERB, JOKERC, MAKT, MB, MD1011, MD2011, MD611, MMD2011, MMD2021, MULTIMAXA, MULTIMAXB, MULTIMAXB6-11AUTOCLEAN, WU14		

accesorios

			
1			
código	550337	referencia	327514 E0346 E371009 EL0327514 ELE371009
descripción	barrera final para terminal de fusible bornesmm ²		
Para modelos:	1011, 1221, 2011, 2021, 611, AUTOCLEAN, EB30, EB30XLDIGITAL, GENIUS, GENIUS6-11, GENIUS6-11GAS, GENIUSGAS, JOKERB, JOKERC, MAKT, MB, MD1011, MD2011, MD611, MMD2011, MMD2021, MULTIMAXA, MULTIMAXB, MULTIMAXB6-11AUTOCLEAN, WU14		

válvulas de gas y centralitas de gas automáticas



válvulas de control de gas

HONEYWELL

			
1			
código	106206	referencia	744050 E434020 EL0744050 ELE434020
descripción	válvula de gas tipo VK4115V 220-240V 50/60Hz entrada gas brida 32x32mm salida gas brida 32x32mm conexión termopar conexión de piloto margen de presión 15-60mbar máx. 60mbar tipo de operador HONEYWELL brida 32x32mm		
Para modelos:	1011, 1221, 2011, 2021, 611, AUTOCLEAN, GENIUS, GENIUS6-11GAS, GENIUSGAS		
accesorios para	106206		
	código	102845	referencia —
	empalme de gas acodado 1/2" brida 32x32mm dist. del agujero 24x24mm Tandem		
	código	102846	referencia —
	empalme de gas recto 1/2" brida 32x32mm dist. del agujero 24x24mm apto para Tandem		

SIT

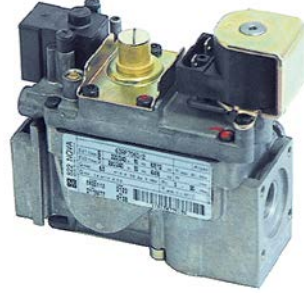
NOVASIT

			
1			
código	101540	referencia	371424 E434008 EL0371424 ELE434008 G0900
descripción	válvula de gas SIT serie Novasit 822 aliment. 230V 50Hz entrada gas 1/2" salida gas 1/2" conexión termopar conexión de piloto cerrado presión de encendido 3-5mbar margen de presión 3-30mbar conexión del presostato ciego núm. Ref. 0.822.113		
repuestos para	101540		
	código	101313	referencia —
	bobina magnética 230V 50Hz		
	código	101542	referencia —
	bobina magnética 50Hz NOVA 822/826/827 apto para NOVASIT aliment. 230V		

Continúa en la página siguiente



accesorios para	101540			
	código	101305	referencia	—
	empalme de gas recto 1/2" brida 45x45mm ELETTROSIT/V4400/4600/4605 para SIT/HONEYWELL dist. del agujero 36x36mm			
	código	101306	referencia	—
	empalme de gas acodado brida 45x45mm dist. del agujero 36x36mm 1/2" ELETTROSIT/V4400/4600/4605 atornillado con junta tórica para SIT/HONEYWELL			
	código	101307	referencia	—
	empalme de gas recto brida 45x45mm dist. del agujero 36x36mm 3/4" ELETTROSIT/V4400/4600/4605 atornillado con junta tórica para SIT/HONEYWELL			
	código	101308	referencia	—
	empalme de gas acodado brida 45x45mm dist. del agujero 36x36mm 3/4" ELETTROSIT/V4400/4600/4605 atornillado con junta tórica para SIT/HONEYWELL			
	código	101317	referencia	—
	conector con cable L 1000mm apto para NOVASIT			
	código	101503	referencia	—
	junta tórica EPDM espesor 2mm int.ø 32mm UE 1 pzs			
	código	101924	referencia	—
	conector con cable L 1090mm apto para NOVA 822/826/827			

encendidos y tempares

electródos



1	código	107890	referencia	507184 EL0507184
	descripción	electrodo de encendido longitud brida 24mm anchura brida 20mm D1 ø 7mm L1 45mm L2 70mm LC1 35mm LC2 22mm empalme F6,3 longitud del cable 450mm distancia de sujeción 9mm		

centralitas de gas automáticas

HONEYWELL



1	código	101166	referencia	371416 E340001 EL0371416 ELE340001 G0901
	descripción	centralita de gas automática HONEYWELL tipo S4560B 1006 electrodos 1 tiempo de espera 0s tiempo de seguridad 10s 220-240V 10VA 50Hz		

otros

	imagen no disponible			
1	código	107936	referencia	EL0506522
	descripción	centralita de gas automática PACTROL apto para ELOMA electrodos 1 tiempo de espera 1s tiempo de seguridad 5s 230V 50/60Hz		

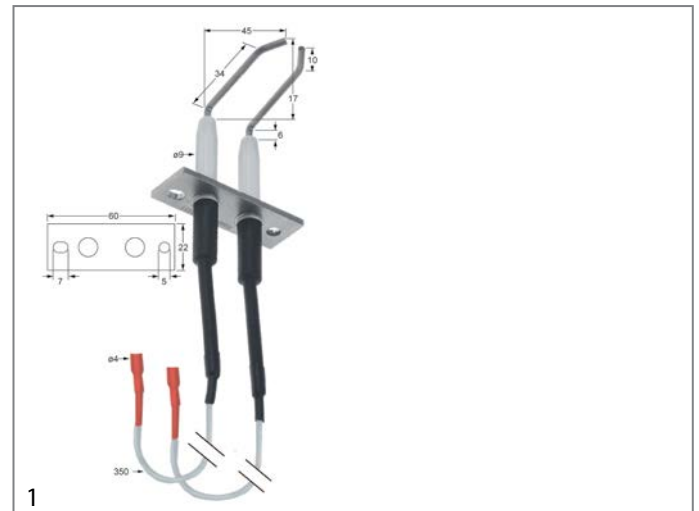

1	código	106996	referencia	874787 EL0874787
	descripción	electrodo de encendido longitud brida 60mm anchura brida 22mm D1 ø 9mm L1 17mm L2 45mm L3 6mm L4 34/10mm LC1 37mm LC2 32mm longitud del cable 350mm ø empalme ø4mm		
	Para modelos:	1011, 2011, 611, GENIUS		
	accesorios para	106996		
	código	699472	referencia	0507495 0507997 0874833 EL0507495 EL0507997 EL0874833
	descripción	junta electrodo de encendido int.ø 13mm agujero ø 6mm L 60mm An 22mm apto para ELOMA grafito		



código	107889	referencia	5071833 EL0507183
descripción	electrodo de encendido longitud brida 60mm anchura brida 22mm D1 ø 9mm L1 33mm L2 45mm L3 6mm L4 45/7mm LC1 29mm LC2 28mm empalme ø4mm longitud del cable 350mm distancia de sujeción 50mm		

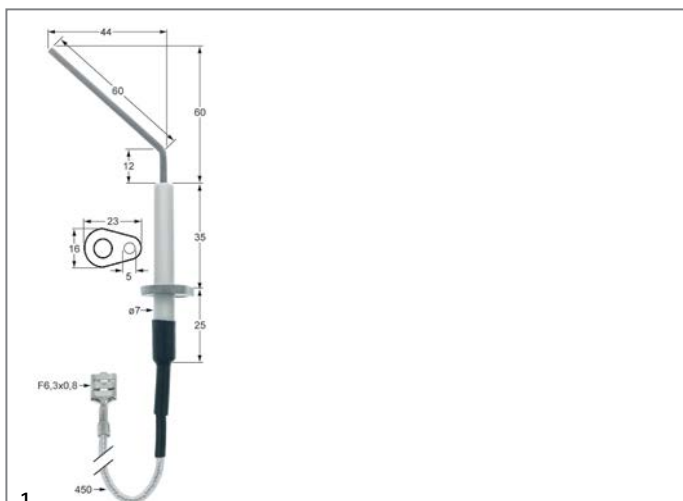

código	106997	referencia	874906 EL0874906
descripción	electrodos de supervisión ø empalme F6,3mm longitud brida 23mm anchura brida 16mm D1 ø 7mm L1 60mm L2 44mm L4 12mm L3 60mm LC1 35mm LC2 25mm empalme F6,3x0,8 longitud del cable 450mm medida de sujeción ø5mm		
Para modelos:	1011, 2011, 611, GENIUS		

código	108151	referencia	EL0507496
descripción	junta bujía L 22.5mm An 15.5mm espesor 2mm grafito		

código	699472	referencia	0507495 0507997 0874833 EL0507495 EL0507997 EL0874833
descripción	junta electrodo de encendido int.ø 13mm agujero ø 6mm L 60mm An 22mm apto para ELOMA grafito		

unidades de encendido

código	107533	referencia	EL0874892
descripción	grupo de encendido salidas 2 230VAC medidas 85x63x38mm distancia de sujeción 60mm entrada F2,8x0,8 salida ø4mm tipo EBI4 60VA 50/60Hz secundaria 15KV		

termopares

termopares insertables

termopares insertables estándar

con casquillo de enchufe ø5mm - type Junkers with aluminised tip

código	102216	referencia	E316012 ELE316012 G0686
descripción	termopar M10x1 L 1500mm clavija ø5,0mm		

boquillas de gas

boquillas piloto

boquillas piloto JUNKERS

serie CB 50203_/503_

código	100222	referencia	E438019 ELE438019 X0342
descripción	boquilla de quemador piloto gas licuado presión de gas 50mbar código 5 UE 1 pzs apto para JUNKERS CB50203_		



materiales auxiliares de gas

consumibles

juntas para roscas



código	890058	referencia	593567
descripción	junta para rosca LOCTITE 511 líquido botella 50ml		
descripción	LOCTITE® 511™ - botella 50ml Está diseñado para fijar y sellar tuberías y conexiones metálicas roscadas. El producto cura rápidamente en ausencia de aire, entre superficies metálicas ajustadas.		
Para modelos:	1011, 1221, 2011, 2021, 611, EB30, EB30XLDIGITAL, GENIUS, MAKT, MB		

componentes específicos

para amasadoras

cadenas

elementos de unión



código	697069	referencia	395021 E395021 ELE395021
descripción	elemento de empalme simple DIN/ISO 06 B-1 división 3/8" eslabones 1 L 17.8mm anchura interior 8.8mm rodillo ø 3mm metal		

para hornos a convección/combinados



código	692909	referencia	782432 EL0782432
descripción	cojinete para bisagra de puerta batiente H 7mm plástico D1 ø 18mm D2 ø 12mm int. ø 10mm		



código	692910	referencia	E401038 EL0563420 EL0568945
descripción	cojinete para bisagra de puerta batiente L 8mm ø 8mm int. ø 6mm		

tubos de inyección



código	692839	referencia	442263 743267
descripción	tubo de inyección para horno a vapor combinado forma U ø ext. 12mm int. ø 10mm L 265mm		
Para modelos:	1011, 2011, 611, AUTOCLEAN, GENIUS, GENIUS6-11, GENIUS6-11GAS, GENIUSGAS, MAKT, MB, MULTIMAXB		



código	692838	referencia	753793 EL0753793 ELE442262
descripción	tubo de inyección para horno a vapor combinado recto ø ext. 12mm int. ø 8mm L 180mm -		
Para modelos:	1011, 2011, 611, GENIUS, MB		

sistema de limpieza

casquillos de acoplamiento



código	501591	referencia	0753890 E440154 EL0753890 ELE440154
descripción	empalme de tubos acero inoxidable tubo ø 10/13mm M9 para sistema de limpieza horno a vapor combinado		

limpieza del brazos



código	542416	referencia	0775177 E600647 EL0775177 ELE600647
descripción	pletina sujeción ø 55mm cubo con junta para brazo de lavado para ELOMA horno a vapor combinado		

bandejas de agua de goteo



1

código	699837	referencia	783331 EL0783331 ELE474094
descripción	bandeja de goteo con borne de sujeción L 530mm An 52mm H 25mm		
Para modelos:	1011, 611, GENIUS, MAKT, MB		



1

código	699270	referencia	0781185 EL0781185
descripción	resorte L 65mm An 32.5mm H 28mm		



1

código	699269	referencia	0781177 EL0781177
descripción	tapón H 10mm ø 20mm		

macánica de puertas

otros



1

código	692909	referencia	782432 EL0782432
descripción	cojinete para bisagra de puerta batiente H 7mm plástico D1 ø 18mm D2 ø 12mm int.ø 10mm		



1

código	692910	referencia	E401038 EL0563420 EL0568945
descripción	cojinete para bisagra de puerta batiente L 8mm ø 8mm int.ø 6mm		

topes de puerta



1

código	694922	referencia	0886726 407079 EL0886726 ELE407079
descripción	tope de goma ø 11.5mm H 19mm goma		

mecánica de cierre



1

código	692714	referencia	0791652 EL0791652
descripción	arandela para cierre ø 44mm agujero ø 6x8mm		



1

código	692715	referencia	775061 888575 EL0775061 EL0888575
descripción	casquillo ø 50mm L 72mm An 59mm H 31mm dist. del agujero 60mm int.ø 37mm		
Para modelos:	1011, 2011, 611, AUTOCLEAN, GENIUS, GENIUS6-11, GENIUS6-11GAS, GENIUSGAS, MAKT, MB, MULTIMAXA, MULTIMAXB		



1

código	692716	referencia	588504 980080 E380093 EL0588504 EL0980080 ELE380093
descripción	cierre de puerta con interruptor L 140mm An 25mm H 63mm dist. del agujero 120mm int.ø 12mm		
Para modelos:	JOKERB, JOKERC		



accesorios



código	699836	referencia	0569593 E407059 EL0569593
descripción	tapón para puerta An 32mm plástico L 50mm		

bombas de vibración



código	499010	referencia	501313 772550 E434022 EL0501313 EL0772550 ELE434022
descripción	bomba magnética tipo E512/B46 230V 60W 50/60Hz entrada ø 7 salida ø 1/8" F CEME L 125mm		
Para modelos:	1011, 1221, 2011, 2021, 611, AUTOCLEAN, GENIUS, GENIUS6-11, GENIUS6-11GAS, GENIUSGAS, MB, MULTIMAXA, MULTIMAXB		

otros



código	696857	referencia	427060 566594 EL0566594 ELE427060
descripción	manguito L 42mm D1 ø 12mm D2 ø 36mm		
Para modelos:	1011, 1221, 2011, 2021, 611, GENIUS, MAKT, MB		



código	692306	referencia	213519 442042 EL0213519 ELE442042 H0446
descripción	tubo largo D1 ø 10mm D2 ø 6mm L 134mm EC 19 rosca 3/8"		
Para modelos:	EBM5, EDC6-11, ELH101, ELH51, ELH53, ELH61, MD2011, MMC2011, MMC2021, MMD2011, MMD2021		



código	692915	referencia	E442044 EL0213500 ELE442044 H0448
descripción	tubo de inyección doble L 192mm D1 ø 8mm D2 ø 6mm EC 19 agujero ø 10mm		

para hornos de pizza

losas de chamota

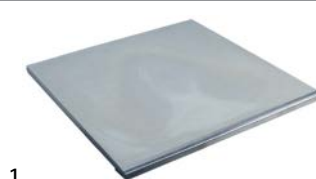

código	850022	referencia	E450029 ELE450029 P0210
descripción	placa inferior L 495mm An 495mm H 16mm horno de pizza para ELP500		

pomos

pomos universales



código	110253	referencia	301086 E0337 E365018 EL0301086 ELE365018
descripción	pomo interruptor marca cero T máx°C°C ø 50mm eje ø 6x4,6mm parte plana arriba negro		



código	110235	referencia	E0322
descripción	pomo reg. de energía 1-3 T máx°C°C ø 50mm eje ø 6x4,6mm parte plana arriba negro		

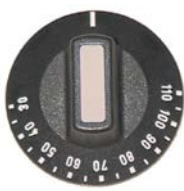

código	110241	referencia	E0340 E365020 ELE365020
descripción	pomo termostato T máx 110°C ø 50mm eje ø 6x4,6mm parte plana arriba negro margen de trabajo 30-110°C		



código	110235	referencia	E0322
descripción	pomo reg. de energía 1-3 T máx°C°C ø 50mm eje ø 6x4,6mm parte plana arriba negro		

pomos personalizados para fabricantes

ELOMA



imagen no disponible

código	112877	referencia	EL0504699 EL0748668
descripción	kit de pomos ø 40mm eje ø 6.3mm		



código	111498	referencia	743690 E365086 EL0743690 ELE365086
descripción	pomo T máx°C°C ø 48mm eje ø 6.5mm parte plana azul		
Para modelos:	1011, 1221, 2011, 2021, 611, AUTOCLEAN, GENIUS, MAKT, MB, MULTIMAXA, MULTIMAXB, MULTIMAXB6-11AUTOCLEAN		
accesorios para	111498		
código	111510	referencia	748781 E365087 EL0748781 ELE365087
descripción	tapa T máx°C°C ø 37mm eje ømm parte plana plata para pomo ELOMA		





código	110253	referencia	301086 E0337 E365018 EL0301086 ELE365018
descripción	pomo interruptor marca cero T máx°C°C ø 50mm eje ø 6x4,6mm parte plana arriba negro		





código	110241	referencia	E0340 E365020 ELE365020
descripción	pomo termostato T máx 110°C ø 50mm eje ø 6x4,6mm parte plana arriba negro margen de trabajo 30-110°C		



código	111499	referencia	332658 E0314 E365003 EL0332658 ELE365003
descripción	pomo interruptor marca cero T máx°C°C ø 52mm eje ø 6x4mm parte plana arriba negro/rojo		
Para modelos:	MD1011, MD2011, MD523, MD611		

 <p>1</p>			
código	111510	referencia	748781 E365087 EL0748781 ELE365087
descripción	tapa T máx°C°C ø 37mm eje ømm parte plana plata para pomo ELOMA		
Para modelos:	1011, 1221, 2011, 2021, 611, AUTOCLEAN, GENIUS, GENIUS6-11, GENIUS6-11GAS, GENIUSGAS, MAKT, MB, MULTIMAXA, MULTIMAXB, MULTIMAXB6-11AUTOCLEAN		
accesorios para	111510		
 <p>1</p>			
código	111498	referencia	743690 E365086 EL0743690 ELE365086
pomo T máx°C°C ø 48mm eje ø 6.5mm parte plana azul			



cierre electromagnético

 <p>1</p>			
código	701439	referencia	EL0503973
descripción	cierre de puerta 24V tensión DC L 134mm An 28mm H 40mm inox con cable de conexión		
repuestos para	701439		
 <p>1</p>			
código	692216	referencia	—
cierre electromagnético 24V tensión DC L 104mm An 24mm H 34mm serie 8440			

 <p>1</p>			
código	692596	referencia	EL0503607
descripción	cierre electromagnético 24V tensión DC L 104mm An 24mm H 34mm		

accesorios

cubiertas

 <p>1</p>			
código	111510	referencia	748781 E365087 EL0748781 ELE365087
descripción	tapa T máx°C°C ø 37mm eje ømm parte plana plata para pomo ELOMA		
Para modelos:	1011, 1221, 2011, 2021, 611, AUTOCLEAN, GENIUS, GENIUS6-11, GENIUS6-11GAS, GENIUSGAS, MAKT, MB, MULTIMAXA, MULTIMAXB, MULTIMAXB6-11AUTOCLEAN		
accesorios para	111510		
 <p>1</p>			
código	111498	referencia	743690 E365086 EL0743690 ELE365086
pomo T máx°C°C ø 48mm eje ø 6.5mm parte plana azul			

cierres de palanca

específico del fabricante

ELOMA

 <p>1</p>			
código	692714	referencia	0791652 EL0791652
descripción	arandela para cierre ø 44mm agujero ø 6x8mm		

 <p>1</p>			
código	692847	referencia	0782505 365152 EL0782505 ELE365152
descripción	manilla de puerta horno a vapor combinado tope derecho L 100mm An 55mm H 35mm asidero ø 35mm azul para ELOMA		
accesorios para	692847		
 <p>1</p>			
código	692848	referencia	0783382 EL0783382
resorte para tirador de puerta tope derecho horno a vapor combinado para ELOMA ø ext. 15mm L 44/11mm espesor de resorte 1.6mm			

cierres

cierres de palanca pivotante

específico del fabricante

ELOMA/PALUX

 <p>1</p>			
código	699268	referencia	588458 E410046 EL0588458
descripción	perno L 19mm H 10mm inox		
Para modelos:	JOKERB, JOKERC		



1

código	691988	referencia	749532 EL0749532
descripción	manilla de puerta L 155mm An 60mm H 58mm longitud muelle 53mm azul distancia de sujeción 40mm espesor de resorte 3mm		
Para modelos:	2011, AUTOCLEAN, GENIUS, GENIUSGAS, MULTIMAXA, MULTIMAXB		
accesorios para	691988		
	código	111510	referencia 748781 E365087 EL0748781 ELE365087
tapa T máx°C°C ø 37mm eje ømm parte plana plata para pomo ELOMA			



1

código	692744	referencia	758388 E365106 EL0758388 ELE365106
descripción	manilla de puerta tope derecho azul		
Para modelos:	1011, 611, AUTOCLEAN, GENIUS, GENIUS6-11, GENIUS6-11GAS, GENIUSGAS, MAKT, MB, MULTIMAXA, MULTIMAXB		



1

código	514450	referencia	791504 EL0791504
descripción	resorte para tirador de puerta ø 6mm L 61mm An 27.5mm		



1

código	692849	referencia	0783390 416078 EL0783390 ELE416078
descripción	resorte para tirador de puerta tope a la derecha horno a vapor combinado para ELOMA ø ext. 15mm L 44/11mm espesor de resorte 1.6mm		



1

código	692848	referencia	0783382 EL0783382
descripción	resorte para tirador de puerta tope derecho horno a vapor combinado para ELOMA ø ext. 15mm L 44/11mm espesor de resorte 1.6mm		



1

código	694067	referencia	747998 E380120 EL0747998 ELE380120
descripción	retén con espiga 1 nivel L 26mm longitud total 51mm rosca M8		
Para modelos:	1011, 2011, 611, GENIUS, GENIUS6-11, GENIUS6-11GAS, GENIUSGAS, MAKT, MB, MULTIMAXA, MULTIMAXB		





1

código	694253	referencia	758264 E380121 EL0758264 ELE380121
descripción	retén con espiga 2 niveles L 36mm longitud total 60mm rosca M8 rosca L 25mm pos. de montaje tope a la derecha		
Para modelos:	1011, 2011, 611, AUTOCLEAN, GENIUS, GENIUS6-11, GENIUS6-11GAS, GENIUSGAS, MAKT, MB, MULTIMAXB		



1



código	691990	referencia	748765 E365091 EL0748765 ELE365091
descripción	manilla de puerta tope a la derecha L 155mm An 60mm H 58mm longitud muelle 53mm azul distancia de sujeción 40mm rosca de sujeción M4		
Para modelos:	1011, 611, AUTOCLEAN, GENIUS, GENIUS6-11, GENIUS6-11GAS, GENIUSGAS, MAKT, MB, MULTIMAXA, MULTIMAXB		
repuestos para	691990		
	código	514450	referencia 791504 EL0791504
resorte para tirador de puerta ø 6mm L 61mm An 27.5mm			
accesorios para	691990		
	código	111510	referencia 748781 E365087 EL0748781 ELE365087
tapa T máx°C°C ø 37mm eje ømm parte plana plata para pomo ELOMA			

			
1			
código	694254	referencia	758272 E380122 EL0758272 ELE380122
descripción	retén con espiga 2 niveles L 36mm longitud total 60mm rosca M8 rosca L 25mm pos. de montaje tope derecho		
Para modelos:	1011, 2011, 611, AUTOCLEAN, GENIUS, GENIUS6-11, GENIUS6-11GAS, GENIUSGAS, MAKT, MB, MULTIMAXB		

cierres angulares

cierres de palanca

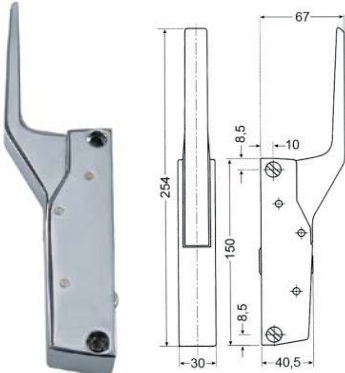



CAFF/FERMOD

			
1			
código	700060	referencia	377732 E380010 EL0377732 ELE380010 H0195
descripción	cierre de palanca L 150mm distancia de sujeción 133mm sin cierre aparatos térmicos G 791		
Para modelos:	MD1011, MD523, MD611, MMD1011, MMD611		
accesorios para	700060		
			
código	700061	referencia	382825 382833 E380011 E380012 E598001 EL0382825 ELE380012 ELE598001 H0196 H0197 V0603
descripción	retén L 58mm An 20mm H 35mm distancia de sujeción 42mm latón cromado para aparatos calientes		
			
código	700062	referencia	292532 E407029 EL0292532 ELE407029 K0443
descripción	protección para mango aparatos térmicos		

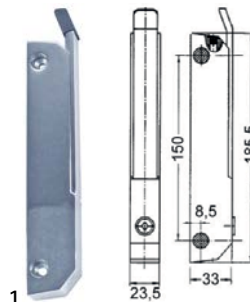
RAHRBACH

serie 6188 ERGO



1			
código	690808	referencia	565458 B0280 E380002 EL0565458
descripción	cierre de palanca L 185mm distancia de sujeción 150mm cromado sin cierre para aparatos calientes 6188 tipo ERGO		
Para modelos:	WU14		
accesorios para	690808		
			
código	690110	referencia	—
descripción	placa de asiento H 1mm L 38mm An 11mm distancia de sujeción 26mm plástico		
			
código	690111	referencia	—
descripción	placa de asiento H 2mm L 38mm An 11mm distancia de sujeción 26mm plástico		
			
código	690114	referencia	—
descripción	placa de asiento H 3.5mm L 185mm An 30mm distancia de sujeción 150mm con posición inclinada rosca M5		
			
código	700082	referencia	—
descripción	retén L 38mm An 18mm distancia de sujeción 26mm		

cierres magnéticos

otros

			
1			
código	701660	referencia	EL0037265 EL0510585
descripción	cierre de válvula L 56mm distancia de sujeción 46mm blanco RALY-6		

retén



código	700061	referencia	382825 382833 E380011 E380012 E598001 EL0382825 ELE380012 ELE598001 H0196 H0197 V0603
descripción	retén L 58mm An 20mm H 35mm distancia de sujeción 42mm latón cromado para aparatos calientes		
Para modelos:	MD1011, MD523, MD611, MMD1011, MMD611		
accesorios para	700061		
	código	690414	referencia —
	cierre de palanca L 150mm distancia de sujeción 133mm sin cierre aparatos de refrigeración G 791		

cierres de cámaras frigoríficas

STUV

serie 3.31.015x.x



código	700071	referencia	030732 E380014 EL0030732 ELE380014 H0200
descripción	cierre de enganche H 58mm L 87mm An 64mm distancia de sujeción 68mm		
Para modelos:	MD2011, MMD2011, MMD2021		



código	700072	referencia	000043 E380015 EL0000043 ELE380015 H0201
descripción	retén H 17mm L 84mm An 53mm distancia de sujeción 68mm cinc presofundido con chaveta aparatos térmicos		
Para modelos:	MD2011, MMD2011, MMD2021		

cierres de enganche

específico del fabricante

ELOMA



código	701303	referencia	380075 587125 593516 E380046 E380072 EL0587125 EL0593516 ELE380046 ELE380072
descripción	cierre de puerta para horno de convección L 140mm An 26mm H 65mm		
Para modelos:	EB30, EB30XLDIGITAL, EDB 6-23		

otros





código	701660	referencia	EL0037265 EL0510585
descripción	cierre de válvula L 56mm distancia de sujeción 46mm blanco RALY-6		

bisagras

bisagras rectangulares

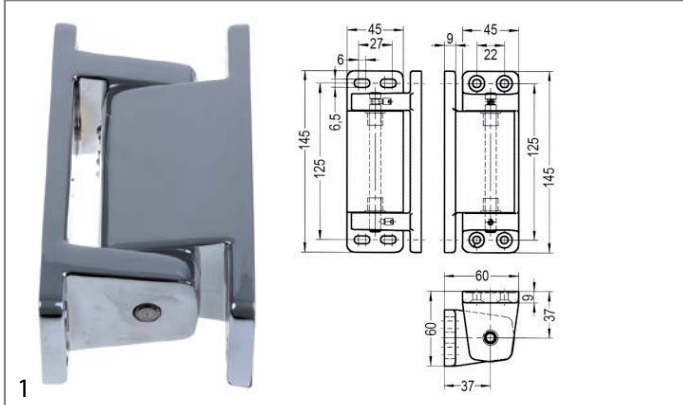
STUV



código	700073	referencia	000051 E382006 EL0000051 ELE382006 H0198
descripción	bisagra rectangular L 145mm An 45mm distancia de sujeción 125mm tope izquierdo/derecho sin rampa punto de rotación 37mm cinc presofundido, cromado aparatos de refrigeración		
Para modelos:	MD2011, MMD2011, MMD2021		
accesorios para	700073		
	código	690310	referencia —
	 placa de asiento para serie 4000/4001 espesor 5mm		

soporte de puerta

código	692689	referencia	EL0502734
descripción	bisagra kit de reparación		

código	692688	referencia	E382017 EL0569178
descripción	bisagra L 78mm An 40mm H 5mm distancia de sujeción 21mm pos. de montaje abajo perno 12mm perno ø 6mm		
Para modelos:	JOKERB, JOKERC		

código	692687	referencia	E382016 EL0565601
descripción	bisagra L 78mm An 40mm H 5mm distancia de sujeción 21mm pos. de montaje arriba perno 12mm perno ø 6mm		
Para modelos:	JOKERB, JOKERC		

accesorios

casquillos

código	692909	referencia	782432 EL0782432
descripción	cojinete para bisagra de puerta batiente H 7mm plástico D1 ø 18mm D2 ø 12mm int.ø 10mm		

código	692910	referencia	E401038 EL0563420 EL0568945
descripción	cojinete para bisagra de puerta batiente L 8mm ø 8mm int.ø 6mm		

otros

código	694994	referencia	0875023 EL0875023
descripción	disco de detención para bisagra int.ø 12mm ø ext. 30mm plástico		

elementos extraíbles

ruedas de rodadura

ruedas de rodadura

accesorios



1

código	560133	referencia	EL0251887
descripción	tuerca hexagonal rosca M6 H 5mm EC 10 inox DIN/ISO DIN 934 / ISO 4032/8673 UE 20 pzs		

pies para aparatos y tapas terminales

tapas terminales y tapones

para tubos cuadrados



1

código	696728	referencia	E407057 EL0568929
descripción	tapón rectangular medida de montaje 31x28mm plástico		
Para modelos:	JOKERB, JOKERC		

DERBY RUOTE

recambios y accesorios

otros



1

código	560193	referencia	0349771 EL0349771
descripción	arandela dentada int.ø 10.4mm ø ext. 18mm acero zincado DIN/ISO DIN 6798A UE 1 pzs para rosca M10		

juntas

juntas térmicas

juntas para ventanas

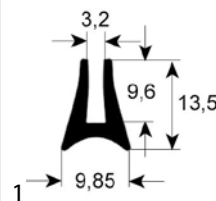

1

código	900110	referencia	215961 425041 E425041 EL0215961 ELE425041 H0515
descripción	junta de ventana perfil 1590 UE al metro		
Para modelos:	EBM5, ELH101, ELH51, ELH61, MD1011, MD2011, MD611, MMC1011, MMC1011G, MMC611, MMD1011, MMD1011G, MMD2011, MMD2021, MMD611		

juntas para puertas

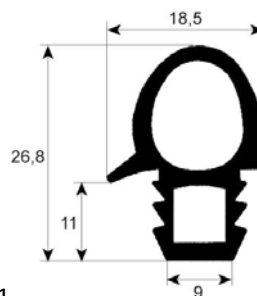

1

código	900100	referencia	384410 425030 E425030 EL0384410 ELE425030 H0497
descripción	junta de puerta perfil 2070 An 460mm L 645mm medidas exteriores UE 1 6 x 1/1		
Para modelos:	EDC6-11, MD611, MMC611, MMD611		

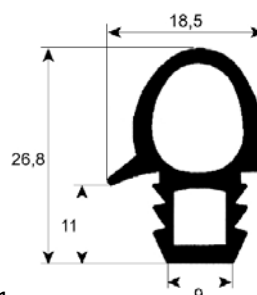

1

código	900101	referencia	382310 E425033 EL0382310 ELE425033 H0502
descripción	junta de puerta perfil 2070 An 645mm L 700mm medidas exteriores UE 1 10 x 1/1		

código	900204	referencia	E425056 ELE425056
descripción	junta de puerta perfil 2448 An 710mm L 1470mm medidas exteriores UE 1		

código	900203	referencia	E425090 ELE425090
descripción	junta de puerta perfil 2448 An 730mm L 980mm medidas exteriores UE 1		

código	900865	referencia	742368 E425198 EL0742368 ELE425198
descripción	junta de puerta perfil 2449 An 490mm L 520mm UE 1		
Para modelos:	611, GENIUS, GENIUS6-11, GENIUS6-11GAS, MAKT, MB, MULTIMAXB6-11AUTOCLEAN		

código	901483	referencia	200021 742384 E425200 EL0742384 ELE425200
descripción	junta de puerta perfil 2449 An 520mm L 1505mm UE 1		
Para modelos:	2011, GENIUS, MAKT, MB		

código	900497	referencia	742376 E425199 EL0742376 ELE425199
descripción	junta de puerta perfil 2449 An 520mm L 775mm UE 1		
Para modelos:	1011, GENIUS, MAKT, MB		

código	901490	referencia	742406 E425202 EL0742406 ELE425202
descripción	junta de puerta perfil 2449 An 690mm L 1550mm UE 1		
Para modelos:	1221, 2021, AUTOCLEAN, GENIUS, MB, MULTIMAXB		

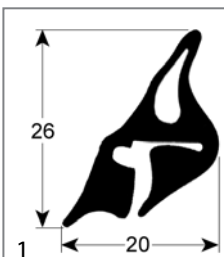

código	900498	referencia	425121 425166 693219 E425166 EL0693219 ELE425166
descripción	junta de puerta perfil 2515 perímetro 1670mm UE 1		
Para modelos:	EBM3e-McDonalds, EDB 6-23, JOKERB, JOKERC		

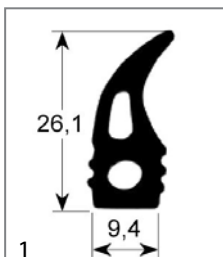

código	900050	referencia	131385 425060 E425031 EL0131385 ELE425031 ELE425060 H0500
descripción	junta de puerta perfil 2710 UE al metro		
Para modelos:	EB30, EB30XLDIGITAL, ELH61, MD1011, MD523, MD611, MMD1011, MMD611, WU14		

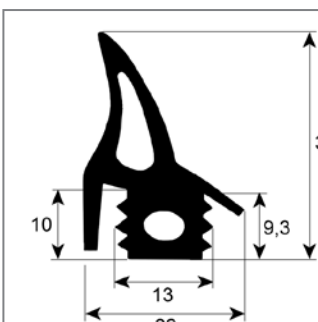

código	901277	referencia	E425207 ELE425207
descripción	junta de puerta perfil 2690 L 2275mm		

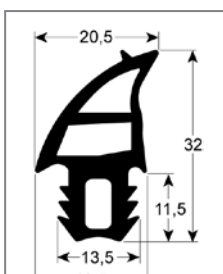

código	902505	referencia	2000214 EL2000214
descripción	junta de puerta perfil 2736 An 510mm L 1487mm medida inserción exterior UE 1 para ELOMA 20-11		

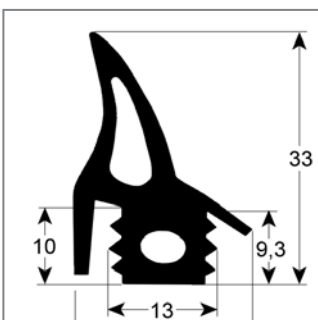

código	901821	referencia	425127 E425208 ELE425208
descripción	junta de puerta perfil 2690 L 2920mm		

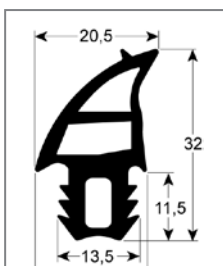

código	902507	referencia	2000212 EL2000212
descripción	junta de puerta perfil 2736 An 510mm L 484mm medida inserción exterior UE 1 para ELOMA 6-11		

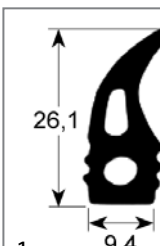

código	902491	referencia	0501645 EL0501645
descripción	junta de puerta perfil 2710 L 1555mm para ELOMA cerrado		

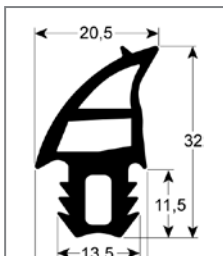

código	902504	referencia	2000213 EL2000213
descripción	junta de puerta perfil 2736 An 510mm L 763mm medida inserción exterior UE 1 para ELOMA 10-11		

código	902506	referencia	2000216 EL2000216
descripción	junta de puerta perfil 2736 An 685mm L 1535mm medida inserción exterior UE 1 para ELOMA 20-21		

código	902492	referencia	2000215 742392 E425201 EL0742392 EL2000215 ELE425201
descripción	junta de puerta perfil 2736 An 695mm L 1000mm medida inserción exterior UE 1 para ELOMA 12-21 silicona		
Para modelos:	1221, 2021, AUTOCLEAN, GENIUS, MB, MULTIMAXB		

código	901298	referencia	693200 E425113 EL0693200 ELE425113
descripción	junta de puerta perfil 2775 UE al metro		
Para modelos:	JOKERB, JOKERC		

juntas para bandejeros

código	900199	referencia	549207 E425062 EL0549207 ELE425062
descripción	junta para carro porta bandejas perfil 4070 L 1000mm UE 1		
Para modelos:	1011, 1221, 2021, 611, GENIUS, MAKT, MB		

juntas para paneles de control

código	902493	referencia	0742309 E425194 EL0742309 ELE425194
descripción	junta para panel de manejo An 220mm L 890mm para ELOMA para horno a vapor combinado con 8 ganchos de sujeción		

código	902556	referencia	EL0742295 ELE425193
descripción	junta para panel de manejo An 225mm L 635mm para ELOMA para horno a vapor combinado con 6 ganchos de sujeción		

juntas tóricas

EPDM

código	504574	referencia	013471 E425026 EL0013471 ELE425026 H0403
descripción	junta tórica EPDM espesor 1.78mm int.ø 9.25mm UE 1 pzs		
Para modelos:	1011, 1221, 2011, 2021, 611, AUTOCLEAN, GENIUS, GENIUS6-11, GENIUS6-11GAS, GENIUSGAS, MD1011, MD2011, MD523, MD611, MMD1011, MMD2011, MMD611, MULTIMAXA, MULTIMAXB		

silicona

código	532726	referencia	577642 E425153 EL0577642 ELE425153
descripción	junta tórica silicona espesor 1.5mm int.ø 17mm UE 10 pzs		
Para modelos:	JOKERB, JOKERC		

Viton

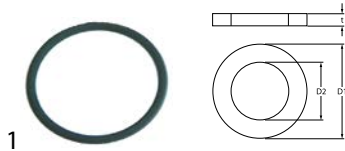

código	510579	referencia	581410 E425066 EL0581410 ELE425066
descripción	junta tórica Viton espesor 2.62mm int.ø 34.6mm UE 1 pzs		
Para modelos:	1011, 1221, 2011, 2021, 611, AUTOCLEAN, GENIUS, GENIUS6-11, GENIUS6-11GAS, GENIUSGAS, MAKT, MB, MULTIMAXA, MULTIMAXB		



código	529357	referencia	753742 E425183 EL0753742 ELE425183
descripción	junta tórica Viton espesor 3.53mm int.ø 23.4mm UE 1 pzs		
Para modelos:	1011, 1221, 2011, 2021, 611, AUTOCLEAN, GENIUS, GENIUS6-11, GENIUS6-11GAS, GENIUSGAS, MB, MULTIMAXB		

NBR



código	532735	referencia	0503932 425185 E425185 EL0503932 ELE425185
descripción	junta tórica NBR 70 espesor 1mm int.ø 6mm		
Para modelos:	JOKERB		

anillos de junta

juntas de cobre

DIN-7603-A



código	528433	referencia	097071 217840 E427020 E427039 EL0097071 EL0217840 EL0571849 ELE427020 ELE427039 R0300
descripción	junta plana cobre ø ext. 14mm int.ø 10mm espesor 1mm		
Para modelos:	1011, 1221, 2011, 2021, 611, AUTOCLEAN, GENIUS, GENIUS6-11, GENIUS6-11GAS, GENIUSGAS, MAKT, MB, MD1011, MD523, MD611, MMD611, MULTIMAXA, MULTIMAXB, WU14		

juntas de PTFE



código	518669	referencia	0373079 EL0373079
descripción	junta PTFE ø ext. 21mm int.ø 15mm espesor 3.5mm		
accesorios para	518669		
	código	375889	referencia 504602 E336029 EL0504602 ELE336029
termostato de seguridad temp. desconexión 360°C 1 polos 16A sonda ø 15mm sonda L 6.5mm capilar 1140mm aislamiento del capilar 1100mm prensaestopas bulbo			

juntas de silicona



código	359721	referencia	425132 693421 976024 E0556 E425005 E425132 EL0976024 ELE425005 ELE425132
descripción	junta silicona ø ext. 48mm int.ø 39.5mm espesor 5mm UE 1 pzs		
Para modelos:	EBM3e-McDonalds, JOKERB, JOKERC		



juntas especiales

para hornos a vapor combinado



1

código	699835	referencia	E425011 EL0307025
descripción	junta altura exterior 18mm ø ext. 65mm int.ø 56mm		



1

código	699472	referencia	0507495 0507997 0874833 EL0507495 EL0507997 EL0874833
descripción	junta electrodo de encendido int.ø 13mm agujero ø 6mm L 60mm An 22mm apto para ELOMA grafito		

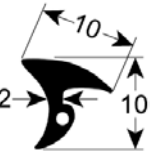

1

código	560648	referencia	0584096 E425133 EL0584096 ELE425133
descripción	junta para ELOMA L 1000mm UE 1m para horno a vapor combinado		
Para modelos:	JOKERB, JOKERC		



1

código	699469	referencia	0505953 874868 EL0505953 EL0874868
descripción	junta para ELOMA para modelo Genius T 6-11 10-11 L 64mm An 64mm para horno a vapor combinado int.ø 50mm grafito espesor 1.7mm		
Para modelos:	1011, 1221, 2011, 2021, 611, GENIUS		



1

código	699471	referencia	0507494 0874876 EL0507494 EL0874876
descripción	junta para ELOMA para modelo Genius T 6-11 10-11 para cámara quemador L 108mm An 100mm grafito horno a vapor combinado		



1

código	699470	referencia	0505956 874841 EL0505956 EL0874841
descripción	junta para ELOMA para modelo Genius T 6-11 10-11 para ventilador radial L 65mm An 82mm para horno a vapor combinado int.ø 25mm grafito espesor 1.7mm		
Para modelos:	1011, 1221, 2011, 2021, 611, GENIUS		

juntas de termostato



1

código	518669	referencia	0373079 EL0373079	
descripción	junta PTFE ø ext. 21mm int.ø 15mm espesor 3.5mm			
accesorios para	518669			
	código	375889	referencia	504602 E336029 EL0504602 ELE336029
	termostato de seguridad temp. desconexión 360°C 1 polos 16A sonda ø 15mm sonda L 6.5mm capilar 1140mm aislamiento del capilar 1100mm prensaestopas bulbo			

técnica de accionamiento y rodamientos de bolas

cadenas

elementos de unión



1

código	697069	referencia	395021 E395021 ELE395021
descripción	elemento de empalme simple DIN/ISO 06 B-1 división 3/8" eslabones 1 L 17.8mm anchura interior 8.8mm rodilloø 3mm metal		

muelles

muelles de torsión



código	692523	referencia	897531 E416055 E416073 EL0897531 ELE416055 ELE416073
descripción	resorte de torsión ø 27.8mm int.ø 21.7mm L2 44mm espesor de hilo 3mm L1 13mm L3 44mm UE 1 pzs		
Para modelos:	1221, 2021, AUTOCLEAN, GENIUS, MB, MULTIMAXB		

imagen no disponible

código	692911	referencia	EL0791520
descripción	resorte de torsión ø 27mm espesor de hilo 2.3mm pos. de montaje tirador de puerta L1 11mm UE 1 pzs		

imagen no disponible

código	692908	referencia	E416030 ELE416030
descripción	resorte de torsión tope a la derecha ø 35mm L2 13mm espesor de hilo 2.5mm pos. de montaje para tirador de puerta L1 13mm L3 13mm UE 1 pzs		
Para modelos:	EDC 20/11		

otros



código	514450	referencia	791504 EL0791504
descripción	resorte para tirador de puerta ø 6mm L 61mm An 27.5mm		

resortes de tracción



código	700030	referencia	416002 527343 EL0527343 ELE416002 G0195
descripción	muelle de tracción ø 12.9mm longitud total 187mm espesor de hilo 2.1mm		



código	700031	referencia	514586 EL0514586 G0197
descripción	muelle de tracción ø 15mm longitud total 290mm espesor de hilo 2.3mm		



código	700032	referencia	G0199
descripción	muelle de tracción ø 24.8mm longitud total 220mm espesor de hilo 3.2mm		



código	700033	referencia	G0201
descripción	muelle de tracción ø 30mm longitud total 300mm espesor de hilo 4.1mm		

manómetros



código	541979	referencia	224758 E348009 EL0224758 ELE348009 H0376
descripción	manómetro ø 40mm margen de presión 0-4bar empalme atrás en el centro rosca 1/8"		
Para modelos:	1011, 1221, 2011, 2021, 611, AUTOCLEAN, GENIUS, GENIUS6-11, GENIUS6-11GAS, GENIUSGAS, MAKT, MB, MULTIMAXA, MULTIMAXB		





			
1			
código	542449	referencia	224758
descripción	manómetro ø 40mm margen de presión 0-6bar empalme atrás en el centro rosca 1/8"		

enrolladores de tubo y duchas de mano para lavado

duchas de mano para lavado

			
1			
código	548636	referencia	EL0393002
descripción	ducha de mano 1/2" M L 250mm		
repuestos para	548636		
	código	540457	referencia —
	varilla de presión ø 10mm D1 ø 18mm L 48.7mm con muelle para ducha de mano de aparato edición ab 03/2016		
	código	549970	referencia —
	varilla de presión ø 10mm D1 ø 18mm L 50.2mm con muelle para ducha de mano de aparato		

			
1			
código	540301	referencia	587583 E250059 EL0587583 EL0783404 ELE250059
descripción	ducha de mano de aparato 1/2" M L 128mm		
Para modelos:	1011, 1221, 2011, 2021, 611, AUTOCLEAN, GENIUS, GENIUS6-11, GENIUS6-11GAS, GENIUSGAS, JOKERB, JOKERC, MAKT, MB, MULTIMAXA, MULTIMAXB, MULTIMAXB6-11AUTOCLEAN		
accesorios para	540301		
	código	530922	referencia EL0504696 ELE444057
	tubo de ducha empalmes 1/2" L 800mm inox para horno a vapor combinado		

			
1			
código	540158	referencia	393002 A0460 E250004 EL0393002 ELE250004
descripción	ducha de mano de aparato 1/2" M tipo ECHTERMANN		

			
1			
código	530922	referencia	EL0504696 ELE444057
descripción	tubo de ducha empalmes 1/2" L 800mm inox para horno a vapor combinado		
accesorios para	530922		
	código	540301	referencia 587583 E250059 EL0587583 EL0783404 ELE250059
	ducha de mano de aparato 1/2" M L 128mm		

enrolladores de tubo

enrolladores de mangueras para aparatos

			
1			
código	545067	referencia	753181 E250103 EL0753181 ELE250103
descripción	enrollador de mangueras sin ducha de mano longitud de tubo 1.55m		
Para modelos:	1011, 611, AUTOCLEAN, GENIUS, GENIUS6-11, GENIUS6-11GAS, GENIUSGAS, MAKT, MB, MULTIMAXA, MULTIMAXB, MULTIMAXB6-11AUTOCLEAN		



1

código	540480	referencia	580953 E250069 EL0580953 ELE250069
descripción	enrollador de mangueras sin ducha de mano longitud de tubo 1.7m		



1

código	540481	referencia	E250070 ELE250070
descripción	enrollador de mangueras sin ducha de mano longitud de tubo 2.1m		
accesorios para	540481		
	código	540301	referencia
			587583 E250059 EL0587583 EL0783404 ELE250059
	ducha de mano de aparato 1/2" M L 128mm		

tubos flexibles

tubos flexibles de ducha

tubos espiral en acero inoxidable



1 imagen no disponible

código	530922	referencia	EL0504696 ELE444057
descripción	tubo de ducha empalmes 1/2" L 800mm inox para horno a vapor combinado		
accesorios para	530922		
	código	540301	referencia
			587583 E250059 EL0587583 EL0783404 ELE250059
	ducha de mano de aparato 1/2" M L 128mm		

tubos flexibles industriales

tubos de nylon



1

código	520252	referencia	785857 EL0785857
descripción	tubo de nylon int.ø 6mm ø ext. 8mm L 5m grosor de la pared 1mm p de trabajo 10bar p de reventamiento 50bar T máx 100°C blanco		
Para modelos:	1011, 1221, 2011, 2021, 611, GENIUS, MAKT, MB		

tubos de silicona

con tejido

con recubrimiento de fibra de vidrio trenzada



1

código	520023	referencia	375500 E444014 EL0375500 ELE444014 K0435
descripción	tubo de silicona con recubierta de fibra de vidrio int.ø 6mm ø ext. 12mm L 5m grosor de la pared 3mm p de trabajo 4bar presión de reventam. a 95°C 26bar presión de reventam. a 130°C 14bar T máx 200°C blanco resis.a la temp. máx. 200°C		
Para modelos:	MD1011, MD2011, MD523, MD611, MMD1011, MMD2011, MMD2021, MMD611		



1

código	520024	referencia	253847 593303 E444013 E444050 EL0253847 EL0593303 ELE444013 ELE444050 K0432
descripción	tubo de silicona con recubierta de fibra de vidrio int.ø 9.5mm ø ext. 17mm L 5m grosor de la pared 3.75mm p de trabajo 4bar presión de reventam. a 95°C 26bar presión de reventam. a 130°C 14bar T máx 200°C blanco		
Para modelos:	1011, 1221, 2011, 2021, 611, AUTOCLEAN, GENIUS, GENIUS6-11, GENIUS6-11GAS, GENIUSGAS, MAKT, MB, MD1011, MD2011, MD523, MD611, MMD1011, MMD2011, MMD2021, MMD611, MULTIMAXA, MULTIMAXB, WU14		



guarniciones, empalmes para mangueras y tubos

empalmes de tubos

otros



1

código	501591	referencia	0753890 E440154 EL0753890 ELE440154
descripción	empalme de tubos acero inoxidable tubo ø 10/13mm M9 para sistema de limpieza horno a vapor combinado		

guarniciones

boquillas dobles



1

código	520160	referencia	440092 754447 E440156 EL0440092 EL0754447 ELE440156
descripción	boquilla doble latón niquelado rosca 1/8" - 1/8" UE 1 pzs		
Para modelos:	1011, 1221, 2011, 2021, 611, AUTOCLEAN, EB30, EB30XLDIGITAL, EBMS, EDC6-11, ELH101, ELH61, GENIUS, GENIUS6-11, GENIUS6-11GAS, GENIUSGAS, MAKT, MB, MD1011, MD2011, MD523, MD611, MMC1011, MMC2011, MMC2021, MMC611, MMD1011, MMD2011, MMD2021, MMD611, MULTIMAXA, MULTIMAXB		



1

código	521187	referencia	570451 E440047 EL0570451 ELE440047 H0654
descripción	boquilla doble latón niquelado rosca 1/8" - 3/8" UE 1 pzs ø int. 1 5mm ø int. 2 9.3mm		
Para modelos:	EB30, EB30XLDIGITAL, MD1011, MD2011, MD523, MD611, MMD1011, MMD2011, MMD2021, MMD611		

reducciones



1

código	520963	referencia	E440039 EL0249696 ELE440039
descripción	reducción rosca 3/4" M - 3/8" H latón niquelado longitud total 26.5mm EC 27 UE 1 pzs		
Para modelos:	1011, 1221, 2011, 2021, 611, AUTOCLEAN, GENIUS, GENIUS6-11, GENIUS6-11GAS, GENIUSGAS, JOKERB, JOKERC, MULTIMAXA, MULTIMAXB		

piezas angulares



1

código	520824	referencia	773719 E440172
descripción	pieza angular rosca 1/8" M - 1/8" H latón niquelado		
Para modelos:	1011, 1221, 2011, 2021, 611, AUTOCLEAN, EB30, EB30XLDIGITAL, GENIUS, GENIUS6-11, GENIUS6-11GAS, GENIUSGAS, MB, MULTIMAXA, MULTIMAXB		

componentes para el circuito agua



reductores de presión

reductores de presión

específico del fabricante



1

código	520502	referencia	577316 871419 E0731 E436009 E598198 EL0871419 ELE436009 ELE598198	
descripción	reductor de presión Norgren serie R91 empalme 1/8" preajustear margen de ajuste 0,1-3bar p máx. 10bar T máx 50°C latón			
Para modelos:	1011, 1221, 2011, 2021, 611, AUTOCLEAN, GENIUS, GENIUS6-11, GENIUS6-11GAS, GENIUSGAS, JOKERB, JOKERC, MAKT, MB, MULTIMAXA, MULTIMAXB			
accesorios para	520502			
	código	541979	referencia	224758 E348009 EL0224758 ELE348009 H0376
	manómetro ø 40mm margen de presión 0-4bar empalme atrás en el centro rosca 1/8"			
	código	542449	referencia	224758
	manómetro ø 40mm margen de presión 0-6bar empalme atrás en el centro rosca 1/8"			

silicona

siliconas para uso alimentario



1

código	890106	referencia	E522026 EL0063096 ELE522026
descripción	silicona TB40 transparente tubo 90g -40 a +160°C		
descripción	Tomabond - TB40 - tubo 90g - transparente Para juntas flexibles en los sectores de agua potable/alimentos/agua/cocinas industriales. Pega firmemente vidrio, metal, productos de madera, cerámica, plásticos con enorme fuerza adhesiva (1,1 N/mm ²). Exento de fungicidas, alguicidas y solventes, resistente al envejecimiento. Resiste temperaturas desde - 40°C a +160°C Verificado y aprobado por KTW/KSW.		

abrazaderas

abrazaderas de tubo

DIN 3017 - W2



1

código	520116	referencia	422007 EL0422007
descripción	abrazadera de tubo ø 32-50mm ancho 9mm UE 5 pzs DIN 3017		
Para modelos:	MMC1011, MMC611, MMD1011, MMD611		

abrazaderas de seguridad

inox/latón



1

código	520069	referencia	276634 E422018 EL0276634 ELE422018 H0284
descripción	abrazadera de tubo inox / latón ø 14-19mm ancho 11mm UE 5 pzs		
Para modelos:	1011, 1221, 2011, 2021, 611, AUTOCLEAN, EB30, EB30XLDIGITAL, GENIUS, GENIUS6-11, GENIUS6-11GAS, GENIUSGAS, MAKT, MB, MD1011, MD2011, MD523, MD611, MMD1011, MMD2011, MMD2021, MMD611, MULTIMAXA, MULTIMAXB		

material auxiliar

juntas para roscas



1

código	890058	referencia	593567
descripción	junta para rosca LOCTITE 511 líquido botella 50ml		
descripción	LOCTITE® 511™ - botella 50ml Está diseñado para fijar y sellar tuberías y conexiones metálicas roscadas. El producto cura rápidamente en ausencia de aire, entre superficies metálicas ajustadas.		
Para modelos:	1011, 1221, 2011, 2021, 611, EB30, EB30XLDIGITAL, GENIUS, MAKT, MB		



			
1			
código	520070	referencia	276642 E422019 EL0276642 ELE422019 H0285
descripción	abrazadera de tubo inox / latón ø 16-21mm ancho 11mm UE 5 pzs		
Para modelos:	1011, 611, GENIUS, MAKT, MB		

			
1			
código	520071	referencia	572160 E422020 EL0572160 ELE422020 H0286
descripción	abrazadera de tubo inox / latón ø 17-22mm ancho 11mm UE 5 pzs		
Para modelos:	1011, 1221, 2011, 2021, 611, AUTOCLEAN, GENIUS, GENIUS6-11, GENIUS6-11GAS, GENIUSGAS, MB, MULTIMAXA, MULTIMAXB, WU14		

			
1			
código	520067	referencia	277665 E422017 EL0277665 ELE422017 H0282
descripción	abrazadera de tubo inox / latón ø 9-14mm ancho 10mm UE 5 pzs		
Para modelos:	1011, 1221, 2011, 2021, 611, AUTOCLEAN, EB30, EB30XLDIGITAL, GENIUS, GENIUS6-11, GENIUS6-11GAS, GENIUSGAS, MD1011, MD2011, MD523, MD611, MMD1011, MMD2011, MMD2021, MMD611, MULTIMAXA, MULTIMAXB, WU14		

material de sujeción

tornillos

tornillos de chapa

			
1			
código	560104	referencia	EL0011800
descripción	tornillos de chapa ø 3.9mm L 19mm inox UE 20 pzs DIN 7981/ISO 7049 ø cabezal 7.5mm cabeza gota de sebo		

tornillos de cabeza avellanada

			
1			
código	560450	referencia	ELE500172
descripción	tornillo de cabeza avellanada rosca M4 L 8mm inox DIN 965/ISO 7046 UE 1 pzs soporte Phillips ø cabezal 7.3mm		

tornillos de cabeza plana

			
1			
código	102600	referencia	ELE500102
descripción	tornillo rosca M4 rosca L 25mm Minisit		

			
1 imagen no disponible			
código	560491	referencia	162469 E500096 EL0162469 ELE500096 N0206
descripción	tornillo de cabeza plana rosca M3 rosca L 16mm acero inoxidable DIN 7985 UE 20 pzs soporte Phillips ø cabezal 6mm espesor cabezal 2.5mm		

			
1			
código	560063	referencia	EL0037311
descripción	tornillo de cabeza plana rosca M4 rosca L 16mm inox DIN 7985/ISO 7045 UE 20 pzs soporte Phillips ø cabezal 8mm espesor cabezal 2mm		

tuercas hexagonales

			
1			
código	560084	referencia	231657 E500021 EL0231657 ELE500021 N0052
descripción	tornillo de cabeza hexagonal rosca M5 rosca L 16mm inox EC 8 UE 20 pzs DIN 933 / ISO 4017		
Para modelos:	1011, 1221, 2021, 611, GENIUS, MAKT, MB, MD1011, MD523, MD611, MMD1011, MMD611		

			
1			
código	560086	referencia	251836
descripción	tornillo de cabeza hexagonal rosca M6 rosca L 10mm inox EC 10 UE 20 pzs DIN 933 / ISO 4017		
Para modelos:	EB30, EB30XLDIGITAL		

tornillos de cabeza cilíndrica

DIN 912/ISO 4762

			
1			
código	560025	referencia	500070 E500070 ELE500070
descripción	tornillo de cabeza cilíndrica rosca M4 rosca L 10mm EC 3 inox UE 20 pzs DIN 912/ISO 4762		

tornillos prisioneros

DIN 913/ISO 4026

			
1			
código	560497	referencia	753785 E500268 EL0753785 ELE500268
descripción	tornillo prisionero rosca M8 L 8mm A2-A2L DIN 913/ISO 4026 EC 4 UE 20 pzs		
Para modelos:	1011, 1221, 2011, 2021, 611, AUTOCLEAN, GENIUS, GENIUS6-11, GENIUS6-11GAS, GENIUSGAS, MB, MULTIMAXB		

DIN 916/ISO 4029

			
1			
código	560173	referencia	588512 895415 E500203 E500261 EL0588512 EL0895415 ELE500203 N0044
descripción	tornillo prisionero rosca M4 L 10mm inox DIN 916/ISO 4029 soporte Allen hexagonal EC 2 UE 20 pzs		
Para modelos:	1011, 1221, 2011, 2021, 611, AUTOCLEAN, GENIUS, GENIUS6-11, GENIUS6-11GAS, GENIUSGAS, JOKERB, JOKERC, MAKT, MB, MD2011, MMD2011, MMD2021, MULTIMAXA, MULTIMAXB		

otros

			
1			
código	560621	referencia	399280 E440101 EL0399280 ELE440101
descripción	tornillo prisionero rosca 1/8" L 5mm latón EC hexagonal 5mm UE 1 pzs		
Para modelos:	1011, 1221, 2011, 2021, 611, AUTOCLEAN, GENIUS, GENIUS6-11, GENIUS6-11GAS, GENIUSGAS, JOKERB, JOKERC, MAKT, MB, MULTIMAXA, MULTIMAXB		

tuercas

tuercas de chapa

			
1			
código	560004	referencia	E505046 ELE505046 H0630
descripción	tuerca de chapa agujero ø 2.9mm L 17mm An 12mm		
Para modelos:	MD1011, MD2011, MD523, MD611, MMD1011, MMD2011, MMD2021, MMD611		

tuercas hexagonales

DIN 934 / ISO 4032/8673

			
1			
código	506166	referencia	E505027 EL0012343
descripción	tuerca rosca M12 H 10mm EC 19 inox DIN/ISO DIN 934 / ISO 4032/8673 UE 1 pzs		

			
1			
código	560340	referencia	003905
descripción	tuerca hexagonal rosca M4 H 3.2mm EC 7 inox DIN/ISO DIN 934 / ISO 4032/8673 UE 1 pzs		
Para modelos:	1011, 1221, 2011, 2021, 611, EB30, EB30XLDIGITAL, GENIUS, MAKT, MB		





 <p>1</p>			
código	560132	referencia	EL0252867
descripción	tuerca hexagonal rosca M5 H 4mm EC 8 inox DIN/ISO DIN 934 / ISO 4032/8673 UE 20 pzs		

 <p>1</p>			
código	560133	referencia	EL0251887
descripción	tuerca hexagonal rosca M6 H 5mm EC 10 inox DIN/ISO DIN 934 / ISO 4032/8673 UE 20 pzs		

DIN 985			
 <p>1</p>			
código	560143	referencia	0587095 EL587095
descripción	tuerca hexagonal rosca M8 H 8.5mm inox EC 13 UE 20 pzs DIN/ISO DIN 985 autobloqueo		

tuercas hexagonales métricas (sin norma)			
 <p>imagen no disponible</p> <p>1</p>			
código	519646	referencia	E505106 EL0765651 ELE505106
descripción	tuerca rosca M9x0,75 H 2.5mm EC 14 inox UE 1 pzs		

arandelas			
arandelas			
DIN 125A			
 <p>1</p>			
código	560332	referencia	EL001007
descripción	arandela int.ø 4.3mm ø ext. 9mm espesor 0.8mm inox UE 1 pzs		

 <p>1</p>			
código	560112	referencia	EL0003980
descripción	arandela int.ø 5.3mm ø ext. 10mm espesor 1mm inox UE 20 pzs DIN 125A para rosca M5		

DIN 9021			
 <p>1</p>			
código	560117	referencia	000582 E508033 EL0000582
descripción	arandela int.ø 6.4mm ø ext. 18mm espesor 1.5mm inox UE 20 pzs DIN 9021 para rosca M6		
Para modelos:	1011, 1221, 2011, 2021, 611, AUTOCLEAN, EB30, EB30XLDIGITAL, GENIUS, GENIUS6-11, GENIUS6-11GAS, GENIUSGAS, JOKERB, JOKERC, MAKT, MB, MULTIMAXA, MULTIMAXB, MULTIMAXB6-11AUTOCLEAN		

arandelas dentadas			
DIN 6798A			
 <p>1</p>			
código	560193	referencia	0349771 EL0349771
descripción	arandela dentada int.ø 10.4mm ø ext. 18mm acero zincado DIN/ISO DIN 6798A UE 1 pzs para rosca M10		

 <p>1</p>			
código	560127	referencia	892912
descripción	arandela dentada int.ø 6.2mm ø ext. 11mm inox DIN/ISO DIN 6798A UE 20 pzs para rosca M6		
Para modelos:	1011, 1221, 2011, 2021, 611, EB30, EB30XLDIGITAL, GENIUS, MAKT, MB		

sujeciones			
tuercas de ranura			
 <p>1</p>			
código	694995	referencia	0760978 EL0760978 ELE512082
descripción	tuerca de ranura An 4mm H 5mm L 12mm semirredondo para cierre de puerta DIN 6888		
Para modelos:	1221, 2021, GENIUS, MB		

abrazaderas

abrazaderas de tubo

DIN 3017 - W2



1

código	520116	referencia	422007 EL0422007
descripción	abrazadera de tubo ø 32-50mm ancho 9mm UE 5 pzs DIN 3017		
Para modelos:	MMC1011, MMC611, MMD1011, MMD611		

abrazaderas de seguridad

inox/latón



1

código	520069	referencia	276634 E422018 EL0276634 ELE422018 H0284
descripción	abrazadera de tubo inox / latón ø 14-19mm ancho 11mm UE 5 pzs		
Para modelos:	1011, 1221, 2011, 2021, 611, AUTOCLEAN, EB30, EB30XLDIGITAL, GENIUS, GENIUS6-11, GENIUS6-11GAS, GENIUSGAS, MAKT, MB, MD1011, MD2011, MD523, MD611, MMD1011, MMD2011, MMD2021, MMD611, MULTIMAXA, MULTIMAXB		



1

código	520070	referencia	276642 E422019 EL0276642 ELE422019 H0285
descripción	abrazadera de tubo inox / latón ø 16-21mm ancho 11mm UE 5 pzs		
Para modelos:	1011, 611, GENIUS, MAKT, MB		



1

código	520071	referencia	572160 E422020 EL0572160 ELE422020 H0286
descripción	abrazadera de tubo inox / latón ø 17-22mm ancho 11mm UE 5 pzs		
Para modelos:	1011, 1221, 2011, 2021, 611, AUTOCLEAN, GENIUS, GENIUS6-11, GENIUS6-11GAS, GENIUSGAS, MB, MULTIMAXA, MULTIMAXB, WU14		



1

código	520067	referencia	277665 E422017 EL0277665 ELE422017 H0282
descripción	abrazadera de tubo inox / latón ø 9-14mm ancho 10mm UE 5 pzs		
Para modelos:	1011, 1221, 2011, 2021, 611, AUTOCLEAN, EB30, EB30XLDIGITAL, GENIUS, GENIUS6-11, GENIUS6-11GAS, GENIUSGAS, MD1011, MD2011, MD523, MD611, MMD1011, MMD2011, MMD2021, MMD611, MULTIMAXA, MULTIMAXB, WU14		

pasadores elásticos



1

código	692474	referencia	ELE512046
descripción	pasador elástico ø 2.5mm L 20mm		



1

código	691637	referencia	512046 E512046
descripción	pasador elástico ø 3mm L 20mm		



consumibles

sellantes y pegamentos

silicona de alta temperatura

			
1			
código	890107	referencia	500402 E522021 EL0500402 ELE522021 H0635
descripción	silicone de alta temperatura TOMABOND TB76 -40 a +250°C rojo/marrón tubo 90ml		
descripción	Tomabond TB76 - tubo 90ml - pardo rojo Silicona elástica especial para uso general como adhesivo y sellante con altas sollicitaciones térmicas. TB 76 se utiliza principalmente en instalaciones domiciliarias, climatización, ventilación y construcción de máquinas. Resiste a corto plazo temperaturas de 300°C		
Para modelos:	1221, 2021, GENIUS, MB, MD2011, MMD2011, MMD2021		

siliconas para uso alimentario

			
1			
código	890106	referencia	E522026 EL0063096 ELE522026
descripción	silicona TB40 transparente tubo 90g -40 a +160°C		
descripción	Tomabond - TB40 - tubo 90g - transparente Para juntas flexibles en los sectores de agua potable/alimentos/agua/cocinas industriales. Pega firmemente vidrio, metal, productos de madera, cerámica, plásticos con enorme fuerza adhesiva (1,1 N/mm ²). Exento de fungicidas, alguicidas y solventes, resistente al envejecimiento. Resiste temperaturas desde - 40°C a +160°C Verificado y aprobado por KTW/KSW.		

juntas para roscas

			
1			
código	890058	referencia	593567
descripción	junta para rosca LOCTITE 511 líquido botella 50ml		
descripción	LOCTITE® 511™ - botella 50ml Está diseñado para fijar y sellar tuberías y conexiones metálicas roscadas. El producto cura rápidamente en ausencia de aire, entre superficies metálicas ajustadas.		
Para modelos:	1011, 1221, 2011, 2021, 611, EB30, EB30XLDIGITAL, GENIUS, MAKT, MB		

fusibles

fusibles finos

			
1			
código	358532	referencia	190756 E0173 E375007 EL0190756 ELE375007
descripción	fusible fino medida ø5x20mm 2A rápido nominal 250V UE 10 pzs		
Para modelos:	1011, 1221, 2011, 2021, 611, AUTOCLEAN, GENIUS, GENIUS6-11, GENIUS6-11GAS, GENIUSGAS, JOKERC, MAKT, MB, MD1011, MD2011, MD611, MMD1011, MMD2011, MMD2021, MMD611, MULTIMAXA, MULTIMAXB		

			
1			
código	358699	referencia	572047 E0168 E375004 EL0572047 ELE375004
descripción	fusible fino medida ø5x20mm 10A semi retardado nominal 250V UE 10 pzs		
Para modelos:	JOKERC, MD2011, MMD1011, MMD2011, MMD2021, MMD611, WU14		

			
1			
código	358697	referencia	E0167 E375003 ELE375003
descripción	fusible fino medida ø5x20mm 6.3A semi retardado nominal 250V UE 10 pzs		



1

código	358608	referencia	578975 EL0578975
descripción	fusible fino medida ø5x20mm 10A retardado nominal 250V UE 10 pzs		
Para modelos:	1011, 1221, 2011, 2021, 611, GENIUS, MAKT, MB		

portafusibles



1

código	358049	referencia	751847 E0965 E373028 EL0751847 ELE373028
descripción	portafusibles		
Para modelos:	1221, 2011, 2021, AUTOCLEAN, GENIUS, MAKT, MB, MD2011, MMD2011, MMD2021, MULTIMAXA, MULTIMAXB		

fusibles de rosca

sistema D0 (NEOZED)



1

código	358043	referencia	658294 E0974 E375015 EL0658294 ELE375015
descripción	fusible medida D01 16A nominal 250/400V E14 ø 11mm L 36mm UE 10 pzs		
Para modelos:	1221, 2021, AUTOCLEAN, GENIUS, MB, MD2011, MMD2011, MMD2021, MULTIMAXB		



1

código	358045	referencia	751863 E0970 E375013 EL0751863 ELE375013
descripción	fusible medida D02 35A nominal 250/400V E18 ø 15mm L 36mm UE 10 pzs		
Para modelos:	2011, AUTOCLEAN, GENIUS, MAKT, MB, MD2011, MMD2011, MMD2021, MULTIMAXA, MULTIMAXB		



1

código	358046	referencia	658286 E0969 E375012 EL0658286 ELE375012
descripción	fusible medida D02 50A nominal 250/400V E18 ø 15mm L 36mm UE 10 pzs		
Para modelos:	1221, 2021, AUTOCLEAN, GENIUS, MB, MD2011, MMD2011, MMD2021, MULTIMAXB		

suplementos de ajuste (NEOZED)



1

código	358064	referencia	658308 E0976 E373023 EL0658308
descripción	suplemento de ajuste medida D02 apto para 16A		
Para modelos:	1221, 2021, AUTOCLEAN, GENIUS, MB, MD2011, MMD2011, MMD2021, MULTIMAXB		



1

código	358067	referencia	751855 E0972 E373021 EL0751855 ELE373021
descripción	suplemento de ajuste medida D02 apto para 35A		
Para modelos:	2011, AUTOCLEAN, GENIUS, MAKT, MB, MD2011, MMD2011, MMD2021, MULTIMAXA, MULTIMAXB		



1

código	358068	referencia	658278 E0971 E373020 ELE373020
descripción	suplemento de ajuste medida D02 apto para 50A		
Para modelos:	1221, 2021, AUTOCLEAN, GENIUS, MB, MD2011, MMD2011, MMD2021, MULTIMAXB		

A			
abrazaderas	58, 62		
abrazaderas de seguridad	58, 62		
abrazaderas de tubo	58, 62		
accesorios eléctricos	36		
anillos de junta	52		
aparatos de mando y aviso	15		
arandelas	61		
arandelas dentadas	61		
B			
bisagras rectangulares	47		
bombas	34		
bombas de vibración	34		
bombillas incandescentes	18		
boquillas de gas	38		
boquillas dobles	57		
C			
centralitas de gas automáticas	37		
cierre electromagnético	43		
cierres angulares	45		
cierres de cámaras frigoríficas	46		
cierres de enganche	46		
cierres de palanca	45		
cierres de palanca pivotante	43		
cierres magnéticos	45		
componentes para el circuito agua	58		
condensadores de servicio	34		
condensadores y filtros antiparasitarios	34		
conmutadores de levas	13		
consumibles	63		
contactores	22		
controladores electrónicos	25		
D			
duchas de mano con rosca macho	55		
duchas de mano para lavado	55		
E			
empalmes de tubos	57		
enrolladores de mangueras para aparatos	55		
enrolladores de tubo	55		
F			
fusibles	34, 63		
fusibles de rosca	64		
fusibles finos	63		
G			
guarniciones	57		
I			
interruptores magnéticos	15		
interruptores y pulsadores	12		
interruptores/pulsadores basculantes	12		
J			
juntas de termostato	53		
juntas para bandejeros	51		
juntas para paneles de control	51		
juntas para puertas	48		
juntas para roscas	39, 58, 63		
juntas para ventanas	48		
juntas térmicas	48		
juntas tóricas	51		
L			
lámparas	16		
lámparas de descarga	16, 17		
lámparas de señalización	16		
lámparas de señalización completas	17		
lámparas fluorescentes	19, 19		
lámparas halógenas	18		
lámparas infrarrojas	18		
lámparas para hornos	19		
lámparas tubulares	18		
M			
material de sujeción	59		
microinterruptores	13		
motores	33		
motores de aire caliente	31		
P			
pasadores elásticos	62		
presostatos	29		
R			
reducciones	57		
reductores de presión	58, 58		
reguladores de energía	10		
relés	24		
relés de temporización	24		
relojes temporizadores	21		
resistencias	3		
resistencias circulación de aire	7		
resistencias de inmersión	6		
resistencias de máquinas de café	4		
resistencias para hornos de pizza	5		
resistencias para salamandras / tostadores de pan	6		
retén	46		
ruedas para aparatos y esquinas protectoras	48		

S

sellantes y pegamentos	63
semiconductores de potencia	23
señalizadores de alarma	22
sensores	26
sensores universales	26
silicona	58, 63
silicona de alta temperatura	63
siliconas para uso alimentario	58, 63
sondas de temperatura	26
sujeciones	61

T

tapas terminales y tapones	48
temporizadores	21
temporizadores eléctricos	21
temporizadores mecánicos	21
terminales	36
termopares	38
termostatos	10
termostatos de regulación	10
termostatos de seguridad	11
tornillos	59
tornillos de cabeza avellanada	59
tornillos de cabeza cilíndrica	60
tornillos de cabeza plana	59
tornillos de chapa	59
tornillos prisioneros	60
transformadores	24
tubos de nylon	56
tubos de silicona	56
tubos espiral en acero inoxidable	56
tubos flexibles de ducha	56
tubos flexibles	56
tubos flexibles industriales	56
tuercas	60
tuercas de chapa	60
tuercas de ranura	61
tuercas hexagonales	59, 60

U

unidades de encendido	38
-----------------------	----

V

válvulas de control de gas	36
válvulas magnéticas	28
ventilador axial	30
ventiladores	30
ventiladores de aire caliente	33
ventiladores tangenciales	30