

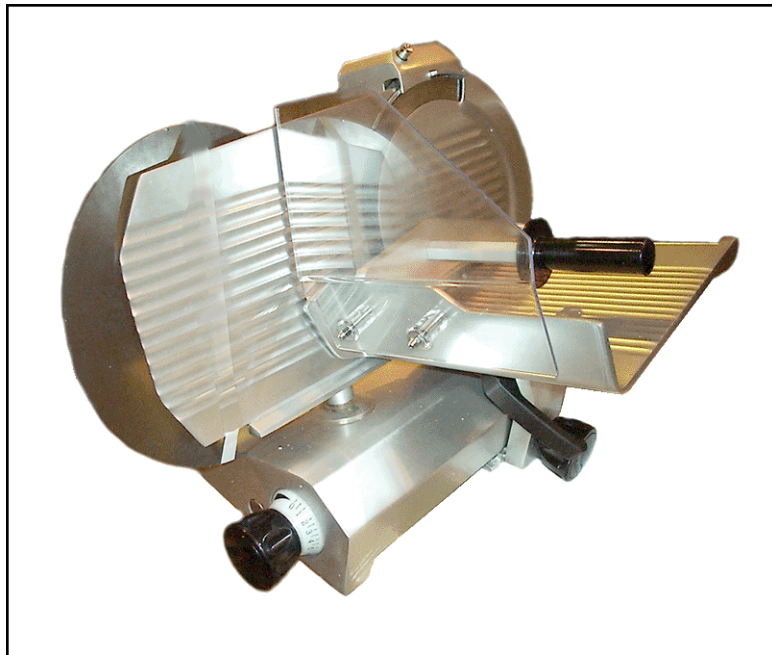

HOBART



Slicer

GLE300

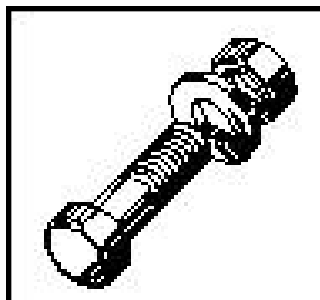

Spare Parts

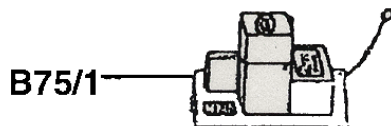
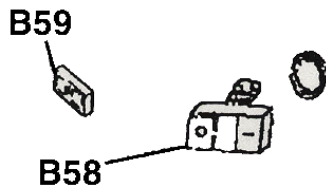
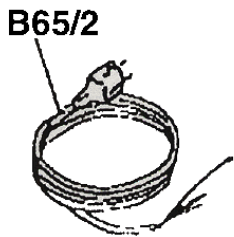
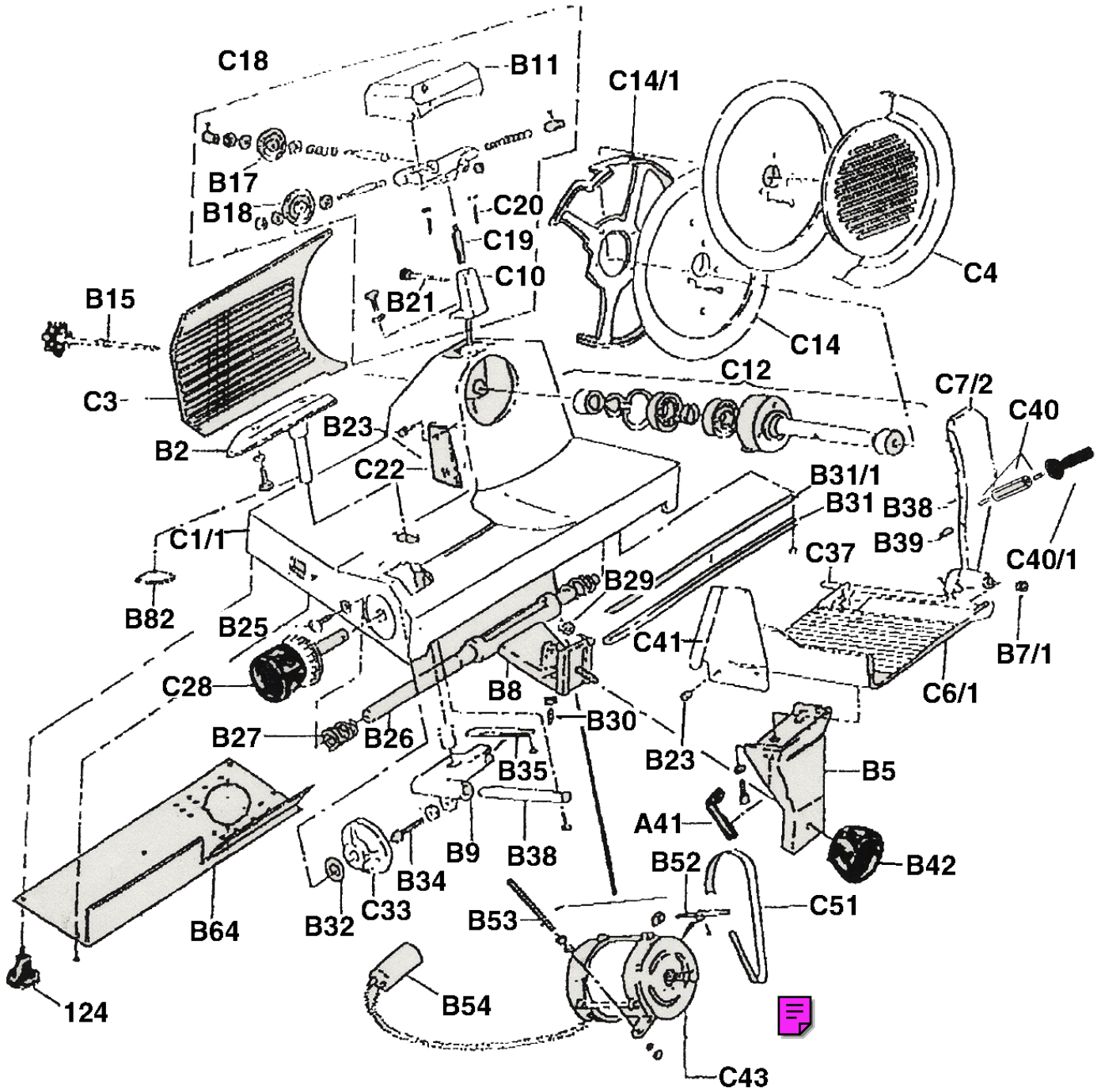



Slicer GLE300

CODE	PART No	DESCRIPTION
C1/1		FRAME
B2		GAUGE PLATE SUPPORT
C3		GAUGE PLATE
C4	00-737740-201	KNIFE COUNTER PLATE
B5		MEAT TABLE SUPPORT
C6/1		MEAT SUPPORT PLATE
C7/2	00-737740-95	MEAT PRESS 00-737740-95
B7/1	00-737740-92	MEAT PRESS SHAFT BUSHING
	00-737740-91	MEAT PUSHER COMPLETE
B8		CARRIAGE with No2 BUSHINGS B8/2 and No1 BEARING B29
B9		THICKNESS PLATE SLIDE
C10		SHARPENER SUPPORT
B11	00-737740-1	SHARPENER COVER
C12	00-737740-102	KNIFE HUB
C14	00-737740-202	KNIFE
C14/1		FILE PROTECTION RING
B15	00-737740-203	COUNTER PLATE KNOB ASSY
C16	00-737740-204	SHARPENER
B17	00-737740-205	INSIDE STONE
B18	00-737740-206	OUTSIDE STONE
C19		SHARPENER POST
C20		REGISTER PIN
B21		KNOB
C22	00-737740-200	DEFLECTOR
B23		DEFLECTOR SCREW
124	00-737740-207	RUBBER FOOT
B25		SCREW
B26		ROUND GUIDE
B27		SPRING
C28	00-737740-209	KNOB
B29		BALL BEARING
B30		HEX SOCKET SCREW
B31		ROD SQUARE
B31/1		STEEL FALT 0.8mm
B32		COMPENSATING RING
C33	00-737740-210	CAM
B34	00-737740-211	PIN
B35		PLATE
B36		PIN
C37	00-737740-93	SLIDING SPINDLE
B38	00-737740-212	PIN
B39	00-737740-213	NYLON PIN
C40	00-737740-214	SPACER FOR MEAT PUSHER HANDLE
C40/1	00-737740-215	MEAT PUSHER HANDLE
A41	00-737740-216	" L " HANDLE
C41	00-737740-217	GUARD
B42	00-737740-218	KNOB
C43	00-737740-107	MOTOR 220 V/50 Hz 1-PHASE
C43/1		MOTOR 110 V/60 Hz 1-PHASE
B51	00-737740-22	BELT
B52		PIN
B53		TIE-ROD
B54	00-737740-220	CAPACITOR
B58	00-737740-221	DOUBLE BUTTON
B59		CAP
B64	00-737740-222	BOTTOM COVER
B65/2		CABLE with PLUG SCHUCO
.		CABLE with PLUG UK
.		LAMP
B75/1	00-737740-223	ELECTRONIC CARD 1-PH
B80		CABLE PASS-THROUGH
B82		SUCKER
.	00-737740-224	BLADE REMOVAL TOOL



Slicer GLE300

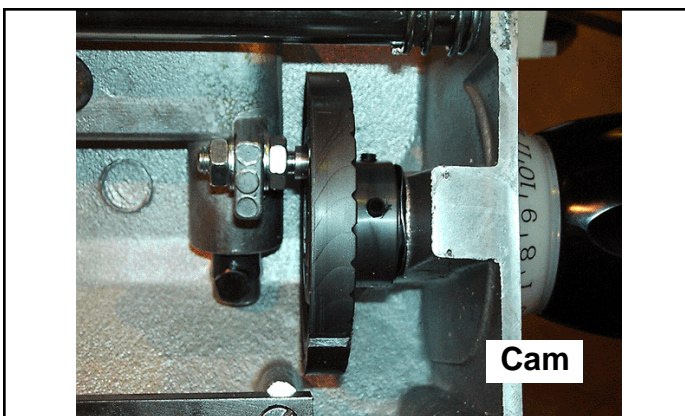
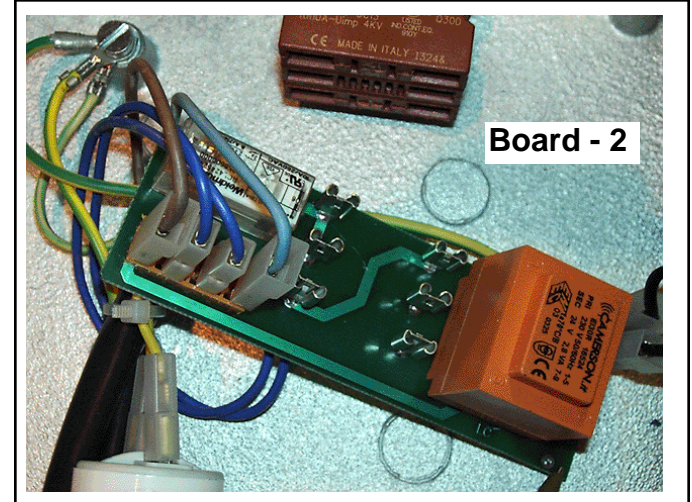
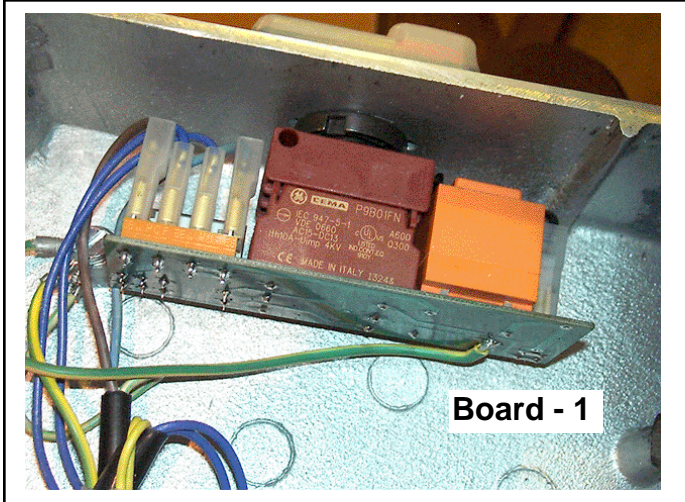
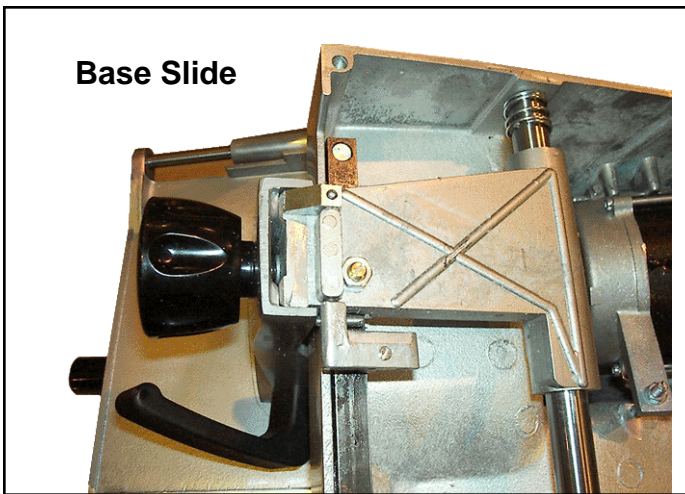
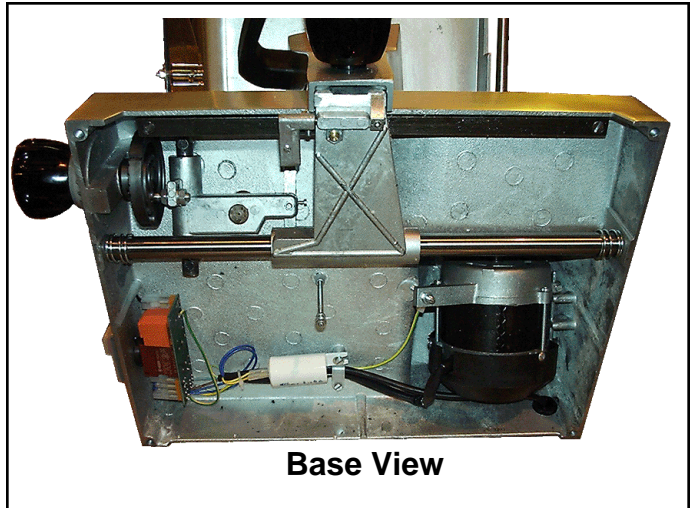
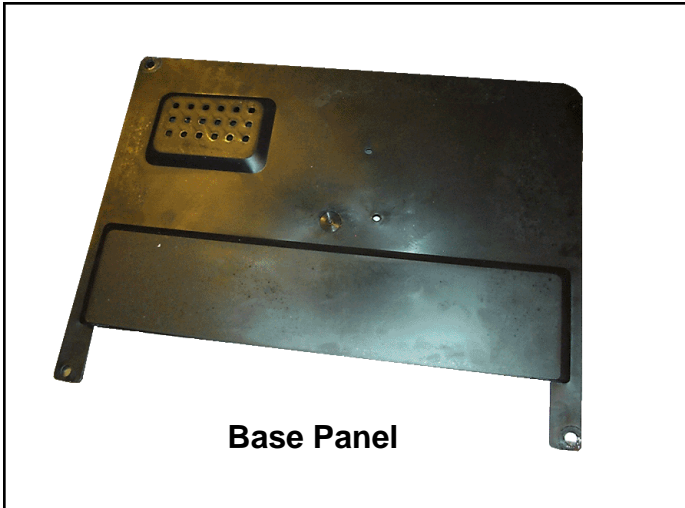



Slicer GLE300

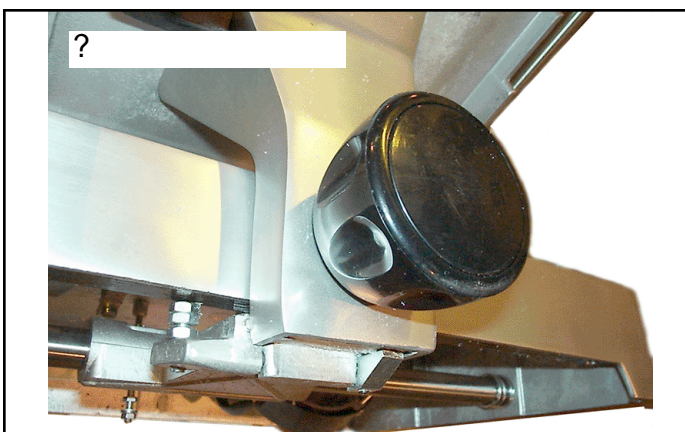
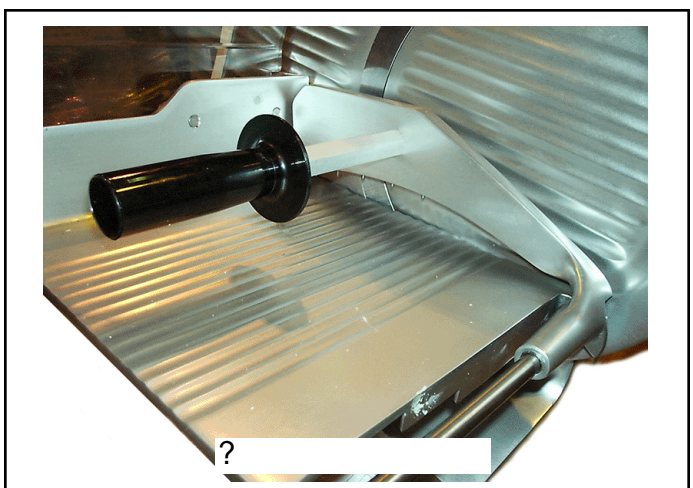
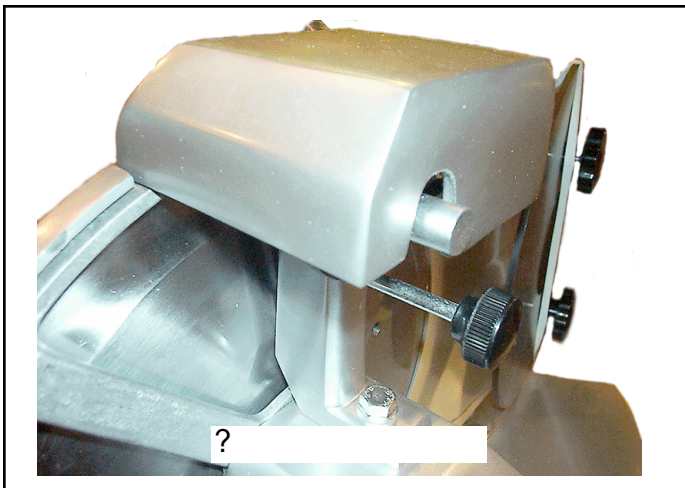
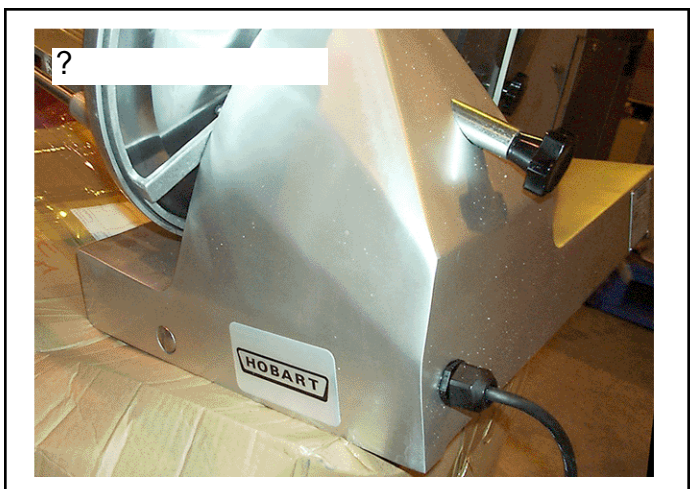
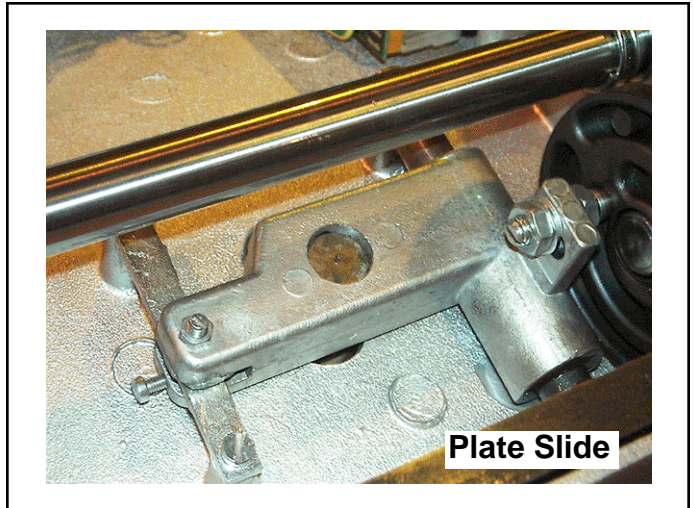



As continued product improvement is a policy of HOBART, specifications are subject to change with-out notice.