

ABBATTITORI RAPIDI
per gastronomia, pasticceria, gelateria

GB **BLAST CHILLER FREEZERS**
for gastronomy, pastry, ice-cream

DE **SCHNELLABKÜHLER SCHOCKFR.**
für Gastronomy, Gebäck, Speiseeis

FR **CELLULES REFROIDISSEMENT**
pour gastronomie, pâtisserie, glacerie

ES **ABATIDORES**
para gastronomia, pasteleria, heladeria

PT **EXPLUDA FREEZER**
para o gastronomia, pastelaria, geleira

GR **ΤΣΙΛΙ ΦΥΣΗΜΑΤΟΣ**
για τη γαστρονομία, ζύμη, παγωτό

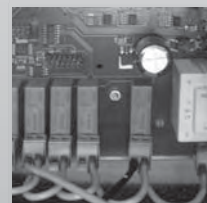
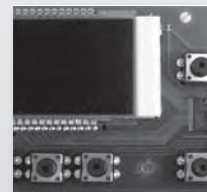



CR

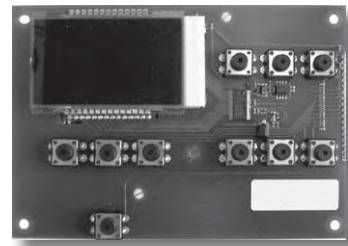

G1 S

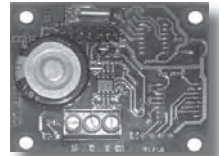

IS



CK

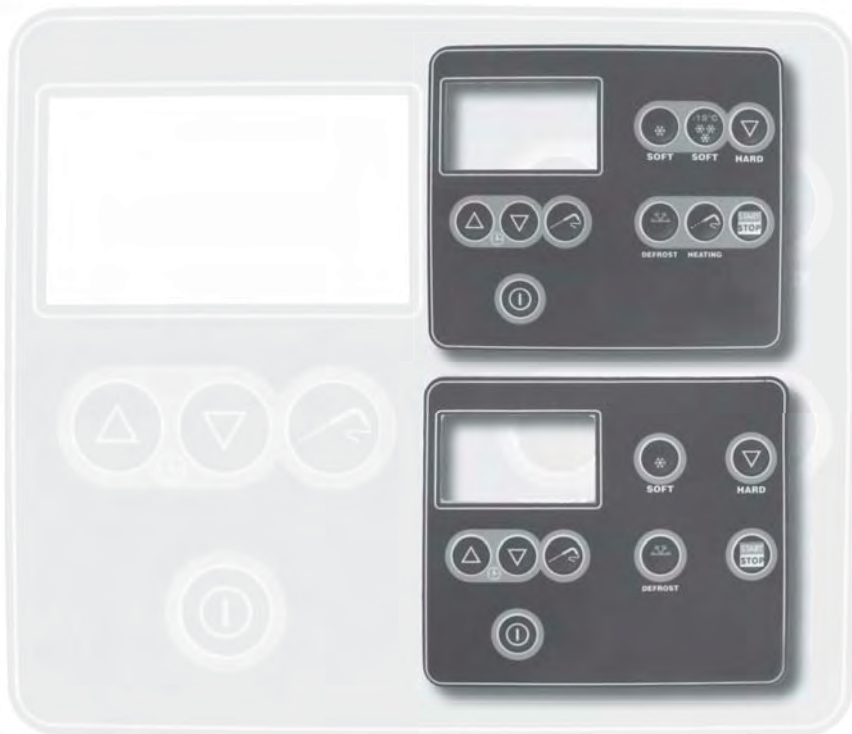

MAS 1

MAS 2

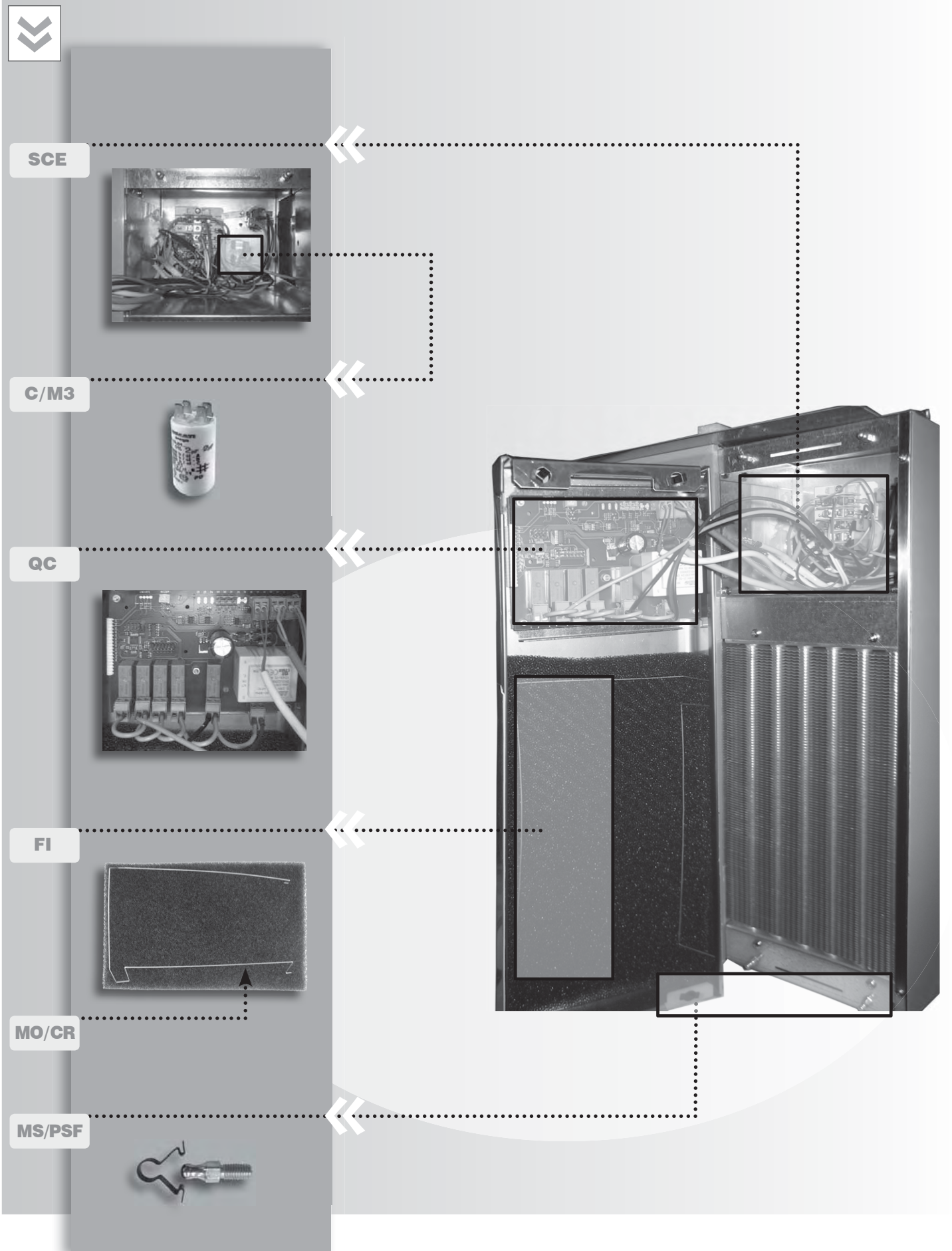

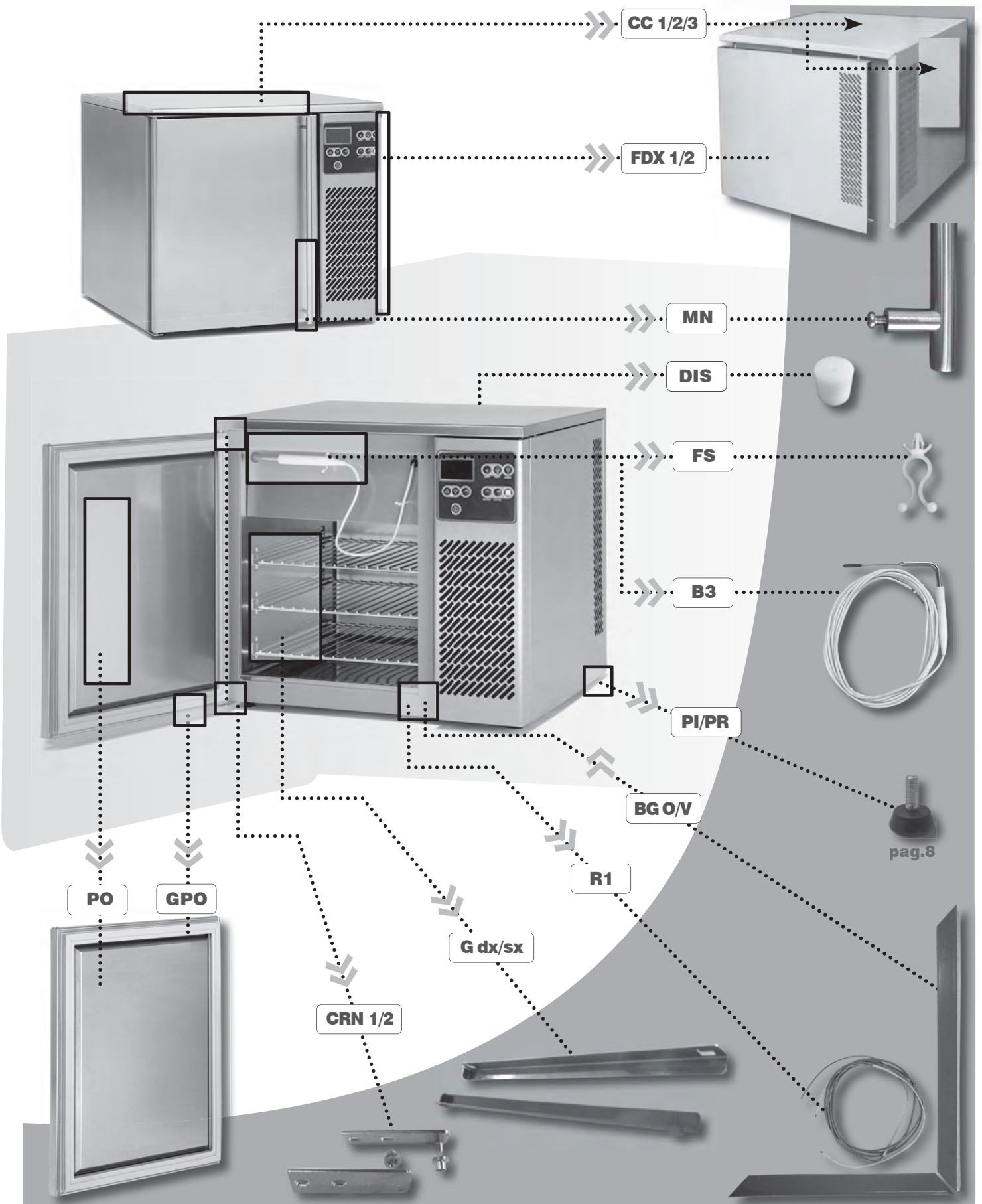



CO

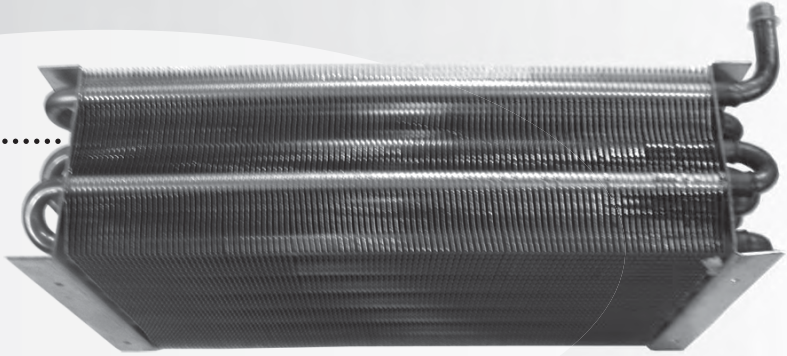

kit TSC

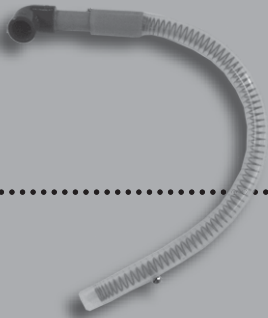

CE/M3

SVE

M3

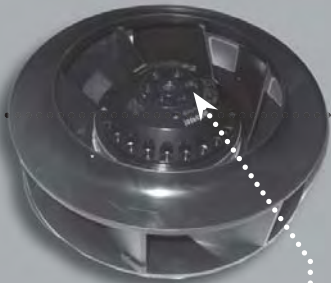

EV

B1

B2

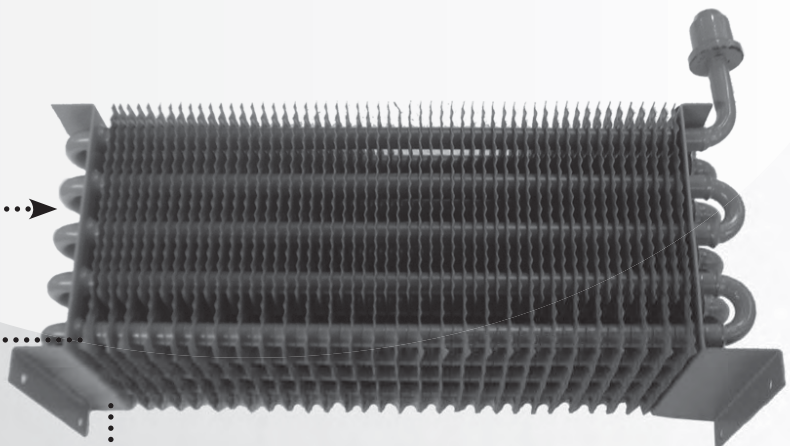
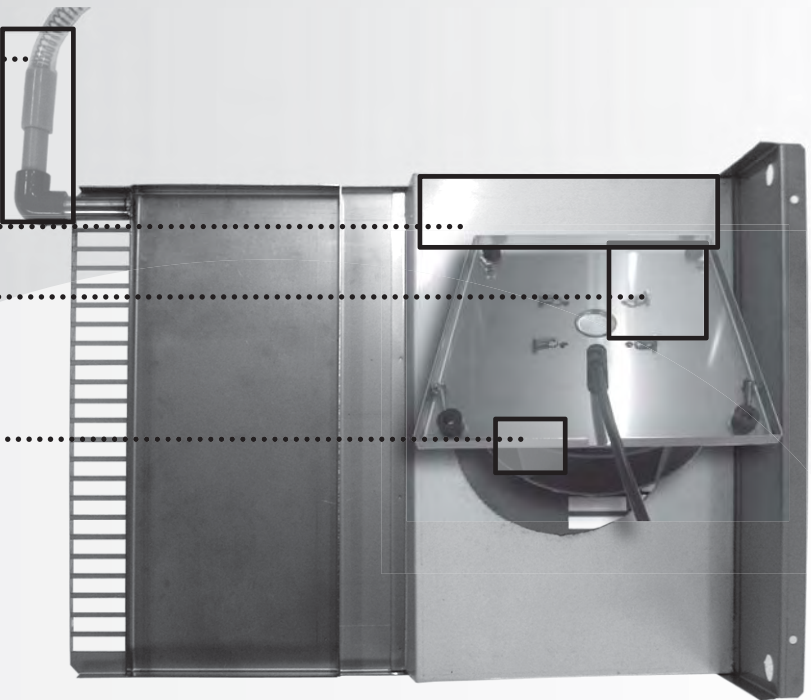



CE I



VE



OR

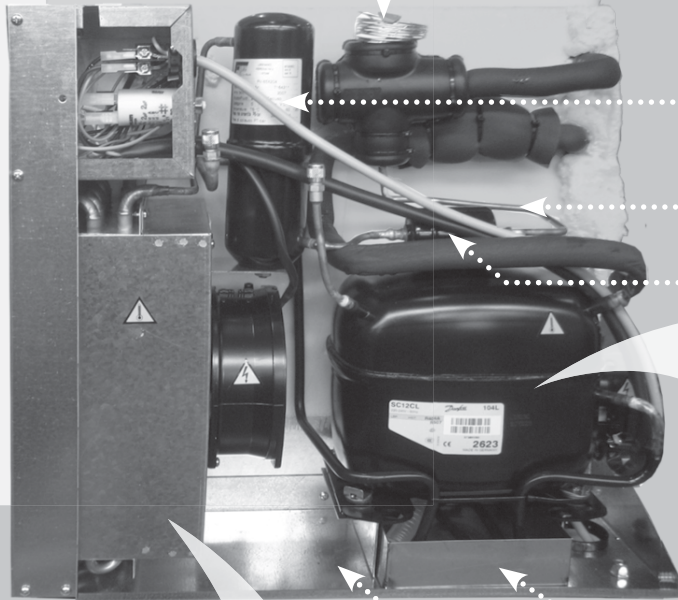

PVE

RL

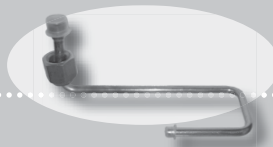

BVE

F



M1



C/M1+Q

VCC



T

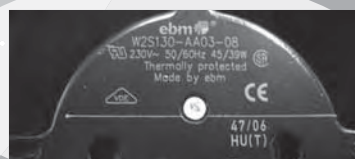
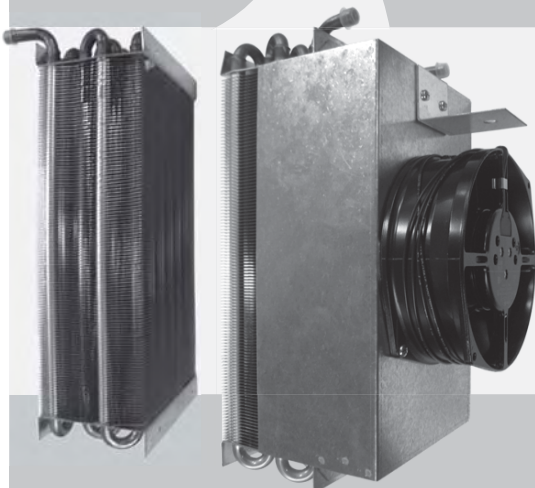

M2

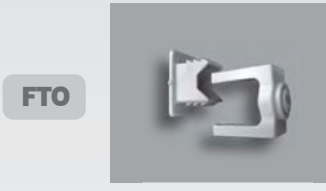
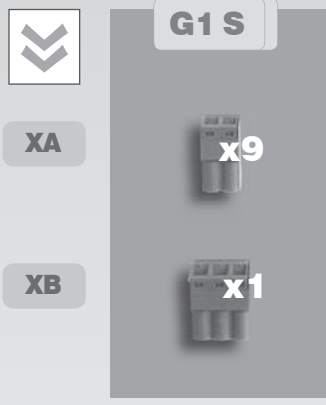
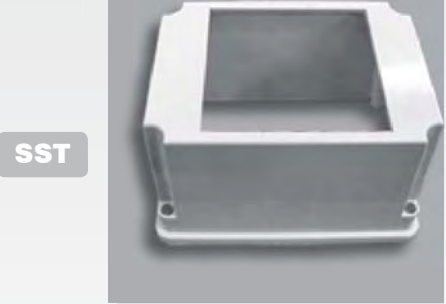
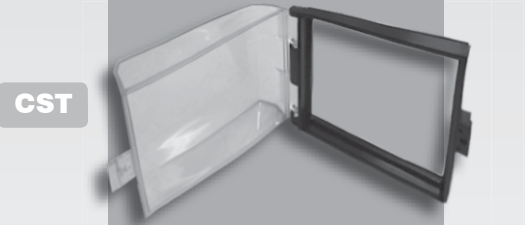
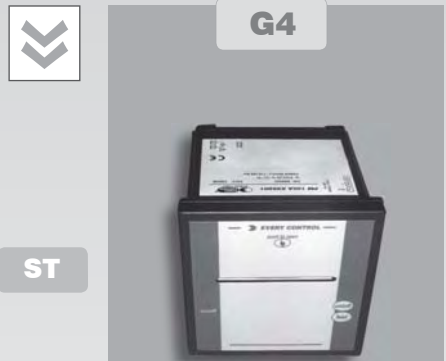
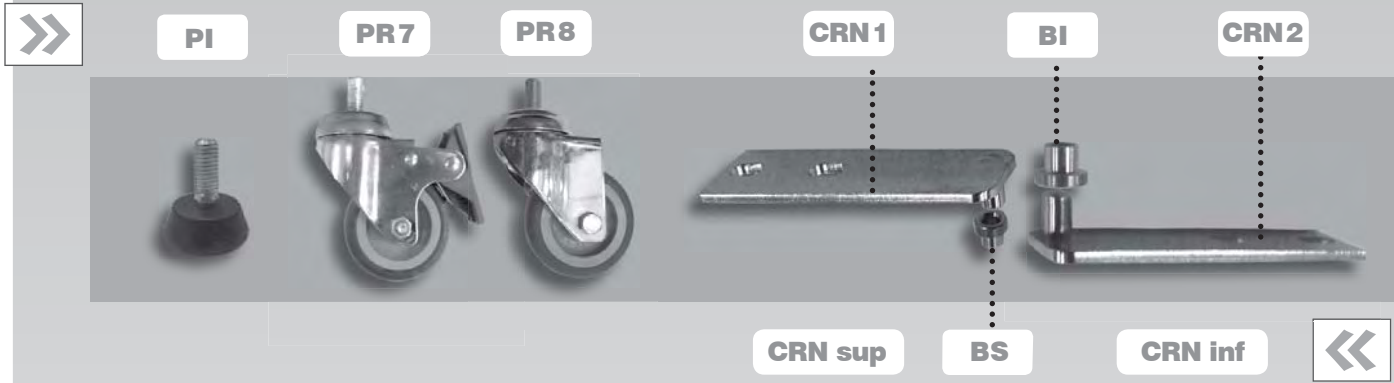

referimento reference	codice code	descrizione description	modello model	da...a from...to
B1	995452	SONDA PTC GRIGIA SILIC.L=1500 CELLA PTC PROBE, GREY SILICONED L=1500 CABINET		01/01/95 00/00/00
B2	995453	SONDA PTC ROSSA SILIC.L=1500 EVAPOR PTC PROBE, RED SILICONED L=1500 EVAPORATOR		01/01/95 00/00/00
B3	965431	SONDA SPIL.PT1000 1 LIV 90° 2500 RISCA CORE PROBE PT1000 LIV1 2,5M WARM		_/_/_ 00/00/00
B3	965432	SONDA SPIL PT1000LIV1 2,5M N/RISCAL CORE PROBE PT1000 LIV1 2,5M NO WARM		_/_/_ 00/00/00
BG 0	965119	PROFILO MOBILE BATT.GUARN.ORIZ MOUVABLE OUTLINE RAB.GASKET HORIZONTAL		24/07/01 00/00/00
BG V	965120	PROFILO MOBILE BATT.GUARN.VERTICAL MOUVABLE OUTLINE RAB.GASKET VERTICAL		24/07/01 00/00/00
BI	925274	BOCCOLA CERNIERA BUSH DOOR HINGE		17/09/96 00/00/00
BO 1	996533	BOCCOLA PASSACAVO D=08 BUSH D=08		_/_/_ 00/00/00
BO 2	996534	BOCCOLA PASSACAVO D=12 BUSH D=12		_/_/_ 00/00/00
BO 8	996538	BOCCOLA PASSACAVO D=42 BUSH D=42		_/_/_ 00/00/00
BS	925034	BOCCOLA SUPERIORE UPPER BUSH		01/01/95 00/00/00
BVE	965697	ASS.TUBO FILTRO-VALVOLA AB 'CHILLY' VALVE-FILTER TUBE BC 'CHILLY'	GN 2/3	_/_/_ 00/00/00
C/M1	996024	CONDENSATORE EL. DANFOSS '117U5017' ELECTRIC CONDENSER DANFOSS '117U5017'		22/05/00 00/00/00
C/M3	996154	CONDENSATORE ELETTRICO MFP 2MF 400V ELECTRIC CONDENSER MFP 2MF 400V		28/08/02 00/00/00
CA	995420	CAVO ALIMENTAZIONE AR-TR SCHUCO ELECTRIC SUPPLY CABLE AR-TR SCHUCO		01/01/95 00/00/00
CC 1	965110	COPERTURA ABBATTITORE 'CHILLY' 'CHILLY' COVERING	GN 2/3	24/07/01 00/00/00
CC 2	965929	COPERTURA ABBATT.'CHILLY' GN1/1 P700 BC 'CHILLY' GN 1/1 P700 COVERING	GN 1/1	14/04/08 00/00/00
CC 3	965930	CHIUSURA ESTERNO SCHIENALE CHILLY P700 EXTERNAL LOCKING BACK CHILLY P700	GN 1/1	14/04/08 00/00/00
CE I	965544	PROFILO ISOLANTE ABB.023 INSULATING PROFILE B.C. 023		_/_/_ 00/00/00
CE/M3	965538	CONVOGLIATORE EVAP. ABB. 023 EVAPORATOR CONVEYOR B.C. 023		_/_/_ 00/00/00
CK	996496	BUZZER X SCHEDA EVCO EVCO CARD BUZZER		09/03/07 00/00/00
CO	965124	CONDENSATORE ABBATTITORE CONDENSER BLAST CHILLER		24/07/01 00/00/00
CR	965540	ASSIEME CRUSCOTTO ABBATTITORE MICRO EV FRONT PANEL ASSEMBLY BLAST CHILLER MICRO EV		_/_/_ 00/00/00
CRN inf	996582	KIT CERNIERA INF ABB 023 LOWER HINGE KIT BLAST CHILLER 023		_/_/_ 00/00/00
CRN sup	996581	KIT CERNIERA SUP ABB 023 UPPER HINGE KIT BLAST CHILLER 023		_/_/_ 00/00/00
CRN 1	965114	CERNIERA SUPERIORE ABBATTITORE UPPER HINGE BLAST CHILLER		24/07/01 00/00/00
CRN 2	965113	CERNIERA INFERIORE ABBATTITORE LOWER HINGE BLAST CHILLER		24/07/01 00/00/00

riferimento reference	codice code	descrizione description	modello model	da...a from...to
CST	996492	COPERCHIO PLEX.PROTEZ.STP EVCO PLEXIGLASS COVER FOR EVCO PRINTER		02/03/07 00/00/00
DIS	925500	DISTANZIALE SCHIENALE TRS MC DONALD'S BACK SPACER TRS MC DONALD'S		_/_/_ 00/00/00
EV	965125	EVAPORATORE ABBATTITORE EVAPORATOR BLAST CHILLER		24/07/01 00/00/00
F	995690	FILTRO DISIDRATATORE ODF DML032S 023Z455 DEHYDRATOR FILTER ODF DML033S 023Z455		02/05/04 00/00/00
FDX 1	965111	FIANCO DESTRO AB 'CHILLY' RIGHT SIDE BLAST CHILLER 'CHILLY'	GN 2/3	24/07/01 00/00/00
FDX 2	965928	ESTERNO FIANCO-SCHIEN. DX CHILLY P700 RIGHT EXTERNAL SIDE CHILLY P70	GN 1/1	14/04/08 00/00/00
FI	965117	FILTRO CRUSCOTTO 180X290 AB CONTROL PANEL FILTER 180X290 B.C.		24/07/01 00/00/00
FS	996068	LACCIO AD INCASTRO STL-350-3-01 (10PZ) FIXED JOINT STL-350-3-01 (10PCS)		24/07/01 00/00/00
FTO	965308	FISSATUBO OBO 3040 LGK D=6-16 MM OBO CLIP 3040 LGK D=6-16 MM		23/02/07 00/00/00
G dx	965545	GUIDA DX ABBATTITORE 023 RIGHT SLIDE B.CHILLER 023	GN 2/3	_/_/_ 00/00/00
G dx	965926	GUIDA DX ABB. CHILLY GN 1/1 RIGHT SLIDE BC CHILLY GN 1/1	GN 1/1	28/04/08 00/00/00
G dx+sx	965109	COPIA GUIDE ABBATTITORE 023 RIGHT AND LEFT SLIDE BLAST CHILLER 023	GN 2/3	24/07/01 00/00/00
G sx	965546	GUIDA SX ABB.023 LEFT SLIDE B.CHILLER 023	GN 2/3	_/_/_ 00/00/00
G sx	965927	GUIDA SX ABB. CHILLY GN 1/1 LEFT SLIDE BC CHILLY GN 1/1	GN 1/1	28/04/08 00/00/00
G1 S	996442	ASS.SCHEDA ELET.EVCO STD HIBE 2°ED.AB ELECTRIC CARD ASS. EVCO STD HIBER 2ND ED.		16/01/07 00/00/00
G4	990584	KIT STAMPANTE ABB 051 PRINTER KIT BC 051		_/_/_ 00/00/00
GPO	965122	GUARNIZIONE PORTA ABBATTITORE 023 DOOR GASKET BLAST CHILLER 023		_/_/_ 00/00/00
IS	996441	SCHEDINA SERIALE AGGIUNTIVA ADDITIONAL PRINTER KIT		22/12/06 00/00/00
kit TSC	965925	KIT TUBO SCARICO CONDENSA CHILLY CONDENSATE DRAIN TUBE KIT FOR CHILLY		04/06/08 00/00/00
M1	995485	COMPRESSORE 14,5 CC T2155GK/SC12CL R40 14,5 CC T2155GK/SC12CL R40 COMPRESSOR		01/03/98 00/00/00
M2	996073	VENTILATORE EBM ELICOIDALE HELICAL FAN EBM		24/07/01 00/00/00
M3	996074	VENTILATORE EBM CENTRIFUGO CENTRIFUGAL FAN EBM		24/07/01 00/00/00
MAS 1	996444	MASCHERINA COMANDI "S" HBR 2 EDIZ. CONTROL PANEL "S" HBR 2ND EDITION		08/01/07 00/00/00
MAS 2	965410	MASCHERINA COMANDI "S" POS HI CONTROL PANEL "S" POS HI		_/_/_ 00/00/00
MN	965115	MANIGLIA PORTA ABBATTITORE 023 HANDLE DOOR BLAST CHILLER 023		20/03/06 00/00/00
MO	965116	MOLLA FIX FILTRO CRUSCOTTO AB 'CHILLY' FIXING SPRING FOR FRONT PANEL FILTER BC CHILLY		24/07/01 00/00/00
MS	996326	MOLLA X PERNO FILETTATO M5 A SCATTO SNAP SPRING FOR THREADED PIN M5		08/11/05 00/00/00

riferimento reference	codice code	descrizione description	modello model	da...a from...to
OR	996263	ORIFIZIO N°01 ODF DANFOSS N.01 ODF ORIFICE DANFOSS		07/09/04 00/00/00
PI	925513	PIEDINO REGOLABILE M8 D30 TRS SPRING ADJUSTABLE FOOT M8 D30 TRS SPRING		26/03/98 00/00/00
PO	965121	PORTA SCHIUMATA ABBATTITORE 023 DOOR FOR BLAST CHILLER 023		24/07/01 00/00/00
PR 7	996540	RUOTA GIR D= 60 CROMATA CON FRENO REVOLVING CASTER D= 60 CROM WITH BRAKE		_/_/_ 00/00/00
PR 8	996541	RUOTA GIR D= 60 CROM S/FR REV. CASTER D=60 CROM WITHOUT BRAKE		_/_/_ 00/00/00
PSF	996327	PERNO FILETTATO M5 A SCATTO ART.R 6333 SNAP THREADED PIN M5 ART.R 6333		08/11/05 00/00/00
PVE	995776	ASS.SEMIPROT.VALVOLA 'FLICA-DANFOSS' SEMI-PROTECTION VALVE 'FLICA/DANFOSS'		13/06/97 00/00/00
Q	996018	RELE' AVVIAMENTO DANFOSS '117U6005' STARTING RELAY DANFOSS '117U6005'		22/05/00 00/00/00
R1	965123	RESISTENZA CORNICE ABBATTITORE 023 FRAME HEATER BLAST CHILLER 023		24/07/01 00/00/00
RC	996493	ROTOLO CARTA X STAMPANTE EVCO PM100AX9 ROLL OF PRINTER PAPER EVCO PM100AX9		02/03/07 00/00/00
RL	995906	RICEVITORE DI LIQUIDO 0,58 LITRI LIQUID RECEIVER 0,58 LITERS		08/10/98 00/00/00
SCE	965559	ASS.SCATOLA ELET. WIRING BOX B.C.		_/_/_ 00/00/00
SST	965568	SCATOLA PER STAMPANTE ABB051 PRINTER BOX BLAST CHILLER 051		_/_/_ 00/00/00
ST	996415	STAMPANTE PER SCHEDA EVCO PRINTER FOR EVCO CARD		03/11/06 00/00/00
SVE	965539	SUPPORTO VENTILATORE INT ABB.023 INTERNAL FAN SUPPORT B.C. ABB.023		_/_/_ 00/00/00
T	990319	TRASFORMATORE 230/24V 17VA 50/60HZ TRANSFORMER 230/24V 17VA 50/60HZ		08/09/00 00/00/00
VCC	965108	VASCHETTA CONDENSATORE CONDENSATOR TRAY		24/07/01 00/00/00
VE	996206	VALVOLA TERMOSTATICA TS2 R404A SILDARE THERMOSTATIC VALVE TS2 R404A TO SOLDER		18/03/03 00/00/00
XA	965525	MORSETTO PHOENIX MSTB 2,5/2-ST PAS=5 PHOENIX TERMINAL MSTB 2,5/2-ST PAS=5		_/_/_ 00/00/00
XB	965526	MORSETTO PHOENIX MSTB 2,5/3-ST PAS=5 PHOENIX TERMINAL MSTB 2,5/3-ST PAS=5		_/_/_ 00/00/00