





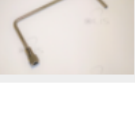





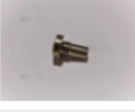



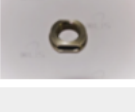



Photo	Pos	Code	Previous code	Quantity	Recommended	From	To	Description
	0001	LAR65040530		1	✓			MOTOR [C] 200/440V 0,55KW ONE SPEED
	0001	LAR65041210		1	✓			MOTOR [C] 240/480V 60HZ 0,55KW ONE SPEED
	0002	LA58003850	LAR58003850	1				COUNTER FLANGE [C]
	0003	LA58003840	LAR58003840	1				FLANGE [C] GASKET
	0004	LA70020050	LAR70020050	1				GASKET [C]
	0005	LA75400440	LAR75400440	1	✓			FAN [C] D. 350X114 50HZ
	0006	LA58004010	LAR58004010	1				WASHER [C] D. 30/12,5
	0007	LA58004000	LAR58004000	1				SCREW [C] M12X1.5
	0008	LA61020562	LAR61020562	1				SCREW [C] M6X55 UNI 5737









	0009	LA70030200		1			GASKET [C] HEATING ELEMENTS
	0010	LAR65011300		1			HEATING ELEM. 15000W 208V
	0010	LAR65011310		1			HEATING ELEMENT [C] 15000W 230V CHAMBER
	0011	LA69150110	LAR69150110	1			CAP [C]
	0012	LA70050140	LAR70050140	1			GASKET CAP BOILER
	0013	BN2519490	LAR70010360	1			KNOB GASKET V-SEALVA40/NBR
	0014	LAR14217020N		1			BOILER C/CALOUT NA-SAEB101 AISI 316
	0015	LA58004030	LAR58004030	1			NUT [C] 1 1/4X10 M/110-210-220
	0016	LA65320010	LAR65320010	2			LEVEL PROBE [C]

	0017	LAR65020310		2			HEATING ELEMENT [C] 7500W208V BOILER	USA
	0017	LAR65020350		2			HEATING ELEMENT [C] 7500W230V BOILER	EUROPA
	0018	LAR65110571		1	✓		VALVE [C] 230V	
	0019	LA62080093	LAR62080093	1			JOINT [C]	
	0020	LA65324550	LAR65324550	1	✓		LEVEL PROBE [C]	
	0021	LA62090908	LAR62090908	1	✓		INTERMEDIATE STRAIGHT CONNECTOR [C] D. 10 SPEEDFIT	
	0022	LA80150060	LAR80150060	0,81	✓		PIPE [C] PEX-B D. 10MM L.100M	
	0023	LA62090528	LAR62090528	2	✓		CURVED CONNECTOR [C] 10X10	
	0024	LAR65110330		1	✓		SOLENOID VALVE [C] 230V 50/60HZ 2 OUTLET JG CONNECTION D. 10	
	0024	LAR65110770		1	✓		ELECTRO VALVE [C] 230V 50/60HZ 2 WAYS OUT J.G. D.10 UL	

	0025	LA62090798	LAR62090798	1	✓		STRAIGHT REDUCTION [C] D. 8-6
	0026	LA80150020	LAR80150020	0,55	✓		TRANSPARENT POLIURETHANE PIPE [C] D. 8X6MM
	0027	LA65110630	LAR65110630	2			SUPPORT [C] PUMP
	0028	LAR65110620		1	✓		PUMP [C] 230V 50HZ
	0029	LA80150020	LAR80150020	0,74	✓		TRANSPARENT POLIURETHANE PIPE [C] D. 8X6MM
	0030	LA62090878	LAR62090878	1			INTERMEDIATE STRAIGHT CONNECTOR [C] D. 8
	0031	LA11201970	LAR11201970	1			ASS.PROL.SPRUZZATORE C-V-M/101.
	0032	LA14219640		1			PIPE [C] CONNECTOR HUMIDIFIER N/SE101 2017
	0033	LA62090908	LAR62090908	1	✓		INTERMEDIATE STRAIGHT CONNECTOR [C] D. 10 SPEEDFIT
	0034	LA80150060	LAR80150060	0,8	✓		PIPE [C] PEX-B D. 10MM L.100M

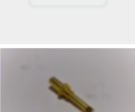
	0035	LA70010370	LAR70010370	2			GASKET [C]
	0036	LAR65320220		3	✓		PROBE [C] K L. 1,5M
	0037	LA62070023	LAR62070023	3			BICONE [C] D. 6
	0038	LA62060223	LAR62060223	3			NUT [C] D. 6
	0039	LAR58006690		1			CAP [C] SERIE 2014
	0040	LAR65095000		1	✓		RELEASE MOTOR [C] COMPLETE - 1 CAM
	0042	LAR70030180		1			GRAPHITE GASKETS KIT [C] 80x50,3x3 SET 5 PIECES
	0043	LAR14201040		1			DEFLECTOR [C] N/S101 2014
	0044	LA75300070	LAR75300070	1			PLATE [C] FAN D. 350 N/S101 2014
	0045	LAR58003110		2			PIN [C] DEFLECTOR CLAMPING

	0046	LA14402130	LAR14402130	1			HINGE [C]
	0047	LA58000370	LAR58000370	1	✓		PIN [C] UPPER HINGE
	0048	LA58004050	LAR58004050	1			NUT [C]
	0049	LA11207240	LAR11207240	1			LOWER HINGE KIT [C] M-V/061-101-102 2005
	0050	LA58002670	LAR58002670	1	✓		LOWER PIN [C] HINGE SR 2005
	0051	LA58000360	LAR58000360	1			NUT [C]
	0052	LA70048012		1			GASKET [C] DOOR T10 2016
	0053	LAR69180210		1			DRAIN CONTAINER [C] N/S071-101 2014
	0054	LA69180250	LAR69180250	1	✓		FILTER [C] CONTAINER DRAIN
	0055	LA14443120	LAR14443120	2			RACK [C] GN N/S 101 2014

	0056	LAR10201710		1			AIR FILTER [C] DRAIN M/210-12 D.86/44,5
	0057	LAR70030180		1			GRAPHITE GASKETS KIT [C] 80x50,3x3 SET 5 PIECES
	0058	LA70060040	LAR70060040	2			SILICONE COUPLING [C] D. INNER 51 D. EXTERIOR 59
	0059	LA70060080		1			SILICONE COUPLING [C] D. 13X18X80
	0060	LAR69180120		1	✓		BOX [C] DRAIN PIPE G/MV T06-T10-T21
	0061	LA58006160		2			NOZZLE [C] D. 0,80
	0062	LA62090633	LAR62090633	1	✓		CURVED CONNECTOR [C] 10/10
	0063	LA70050150	LAR70050150	1			GASKET [C] BOILER CAP
	0064	LA69150100	LAR69150100	1			CAP [C]
	0065	LA61630031	LAR61630031	3			ZINC CLAMP [C]



0066

LA62280038

LAR62280038

1

CURVE [C]



0067

LAR65240030

1

FAIRLEAD [C]

DX

SX

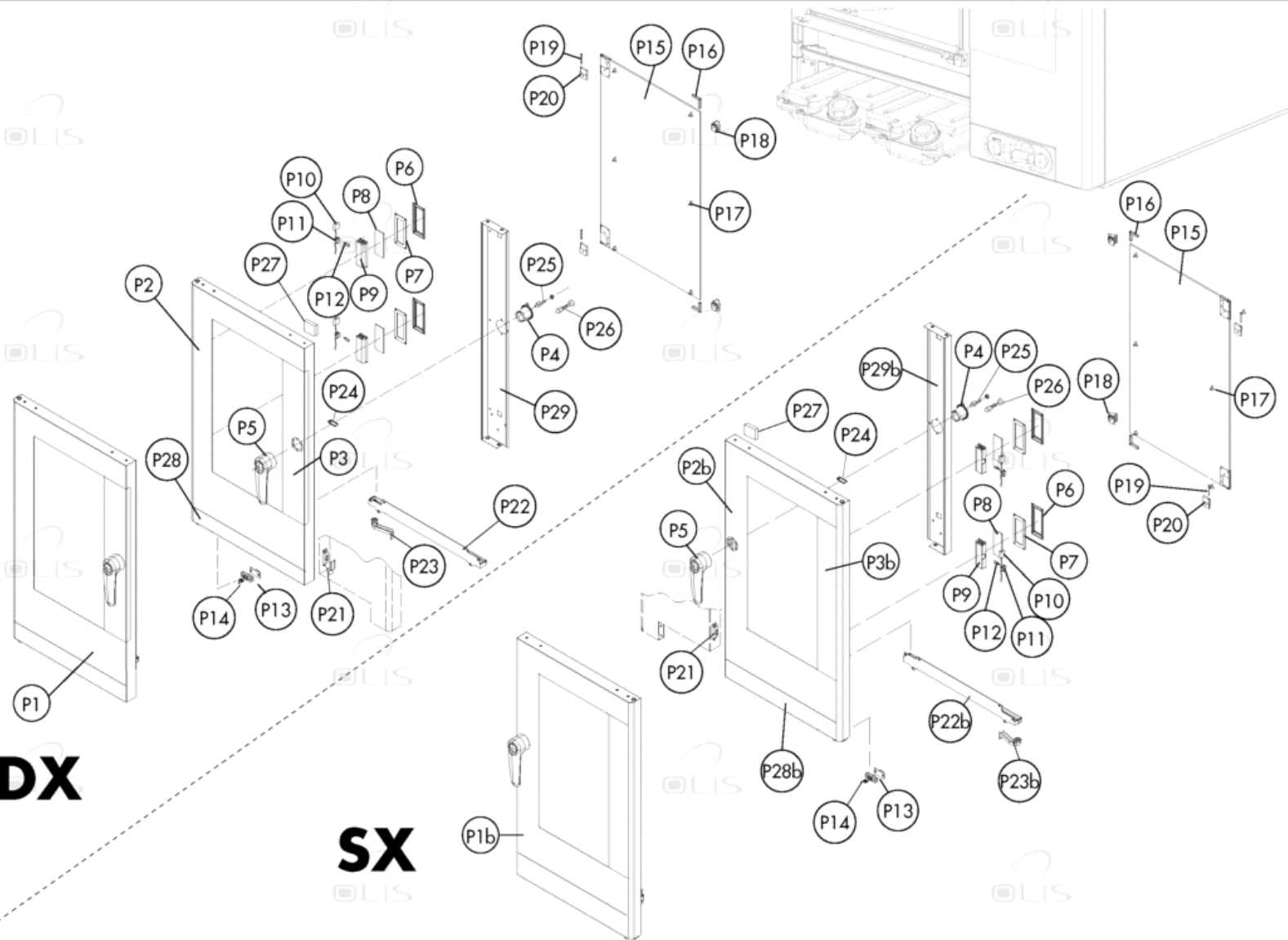















Photo	Pos	Code	Previous code	Quantity	Recommended	From	To	Description
	00P1	LAR14184290		1		21/10/2019		DOOR [C] SA_101 W/TANK LED
	00P2	LAR14203770H		1		21/10/2019		OUTER DOOR [C] SA_101 W/TANK LED
	00P4	LAR69010630		1	✓			COVERING [C] GROUP 6303 CLOSING
	00P5	LA69010190	LAR69010190	1	✓			LOCK [C] 6303 N/S2014
	00P6	LA11401450		2			18/10/2019	FLANGE [C] BULB GLASS
	00P6	LA65270590		2	✓	21/10/2019		LED LAMP L=130MM 12V DC [C]
	00P7	LA65270590		2	✓	21/10/2019		LED LAMP L=130MM 12V DC [C]
	00P7	LA70044200		2			18/10/2019	GASKET [C] BULB GLASS P2000
	00P8	LA65270590		2	✓	21/10/2019		LED LAMP L=130MM 12V DC [C]
	00P8	LA71500150		2			18/10/2019	GLASS PLATE [C]

	00P9	LA11401440		2			18/10/2019	LAMP COVER [C]
	00P9	LA65270590		2	✓	21/10/2019		LED LAMP L=130MM 12V DC [C]
	0P10	LA66110320		1			18/10/2019	DOOR LIGHTS CABLE SET [C] MV101-102
	0P10	LA66115810		1		21/10/2019		CABLAGGIO LUCI PORTA MV101-102.
	0P11	LA65270450		2	✓		18/10/2019	LAMP HOLDER [C]
	0P11	LA65270590		2	✓	21/10/2019		LED LAMP L=130MM 12V DC [C]
	0P12	LA65270020		2	✓		18/10/2019	BULB [C] 12V 20W G4
	0P12	LA65270590		2	✓	21/10/2019		LED LAMP L=130MM 12V DC [C]
	0P13	LAR65260752		1	✓			LIGHT CONTACT [C] SR.2014 - FLOOR OVEN
	0P14	LA61600031	LAR61600031	2				GASKET [C] D. 3,2

	OP15	LAR71202190		1				GLASS PLATE [C]
	OP15	LAR71202190A		1				GLASS PLATE [C]
	OP16	LA11423460	LAR11423460	2				PROTECTION [C] DOOR GLASS K E T 2011
	OP17	LAR70050180		6				SPACER [C] GLASS PLATE 15X8
	OP18	LAR17406230		2		13/08/2018		GLASS BLOCK [C]
	OP18	LAR58001780		2		10/08/2018		FERMO VETRO PORTA P2000
	OP19	LA58001770	LAR58001770	2				PIN [C] GLASS HINGE SR2000
	OP1b	LAR14173860		1			18/10/2019	DOOR [C] REVERSAL SA_101 W/TANK
	OP1b	LAR14184320		1		21/10/2019		DOOR [C] REVERSAL SA_101 W/TANK LED

	OP20	LA58001760	LAR58001760	2				HINGE [C]
	OP21	LAR65265100		1				MICROSWITCH [C] DOOR
	OP22	LAR69180220		1	✓			DOOR CONTAINER [C] N/S071-101 2014
	OP23	LA69180011		1				WATER DRAIN [C] CONTAINER
	OP24	LA61620132	LAR61620132	1	✓			SPRING [C] PRONG HOOK
	OP25	LA69010260	LAR69010260	1	✓			PRONG [C]
	OP26	LAR69010270		1				DOOR LATCH 2 STEP [C]
	OP27	LA11420660	LAR11420660	1				FLANGE [C]
	OP2b	LAR14204090B		1			18/10/2019	OUTER DOOR [C] OPPOSITE SA_101 W/TANK
	OP2b	LAR14204090H		1			21/10/2019	OUTER DOOR [C] REVERSAL SA_101 W/TANK LED

	OP3b	LA67017221		1				RIVESTIMENTO PORTA S/MAN. SA_101R-102R
	P22b	LAR14202061		1				TRAY [C] LH DOOR N/S071- 101 2014
	P23b	LA11202240	LAR11202240	1				WATER DRAIN [C] CONTAINER SR2000

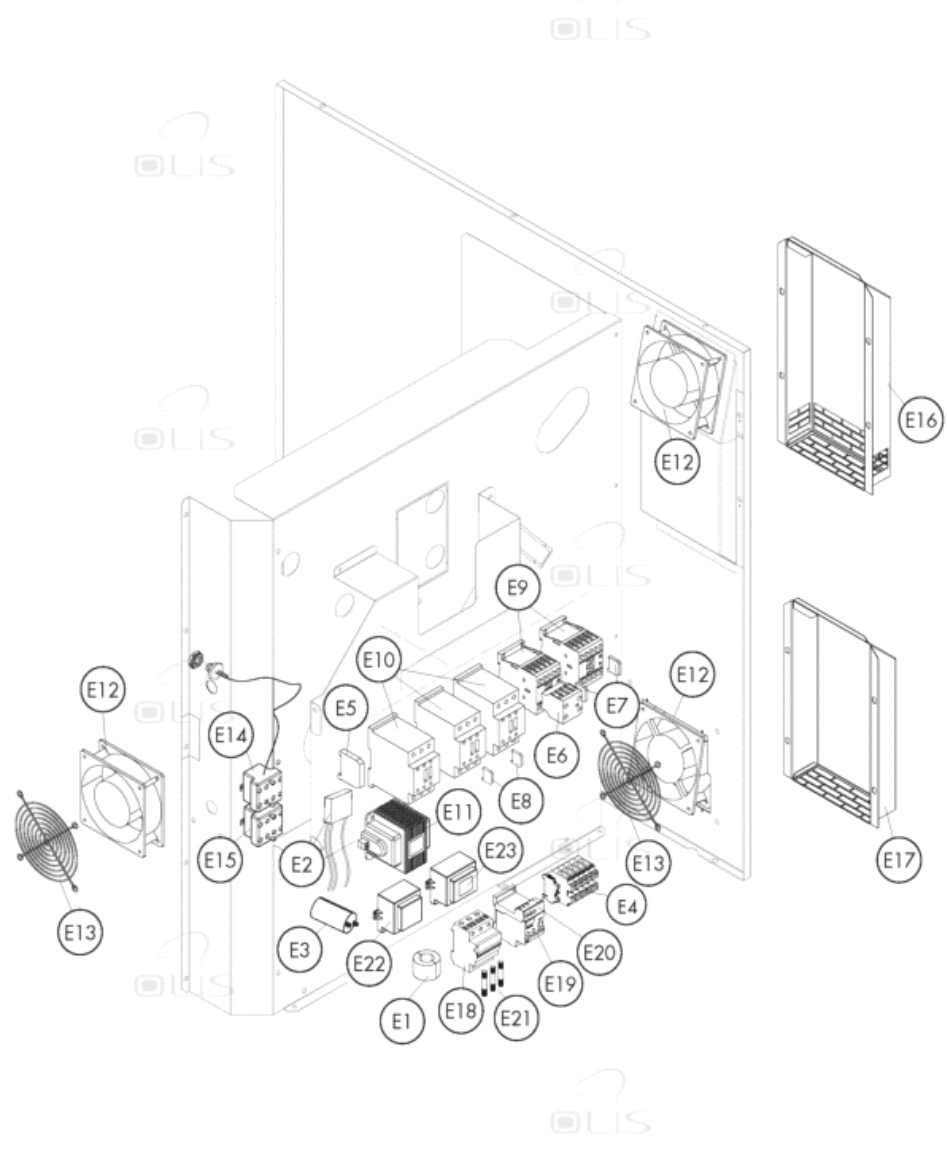
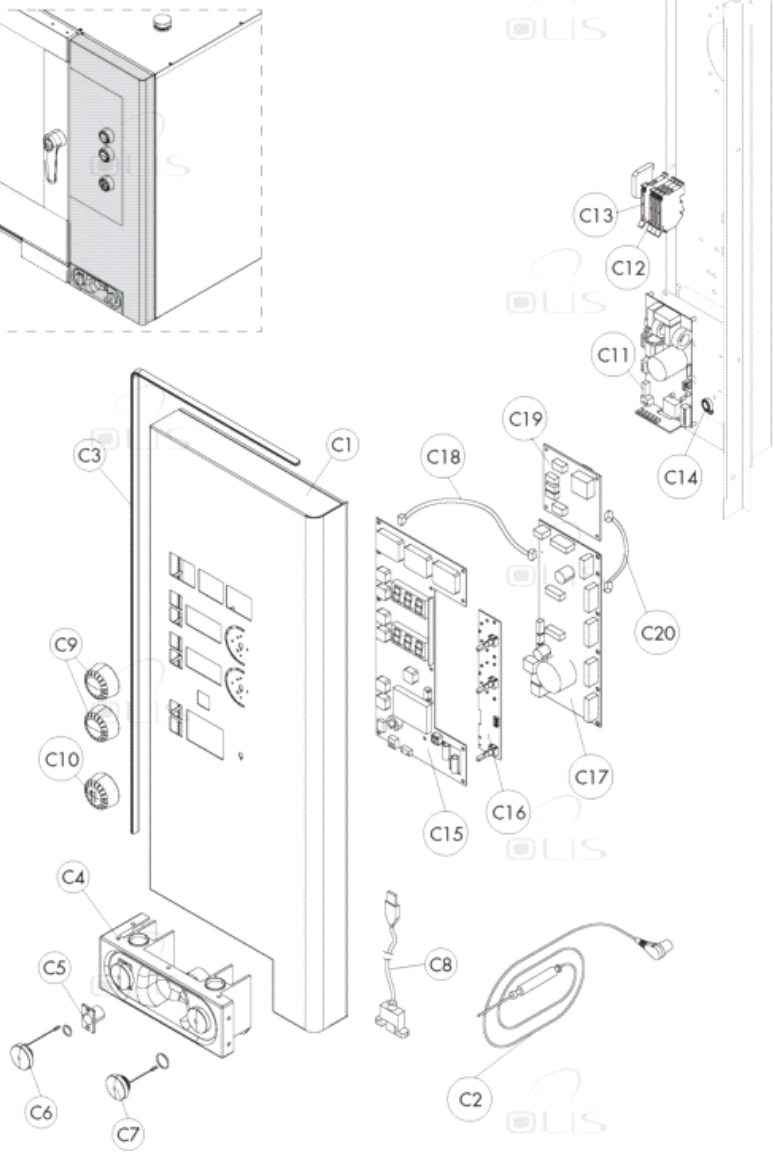
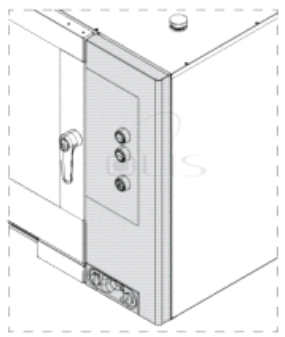



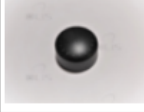























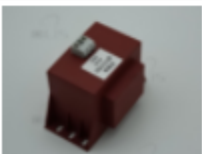

Photo	Pos	Code	Previous code	Quantity	Recommended	From	To	Description
	00C2	LA65321102		1				SONDA AL CUORE K 4 PUNTI 6 PIN.IMP.2012
	00C3	LAR80100101		1				PROFILO GUARNIZIONE NERO 2CRISTALLI 5M
	00C4	LA14402070	LAR14402070	1				CONNECTIONS FRAME [C]
	00C5	LA65321360	LAR65321360	1				F-CONNECTOR [C] FOR CORE PROBE L. 1000
	00C6	LA65321330	LAR65321330	1				CAP [C] N/S 2014
	00C7	LA65321310	LAR65321310	1				CAP [C] USB SOCKET
	00C8	LA65302600	LAR65302600	1				CONNECTING CABLE [C] BOARD/USB OUTLET L. 850
	00C9	LA69030380		2				ENCODER [C] KNOB D. 46
	00E1	LAR65280510		1				FERRITE TOROIDALE FT58

	00E2	LA65280250	LAR65280250	1			POWER FILTER [C]
	00E3	LA65280240	LAR65280240	1			ELECTROMECHANICAL FILTER [C]
	00E4	LA65220290	LAR65220290	1			TERMINAL BLOCK [C]
	00E5	LA65140940	LAR65140940	1	✓		CONTACT [C] 1L+1R 3RH2921-1DA11
	00E6	LA65140930	LAR65140930	1	✓		CONTACT [C] 1L+1R 3RH2911-1HA11
	00E7	LA65140960	LAR65140960	2			SURGE SUPPRESSOR (SNABBER)
	00E8	LA65140970	LAR65140970	2			LIMITING DEVICE [C]
	00E9	LA65140900		2	✓		CONTACTOR [C]
	0C10	LA69030400		1	✓		ENCODER [C] KNOB D. 46 W/LOGO

	0C11	LAR65140090		1	✓		INVERTER [C] 0,8KW UL
	0C11	LAR65140100		1	✓		INVERTER 0,8 KW
	0C12	LA65210020	LAR65210020	3			FUSE CARRIER [C] 5X20
	0C13	LA65210050	LAR65210050	1			FUSE CARRIER [C] 6,3X32
	0C14	LA65280480	LAR65280480	1			FERRITE [C]
	0C15	LA65302990		1			KEYBOARD BOARD [C] VERTICAL 2 RELOADED
	0C16	LA65303010		1			ENCODER BOARD [C] VERTICAL S RELOADED
	0C17	LA65302680		1	✓		BUZZER BOARD [C] ICON 2015
	0C17	LA65302980		1			MAIN BOARD [C] S RELOADED
	0C18	LA65303230		1	✓		CAVO COLLEG.BASE-TASTIERA L=600

	0C19	LA65302260		1			EXPANSION BOAD [C] S 2009		
	0E10	LA65140910		3	✓		CONTACTOR [C] 3RT2025-1AL20		
	0E11	LA65180430		1	✓		TRANSFORMER [C] 40VA 0-220-240/12V		
	0E12	LA65060050	LAR65060050	3	✓		FAN [R] D. 120 4715MS 23T		
	0E13	LAR75300020		2			PLATE [C] FAN D. 120		
	0E14	LA65070350	LAR65070350	1			THERMOSTAT [C] 360Â°C-25K		EUROPA
	0E14	LA65070370		1	✓		THERMOSTAT [C] 360Â°C		USA
	0E15	LA65070380	LAR65070380	1	✓		THERMOSTAT [C] 150Â°C		USA
	0E15	LAR65070081		1			SECUR. THERMOSTAT 5532522852		EUROPA
	0E16	LA14424581		1			OUTER BOX AIR CONVEYOR		

	0E17	LA14441331		1				BOX [C] AIR CONVEYOR BACK PANEL T10 2016
	0E22	LA65180420		1	✓			TRANSFORMER [C] 20VA 0-220-240/12V
	0E22	LA65187260		1	✓	21/10/2019		BALLAST [C] LED APV-12-12
	0E23	LA65450211		1	✓			INDUCTOR [C] 27 mH 8A

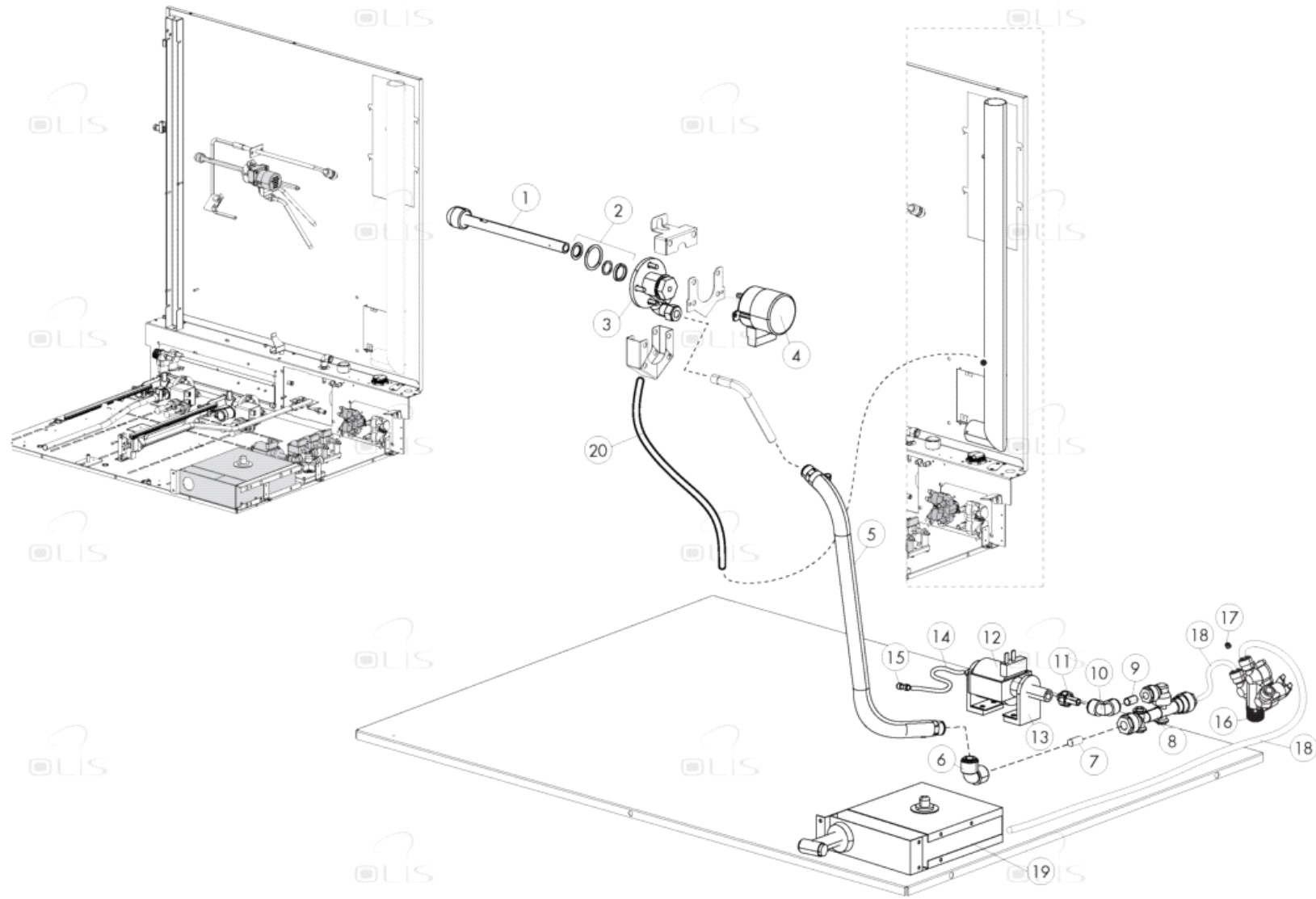











Photo	Pos	Code	Previous code	Quantity	Recommended	From	To	Description
	0001	LAR58007080		1				WASHING HEAD [C] L=160 (1/1)
	0002	LAR70045120		1	✓			GASKET
	0003	LAR58007020		1	✓			FLANGE [C] MOB WASHING
	0004	LA65090260	LAR65090260	1	✓			GEARMOTOR [C]
	0005	LA14170300		1				KIT DETERGENT WASHING PIPE [C] N/S071-101-072- 102
	0006	LA62090478	LAR62090478	1	✓			INTERMEDIATE CURVED CONNECTOR [C] D. 10
	0007	LA80150000		0,05				LIGHT BLUE POLYETHYL PIPE D. 10X7MM
	0008	LA62090888	LAR62090888	1	✓			MANIFOLD [C]
	0009	LA80150020	LAR80150020	0,04	✓			TRANSPARENT POLIURETHANE PIPE [C] D. 8X6MM

	0010	LA62090498	LAR62090498	1			INTERMEDIATE CURVED CONNECTOR [C] D. 8
	0011	LA62090608	LAR62090608	1	✓		END SIDE PIPE [C]
	0012	LAR65110600		1	✓		PUMP [C] WITH OSCILLATING PISTON
	0013	LA65110610		2			PUMP SUPPORT [C] ET500/8
	0014	LA80150020	LAR80150020	0,6	✓		TRANSPARENT POLIURETHANE PIPE [C] D. 8X6MM
	0015	LA62090878	LAR62090878	1			INTERMEDIATE STRAIGHT CONNECTOR [C] D. 8
	0016	LAR65110240		1	✓		SOLENOID VALVE [C] 220V 50HZ 3 OUTLETS JG CONNECTION
	0016	LAR65110360		1	✓		SOLENOID VALVE [C] 230V 50/60HZ 3 OUTLETS JG CONNECTION D. 10
	0016	LAR65110790		1	✓		SOLENOID VALVE [C] 230V 50/60HZ
	0018	LA80150000		1			LIGHT BLUE POLYETHYL PIPE D. 10X7MM

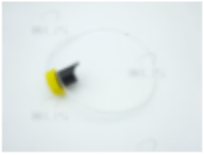
	0019	LA62200172	LAR62200172	1			SHOWER HEAD [C] N071/101/072/102 2014
	0020	LA80120060	LAR80120060	1			TRANSPARENT SILICONE PIPE [C] SR60/TR 7/12

Photo	Pos	Code	Previous code	Quantity	Recommended	From	To	Description
	0002	LA14171821		1				PIPE DECALCIFER TANK N/S101
	0003	LA14171791		1				PIPE DETERGENT TANK