



B-TRONIC

Typenreihe B 230
Serie B 230
Série B 230

Ersatzteilliste Spare parts list Liste de pièces détachées



Für Maschinen ab Bj. 04/1998 bis 01/2003
For machines manufactured in 04/1998 until 01/2003
Pour machines construites de 04/1998 à 01/2003

ERSATZTEILLISTE



SPARE PARTS LIST

LISTE DE PIECES DETACHEES

Typenreihe	B 230	gültig ab	04 / 1998
Type	B 230	valid from	04 / 1998
Série	B 230	valable à partir de	04 / 1998

*Bei Ersatzteilbestellung sind folgende Angaben erforderlich:
Following information should be stated in your spare parts orders:
Veuillez indiquer s.v.p. les informations suivantes dans vos commandes.*

Kunde/Betreff:
Customer/Ref.: _____
Client/Objet:

MEIKO-Auftragsnummer
MEIKO-Serial No.: _____
No. de série MEIKO:

Maschinentype:
Type of machine:: _____
Type de la machine:

Positions-Nr.:
Item No.: _____
Repère No.:

Benennung:
Denomination: _____
Dénomination:

Ersatzteilnummer:
Part No.: _____
Pièce No.:

Bei einigen Teilen sind zusätzliche Angaben nötig. Diese Teile sind in der Ersatzteilliste mit einem entsprechenden Hinweis versehen.

Some parts require more detailed information, these parts are especially stated in our list.

Il faut donner des informations supplémentaires pour quelques pièces.
Nous les avons munies de remarques spéciales.

ERSATZTEILLISTE



SPARE PARTS LIST

LISTE DE PIECES DETACHEES

Auf nachfolgenden Ersatzteilblättern finden Sie einige Bauteile (Pumpen, Spulen, Motoren und Heizungen), die nicht mit Ident Nummern angezogen sind.

Die dazugehörigen Id. Nummern finden Sie in der Stückliste des Elektroschaltplanes.

Aufschlüsselung des Anhanges zur Ident Nr:

01 = Arbeitsrichtung Links-Rechts

02 = Arbeitsrichtung Rechts-Links

03 = Ausführung Links

04 = Ausführung Rechts

L-R = Arbeitsrichtung Links-Rechts

R-L = Arbeitsrichtung Rechts-Links

On the enclosed spare parts sheets you can find some construction parts (Pumpen, Spulen, Motoren und Heizungen)

which do not have an identification number.

The corresponding ident numbers can be found in the parts list of the wiring diagram

Details of the enclosure:

01 = working direction left-right

02 = working direction right-left

03 = execution left

04 = execution right

L-R = working direction left-right

R-L = working direction right-left

Sur les fiches des pièces détachées en annexe vous trouverez quelques pièces de construction (Pumpen, Spulen, Motoren und Heizungen)

sans numéro d'identification.

Vous trouverez les numéros correspondants dans la liste de pièces du schéma de connexions.

Détails de l'annexe du numéro d'identification:

01 = sens de travail gauche-droite

02 = sens de travail droite-gauche

03 = exécution gauche

04 = exécution droite

L-R = sens de travail gauche-droite

R-L = sens de travail droite-gauche

Kennzeichnung der Ersatzteile:

* / V Diese Teile empfehlen wir auf Lager zu legen!

V = Verschleißteil!

Special marks of spares:

* / V We recommend to store these parts!

V = wear and tare part!

Marquage speciales des pieces:

* / V Nous recommandons de prendre ces pièces en stock!

V = pièce d'usure!

ERSATZTEILLISTE

SPARE PARTS LIST

LISTE DE PIECES DETACHEES

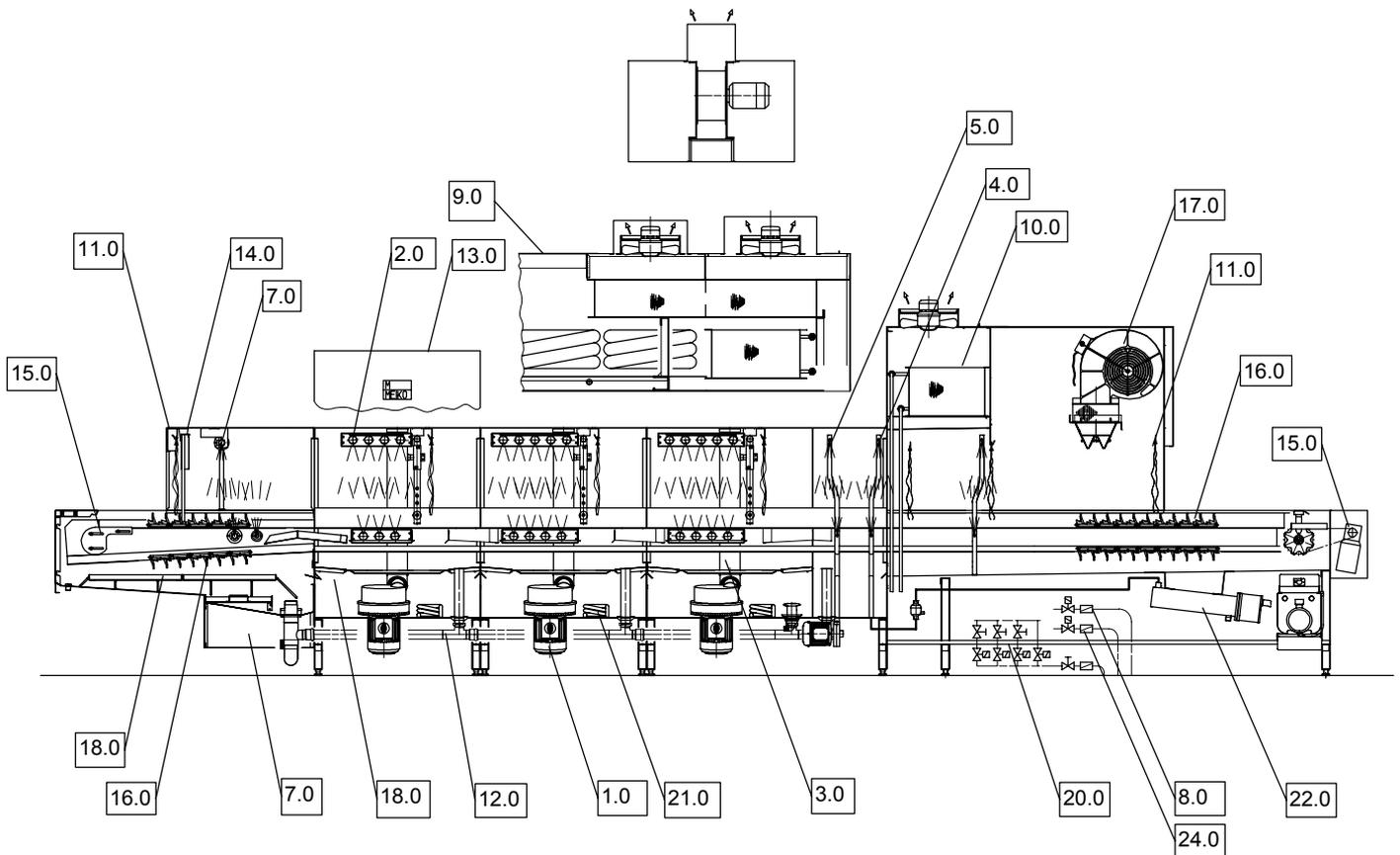

23.0 Zubehör / accesories / accessoires

Schnittbild einer B-tronic - Maschine.

Sectional drawing of a B-tronic - machine.

Coupe d'une machine B-tronic.

INHALTSVERZEICHNIS		CONTENTS		SOMMAIRE	
1.0	WASCHPUMPE	WASH PUMP		POMPE DE LAVAGE	
1.1	WASCHPUMPE 0,55KW	WASH PUMP 0,55KW		POMPE DE LAVAGE 0,55KW	
1.2	WASCHPUMPE 1,7KW	WASH PUMP 1,7KW		POMPE DE LAVAGE 1,7KW	
1.3	WASCHPUMPE 2,2KW	WASH PUMP 2,2KW		POMPE DE LAVAGE 2,2KW	
1.3.1	WASCHPUMPE 2,2KW	WASH PUMP 2,2KW		POMPE DE LAVAGE 2,2KW	
1.4	WASCHPUMPE 4KW	WASH PUMP 4KW		POMPE DE LAVAGE 4KW	
1.5	WASCHPUMPE 2,2KW / 4KW	WASH PUMP 2,2KW / 4KW		POMPE DE LAVAGE 2,2KW / 4KW	
2.0	WASCHSYSTEM	WASH SYSTEM		SYSTEME DE LAVAGE	
2.1	WASCHSYSTEM, 3 ARME OBEN	WASH SYSTEM, 3 WASH ARMS ABOVE		SYSTEME DE LAVAGE, 3 BRAS DE LAVAGE EN HAUT	
2.2	WASCHSYSTEM, 4 ARME OBEN	WASH SYSTEM, 4 WASH ARMS ABOVE		SYSTEME DE LAVAGE, 4 BRAS DE LAVAGE EN HAUT	
2.3	WASCHSYSTEM, 5 ARME OBEN	WASH SYSTEM, 5 WASH ARMS ABOVE		SYSTEME DE LAVAGE, 5 BRAS DE LAVAGE EN HAUT	
2.4	WASCHSYSTEM, 6 ARME OBEN	WASH SYSTEM, 6 WASH ARMS ABOVE		SYSTEME DE LAVAGE, 6 BRAS DE LAVAGE EN HAUT	
2.5	SEITLICHES WASCHSYSTEM	LATERAL WASH SYSTEM		SYSTEME DE LAVAGE LATERAL	
2.5.1	SEITLICHES WASCHSYSTEM	LATERAL WASH SYSTEM		SYSTEME DE LAVAGE LATERAL	
3.0	STEIGROHR	ASCENDING PIPE		CONDUITE ASCENDANTE	
3.1	STEIGROHR KPL., 0,55KW	ASCENDING PIPE CPL., 0,55KW		CONDUITE ASCENDANTE CPL., 0,55KW	
3.2	STEIGROHR, 2,2KW / 4,0KW	ASCENDING PIPE, 2,2KW / 4,0KW		CONDUITE ASCENDANTE, 2,2KW / 4,0KW	
4.0	FRISCHWASSERKLARSPÜLUNG	FRESH WATER FINAL RINSE		RINCAGE FINAL A EAU CLAIRE	
4.1	FRISCHWASSERKLARSPÜLUNG, STANDARD	FRESH WATER FINAL RINSE, STANDARD		RINCAGE FINAL A L'EAU CLAIRE, STANDARD	
4.2	FRISCHWASSERNETZTRENNUNG	FRESH WATER MAINS ISOLATING DEVICE		DIPOSITIF DE SEPERATION DU RESEAU I EAU	
4.3	NETZMITTELMISCHBEHÄLTER	RINSE-AID MIXING CHAMBER		RESERVOIR DE MELANGE DE PRODUIT DE RINCAGE	
4.4	FRISCHWASSERKLARSPÜLUNG, VERSETZT	FRESH WATER FINAL RINSE, DISPLACED		RINCAGE FINAL A L'EAU CLAIRE, DEPLACE	
4.5	FRISCHWASSERKLARSPÜLUNG	FRESH WATER FINAL RINSE		RINCAGE FINAL A L'EAU CLAIRE	
4.6	FRISCHWASSERKLARSPÜLUNG, VERSETZT	FRESH WATER FINAL RINSE, DISPLACED		RINCAGE FINAL A L'EAU CLAIRE, DEPLACE	

INHALTSVERZEICHNIS		CONTENTS	SOMMAIRE
5.0	PUMPENKLARSPÜLUNG	PUMP FINAL RINSE	RINCAGE FINAL A POMPE
5.1	PUMPENKLARSPÜLUNG, SPRÜHSYSTEM	PUMP FINAL RINSE, SPRAYING SYSTEM	RINCAGE FINAL A POMPE, SYSTEME D'ARROSAGE
5.2	PUMPENKLARSPÜLUNG, PUMPENANSAUGUNG	PUMP FINAL RINSE, INDUCTION OF PUMP	RINCAGE FINAL A POMPE, ASPIRATION DE POMPE
5.3	PUMPENKLARSPÜLUNG, SPRÜHSYSTEM, DOPPELTE KLARSPÜLARME	PUMP FINAL RINSE, SPRAYING SYSTEM , DOUBLE RINSE ARMS	RINCAGE FINAL A POMPE, SYSTEME D'ARROSAGE, DOUBLE BRAS DE RINCAGE
5.4	PUMPENKLARSPÜLUNG, SPRÜHSYSTEM	PUMP FINAL RINSE, SPRAYING SYSTEM	RINCAGE FINAL A POMPE, SYSTEME D'ARROSAGE
6.0	DEMIKLARSPÜLUNG	DEMI FINAL RINSE	RINCAGE FINAL A DEMI
6.1	DEMIKLARSPÜLUNG, VERSETZT	DEMI FINAL RINSE, DISPALED	RINCAGE FINAL A L'EAU DEMINERALISEE, DEPLACE
7.0	CHEMIESPARSYSTEM	CSS-SYSTEM	SYSTEME-CSS
7.1	CSS SPRÜHSYSTEM	CSS SPRAYING SYSTEM	CSS SYSTEME D' ARROSAGE
7.2	CSS TOP SPRÜHSYSTEM OBEN	CSS TOP SPRAYING SYSTEM ABOVE	CSS TOP SYSTEME D' ARROSAGE EN HAUT
7.3	PUMPENVERROHRUNG CSS CLASSIC	PIPEWORK FOR CSS CLASSIC	TUYAUTERIE DE CSS CLASSIC
7.4	PUMPENVERROHRUNG CSS TOP	PIPEWORK FOR CSS TOP	TUYAUTERIE DE CSS TOP
7.5	ANSAUGSYSTEM, ABLAUF	SUCTION SYSTEM, DRAIN	SYSTEME D' ASPIRATION, VIDANGE
7.6	CSS CLASSIC	CSS CLASSIC	CSS CLASSIC
7.7	CSS BASIC	CSS BASIC	CSS BASIC
7.8	CSS BASIC	CSS BASIC	CSS BASIC
7.9	CSS TOP SPRÜHSYSTEM UNTEN	CSS TOP LOWER SPRAYING SYSTEM	CSS TOP SYSTEME D'ARROSAGE INFERIEUR
8.0	FRISCHWASSERINSTALLATION	FRESH WATER INSTALLATION	INSTALLATION A EAU CLAIRE
8.1	DRUCKMINDERER	PRESSURE REDUCING VALVE	REDUCTEUR DE PRESSION
8.2	DURCHFLUSSMESSER	FLOW CONTROL	DEBIT METRE
8.3	DURCHFLUSSWÄCHTER	FLOW CONTROL INSTRUMENT	CONTROLEUR DE DEBIT
8.4	ÜBEDRUCKVENTIL	OVER PRESSURE VALVE	SOUPAPE DE SURPRESSION
9.0	WÄRMEPUMPE	HEAT PUMP	POMPE A CHALEUR
9.1	AXIALGEBLÄSE FÜR WÄRMEPUMPE	AXIAL FAN FOR HEATPUMP	VENTILATEUR AXIAL POUR POMPE A CHALEUR
9.2	UMWÄLZPUMPE FÜR WÄRMEPUMPE	CIRCULATING PUMP FOR HEATPUMP	POMPE DE CIRCULATION POUR POMPE A CHALEUR

INHALTSVERZEICHNIS		CONTENTS	SOMMAIRE
10.0	WÄRMERÜCKGEWINNUNG	HEAT RECOVERY	RECUPERATION
10.1	AXIALGEBLÄSE FÜR WÄRMERÜCKGEWINNUNG	AXIAL FAN FOR HEAT RECOVERY	VENTILATEUR AXIAL POUR RECUPERATION
10.2	WÄRMETAUSCHER	HEAT EXCHANGER	ECHANGEUR DE CHALEUR
10.3	STEIGLEITUNG	ASCENDING PIPE	CONDUITE ASCENDANTE
11.0	VORHÄNGE	CURTAIN	RIDEAU
11.1.1	VORHÄNGE	CURTAIN	RIDEAU
12.0	ABLAUF	DRAIN	VIDANGE
12.1	ABLAUFROHRVERBINDUNG	DRAINPIPE CONNECTION	CONNEXION DE TUYAU DE VIDANGE
12.2	ABLAUFVERROHRUNG	PIPEWORK FOR DRAIN	TUYAUTERIE DE VIDANGE
12.3	ABLAUFVERROHRUNG	PIPEWORK FOR DRAIN	TUYAUTERIE DE VIDANGE
12.4	ABLAUFVERROHRUNG EINLAUF	PIPEWORK FOR DRAIN-INFEED	TUYAUTERIE DE VIDANGE-ENTREE
12.5	ABLAUFSIFON	SIPHON	SIPHON
12.6	TANKABLAUF, PUMPE	DRAIN, PUMP	VIDANGE, POMPE
12.6.1	TANKABLAUF, PUMPE	DRAIN, PUMP	VIDANGE, POMPE
12.7	TANKABLAUF, STANDROHR	TANK DRAIN, STAND PIPE	VIDANGE DE BAC, TUYAU DE VIDANGE
13.0	SCHIEBETÜR	SLIDING DOOR	PORTES COULISSANTES
13.1	SCHIEBETÜR 600	SLIDING DOOR 600	PORTES COULISSANTES 600
13.2	SCHIEBETÜR 900	SLIDING DOOR 900	PORTES COULISSANTES 900
13.3	SCHIEBETÜR 1300	SLIDING DOOR 1300	PORTES COULISSANTES 1300
14.0	TAKTSCHALTUNG	INTERVAL SWITCH	INTERRUPT. DE SYNCHRONISATION
14.1	TAKTSCHALTUNG	INTERVAL SWITCH	INTERRUPT. DE SYNCHRONISATION
14.1.1	TAKTSCHALTUNG	INTERVAL SWITCH	INTERRUPT. DE SYNCHRONISATION
14.1.2	TAKTSCHALTUNG	INTERVAL SWITCH	INTERRUPT. DE SYNCHRONISATION
15.0	BANDTRANSPORT	BELT TRANSPORT	TRANSPORT DE BANDE
15.1	UMLENKUNG	REVERSE	RENVOI
15.2	BANDANTRIEB DREHSTROM	BELT DRIVE 3-PHASE CURRENT	ENTRAINEMENT DE CONVOYEUR TRI-PHASE
15.3	BANDANTRIEB GLEICHSTROM	BELT DRIVE DIRECT CURRENT	ENTRAINEMENT DE CONVOYEUR COURANT CONTINU
15.4	KETTENSANNUNG DREHSTROM	CHAIN TENSION 3-PHASE CURRENT	TENSION DE CHAINE TRI-PHASE
15.5	KETTENSANNUNG GLEICHSTROM	CHAIN TENSION DIRECT CURRENT	TENSION DE CHAINE COURANT CONTINU
15.6	BANDENDSCHALTER	FINAL SWITCH FOR BELT	INTERRUPTEUR FINAL POUR BANDE

INHALTSVERZEICHNIS		CONTENTS	SOMMAIRE
16.0	TRANSPORTBÄNDER	TRANSPORT BELTS	TRANSPORT DE BANDES
16.1	MASCHINENTRANSPORTBAND TEILUNG 108MM	CONVEYOR BELT DIVISION 108MM	CONVOYEUR DE TRANSPORT DIVISION 108MM
16.2	MASCHINENTRANSPORTBAND TEILUNG 60MM	CONVEYOR BELT DIVISION 60MM	CONVOYEUR DE TRANSPORT DIVISION 60MM
16.3	MASCHINENTRANSPORTBAND	CONVEYOR BELT	CONVOYEUR DE TRANSPORT
17.0	TROCKNUNG	DRYING	SECHAGE
17.1	TROCKNUNG	DRYING	SECHAGE
17.2	HEIZKÖRPER, TROCKNUNG	HEATING ELEMENT, DRYING	RESISTANCE, SECHAGE
17.3	TROCKNUNGSGEBLÄSE	DRYING FAN	VENTILATEUR DE SECHAGE
17.4	TROCKNUNGSHEIZREGISTER	HEATING REGISTER	REGISTRE DE CHAUFFAGE
18.0	SIEBE	SIEVE	TAMIS
18.1	EINLAUFSIEBSYSTEM	INFEED SIEVE SYSTEM	SYSTEME DE TAMIS ENTREE
18.2	TANKABDECKSIEBSYSTEM	TANK COVERING SIEVE SYSTEM	SYSTEME DE TAMIS DE RECouvreMENT
20.0	BEHEIZUNGSINSTALLATION	HEATING INSTALLATION	INSTALLATION DE CHAUFFAGE
20.1	TANK EXTERNE THERMOSTATREGELUNG	EXTERNAL TANK THERMOSTAT REGULATION	REGULATION DE THERMOSTAT EXTERNE DE BAC
20.2	MAGNETVENTIL	SOLENOID VALVE	ELECTROVANNE
20.3	MAGNETVENTIL	SOLENOID VALVE	ELECTROVANNE
20.4	MAGNETVENTIL	SOLENOID VALVE	ELECTROVANNE
20.5	MAGNETVENTIL	SOLENOID VALVE	ELECTROVANNE
20.6	MAGNETVENTIL	SOLENOID VALVE	ELECTROVANNE
20.7	MAGNETVENTIL	SOLENOID VALVE	ELECTROVANNE
20.8	VORSTEUERVENTIL	PILOT VALVE	VANNE DE PILOTE
20.9	KONDENSATABLEITER	STEAM TRAP	SEPARATURE DE VAPEUR
20.10	KONDENSATABLEITER	STEAM TRAP	SEPARATURE DE VAPEUR
21.0	TANKHEIZUNG	TANK HEATING ELEMENT	RESISTANCE DU BAC
21.1	TANKHEIZUNG, ELEKTRISCH	TANK HEATING ELEMENT, ELECTRICAL	RESISTANCE DU BAC, ELECTRIQUE
21.2.1	TANKHEIZUNG DAMPF, PHW GESCHRAUBT	TANK HEATING STEAM, PUMP HOT WATER SCREWED	RESISTANCE DU BAC VAPEUR, EAU CHAUDE A POMPE VISEE
21.3	TANKHEIZUNG DAMPF, PHW GEFLANSCHT	TANK HEATING STEAM, PUMP HOT WATER FLANGED	RESISTANCE DU BAC VAPEUR, EAU CHAUDE A POMPE BRIDEE

INHALTSVERZEICHNIS		CONTENTS	SOMMAIRE
22.0	DURCHLAUFWASSERERWÄRMER / BOILER	BOOSTER HEATER / BOILER	SURCHAUFFEUR POUR EAU / SURCHAUFFEUR
22.1	DURCHLAUFWASSERERWÄRMER ELT., ELEKTRONIKREG	BOILER ELT., ELECTRONICALLY CONTROLLED	SURCHAUFFEUR ELT., A CONTROLE ELECTRONIQUE
22.2	DURCHLAUFWASSERERWÄRMER ELT., EXTERNE THERMOSTATREGELUNG	BOILER ELT., EXTERNAL THERMOSTAT REGULATION	SURCHAUFFEUR ELT., AVEC REGULATION THERMOSTAT EXTERNE
22.3	DURCHLAUFWASSERERWÄRMER DAMPF, PHW	BOILER STEAM, PUMP HOT WATER	SURCHAUFFEUR VAPEUR, EAU CHAUDE A POMPE
22.4.1	BOILER ELT., ELEKTRONIKREGELUNG	BOILER ELT., ELECTRONICALLY CONTROLLED	SURCHAUFFEUR ELT., A CONTROLE ELECTRONIQUE
22.5.1	BOILER ELT., EXTERNE THERMOSTATREGELUNG	BOILER ELT., EXTERNAL THERMOSTAT REGULATION	SURCHAUFFEUR ELT., AVEC REGULATION THERMOSTAT EXTERNE
22.6	PLATTENWÄRMETAUSCHER, HEISSWASSER	HEAT EXCHANGER PLATE SHAPED, HOT WATER	EXCHANGEUR DE CHALEUR A PLAQUES, EAU CHAUDE
23.0	ZUBEHÖR	ACCESSORIES	ACCESSOIRES
23.1	RADIALGEBLÄSE	RADIAL FAN	VENTILATEUR RADIAL
23.2.1	WASSERUMGEHUNG FÜR STÄRKELÖSEPROGRAMM	WATER BY-PASS FOR STARCH REMOVING PROGRAMME	DEVIATION D' EAU POUR PROGRAMME A ENLEVER L'AMIDON
23.3.1	MASCHINENSTOLLEN	FEET OF MACHINE	PIEDS DE MACHINE
23.4	ROHRABDICHTUNG	TUBE PACKING	JOINT DE TUYAU
23.5	SCHWIMMERSCHALTER	FLOAT SWITCH	FLOTTEUR POUR NIVEAU DE BAC
23.6	NIVEAUREGELUNG	LEVEL CONTROL	REGULATION DE NIVEAU
23.7	WRASENABDICHTUNG FÜR TRANSPORTBAND	VAPEUR SEALING FOR TRANSPORT CONVEYOR	JOINT DE BUEES POUR CONVOYEUR DE TRANSPORT
23.8	FROSTSCHUTZWÄCHTER	FROST PROTECTION	PROTECTEUR ANTI-GEL
23.9	ABWASSERLEITUNG FÜR UMKEHROSMOSEANLAGE	WASTE WATER PIPE FOR REVERSE OSMOSIS INSTALLATION	CONDUITE D'EAU USEE POUR INSTALLATION OSMOSE INVERSEE
23.10	KLAPPENSCHALTER IM EINLAUFTUNNEL	FLAP SWITCH IN THE FEEDING TUNNEL	INTERRUPTEUR A CLAPET DANS LE TUNNEL D'ENTREE
23.10.1	KLAPPENSCHALTER IM EINLAUFTUNNEL	FLAP SWITCH IN THE FEEDING TUNNEL	INTERRUPTEUR A CLAPET DANS LE TUNNEL D'ENTREE
23.11	KABELFÜHRUNG IM EINLAUFTUNNEL	CABLE CHANNEL IN THE FEEDING TUNNEL	GUIDAGE DE CABLE DANS LE TUNNEL D'ENTREE
23.12	DRUCKSTEIGERUNGSPUMPE	BOOSTER PUMP	SURPRESSEUR
24.0	FÜLLUNG	FILLING	REPLISSAGE
24.1.1	FÜLLEITUNG IN P TANK	FILLING PIPE INTO P-TANK, PUMP FINAL RINSE	TUYAU DE REPLISSAGE POUR BAC P, RINCAGE FINAL A POMPE
24.2.1	FÜLLEITUNG IN KWZ TANK	FILLING PIPE INTO KWZ TANK, FINAL RINSE TANK	TUYAU DE REPLISSAGE POUR BAC KWZ, BAC DE RINCAGE FINAL

1.1 WASCHPUMPE 0,55KW



1.1 WASH PUMP 0,55KW

1.1 POMPE DE LAVAGE 0,55KW

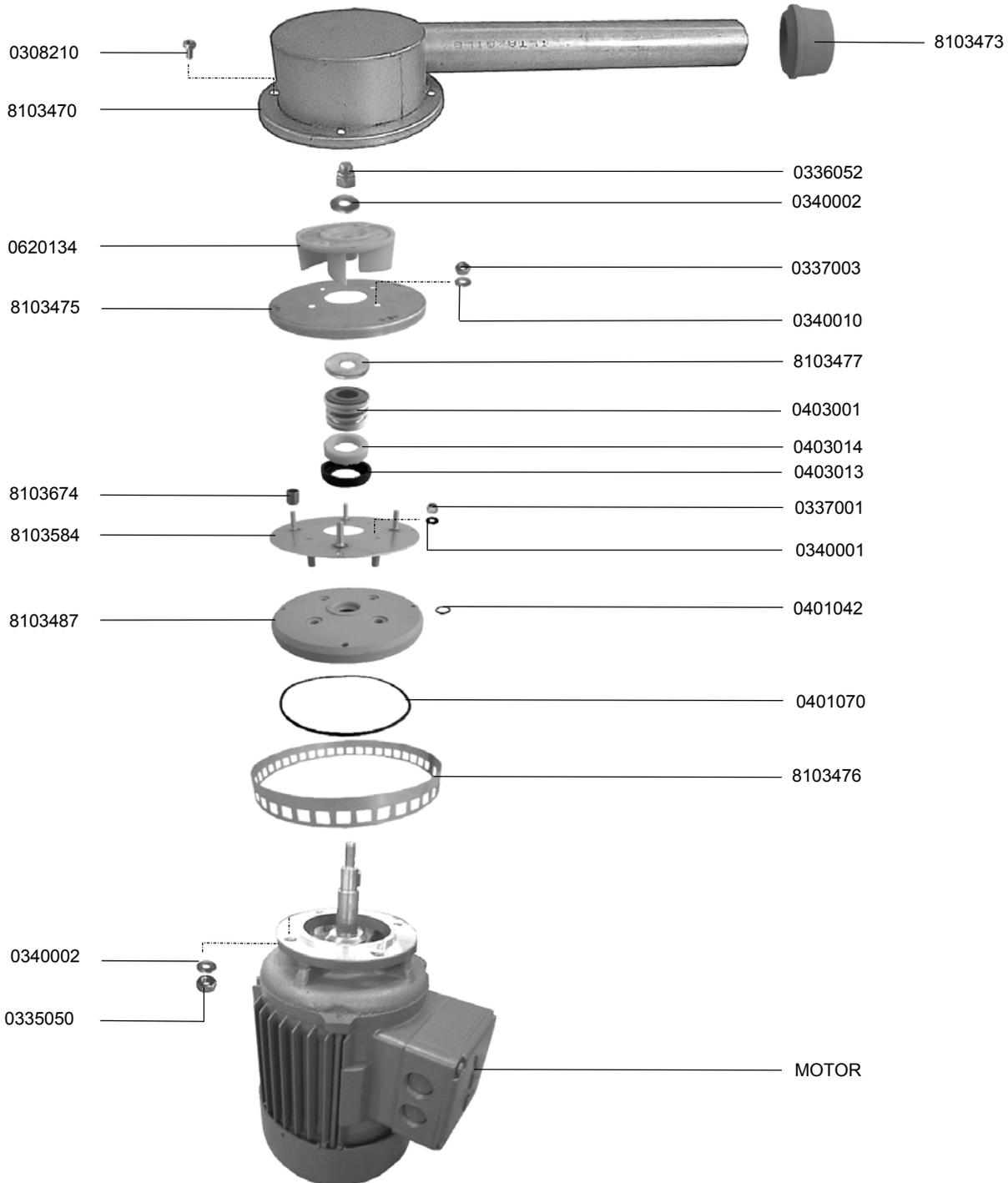

1.1 WASCHPUMPE 0,55KW



1.1 WASH PUMP 0,55KW

1.1 POMPE DE LAVAGE 0,55KW

IDENT.-NR. IDENT.-NO.	BEZEICHNUNG	DESIGNATION	DESIGNATION
8103473	ADAPTER	ADAPTER	ADAPTEUR
0336052	HUTMUTTER M8	NUT M8	ECROU M8
0340002	SCHEIBE	DISK	DISQUE
0337003	MUTTER M6	NUT M6	ECROU M6
0340010	SCHEIBE	DISK	DISQUE
8103477	SCHEIBE	DISK	DISQUE
V 0403001	GLEITRINGDICHTUNG 15X30 EPDM	SLIDING SEAL 15X30 EPDM	JOINT AXIAL 15X30 EPDM
V 0403014	GLEITRING SPR-E23 KERAMIK 15X25X6	SLIDING RING CERAMICS 15X25X6	BAGUE CERAMICS 15X25X6
V 0403013	GLEITR.-MANSCHETTE WINKEL 17X27X5 EPDM	ANGLE COLLAR 17X27X5 EPDM	MANCHETTE EN ANGLE 17X27X5 EPDM
0337001	MUTTER M5	NUT M5	ECROU M5
0340001	SCHEIBE	DISK	DISQUE
0401042	O-RING	O-RING	BAGUE
* 0401070	O-RING	O-RING	BAGUE
8103476	ANSAUGSIEB	SUCTION SIEVE	FILTRE DE ASPIRATION
MOTOR	SIEHE ELEKTROSCHALTPLAN	SEE ELECTRIC WIRING DIAGRAM	VOIR SCHEMA ELECTRIQUE
0335050	MUTTER M8	NUT M8	ECROU M8
8103487	TRÄGER	SUPPORT	SUPPORT
8103584	MOTORTRÄGER	MOTOR SUPPORT	SUPPORT DE MOTEUR
8103674	DISTANZHÜLSE	SPACER	DOVILLE DE ECARTEMENT
8103475	PUMPENBODEN KOMPL. 0,55KW	PUMP BASE CPL. 0,55KW	READY FOND DE POMPE CPL. 0,55KW
* 0620134	PUMPENRAD K134	IMPELLER K134	ROUE DE POMPE K134
8103470	PUMPENDECKEL	PUMP LID	COUVERCLE DE POMPE
0308210	SCHRAUBE M6X10	SCREW M6X10	VIS M6X10

1.2 WASCHPUMPE 1,7KW



1.2 WASH PUMP 1,7KW

1.2 POMPE DE LAVAGE 1,7KW

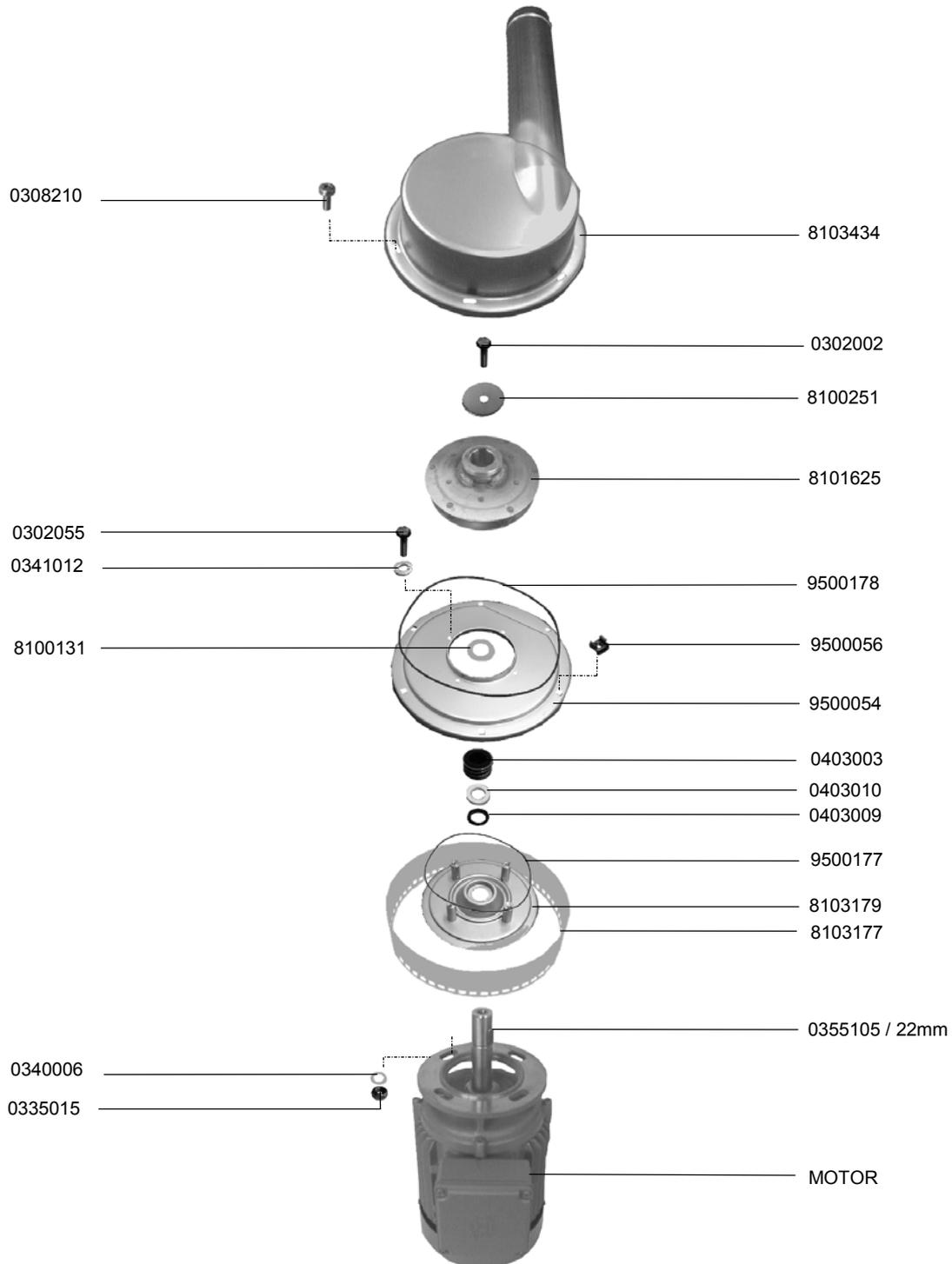

1.2 WASCHPUMPE 1,7KW



1.2 WASH PUMP 1,7KW

1.2 POMPE DE LAVAGE 1,7KW

IDENT.-NR. IDENT.-NO.	BEZEICHNUNG	DESIGNATION	DESIGNATION
8103434	PUMPENDECKEL KOMPL.	PUMP LID CPL.	COUVERCLE DE POMPE CPL.
0302002	SKT.-SCHRAUBE M6X20	HEXAGON SCREW M6X20	VIS A 6 PANS M6X20
8100251	U-SCHEIBE Ø34XØ7X2	FRONT DISC Ø34XØ7X2	RONDELLE Ø34XØ7X2
* 8101625	PUMPENRAD 1,7KW Ø120X49	IMPELLER 1,7KW Ø120X49	ROUE DE POMPE 1,7KW Ø120X49
* 9500178	RUNDDICHTRING 70°	GASKET 70°	JOINT 70°
9500056	KÄFIGMUTTER M6 1,2-1,6MM	NUT M6 1,2-1,6MM	ECROU M6 1,2-1,6MM
9500054	PUMPENBODEN	PUMP BASE	FOND DE POMPE
V 0403003	GLEITRINGDICHTUNG VITON 25X44X20	SLIDING SEAL 25X44X20	JOINT AXIAL 25X44X20
V 0403010	GLEITRING KERAMIK 25,9X38X8	SLIDING SEAL CERAMICS 25,9X38X8	JOINT AXIAL CERAMIQUE 25,9X38X8
V 0403009	GLEITR.-MANSCHETTE WINKEL 30X40X7	COLLAR PERBUNAN 30X40X7	MANCHETTE PEBUNAN 30X40X7
* 9500177	RUNDDICHTRING 70°	GASKET 70°	JOINT 70°
8103179	MOTORTRÄGER	MOTOR SUPPORT	SUPPORT DE MOTEUR
8103177	ANSAUGSIEB	SUCTION SIEVE	FILTRE D'ASPIRATION
* 0355105	PASSFEDER A 8X7X22	FEATHER KEY A 8X7X22	RESSORT D'AJUSTAGE A 8X7X22
MOTOR	SIEHE ELEKTROSCHALTPLAN	SEE ELECTRIC WIRING DIAGRAM	VOIR SCHEMA ELECRIQUE
0335015	SKT.-MUTTER M8	HEXAGON NUT M8	ECROU A 6 PANS M8
0340006	U-SCHEIBE MS. VERN. Ø18XØ8,4X2	WASHER BRASS NICKELLED Ø18XØ8,4X2	RONDELLE EN LAITON NICKELE Ø18XØ8,4X2
8100131	U-SCHEIBE Ø38XØ24,1X1	SUPPORT DISC Ø38XØ24X1	RONDELLE Ø38XØ24X1
0341012	FEDERRING 6MM	SPRING RING 6MM	RESSORT 6MM
0302055	SKT.-SCHRAUBE M6X12	HEXAGON SCREW M6X12	VIS A 6 PANS M6X12
0308210	SCHRAUBE M6X10	SCREW M6X10	VIS M6X15

1.3 WASCHPUMPE 2,2KW



1.3 WASH PUMP 2,2KW

1.3 POMPE DE LAVAGE 2,2KW

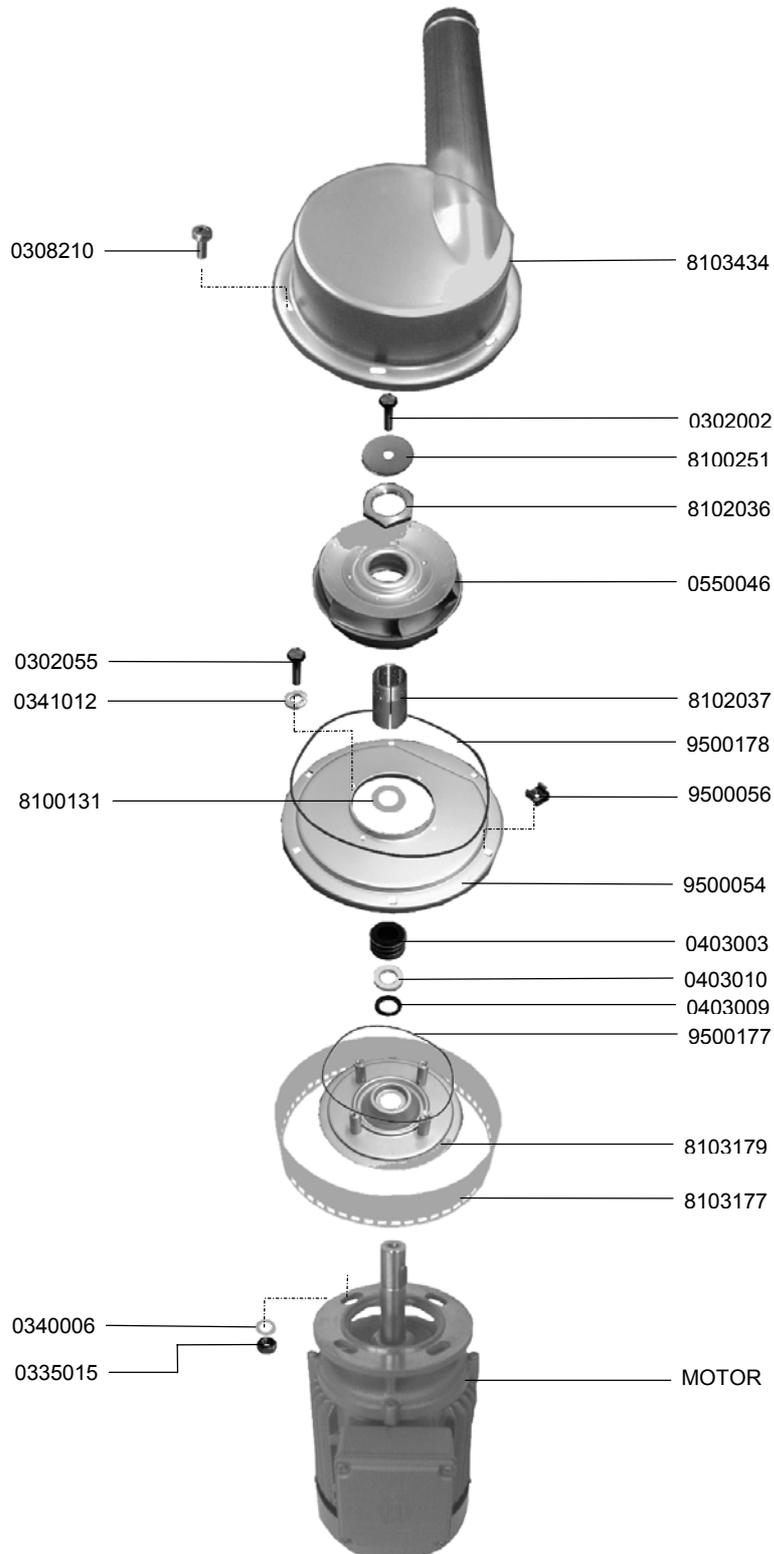

1.3 WASCHPUMPE 2,2KW



1.3 WASH PUMP 2,2KW

1.3 POMPE DE LAVAGE 2,2KW

IDENT.-NR. IDENT.-NO.	BEZEICHNUNG	DESIGNATION	DESIGNATION
8103434	PUMPENDECKEL KOMPL.	PUMP LID CPL.	COUVERCLE DE POMPE CPL.
0302002	SKT.-SCHRAUBE M6X20	HEXAGON SCREW M6X20	VIS A 6 PANS M6X20
8100251	U-SCHEIBE Ø34XØ7X2	FRONT DISC Ø34XØ7X2	RONDELLE Ø34XØ7X2
8102036	SKT.MUTTER M30X1,5	HEXAGON NUT M30X1,5	ECROU A 6 PANS M30X1,5
* 0550046	PUMPENRAD 2,2KW	IMPELLER 2,2KW	ROUE DE POMPE 2,2KW
8102037	BÜCHSE	BUSHING	DOUILLE
* 9500178	RUNDDICHTRING 70°	GASKET 70°	JOINT 70°
9500056	KÄFIGMUTTER M6 1,2-1,6MM	NUT M6 1,2-1,6MM	ECROU M6 1,2-1,6MM
9500054	PUMPENBODEN	PUMP BASE	FOND DE POMPE
V 0403003	GLEITRINGDICHTUNG VITON 25X44X20	SLIDING SEAL 25X44X20	JOINT AXIAL 25X44X20
V 0403010	GLEITRING KERAMIK 25,9X38X8	SLIDING SEAL CERAMICS 25,9X38X8	JOINT AXIAL CERAMIQUE 25,9X38X8
V 0403009	GLEITR.-MANSCHETTE WINKEL 30X40X7	COLLAR PERBUNAN 30X40X7	MANCHETTE PEBUNAN 30X40X7
* 9500177	RUNDDICHTRING 70°	GASKET 70°	JOINT 70°
8103179	MOTORTRÄGER	MOTOR SUPPORT	SUPPORT DE MOTEUR
8103177	ANSAUGSIEB	SUCTION SIEVE	FILTRE D'ASPIRATION
MOTOR	SIEHE ELEKTROSCHALTPLAN	SEE ELECTRIC DIAGRAM	VOIR SCHEMA ELECTRIQUE
0335015	SKT.-MUTTER M8	HEXAGON NUT M8	ECROU A 6 PANS M8
0340006	U-SCHEIBE MS. VERN. Ø18XØ8,4X2	WASHER BRASS NICKELED Ø18XØ8,4X2	RONDELLE EN LAITON NICKELE Ø18XØ8,4X2
8100131	U-SCHEIBE Ø38XØ24,1X1	SUPPORT DISC Ø38XØ24X1	RONDELLE Ø38XØ24X1
0341012	FEDERRING 6MM	SPRING RING 6MM	RESSORT 6MM
0302055	SKT.-SCHRAUBE M6X12	HEXAGON SCREW M6X12	VIS A 6 PANS M6X12
0308210	SCHRAUBE M6X10	SCREW M6X10	VIS M6X15

1.3.1 WASCHPUMPE 2,2KW



1.3.1 WASH PUMP 2,2KW

1.3.1 POMPE DE LAVAGE 2,2KW

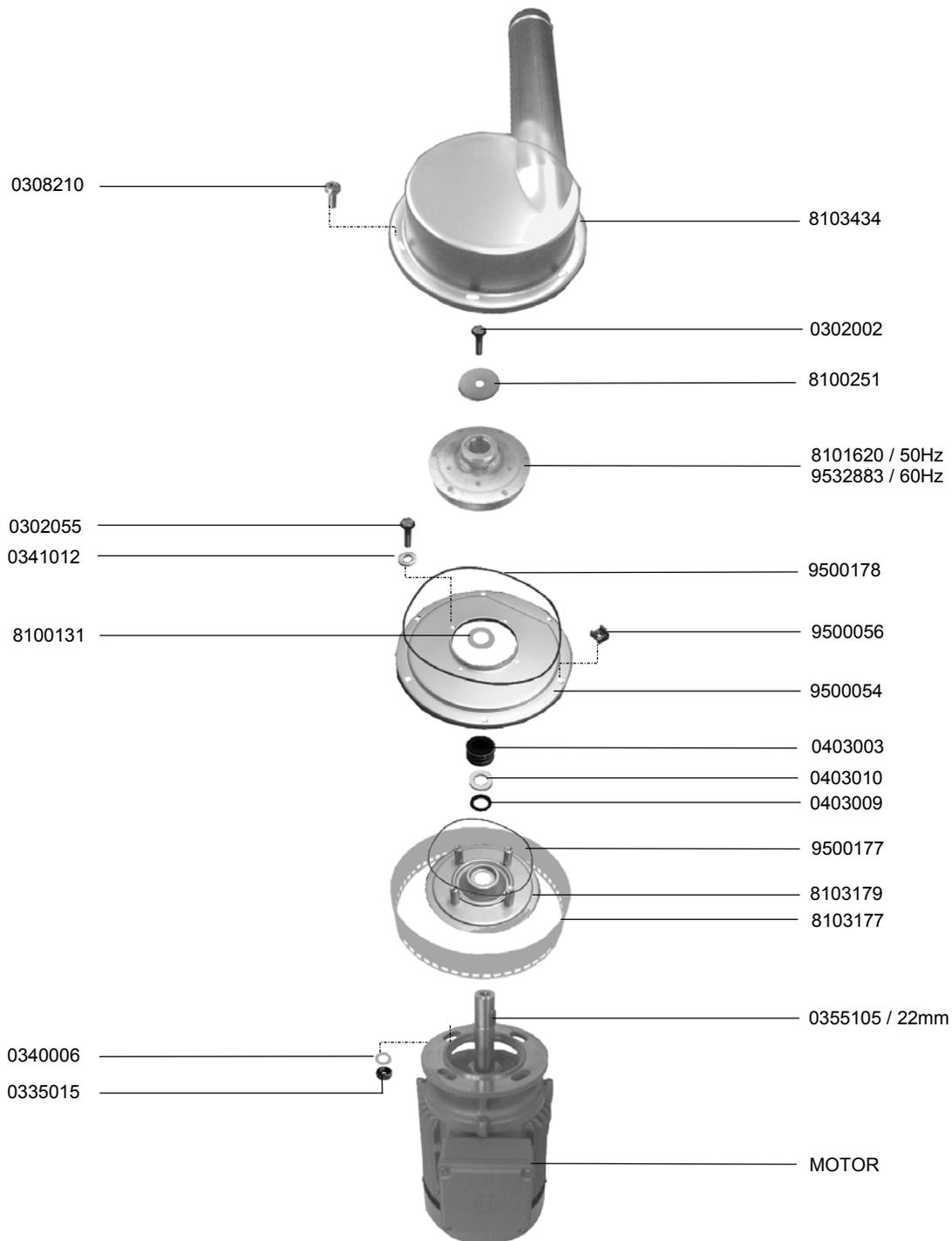

1.3.1 WASCHPUMPE 2,2KW



1.3.1 WASH PUMP 2,2KW

1.3.1 POMPE DE LAVAGE 2,2KW

IDENT.-NR. IDENT.-NO.	BEZEICHNUNG	DESIGNATION	DESIGNATION
8103434	PUMPENDECKEL KOMPL.	PUMP LID CPL.	COUVERCLE DE POMPE CPL.
0302002	SKT.-SCHRAUBE M6X20	HEXAGON SCREW M6X20	VIS A 6 PANS M6X20
8100251	U-SCHEIBE Ø34XØ7X2	FRONT DISC Ø34XØ7X2	RONDELLE Ø34XØ7X2
* 8101620	PUMPENRAD 1,7KW 50HZ Ø120X49	IMPELLER 1,7KW 50HZ Ø120X49	ROUE DE POMPE 1,7KW 50HZ Ø120X49
* 9532883	PUMPENRAD 1,7KW 60HZ Ø108X49	IMPELLER 1,7KW 60HZ Ø108X49	ROUE DE POMPE 1,7KW 60HZ Ø108X49
* 9500178	RUNDDICHTRING 70°	GASKET 70°	JOINT 70°
9500056	KÄFIGMUTTER M6 1,2-1,6MM	NUT M6 1,2-1,6MM	ECROU M6 1,2-1,6MM
9500054	PUMPENBODEN	PUMP BASE	FOND DE POMPE
V 0403003	GLEITRINGDICHTUNG VITON 25X44X20	SLIDING SEAL 25X44X20	JOINT AXIAL 25X44X20
V 0403010	GLEITRING KERAMIK 25,9X38X8	SLIDING SEAL CERAMICS 25X38X8	JOINT AXIAL CERAMIQUE 25X38X8
V 0403009	GLEITR.-MANSCHETTE WINKEL 30X40X7	COLLAR PERBUNAN 30X40X7	MANCHETTE PEBUNAN 30X40X7
* 9500177	RUNDDICHTRING 70°	GASKET 70°	JOINT 70°
8103179	MOTORTRÄGER	MOTOR SUPPORT	SUPPORT DE MOTEUR
8103177	ANSAUGSIEB	SUCTION SIEVE	FILTRE D'ASPIRATION
* 0355105	PASSFEDER A 8X7X22	FEATHER KEY A 8X7X22	RESSORT D'AJUSTAGE A 8X7X22
MOTOR	SIEHE ELEKTROSCHALTPLAN	SEE ELECTRIC WIRING DIAGRAM	VOIR SHEMA ELECTRIQUE
0335015	SKT.-MUTTER M8	HEXAGON NUT M8	ECROU A 6 PANS M8
0340006	U-SCHEIBE MS. VERN. Ø18XØ8,4X2	WASHER BRASS NICKELED Ø18XØ8,4X2	RONDELLE EN LAITON NICKELE Ø18XØ8,4X2
8100131	U-SCHEIBE Ø38XØ24,1X1	SUPPORT DISC Ø38XØ24,1X1	RONDELLE Ø38XØ24,1X1
0341012	FEDERRING 6MM	SPRING RING 6MM	RESSORT 6MM
0302055	SKT.-SCHRAUBE M6X12	HEXAGON SCREW M6X12	VIS A 6 PANS M6X12
0308210	SCHRAUBE M6X10	SCREW M6X10	VIS M6X10

1.4 WASCHPUMPE 4KW



1.4 WASH PUMP 4KW

1.4 POMPE DE LAVAGE 4KW

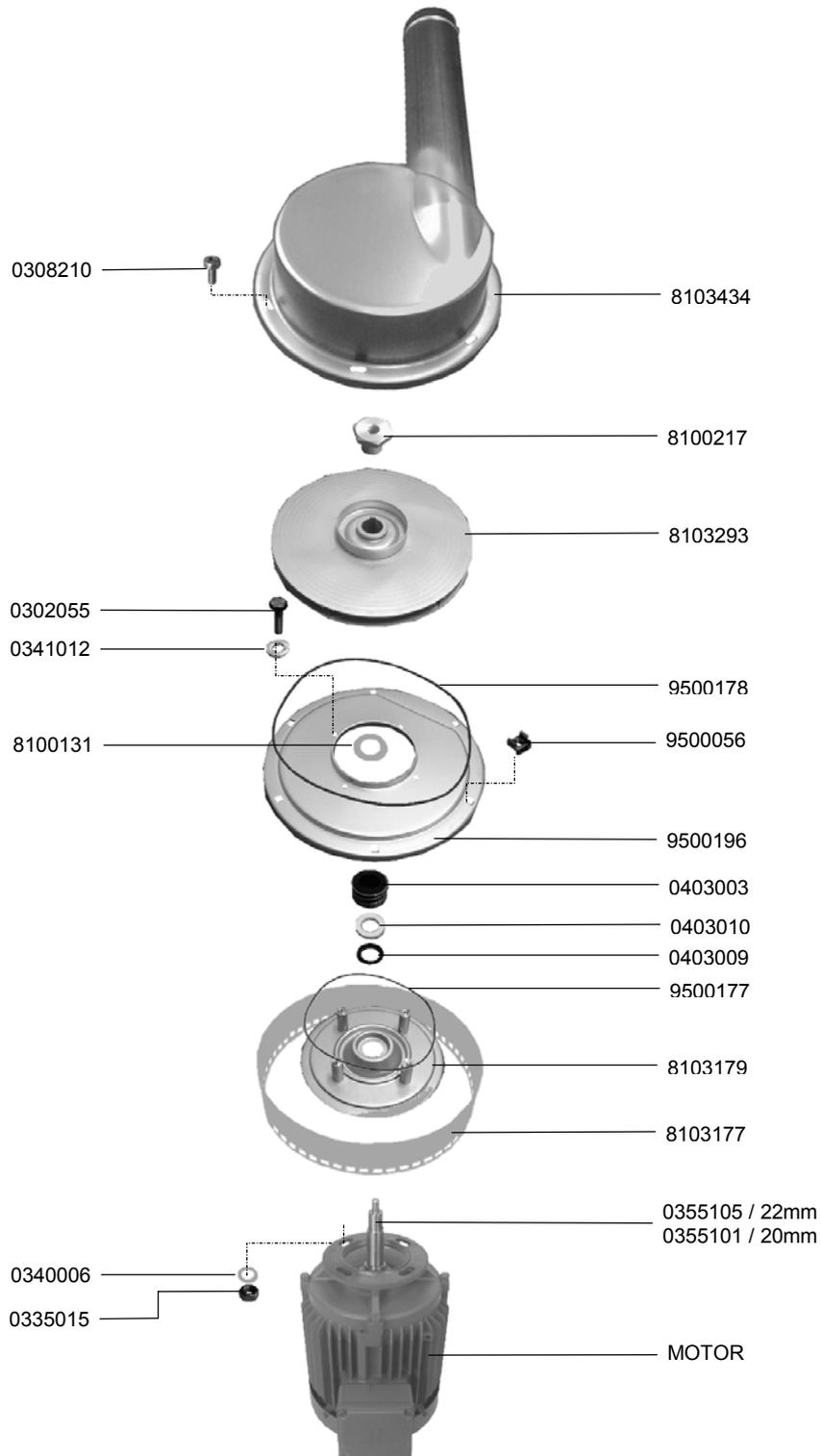

1.4 WASCHPUMPE 4KW



1.4 WASH PUMP 4KW

1.4 POMPE DE LAVAGE 4KW

IDENT.-NR. IDENT.-NO.	BEZEICHNUNG	DESIGNATION	DESIGNATION
8103434	PUMPENDECKEL KOMPL.	PUMP LID CPL.	COUVERCLE DE POMPE CPL.
8100217	MUTTER	NUT	ECROU
* 8103293	PUMPENRAD 4KW	IMPELLER 4KW	ROUE DE POMPE 4KW
* 9500178	RUNDDICHTRING 70°	GASKET 70°	JOINT 70°
9500056	KÄFIGMUTTER M6 1,2-1,6MM	NUT M6 1,2-1,6MM	ECROU M6 1,2-1,6MM
9500196	PUMPENBODEN	PUMP BASE	FOND DE POMPE
V 0403003	GLEITRINGDICHTUNG VITON 25X44X20	SLIDING SEAL 25X44X20	JOINT AXIAL 25X44X20
V 0403010	GLEITRING KERAMIK 25,9X38X8	SLIDING SEAL CERAMICS 25,9X38X8	JOINT AXIAL CERAMIQUE 25,9X38X8
V 0403009	GLEITR.-MANSCHETTE WINKEL 30X40X7	COLLAR PERBUNAN 30X40X7	MANCHETTE PEBUNAN 30X40X7
* 9500177	RUNDDICHTRING 70°	GASKET 70°	JOINT 70°
8103179	MOTORTRÄGER	MOTOR SUPPORT	SUPPORT DE MOTEUR
8103177	ANSAUGSIEB	SUCTION SIEVE	FILTRE D'ASPIRATION
* 0355105	PASSFEDER A 8X7X22	FEATHER KEY A 8X7X22	RESSORT D'AJUSTAGE A 8X7X22
* 0355101	PASSFEDER A 8X7X20	FEATHER KEY A 8X7X20	RESSORT D'AJUSTAGE A 8X7X20
MOTOR	SIEHE ELEKTROSCHALTPLAN	SEE ELECTRIC DIAGRAM	VOIR SCHEMA ELECTRIQUE
0335015	SKT.-MUTTER M8	HEXAGON NUT M8	ECROU A 6 PANS M8
0340006	U-SCHEIBE MS. VERN. Ø18XØ8,4X2	WASHER BRASS NICKELLED Ø18XØ8,4X2	RONDELLE EN LAITON NICKELE Ø18XØ8,4X2
0341012	FEDERRING 6MM	SPRING RING 6MM	RESSORT 6MM
0302055	SKT.-SCHRAUBE M6X12	HEXAGON SCREW M6X12	VIS A 6 PANS M6X12
0308210	SCHRAUBE M6X10	SCREW M6X10	VIS M6X15

1.5 WASCHPUMPE 2,2KW / 4KW



1.5 WASH PUMP 2,2KW / 4KW

1.5 POMPE DE LAVAGE 2,2KW / 4KW

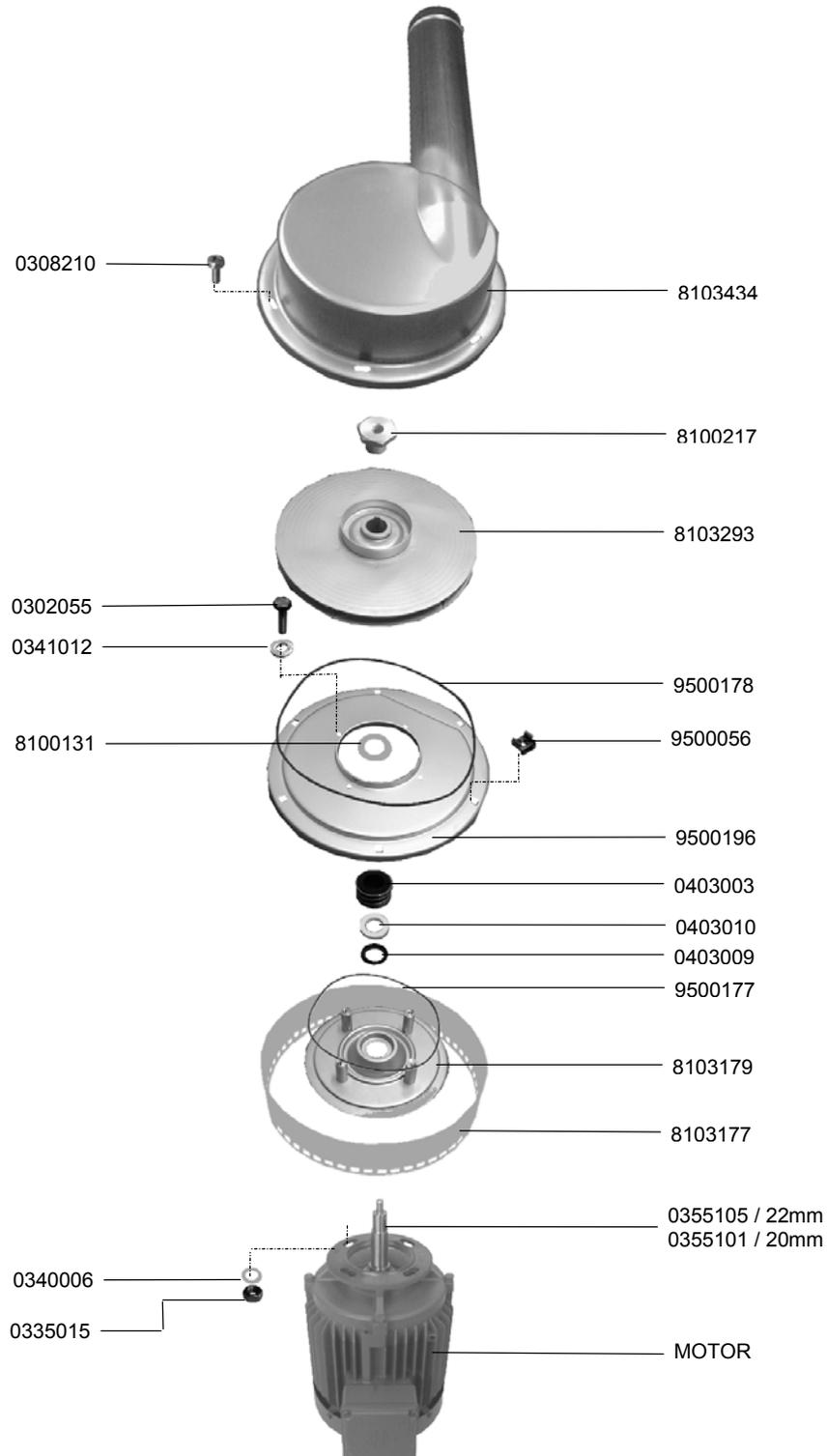

1.5 WASCHPUMPE 2,2KW / 4KW



1.5 WASH PUMP 2,2KW / 4KW

1.5 POMPE DE LAVAGE 2,2KW / 4KW

IDENT.-NR. IDENT.-NO.	BEZEICHNUNG	DESIGNATION	DESIGNATION
8103434	PUMPENDECKEL KOMPL.	PUMP LID CPL.	COUVERCLE DE POMPE CPL.
8100217	MUTTER	NUT	ECROU
* 8103293	PUMPENRAD 4KW	IMPELLER 4KW	ROUE DE POMPE 4KW
* 9500178	RUNDDICHTRING 70°	GASKET 70°	JOINT 70°
9500056	KÄFIGMUTTER M6 1,2-1,6MM	NUT M6 1,2-1,6MM	ECROU M6 1,2-1,6MM
9500196	PUMPENBODEN	PUMP BASE	FOND DE POMPE
V 0403003	GLEITRINGDICHTUNG VITON 25X44X20	SLIDING SEAL 25X44X20	JOINT AXIAL 25X44X20
V 0403010	GLEITRING KERAMIK 25,9X38X8	SLIDING SEAL CERAMICS 25,9X38X8	JOINT AXIAL CERAMIQUE 25,9X38X8
V 0403009	GLEITR.-MANSCHETTE WINKEL 30X40X7	COLLAR PERBUNAN 30X40X7	MANCHETTE PEBUNAN 30X40X7
* 9500177	RUNDDICHTRING 70°	GASKET 70°	JOINT 70°
8103179	MOTORTRÄGER	MOTOR SUPPORT	SUPPORT DE MOTEUR
8103177	ANSAUGSIEB	SUCTION SIEVE	FILTRE D'ASPIRATION
* 0355105	PASSFEDER A 8X7X22	FEATHER KEY A 8X7X22	RESSORT D'AJUSTAGE A 8X7X22
* 0355101	PASSFEDER A 8X7X20	FEATHER KEY A 8X7X20	RESSORT D'AJUSTAGE A 8X7X20
MOTOR	SIEHE ELEKTROSCHALTPLAN	SEE ELECTRIC WIRING DIAGRAM	VOIR SCHEMA ELECTRIQUE
0335015	SKT.-MUTTER M8	HEXAGON NUT M8	ECROU A 6 PANS M8
0340006	U-SCHEIBE MS. VERN. Ø18XØ8,4X2	WASHER BRASS NICKELED Ø18XØ8,4X2	RONDELLE EN LAITON NICKELE Ø18XØ8,4X2
8100131	U-SCHEIBE Ø38XØ24,1X1	SUPPORT DISC Ø38XØ24,1X1	RONDELLE Ø38XØ24,1X1
0341012	FEDERRING 6MM	SPRING RING 6MM	RESSORT 6MM
0302055	SKT.-SCHRAUBE M6X12	HEXAGON SCREW M6X12	VIS A 6 PANS M6X12
0308210	SCHRAUBE M6X10	SCREW M6X10	VIS M6X10

2.1 WASCHSYSTEM, 3 ARME OBEN



2.1 WASH SYSTEM, 3 WASH ARMS ABOVE

2.1 SYSTEME DE LAVAGE, 3 BRAS DE LAVAGE EN HAUT

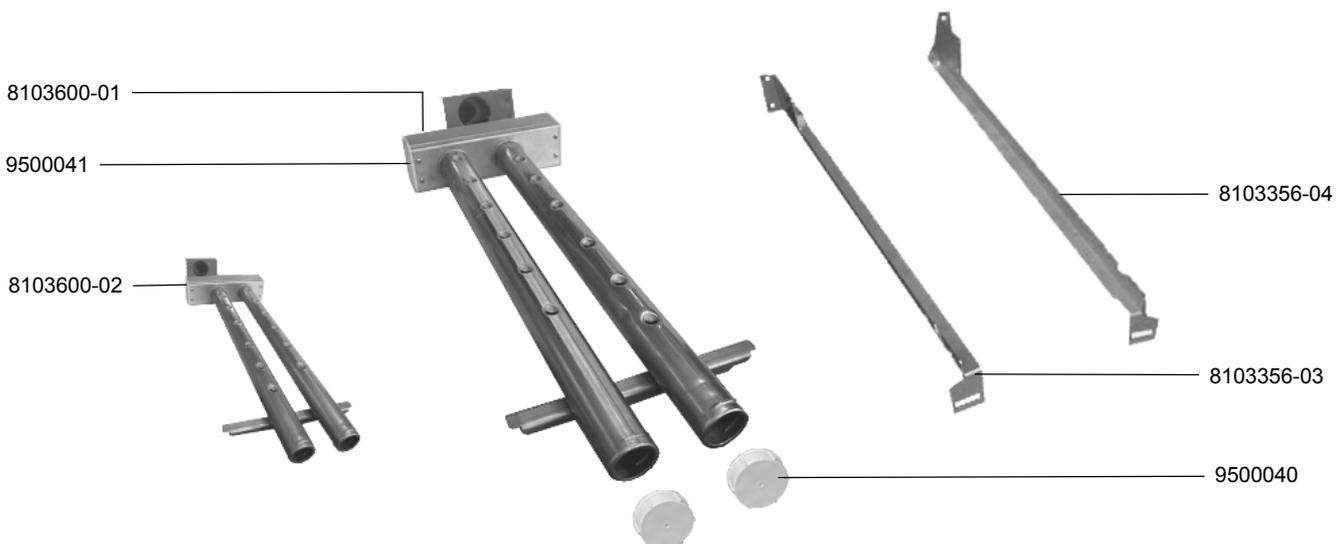
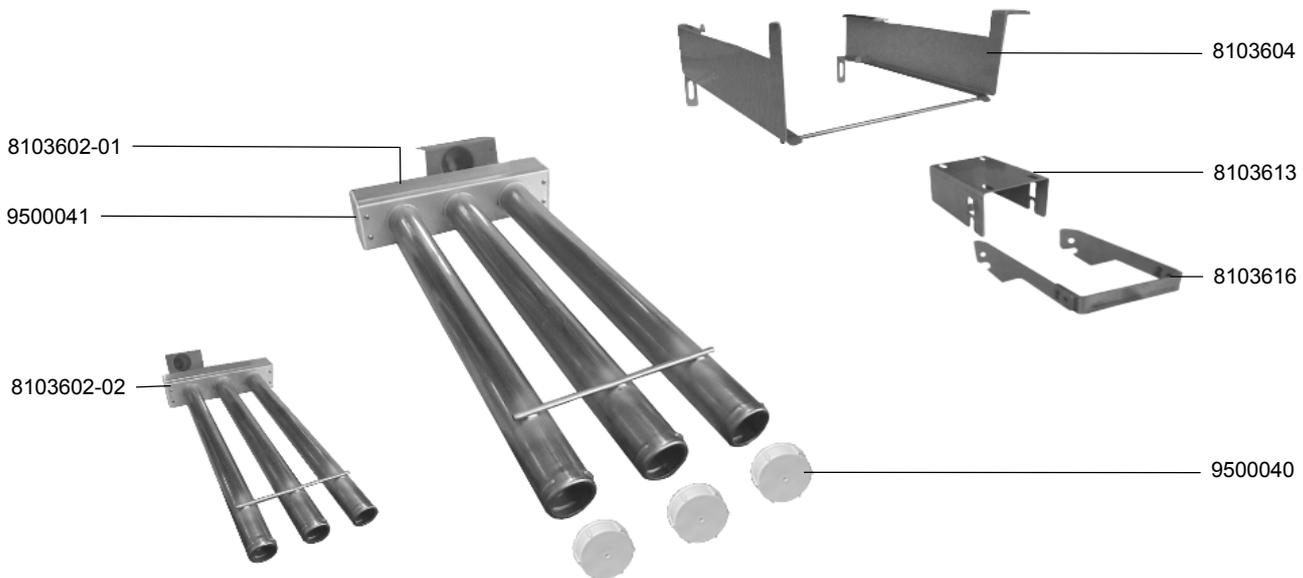

2.1 WASCHSYSTEM, 3 ARME OBEN



2.1 WASH SYSTEM, 3 WASH ARMS ABOVE

2.1 SYSTEME DE LAVAGE, 3 BRAS DE LAVAGE EN HAUT

IDENT.-NR. IDENT.-NO.	BEZEICHNUNG	DESIGNATION	DESIGNATION
8103604	AUFLAGE	SUPPORT	SUPPORT
8103613	BEFESTIGUNGSBÜGEL	FIXING BOW	BOUCLE DE FIXATION
8103616	BÜGEL	BOW	BOUCLE
* 9500040	VERSCHLUSSKAPPE	CLOSING CAP	CAPOUCHON
8103356-04	SEITENFÜHRUNG RECHTS	GUIDANCE RIGHT	GUIDAGE DROITE
8103356-03	SEITENFÜHRUNG LINKS	GUIDANCE LEFT	GUIDAGE GAUGE
8103600-02	WASCHSYSTEM UNTEN KPL. R-L	LOWER WASHSYSTEM CPL. R-L	SYSTEME DE LAVAGE INF. CPL D-G
9500041	DECKEL	LID	COVERCLE
8103600-01	WASCHSYSTEM UNTEN KPL. L-R	LOWER WASHSYSTEM CPL. L-R	SYSTEME DE LAVAGE INF. CPL G-D
8103602-01	WASCHSYSTEM OBEN KPL. L-R	UPPER WASHSYSTEM CPL. L-R	SYSTEME DE LAVAGE SUP. CPL.G-D
8103602-02	WASCHSYSTEM OBEN KPL. R-L	UPPER WASHSYSTEMCPL. R-L	SYSTEME DE LAVAGE SUP. CPL.D-G

2.2 WASCHSYSTEM, 4 ARME OBEN



2.2 WASH SYSTEM, 4 WASH ARMS ABOVE

2.2 SYSTEME DE LAVAGE, 4 BRAS DE LAVAGE EN HAUT

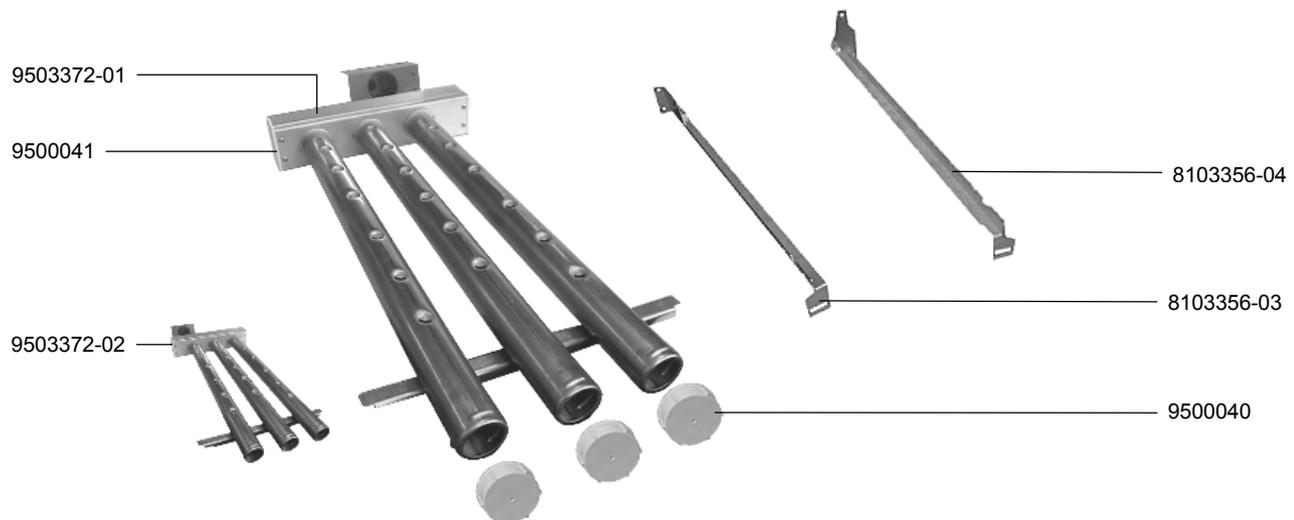
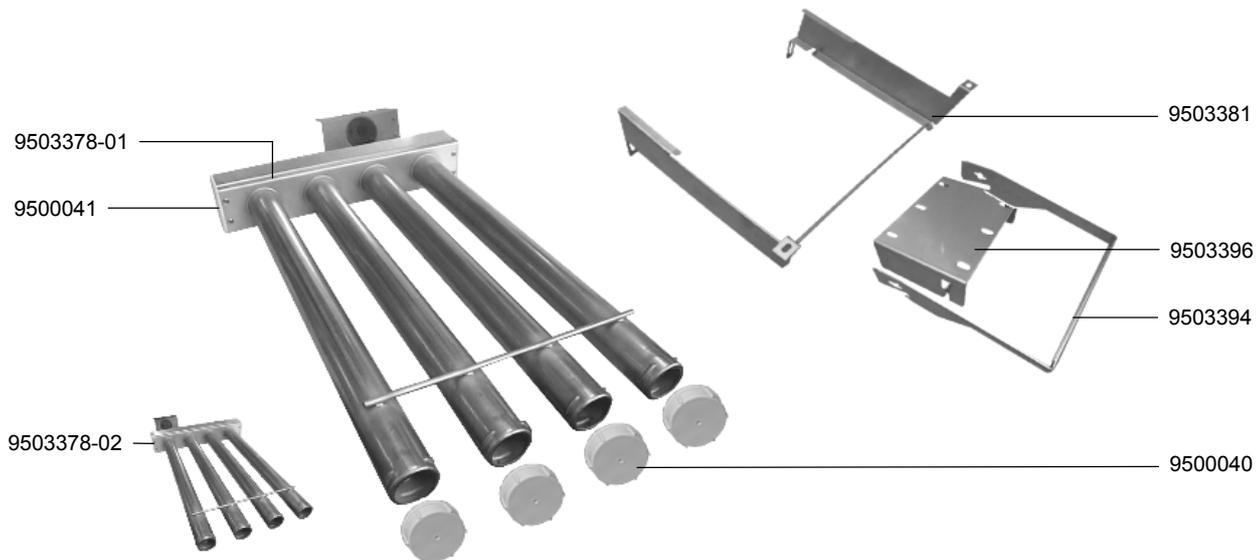

2.2 WASCHSYSTEM, 4 ARME OBEN



2.2 WASH SYSTEM, 4 WASH ARMS ABOVE

2.2 SYSTEME DE LAVAGE, 4 BRAS DE LAVAGE EN HAUT

IDENT.-NR. IDENT.-NO.	BEZEICHNUNG	DESIGNATION	DESIGNATION
9503381	AUFLAGE	SUPPORT	SUPPORT
9503396	BEFESTIGUNGSBÜGEL	FIXING BOW	BOUCLE DE FIXATION
9503394	BÜGEL	BOW	BOUCLE
* 9500040	VERSCHLUSSKAPPE	CLOSING CAP	CAPOUCHON
8103356-04	SEITENFÜHRUNG	GUIDANCE RIGHT	GUIDAGE DROITE
8103356-03	SEITENFÜHRUNG	GUIDANCE LEFT	GUIDAGE GAUCHE
9503372-02	WASCHSYSTEM UNTEN KPL. R-L	LOWER WASHSYSTEM CPL. R-L	SYSTEME DE LAVAGE INF. CPL D-G
9500041	DECKEL	LID	COVERCLE
9503372-01	WASCHSYSTEM UNTEN KPL. L-R	LOWER WASHSYSTEM CPL. L-R	SYSTEME DE LAVAGE INF. CPL G-D
9503378-02	WASCHSYSTEM OBEN KPL. R-L	UPPER WASHSYSTEMCPL. R-L	SYSTEME DE LAVAGE SUP. CPL.D-G
9503378-01	WASCHSYSTEM OBEN KPL. L-R	UPPER WASHSYSTEM CPL. L-R	SYSTEME DE LAVAGE SUP. CPL.G-D

2.3 WASCHSYSTEM, 5 ARME OBEN



2.3 WASH SYSTEM, 5 WASH ARMS ABOVE

2.3 SYSTEME DE LAVAGE, 5 BRAS DE LAVAGE EN HAUT

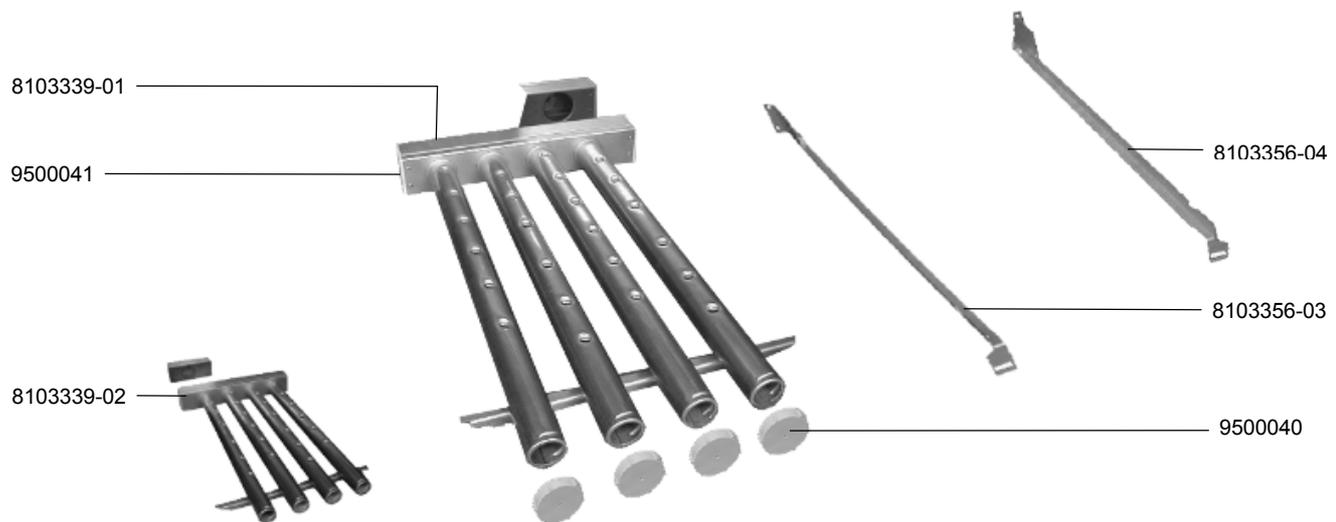
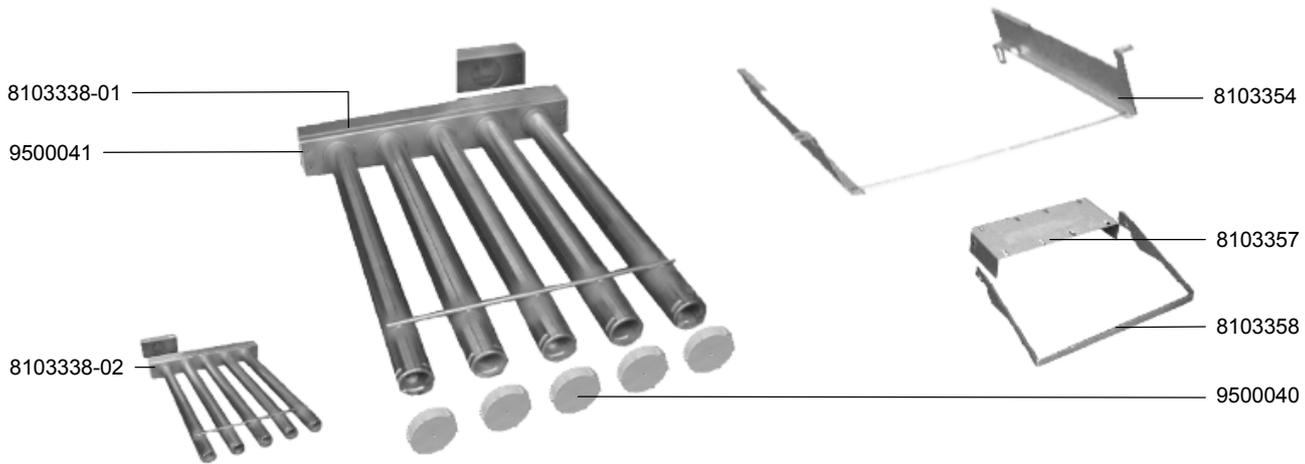

2.3 WASCHSYSTEM, 5 ARME OBEN



2.3 WASH SYSTEM, 5 WASH ARMS ABOVE

2.3 SYSTEME DE LAVAGE, 5 BRAS DE LAVAGE EN HAUT

IDENT.-NR. IDENT.-NO.	BEZEICHNUNG	DESIGNATION	DESIGNATION
8103354	AUFLAGE	SUPPORT	SUPPORT
8103357	BEFESTIGUNGSBÜGEL	FIXING BOW	BOUCLE DE FIXATION
8103358	BÜGEL	BOW	BOUCLE
* 9500040	VERSCHLUSSKAPPE	CLOSING CAP	CAPOUCHON
8103356-04	SEITENFÜHRUNG RECHTS	GUIDANCE RIGHT	GUIDAGE DROITE
8103356-03	SEITENFÜHRUNG LINKS	GUIDANCE LEFT	GUIDAGE GAUGE
8103339-02	WASCHSYSTEM UNTEN KPL. R-L	LOWER WASHSYSTEM CPL. R-L	SYSTEME DE LAVAGE INF. CPL D-G
9500041	DECKEL	LID	COVERCLE
8103339-01	WASCHSYSTEM UNTEN KPL. L-R	LOWER WASHSYSTEM CPL. L-R	SYSTEME DE LAVAGE INF. CPL G-D
8103338-02	WASCHSYSTEM OBEN KPL. R-L	UPPER WASHSYSTEMCPL. R-L	SYSTEME DE LAVAGE SUP. CPL.D-G
8103338-01	WASCHSYSTEM OBEN KPL. L-R	UPPER WASHSYSTEM CPL. L-R	SYSTEME DE LAVAGE SUP. CPL.G-D

2.4 WASCHSYSTEM, 6 ARME OBEN



2.4 WASH SYSTEM, 6 WASH ARMS ABOVE

2.4 SYSTEME DE LAVAGE, 6 BRAS DE LAVAGE EN HAUT

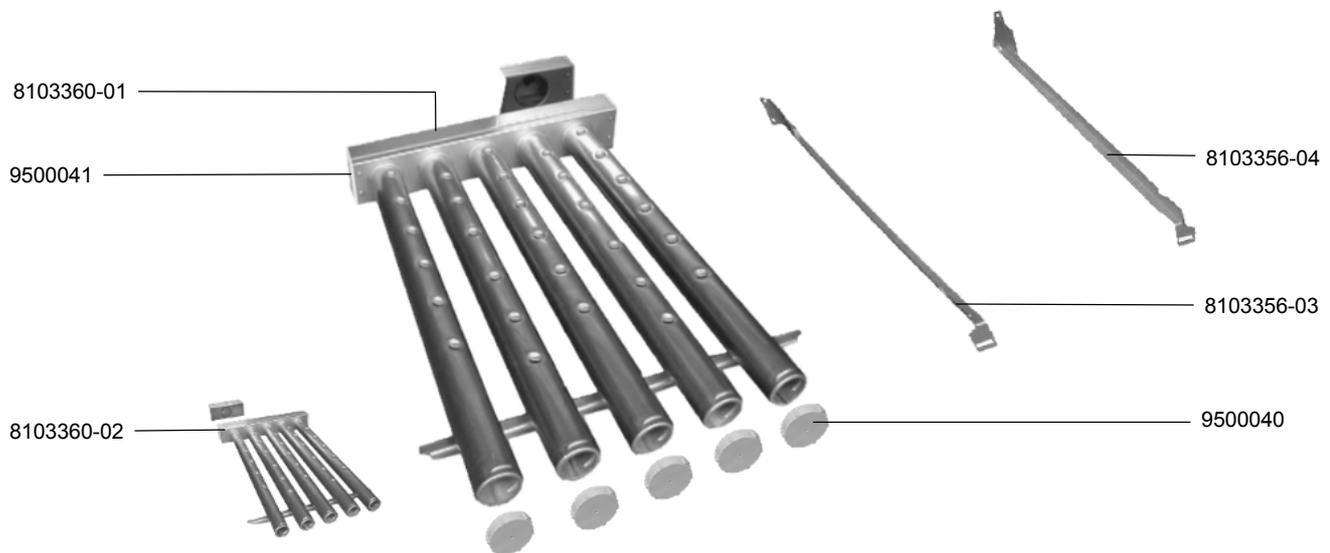
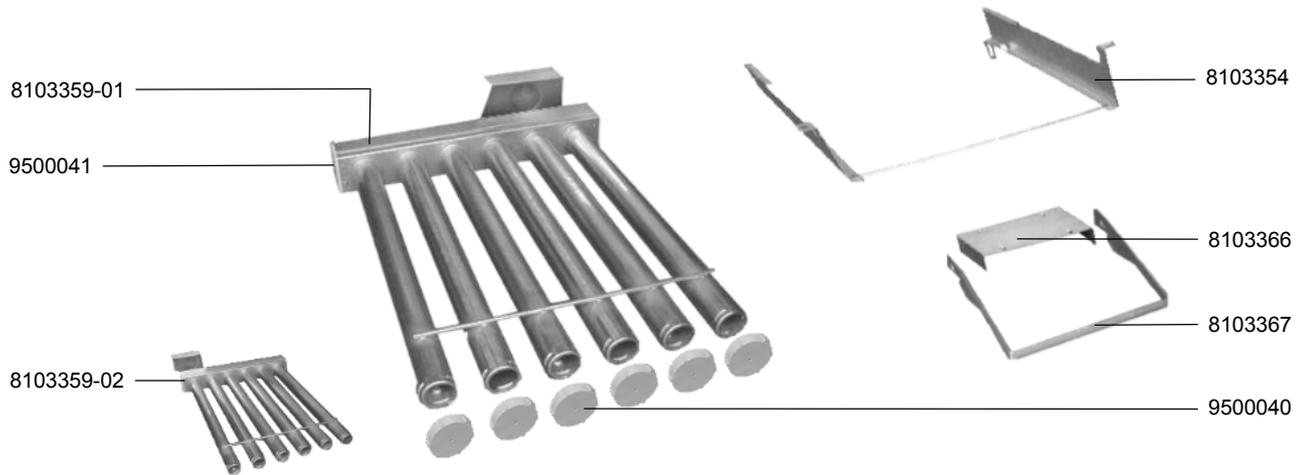

2.4 WASCHSYSTEM, 6 ARME OBEN



2.4 WASH SYSTEM, 6 WASH ARMS ABOVE

2.4 SYSTEME DE LAVAGE, 6 BRAS DE LAVAGE EN HAUT

IDENT.-NR. IDENT.-NO.	BEZEICHNUNG	DESIGNATION	DESIGNATION
8103354	AUFLAGE	SUPPORT	SUPPORT
8103366	BEFESTIGUNGSBÜGEL	FIXING BOW	BOUCLE DE FIXATION
8103367	BÜGEL	BOW	BOUCLE
* 9500040	VERSCHLUSSKAPPE	CLOSING CAP	CAPOUCHON
8103356-04	SEITENFÜHRUNG RECHTS	GUIDANCE RIGHT	GUIDAGE DROITE
8103356-03	SEITENFÜHRUNG LINKS	GUIDANCE LEFT	GUIDAGE GAUGE
8103360-02	WASCHSYSTEM UNTEN KPL. R-L	LOWER WASHSYSTEM CPL. R-L	SYSTEME DE LAVAGE INF. CPL D-G
9500041	DECKEL	LID	COVERCLE
8103360-01	WASCHSYSTEM UNTEN KPL. L-R	LOWER WASHSYSTEM CPL. L-R	SYSTEME DE LAVAGE INF. CPL G-D
8103359-02	WASCHSYSTEM OBEN KPL. R-L	UPPER WASHSYSTEMCPL. R-L	SYSTEME DE LAVAGE SUP. CPL.D-G
8103359-01	WASCHSYSTEM OBEN KPL. L-R	UPPER WASHSYSTEM CPL. L-R	SYSTEME DE LAVAGE SUP. CPL.G-D

2.5 SEITLICHES WASCHSYSTEM



2.5 LATERAL WASH SYSTEM

2.5 SYSTEME DE LAVAGE LATERAL

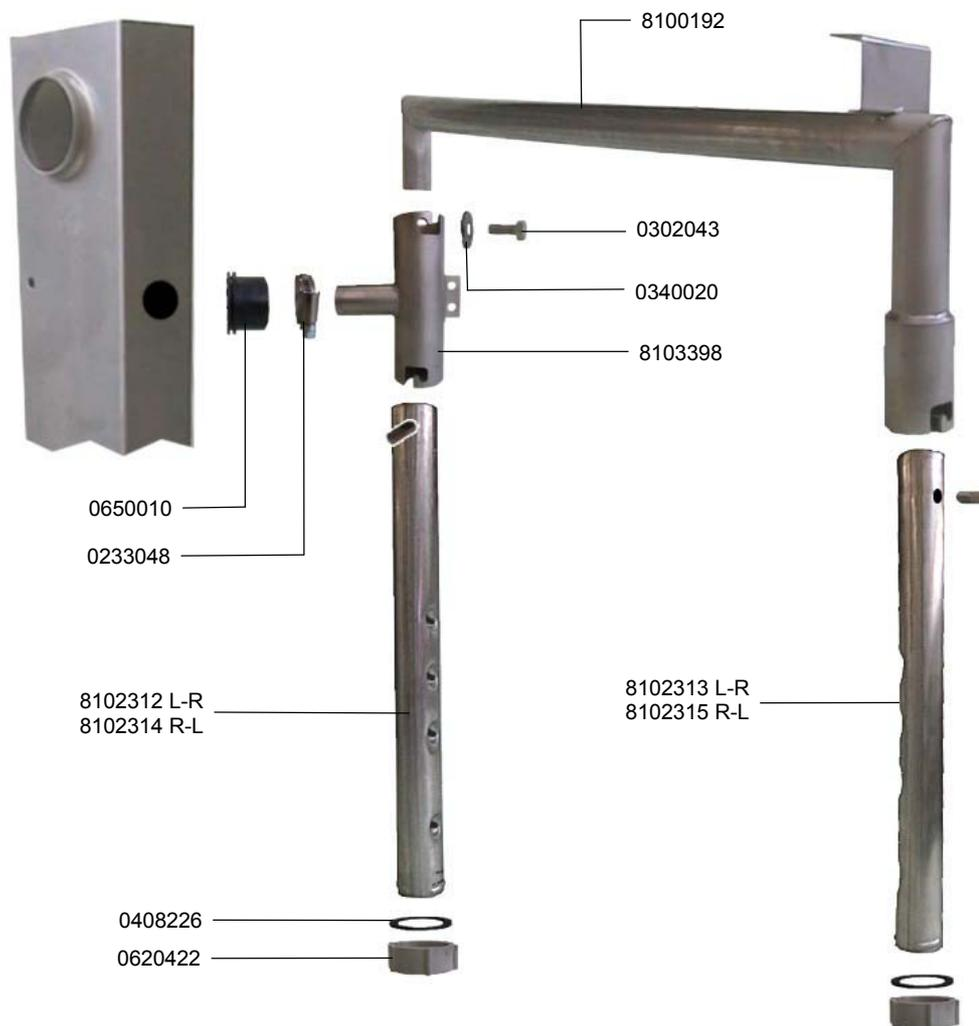

2.5 SEITLICHES WASCHSYSTEM



2.5 LATERAL WASH SYSTEM

2.5 SYSTEME DE LAVAGE LATERAL

IDENT.-NR. IDENT.-NO.	BEZEICHNUNG	DESIGNATION	DESIGNATION
8100192	VERTEILERROHR	DISTRIBUTING PIPE	TUYAU DISTRIBUTEUR
0302043	SKT.SCHRAUBE M5X10	HEXAGONE SCREW M5X10	VIS A 6 PANS M5X10
0340020	SCHEIBE	DISK	DISQUE
8103398	BAJONETTROHR	DISTRIBUTING BAYONET	BAIONNETTE DISTRIBUTEUR
8102313	WASCHARM KPL. R-L	WASH ARM CPL. R-L	BRAS DE LAVAGE CPL.D-G
8102315	WASCHARM KPL. R-L	WASH ARM CPL. R-L	BRAS DE LAVAGE CPL.D-G
* 0620422	VERSCHLUSSKAPPE	CLOSING CAP	CAPOUCHON
V 0408226	DICHTUNG	PACKING	JOINT
8102314	WASCHARM KPL. L-R	WASH ARM CPL. L-R	BRAS DE LAVAGE CPL.G-D
8102312	WASCHARM KPL. L-R	WASH ARM CPL. L-R	BRAS DE LAVAGE CPL.G-D
0233048	SCHLAUCHKLEMME 20-32	HOSE WIRE CLAMP 20-32	COLLIER DE SERRAGE 20-32
0650010	GUMMITUILLE	RUBBER BUSHING	DOUILLE EN CAOUTCHOUC

2.5.1 SEITLICHES WASCHSYSTEM



2.5.1 LATERAL WASH SYSTEM

2.5.1 SYSTEME DE LAVAGE LATERAL

IDENT.-NR. IDENT.-NO.	BEZEICHNUNG	DESIGNATION	DESIGNATION
9533755	VERSCHLUSSKAPPE	CLOSING CAP	CAPOUCHON
0302001	SKT.-SCHRAUBE M6X15	HEXAGON SCREW M6X15	VIS A 6 PANS M6X15
9533849	WASCHARM KPL	WASH ARM CPL	BRAS DE LAVAGE
9533933-01	VERTEILERROHR L-R	DISTRIBUTION PIPE L-R	TUYAU DE DISTRIBUTION L-R
9533933-02	VERTEILERROHR R-L	DISTRIBUTION PIPE R-L	TUYAU DE DISTRIBUTION R-L
0233048	SCHLAUCHKLEMME 20-32	HOSE WIRE CLAMP 20-32	COLLIER DE SERRAGE 20-32
0650010	GUMMITUILLE	RUBBER BUSHING	DOUILLE EN CAOUTCHOUC

3.1 STEIGROHR KPL., 0,55KW



3.1 ASCENDING PIPE CPL., 0,55KW

3.1 CONDUITE ASCENDANTE CPL., 0,55KW

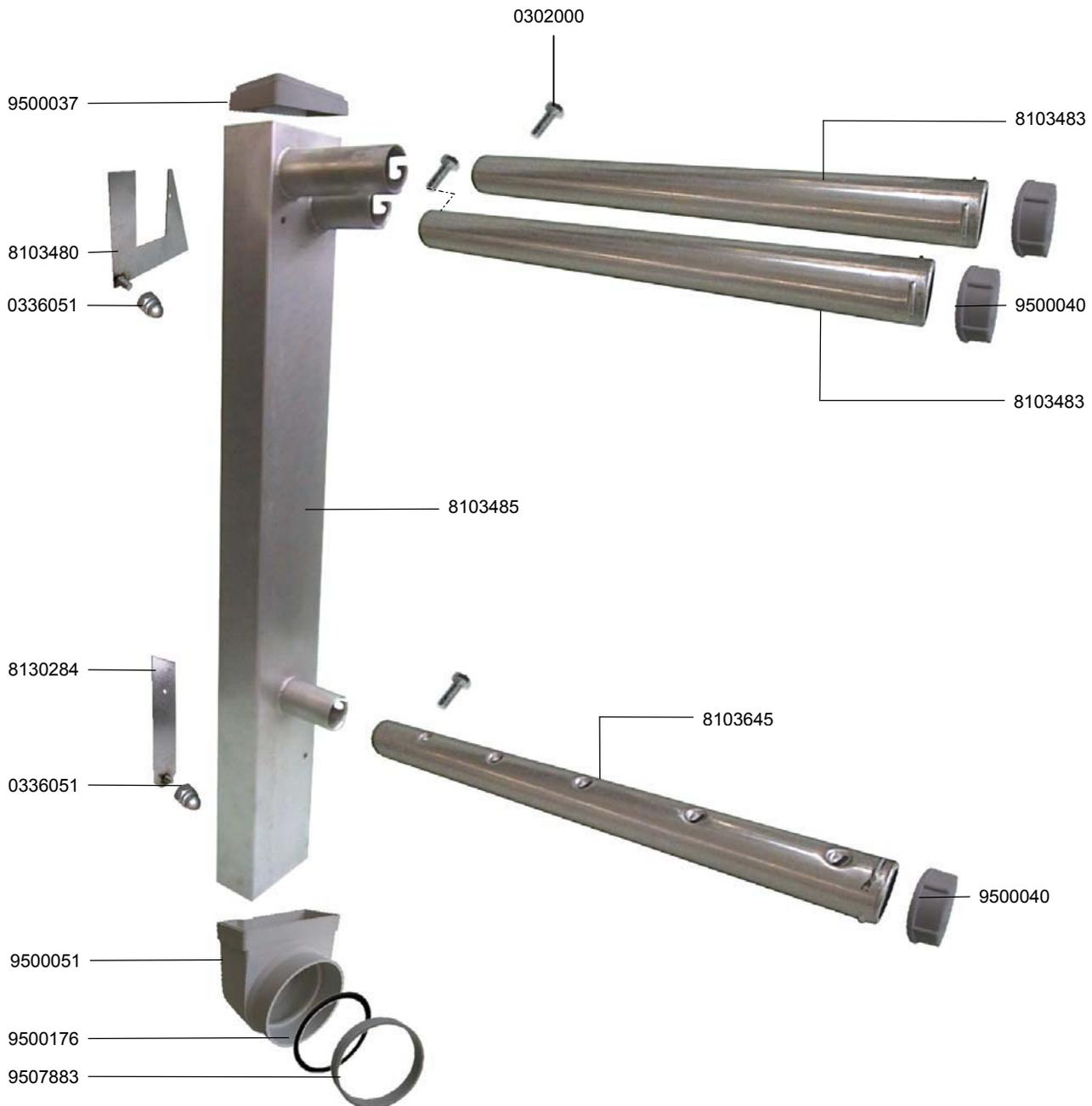

3.1 STEIGROHR KPL., 0,55KW



3.1 ASCENDING PIPE CPL., 0,55KW

3.1 CONDUITE ASCENDANTE CPL., 0,55KW

IDENT.-NR. IDENT.-NO.	BEZEICHNUNG	DESIGNATION	DESIGNATION
8103483	WASCHARM OBEN KPL.	UPPER WASH ARM CPL.	BRAS DE LAVAGE SUP. CPL.
* 9500040	VERSCHLUSSKAPPE	CLOSING CAP	CAPOUCHON
8103485	STEIGROHR	ASCENDING PIPE	CONDUITE ASCENDANTE
8103645	WASCHARM UNTEN KPL.	LOWER WASH ARM CPL.	BRAS DE LAVAGE INF. CPL
9507883	STÜTZRING	SUPPORT RING	BAGUE DE SUPPORT
9500176	O-RING	O-RING	BAGUE
9500051	STEIGROHRANSCHLUSS	ASCENDING PIPE CONNECTION	CONNEXION POUR CONDUITE ASCENDANTE
0336051	HUTMUTTER M6	CAP NUT M6	ECROU BORGNE M6
8130284	DROSSELBLECH	THROTTLE PLATE	TOLE DE D'ETRANGLEMENT
8103480	STEIGROHRDROSSEL	THROTTLE PLATE	TOLE DE D'ETRANGLEMENT
9500037	STEIGROHRDECKEL	LID	COUVERCLE
0302000	SKT.-SCHRAUBE M6X10	HEXAGON SCREW M6X10	VIS A 6 PANS M6X10

3.2 STEIGROHR, 2,2KW / 4,0KW



3.2 ASCENDING PIPE, 2,2KW / 4,0KW

3.2 CONDUITE ASCENDANTE, 2,2KW / 4,0KW

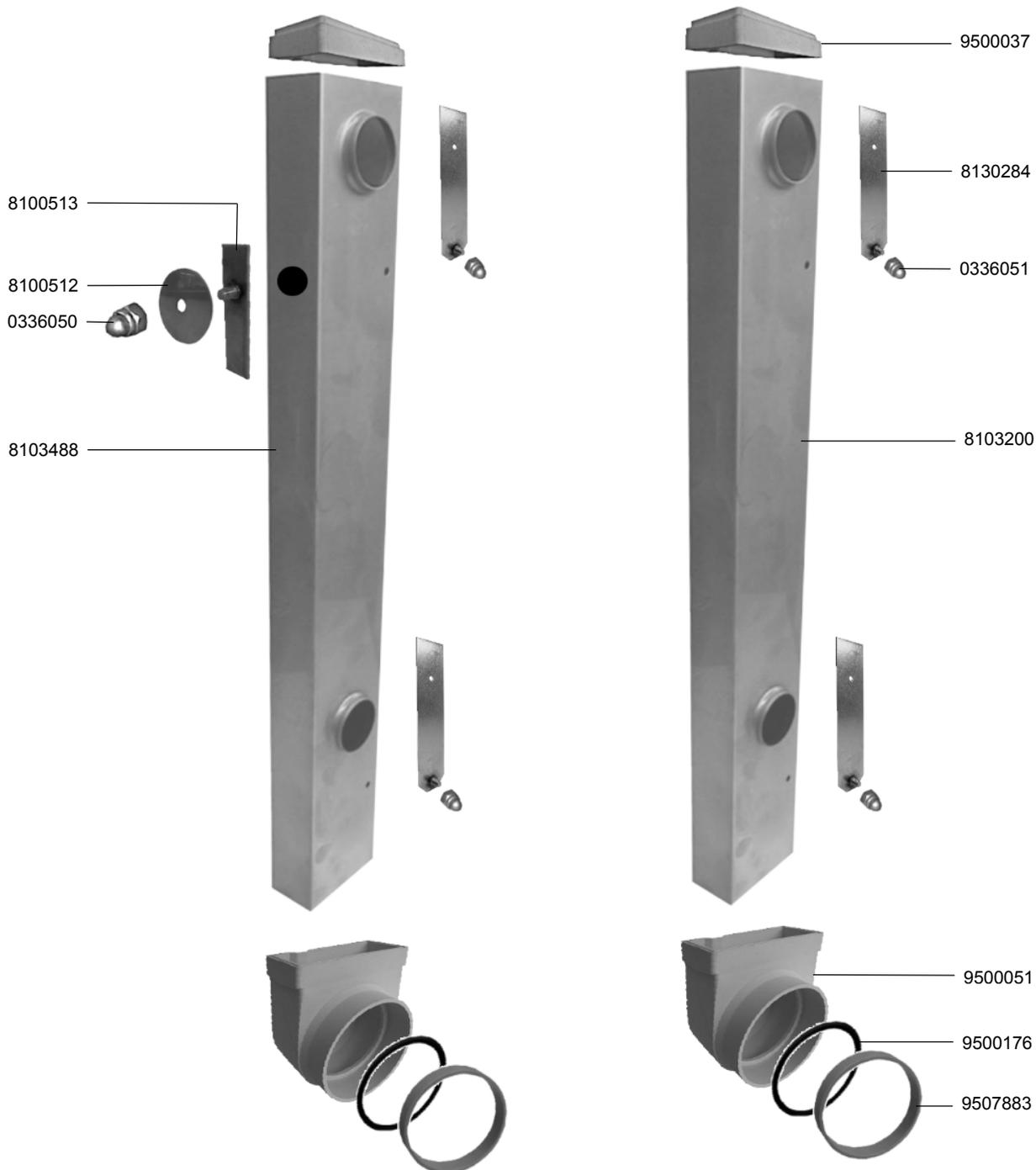

3.2 STEIGROHR, 2,2KW / 4,0KW



3.2 ASCENDING PIPE, 2,2KW / 4,0KW

3.2 CONDUITE ASCENDANTE, 2,2KW / 4,0KW

IDENT.-NR. IDENT.-NO.	BEZEICHNUNG	DESIGNATION	DESIGNATION
9500037	STEIGROHRDECKEL	LID	COUVERCLE
8130284	DROSSELBLECH	THROTTLE PLATE	TOLE DE D'ETRANGLEMENT
0336051	HUTMUTTER M6	CAP NUT M6	ECROU BORGNE M6
8103200	STEIGROHR	ASCENDING PIPE	CONDUITE ASCENDANTE
9500051	STEIGROHRANSCHLUSS	ASCENDING PIPE CONNECTION	CONNEXION POUR CONDUITE ASCENDANTE
* 9500176	O-RING	O-RING	O-RING
9507883	STÜTZRING	SUPPORT RING	BAGUE DE SUPPORT
8103488	STEIGROHR	ASCENDING PIPE	CONDUITE ASCENDANTE
0336050	HUTMUTTER M5	CAP NUT M5	ECROU BORGNE M5
8100512	SCHEIBE	DISK	DISQUE
8100513	STEIGROHRVERSCHLUSSBLECH	STOPPER	TOLE DE OBTURATION

4.1 FRISCHWASSERKLARSPÜLUNG, STANDARD



4.1 FRESH WATER FINAL RINSE, STANDARD

4.1 RINCAGE FINAL A L'EAU CLAIRE, STANDARD

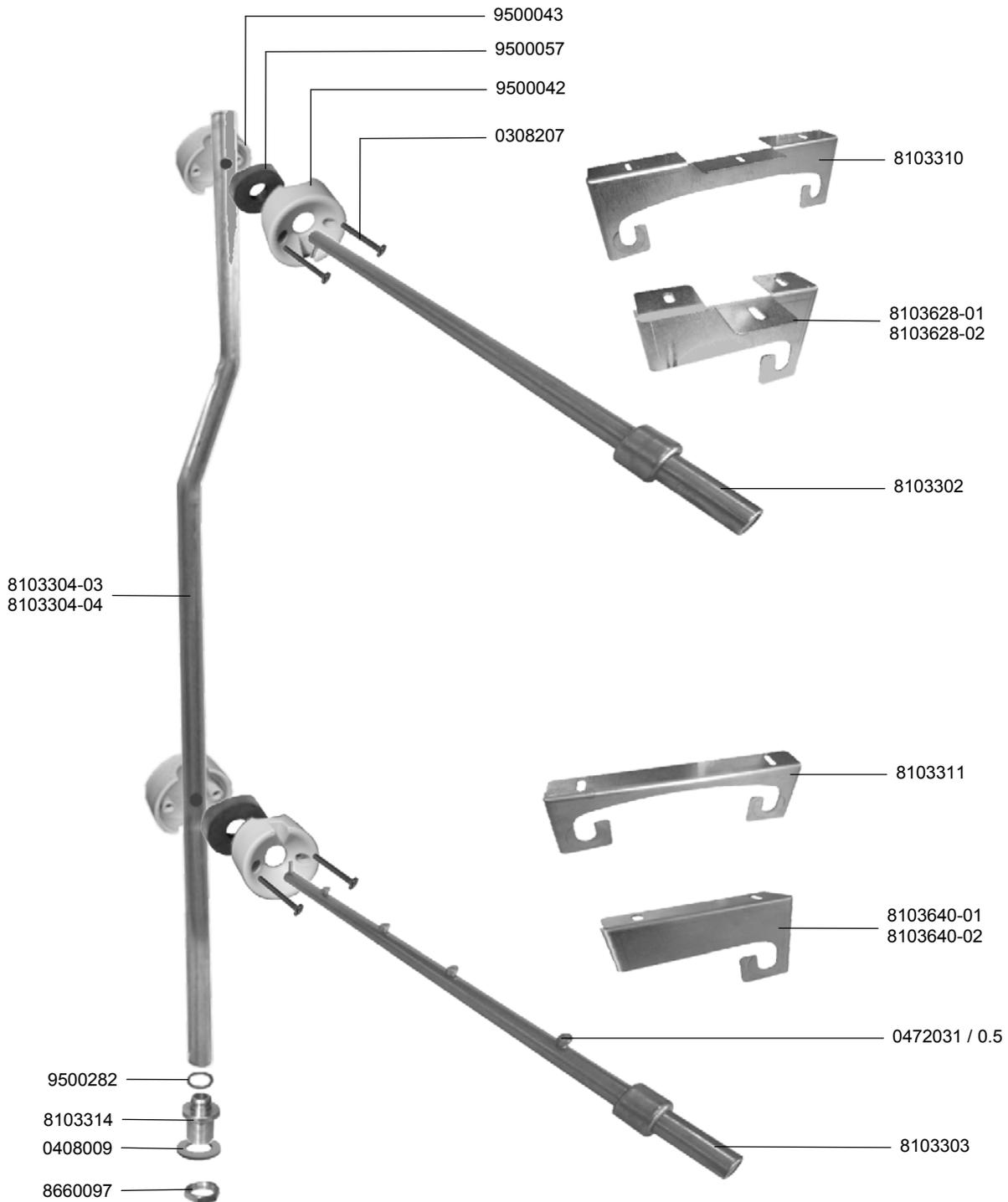

4.1 FRISCHWASSERKLARSPÜLUNG, STANDARD



4.1 FRESH WATER FINAL RINSE, STANDARD

4.1 RINCAGE FINAL A L'EAU CLAIRE, STANDARD

IDENT.-NR. IDENT.-NO.	BEZEICHNUNG	DESIGNATION	DESIGNATION
* 9500043	KUPPLUNG RÜCKTEIL	CLUTCH BACK PART.	ACCOUPLLEMENT ARRIERE
* 9500057	DICHTUNG	PACKING	JOINT
* 9500042	KUPPLUNG VORDERTEIL	CLUTCH FRONT PART	ACCOUPLLEMENT FRONTALE
0308207	SCHRAUBE M4X10	SCREW M4X10	VIS M4X10
8103310	HALTERUNG OBEN	UPPER SUPPORT	SUPPORT SUP.
8103628-01	HALTERUNG OBEN L-R	UPPER SUPPORT L-R	SUPPORT SUP. G-D
8103628-02	HALTERUNG OBEN R-L	UPPER SUPPORT R-L	SUPPORT SUP. D-G
8103302	WASCHARM OBEN KPL.	UPPER WASH ARM CPL.	BRAS DE LAVAGE SUP. CPL.
8103311	HALTERUNG UNTEN	LOWER SUPPORT	SUPPORT INF.
8103640-01	HALTERUNG UNTEN L-R	LOWER SUPPORT L-R	SUPPORT INF. G-D
8103640-02	HALTERUNG UNTEN R-L	LOWER SUPPORT R-L	SUPPORT INF. D-G
* 0472031	DÜSE 0.5	NOZZLE 0.5	GICLEUR 0.5
8103303	WASCHARM UNTEN KPL.	LOWER WASH ARM CPL.	BRAS DE LAVAGE INF. CPL.
8660097	SKT.MUTTER	HEXAGON NUT	ECROU A 6 PANS
0408009	DICHTUNG	PACKING	JOINT
8103314	TANKDURCHFÜHRUNG	TANK THROUGH-LEAD	TRAVERSEE DU BAC
9500282	O-RING	O-RING	BAGUE
8103304-04	STEIGROHR RECHTS	ASCENDING PIPE RIGHT	CONDUITE ASCENDANTE DROITE
8103304-03	STEIGROHR LINKS	ASCENDING PIPE LEFT	CONDUITE ASCENDANTE GAUGE

4.2 FRISCHWASSERNETZTRENNUNG



4.2 FRESH WATER MAINS ISOLATING DEVICE

4.2 DIPOSITIF DE SEPERATION DU RESEAU D' EAU

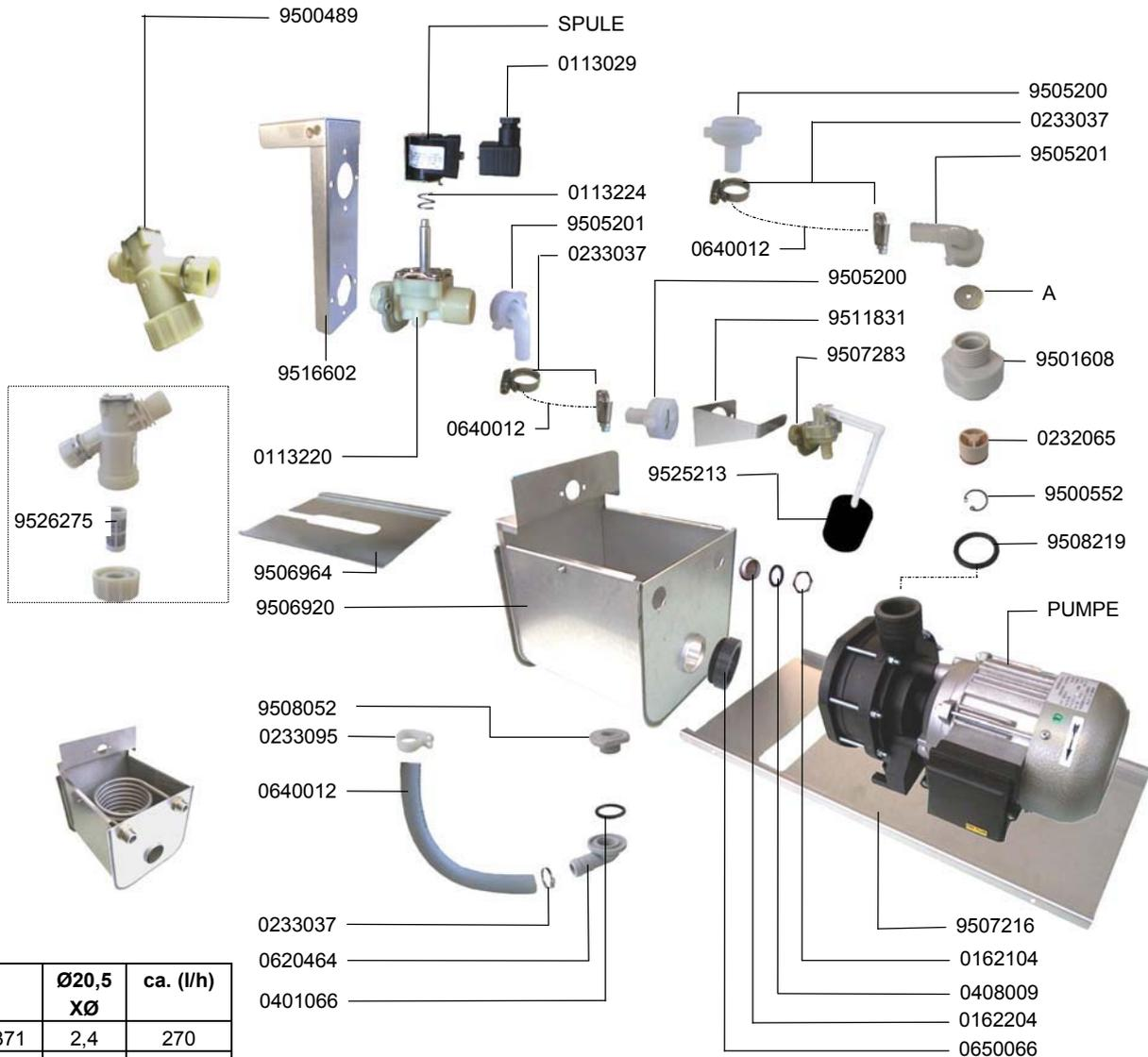

A	Ø20,5 XØ	ca. (l/h)
9502371	2,4	270
9502372	2,5	280
9515128	2,6	290
9515129	2,7	300
9515130	2,8	320
9515131	2,9	330
9515132	3,0	330/340
9515133	3,1	350
9515150	3,2	360/380
9515151	3,3	400



4.2 FRISCHWASSERNETZTRENNUNG



4.2 FRESH WATER MAINS ISOLATING DEVICE

4.2 DIPOSITIF DE SEPERATION DU RESEAU D' EAU

IDENT.-NR. IDENT.-NO.	BEZEICHNUNG	DESIGNATION	DESIGNATION
SPULE	SIEHE ELEKTROSCHALTPLAN	SEE ELECTRIC WIRING DIAGRAM	VOIR SCHEMA ELECTRIQUE
0113029	STECKBÜCHSE	TIP JACK	FICHE FEMELLE
9505200	ANSCHLUSSTÜCK	CONNECTION PIECE	PIECE DE CONNEXION
0233037	SCHLAUCHKLEMME 16-27	HOSE WIRE CLAMP 16-27	COLLIER DE SERRAGE 16-27
9505201	ANSCHLUSSWINKEL	CONNECTION ANGLE	ANGLE DE CONNEXION
* 0113224	FEDER	SPRING	RESSORT
0640012	SCHLAUCH	HOSE	TUYAU
9511831	HALTEBLECH	SUPPORT	SUPPORT
* 9507283	SCHWIMMERVENTIL	FLOAT VALVE	VANNE A FLOTTEUR
* 9525213	SCHWIMMER	FLOAT	FLOTTEUR
9502371	DROSSELSCHEIBE Ø20,5XØ2,4; 270L/H	THROTTLE DISK Ø20,5XØ2,4; 270L/H	DISQUE D' ETRANGLEMENT Ø20,5XØ2,4; 270L/H
9502372	DROSSELSCHEIBE Ø20,5XØ2,5; 280L/H	THROTTLE DISK Ø20,5XØ2,5; 280L/H	DISQUE D' ETRANGLEMENT Ø20,5XØ2,5; 280L/H
9515128	DROSSELSCHEIBE Ø20,5XØ2,6; 290L/H	THROTTLE DISK Ø20,5XØ2,6; 290L/H	DISQUE D' ETRANGLEMENT Ø20,5XØ2,6; 290L/H
9515129	DROSSELSCHEIBE Ø20,5XØ2,7; 300L/H	THROTTLE DISK Ø20,5XØ2,7; 300L/H	DISQUE D' ETRANGLEMENT Ø20,5XØ2,7; 300L/H
9515130	DROSSELSCHEIBE Ø20,5XØ2,8; 320L/H	THROTTLE DISK Ø20,5XØ2,8; 320L/H	DISQUE D' ETRANGLEMENT Ø20,5XØ2,8; 320L/H
9515131	DROSSELSCHEIBE Ø20,5XØ2,9; 330L/H	THROTTLE DISK Ø20,5XØ2,9; 330L/H	DISQUE D' ETRANGLEMENT Ø20,5XØ2,9; 330L/H
9515132	DROSSELSCHEIBE Ø20,5XØ3,0; 330-340L/H	THROTTLE DISK Ø20,5XØ3,0; 330-340L/H	DISQUE D' ETRANGLEMENT Ø20,5XØ3,0; 330-340L/H
9515133	DROSSELSCHEIBE Ø20,5XØ3,1; 350L/H	THROTTLE DISK Ø20,5XØ3,1; 350L/H	DISQUE D' ETRANGLEMENT Ø20,5XØ3,1; 350L/H
9515150	DROSSELSCHEIBE Ø20,5XØ3,2; 360-380L/H	THROTTLE DISK Ø20,5XØ3,2; 360-380L/H	DISQUE DE ETRANGLEMENT Ø20,5XØ3,2; 360-380L/H
9515151	DROSSELSCHEIBE Ø20,5XØ3,3; 400L/H	THROTTLE DISK Ø20,5XØ3,3; 400L/H	DISQUE D' ETRANGLEMENT Ø20,5XØ3,3; 400L/H
9501608	ADAPTER	ADAPTER	ADAPTEUR
* 0232065	RÜCKSCHLAGVENTIL	CHECK VALVE	CLAPET ANTI-RETOUR
* 9500552	SICHERUNGSRING	SAFETY RING	BAGUE DE SECURITE
* 9508219	O-RING	O-RING	BAGUE
PUMPE	SIEHE ELEKTROSCHALTPLAN	SEE ELECTRIC WIRING DIAGRAM	VOIR SCHEMA ELECTRIQUE
9507216	KONSOLE	CONSOLE	CONSOLE
0162104	GEGENMUTTER	COUNTER NUT	CONTRE-ECROU
0408009	DICHTUNG	PACKING	JOINT
0162204	BLINDSTOPFEN	BLIND PLUG	TAMPON BORGNE
* 0650066	MUFFE	MUFF	MANCHON
* 9522401	PUMPENLAUFRAD	PUMP WHEEL	ROUE DE POMPE

4.2 FRISCHWASSERNETZTRENNUNG



4.2 FRESH WATER MAINS ISOLATING DEVICE

4.2 DIPOSITIF DE ISOLEMENT DU RESEAU DE EAU

IDENT.-NR. IDENT.-NO.	BEZEICHNUNG	DESIGNATION	DESIGNATION
9522402	DICHTUNGSSATZ	PACKING	JOINT
0401066	O-RING	O-RING	BAGUE
0620464	ANSCHLUSSWINKEL	CONNECTION ANGLE	ANGLE DE CONNEXION
0233095	SCHLAUCHKLEMME 13-16	HOSE WIRE CLAMP 13-16	COLLIER DE SERRAGE 13-16
9508052	VERSCHRAUBUNG	SCREWING	VISSAGE
9526275	SIEB	SIEVE	TAMIS
9506920	BEHÄLTER	CONTAINER	CONTENEUR
9506964	DECKEL	LID	COUVERCLE
0113220	MAGNETVENTIL	SOLENOID VALVE	ELECTROVANNE
9516602	HALTERUNG	SUPPORT	SUPPORT
9500489	SCHMUTZFÄNGER	DIRT TRAP	COLLECTEUR DE SELETE

4.3 NETZMITTELMISCHBEHÄLTER



4.3 RINSE-AID MIXING CHAMBER

4.3 RESERVOIR DE MELANGE DE PRODUIT DE RINCAGE

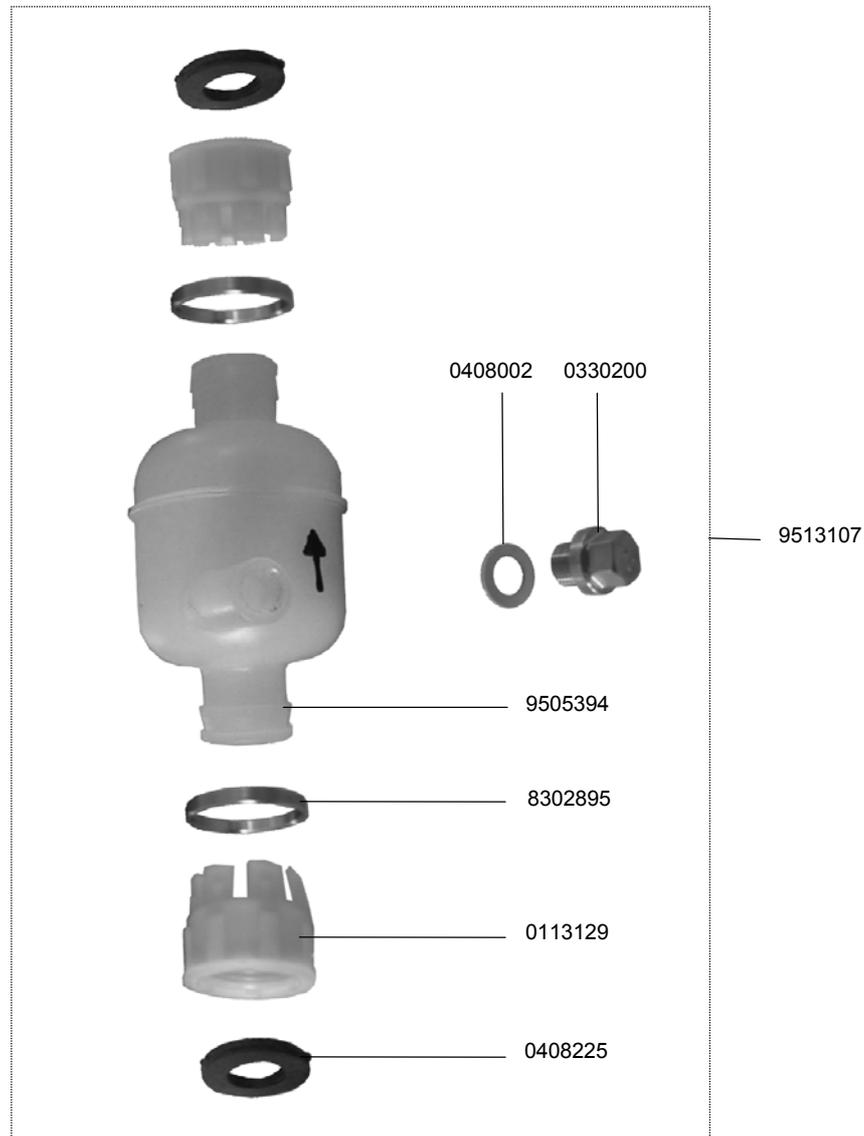

IDENT.-NR. IDENT.-NO.	BEZEICHNUNG	DESIGNATION	DESIGNATION
9513107	MISCHBEHÄLTER KPL.	MIXING CHAMBER CPL.	RESERVOIR DE MELANGE CPL.
0408002	DICHTUNG	PACKING	JOINT
0330200	VERSCHLUSSRAUBE 1/8"	SCREW 1/8"	VIS 1/8"
9505394	MISCHBEHÄLTER	MIXING CHAMBER	RESERVOIR DE MELANGE
8302895	HALTERING	RING	BAGUE
0113129	ANSCHLUSSTÜCK	CONNECTION PART	PIECE DE CONNEXION
0408225	DICHTUNG	PACKING	JOINT

4.4 FRISCHWASSERKLARSPÜLUNG, VERSETZT



4.4 FRESH WATER FINAL RINSE, DISPLACED

4.4 RINCAGE FINAL A L'EAU CLAIRE, DEPLACE

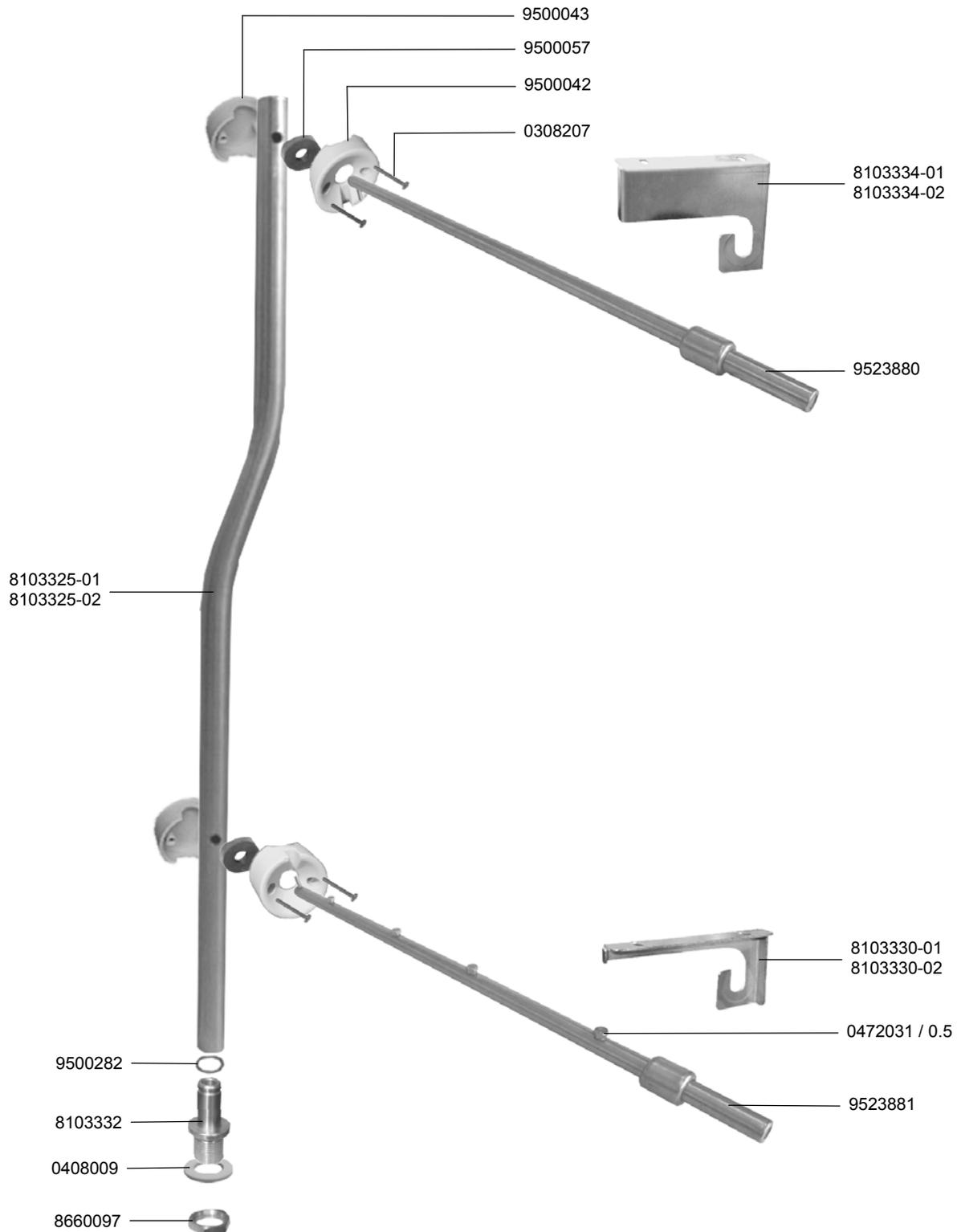

4.4 FRISCHWASSERKLARSPÜLUNG, VERSETZT



4.4 FRESH WATER FINAL RINSE, DISPLACED

4.4 RINCAGE FINAL A L'EAU CLAIRE, DEPLACE

IDENT.-NR. IDENT.-NO.	BEZEICHNUNG	DESIGNATION	DESIGNATION
* 9500043	KUPPLUNG RÜCKTEIL	CLUTCH BACK PART.	ACCOUPEMENT ARRIERE
* 9500057	DICHTUNG	PACKING	JOINT
* 9500042	KUPPLUNG VORDERTEIL	CLUTCH FRONT PART	ACCOUPEMENT FRONTALE
0308207	SCHRAUBE M4X10	SCREW M4X10	VIS M4X10
8103334-01	HALTERUNG OBEN L-R	UPPER SUPPORT L-R	SUPPORT SUP. G-D
8103334-02	HALTERUNG OBEN R-L	UPPER SUPPORT R-L	SUPPORT SUP. D-G
9523880	WASCHARM OBEN KPL.	UPPER WASH ARM CPL.	BRAS DE LAVAGE SUP. CPL.
8103330-01	HALTERUNG UNTEN L-R	LOWER SUPPORT L-R	SUPPORT INF. G-D
8103330-02	HALTERUNG UNTEN R-L	LOWER SUPPORT R-L	SUPPORT INF. D-G
* 0472031	DÜSE 0.5	NOZZLE 0.5	GICLEUR 0.5
9523881	WASCHARM UNTEN KPL.	LOWER WASH ARM CPL.	BRAS DE LAVAGE INF. CPL.
8660097	SKT.MUTTER	HEXAGON NUT	ECROU A 6 PANS
0408009	DICHTUNG	PACKING	JOINT
8103332	TANKDURCHFÜHRUNG	TANK THROUGH-LEAD	TRAVERSEE DU BAC
9500282	O-RING	O-RING	BAGUE
8103325-02	STEIGROHR R-L	ASCENDING PIPE R-L	COLONNE ASCENDANTE D-G
8103325-01	STEIGROHR L-R	ASCENDING PIPE L-R	CONDUITE ASCENDANTE G-D

4.5 FRISCHWASSERKLARSPÜLUNG



4.5 FRESH WATER FINAL RINSE

4.5 RINCAGE FINAL A L'EAU CLAIRE

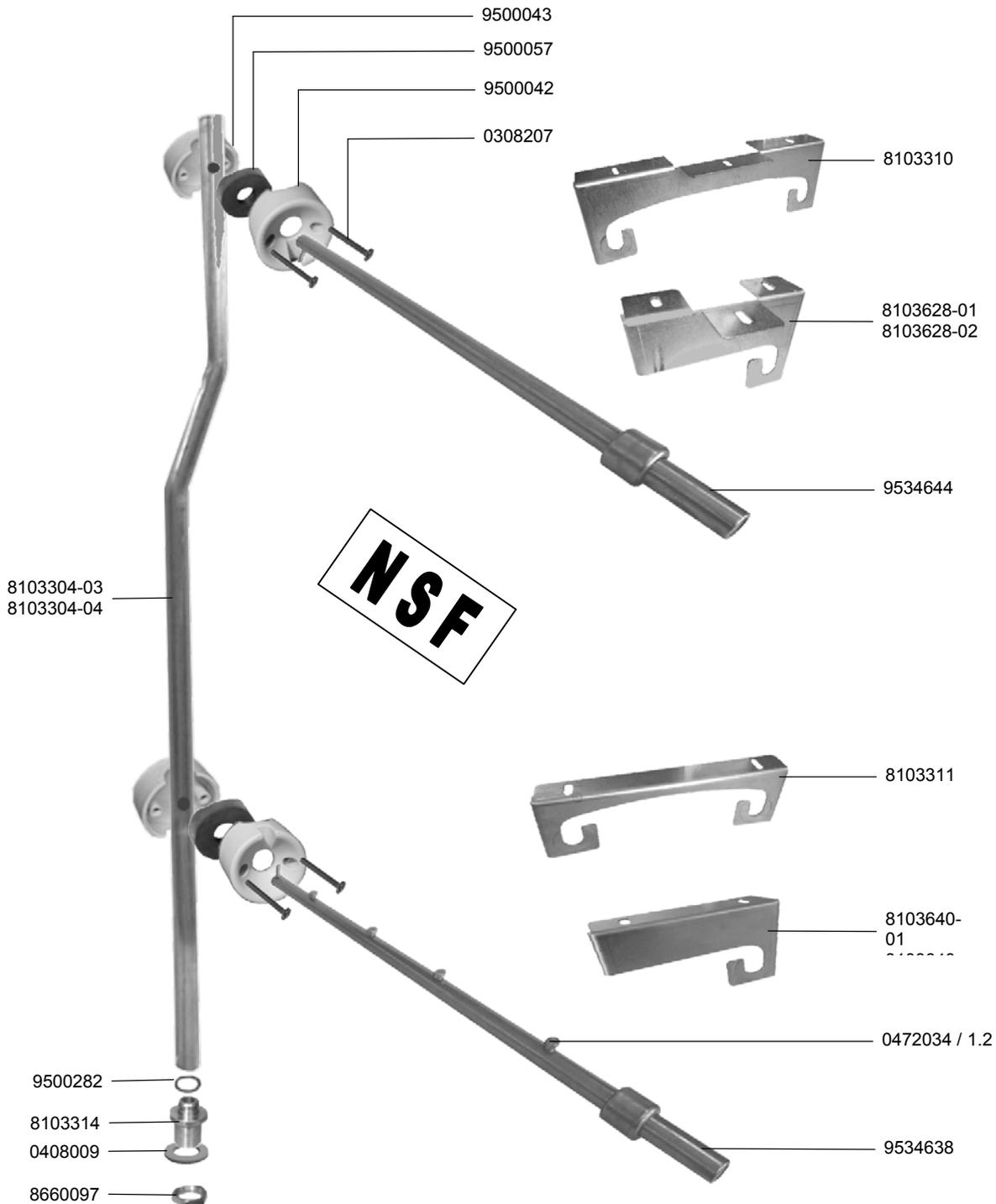

4.5 FRISCHWASSERKLARSPÜLUNG



4.5 FRESH WATER FINAL RINSE

4.5 RINCAGE FINAL A L'EAU CLAIRE

IDENT.-NR. IDENT.-NO.	BEZEICHNUNG	DESIGNATION	DESIGNATION
* 9500043	KUPPLUNG RÜCKTEIL	CLUTCH BACK PART.	ACCOUPLLEMENT ARRIERE
* 9500057	DICHTUNG	PACKING	JOINT
* 9500042	KUPPLUNG VORDERTEIL	CLUTCH FRONT PART	ACCOUPLLEMENT FRONTALE
0308207	SCHRAUBE M4X10	SCREW M4X10	VIS M4X10
8103310	HALTERUNG OBEN	UPPER SUPPORT	SUPPORT SUP.
8103628-01	HALTERUNG OBEN L-R	UPPER SUPPORT L-R	SUPPORT SUP. G-D
8103628-02	HALTERUNG OBEN R-L	UPPER SUPPORT R-L	SUPPORT SUP. D-G
9534644	WASCHARM OBEN KPL.	UPPER WASH ARM CPL.	BRAS DE LAVAGE SUP. CPL.
8103311	HALTERUNG UNTEN	LOWER SUPPORT	SUPPORT INF.
8103640-01	HALTERUNG UNTEN L-R	LOWER SUPPORT L-R	SUPPORT INF. G-D
8103640-02	HALTERUNG UNTEN R-L	LOWER SUPPORT R-L	SUPPORT INF. D-G
* 0472034	DÜSE 1.2	NOZZLE 1.2	GICLEUR 1.2
9534638	WASCHARM UNTEN KPL.	LOWER WASH ARM CPL.	BRAS DE LAVAGE INF. CPL.
8660097	SKT.MUTTER	HEXAGON NUT	ECROU A 6 PANS
0408009	DICHTUNG	PACKING	JOINT
8103314	TANKDURCHFÜHRUNG	TANK THROUGH-LEAD	TRAVERSEE DU BAC
9500282	O-RING	O-RING	BAGUE
8103304-04	STEIGROHR RECHTS	ASCENDING PIPE RIGHT	CONDUITE ASCENDANTE DROITE
8103304-03	STEIGROHR LINKS	ASCENDING PIPE LEFT	CONDUITE ASCENDANTE GAUGE

4.6 FRISCHWASSERKLARSPÜLUNG, VERSETZT



4.6 FRESH WATER FINAL RINSE, DISPLACED

4.6 RINCAGE FINAL A L'EAU CLAIRE, DEPLACE

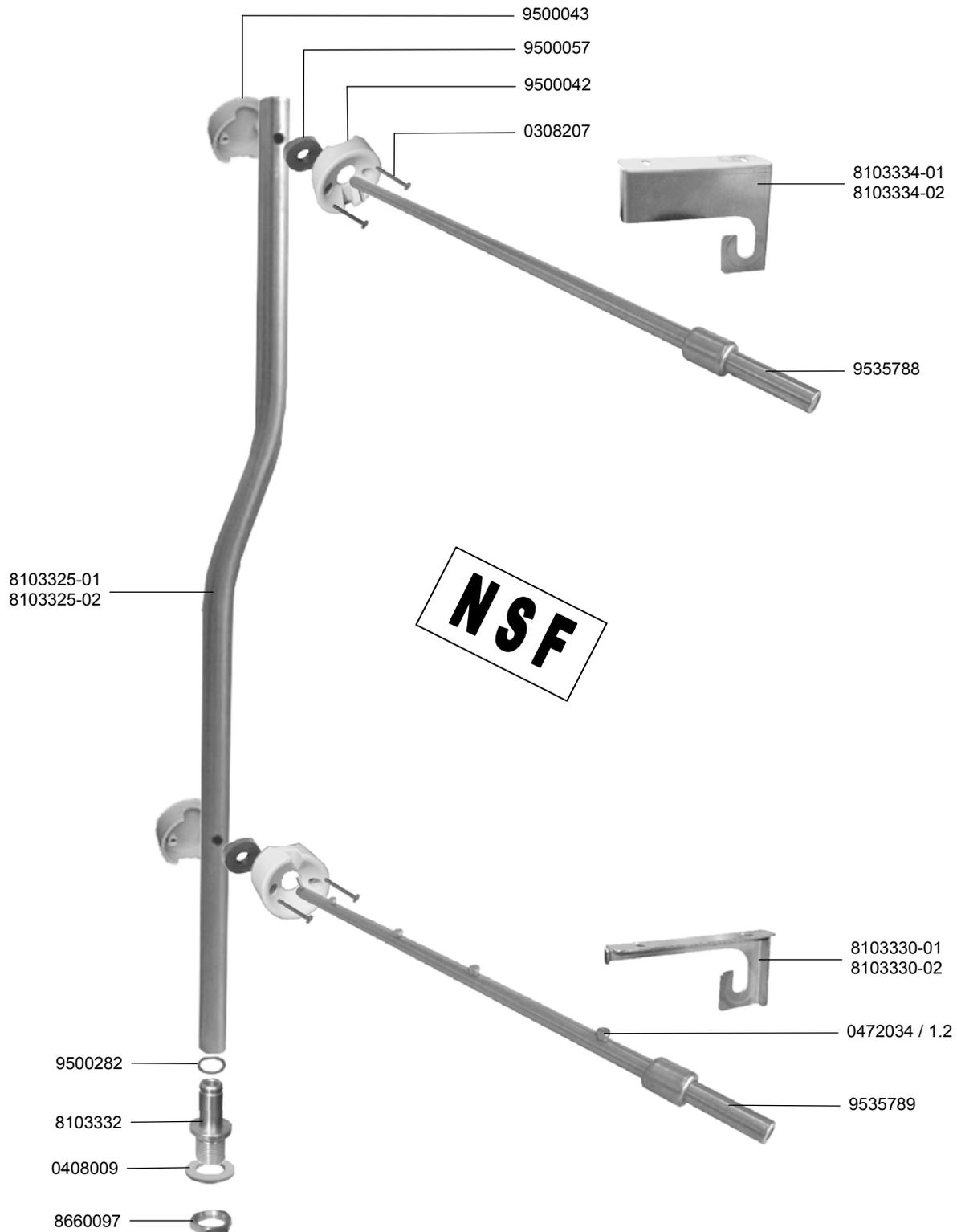

4.6 FRISCHWASSERKLARSPÜLUNG, VERSETZT



4.6 FRESH WATER FINAL RINSE, DISPLACED

4.6 RINCAGE FINAL A L'EAU CLAIRE, DEPLACE

IDENT.-NR. IDENT.-NO.	BEZEICHNUNG	DESIGNATION	DESIGNATION
* 9500043	KUPPLUNG RÜCKTEIL	CLUTCH BACK PART.	ACCOUPEMENT ARRIERE
* 9500057	DICHTUNG	PACKING	JOINT
* 9500042	KUPPLUNG VORDERTEIL	CLUTCH FRONT PART	ACCOUPEMENT FRONTALE
0308207	SCHRAUBE M4X10	SCREW M4X10	VIS M4X10
8103334-01	HALTERUNG OBEN L-R	UPPER SUPPORT L-R	SUPPORT SUP. G-D
8103334-02	HALTERUNG OBEN R-L	UPPER SUPPORT R-L	SUPPORT SUP. D-G
9535788	WASCHARM OBEN KPL.	UPPER WASH ARM CPL.	BRAS DE LAVAGE SUP. CPL.
8103330-01	HALTERUNG UNTEN L-R	LOWER SUPPORT L-R	SUPPORT INF. G-D
8103330-02	HALTERUNG UNTEN R-L	LOWER SUPPORT R-L	SUPPORT INF. D-G
* 0472034	DÜSE 1.2	NOZZLE 1.2	GICLEUR 1.2
9535789	WASCHARM UNTEN KPL.	LOWER WASH ARM CPL.	BRAS DE LAVAGE INF. CPL.
8660097	SKT.MUTTER	HEXAGON NUT	ECROU A 6 PANS
0408009	DICHTUNG	PACKING	JOINT
8103332	TANKDURCHFÜHRUNG	TANK THROUGH-LEAD	TRAVERSEE DU BAC
9500282	O-RING	O-RING	BAGUE
8103325-02	STEIGROHR R-L	ASCENDING PIPE R-L	COLONNE ASCENDANTE D-G
8103325-01	STEIGROHR L-R	ASCENDING PIPE L-R	CONDUITE ASCENDANTE G-D

5.1 PUMPENKLARSPÜLUNG, SPRÜHSYSTEM



5.1 PUMP FINAL RINSE, SPRAYING SYSTEM

5.1 RINCAGE FINAL A POMPE, SYSTEME D' ARROSAGE

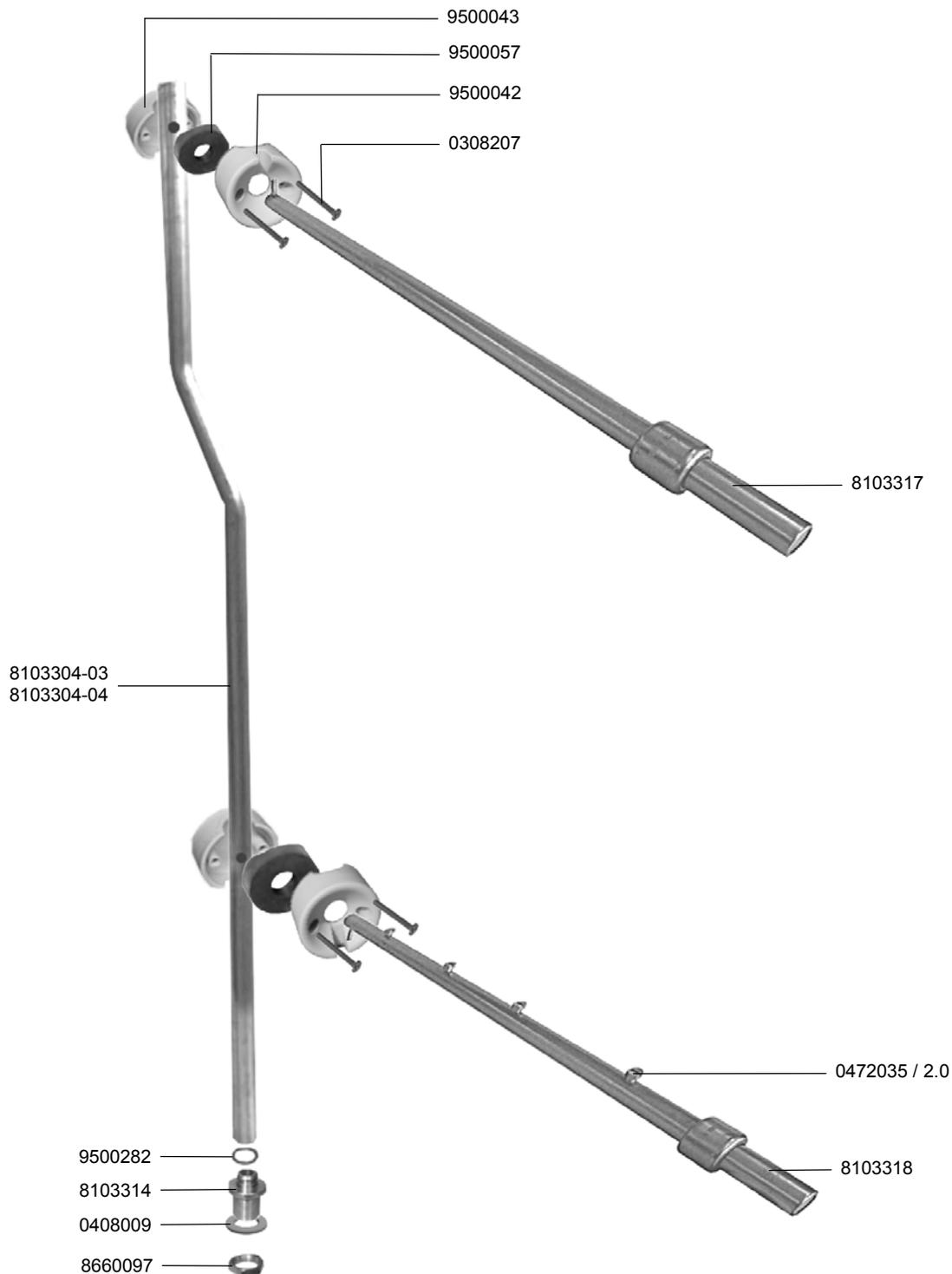

5.1 PUMPENKLARSPÜLUNG, SPRÜHSYSTEM



5.1 PUMP FINAL RINSE, SPRAYING SYSTEM

5.1 RINCAGE FINAL A POMPE, SYSTEME D' ARROSAGE

IDENT.-NR. IDENT.-NO.	BEZEICHNUNG	DESIGNATION	DESIGNATION
* 9500043	KUPPLUNG RÜCKTEIL	CLUTCH BACK PART.	ACCOUPEMENT ARRIERE
* 9500057	DICHTUNG	PACKING	JOINT
* 9500042	KUPPLUNG VORDERTEIL	CLUTCH FRONT PART	ACCOUPEMENT FRONTALE
0308207	SCHRAUBE M4X10	SCREW M4X10	VIS M4X10
8103317	WASCHARM OBEN KPL.	UPPER WASH ARM CPL.	BRAS DE LAVAGE SUP. CPL.
* 0472035	DÜSE 2.0	NOZZLE 2.0	GICLEUR 2.0
8103318	WASCHARM UNTEN KPL.	LOWER WASH ARM CPL.	BRAS DE LAVAGE INF. CPL.
8660097	SKT.MUTTER	HEXAGON NUT	ECROU A 6 PANS
0408009	DICHTUNG	PACKING	JOINT
8103314	TANKDURCHFÜHRUNG	TANK THROUGH-LEAD	TRAVERSEE DU BAC
9500282	O-RING	O-RING	BAGUE
8103304-04	STEIGROHR RECHTS	ASCENDING PIPE RIGHT	CONDUITE ASCENDANTE DROITE
8103304-03	STEIGROHR LINKS	ASCENDING PIPE LEFT	CONDUITE ASCENDANTE GAUGE

5.2 PUMPENKLARSPÜLUNG, PUMPENANSAUGUNG



5.2 PUMP FINAL RINSE, INDUCTION OF PUMP

5.2 RINCAGE FINAL A POMPE, ASPIRATION DE POMPE

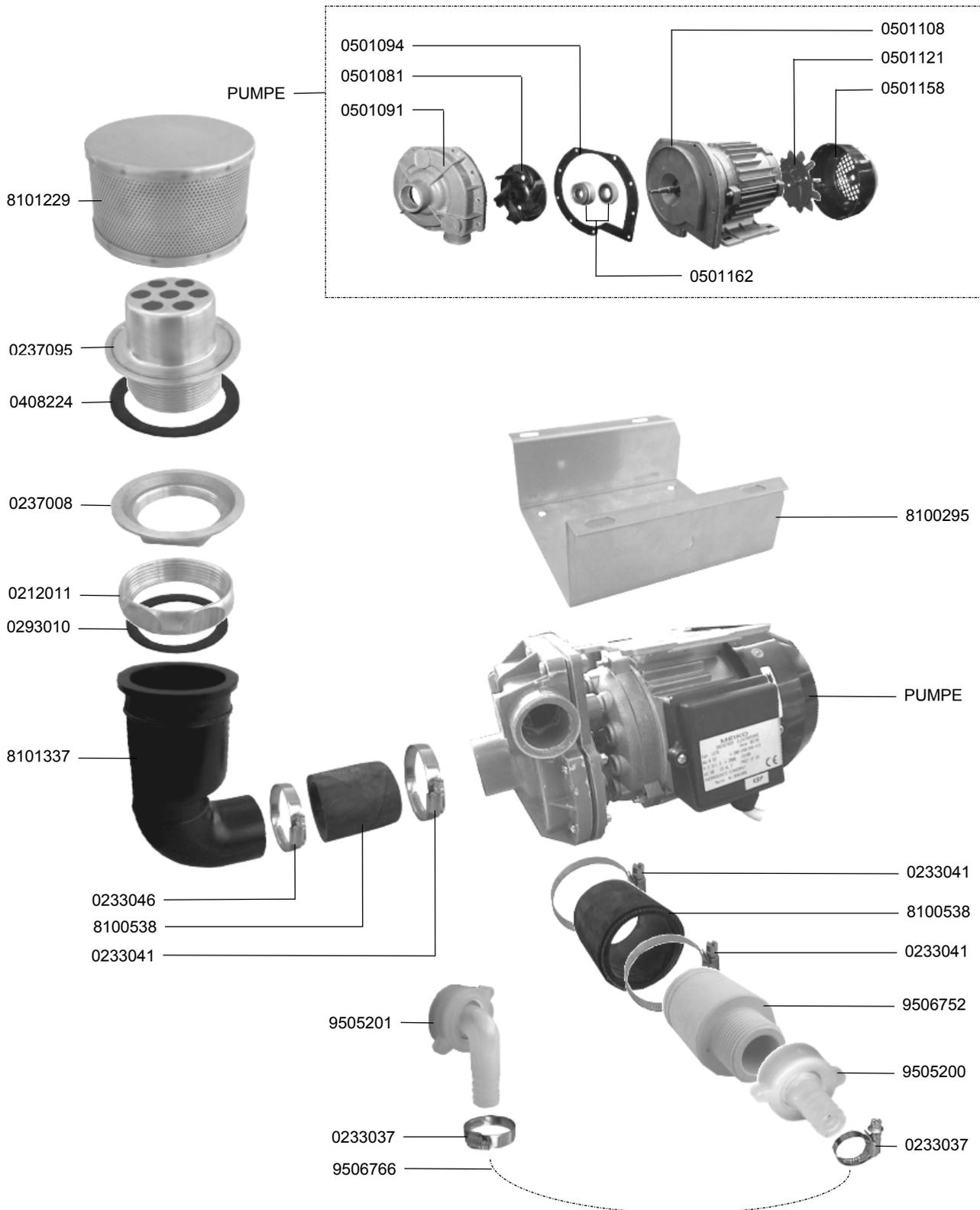

5.2 PUMPENKLARSPÜLUNG, PUMPENANSAUGUNG



5.2 PUMP FINAL RINSE, INDUCTION OF PUMP

5.2 RINÇAGE FINAL A POMPE, ASPIRATION DE POMPE

IDENT.-NR. IDENT.-NO.	BEZEICHNUNG	DESIGNATION	DESIGNATION
PUMPE	SIEHE ELEKTROSCHALTPLAN	SEE ELECTRIC WIRING DIAGRAM	VOIR SCHEMA ELECTRIQUE
0501094	DICHTUNG	PACKING	JOINT
* 0501081	PUMPENLAUFRAD	PUMP WHEEL	ROUE DE POMPE
0501091	PUMPENGEHÄUSE	PUMP HOUSING	CORPS DE POMPE
0501108	PUMPENDECKEL	PUMP LID	COUVERCLE DE POMPE
0501121	VENTILATORFLÜGEL	FAN WHEEL	ROUE VENTILATEUR
0501158	LÜFTERHAUBE	FAN COWL	CAPOTAGE DE VENTILATEUR
V 0501162	GLEITRINGDICHTUNG	SLIDING SEAL	JOINT AXIAL
8100295	KONSOLE	CONSOLE	CONSOLE
0233041	SCHLAUCHKLEMME 40-60	HOSE WIRE CLAMP 40-60	COLLIER DE SERRAGE 40-60
8100538	SCHLAUCH	HOSE	TUYAU
9506752	VERBINDUNGSTEIL	CONNECTION PART	PIECE DE CONNEXION
9505200	ANSCHLUSSTÜCK	CONNECTION PART	PIECE DE CONNEXION
0233037	SCHLAUCHKLEMME 16-27	HOSE WIRE CLAMP 16-27	COLLIER DE SERRAGE 16-27
9506766	SCHLAUCH	HOSE	TUYAU
9505201	ANSCHLUSWINKEL	CONNECTION ANGLE	ANGLE DE CONNEXION
0233046	SCHLAUCHKLEMME 32-50	HOSE WIRE CLAMP 32 50	COLLIER D' SERRAGE 32-50
8101337	ANSAUGSTUTZEN	SUCTION PORT	MANCHON DE ASPIRATION
0293010	DICHTUNG	PACKING	JOINT
0212011	ÜBERWURFMUTTER 2"	SLEEVE NUT 2"	ECROU RACCORD 2"
0237008	MUTTER 2"	NUT 2"	ECROU 2"
0408224	DICHTUNG	PACKING	JOINT
0237095	ANSAUGSIEB	SUCTION SIEVE	FILTRE D' ASPIRATION
8101229	ANSAUGSIEB	SUCTION SIEVE	FILTRE D' ASPIRATION

**5.3 PUMPENKLARSPÜLUNG, SPRÜHSYSTEM,
DOPPELTE KLARSPÜLARME**



**5.3 PUMP FINAL RINSE, SPRAYING SYSTEM,
DOUBLE RINSE ARMS**

**5.3 RINCAGE FINAL A POMPE, SYSTEME D' ARROSAGE,
DOUBLE BRAS DE RINCAGE**

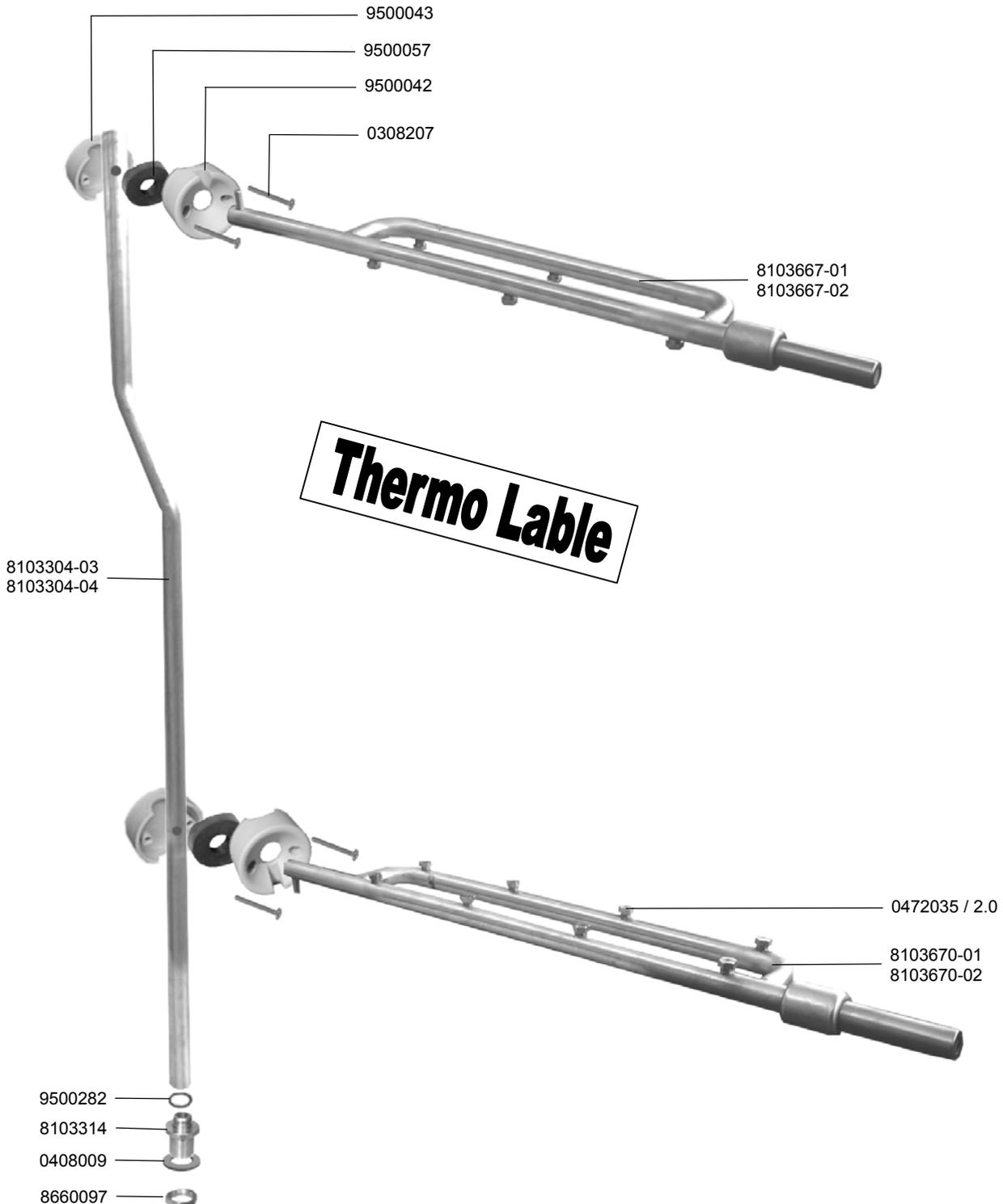

5.3 PUMPENKLARSPÜLUNG, SPRÜHSYSTEM, DOPPELTE KLARSPÜLARME



5.3 PUMP FINAL RINSE, SPRAYING SYSTEM, DOUBLE RINSE ARMS

5.3 RINCAGE FINAL A POMPE, SYSTEME D' ARROSAGE, DOUBLE BRAS DE RINCAGE

IDENT.-NR. IDENT.-NO.	BEZEICHNUNG	DESIGNATION	DESIGNATION
* 9500043	KUPPLUNG RÜCKTEIL	CLUTCH BACK PART.	ACCOUPLLEMENT ARRIERE
* 9500057	DICHTUNG	PACKING	JOINT
* 9500042	KUPPLUNG VORDERTEIL	CLUTCH FRONT PART	ACCOUPLLEMENT FRONTALE
0308207	SCHRAUBE M4X10	SCREW M4X10	VIS M4X10
8103667-01	WASCHARM OBEN KPL. L-R	UPPER WASH ARM CPL. L-R	BRAS DE LAVAGE SUP. CPL. G-D
8103667-02	WASCHARM OBEN KPL. R-L	UPPER WASH ARM CPL. R-L	BRAS DE LAVAGE INF. SUP. D-G
* 0472035	DÜSE 2.0	NOZZLE 2.0	GICLEUR 2.0
8103670-01	WASCHARM UNTEN KPL. L-R	LOWER WASH ARM CPL. L-R	BRAS DE LAVAGE INF. CPL. G-D
8103670-02	WASCHARM UNTEN KPL. R-L	LOWER WASH ARM CPL. R-L	BRAS DE LAVAGE INF. CPL. D-G
8660097	SKT.MUTTER	HEXAGON NUT	ECROU A 6 PANS
0408009	DICHTUNG	PACKING	JOINT
8103314	TANKDURCHFÜHRUNG	TANK THROUGH-LEAD	TRAVERSEE DU BAC
9500282	O-RING	O-RING	BAGUE
8103304-04	STEIGROHR RECHTS	ASCENDING PIPE RIGHT	CONDUITE ASCENDANTE DROITE
8103304-03	STEIGROHR LINKS	ASCENDING PIPE LEFT	CONDUITE ASCENDANTE GAUGE

5.4 PUMPENKLARSPÜLUNG, SPRÜHSYSTEM



5.4 PUMP FINAL RINSE, SPRAYING SYSTEM

5.4 RINCAGE FINAL A POMPE, SYSTEME D' ARROSAGE

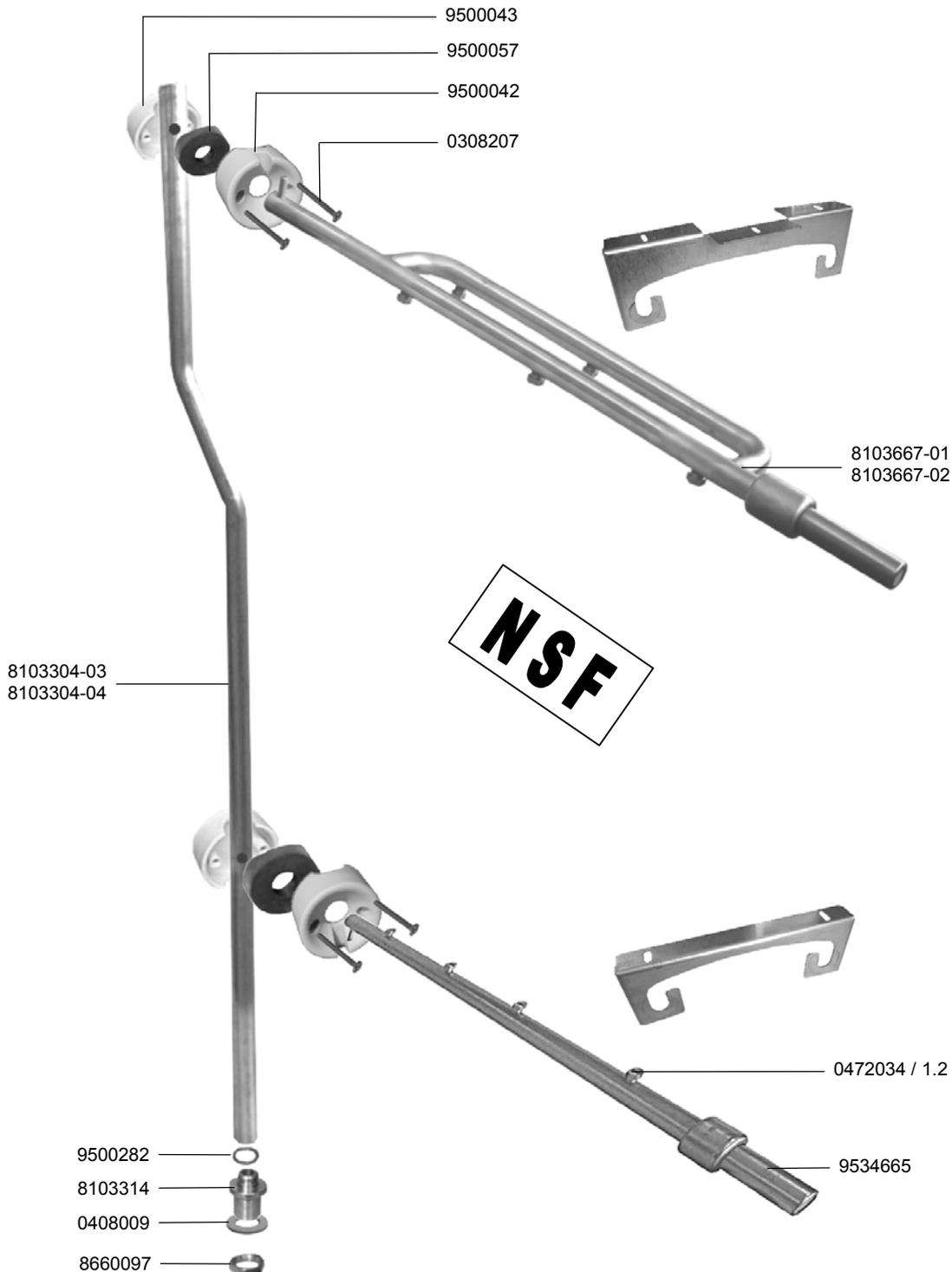

5.4 PUMPENKLARSPÜLUNG, SPRÜHSYSTEM



5.4 PUMP FINAL RINSE, SPRAYING SYSTEM

5.4 RINCAGE FINAL A POMPE, SYSTEME D' ARROSAGE

IDENT.-NR. IDENT.-NO.	BEZEICHNUNG	DESIGNATION	DESIGNATION
* 9500043	KUPPLUNG RÜCKTEIL	CLUTCH BACK PART.	ACCOUPLLEMENT ARRIERE
* 9500057	DICHTUNG	PACKING	JOINT
* 9500042	KUPPLUNG VORDERTEIL	CLUTCH FRONT PART	ACCOUPLLEMENT FRONTALE
0308207	SCHRAUBE M4X10	SCREW M4X10	VIS M4X10
8103667-01	WASCHARM OBEN KPL. L-R	UPPER WASH ARM CPL. L-R	BRAS DE LAVAGE SUP. CPL. G-D
8103667-02	WASCHARM OBEN KPL. R-L	UPPER WASH ARM CPL. R-L	BRAS DE LAVAGE SUP. CPL. D-G
* 0472034	DÜSE 1.2	NOZZLE 1.2	GICLEUR 1.2
9534665	WASCHARM UNTEN KPL.	LOWER WASH ARM CPL.	BRAS DE LAVAGE INF. CPL.
8660097	SKT.MUTTER	HEXAGON NUT	ECROU A 6 PANS
0408009	DICHTUNG	PACKING	JOINT
8103314	TANKDURCHFÜHRUNG	TANK THROUGH-LEAD	TRAVERSEE DU BAC
9500282	O-RING	O-RING	BAGUE
8103304-04	STEIGROHR RECHTS	ASCENDING PIPE RIGHT	CONDUITE ASCENDANTE DROITE
8103304-03	STEIGROHR LINKS	ASCENDING PIPE LEFT	CONDUITE ASCENDANTE GAUGE

6.1 DEMIKLARSPÜLUNG, VERSETZT



6.1 DEMI FINAL RINSE, DISPALED

6.1 RINCAGE FINAL A L'EAU DEMINERALISEE, DEPLACE

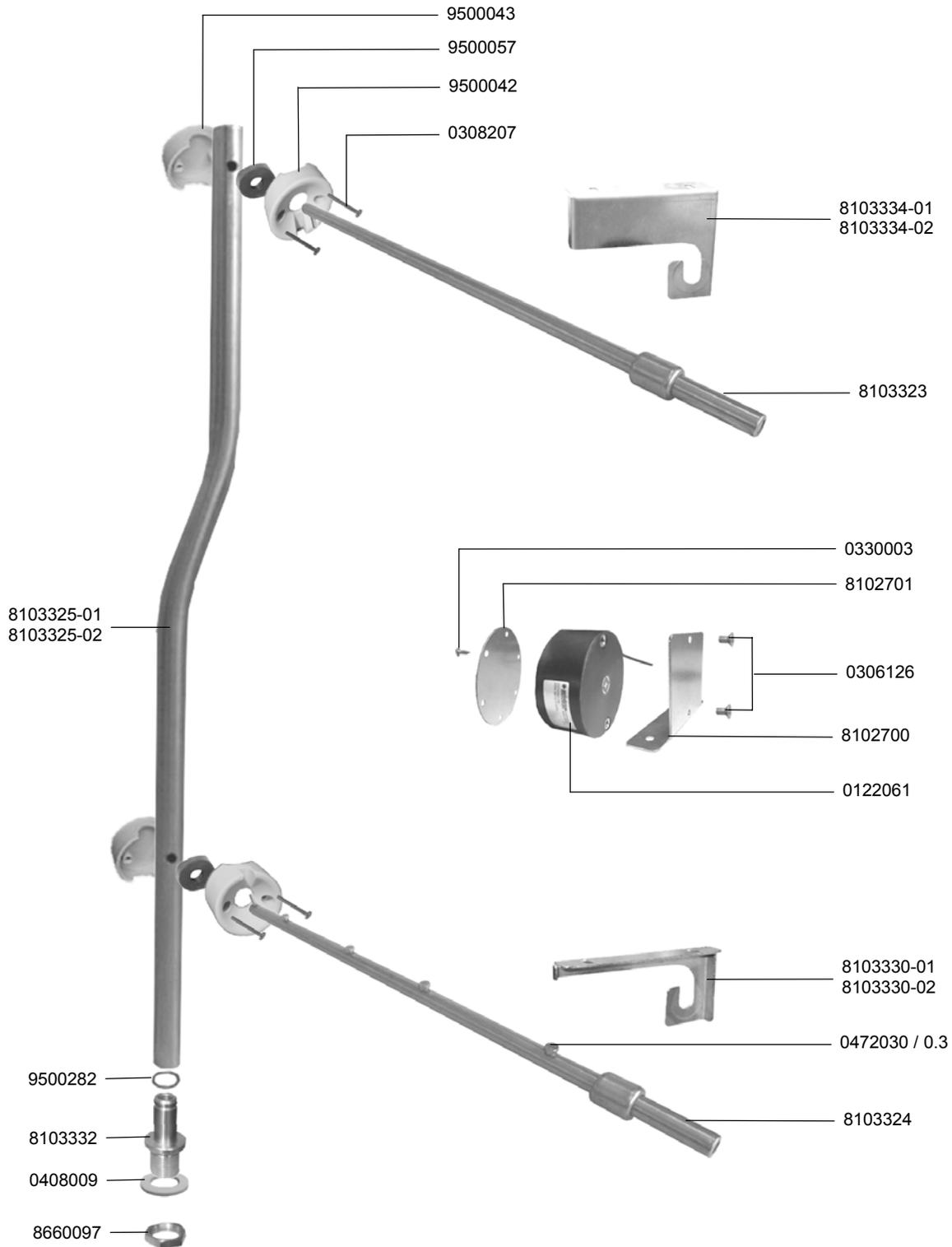

6.1 DEMIKLARSPÜLUNG, VERSETZT



6.1 DEMI FINAL RINSE, DISPACED

6.1 RINCAGE FINAL A L'EAU DEMINERALISEE, DEPLACE

IDENT.-NR. IDENT.-NO.	BEZEICHNUNG	DESIGNATION	DESIGNATION
* 9500043	KUPPLUNG RÜCKTEIL	CLUTCH BACK PART.	ACCOUPLLEMENT ARRIERE
* 9500057	DICHTUNG	PACKING	JOINT
* 9500042	KUPPLUNG VORDERTEIL	CLUTCH FRONT PART	ACCOUPLLEMENT FRONTALE
0308207	SCHRAUBE M4X10	SCREW M4X10	VIS M4X10
8103334-01	HALTERUNG OBEN L-R	UPPER SUPPORT L-R	SUPPORT SUP. G-D
8103334-02	HALTERUNG OBEN R-L	UPPER SUPPORT R-L	SUPPORT SUP. D-G
8103323	WASCHARM OBEN KPL.	UPPER WASH ARM CPL.	BRAS DE LAVAGE SUP. CPL.
0330003	SCHRAUBE 3,5X9,5	SCREW 3,5X9,5	VIS 3,5X9,5
8102701	ABDICHTBLECH	SEALING SHEET	TOLE D' ETANCHEITE
0306126	SCHRAUBE M6X10	SCREW M6X10	VIS M6X10
8102700	HALTERUNG	SUPPORT	SUPPORT
* 0122061	MAGNETSCHALTER	SWITCH	INTERRUPTEUR
8103330-01	HALTERUNG UNTEN L-R	LOWER SUPPORT L-R	SUPPORT INF. G-D
8103330-02	HALTERUNG UNTEN R-L	LOWER SUPPORT R-L	SUPPORT INF. D-G
* 0472030	DÜSE 0.3	NOZZLE 0.3	GICLEUR 0.3
8103324	WASCHARM UNTEN KPL.	LOWER WASH ARM CPL.	BRAS DE LAVAGE INF. CPL.
8660097	SKT.MUTTER	HEXAGON NUT	ECROU A 6 PANS
0408009	DICHTUNG	PACKING	JOINT
8103332	TANKDURCHFÜHRUNG	TANK THROUGH-LEAD	TRAVERSEE DU BAC
9500282	O-RING	O-RING	BAGUE
8103325-02	STEIGROHR R-L	ASCENDING PIPE R-L	CONDUITE ASCENDANTE D-G
8103325-01	STEIGROHR L-R	ASCENDING PIPE L-R	CONDUITE ASCENDANTE G-D

7.1 CSS SPRÜHSYSTEM



7.1 CSS SPRAYING SYSTEM

7.1 CSS SYSTEME D' ARROSAGE

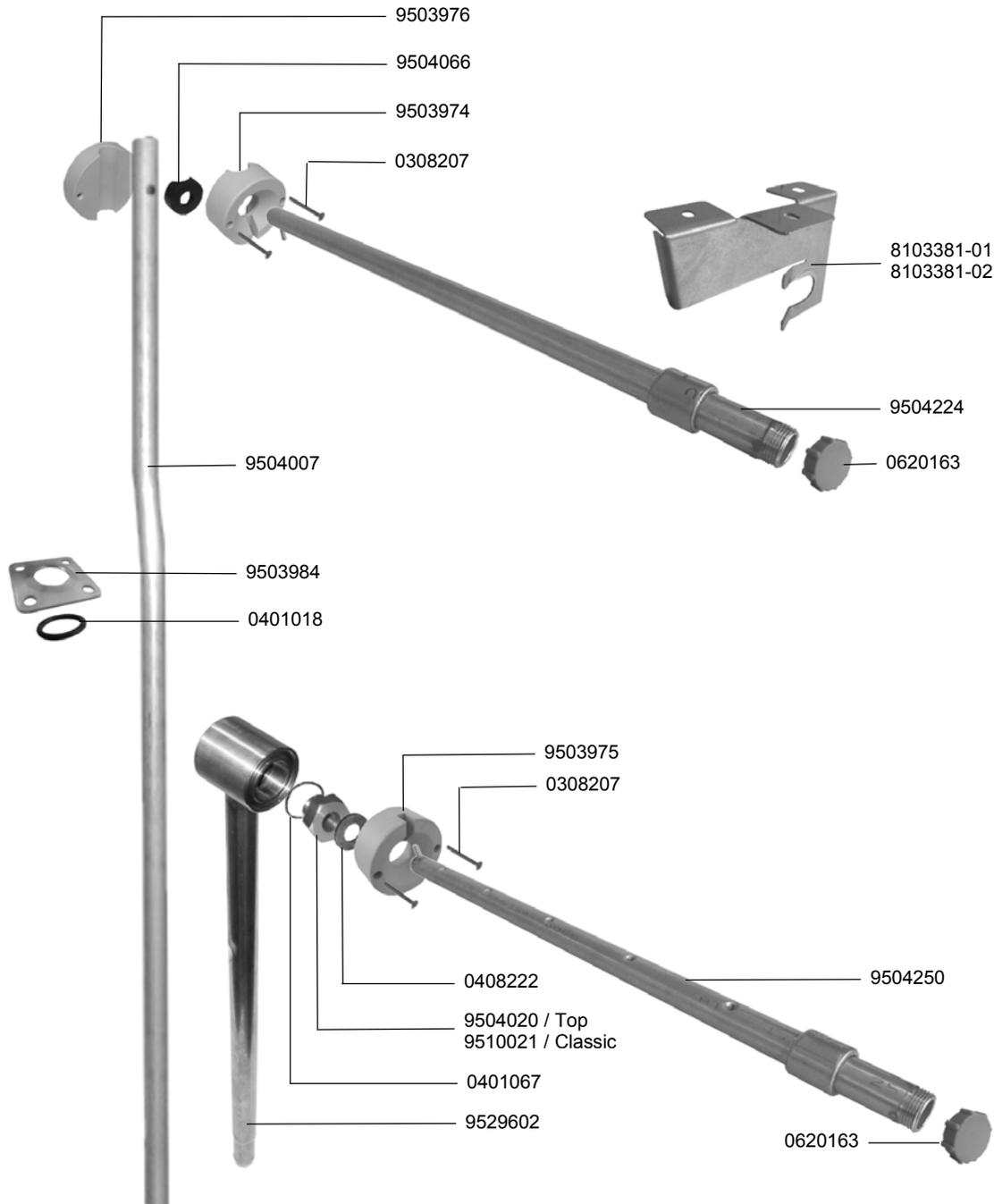

7.1 CSS SPRÜHSYSTEM



7.1 CSS SPRAYING SYSTEM

7.1 CSS SYSTEME D' ARROSAGE

IDENT.-NR. IDENT.-NO.	BEZEICHNUNG	DESIGNATION	DESIGNATION
* 9503976	KUPPLUNG RÜCKTEIL	CLUTCH BACK PART.	ACCOUPLLEMENT ARRIERE
* 9504066	DICHTUNG	PACKING	JOINT
* 9503974	KUPPLUNG VORDERTEIL	CLUTCH FRONT PART	ACCOUPLLEMENT FRONTALE
0308207	SCHRAUBE M4X10	SCREW M4X10	VIS M4X10
8103381-01	HALTERUNG OBEN L-R	UPPER SUPPORT L-R	SUPPORT SUP. G-D
8103381-02	HALTERUNG OBEN R-L	UPPER SUPPORT R-L	SUPPORT SUP. D-G
9504224	WASCHARM OBEN KPL.	UPPER WASH ARM CPL.	BRAS DE LAVAGE SUP. CPL.
* 0620163	DECKEL	LID	COUVERCLE
9504250	WASCHARM UNTEN KPL.	LOWER WASH ARM CPL.	BRAS DE LAVAGE INF. CPL.
9529602	STEIGLEITUNG	ASCENDING PIPE	CONDUITE ASCENDANTE
0401067	O-RING	O-RING	BAGUE
9510021	NIPPEL CLASSIC	NIPPLE CLASSIC	NIPPLE CLASSIC
9504020	NIPPEL TOP	NIPPLE TOP	NIPPLE TOP
0408222	DICHTUNG	PACKING	JOINT
9503975	KUPPLUNG VORDERTEIL	CLUTCH FRONT PART	ACCOUPLLEMENT FRONTALE
0401018	O-RING	O-RING	BAGUE
9503984	FLANSCH	FLANGE	FLASQUE
9504007	STEIGROHR	ASCENDING PIPE	CONDUITE ASCENDANTE

7.2 CSS TOP SPRÜHSYSTEM OBEN



7.2 CSS TOP SPRAYING SYSTEM ABOVE

7.2 CSS TOP SYSTEME D' ARROSAGE EN HAUT

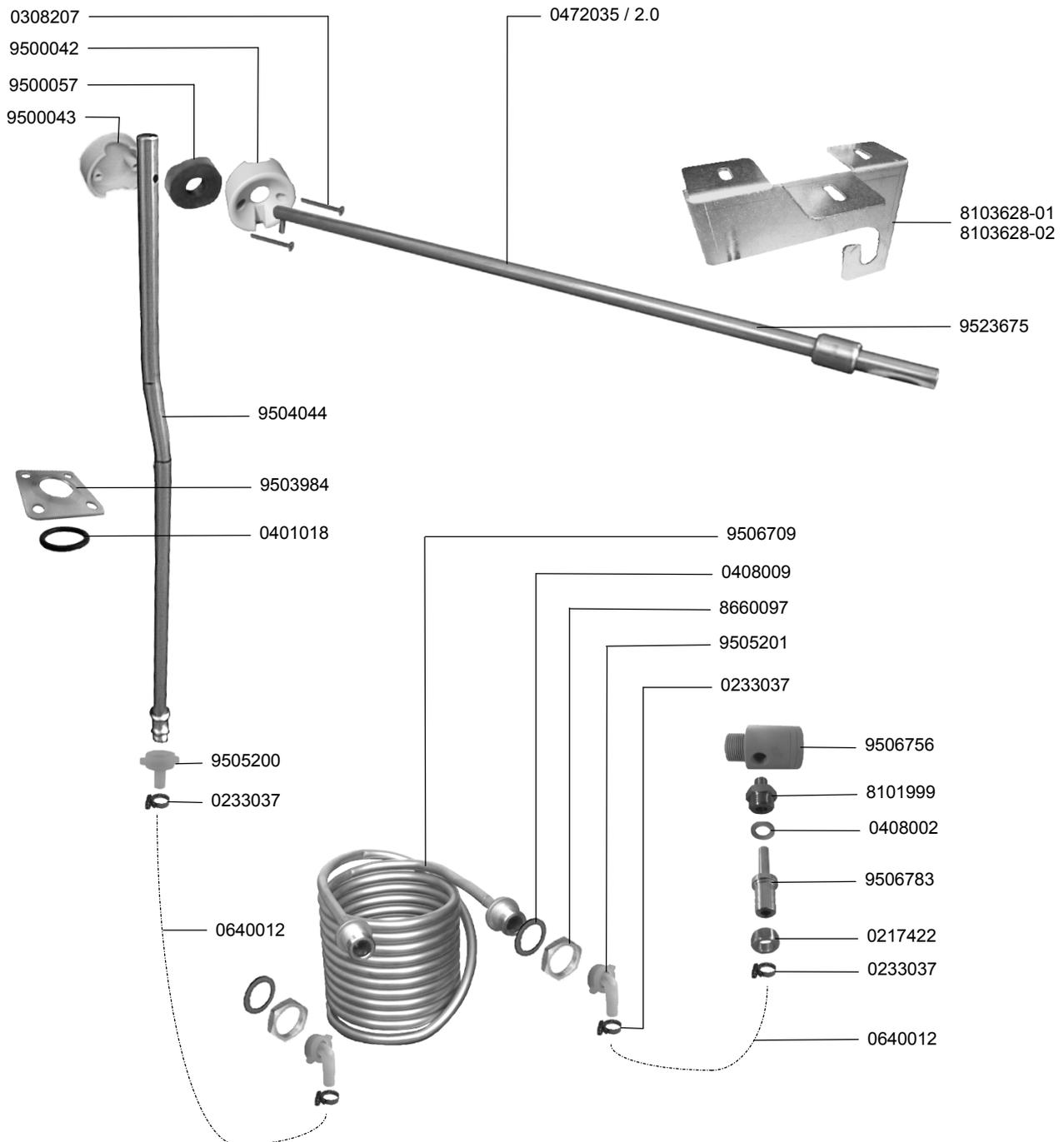

7.2 CSS TOP SPRÜHSYSTEM OBEN



7.2 CSS TOP SPRAYING SYSTEM ABOVE

7.2 CSS TOP SYSTEME D' ARROSAGE EN HAUT

IDENT.-NR. IDENT.-NO.	BEZEICHNUNG	DESIGNATION	DESIGNATION
* 0472035	DÜSE 2.0	NOZZLE 2.0	GICLEUR 2.0
8103628-01	HALTERUNG OBEN L-R	UPPER SUPPORT L-R	SUPPORT SUP. G-D
8103628-02	HALTERUNG OBEN R-L	UPPER SUPPORT R-L	SUPPORT SUP. D-G
9523675	SPÜLARM	FINAL RINSE ARM	BRAS DE RINCAGE FINAL
9506709	WÄRMETAUSCHER	HEAT EXCHANGER	ECHANGEUR DE CHALEUR
0408009	DICHTUNG	PACKING	JOINT
8660097	MUTTER	NUT	ECROU
9505201	ANSCHLUSSWINKEL	CONNECTION ANGLE	ANGLE DE CONNEXION
0233037	SCHLAUCHKLEMME	HOSE WIRE CLAMP	COLLIER DE SERRAGE
9506756	VERBINDUNGSTEIL	CONNECTION PART	PIECE DE CONNEXION
8101999	ADAPTER	ADAPTER	ADAPTEUR
0408002	DICHTUNG	PACKING	JOINT
9506783	BLENDE	STOP	OBTURATEUR
0217422	ÜBERWURFMUTTER	SLEEVE NUT	ECROU RACCORD
0640012	SCHLAUCH	HOSE	TUYAU
9505200	ANSCHLUSSTÜCK	CONNECTION PIECE	PIECE DE CONNEXION
0401018	O-RING	O-RING	BAGUE
9503984	FLANSCHPLATTE	FLANGE	FLASQUE
9504044	STEIGROHR	ASCENDING PIPE	CONDUITE ASCENDANTE
* 9500043	KUPPLUNG RÜCKTEIL	CLUTCH BACK PART	ACCOUPLLEMENT ARRIERE
* 9500057	DICHTUNG	PACKING	JOINT
* 9500042	KUPPLUNG VORDERTEIL	CLUTCH FRONT PART	ACCOUPLLEMENT FRONTALE
0308207	SCHRAUBE M4X10	SCREW M4X10	VIS M4X10

7.3 PUMPENVERROHRUNG CSS CLASSIC



7.3 PIPEWORK FOR CSS CLASSIC

7.3 TUYAUTERIE DE CSS CLASSIC

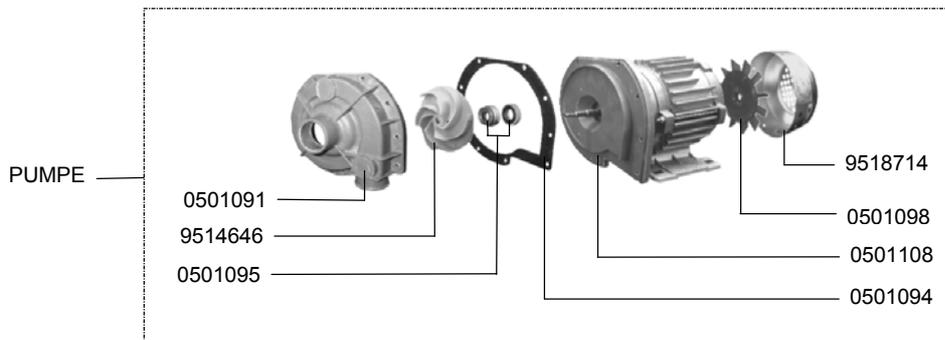
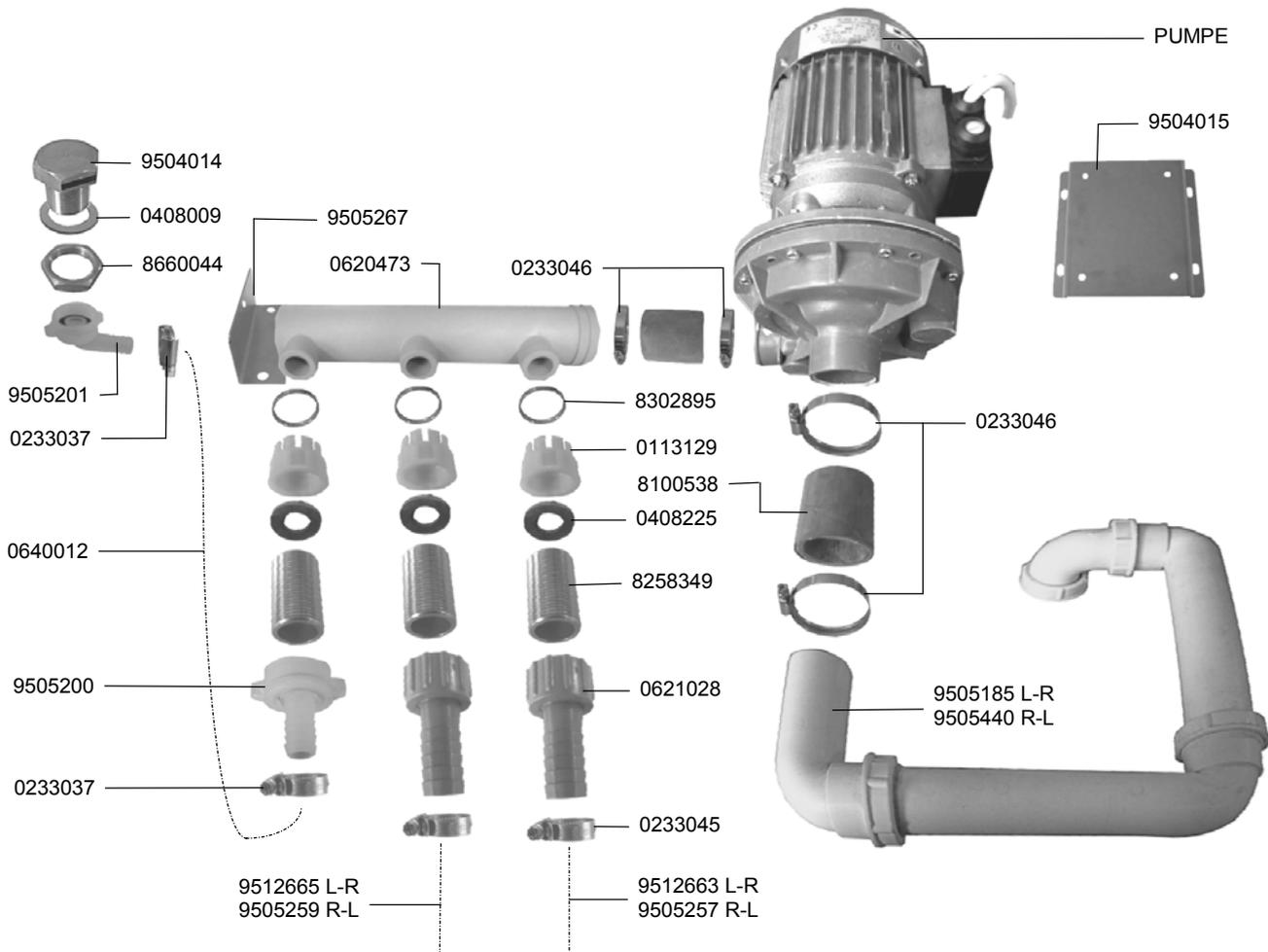

7.3 PUMPENVERROHRUNG CSS CLASSIC



7.3 PIPEWORK FOR CSS CLASSIC

7.3 TUYAUTERIE DE CSS CLASSIC

IDENT.-NR. IDENT.-NO.	BEZEICHNUNG	DESIGNATION	DESIGNATION
PUMPE	SIEHE ELEKTROSCHALTPLAN	SEE ELECTRIC DIAGRAM	VOIR SCHEMA ELECTRIQUE
9504015	KONSOLE	CONSOLE	CONSOLE
0233046	SCHLAUCHKLEMME	HOSE WIRE CLAMP	COLLIER DE SERRAGE
8302895	HALTERING	SUPPORT RING	BAGUE DE SUPPORT
0113129	ANSCHLUSSTÜCK	CONNECTION PIECE	PIECE DE CONNEXION
8100538	SCHLAUCH	HOSE	TUYAU
* 0408225	DICHTUNG	PACKING	JOINT
8258349	GEWINDENIPPEL	NIPPLE	NIPPLE
0621028	ÜBERGANGSSTÜCK	CONNECTOR	PIECE DE RACCORDEMENT
9505185	ANSAUGSTUTZEN L-R	SUCTION SOCKET L-R	MANCHON D'ASPIRATION G-D
9505440	ANSAUGSTUTZEN R-L	SUCTION SOCKET R-L	MANCHON D'ASPIRATION D-G
0233045	SCHLAUCHKLEMME	HOSE WIRE CLAMP	COLLIER DE SERRAGE
9512663	SCHLAUCH L-R	HOSE L-R	TUYAU G-D
9505257	SCHLAUCH R-L	HOSE R-L	TUYAU D-G
9518714	LÜFTERHAUBE	FAN HOOD	CAPOTAGE DE VENTILATEUR
0501098	VENTILATORFLÜGEL	FAN WHEEL	ROUE VENTILATEUR
0501108	PUMPENDECKEL	PUMP LID	COUVERCLE DE POMPE
0501094	DICHTUNG	PACKING	JOINT
V 0501095	GLEITRINGDICHTUNG	SLIDING SEAL	JOINT AXIAL
* 9514646	PUMPENLAUFRAD	PUMP WHEEL	ROUE DE POMPE
0501091	PUMPENGEHÄUSE	PUMP HOUSING	CORPS DE POMPE
9505259	SCHLAUCH R-L	HOSE R-L	TUYAU D-G
9512665	SCHLAUCH L-R	HOSE L-R	TUYAU G-D
0233037	SCHLAUCHKLEMME	HOSE WIRE CLAMP	COLLIER DE SERRAGE
9505200	ANSCHLUSSTÜCK	CONNECTION PIECE	PIECE DE CONNEXION
0640012	SCHLAUCH	HOSE	TUYAU
9505201	ANSCHLUSWINKEL	CONNECTION ANGLE	ANGLE DE CONNEXION
8660044	MUTTER	NUT	ECROU
0408009	DICHTUNG	PACKING	JOINT
9504014	FLACHSTRAHLDÜSE	NOZZLE	GICLEUR
9505267	HALTERUNG	SUPPORT	SUPPORT
0620473	VERTEILERROHR	DISTRIBUTING PIPE	TUYAU DISTRIBUTEUR

7.4 PUMPENVERROHRUNG CSS TOP



7.4 PIPEWORK FOR CSS TOP

7.4 TUYAUTERIE DE CSS TOP

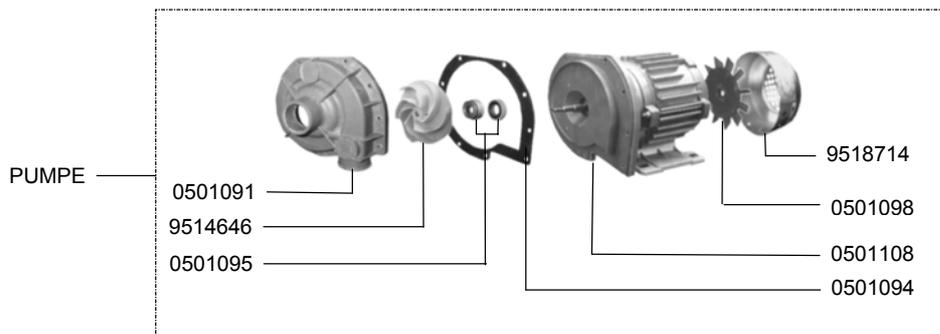
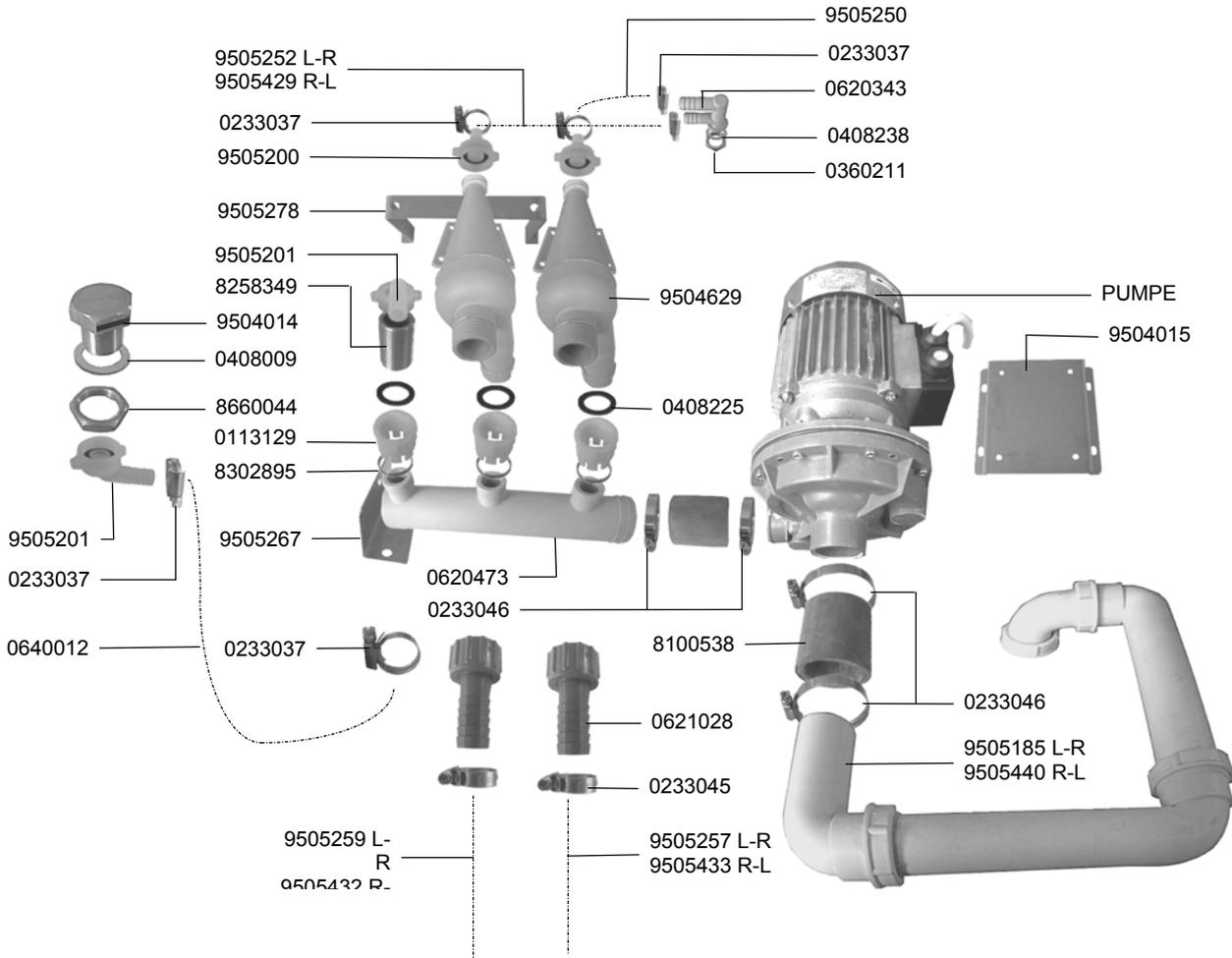

7.4 PUMPENVERROHRUNG CSS TOP



7.4 PIPEWORK FOR CSS TOP

7.4 TUYAUTERIE DE CSS TOP

IDENT.-NR. IDENT.-NO.	BEZEICHNUNG	DESIGNATION	DESIGNATION
9505250	SCHLAUCH	HOSE	TUYAU
0233037	SCHLAUCHKLEMME	HOSE WIRE CLAMP	COLLIER DE SERRAGE
0620343	SCHLAUCHANSCHLUSS	HOSE CONNECTION	CONNEXION DE TUYAU
0408238	DICHTUNG	PACKING	JOINT
0360211	MUTTER	NUT	ECROU
* 9504629	ZYKLONGEHÄUSE	CYCLONE HOUSING	CORPS CYCLONE
* 0408225	DICHTUNG	PACKING	JOINT
PUMPE	SIEHE ELEKTROSCHALTPLAN	SEE ELECTRIC DIAGRAM	VOIR SCHEMA ELECTRIQUE
9504015	KONSOLE	CONSOLE	CONSOLE
8100538	SCHLAUCH	HOSE	TUYAU
0233046	SCHLAUCHKLEMME	HOSE WIRE CLAMP	COLLIER DE SERRAGE
0621028	ÜBERGANGSSTÜCK	CONNECTOR	PIECE DE RACCORDEMENT
9505185	ANSAUGSTUTZEN L-R	SUCTION PORT L-R	MANCHON D' ASPIRATION G-D
9505440	ANSAUGSTUTZEN R-L	SUCTION PORT R-L	MANCHON D' ASPIRATION D-G
0233045	SCHLAUCHKLEMME	HOSE WIRE CLAMP	COLLIER DE SERRAGE
9505257	SCHLAUCH L-R	HOSE L-R	TUYAU G-D
9505433	SCHLAUCH R-L	HOSE R-L	TUYAU D-G
9518714	LÜFTERHAUBE	FAN COWL	CAPOTAGE DE VENTILATEUR
0501098	VENTILATORFLÜGEL	FAN WHEEL	ROUE VENTILATEUR
0501108	PUMPENDECKEL	PUMP LID	COUVERCLE DE POMPE
0501094	DICHTUNG	PACKING	JOINT
V 0501095	GLEITRINGDICHTUNG	SLIDING SEAL	JOINT AXIAL
* 9514646	PUMPENLAUFRAD	PUMP WHEEL	ROUE DE POMPE
0501091	PUMPENGEHÄUSE	PUMP HOUSING	CORPS DE POMPE
9505432	SCHLAUCH R-L	HOSE R-L	TUYAU D-G
9505259	SCHLAUCH L-R	HOSE L-R	TUYAU G-D
0640012	SCHLAUCH	HOSE	TUYAU
0620473	VERTEILERROHR	DISTRIBUTING PIPE	TUYAU DISTRIBUTEUR
9505267	HALTERUNG	SUPPORT	SUPPORT
9505201	ANSCHLUSWINKEL	CONNECTION ANGLE	ANGLE DE CONNEXION
8302895	HALTERING	SUPPORT RING	BAGUE DE SUPPORT
0113129	ANSCHLUSSTÜCK	CONNECTION PIECE	PIECE DE CONNEXION
8660044	MUTTER	NUT	ECROU
0408009	DICHTUNG	PACKING	JOINT
* 9504014	FLACHSTRAHLDÜSE	NOZZLE	GICLEUR

7.4 PUMPENVERROHRUNG CSS TOP



7.4 PIPEWORK FOR CSS TOP

7.4 TUYAUTERIE DE CSS TOP

IDENT.-NR. IDENT.-NO.	BEZEICHNUNG	DESIGNATION	DESIGNATION
8258349	GEWINDENIPPEL	NIPPLE	NIPPLE
9505278	HALTEBÜGEL	SUPPORT	SUPPORT
9505200	ANSCHLUSSTÜCK	CONNECTION PIECE	PIECE DE CONNEXION
9505429	SCHLAUCH R-L	HOSE R-L	TUYAU D-G
9505252	SCHLAUCH L-R	HOSE L-R	TUYAU G-D

7.5 ANSAUGSYSTEM, ABLAUF



7.5 SUCTION SYSTEM, DRAIN

7.5 SYSTEME D'ASPIRATION, VIDANGE

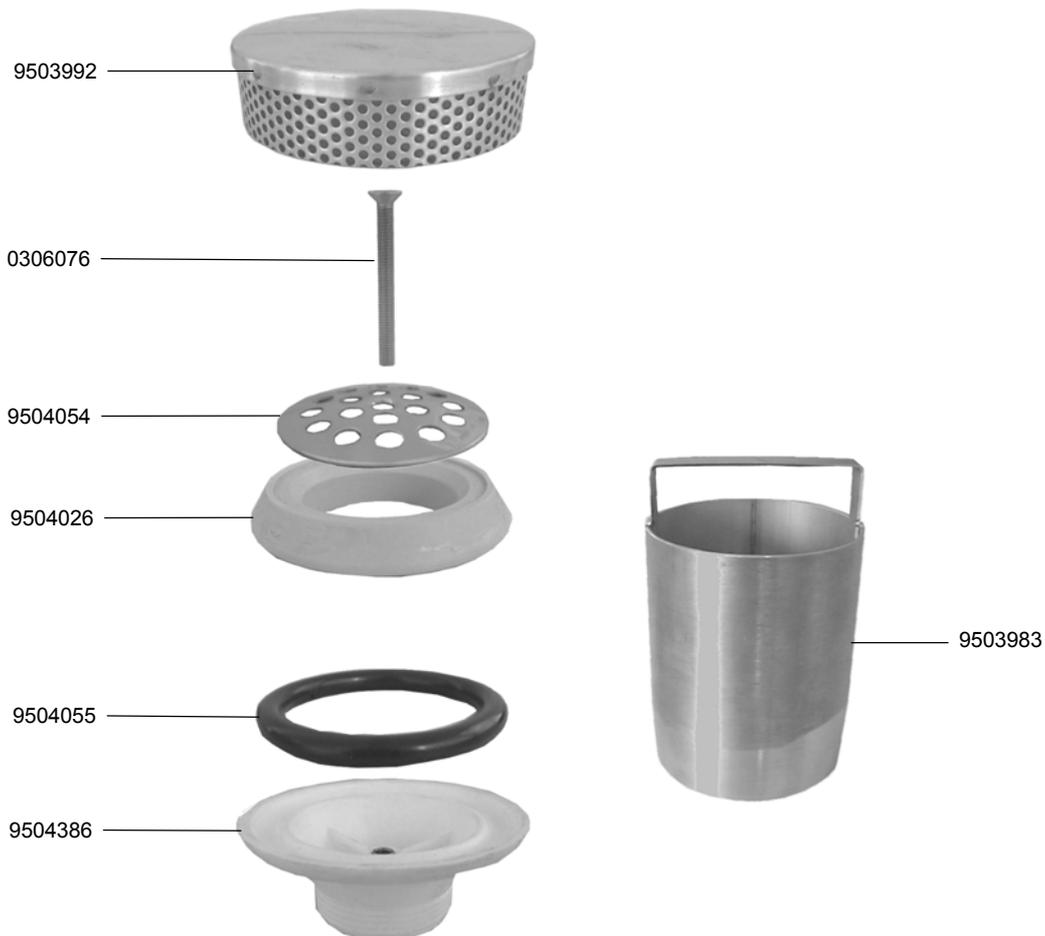

IDENT.-NR. IDENT.-NO.	BEZEICHNUNG	DESIGNATION	DESIGNATION
9503983	STANDROHR	DRAIN PLUG	BONDE DE TROP PLEIN
9504386	VENTILUNTERTEIL	LOWER PART OF VALVE	PARTIE INFERIEURE DE VANNE
9504055	O-RING	O-RING	BAGUE
9504026	ANSAUGSTUTZEN	SUCTION PORT	MANCHON D'ASPIRATION
9504054	SIEB	SIEVE	TAMIS
0306076	SCHRAUBE M6X60	SCREW M6X60	VIS M6X60
9503992	ANSAUGSIEB	SUCTION SIEVE	FILTRE D'ASPIRATION

7.6 CSS CLASSIC



7.6 CSS CLASSIC

7.6 CSS CLASSIC

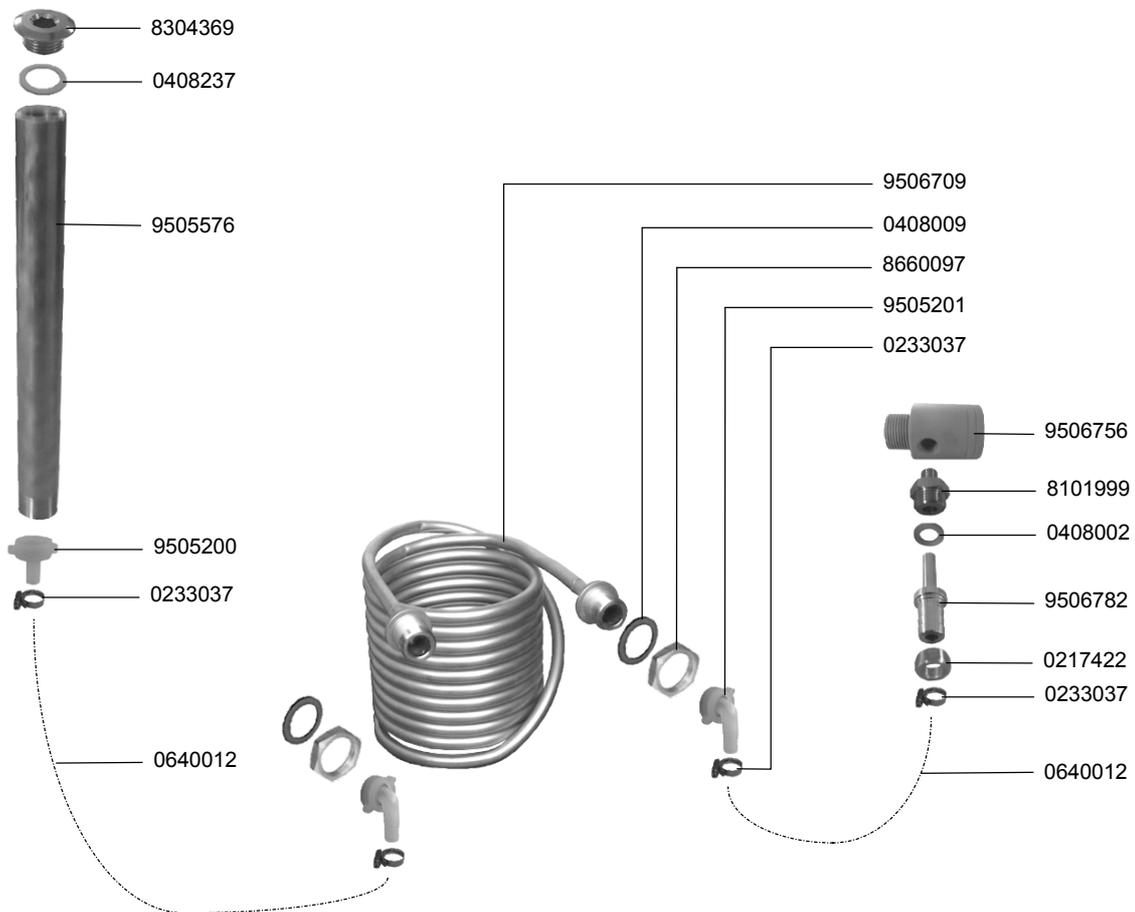

7.6 CSS CLASSIC



7.6 CSS CLASSIC

7.6 CSS CLASSIC

IDENT.-NR. IDENT.-NO.	BEZEICHNUNG	DESIGNATION	DESIGNATION
9506709	WÄRMETAUSCHER	HEAT EXCHANGER	ECHANGEUR DE CHALEUR
0408009	DICHTUNG	PACKING	JOINT
8660097	MUTTER	NUT	ECROU
9505201	ANSCHLUSSWINKEL	CONNECTION ANGLE	ANGLE DE CONNEXION
0233037	SCHLAUCHKLEMME	HOSE WIRE CLAMP	COLLIER DE SERRAGE
9506756	VERBINDUNGSTEIL	CONNECTION PART	PIECE DE CONNEXION
8101999	ADAPTER	ADAPTER	ADAPTEUR
0408002	DICHTUNG	PACKING	JOINT
9506782	BLENDE	STOP	OBTURATEUR
0217422	ÜBERWURFMUTTER	SLEEVE NUT	ECROU RACCORD
0640012	SCHLAUCH	HOSE	TUYAU
9505200	ANSCHLUSSTÜCK	CONNECTION PIECE	PIECE DE CONNEXION
9505576	STEIGROHR	ASCENDING PIPE	CONDUITE ASCENDANTE
0408237	DICHTUNG	PACKING	JOINT
8304369	DÜSE	NOZZLE	GICLEUR

7.7 CSS BASIC



7.7 CSS BASIC

7.7 CSS BASIC

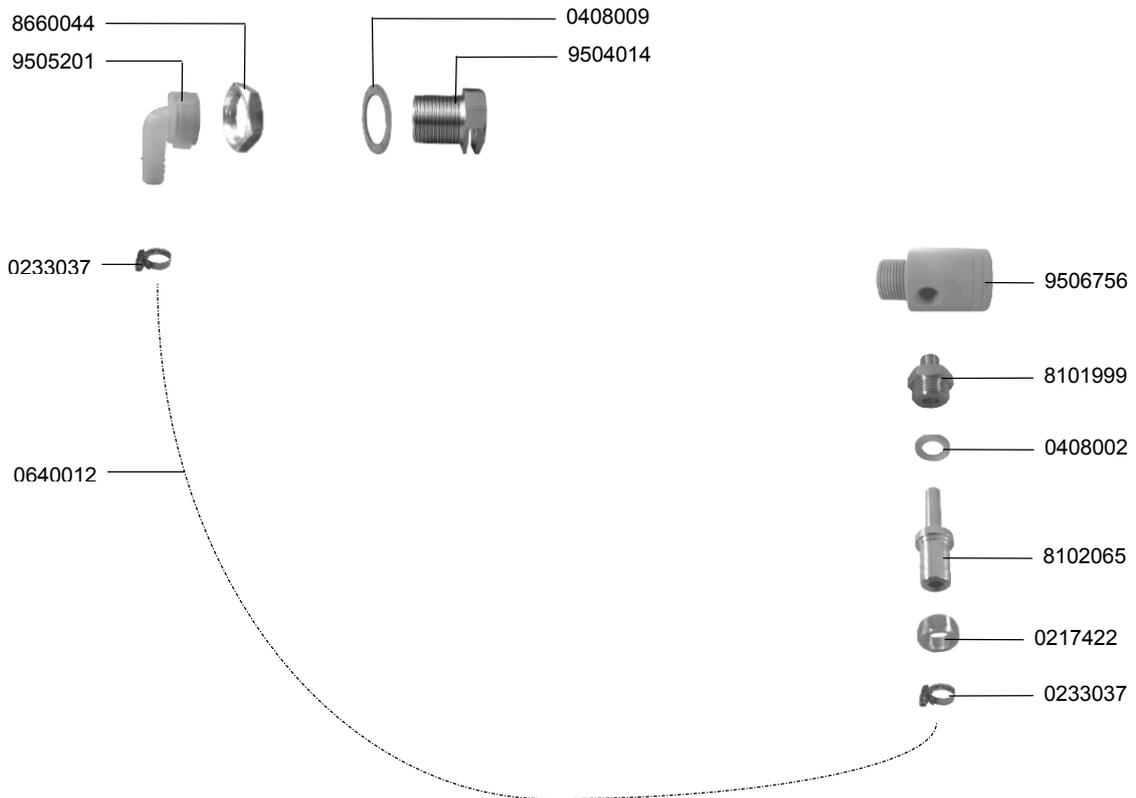

IDENT.-NR. IDENT.-NO.	BEZEICHNUNG	DESIGNATION	DESIGNATION
0408009	DICHTUNG	PACKING	JOINT
* 9504014	FLACHSTRAHLDÜSE	NOZZLE	GICLEUR
9506756	VERBINDUNGSTEIL	CONNECTION PART	PIECE DE CONNEXION
8101999	ADAPTER	ADAPTER	ADAPTEUR
0408002	DICHTUNG	PACKING	JOINT
8102065	BLENDE	STOP	OBTURATEUR
0217422	ÜBERWURFMUTTER	SLEEVE NUT	ECROU RACCORD
0233037	SCHLAUCHKLEMME 16-27	HOSE WIRE CLAMP 16-27	COLLIER DE SERRAGE 16-27
0640012	SCHLAUCH	HOSE	TUYAU
9505201	ANSCHLUSWINKEL	CONNECTION ANGLE	ANGLE DE CONNEXION
8660044	SKT. MUTTER 3/4"	HEXAGON NUT 3/4"	ECROU A 6 PANS 3/4"

7.8 CSS BASIC



7.8 CSS BASIC

7.8 CSS BASIC

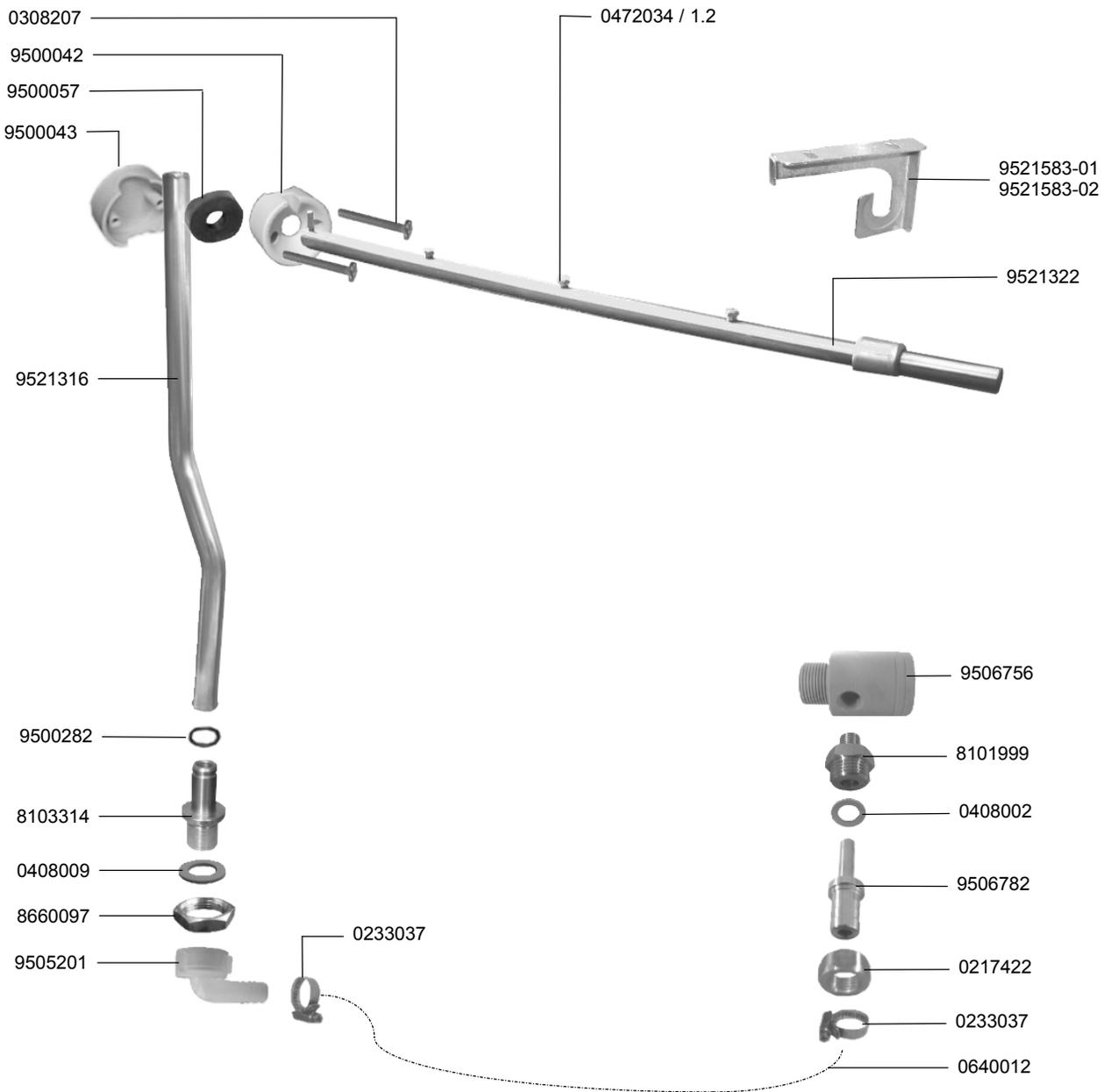

7.8 CSS BASIC



7.8 CSS BASIC

7.8 CSS BASIC

IDENT.-NR. IDENT.-NO.	BEZEICHNUNG	DESIGNATION	DESIGNATION
* 0472034	DÜSE 1.2	NOZZLE 1.2	GICLEUR 1.2
9521583-01	HALTERUNG OBEN L-R	UPPER SUPPORT L-R	SUPPORT SUP. G-D
9521583-02	HALTERUNG OBEN R-L	UPPER SUPPORT R-L	SUPPORT SUP. D-G
9521322	SPÜLARM	FINAL RINSE ARM	BRAS DE RINCAGE FINAL
9506756	VERBINDUNGSTEIL	CONNECTION PART	PIECE DE CONNEXION
8101999	ADAPTER	ADAPTER	ADAPTEUR
0408002	DICHTUNG	PACKING	JOINT
9506782	BLENDE	STOP	OBTURATEUR
0217422	ÜBERWURFMUTTER	SLEEVE NUT	ECROU RACCORD
0233037	SCHLAUCHKLEMME	HOSE WIRE CLAMP	COLLIER DE SERRAGE
0640012	SCHLAUCH	HOSE	TUYAU
9505201	ANSCHLUSSWINKEL	CONNECTION ANGLE	ANGLE DE CONNEXION
8660097	MUTTER	NUT	ECROU
0408009	DICHTUNG	PACKING	JOINT
8103314	TANKDURCHFÜHRUNG	TANK THROUGH LEAD	TRAVERSEE DU BAC
9500282	O-RING	O-RING	BAGUE
9521316	STEIGROHR	ASCENDING PIPE	CONDUITE ASCENDANTE
* 9500043	KUPPLUNG RÜCKTEIL	CLUTCH BACK PART	ACCOUPLLEMENT ARRIERE
* 9500057	DICHTUNG	PACKING	JOINT
* 9500042	KUPPLUNG VORDERTEIL	CLUTCH FRONT PART	ACCOUPLLEMENT FRONTALE
0308207	SCHRAUBE M4X10	SCREW M4X10	VIS M4X10

7.9 CSS TOP SPRÜHSYSTEM UNTEN



7.9 CSS TOP LOWER SPRAYING SYSTEM

7.9 CSS TOP SYSTEME D'ARROSAGE INFERIEUR

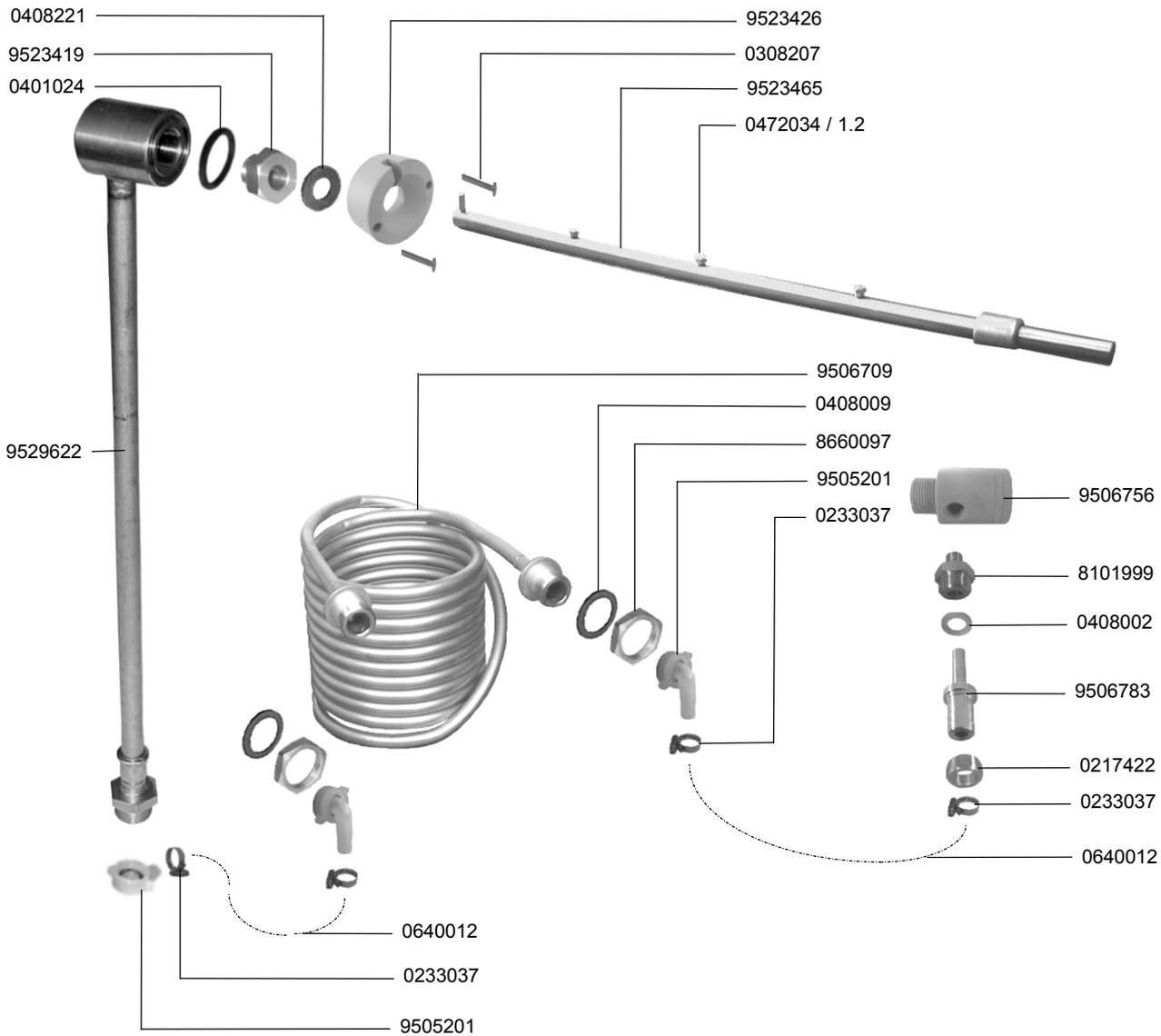

7.9 CSS TOP SPRÜHSYSTEM UNTEN



7.9 CSS TOP LOWER SPRAYING SYSTEM

7.9 CSS TOP SYSTEME D'ARROSAGE INFERIEUR

IDENT.-NR. IDENT.-NO.	BEZEICHNUNG	DESIGNATION	DESIGNATION
* 9523426	KUPPLUNG VORDERTEIL	CLUTCH FRONT PART	ACCOUPLLEMENT FRONTALE
0308207	SCHRAUBE M4X10	SREW M4X10	VIS M4X10
9523465	SPÜLARM CSS TOP UNTEN	LOWER RINSE ARM	BRAS DE RINCAGE FINAL INF.
* 0472034	DÜSE 1.2	NOZZLE 1.2	GICLEUR 1.2
9506709	WÄRMETAUSCHER	HEAT EXCHANGER	ECHANGEUR DE CHALEUR
0408009	DICHTUNG	PACKING	JOINT
8660097	MUTTER	NUT	ECROU
9505201	ANSCHLUSSWINKEL	CONNECTION ANGLE	ANGLE DE CONNEXION
0233037	SCHLAUCHKLEMME	HOSE WIRE CLAMP	COLLIER DE SERRAGE
9506756	VERBINDUNGSTEIL	CONNECTION PART	PIECE DE CONNEXION
8101999	ADAPTER	ADAPTER	ADAPTEUR
0408002	DICHTUNG	PACKING	JOINT
9506783	BLENDE	STOP	OBTURATEUR
0217422	ÜBERWURFMUTTER	SLEEVE NUT	ECROU RACCORD
0640012	SCHLAUCH	HOSE	TUYAU
9529622	STEIGLEITUNG	ASCENDING PIPE	CONDUITE ASCENDANTE
* 0401024	O-RING	O-RING	BAGUE
9523419	NIPPEL	NIPPLE	NIPPLE
0408221	DICHTUNG	PACKING	JOINT

8.1 DRUCKMINDERVENTIL



8.1 PRESSURE REDUCING VALVE

8.1 REDUCTEUR DE PRESSION

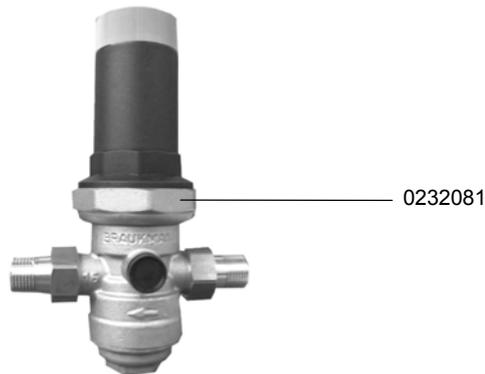

IDENT.-NR. IDENT.-NO.	BEZEICHNUNG	DESIGNATION	DESIGNATION
* 9500401	DRUCKMINDERVENTIL DN10 0,5-9 BAR 3/4"	PRESSURE REDUCING VALVE DN10 0,5-9 BAR 3/4"	COLLECTEUR DE DN10 0,5-9 BAR 3/4"
* 0232081	DRUCKMINDERVENTIL D06FN-1/2" A	PRESSURE REDUCING VALVE D06FN-1/2" A	REDUCTEUR DE PRESSION D06FN-1/2" A

8.2 DURCHFLUSSMESSER



8.2 FLOW CONTROL

8.2 DEBIT METRE

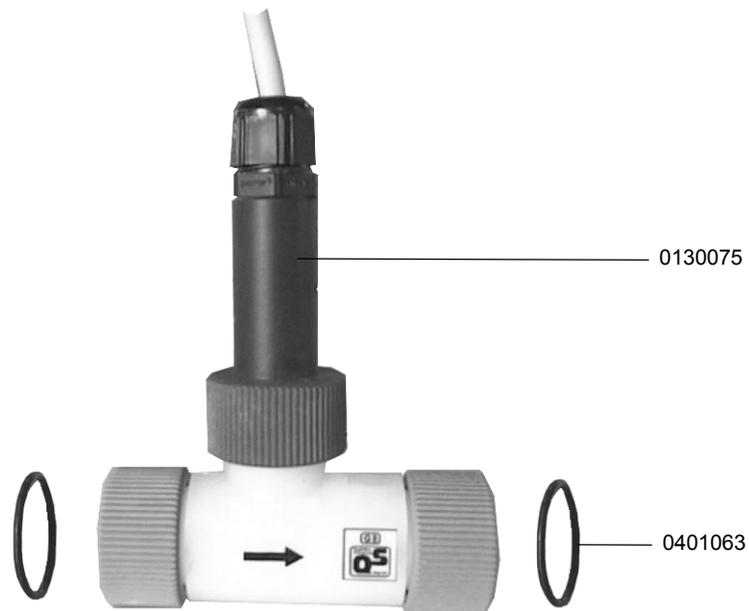

IDENT.-NR. IDENT.-NO.	BEZEICHNUNG	DESIGNATION	DESIGNATION
* 0130075	DURCHFLUSSMESSER	FLOW CONTROL	DEBIT METRE
* 0401063	O-RING	O-RING	BAGUE

8.3 DURCHFLUSSWÄCHTER



8.3 FLOW CONTROL INSTRUMENT

8.3 CONTROLEUR DE DEBIT

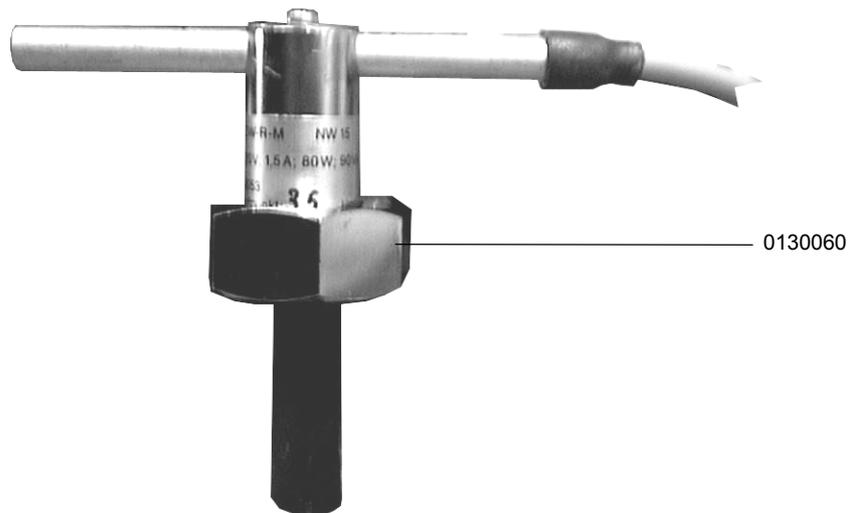

IDENT.-NR. IDENT.-NO.	BEZEICHNUNG	DESIGNATION	DESIGNATION
--------------------------	-------------	-------------	-------------

* 0130060	DURCHFLUSSWÄCHTER	FLOW CONTROL INSTRUMENT	CONTROLEUR DE DEBIT
-----------	-------------------	-------------------------	---------------------

8.4 ÜBERDRUCKVENTIL



8.4 OVERPRESSURE VALVE

8.4 SOUPAPE DE SURPRESSION

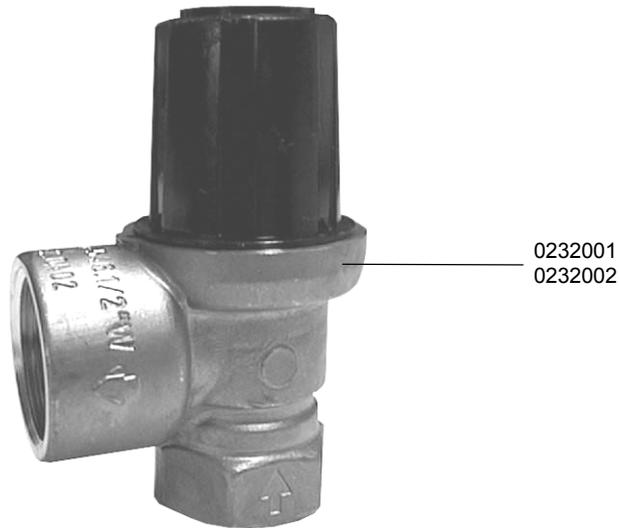

IDENT.-NR. IDENT.-NO.	BEZEICHNUNG	DESIGNATION	DESIGNATION
* 0232001	SICHERHEITSVENTIL 1/2"	OVERPRESSURE VALVE 1/2"	SOUPAPE DE SURPRESSION 1/2"
* 0232002	SICHERHEITSVENTIL 3/4"	OVERPRESSURE VALVE 3/4"	SOUPAPE DE SURPRESSION 3/4"

9.1 AXIALGEBLÄSE FÜR WÄRMEPUMPE



9.1 AXIAL FAN PUMP FOR HEAT PUMP

9.1 VENTILATEUR AXIAL POUR POMPE A CHALEUR

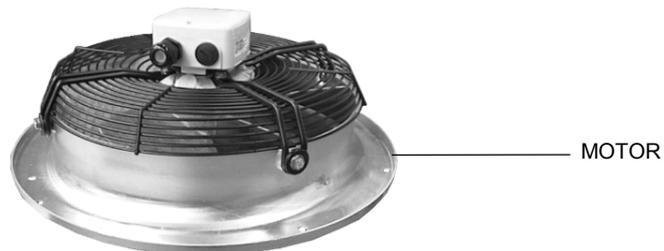
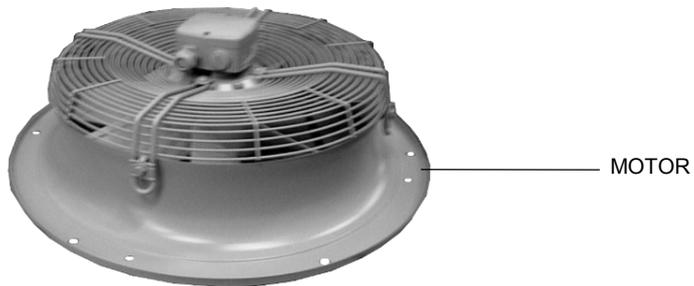

IDENT.-NR. IDENT.-NO.	BEZEICHNUNG	DESIGNATION	DESIGNATION
MOTOR	SIEHE ELEKTROSCHALTPLAN	SEE ELECTRIC DIAGRAM	VOIR SCHEMA ELECTRIQUE

9.2 UMWÄLZPUMPE FÜR WÄRMEPUMPE



9.2 CIRCULATION PUMP FOR HEAT PUMP

9.2 POMPE DE CIRCULATION POUR POMPE A CHALEUR

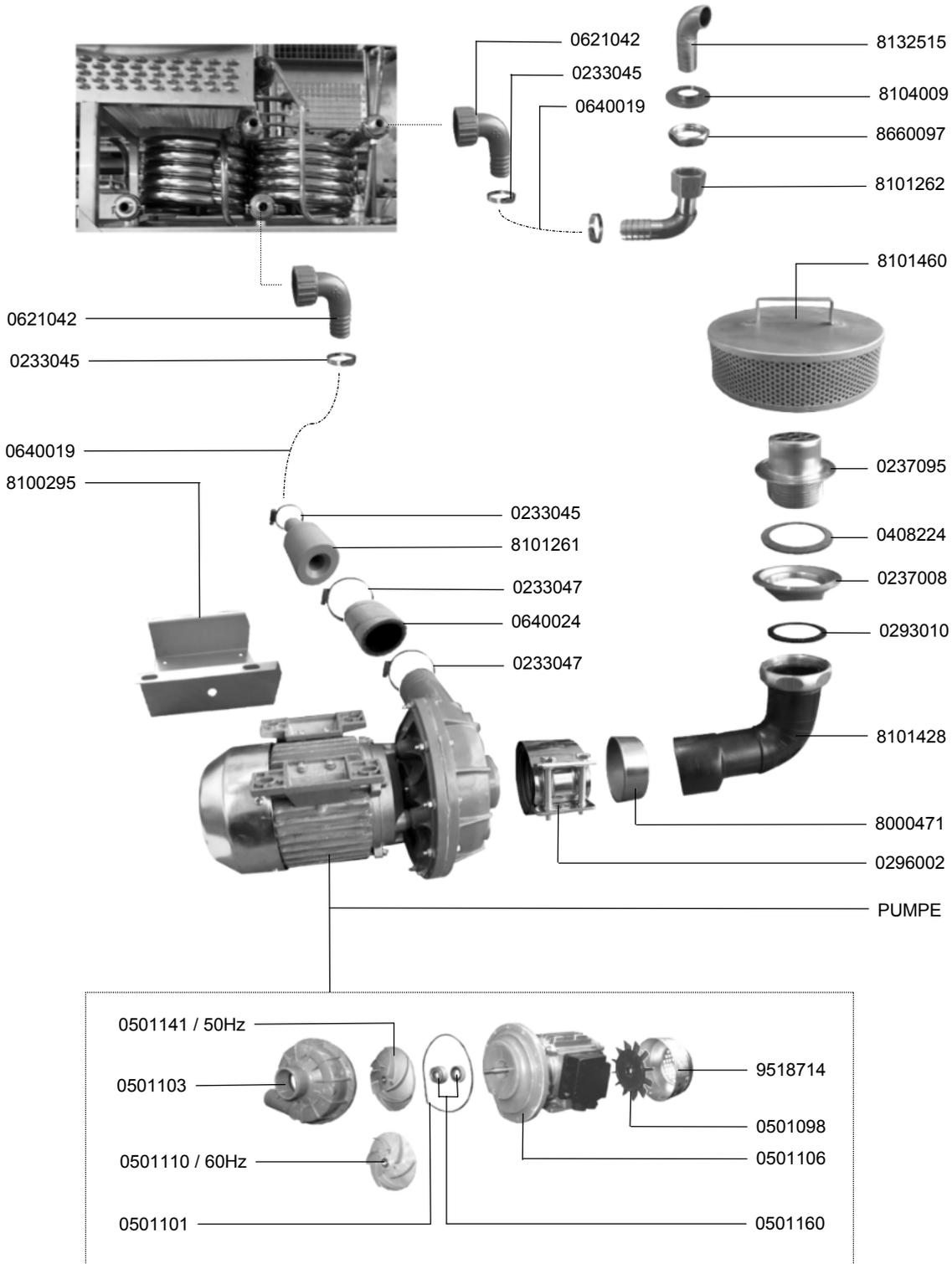

9.2 UMWÄLZPUMPE FÜR WÄRMEPUMPE



9.2 CIRCULATION PUMP FOR HEAT PUMP

9.2 POMPE DE CIRCULATION POUR POMPE A CHALEUR

IDENT.-NR. IDENT.-NO.	BEZEICHNUNG	DESIGNATION	DESIGNATION
0621042	ANSCHLUSSWINKEL	CONNECTION ANGLE	ANGLE DE CONNEXION
0233045	SCHLAUCHKLEMME 20-32	HOSE WIRE CLAMP 20-32	COLLIER DE SERRAGE 20-32
0640019	SCHLAUCH	HOSE	TUYAU
8132515	FÜLLHAKEN	FILLING HOOK	CROCHET DE REMPLISSAGE
8104009	MUTTER ¾"	NUT ¾"	ECROU ¾"
8660097	SKT.MUTTER ¾"	HEXAGON NUT ¾"	ECROU A 6 PANS ¾"
8101262	ANSCHLUSWINKEL ¾"	CONNECTION ANGLE ¾"	ANGLE DE CONNEXION ¾"
8101460	ANSAUGSIEB	SUCTION SIEVE	FILTRE D'ASPIRATION
0237095	ANSAUGSIEB	SUCTION SIEVE	FILTRE D'ASPIRATION
0408224	DICHTUNG	PACKING	JOINT
0237008	MUTTER 2"	NUT 2"	ECROU 2"
0293010	DICHTUNG	PACKING	JOINT
8101428	ANSAUGSTUTZEN	SUCTION PORT	MANCHON D'ASPIRATION
8000471	VERSTÄRKUNGSRING	SUPPORT RING	BAGUE DE SUPPORT
0296002	VERBINDER CV	CV-CONNECTION	CONNEXION CV
PUMPE	SIEHE ELEKTROSCHALTPLAN	SEE ELECTRIC WIRING DIAGRAM	VOIR SHEMA ELECTRIQUE
9518714	LÜFTERHAUBE	FAN COWL	CAPOTAGE DE VENTILATEUR
0501098	VENTILATORFLÜGEL	FAN WHEEL	ROUE VENTILATEUR
0501106	LAGERSCHILD	END SHIELD	FLASQUE
V 0501160	GLEITRINGDICHTUNG	SLIDING SEAL	JOINT AXIAL
0501101	DICHTUNG	PACKING	JOINT
* 0501110	LAUFRAD 60HZ	IMPELLER 60HZ	ROUE DE POMPE 60HZ
0501103	PUMPENGEHÄUSE	PUMP HOUSING	CORPS DE POMPE
* 0501141	LAUFRAD 50HZ	IMPELLER 50HZ	ROUE DE POMPE 50HZ
0233047	SCHLAUCHKLEMME 50-70	HOSE WIRE CLAMP 50-70	COLLIER DE SERRAGE 50-70
0640024	SCHLAUCH	HOSE	TUYAU
8101261	NIPPEL	NIPPLE	NIPPLE
8100295	KONSOLE	CONSOLE	CONSOLE

10.1 ABSAUGGEBLÄSE FÜR WÄRMERÜCKGEWINNUNG



10.1 EXTRACTION FAN FOR HEAT RECOVERY

10.1 VENTILATEUR D'ASPIRATION POUR RECUPERATION



IDENT.-NR. IDENT.-NO.	BEZEICHNUNG	DESIGNATION	DESIGNATION
MOTOR	SIEHE ELEKTROSCHALTPLAN	SEE ELECTRIC DIAGRAM	VOIR SCHEMA ELECTRIQUE

10.2 WÄRMETAUSCHER

10.2 HEAT EXCHANGER

10.2 ECHANGEUR DE CHALEUR

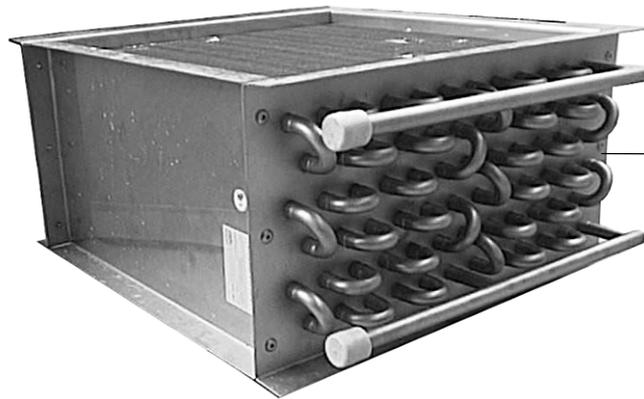

0254026 / 1.4435
9517229 / Cu

IDENT.-NR. IDENT.-NO.	BEZEICHNUNG	DESIGNATION	DESIGNATION
0254026	KÜHLER 1.4435	COOLER 1.4435	REFROIDISSEUR 1.4435
9517229	KÜHLER CU	COOLER CU	REFROIDISSEUR CU

10.3 STEIGLEITUNG



10.3 ASCENDING PIPE

10.3 CONDUITE ASCENDANTE

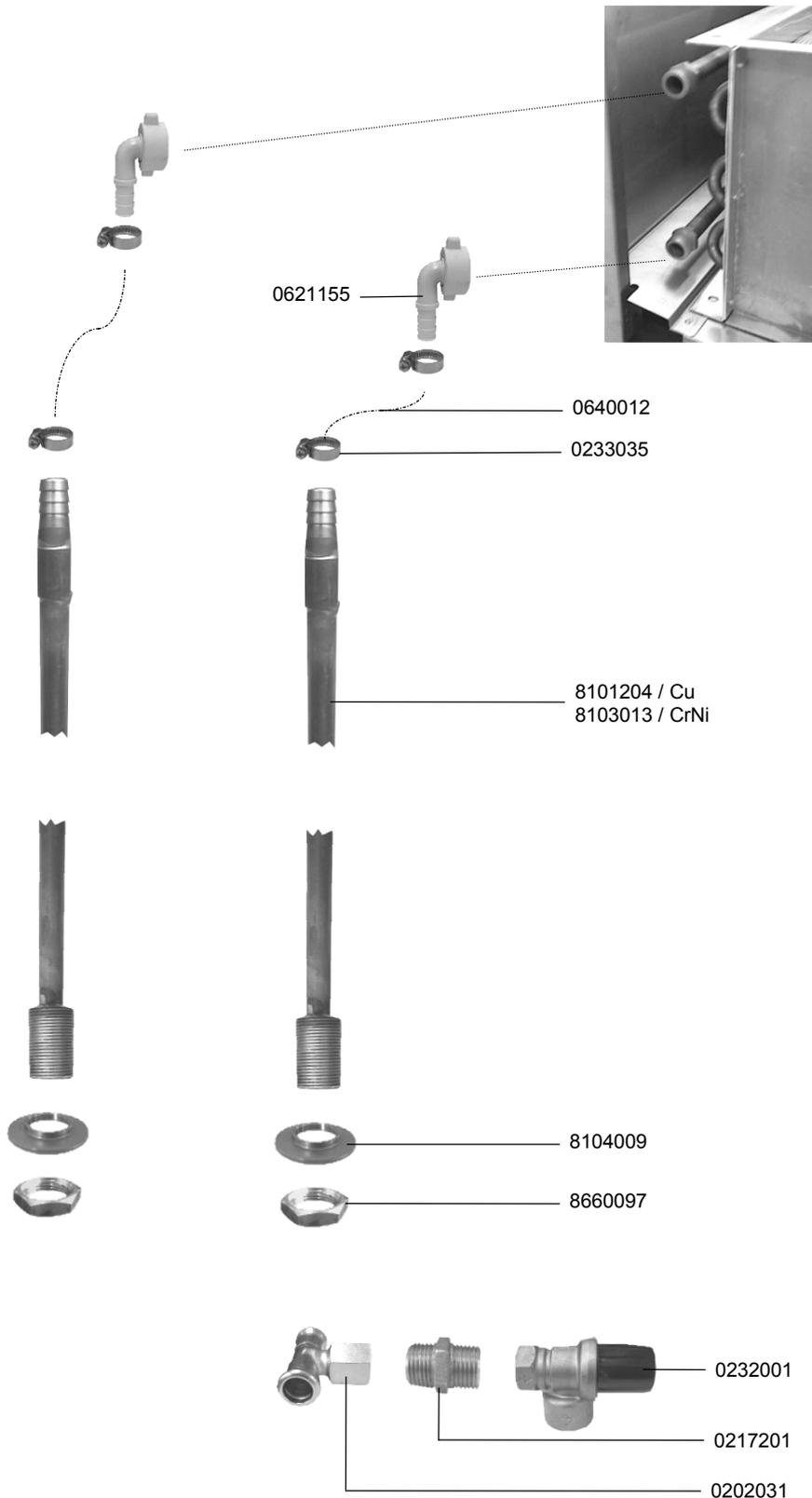

10.3 STEIGLEITUNG



10.3 ASCENDING PIPE

10.3 CONDUITE ASCENDANTE

IDENT.-NR. IDENT.-NO.	BEZEICHNUNG	DESIGNATION	DESIGNATION
0621155	ANSCHLUSSWINKEL	CONNECTION ANGLE	ANGLE DE CONNEXION
0640012	SCHLAUCH	HOSE	TUYAU
0233035	SCHLAUCHKLEMME 12-20	HOSE WIRE CLAMP 12-20	COLLIER DE SERRAGE 12-20
8101204	STEIGROHR CU	ASCENDING PIPE CU	CONDUITE ASCENDANTE CU
8103013	STEIGROHR CRNI	ASCENDING PIPE CRNI	CONDUITE ASCENDANTE CRNI
8104009	MUTTER 3/4"	NUT 3/4"	ECROU 3/4"
8660097	SKT. MUTTER 3/4"	HEXAGON NUT 3/4"	ECROU A 6 PANS 3/4"
* 0232001	SICHERHEITSVENTIL	OVERPRESSURE VALVE	SOUPAPE DE SURPRESSION
0217201	DOPPELNIPPEL	DOUBLE NIPPLE	NIPPLE DOUBLE
0202031	T-STÜCK	T-PIECE	PIECE DE T

11.1.1 VORHÄNGE



11.1.1 CURTAIN

11.1.1 RIDEAU

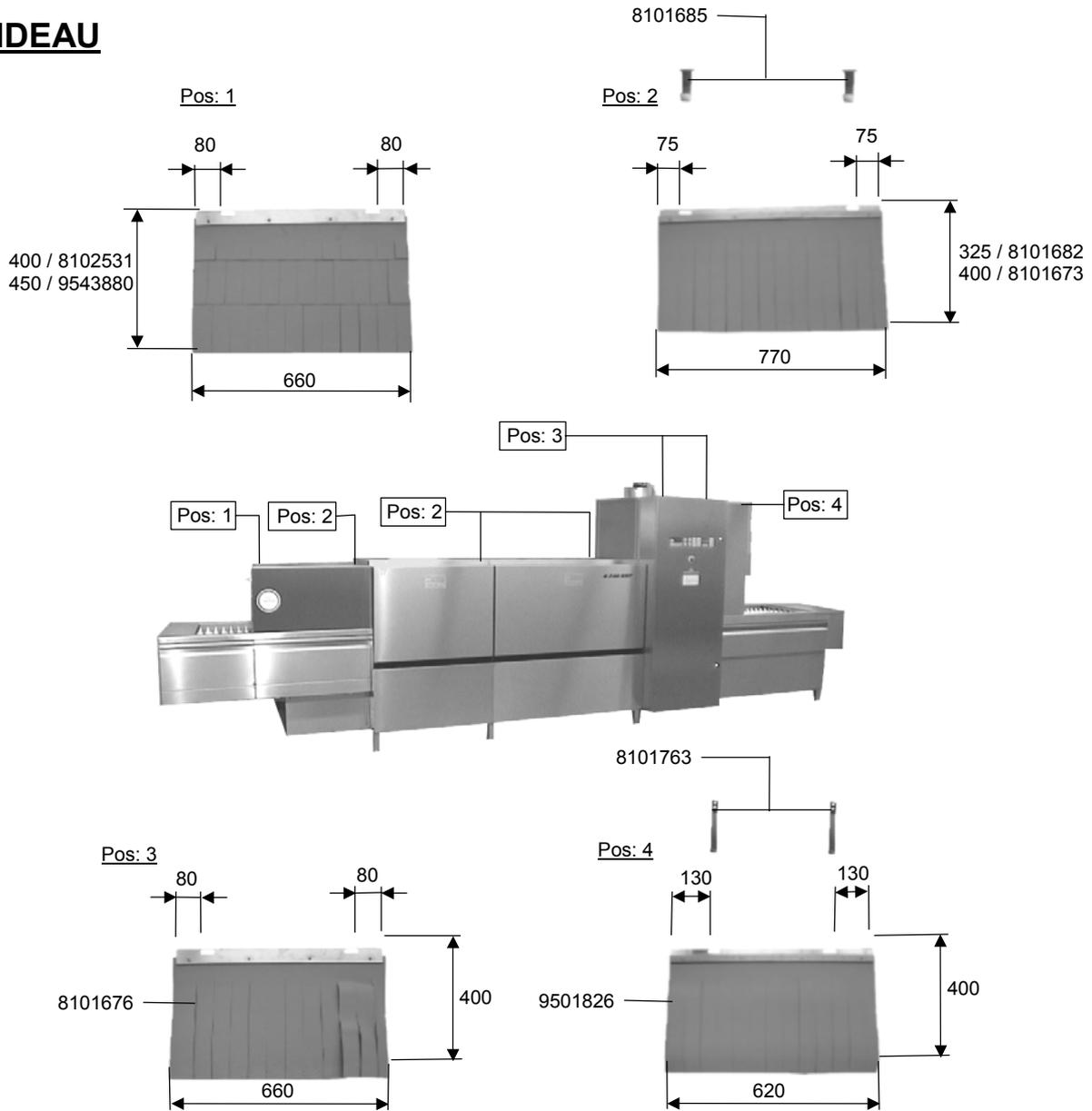

IDENT.-NR. IDENT.-NO.	BEZEICHNUNG	DESIGNATION	DESIGNATION
* 8102531	VORHANG EINLAUF KPL. 660X400	CURTAIN FEEDING CPL. 660X400	RIDEAU ENTREE CPL. 660X400
* 9543880	VORHANG EINLAUF KPL. 660X450	CURTAIN FEEDING CPL. 660X450	RIDEAU ENTREE CPL. 660X450
* 8101673	VORHANG MASCHINE KPL. 770X400	CURTAIN MACHINE CPL. 770X400	RIDEAU MACHINE CPL. 770X400
* 8101682	VORHANG VOR FNSP KPL. 770X325	CURTAIN CPL. 770X325	RIDEAU CPL. 770X325
8101685	VORHANGAUFHÄNGEWINKEL	CURTAIN SUSPENSION ANGLE	ANGLE D' ACCROCHAGE DE RIDEAU
* 8101676	VORHANG AUSLAUFTUNNEL KPL. 660X400	CURTAIN DISCH.SIDE CPL. 660X400	RIDEAU SORTIE CPL. 660X400
* 9501826	VORHANG TROCKNUNG KPL. 620X400	CURTAIN DRYING CPL. 620X400	RIDEAU SECHAGE CPL. 620X400
8101763	VORHANGAUFHÄNGEWINKEL	CURTAIN SUSPENSION ANGLE	ANGLE D' ACCROCHAGE DE RIDEAU

12.1 ABLAUFROHRVERBINDUNG



12.1 DRAINPIPE CONNECTION

12.1 CONNEXION DE TUYAU DE VIDANGE



IDENT.-NR. IDENT.-NO.	BEZEICHNUNG	DESIGNATION	DESIGNATION
0296003	VERBINDER CV 100MM	CV-CONNECTION 100MM	CONNEXION CV 100MM
0296005	VERBINDER CV 70MM	CV-CONNECTION 70MM	CONNEXION CV 70MM

12.2 ABLAUFVERROHRUNG

12.2 PIPEWORK FOR DRAIN

12.2 TUYAUTERIE DE VIDANGE

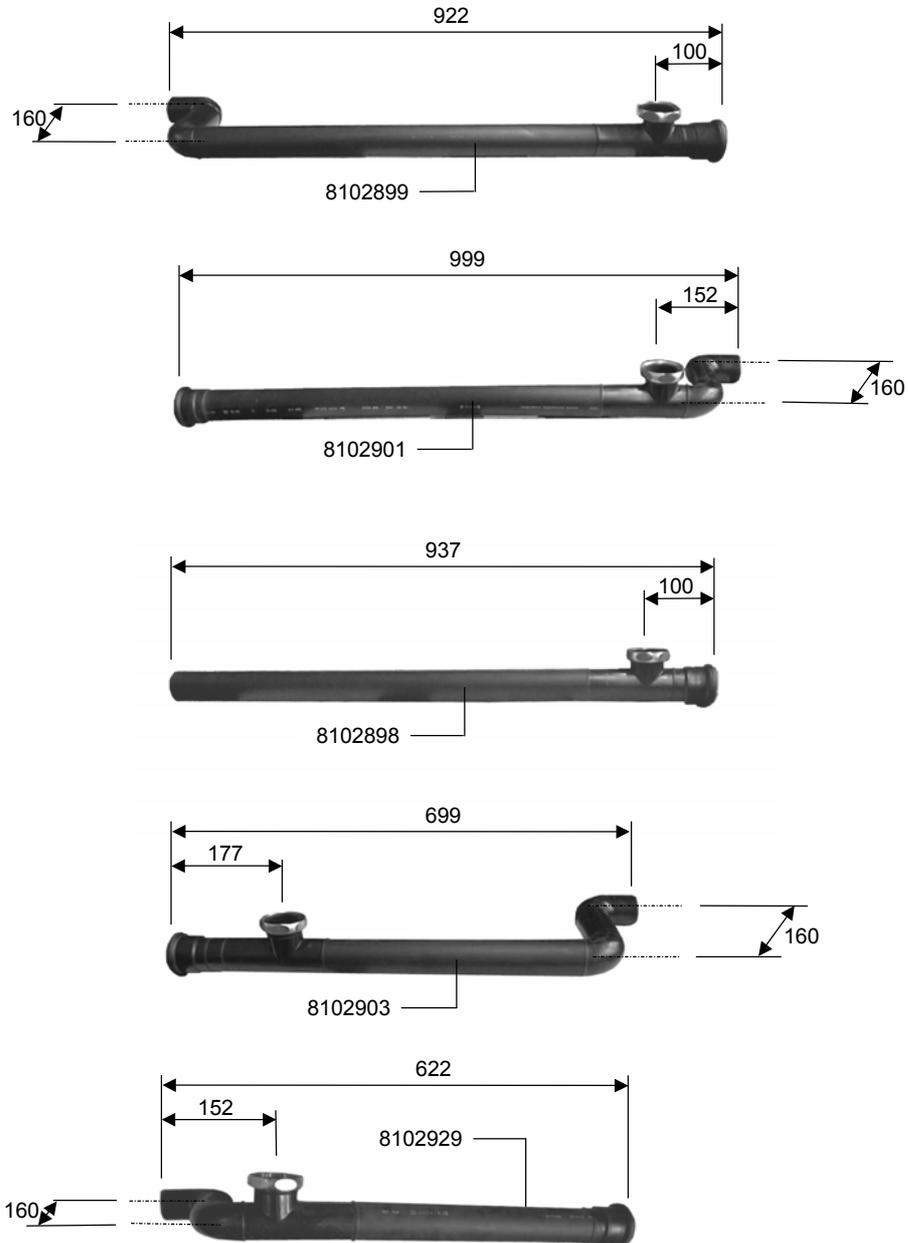

IDENT.-NR. IDENT.-NO.	BEZEICHNUNG	DESIGNATION	DESIGNATION
8102899	ABLAUFVERROHRUNG	PIPEWORK FOR DRAIN	TUYAUTERIE DE VIDANGE
8102901	ABLAUFVERROHRUNG	PIPEWORK FOR DRAIN	TUYAUTERIE DE VIDANGE
8102898	ABLAUFVERROHRUNG	PIPEWORK FOR DRAIN	TUYAUTERIE DE VIDANGE
8102903	ABLAUFVERROHRUNG	PIPEWORK FOR DRAIN	TUYAUTERIE DE VIDANGE
8102929	ABLAUFVERROHRUNG	PIPEWORK FOR DRAIN	TUYAUTERIE DE VIDANGE

12.3 ABLAUFVERROHRUNG



12.3 PIPEWORK FOR DRAIN

12.3 TUYAUTERIE DE VIDANGE

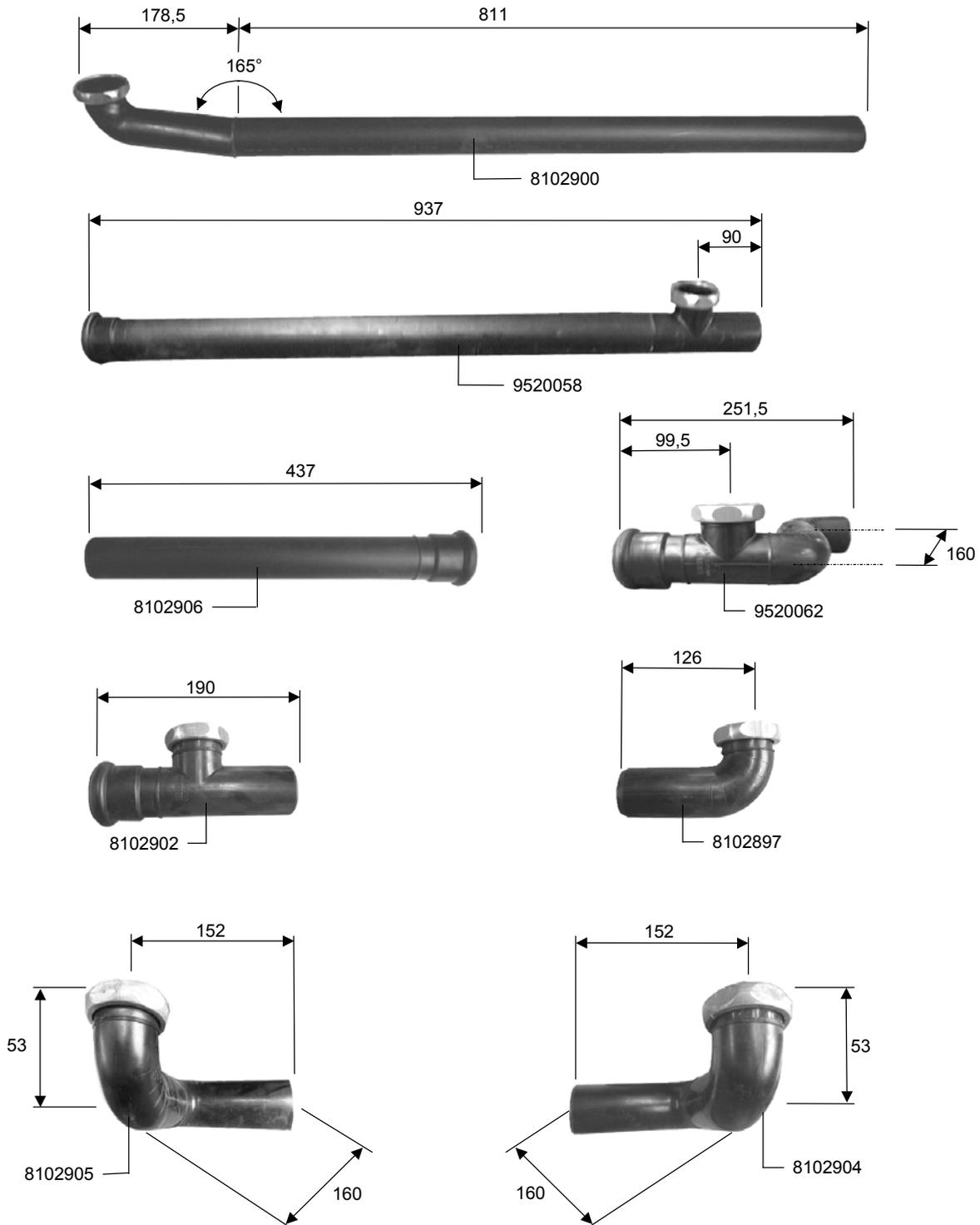

12.3 ABLAUFVERROHRUNG



12.3 PIPEWORK FOR DRAIN

12.3 TUYAUTERIE DE VIDANGE

IDENT.-NR. IDENT.-NO.	BEZEICHNUNG	DESIGNATION	DESIGNATION
8102900	ABLAUFVERROHRUNG	PIPEWORK FOR DRAIN	TUYAUTERIE DE VIDANGE
9520058	ABLAUFVERROHRUNG	PIPEWORK FOR DRAIN	TUYAUTERIE DE VIDANGE
9520062	ABLAUFVERROHRUNG	PIPEWORK FOR DRAIN	TUYAUTERIE DE VIDANGE
8102897	ABLAUFVERROHRUNG	PIPEWORK FOR DRAIN	TUYAUTERIE DE VIDANGE
8102904	ABLAUFVERROHRUNG	PIPEWORK FOR DRAIN	TUYAUTERIE DE VIDANGE
8102905	ABLAUFVERROHRUNG	PIPEWORK FOR DRAIN	TUYAUTERIE DE VIDANGE
8102902	ABLAUFVERROHRUNG	PIPEWORK FOR DRAIN	TUYAUTERIE DE VIDANGE
8102906	ABLAUFVERROHRUNG	PIPEWORK FOR DRAIN	TUYAUTERIE DE VIDANGE

12.4 ABLAUFVERROHRUNG, EINLAUF

12.4 PIPEWORK FOR DRAIN, INFEED

12.4 TUYAUTERIE DE VIDANGE, ENTREE



IDENT.-NR. IDENT.-NO.	BEZEICHNUNG	DESIGNATION	DESIGNATION
8102271	EINLAUFSAMMELROHR CSS	FEEDING COLLECTION PIPE CSS	TUYAU-COLLECTEUR ENTREE CSS
9504458	ABLAUFVERROHRUNG	PIPEWORK FOR DRAIN	TUYAUTERIE DE VIDANGE
8102116	EINLAUFSAMMELROHR CSS	FEEDING COLLECTION CSS	TUYAU-COLLECTEUR ENTREE CSS
8102490	EINLAUFSAMMELROHR	FEEDING COLLECTION PIPE	TUYAU-COLLECTEUR ENTREE
8102117	EINLAUFSAMMELROHR STANDARD	FEEDING COLLECTION PIPE STANDARD	TUYAU -COLLECTEUR ENTREE STANDARD
9521176	ABLAUFVERROHRUNG	PIPEWORK FOR DRAIN	TUYAUTERIE DE VIDANGE

12.5 ABLAUFSIFON



12.5 SIPHON

12.5 SIPHON

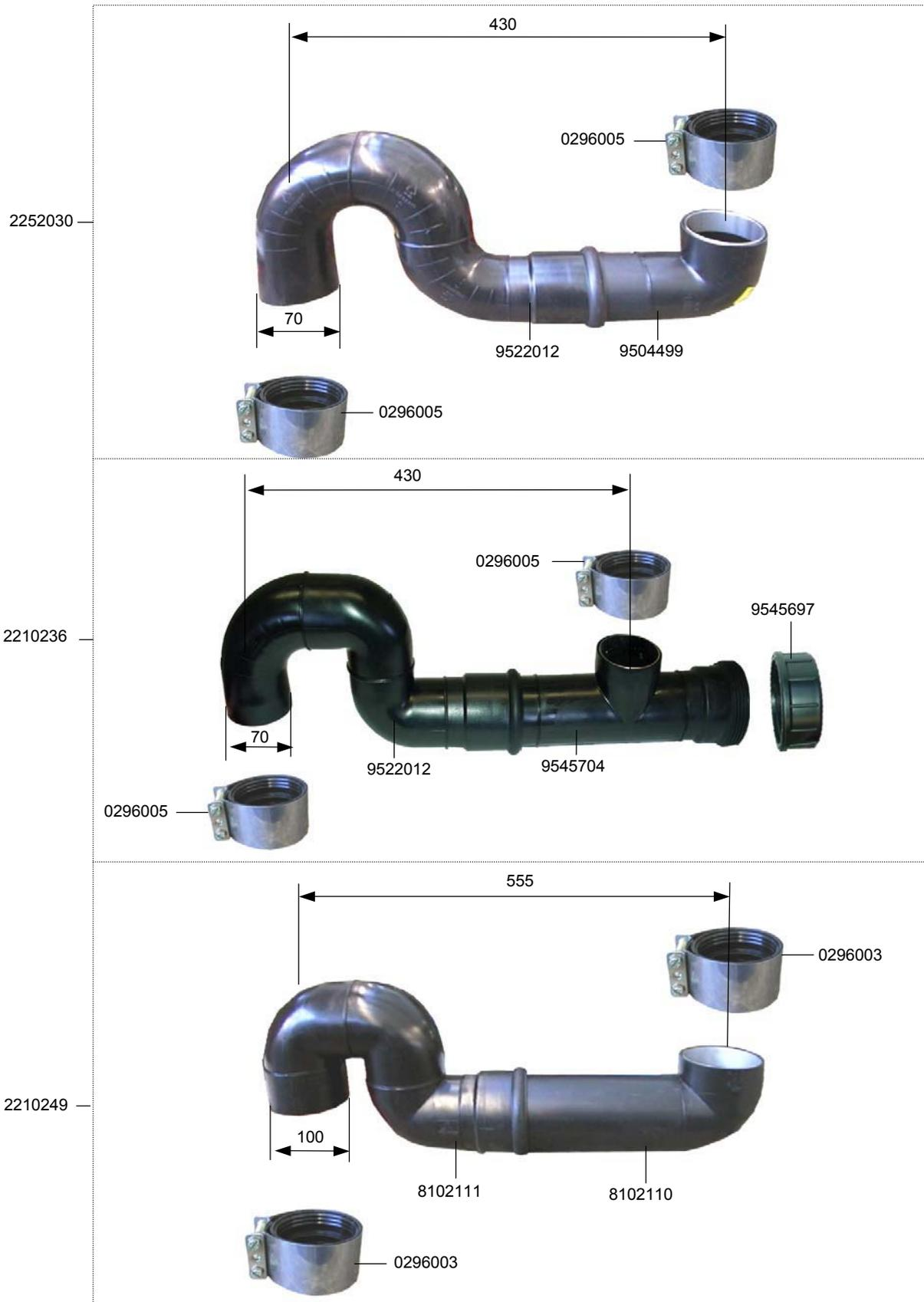

12.5 ABLAUFSIFON



12.5 SIPHON

12.5 SIPHON

IDENT.-NR. IDENT.-NO.	BEZEICHNUNG	DESIGNATION	DESIGNATION
0296005	CV-VERBINDER	CV-CONNECTION	CONNEXION-CV
9504499	ABLAUFSIFON TEIL1	SIPHON PART1	SIPHON PART1
9522012	GERUCHVERSCHLUß TEIL3	WATER TRAP PART3	SIPHON PART3
9545704	GERUCHVERSCHLUß TEIL4	WATER TRAP PART4	SIPHON PART4
9545697	VERSCHLUßKAPPE	END CAP	CAPUCHON DE FERM
0296003	CV-VERBINDER	CV-CONNECTION	CONNEXION-CV
8102110	ABLAUFSIFON TEIL 1	SIPHON PART 1	SIPHON PARTIE 1
8102111	ABLAUFSIFON TEIL 2	SIPHON PART 2	SIPHON PARTIE 2
2210249	ABLAUFSIFON KPL. CSS	SIPHON CPL. CSS	SIPHON CPL. CSS
2210236	ABLAUFSIFON KPL.MIT REVISIONSDECKEL DN 70	SIPHON CPL. DN 70	SIPHON CPL. DN 70
2252030	ABLAUFSIFON KPL. DN 70	SIPHON CPL. DN 70	SIPHON CPL. DN 70

12.6 TANKABLAUF, PUMPE



12.6 DRAIN, PUMP

12.6 VIDANGE, POMPE

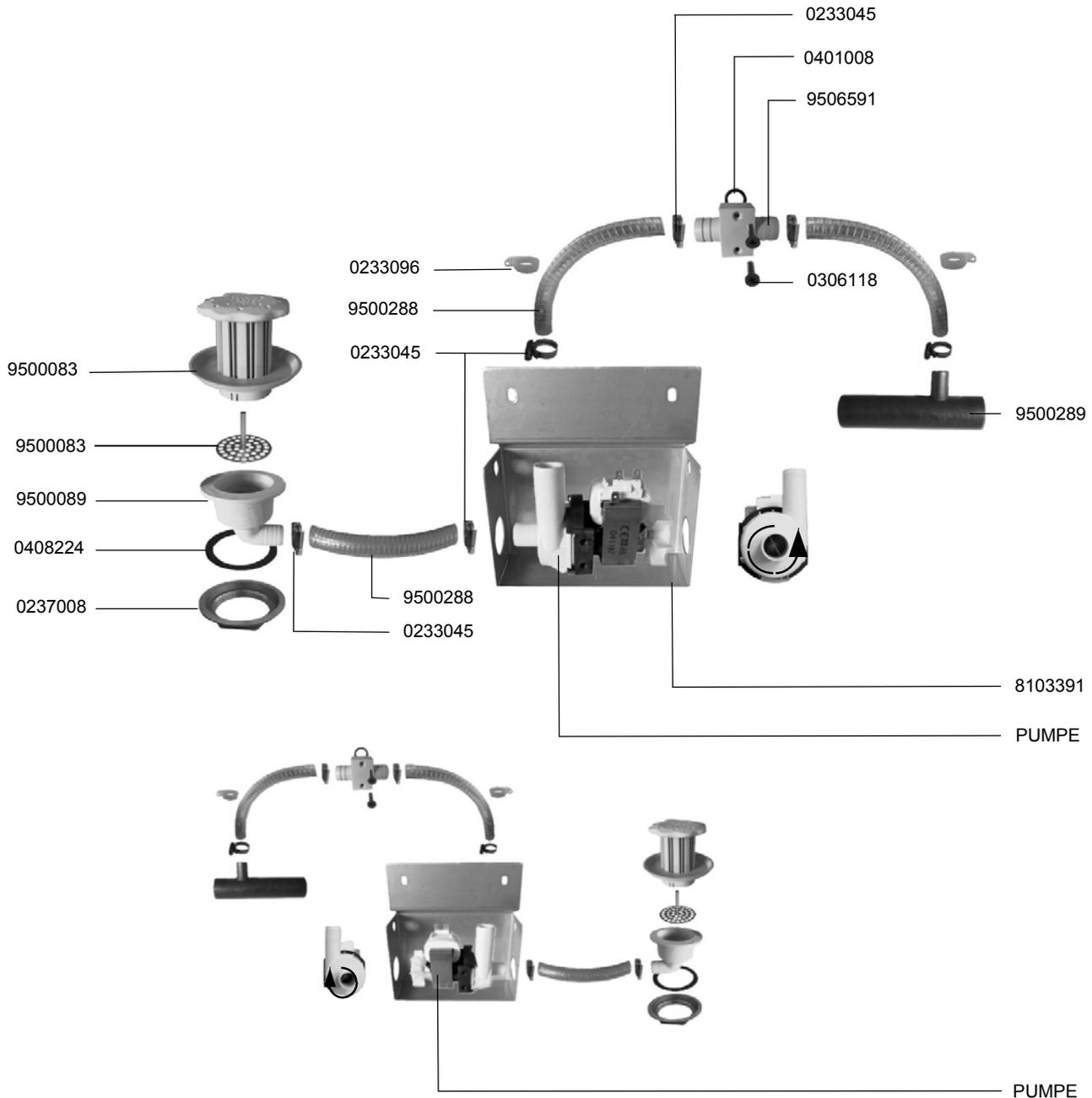

12.6 TANKABLAUF, PUMPE



12.6 DRAIN, PUMP

12.6 VIDANGE, POMPE

IDENT.-NR. IDENT.-NO.	BEZEICHNUNG	DESIGNATION	DESIGNATION
0233045	SCHLAUCHKLEMME 20-32	HOSE WIRE CLAMP 20-32	COLLIER DE SERRAGE 20-32
0401008	DICHTUNG	PACKING	JOINT
9506591	ENTLÜFTUNGSVENTIL	VENT VALVE	VANNE D' AERATION TUYAU
0306118	SCHRAUBE M4X20	SCREW M4X20	VIS M4X20
9500289	ROHR	TUBE	TUYAU
8103391	PUMPENHALTERUNG	PUMP SUPPORT	SUPPORT DE POMPE
PUMPE	SIEHE ELEKTROSCHALTPLAN	SEE ELECTRIC WIRING DIAGRAM	VOIR SCHEMA ELECTRIQUE ECROU 2"
9500288	SCHLAUCH	HOSE	TUYAU
0237008	MUTTER 2"	NUT 2"	ECROU 2"
0408224	DICHTUNG	PACKING	JOINT
9500089	ABLAUFVENTIL	DRAIN VALVE	VANNE DE VIDANGE
9524035	SIEB FÜR ABLAUF	SIEVE FOR DRAIN	TAIMS POUR VIDAGNE
9500083	STANDSIEB	SIEVE	FILTRE
0233096	SCHLAUCHKLEMME	HOSE WIRE CLAMP	COLLIER DE SERRAGE

12.6.1 TANKABLAUF, PUMPE



12.6.1 DRAIN, PUMP

12.6.1 VIDANGE, POMPE

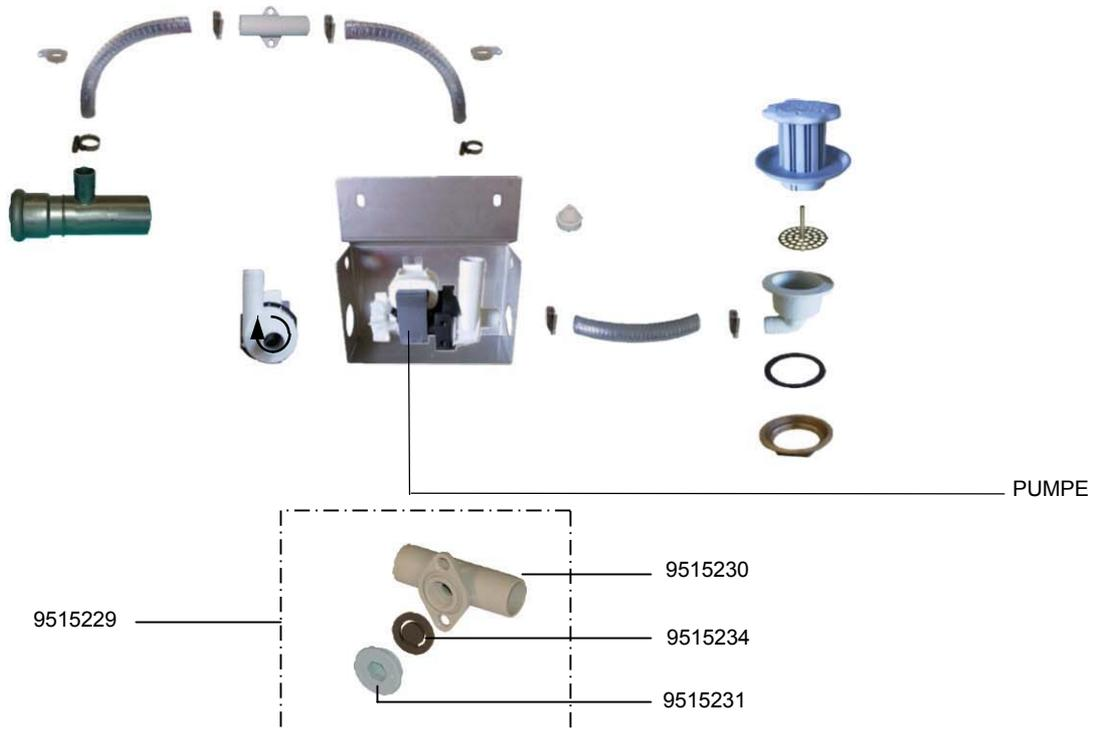
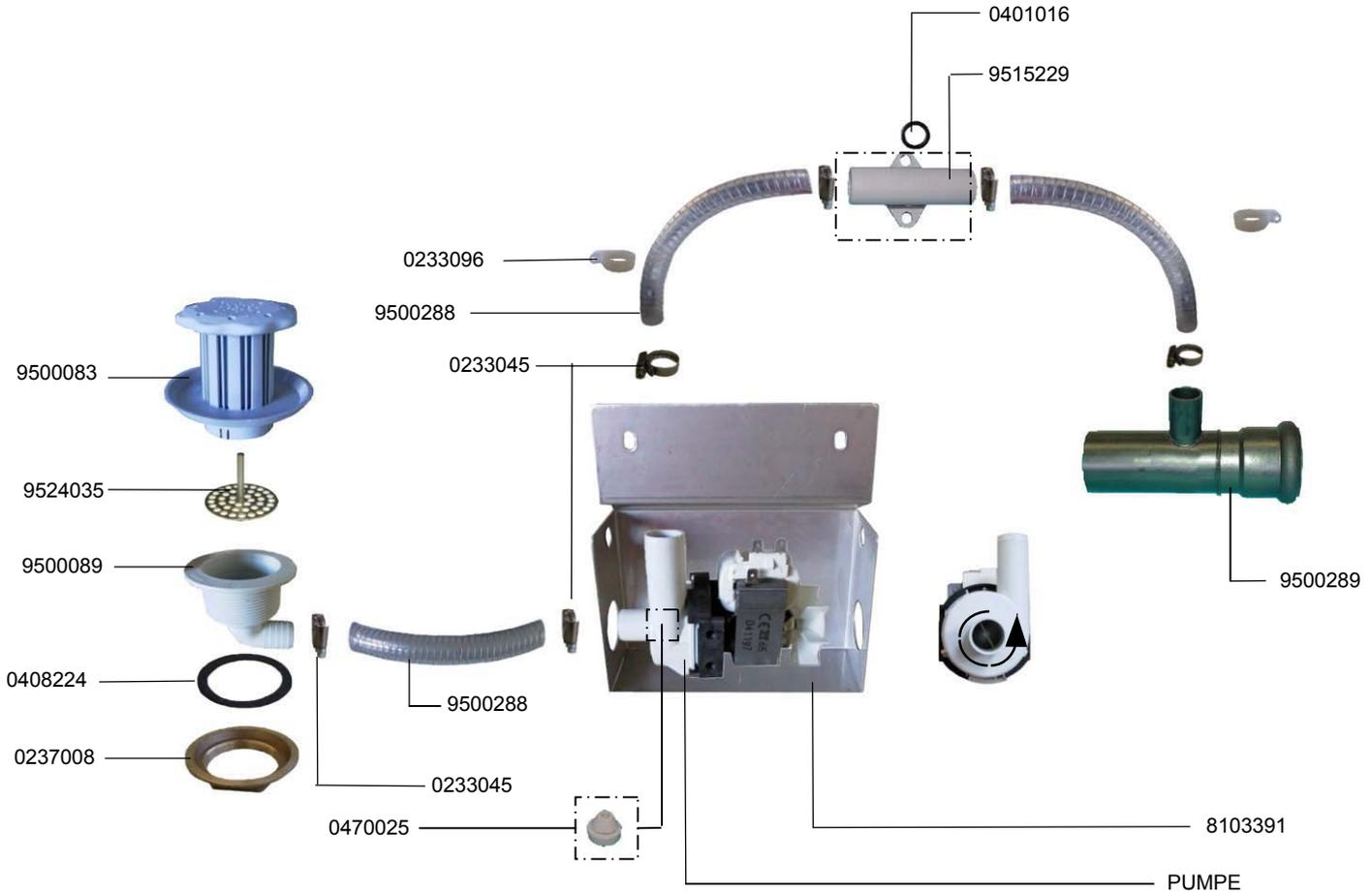

12.6.1 TANKABLAUF, PUMPE



12.6.1 DRAIN, PUMP

12.6.1 VIDANGE, POMPE

IDENT.-NR. IDENT.-NO.	BEZEICHNUNG	DESIGNATION	DESIGNATION
0233045	SCHLAUCHKLEMME 20-32	HOSE WIRE CLAMP 20-32	COLLIER DE SERRAGE 20-32
0401016	DICHTUNG	PACKING	JOINT
9500289	ROHR	TUBE	TUYAU
8103391	PUMPENHALTERUNG	PUMP SUPPORT	SUPPORT DE POMPE
PUMPE	SIEHE ELEKTROSCHALTPLAN	SEE ELECTRIC WIRING DIAGRAM	VOIR SCHEMA ELECTRIQUE
9500288	SCHLAUCH	HOSE	TUYAU
0237008	MUTTER 2"	NUT 2"	ECROU 2"
0408224	DICHTUNG	PACKING	JOINT
9500089	ABLAUFVENTIL	DRAIN VALVE	VANNE DE VIDANGE
9524035	SIEB FÜR ABLAUF	SIEVE FOR DRAIN	TAMIS POUR VIDANGE
9500083	STANDSIEB	SIEVE	FILTRE
0233096	SCHLAUCHKLEMME	HOSE WIRE CLAMP	COLLIER DE SERRAGE
9515229	ENTLÜFTUNGSVENTIL KPL	VENT VALVE CPL	VANNE D' AERATION CPL
9515230	ENTLÜFTUNGSVENTIL	VENT VALVE	VANNE D' AERATION
9515234	DICHTUNG	PACKING	JOINT
9515231	VERSCHLUSSSCHRAUBE	SCREW PLUG	BOUCHON FILETÉ DE DÉCHARGE
0470025	GUMMIPUFFER	RUBBER BUFFER	TAMPON EN CAOUTCHOUC

12.7 TANKABLAUF, STANDROHR



12.7 TANK DRAIN, STAND PIPE

12.7 VIDANGE DE BAC, TUYAU DE VIDANGE

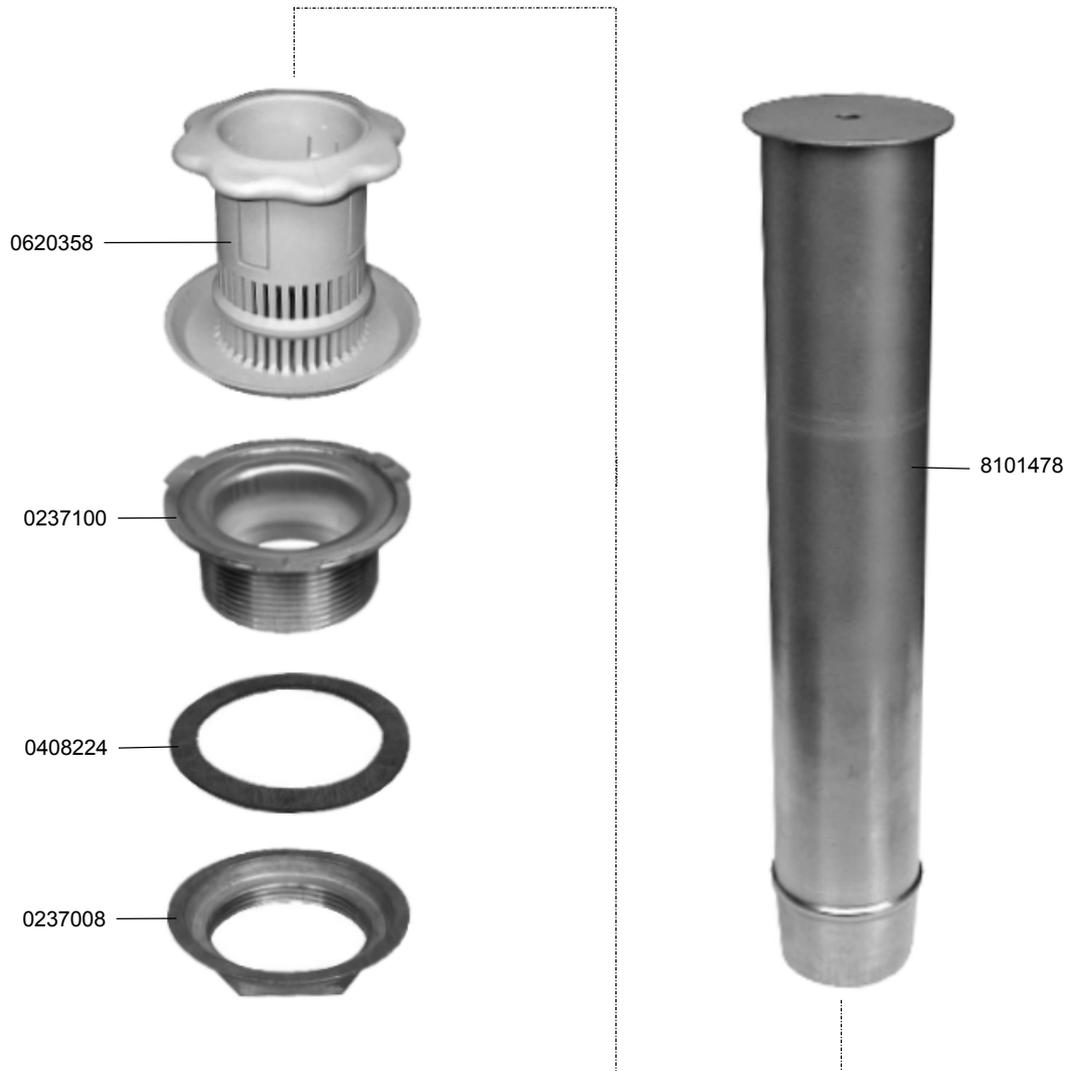

IDENT.-NR. IDENT.-NO.	BEZEICHNUNG	DESIGNATION	DESIGNATION
* 8101478	TRICHTERSTANDROHR	FUNNEL STAND PIPE	TROP-PLEIN ENTONNOIR
0237008	STANDR.VENT.-MUTTER 9942 2"X88 MS.	NUT. NO. 9942 MS 2"X88	ECROU NO. 9942 MS 2"X88
0408224	GUMMIDICHTUNG 78X60X2	RUBBER PACKING 78X60X2	JOINT EN CAOUTCHOUC 78X60X2
0237100	ABLAUF G 2" KOMPLETT	DRAIN 2" 434131240	VIDANGE 2"
* 0620358	SIEB FUER STANDROHR K363	SIEVE F. DRAIN PLUG K363	TAMIS P. TUYAU DE VIDANGE K363

13.1 SCHIEBETÜR 600



13.1 SLIDING DOOR 600

13.1 PORTES COULISSANTES 600

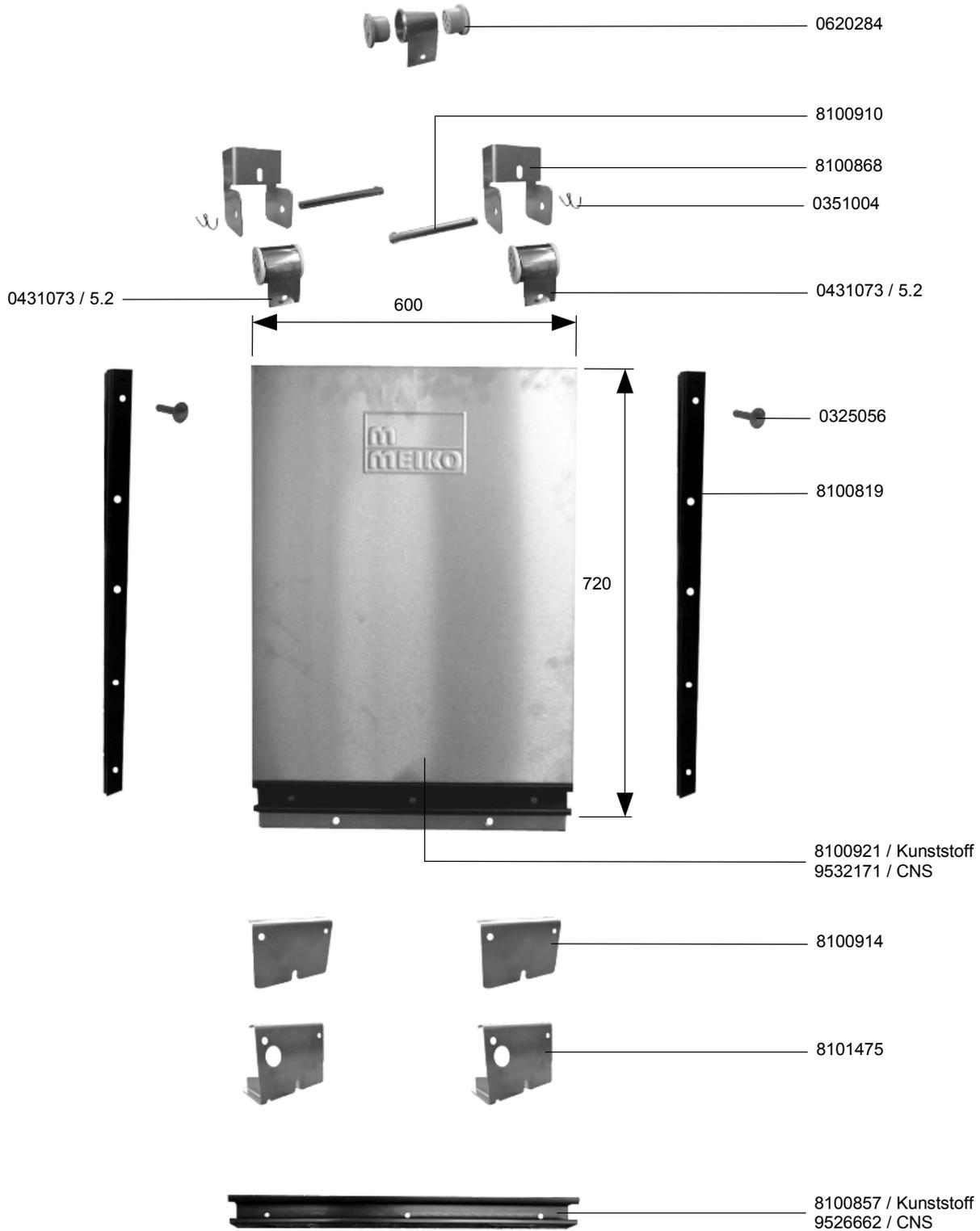

13.1 SCHIEBETÜR 600



13.1 SLIDING DOOR 600

13.1 PORTES COULISSANTES 600

IDENT.-NR. IDENT.-NO.	BEZEICHNUNG	DESIGNATION	DESIGNATION
* 0620284	LAGERROLLE ½"	SUPPORT ROLL ½"	ROLEAU DE SUPPORT ½"
8100910	LAGERBOLZEN KURZ Ø8X78	BOLT SHORT Ø8X78	BOULON Ø8X78
8100868	ROLLFEDERHALTERUNG	SCROLL SPRING SUPPORT	SUPPORT POUR RESSORT A CROSSE
* 0351004	SPLINT 2X20	SPLIT 2X20	GOUPILLE 2X20
V 0431073	ROLLFEDER 5.2	ROLLER SPRING 5.2	ROULEAU A TROU 5.2
0325056	SCHRAUBE M5X30	SCREW M5X30	VIS M5X30
8100819	FÜHRUNGSSCHIENE	GUIDE RAIL	RAIL DE GUIDAGE
8100921	TÜR 600 KPL. MIT KUNSTSTOFF GRIFFPROFIL	DOOR WITH PLASTIC HANDLE PROFILE	PORTE AVEC PROFIL DE MANCHE EN MATIERE PLASTIQUE
9523171	TÜR 600 KPL. MIT CRNI GRIFFPROFIL	DOOR WITH CRNI HANDLE PROFILE	PORTE AVEC PROFIL DE MANCHE EN MATIERE CRNI
8100914	TÜRANSCHLAG	DOOR CATCH	ARRET DE PORTE
8101475	TÜRANSCHLAG MIT ABLAUF SCHLIESSUNG	DOOR CATCH WITH DRAIN CLOSING SYSTEM	ARRET DE PORTE AVEC SYSTEME DE FERMETURE DE VIDANGE
8100857	TÜRGRIFFPFIL KUNSTSTOFF TÜR 600	DOOR HANDLE PROFILE PLASTIC DOOR 600	PROFILE DE POIGNEE DE PORTE EN MATIERE PLASTIQUE PORTE 600
9526662	TÜRGRIFFPFIL CRNI TÜR 600	DOOR HANDLE PROFILE CRNI DOOR 600	PROFILE DE POIGNEE DE PORTE EN MATIERE CRNI PORTE 600

13.2 SCHIEBETÜR 900



13.2 SLIDING DOOR 900

13.2 PORTES COULISSANTES 900

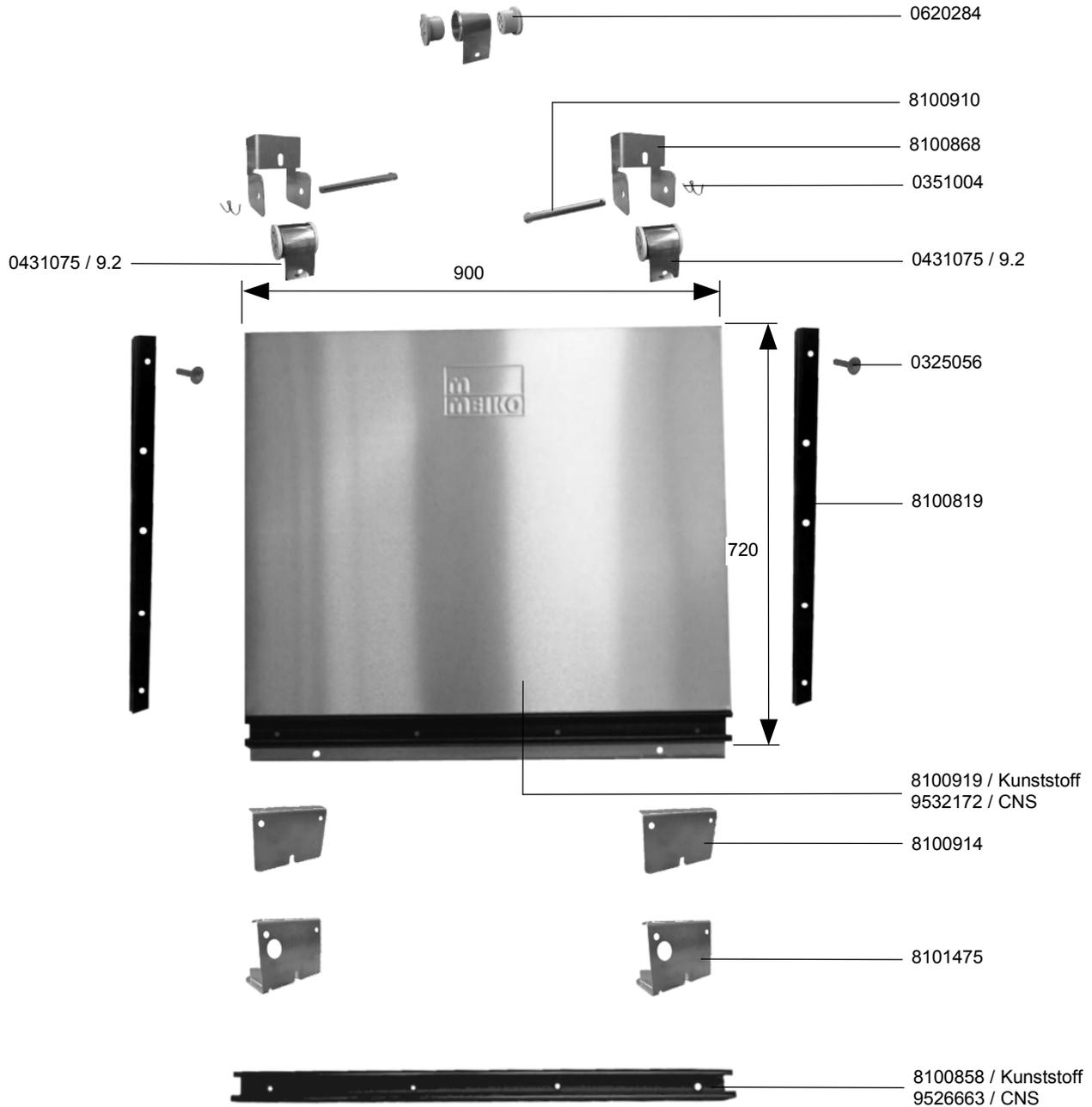

13.2 SCHIEBETÜR 900



13.2 SLIDING DOOR 900

13.2 PORTES COULISSANTES 900

IDENT.-NR. IDENT.-NO.	BEZEICHNUNG	DESIGNATION	DESIGNATION
* 0620284	LAGERROLLE ½"	SUPPORT ROLL ½"	ROLEAU DE SUPPORT ½"
8100910	LAGERBOLZEN KURZ Ø8X78	BOLT SHORT Ø8X78	BOULON Ø8X78
8100868	ROLLFEDERHALTERUNG	SCROLL SPRING SUPPORT	SUPPORT POUR RESSORT A CROSSE
* 0351004	SPLINT 2X20	SPLIT 2X20	GOUPILLE 2X20
V 0431075	ROLLFEDER 9.2	ROLLER SPRING 9.2	ROULEAU A TROU 9.2
0325056	SCHRAUBE M5X30	SCREW M5X30	VIS M5X30
8100819	FÜHRUNGSSCHIENE	GUIDE RAIL	RAIL DE GUIDAGE
8100919	TÜR 900 KPL. MIT KUNSTSTOFF GRIFFPROFIL	DOOR WITH PLASTIC HANDLE PROFILE	PORTE AVEC PROFIL DE MANCHE EN MATIERE PLASTIQUE
9523172	TÜR 900 KPL. MIT CRNI GRIFFPROFIL	DOOR WITH CRNI HANDLE PROFILE	PORTE AVEC PROFIL DE MANCHE EN MATIERE CRNI
8100914	TÜRANSCHLAG	DOOR CATCH	ARRET DE PORTE
8101475	TÜRANSCHLAG MIT ABLAUF SCHLIESSUNG	DOOR CATCH WITH DRAIN CLOSING SYSTEM	ARRET DE PORTE AVEC SYSTEME DE FERMETURE DE VIDANGE
8100858	TÜRGRIFFPFIL KUNSTSTOFF TÜR 900	DOOR HANDLE PROFILE PLASTIC DOOR 900	PROFILE DE POIGNEE DE PORTE EN MATIERE PLASTIQUE PORTE 900
9526663	TÜRGRIFFPFIL CRNI TÜR 900	DOOR HANDLE PROFILE CRNI DOOR 900	PROFILE DE POIGNEE DE PORTE EN MATIERE CRNI PORTE 900

13.3 SCHIEBETÜR 1300



13.3 SLIDING DOOR 1300

13.3 PORTES COULISSANTES 1300

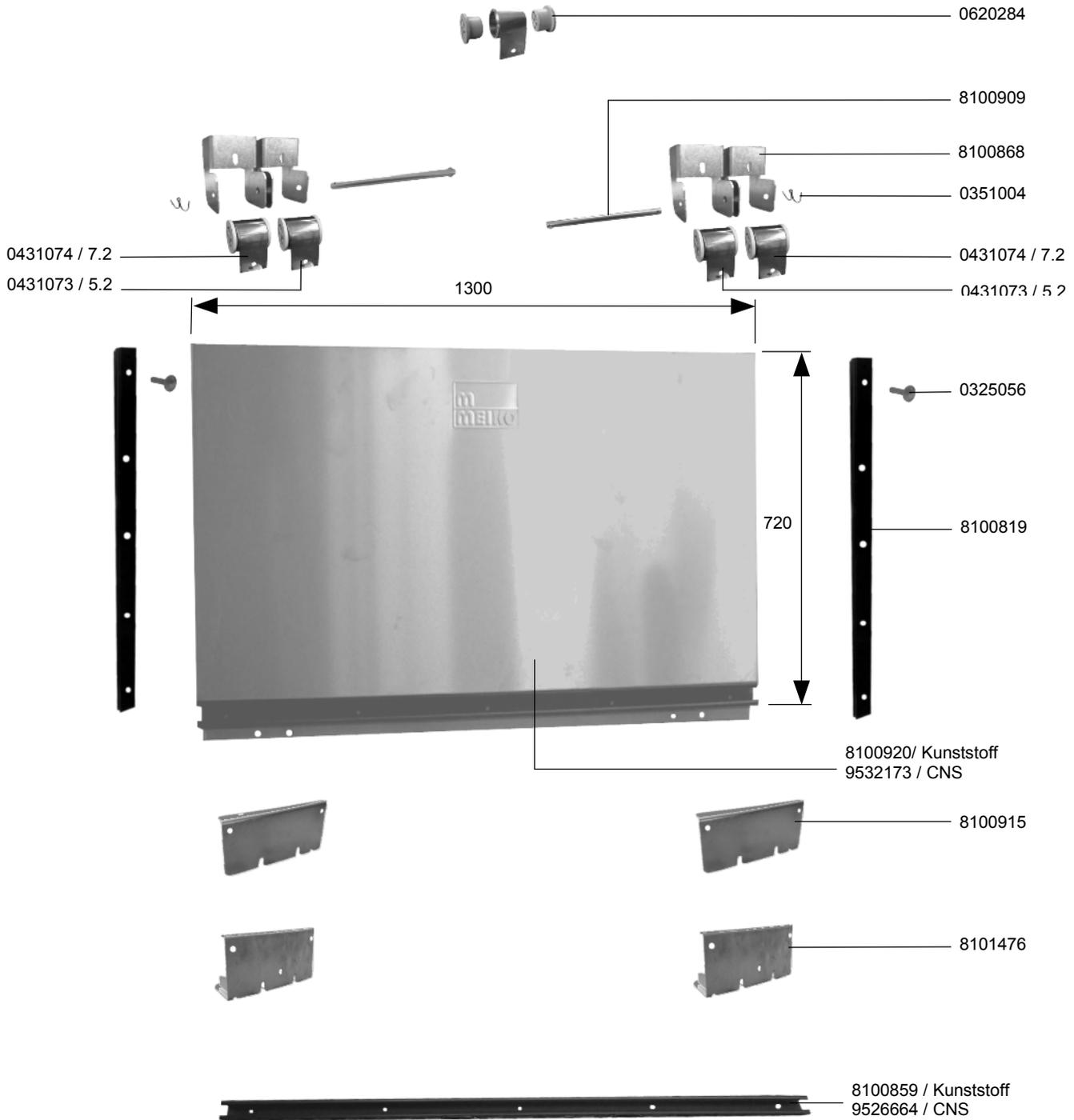

13.3 SCHIEBETÜR 1300



13.3 SLIDING DOOR 1300

13.3 PORTES COULISSANTES 1300

IDENT.-NR. IDENT.-NO.	BEZEICHNUNG	DESIGNATION	DESIGNATION
* 0620284	LAGERROLLE ½"	SUPPORT ROLL ½"	ROLEAU DE SUPPORT ½"
8100909	LAGERBOLZEN LANG Ø8X149	BOLT LONG Ø8X149	BOULON Ø8X149
8100868	ROLLFEDERHALTERUNG	SCROLL SPRING SUPPORT	SUPPORT POUR RESSORT A CROSSE
* 0351004	SPLINT 2X20	SPLIT 2X20	GOUPILLE 2X20
V 0431074	ROLLFEDER 7.2	ROLLER SPRING 7.2	ROULEAU A TROU 7.2
V 0431073	ROLLFEDER 5.2	ROLLER SPRING 5.2	ROULEAU A TROU 5.2
0325056	SCHRAUBE M5X30	SCREW M5X30	VIS M5X30
8100819	FÜHRUNGSSCHIENE	GUIDE RAIL	RAIL DE GUIDAGE
8100920	TÜR 1300 KPL. MIT KUNSTSTOFF GRIFFPROFIL	DOOR WITH PLASTIC HANDLE PROFILE	PORTE AVEC PROFIL DE MANCHE EN MATIERE PLASTIQUE
9523173	TÜR 1300 KPL. MIT CRNI GRIFFPROFIL	DOOR WITH CRNI HANDLE PROFILE	PORTE AVEC PROFIL DE MANCHE EN MATIERE CRNI
8100915	TÜRANSCHLAG	DOOR CATCH	ARRET DE PORTE
8101476	TÜRANSCHLAG MIT ABLAUF SCHLIESSUNG	DOOR CATCH WITH DRAIN CLOSING SYSTEM	ARRET DE PORTE AVEC SYSTEME DE FERMETURE DE VIDANGE
8100859	TÜRGRIFFPROFIL KUNSTSTOFF TÜR 1300	DOOR HANDLE PROFILE PLASTIC DOOR 1300	PROFILE DE POIGNEE DE PORTE EN MATIERE PLASTIQUE PORTE 1300
9526664	TÜRGRIFFPROFIL CRNI TÜR 1300	DOOR HANDLE PROFILE CRNI DOOR 1300	PROFILE DE POIGNEE DE PORTE EN MATIERE CRNI PORTE 1300

14.1 TAKTSCHALTUNG



14.1 INTERVAL SWITCH

14.1 INTERRUPTEUR DE SYNCHRONISATION

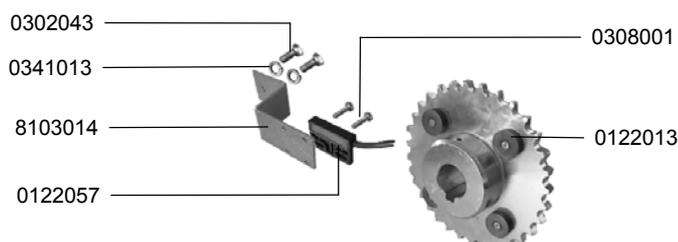
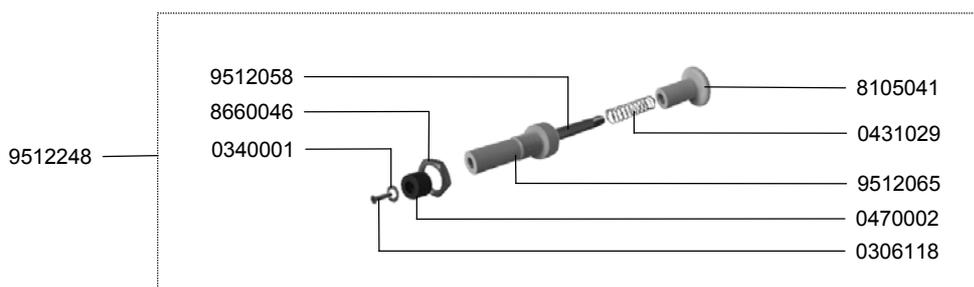
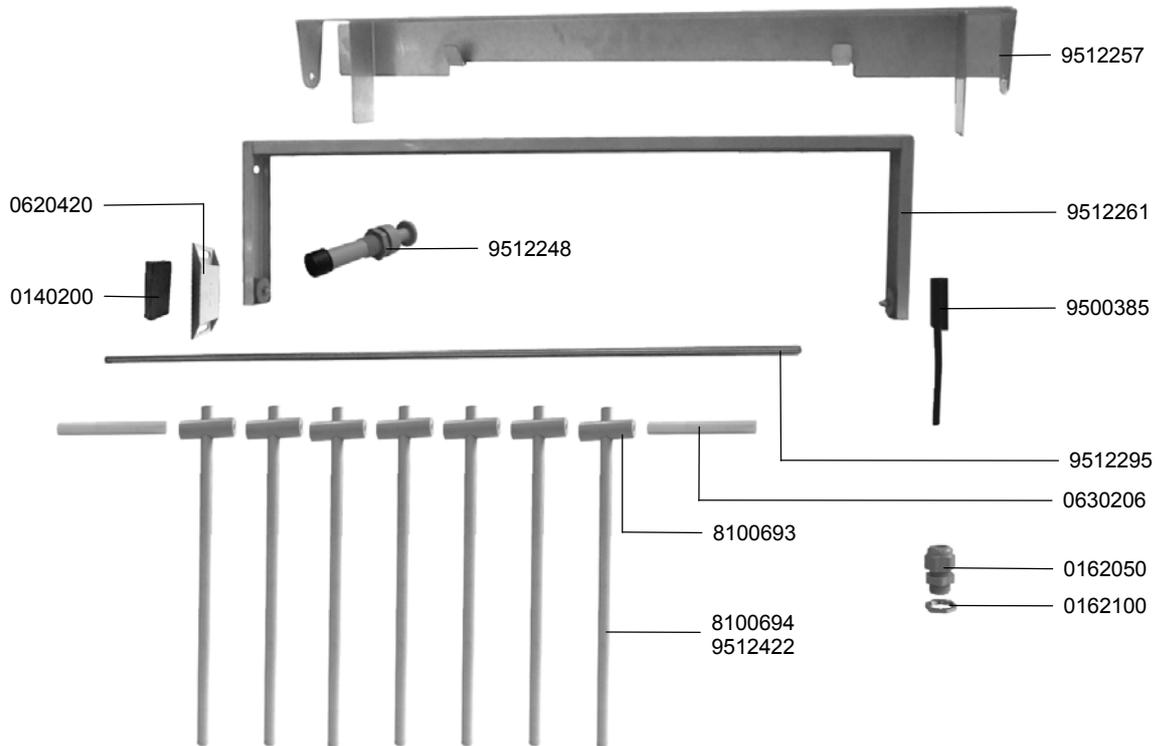

14.1 TAKTSCHALTUNG



14.1 INTERVAL SWITCH

14.1 INTERRUPTEUR DE SYNCHRONISATION

IDENT.-NR. IDENT.-NO.	BEZEICHNUNG	DESIGNATION	DESIGNATION
9512257	AUFHÄNGEBLECH	SUSPENSION	SUSPENSION
9512261	WIPPE	ROCKER	BASCULE
9512248	DRUCKTASTER KPL.	PUSH BUTTON CPL.	BOUTON-POUSSOIR CPL.
9500385	SCHALTER	SWITCH	INTERRUPTEUR
9512295	LAGERSTANGE	BEARING SHAFT	ARBRE DE PALIER
0630206	ROHR	TUBE	TUYAU
8100693	ROHR	TUBE	TUYAU
0162050	VERSCHRAUBUNG	SCREWING	VISSAGE
0162100	GEGENMUTTER	COUNTER NUT	ECROU RACCORD
8100694	ROHR	TUBE	TUYAU
9512422	ROHR	TUBE	TUYAU
8105041	DRUCKKNOPF	BUTTON	BOUTON
0431029	DRUCKFEDER	PRESSURE SPRING	RESSORT DE PRESSION
9512065	SCHALTERFÜHRUNG	SWITCH GUIDING	GUIDAGE D' INTERRUPTEUR
0470002	PUFFER	BOUMPER	AMORTISSEUR
0306118	SCHRAUBE M4X20	SCREW M4X20	VIS M4X20
0308001	SCHRAUBE M3X6	SCREW M3X6	VIS M3X6
0122013	RINGMAGNET	RING MAGNET	AIMANT ROND
0122057	MAGNETSCHALTER	MAGNET SWITCH	INTERRUPTEUR
8103014	BEFESTIGUNGSBLECH	FIXATION	FIXATION
0341013	FEDERRING	SPRING RING	BAGUE RESSORT
0302043	SKT. SCHRAUBE M5X10	HEXAGON SCREW M5X10	VIS A 6 PANS M5X10
0340001	SCHEIBE	DISK	DISQUE
8660046	SKT. MUTTER 1/2"	HEXAGON NUT 1/2"	ECROU A 6 PANS 1/2"
9512058	DRUCKSTANGE	PUSH ROD	BANNE-POUSSOIR
0140200	MAGNET	MAGNET	AIMANT
0640420	HALTERUNG	SUPPORT	SUPPORT

14.1.1 TAKTSCHALTUNG



14.1.1 INTERVAL SWITCH

14.1.1 INTERRUPTEUR DE SYNCHRONISATION

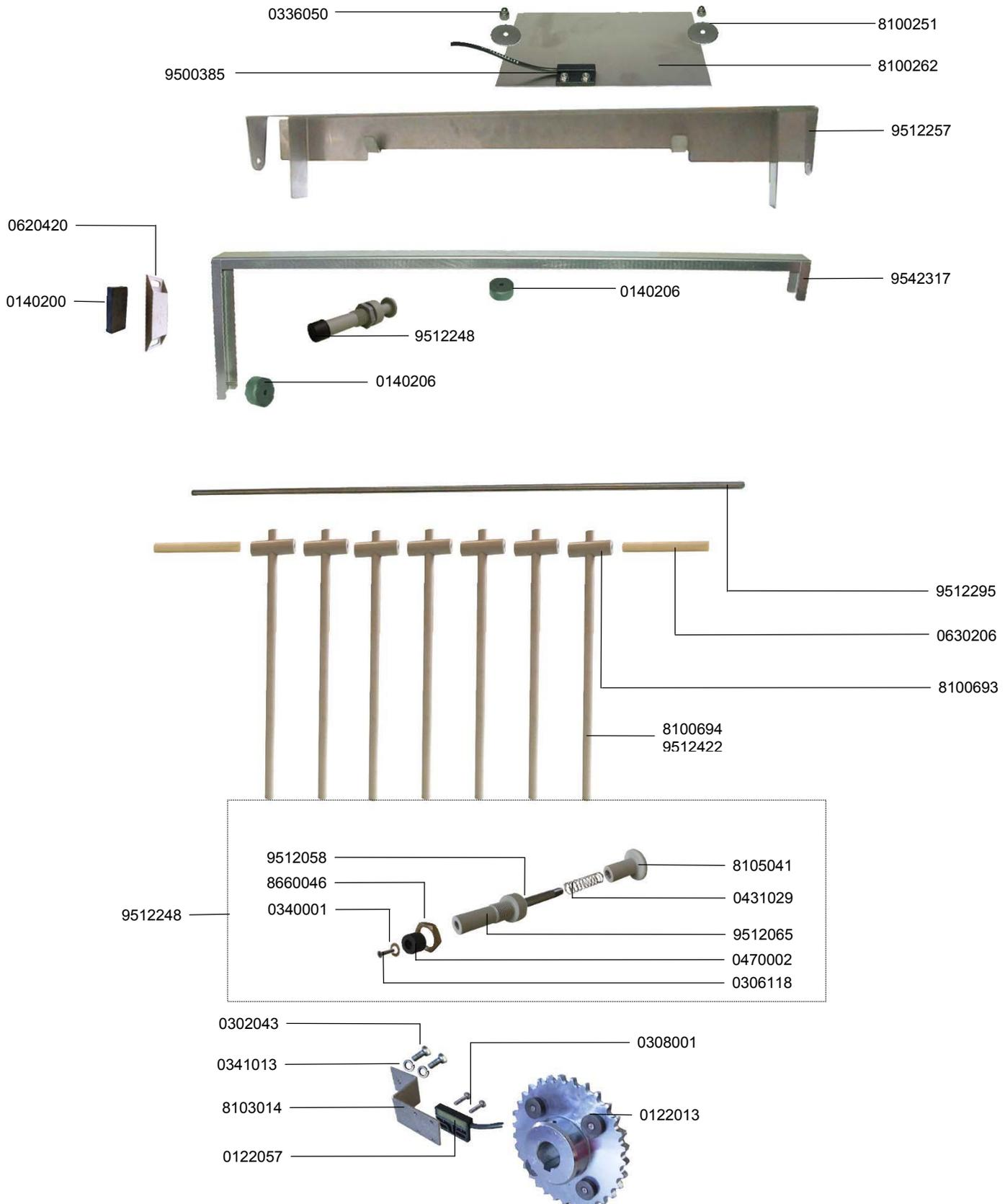

14.1.1 TAKTSCHALTUNG



14.1.1 INTERVAL SWITCH

14.1.1 INTERRUPTEUR DE SYNCHRONISATION

IDENT.-NR. IDENT.-NO.	BEZEICHNUNG	DESIGNATION	DESIGNATION
0336050	HUTMUTTER M5	CAP NUT M5	ECROU BORGNE M5
8100251	U-SCHEIBE D 34*7	FRONT DISC D 34*7	RONDELLE 34*7
8100262	TRÄGERBLECH	HOLDING SHEET.	TOLE A POUTRE.
9500385	SCHALTER	SWITCH	INTERRUPTEUR
9512257	AUFHÄNGEBLECH	SUSPENSION	SUSPENSION
0140206	RINGMAGNET	RING MAGNET	AIMANT ROND
9542317	WIPPE	ROCKER	BASCULE
9512248	DRUCKTASTER KPL.	PUSH BUTTON CPL.	BOUTON-POUSSOIR CPL.
9512295	LAGERSTANGE	BEARING SHAFT	ARBRE DE PALIER
0630206	ROHR	TUBE	TUYAU
8100693	ROHR	TUBE	TUYAU
8100694	ROHR	TUBE	TUYAU
9512422	ROHR	TUBE	TUYAU
8105041	DRUCKKNOPF	BUTTON	BOUTON
0431029	DRUCKFEDER	PRESSURE SPRING	RESSORT DE PRESSION
9512065	SCHALTERFÜHRUNG	SWITCH GUIDING	GUIDAGE D' INTERRUPTEUR
0470002	PUFFER	BOUMPER	AMORTISSEUR
0306118	SCHRAUBE M4X20	SCREW M4X20	VIS M4X20
0308001	SCHRAUBE M3X6	SCREW M3X6	VIS M3X6
0122013	RINGMAGNET	RING MAGNET	AIMANT ROND
0122057	MAGNETSCHALTER	MAGNET SWITCH	INTERRUPTEUR
8103014	BEFESTIGUNGSBLECH	FIXATION	FIXATION
0341013	FEDERRING	SPRING RING	BAGUE RESSORT
0302043	SKT. SCHRAUBE M5X10	HEXAGON SCREW M5X10	VIS A 6 PANS M5X10
0340001	SCHEIBE	DISK	DISQUE
8660046	SKT. MUTTER 1/2"	HEXAGON NUT 1/2"	ECROU A 6 PANS 1/2"
9512058	DRUCKSTANGE	PUSH ROD	BANNE-POUSSOIR
0140200	MAGNET	MAGNET	AIMANT
0640420	HALTERUNG	SUPPORT	SUPPORT

14.1.2 TAKTSCHALTUNG



14.1.2 INTERVAL SWITCH

14.1.2 INTERRUPTEUR DE SYNCHRONISATION

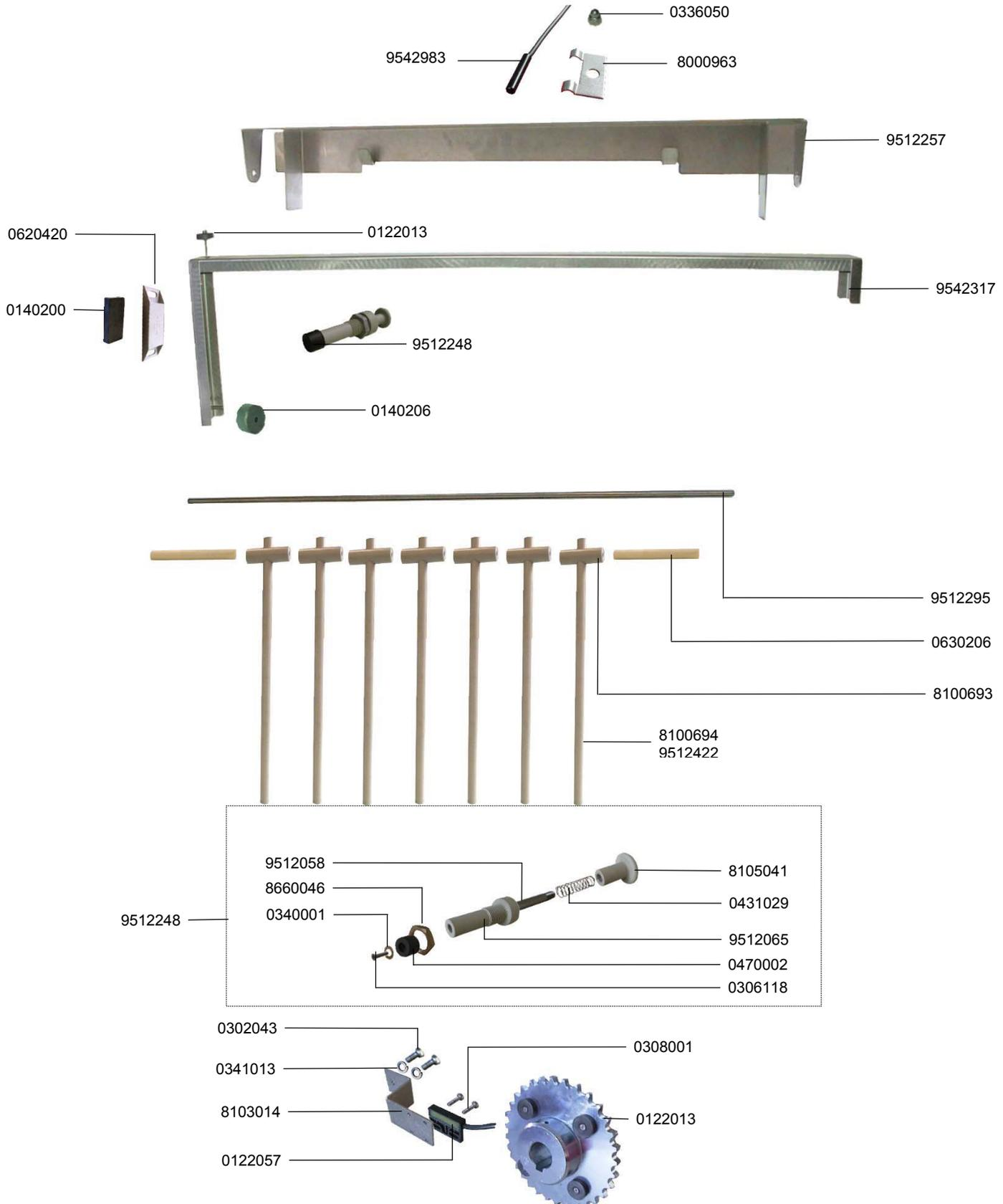

14.1.2 TAKTSCHALTUNG



14.1.2 INTERVAL SWITCH

14.1.2 INTERRUPTEUR DE SYNCHRONISATION

IDENT.-NR. IDENT.-NO.	BEZEICHNUNG	DESIGNATION	DESIGNATION
0336050	HUTMUTTER M5	CAP NUT M5	ECROU BORGNE M5
9000963	HALTER	SUPPORT	APPUI
9542983	SCHALTER	SWITCH	INTERRUPTEUR
9512257	AUFHÄNGEBLECH	SUSPENSION	SUSPENSION
0122013	MAGNET	MAGNET	AIMANT
9542317	WIPPE	ROCKER	BASCULE
9512248	DRUCKTASTER KPL.	PUSH BUTTON CPL.	BOUTON-POUSOIR CPL.
9512295	LAGERSTANGE	BEARING SHAFT	ARBRE DE PALIER
0630206	ROHR	TUBE	TUYAU
8100693	ROHR	TUBE	TUYAU
8100694	ROHR	TUBE	TUYAU
9512422	ROHR	TUBE	TUYAU
8105041	DRUCKKNOPF	BUTTON	BOUTON
0431029	DRUCKFEDER	PRESSURE SPRING	RESSORT DE PRESSION
9512065	SCHALTERFÜHRUNG	SWITCH GUIDING	GUIDAGE D' INTERRUPTEUR
0470002	PUFFER	BOUMPER	AMORTISSEUR
0306118	SCHRAUBE M4X20	SCREW M4X20	VIS M4X20
0308001	SCHRAUBE M3X6	SCREW M3X6	VIS M3X6
0122013	RINGMAGNET	RING MAGNET	AIMANT ROND
0122057	MAGNETSCHALTER	MAGNET SWITCH	INTERRUPTEUR
8103014	BEFESTIGUNGSBLECH	FIXATION	FIXATION
0341013	FEDERRING	SPRING RING	BAGUE RESSORT
0302043	SKT. SCHRAUBE M5X10	HEXAGON SCREW M5X10	VIS A 6 PANS M5X10
0340001	SCHEIBE	DISK	DISQUE
8660046	SKT. MUTTER 1/2"	HEXAGON NUT 1/2"	ECROU A 6 PANS 1/2"
9512058	DRUCKSTANGE	PUSH ROD	BANNE-POUSOIR
0140206	MAGNET	MAGNET	AIMANT
0640420	HALTERUNG	SUPPORT	SUPPORT

15.1 UMLENKUNG



15.1 REVERSE UNIT

15.1 RENVOI

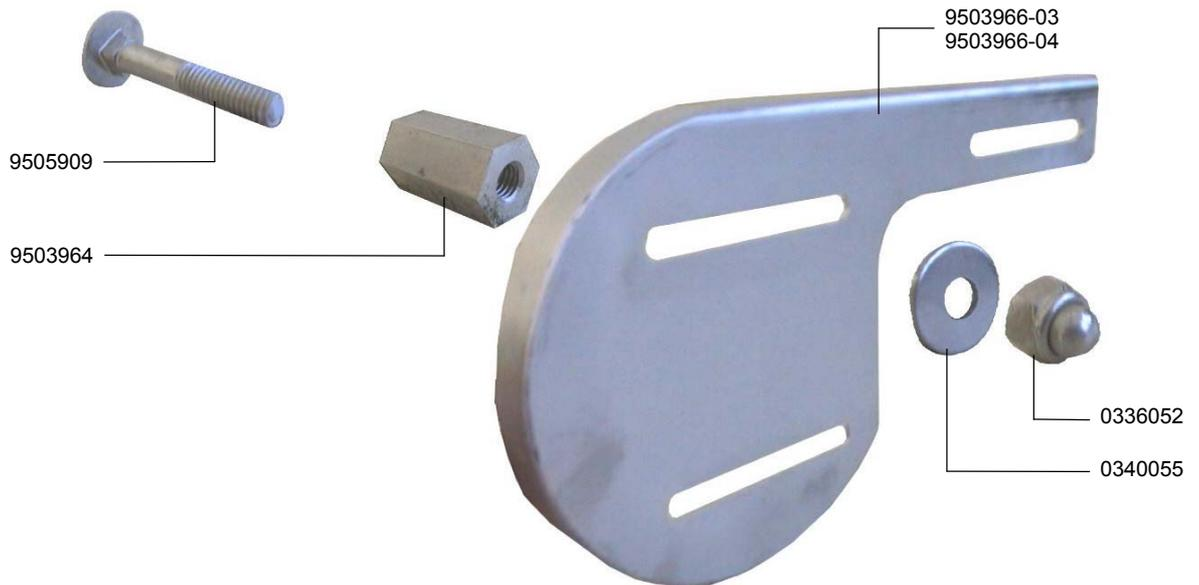

IDENT.-NR. IDENT.-NO.	BEZEICHNUNG	DESIGNATION	DESIGNATION
9503966-03	UMLENKSCHIEBE LINKS	REVERSE DISK LEFT	DISQUE DE RENVOI GAUGE
9503966-04	UMLENKSCHIEBE RECHTS	REVERSE DISK RIGHT	DISQUE DE RENVOI DROITE
0336052	HUTMUTTER M8	CAP NUT M8	ECROU BORGNE M8
0340055	SCHEIBE	DISK	DISQUE
9503964	DISTANZKLOTZ SW17X30	DISTANCE BLOCK	BLOC DE DISTANCE
9505909	SCHRAUBE M8X45	SCREW M8X45	VIS M8X45

15.2 BANDANTRIEB DREHSTROM / FREQUENZUMRICHTERBETRIEB



15.2 BELT DRIVE 3-PHASE-CURRENT / FREQUENCY CONVERTER OPERATION

15.2 ENTRAINEMENT DE CONVOYEUR TRI-PHASE / OPÉRATION DU CONVERTEUR DE FRÉQUENCE

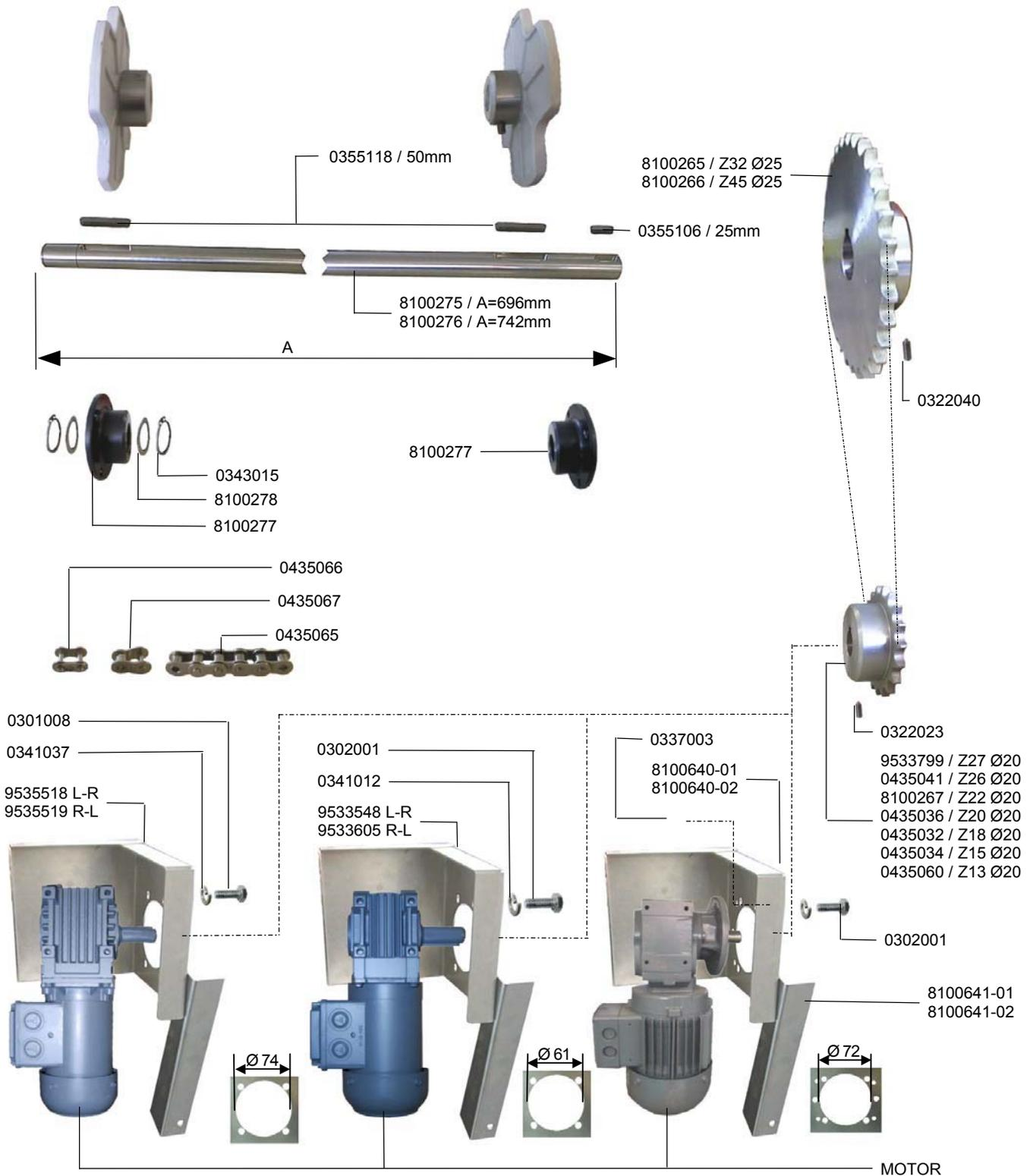

15.2 BANDANTRIEB DREHSTROM / FREQUENZUMRICHTERBETRIEB



15.2 BELT DRIVE 3-PHASE-CURRENT / FREQUENCY CONVERTER OPERATION

15.2 ENTRAINEMENT DE CONVOYEUR TRI-PHASE / OPERATION DU CONVERTEUR DE FREQUENCE

IDENT.-NR. IDENT.-NO.	BEZEICHNUNG	DESIGNATION	DESIGNATION
* 0355118	PASSFEDER 8X7X50	FEATHER KEY 8X7X50	RESSORT D' AJUSTAGE 8X7X50
8100265	KETTENRAD Z45 Ø25	CHAIN WHEEL Z45 Ø25	ROUE DE CHAINE Z45 Ø25
8100266	KETTENRAD Z32 Ø25	CHAIN WHEEL Z32 Ø25	ROUE DE CHAINE Z32 Ø25
* 0355106	PASSFEDER 8X7X25	FEATHER KEY 8X7X25	RESSORT D' AJUSTAGE 8X7X25
8100275	ANTRIEBSWELLE A=696MM	DRIVE SHAFT A=696MM	ARBRE D' ENTRAINEMENT A=696MM
8100276	ANTRIEBSWELLE A=742MM	DRIVE SHAFT A=742MM	ARBRE D' ENTRAINEMENT A=742MM
0322040	GEWINDESTIFT M8X20	SET SCREW M8X20	VIS SANS TETE M8X20
0322023	GEWINDESTIFT M6X12	SET SCREW M6X12	VIS SANS TETE M6X12
9533799	KETTENRAD Z27 Ø20	CHAIN WHEEL Z27 Ø20	ROUE DE CHAINE Z27 Ø20
0435041	KETTENRAD Z26 Ø20	CHAIN WHEEL Z26 Ø20	ROUE DE CHAINE Z26 Ø20
8100267	KETTENRAD Z22 Ø20	CHAIN WHEEL Z22 Ø20	ROUE DE CHAINE Z22 Ø20
0435036	KETTENRAD Z20 Ø20	CHAIN WHEEL Z20 Ø20	ROUE DE CHAINE Z20 Ø20
0435032	KETTENRAD Z18 Ø20	CHAIN WHEEL Z18 Ø20	ROUE DE CHAINE Z18 Ø20
0435034	KETTENRAD Z15 Ø20	CHAIN WHEEL Z15 Ø20	ROUE DE CHAINE Z15 Ø20
0435060	KETTENRAD Z13 Ø20	CHAIN WHEEL Z13 Ø20	ROUE DE CHAINE Z13 Ø20
0302001	SKT. SCHRAUBE M6X16	HEXAGON NUT M6X16	VIS A 6 PANS M6X16
8100641-01	SPANNWINKEL L-R	TENSION ANGLE L-R	ANGLE DE TENSION L-R
8100641-02	SPANNWINKEL R-L	TENSION ANGLE R-L	ANGLE DE TENSION R-L
MOTOR	SIEHE ELEKTROSCHALTPLAN	SEE ELECTRIC WIRING DIAGRAM	VOIR SCHEMA ELECTRIQUE
9535519	MOTORWIPPE R-L	CONSOLE R-L	CONSOLE R-L
9535518	MOTORWIPPE L-R	CONSOLE L-R	CONSOLE L-R
0341037	FEDERRING 8	SPRING RING 8	RESSORT 8
0301008	SKT. SCHRAUBE M8X15	HEXAGON NUT M8X15	VIS A 6 PANS M8X15
9533605	MOTORWIPPE R-L	CONSOLE R-L	CONSOLE R-L
9533548	MOTORWIPPE L-R	CONSOLE L-R	CONSOLE L-R
0341012	FEDERRING 6	SPRING RING 6	RESSORT 6
8100640-02	MOTORWIPPE R-L	CONSOLE R-L	CONSOLE R-L
8100640-01	MOTORWIPPE L-R	CONSOLE L-R	CONSOLE L-R
0337003	SKT. MUTTER M6	HEXAGON NUT M6	VIS A 6 PANS M6
* 0435065	ROLLENKETTE	DRIVE CHAIN	CHAINE A ROULEAU
* 0435067	KETTENKROEPFGLIED	HALF MEMBER	ELEMENT DE CHAINE ONDULE
* 0435066	KETTENSCHLUSSGLIED	CHAIN LOCK	ELEMENT FINAL DE CHAINE
8100277	LAGER	BEARING	PALIER
8100278	SCHEIBE	DISK	DISQUE
0343015	SICHERUNGSRING	CIRCLIP	CIRCLIP

15.3 BANDANTRIEB GLEICHSTROM



15.3 BELT DRIVE DIRECT CURRENT

15.3 ENTRAINEMENT DE CONVOYEUR COURANT CONTINU

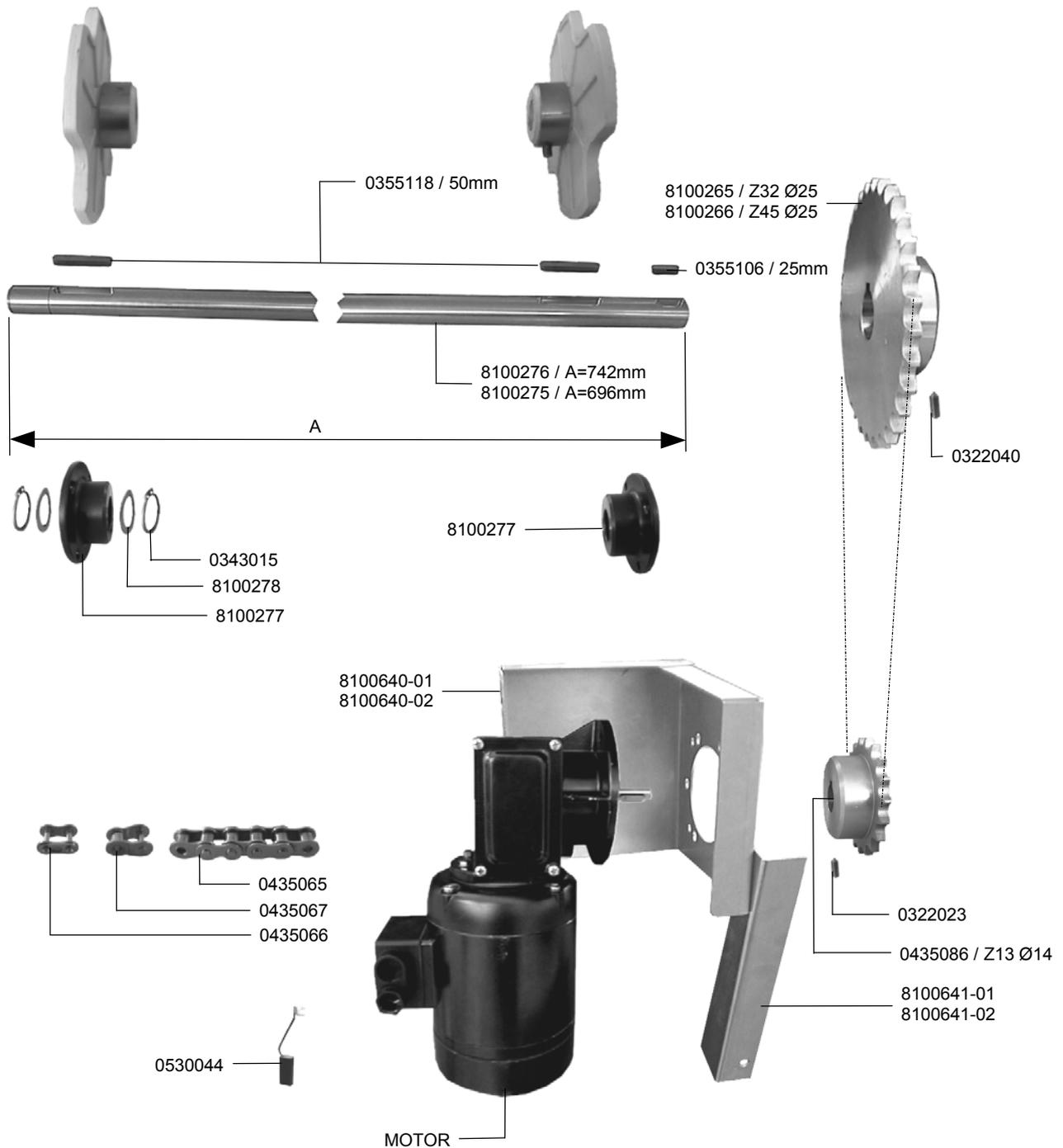

15.3 BANDANTRIEB GLEICHSTROM



15.3 BELT DRIVE DIRECT CURRENT

15.3 ENTRAINEMENT DE CONVOYEUR COURANT CONTINU

IDENT.-NR. IDENT.-NO.	BEZEICHNUNG	DESIGNATION	DESIGNATION
* 0355118	PASSFEDER 8X7X50	FEATHER KEY 8X7X50	RESSORT D' AJUSTAGE 8X7X50
8100265	KETTENRAD Z45	CHAIN WHEEL Z45	ROUE DE CHAINE Z45
8100266	KETTENRAD Z32	CHAIN WHEEL Z32	ROUE DE CHAINE Z32
* 0355106	PASSFEDER 8X7X25	FEATHER KEY 8X7X25	RESSORT D' AJUSTAGE 8X7X25
8100275	ANTRIEBSWELLE A=696MM	DRIVE SHAFT A=696MM	ARBRE D' ENTRAINEMENT A=696MM
8100276	ANTRIEBSWELLE A=742MM	DRIVE SHAFT A=742MM	ARBRE D' ENTRAINEMENT A=742MM
0322040	GEWINDESTIFT M8X20	SET SCREW M8X20	VIS SANS TETE M8X20
0322023	GEWINDESTIFT M6X12	SET SCREW M6X12	VIS SANS TETE M6X12
0435086	KETTENRAD Z13 Ø14	CHAIN WHEEL Z13 Ø14	ROUE DE CHAINE Z13 Ø14
8100641-01	SPANNWINKEL L-R	TENSION ANGLE L-R	ANGLE DE TENSION L-R
8100641-02	SPANNWINKEL R-L	TENSION ANGLE R-L	ANGLE DE TENSION R-L
MOTOR	SIEHE ELEKTROSCHALTPLAN	SEE ELECTRIC WIRING DIAGRAM	VOIR SCHEMA ELECTRIQUE
V 0530044	KOHLLEN	CARBON	CHARBRON
* 0435066	KETTENSCHLUSSGLIED	CHAIN LOCK	ELEMENT FINAL DE CHAINE
* 0435067	KETTENKROEPFGLIED	HALF MEMBER	ELEMENT DE CHAINE ONDULE
* 0435065	ROLLENKETTE	DRIVE CHAIN	CHAINE A ROULEAU
8100640-02	MOTORWIPPE R-L	CONSOLE R-L	CONSOLE R-L
8100640-01	MOTORWIPPE L-R	CONSOLE L-R	CONSOLE L-R
8100277	LAGER	BEARING	PALIER
8100278	SCHEIBE	DISK	DISQUE
0343015	SICHERUNGSRING	CIRCLIP	CIRCLIP

15.4 KETTENSpannung DREHSTROM / FREQUENZUMRICHTERBETRIEB



15.4 CHAIN TENSION 3-PHASE CURRENT/ FREQUENCY CONVERTER OPERATION

15.4 TENSION DE CHAINE A COURANT TRIPHASE/ OPERATION DU CONVERTEUR DE FREQUENCE

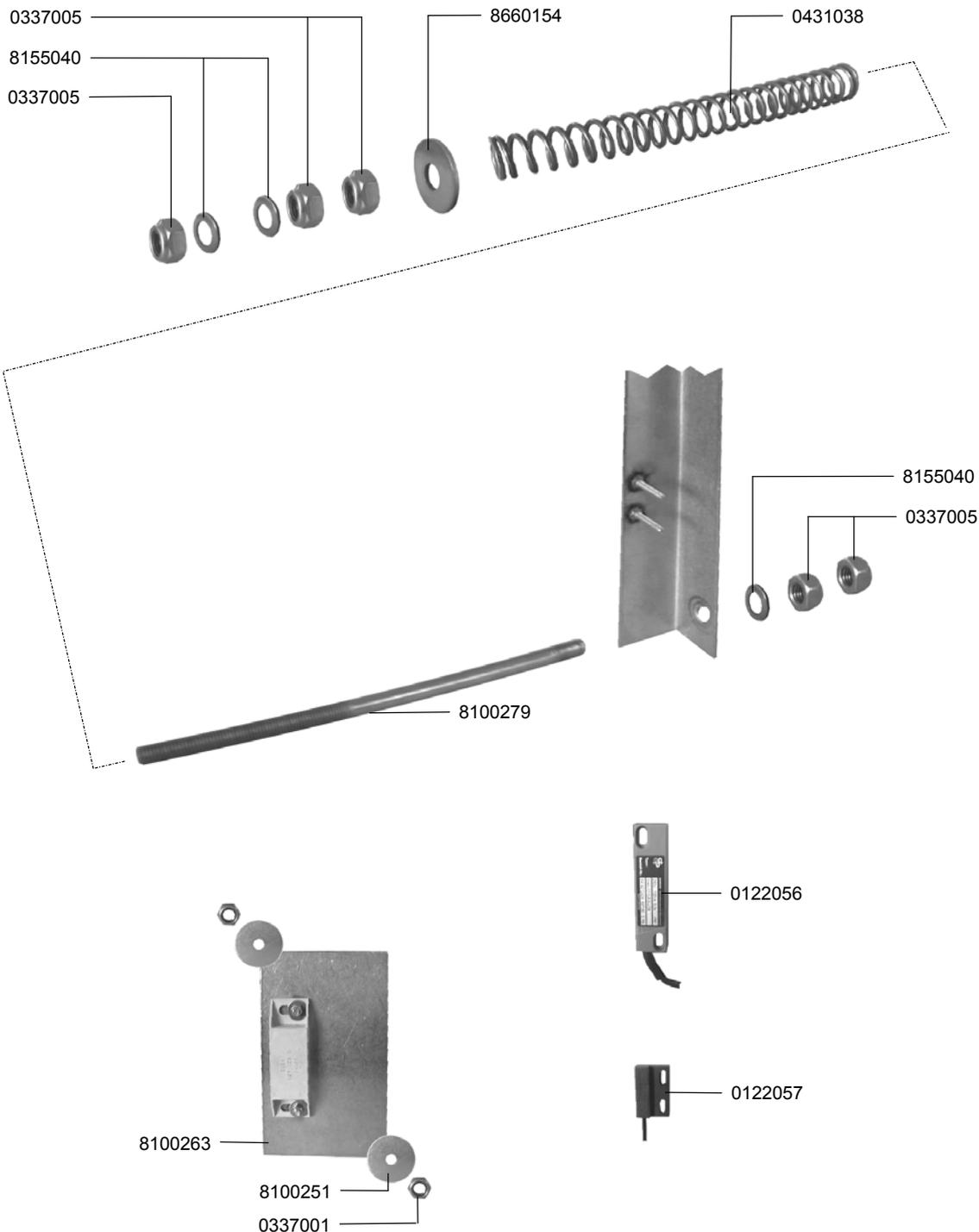

15.4 KETTENSPIANNUNG DREHSTROM / FREQUENZUMRICHTERBETRIEB



15.4 CHAIN TENSION 3-PHASE CURRENT/ FREQUENCY CONVERTER OPERATION

15.4 TENSION DE CHAINE A COURANT TRIPHASE/ OPERATION DU CONVERTEUR DE FREQUENCE

IDENT.-NR. IDENT.-NO.	BEZEICHNUNG	DESIGNATION	DESIGNATION
8660154	SCHEIBE	DISK	DISQUE
* 0431038	DRUCKFEDER	PRESSURE SPRING	RESSORT DE PRESSION
8155040	SCHEIBE	DISK	DISQUE
0337005	SKT. MUTTER M8	HEXAGON NUT M8	ECROU A 6 PANS M8
8100279	GEWINDESTANGE	THREADED ROD	TIGE FILETEE
* 0122056	GRENZTASTER	LIMIT SWITCH	INTERRUPTEUR FINAL COURSE
* 0122057	MAGNETSCHALTER	SOLENOID SWITCH	INTERRUPTEUR
0337001	SKT. MUTTER M5	HEXAGON NUT M5	ECROU A 6 PANS M5
8100251	SCHEIBE	DISK	DISQUE
8100263	TRÄGERBLECH KPL.	HOLDING SHEET CPL.	TOLE A POUTRE CPL.

15.5 KETTENSPIANNUNG GLEICHSTROM



15.5 CHAIN TENSION DIRECT CURRENT

15.5 TENSION DE CHAINE A COURANT CONTINU

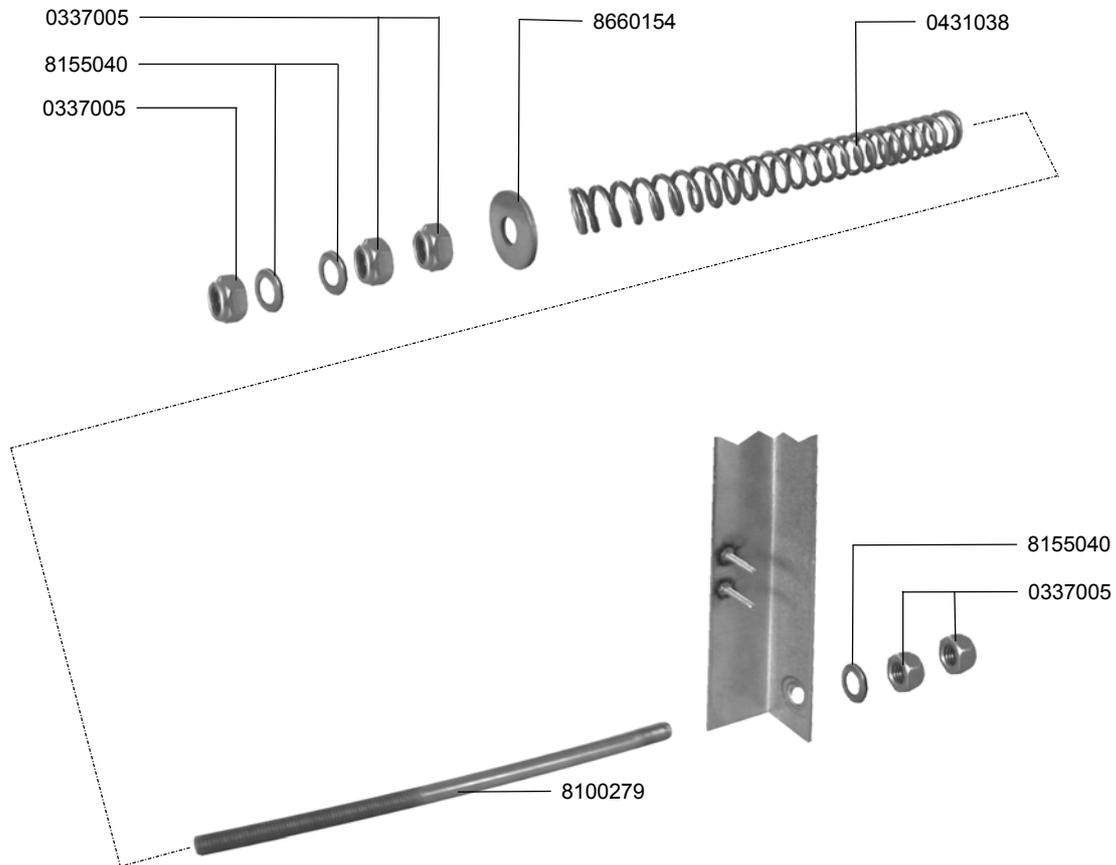

IDENT.-NR. IDENT.-NO.	BEZEICHNUNG	DESIGNATION	DESIGNATION
8660154	SCHEIBE	DISK	DISQUE
* 0431038	DRUCKFEDER	PRESSURE SPRING	RESSORT DE PRESSION
8155040	SCHEIBE	DISK	DISQUE
0337005	SKT. MUTTER M8	HEXAGON NUT M8	ECROU A 6 PANS M8
8100279	GEWINDESTANGE	THREADED ROD	TIGE FILETEE

15.6 BANDENDSCHALTER



15.6 FINAL SWITCH FOR BELT

15.6 INTERRUPTEUR FINAL POUR CONVOYEUR

9518755 / A=15 MTB 1.2, 1.4, 2.2, 2.3, 2.4, 2.5, 2.6, 2.9, 7.2, 7.3, 7.4

8100268 / A=25 MTB 2.7, 2.11, 2.12, 2.13, 2.16, 2.17, 2.18, 2.19

9518759 / A=30 MTB 3.3, 3.4, 3.7

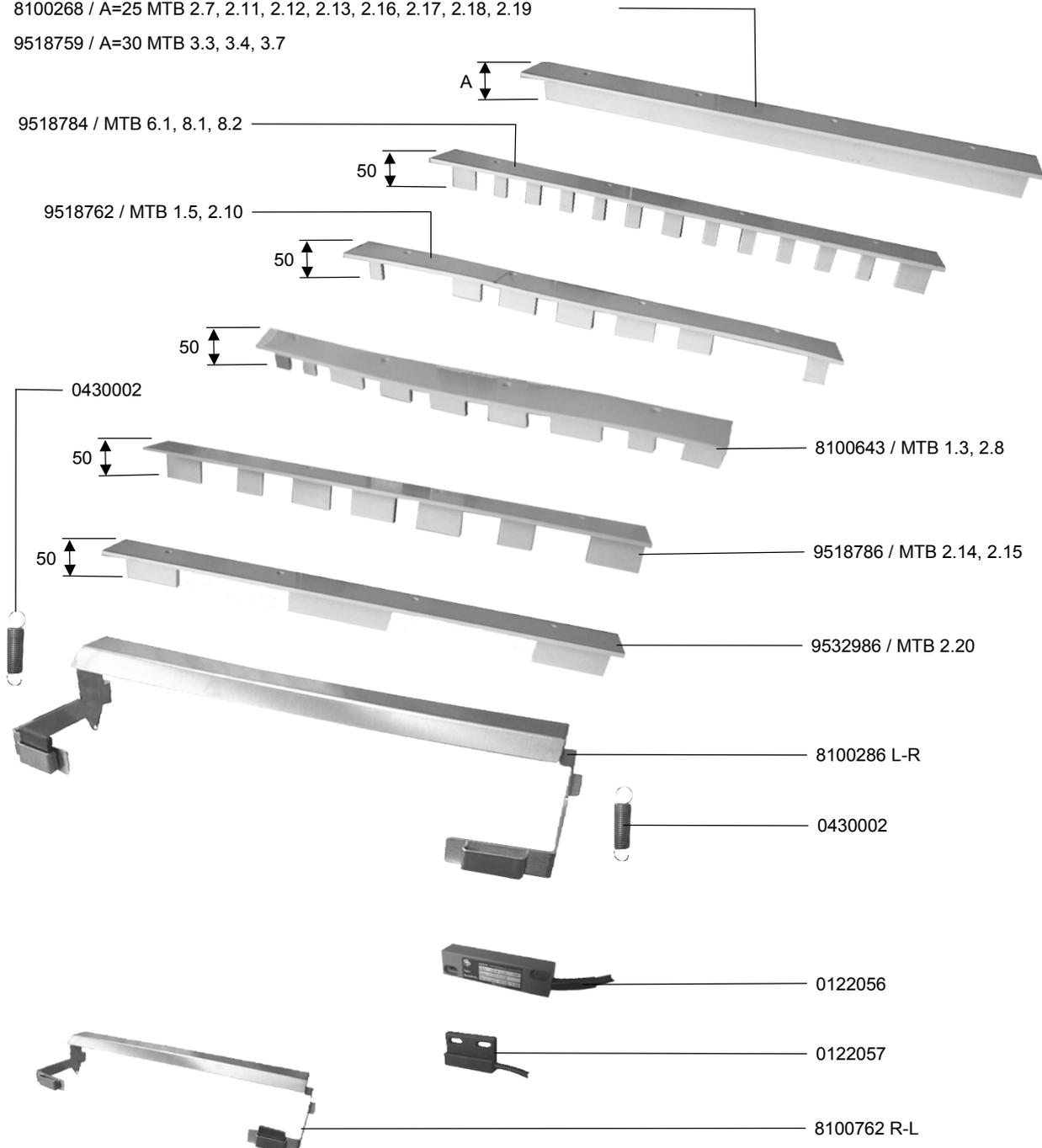

15.6 BANDENDSCHALTER



15.6 FINAL SWITCH FOR BELT

15.6 INTERRUPTEUR FINAL POUR CONVOYEUR

IDENT.-NR. IDENT.-NO.	BEZEICHNUNG	DESIGNATION	DESIGNATION
8100643	WINKEL 50 BAND 1.3, 2.8	ANGLE 50 BELT 1.3, 2.8	ANGLE 50 BANDE 1.3, 2.8
9518786	WINKEL 50 BAND 2.14, 2.15	ANGLE 50 BELT 2.14, 2.15	ANGLE 50 BANDE 2.14, 2.15
9532986	WINKEL 50 BAND 2.20	ANGLE 50 BELT 2.20	ANGLE 50 BANDE 2.20
8100286	ENDSCHALTERWIPPE KPL L-R	FINAL SWITCH ROCKER CPL. L-R	BASCULE D' INTERRUPTEUR FINAL CPL. L-R
* 0430002	ZUGFEDER	TENSION SPRING	RESSORT DE TENSIONS
* 0122056	GRENZTASTER	LIMIT SWITCH	INTERRUPTEUR FINAL COURSE
* 0122057	MAGNETSCHALTER	SOLENOID SWITCH	INTERRUPTEUR
8100762	ENDSCHALTERWIPPE KPL R-L	FINAL SWITCH ROCKER CPL. R-L	BASCULE D' INTERRUPTEUR FINAL CPL. R-L
9518762	WINKEL 50 BAND 1.5, 2.10	ANGLE 50 BELT 1.5, 2.10	ANGLE 50 BANDE 1.5, 2.10
9518784	WINKEL 50 BAND 6.1, 8.1, 8.2	ANGLE 50 BELT 6.1, 8.1, 8.2	ANGLE 50 BANDE 6.1, 8.1, 8.2
9518759	WINKEL A=50 BAND 3.3, 3.4, 3.7	ANGLE A=50 BELT 3.3, 3.4, 3.7	ANGLE A=50 BANDE 3.3, 3.4, 3.7
8100268	WINKEL A=25 BAND 2.7, 2.11, 2.12, 2.13, 2.16, 2.17, 2.18, 2.19	ANGLE A=25 BELT 2.7, 2.11, 2.12, 2.13, 2.16, 2.17, 2.18, 2.19	ANGLE A=25 BANDE 2.7, 2.11, 2.12, 2.13, 2.16, 2.17, 2.18, 2.19
9518755	WINKEL A=15 BAND 1.2, 1.4, 2.2, 2.3, 2.4, 2.5, 2.6, 2.9, 7.2, 7.3, 7.4	ANGLE A=15 BELT 1.2, 1.4, 2.2, 2.3, 2.4, 2.5, 2.6, 2.9, 7.2, 7.3, 7.4	ANGLE A=15 BANDE 1.2, 1.4, 2.2, 2.3, 2.4, 2.5, 2.6, 2.9, 7.2, 7.3, 7.4

16.1 MASCHINENTRANSPORTBAND, TEILUNG 108MM



16.1 TRANSPORTCONVEYOR, DIVISION 108MM

16.1 CONVOYEUR DE TRANSPORT, DIVISION 108MM

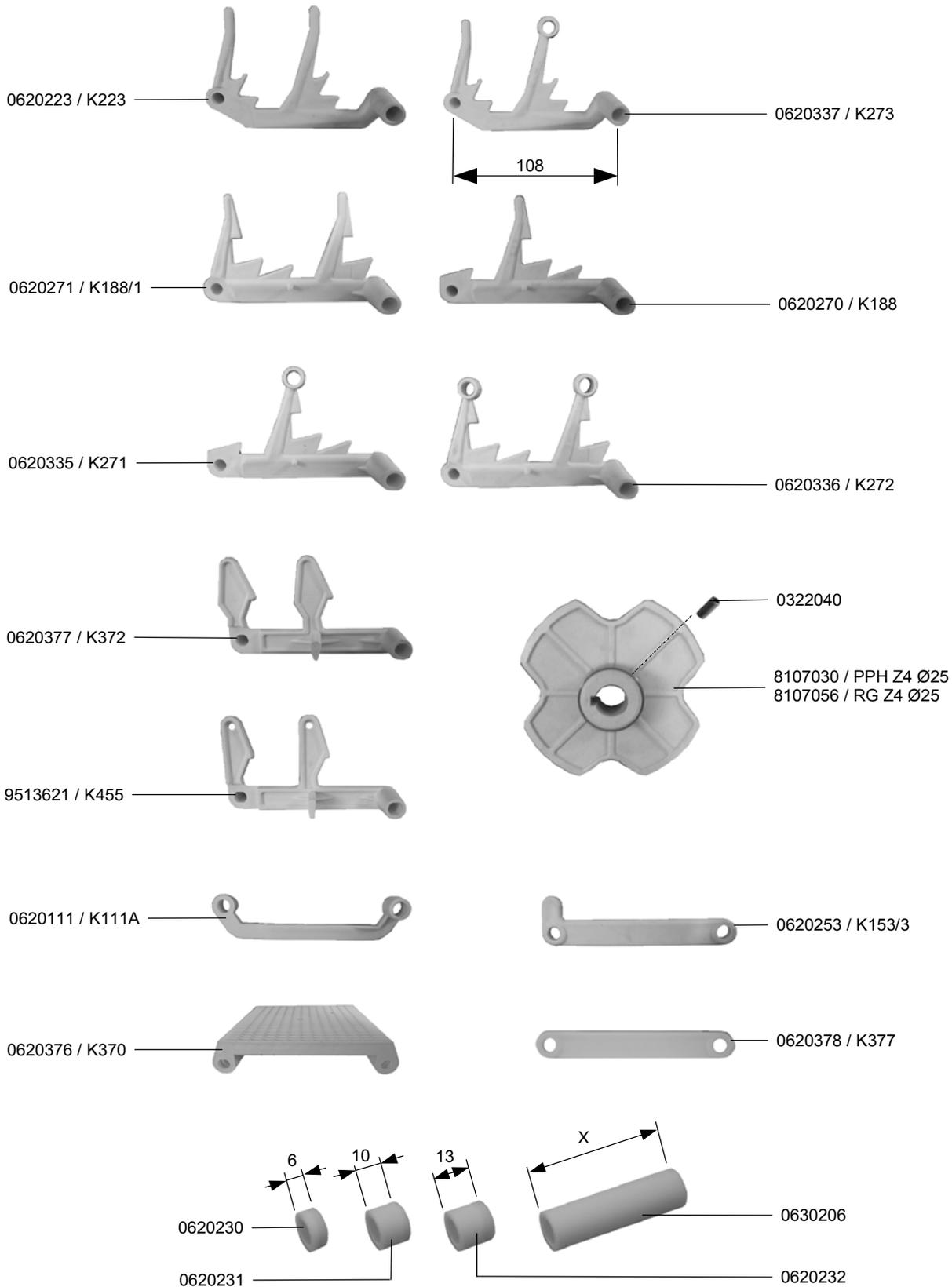

16.1 MASCHINENTRANSPORTBAND, TEILUNG 108MM



16.1 TRANSPORTCONVEYOR, DIVISION 108MM

16.1 CONVOYEUR DE TRANSPORT, DIVISION 108MM

IDENT.-NR. IDENT.-NO.	BEZEICHNUNG	DESIGNATION	DESIGNATION
0620337	BANDFINGER K273	BELT FINGER K273	DOIGT DE BANDE K273
0620270	BANDGLIED K188	BELT FINGER K188	DOIGT DE BANDE K188
0620336	BANDFINGER K272	BELT FINGER K272	DOIGT DE BANDE K272
0322040	GEWINDESTIFT M8X20	SET SCREW M8X20	VIS SANS TETE M8X20
8107030	KETTENRAD PPH Z4 Ø25	CHAIN WHEEL PPH Z4 Ø25	ROUE DE CHAINE PPH Z4 Ø25
8107056	KETTENRAD RG Z4 Ø25	CHAIN WHEEL RG Z4 Ø25	ROUE DE CHAINE RG Z4 Ø25
0620253	MITNEHMER K153/3	CARRIER K153/3	DOIGT K153/3
0620378	LASCHE K377	PLATE K377	MAILLON K377
0630206	PP-ROHR	PP-TUBE	PP-TUYAU
0620232	DISTANZSTUECK K125/13	INTERMEDIATE PIECE K125/13	PIECE INTERMEDIAIRE K125/13
0620231	DISTANZSTUECK K125/10	INTERMEDIATE PIECE K125/10	PIECE INTERMEDIAIRE K125/10
0620230	DISTANZSTUECK K125/6	INTERMEDIATE PIECE K125/6	PIECE INTERMEDIAIRE K125/6
0620376	BESTECKTEIL K370	MEMBER K370	MEMBRE K370
0620111	ZWISCHENGLIED K111A	BELT FINGER K111A	DOIGT DE BANDE K111A
9513621	BANDFINGER K455	BELT FINGER K455	DOIGT DE BANDE K455
0620377	BANDFINGER K372	BELT FINGER K372	DOIGT DE BANDE K372
0620335	BANDFINGER K271	BELT FINGER K271	DOIGT DE BANDE K271
0620271	BANDGLIED K188/1	BELT FINGER K188/1	DOIGT DE BANDE K188/1
0620223	BANDFINGER K223	BELT FINGER K223	DOIGT DE BANDE K223

16.2 MASCHINENTRANSPORTBAND, TEILUNG 60MM



16.2 CONVEYOR BELT, DIVISION 60MM

16.2 CONVOYEUR DE TRANSPORT, DIVISION 60MM

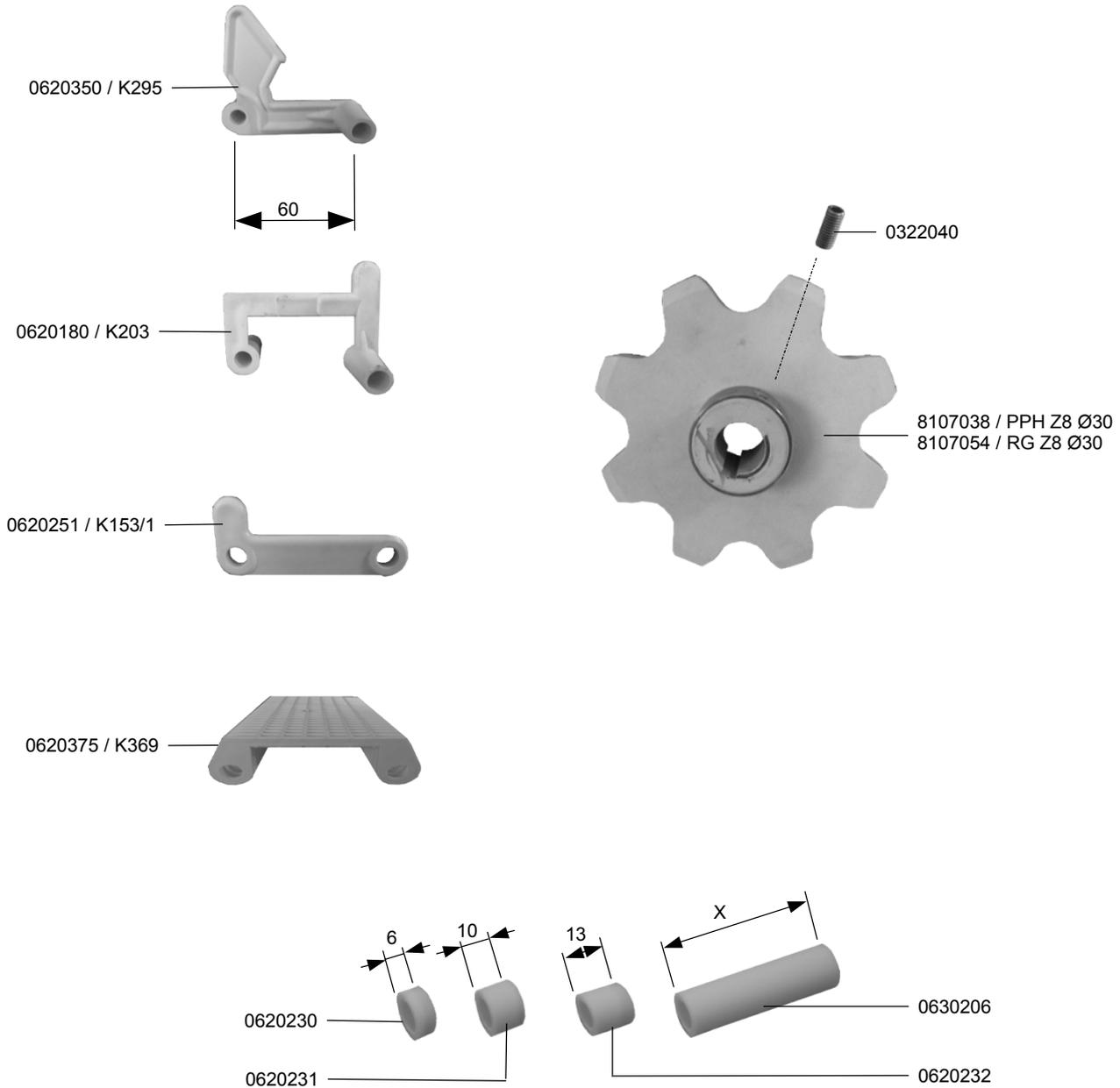

16.2 MASCHINENTRANSPORTBAND, TEILUNG 60MM



16.2 CONVEYOR BELT, DIVISION 60MM

16.2 CONVOYEUR DE TRANSPORT, DIVISION 60MM

IDENT.-NR. IDENT.-NO.	BEZEICHNUNG	DESIGNATION	DESIGNATION
0322040	GEWINDESTIFT M8X20	SET SCREW M8X20	VIS SANS TETE M8X20
8107038	KETTENRAD PPH Z8 Ø30	CHAIN WHEEL PPH Z8 Ø30	ROUE DE CHAINE PPH Z8 Ø30
8107054	KETTENRAD RG Z8 Ø30	CHAIN WHEEL RG Z8 Ø30	ROUE DE CHAINE RG Z8 Ø30
0630206	PP-ROHR	PP-TUBE	PP-TUYAU
0620232	DISTANZSTUECK K125/13	INTERMEDIATE PIECE K125/13	PIECE INTERMEDIAIRE K125/13
0620231	DISTANZSTUECK K125/10	INTERMEDIATE PIECE K125/10	PIECE INTERMEDIAIRE K125/10
0620230	DISTANZSTUECK K125/6	INTERMEDIATE PIECE K125/6	PIECE INTERMEDIAIRE K125/6
V 0620375	BESTECKTEIL K369	MEMBER K369	MEMBRE K369
V 0620251	MITNEHMER K153/1	CARRIER K153/1	DOIGT K153/1
V 0620180	BANDFINGER K203	BELT FINGER K203	DOIGT DE BANDE K203
V 0620350	KETTENGLIED K295	MEMBER K295	MEMBRE K295

16.3 MASCHINENTRANSPORTBAND



16.3 CONVEYOR BELT

16.3 CONVOYEUR DE TRANSPORT

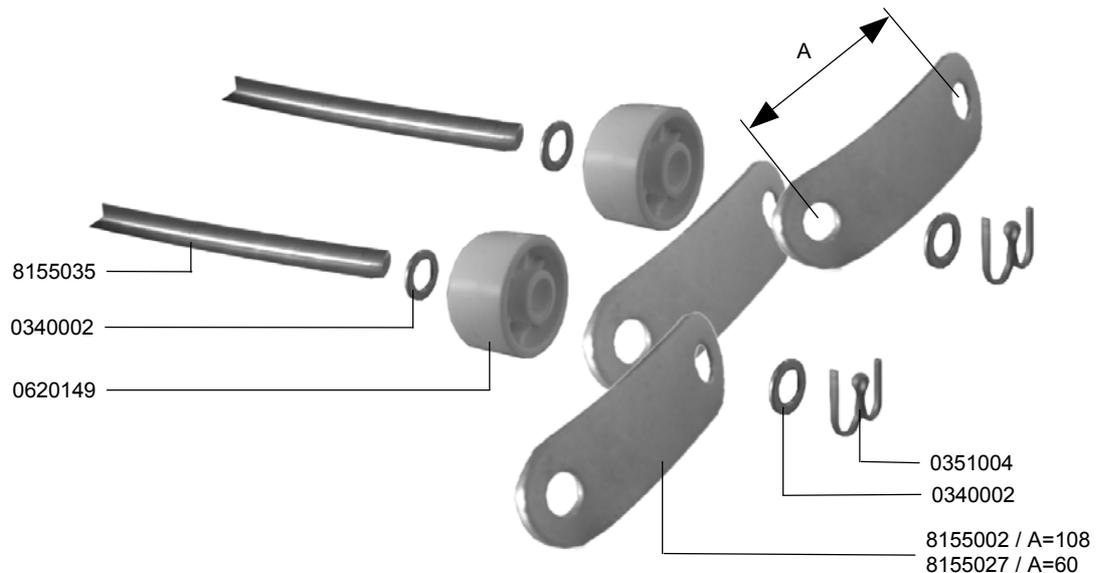

IDENT.-NR. IDENT.-NO.	BEZEICHNUNG	DESIGNATION	DESIGNATION
V 0351004	SPLINT 2X20	SPLIT 2X20	GOUPILLE 2X20
0340002	SCHEIBE	DISK	DISQUE
8155002	KETTENLASCHE T108	CHAIN PLATE T108	MAILLON DE CHAIN T108
8155027	KETTENLASCHE T60	CHAIN PLATE T60	MAILLON DE CHAIN T60
V 0620149	LAUFROLLE	ROLLER	GALET
8155035	BANDSTANGE Ø8X610	BELT ROD Ø8X610	BARRE DE CONVOYEUR Ø8X610

17.1 TROCKNUNG



17.1 DRYING

17.1 SECHAGE

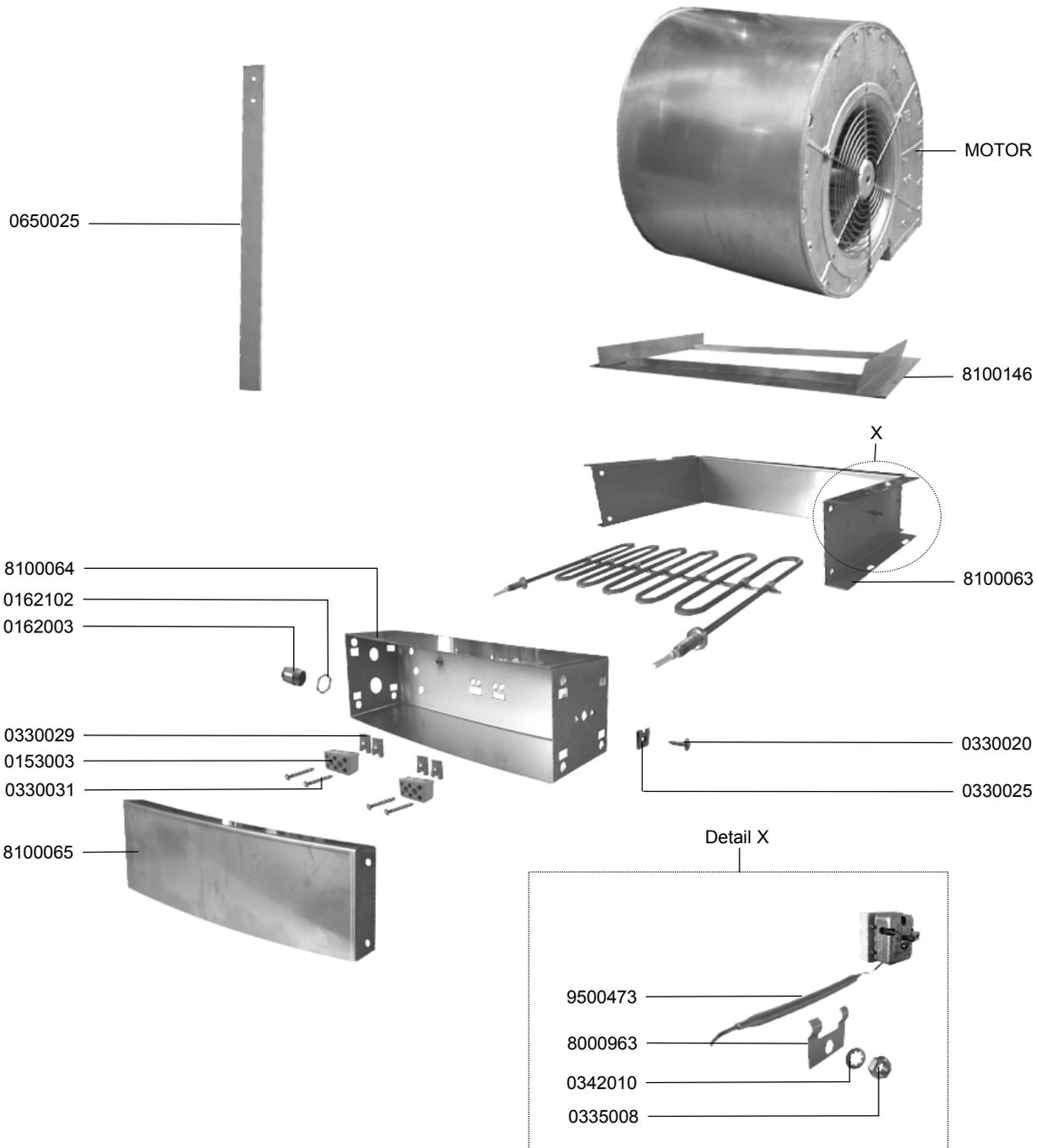

17.1 TROCKNUNG



17.1 DRYING

17.1 SECHAGE

IDENT.-NR. IDENT.-NO.	BEZEICHNUNG	DESIGNATION	DESIGNATION
MOTOR	SIEHE ELEKTROSCHALTPLAN	SEE ELECTRIC DIAGRAM	VOIR SCHEMA ELECTRIQUE
8100146	RAHMEN FÜR GEBLÄSE,SCHW.T 1.4301 440X250X30	FRAME FOR FAN 1.4301 440X250X30	CADRE DE VENTILATEUR 1.4301 440X250X30
8100063	MANTEL	CLADDING	HABILLAGE
0330020	SCHRAUBE 4,2X13	SCREW 4,2X13	VIS 4,2X13
0330025	BLECHMUTTER	NUT	ECROU
* 9500473	TEMPERATURFÜHLER	TEMPERATURE PROBE	SONDE DE TEMPERATURE
8000963	HALTER	FIXATION	FIXATION
0342010	ZAHNSCHEIBE	TOOTH LOCK WASHER	RONDELLE A FENTE
0335008	MUTTER M5	NUT M5	ECROU M5
8100065	ABDECKBLECH	COVER	COUVERCLE
0330031	SCHRAUBE 2,9X22	SCREW 2,9X22	VIS 2,9X22
0153003	ANSCHLUSSKLEMME	CONNECTING TERMINAL	BORNE
0330029	KLAMMER	CLAMP	BRIDE DE FIXATION
0162003	VERSCHRAUBUNG	SCREWING	VISSAGE
0162102	GEGENMUTTER	COUNTERNUT	CONTRE-ECROU
8100064	HEIZKÖRPERBLECH	HEATING REGISTER HOUSING	CAISSON DE RESISTANCE
0650025	GUMMI FÜR NIEDERHALTER	RUBBER FOR HOLDING DOWN DEVICE	CAOUTCHOUC POUR SUPPORT BAS

17.2 HEIZKÖRPER, TROCKNUNG



17.2 HEATING ELEMENT, DRYING

17.2 RESISTANCE, SECHAGE

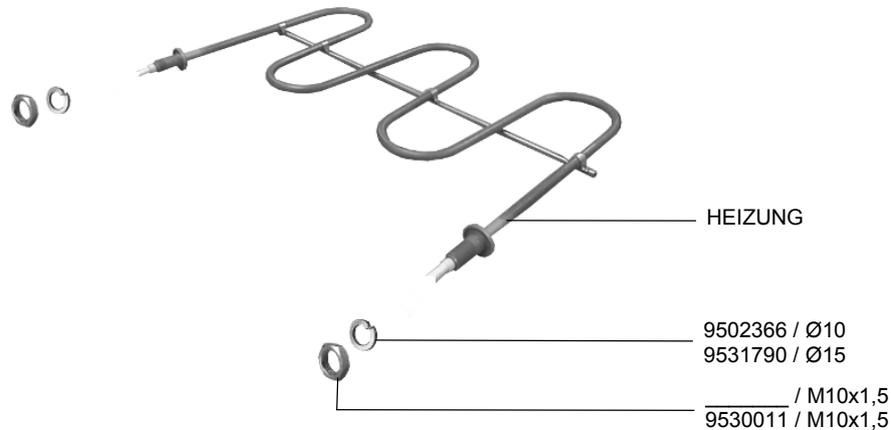
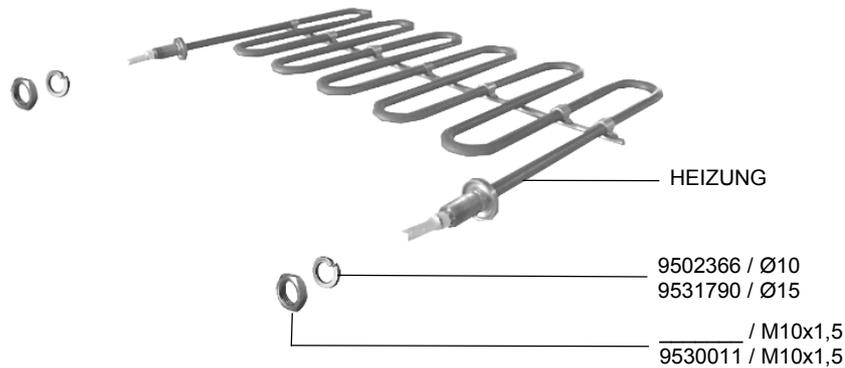

IDENT.-NR. IDENT.-NO.	BEZEICHNUNG	DESIGNATION	DESIGNATION
HEIZUNG	SIEHE ELEKTROSCHALTPLAN	SEE ELECTRIC WIRING DIAGRAM	VOIR SHEMA ELECTRIQUE
9502366	FEDERRING Ø10	SPRING RING	BAGUE DE RESSORT
9531790	SCHEIBE Ø15	DISK	DISQUE
-----	SKT. MUTTER M10X1,5	HEXAGON NUT M10X1,5	ECROU A 6 PANS M10X1,5
9530011	SKT. MUTTER M14X1,5	HEXAGON NUT M14X1,5	ECROU A 6 PANS M14X1,5

17.3 TROCKNUNGSGEBLÄSE



17.3 DRYING FAN

17.3 VENTILATEUR DE SECHAGE

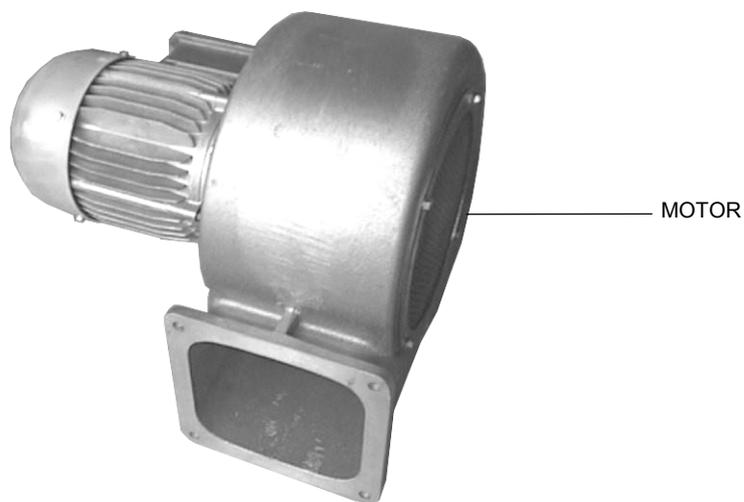

IDENT.-NR. IDENT.-NO.	BEZEICHNUNG	DESIGNATION	DESIGNATION
MOTOR	SIEHE ELEKTROSCHALTPLAN	SEE ELECTRIC DIAGRAM	VOIR SCHEMA ELECTRIQUE

17.4 TROCKNUNGSSHEIZREGISTER



17.4 DRYING HEATING REGISTER

17.4 REGISTRE DE CHAUFFAGE SECHAGE



0252028 / Cu
0252033 / 1.4301



8259966 / 1.4435

IDENT.-NR. IDENT.-NO.	BEZEICHNUNG	DESIGNATION	DESIGNATION
0252028	HEIZREGISTER CU	HEATING REGISTER CU	REGISTRE DE CHAUFFAGE CU
0252033	HEIZREGISTER 1.4301	HEATING REGISTER 1.4301	REGISTRE DE CHAUFFAGE 1.4301
8259966	LUFTERHITZER GEFLANSCHT 1.4435	HEATING REGISTER FLANGED 1.4435	REGISTRE DE CHAUFFAGE BRIDE 1.4435

18.1 EINLAUFSIEBSYSTEM



18.1 INFEEED SIEVE SYSTEM

18.1 SYSTEME DE TAMIS D'ENTREE

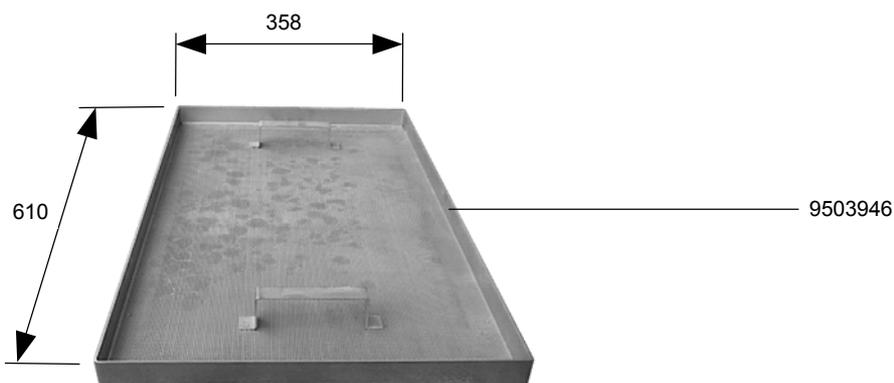
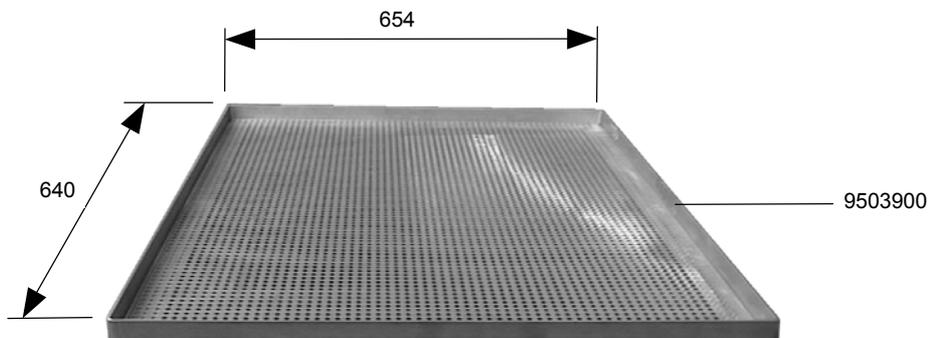
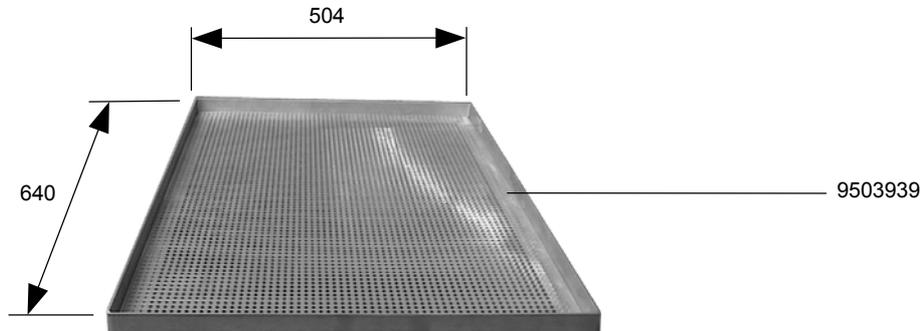

IDENT.-NR. IDENT.-NO.	BEZEICHNUNG	DESIGNATION	DESIGNATION
9503939	ABDECKSIEB GROB	COVERING SIEVE	TAMIS DE RECOUVREMENT
9503900	ABDECKSIEB GROB	COVERING SIEVE	TAMIS DE RECOUVREMENT
9503946	ABDECKSIEB FEIN	COVERING SIEVE	TAMIS DE RECOUVREMENT

18.2 TANKABDECKSIEBSYSTEM



18.2 TANK COVERING SIEVE SYSTEM

18.2 SYSTEME DE TAMIS DE RECOUVREMENT

Ident-Nr.	a
8103188	546,5

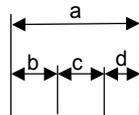
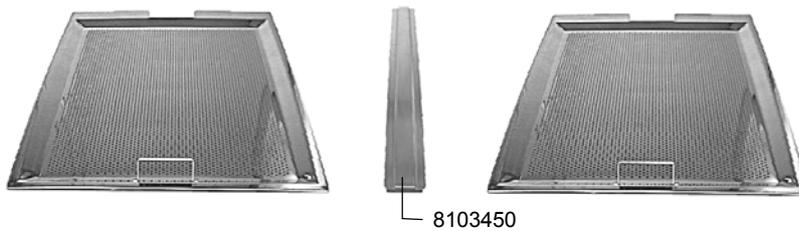
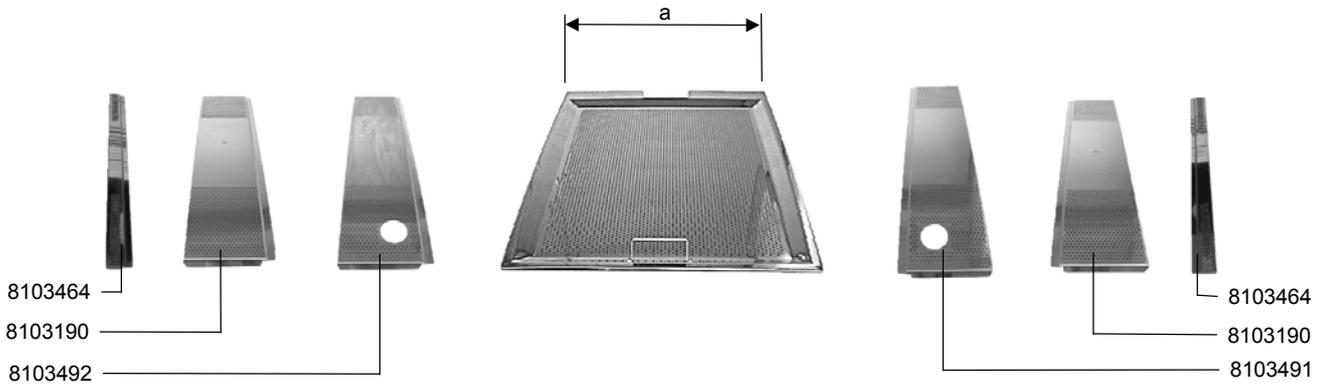

Ident-Nr.	a	b	c	d
8103459	364,5	132,25	118	114,25
8103460	364,5	114,25	118	132,25
8103448	364,5	--	--	--

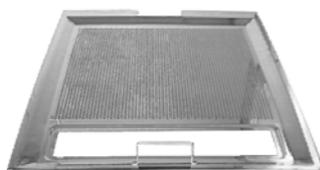
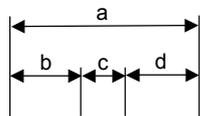

Ident-Nr.	a	b	c	d
8103186	546,5	214,25	118	214,25
8103420	364,5	14,25	118	232,25
8103446	364,5	232,25	118	14,25
8103465	364,5	64,25	118	182,25

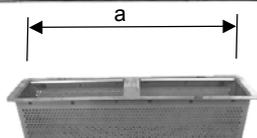

Ident-Nr.	a
8103193	431,5
8103463	249,5

18.2 TANKABDECKSIEBSYSTEM



18.2 TANK COVERING SIEVE SYSTEM

18.2 SYSTEME DE TAMIS DE RECOUVREMENT

IDENT.-NR. IDENT.-NO.	BEZEICHNUNG	DESIGNATION	DESIGNATION
8103188	TANKABDECKSIEB	TANK COVERING SIEVE	TAMIS DE RECOVREMENT
8103464	SIEBAUFLAGE SEITLICH	SIEVE SUPPORT	SUPPORT DE TAMIS
8103190	SIEBAUFLAGE SEITLICH	SIEVE SUPPORT	SUPPORT DE TAMIS
8103491	SIEBAUFLAGE RECHTS	SIEVE SUPPORT RIGHT	SUPPORT DE TAMIS DROITE
8103450	SIEBAUFLAGE	SIEVE SUPPORT	SUPPORT DE TAMIS
8103459	TANKABDECKSIEB	TANK COVERING SIEVE	TAMIS DE RECOVREMENT
8103460	TANKABDECKSIEB	TANK COVERING SIEVE	TAMIS DE RECOVREMENT
8103448	TANKABDECKSIEB	TANK COVERING SIEVE	TAMIS DE RECOVREMENT
8103186	TANKABDECKSIEB	TANK COVERING SIEVE	TAMIS DE RECOVREMENT
8103420	TANKABDECKSIEB	TANK COVERING SIEVE	TAMIS DE RECOVREMENT
8103446	TANKABDECKSIEB	TANK COVERING SIEVE	TAMIS DE RECOVREMENT
8103465	TANKABDECKSIEB	TANK COVERING SIEVE	TAMIS DE RECOVREMENT
8103193	TANKABDECKSIEB	TANK COVERING SIEVE	TAMIS DE RECOVREMENT
8103463	TANKABDECKSIEB	TANK COVERING SIEVE	TAMIS DE RECOVREMENT
8103492	SIEBAUFLAGE LINKS	SIEVE SUPPORT LEFT	SUPPORT DE TAMIS GAUCHE

20.1 TANK EXTERNE THERMOSTATREGELUNG



20.1 EXTERNAL TANK THERMOSTAT REGULATION

20.1 REGULATION DE THERMOSTAT EXTERNE DE BAC

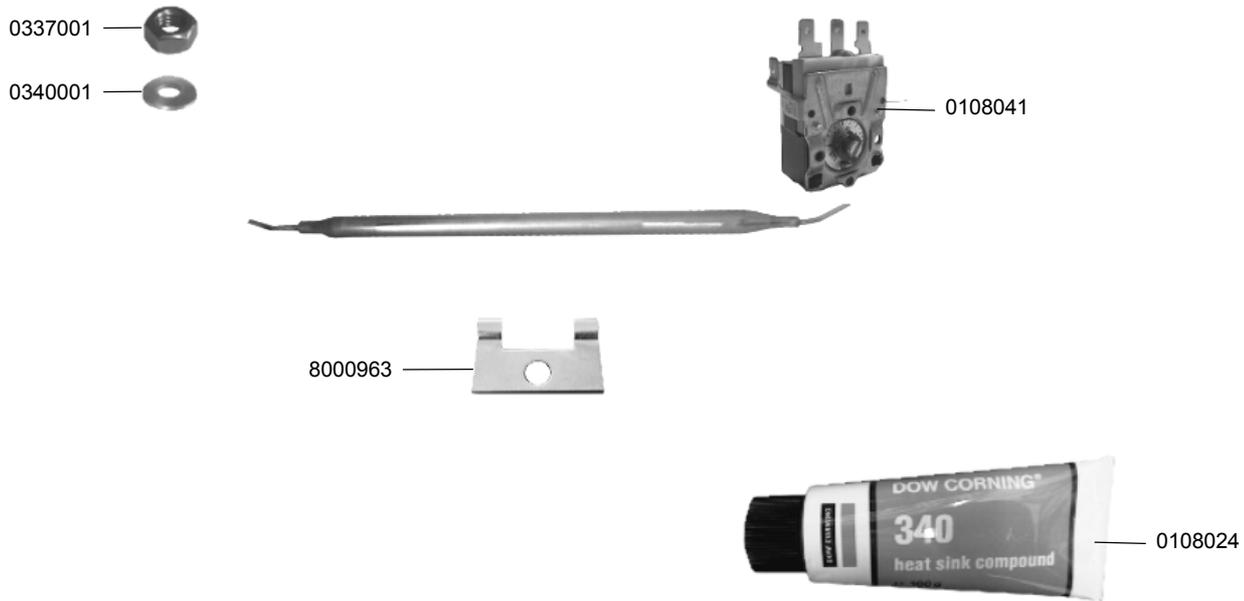

IDENT.-NR. IDENT.-NO.	BEZEICHNUNG	DESIGNATION	DESIGNATION
* 0108041	TEMPERATURFÜHLER	TEMPERATURE PROBE	SONDE DE TEMPERATURE
0108024	LEITFÄHIGKEITSPASTE	CONDUCTIVE PASTE	PATE DE CONDUCTION
8000963	HALTER	FIXATION	FIXATION
0340001	SCHEIBE	DISK	DISQUE
0337001	SKT. MUTTER M5	HEXAGON NUT M5	ECROU A 6 PANS M5

20.2 MAGNETVENTIL

20.2 SOLENOID VALVE

20.2 ELECTROVANNE

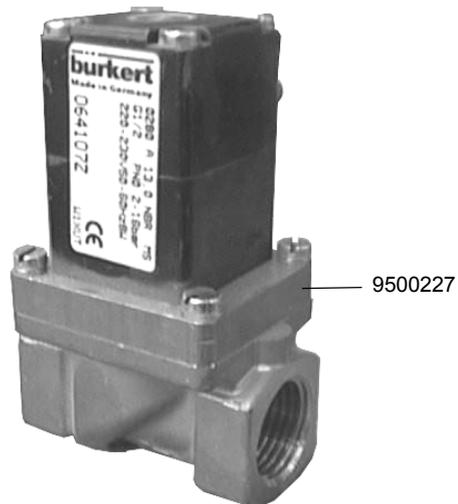

IDENT.-NR. IDENT.-NO.	BEZEICHNUNG	DESIGNATION	DESIGNATION
9500227	MAGNETVENTIL G 1/2"	SOLENOID VALVE G 1/2"	ELECTROVANNE G 1/2"

20.3 MAGNETVENTIL



20.3 SOLENOID VALVE

20.3 ELECTROVANNE



IDENT.-NR. IDENT.-NO.	BEZEICHNUNG	DESIGNATION	DESIGNATION
9500221	MAGNETVENTIL G 3/4" L=80 MM	SOLENOID VALVE G 3/4" L=80 MM	ELECTROVANNE G 3/4" L=80 MM

20.4 MAGNETVENTIL

20.4 SOLENOID VALVE

20.4 ELECTROVANNE



IDENT.-NR. IDENT.-NO.	BEZEICHNUNG	DESIGNATION	DESIGNATION
0113312	MAGNETVENTIL G 1/2"	SOLENOID VALVE G 1/2"	ELECTROVANNE G 1/2"

20.5 MAGNETVENTIL



20.5 SOLENOID VALVE

20.5 ELECTROVANNE

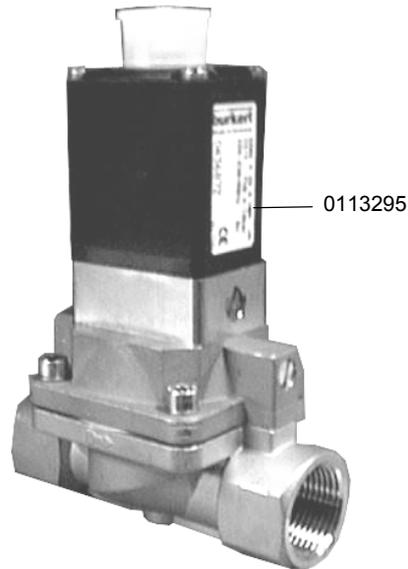

IDENT.-NR. IDENT.-NO.	BEZEICHNUNG	DESIGNATION	DESIGNATION
0113295	MAGNETVENTIL G 3/4"	SOLENOID VALVE G 3/4"	ELECTROVANNE G 3/4"

20.6 MAGNETVENTIL

20.6 SOLENOID VALVE

20.6 ELECTROVANNE

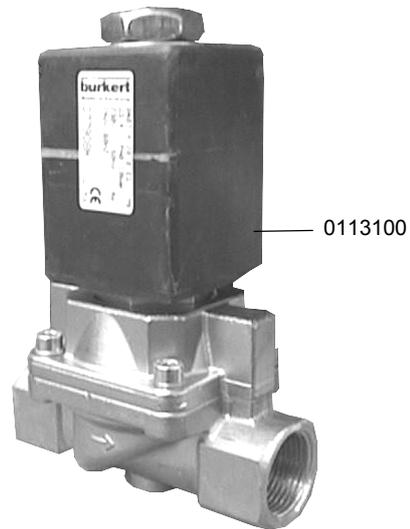

IDENT.-NR. IDENT.-NO.	BEZEICHNUNG	DESIGNATION	DESIGNATION
0113100	MAGNETVENTIL G 3/4"	SOLENOID VALVE G 3/4"	ELECTROVANNE G 3/4"

20.7 MAGNETVENTIL



20.7 SOLENOID VALVE

20.7 ELECTROVANNE

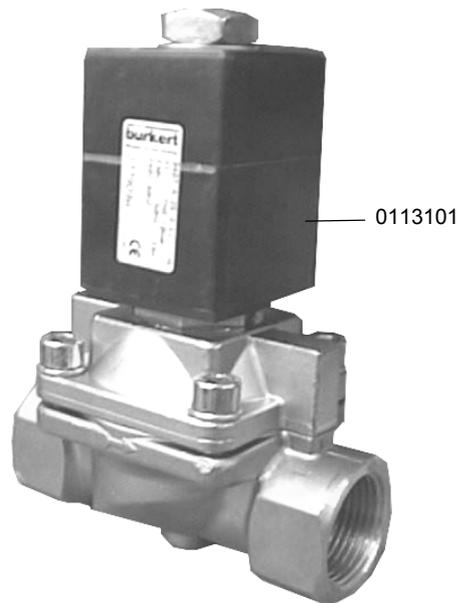

IDENT.-NR. IDENT.-NO.	BEZEICHNUNG	DESIGNATION	DESIGNATION
0113101	MAGNETVENTIL G 1"	SOLENOID VALVE G 1"	ELECTROVANNE G 1"

20.8 VORSTEUERVENTIL

20.8 PILOT VALVE

20.8 VANNE DE PILOTE

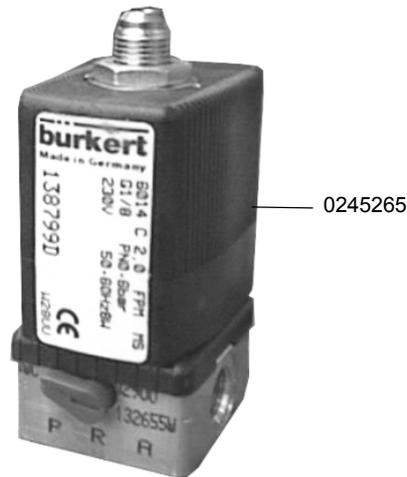

IDENT.-NR. IDENT.-NO.	BEZEICHNUNG	DESIGNATION	DESIGNATION
0245265	VORSTEUERVENTIL	PILOT VALVE	VANNE DE PILOT

20.9 KONDENSATABLEITER



20.9 STEAM TRAP

20.9 SEPARATEUR DE VAPEUR



IDENT.-NR. IDENT.-NO.	BEZEICHNUNG	DESIGNATION	DESIGNATION
9512081	KONDENSATABLEITER	STEAM TRAP	SEPARATEUR DE VAPEUR

20.10 KONDENSATABLEITER



20.10 STEAM TRAP

20.10 SEPARATEUR DE VAPEUR



IDENT.-NR. IDENT.-NO.	BEZEICHNUNG	DESIGNATION	DESIGNATION
9520449	KONDENSATABLEITER	STEAM TRAP	SEPARATEUR DE VAPEUR

21.1 TANKHEIZUNG, ELEKTRISCH



21.1 TANK HEATING ELEMENT, ELECTRICAL

21.1 RESISTANCE DU BAC, ELECTRIQUE

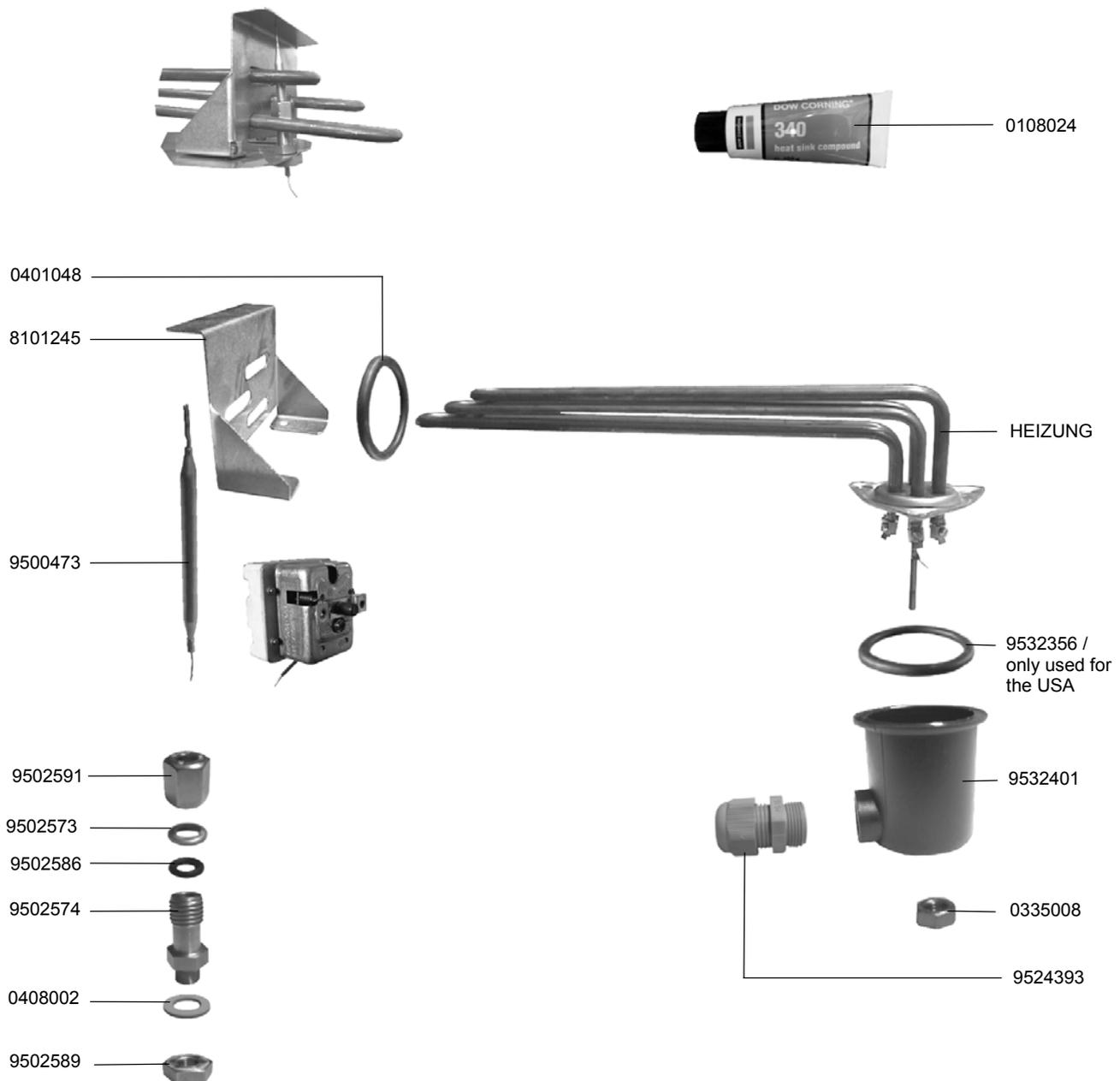

21.1 TANKHEIZUNG, ELEKTRISCH



21.1 TANK HEATING ELEMENT, ELECTRICAL

21.1 RESISTANCE DU BAC, ELECTRIQUE

IDENT.-NR. IDENT.-NO.	BEZEICHNUNG	DESIGNATION	DESIGNATION
0108024	LEITFÄHIGKEITSPASTE	CONDUCTIVE PASTE	PATE DE CONDUCTION
HEIZUNG	SIEHE ELEKTROSCHALTPLAN	SEE ELECTRIC WIRING DIAGRAM	VOIR SCHEMA ELECTRIQUE
9532356	O-RING	O-RING	BAGUE
9532401	HEIZSTABABDECKUNG	HEATING ELEMENT COVERED	ELEMENT DE CHAUFFAGE RECOUVERT
0335008	SKT.MUTTER M5	HEXAGON NUT M5	ECROU A 6 PANS M5
9524393	VERSCHRAUBUNG	SCREWING	VISSAGE
9502589	SKT.MUTTER 1/8"	HEXAGON NUT 1/8"	ECROU A 6 PANS 1/8"
0408002	DICHTUNG	PACKING	JOINT
9502574	VERSCHRAUBUNG	SCREWING	VISSAGE
* 9502586	O-RING	O-RING	BAGUE
9502573	SCHEIBE	DISK	DISQUE
9502591	ÜBERWURFMUTTER M12	SLEEVE NUT M12	ECROU RACCORD M12
* 9500473	TEMPERATURFÜHLER	TEMPERATURE PROBE	SONDE DE TEMPERATURE
8101245	BEFESTIGUNG	FIXATION	FIXATION
* 0401048	O-RING	O-RING	BAGUE

21.2.1 TANKHEIZUNG DAMPF, PHW GESCHRAUBT



21.2.1 TANK HEATING STEAM, PUMP HOT WATER SCREWED

21.2.1 RESISTANCE DU BAC VAPEUR, EAU CHAUDE A POMPE VISEE

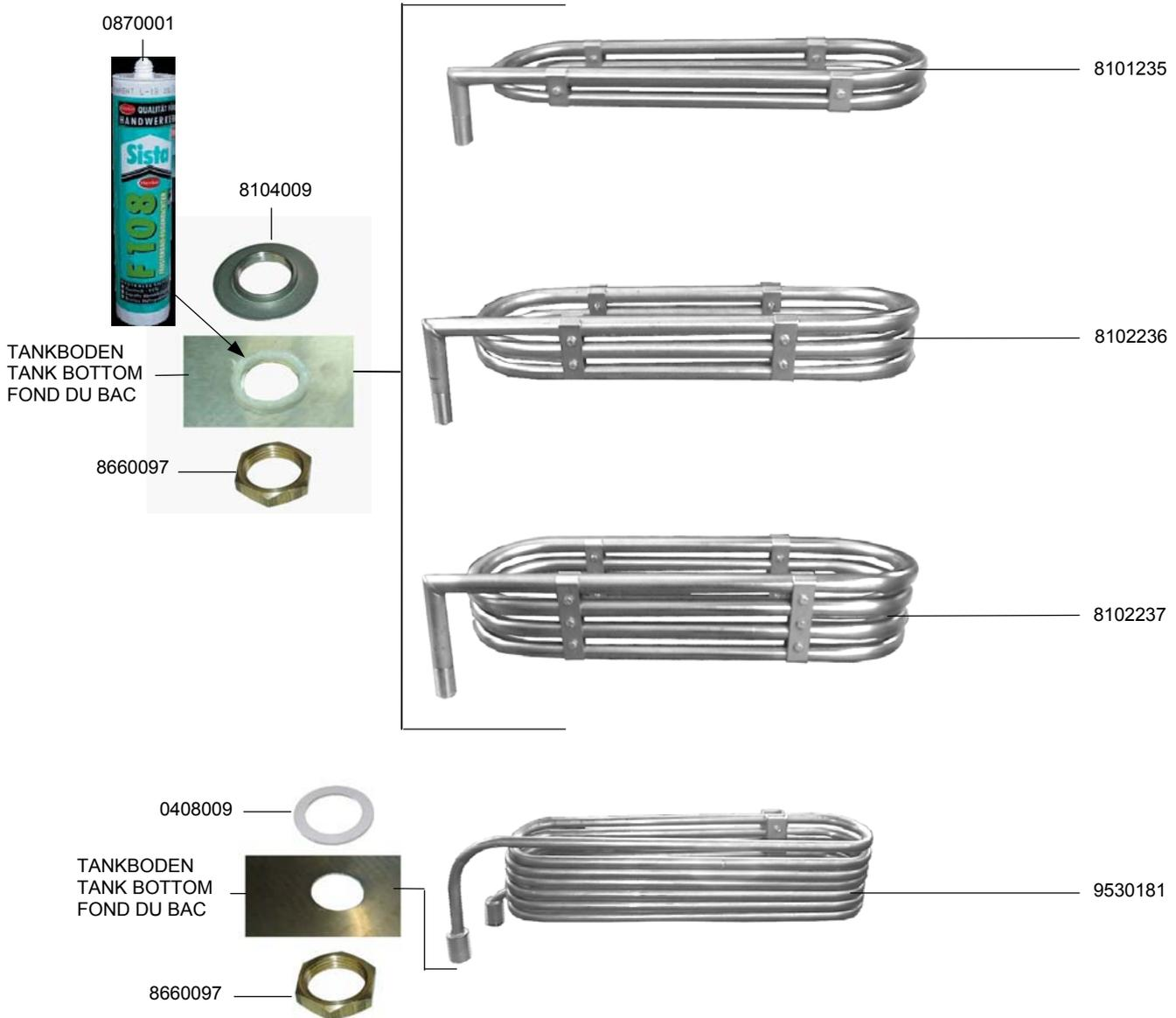

IDENT.-NR. IDENT.-NO.	BEZEICHNUNG	DESIGNATION	DESIGNATION
8101235	HEIZSCHLANGE 2 WD.	HEAT COIL WITH 2 BENDS	SERP. DE CHAUFFAGE 2 TOURS
8102236	HEIZSCHLANGE 3 WD.	HEAT COIL WITH 3 BENDS	SERP. DE CHAUFFAGE 3 TOURS
8102237	HEIZSCHLANGE 4 WD.	HEAT COIL WITH 4 BENDS	SERP. DE CHAUFFAGE 4 TOURS
9530181	HEIZSCHLANGE 7 WD.	HEAT COIL WITH 7 BENDS	SERP. DE CHAUFFAGE 7 TOURS
8104009	MUTTER, BLECH G 3/4"	THIN NUT FOR BORE-HOLE G 3/4"	PERCAGE ENTRE LES BACS G 3/4"
8660097	SECHSKANTMUTTER R 3/4"	HEXAGON NUT R 3/4"	ECROU A SIX PANS R 3/4"
0408009	FLACHDICHTUNG	FLAT SEAL	GARNITURE PLATE
0870001	SISTA F 108	SISTA F 108	SISTA F 108

21.3 TANKHEIZUNG DAMPF, PHW GEFLANSCHT



21.3 TANK HEATING STEAM, PUMP HOT WATER FLANGED

21.3 RESISTANCE DU BAC VAPEUR, EAU CHAUDE A POMPE BRIDEE

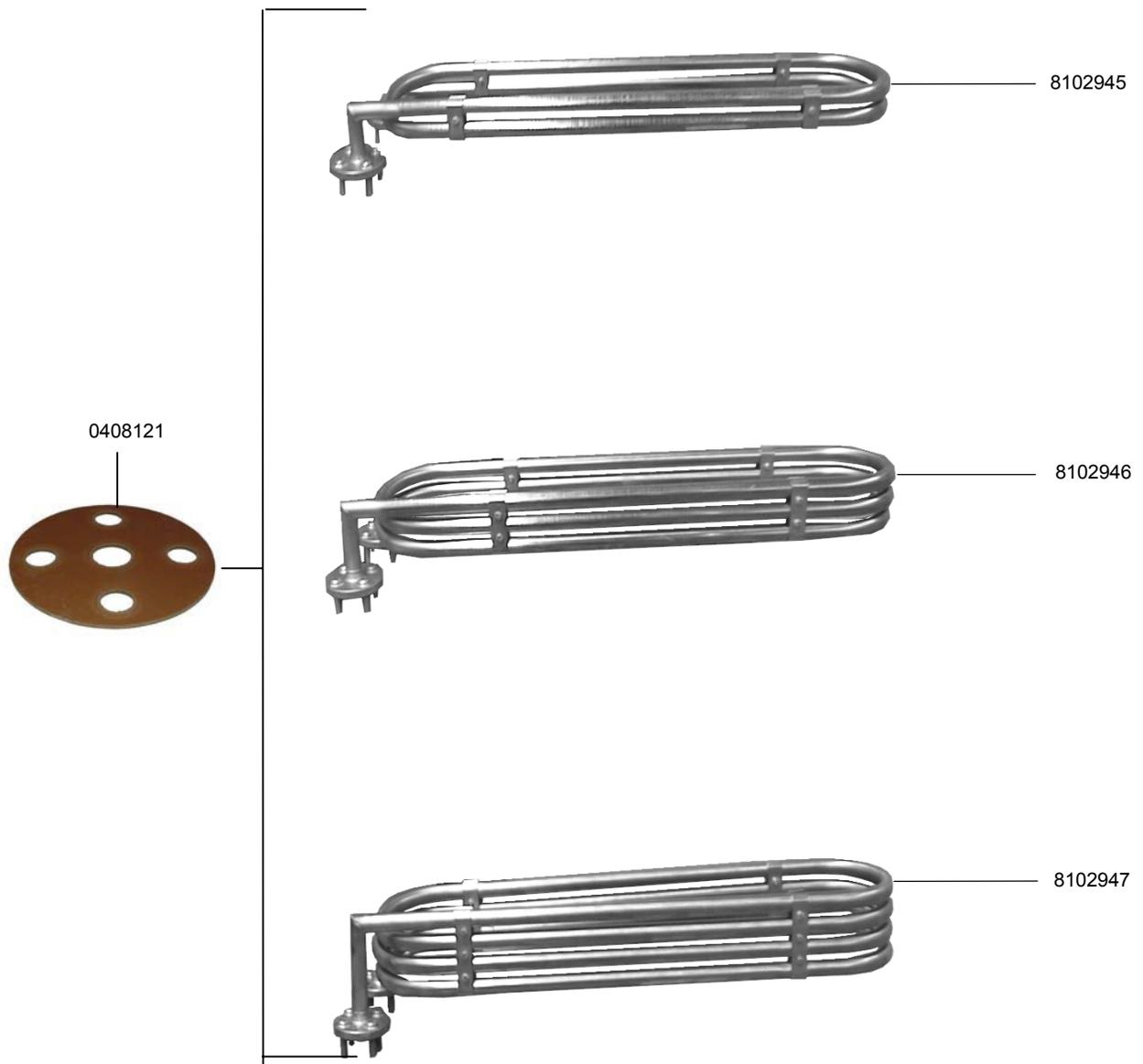

IDENT.-NR. IDENT.-NO.	BEZEICHNUNG	DESIGNATION	DESIGNATION
8102945	HEIZSCHLANGE 2 WD.	HEAT COIL WITH 2 BENDS	SERP. DE CHAUFFAGE 2 TOURS
8102946	HEIZSCHLANGE 3 WD.	HEAT COIL WITH 3 BENDS	SERP. DE CHAUFFAGE 3 TOURS
8102947	HEIZSCHLANGE 4 WD.	HEAT COIL WITH 4 BENDS	SERP. DE CHAUFFAGE 4 TOURS
0408121	FLACHDICHTUNG	FLAT SEAL	GARNITURE PLATE

22.1 DURCHLAUFWASSERERWÄRMER ELT., ELEKTRONIKREG.



22.1 BOILER ELT., ELECTRONICALLY CONTROLLED

22.1 SURCHAFFEUR ELT., A CONTROLE ELECTRONIQUE



0108024



0180422

8100317

0233037

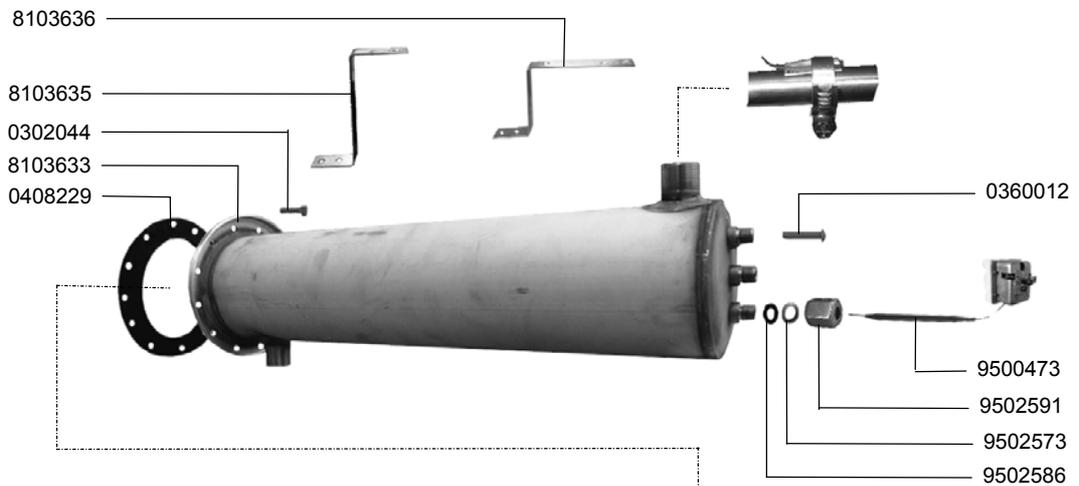

8103636

8103635

0302044

8103633

0408229

0360012

9500473

9502591

9502573

9502586

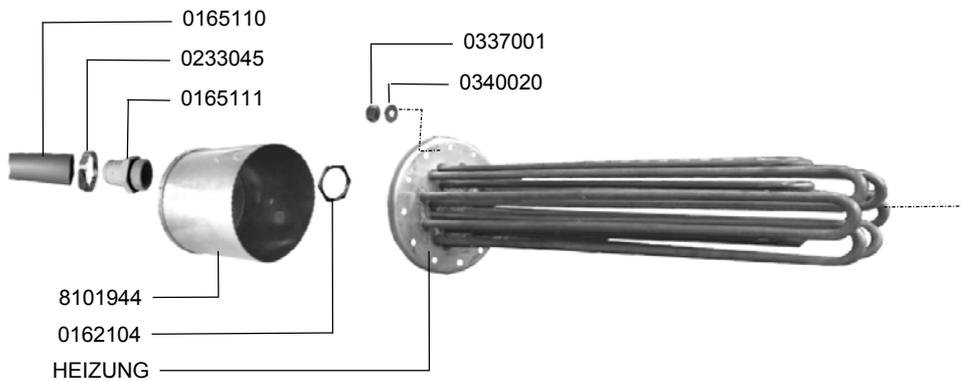

0165110

0233045

0165111

0337001

0340020

8101944

0162104

HEIZUNG

22.1 DURCHLAUFWASSERERWÄRMER ELT., ELEKTRONIKREG.



22.1 BOILER ELT., ELECTRONICALLY CONTROLLED

22.1 SURCHAFFEUR ELT., A CONTROLE ELECTRONIQUE

IDENT.-NR. IDENT.-NO.	BEZEICHNUNG	DESIGNATION	DESIGNATION
0180422	KABELBAUM	CABLE HARNESS	HARNAIS DE CABLES
8100317	BEFESTIGUNGSBLECH	FIXATION	FIXATION
0233037	SCHLAUCHKLEMME 16-27	HOSE WIRE CLAMP 16-27	COLLIER DE SERRAGE 16-27
0360012	HALBRUNDNIET	ROUND HEAD RIVET	RIVET A TETE RONDE
* 9500473	TEMPERATURBEGRENZER	TEMPERATURE LIMITER	LIMITEUR DE TEMPERATURE
9502591	ÜBERWURFMUTTER	SLEEVE NUT	ECROU RACCORD
9502573	SCHEIBE	DISK	DISQUE
* 9502586	O-RING	O-RING	BAGUE
HEIZUNG	SIEHE ELEKTROSCHALTPLAN	SEE ELECTRIC WIRING DIAGRAM	VOIR SCHEMA ELECTRIQUE
0162104	GENENMUTTER	COUNTERNUT	CONTRE-ECROU
8101944	SCHUTZABDECKUNG	PROTECTION COVER	RECOUVREMENT DE PROTECTION
0165111	VERSCHRAUBUNG	SCREWING	VISSAGE
0233045	SCHLAUCHKLEMME 20-32	HOSE WIRE CLAMP 20-32	COLLIER DE SERRAGE 20-32
0165110	SCHLAUCH	HOSE	TUYAU
0340020	SCHEIBE	DISK	DISQUE
0337001	SKT.MUTTER M5	HEXAGON NUT M5	ECROU A 6 PANS M5
* 0408229	DICHTUNG	PACKING	JOINT
8103633	BOILER	BOILER	SURCHAUFFEUR
0302044	SCHRAUBE M6X110	SCREW M6X110	VIS M6X110
8103635	BEFESTIGUNGSWINKEL	FIXATION ANGLE	ANGLE DE FIXATION
8103636	BEFESTIGUNGSWINKEL	FIXATION ANGLE	ANGLE DE FIXATION
0108024	LEITFÄHIGKEITSPASTE	CONDUCTIVE PASTE	PATE DE CONDUCTION

22.2 DURCHLAUFWASSERERWÄRMER ELT., EXTERNE THERMOSTATREGELUNG



22.2 BOILER ELT., EXTERNAL THERMOSTAT REGULATION

22.2 SURCHAUFFEUR ELT., AVEC REGULATION THERMOSTAT EXTERNE

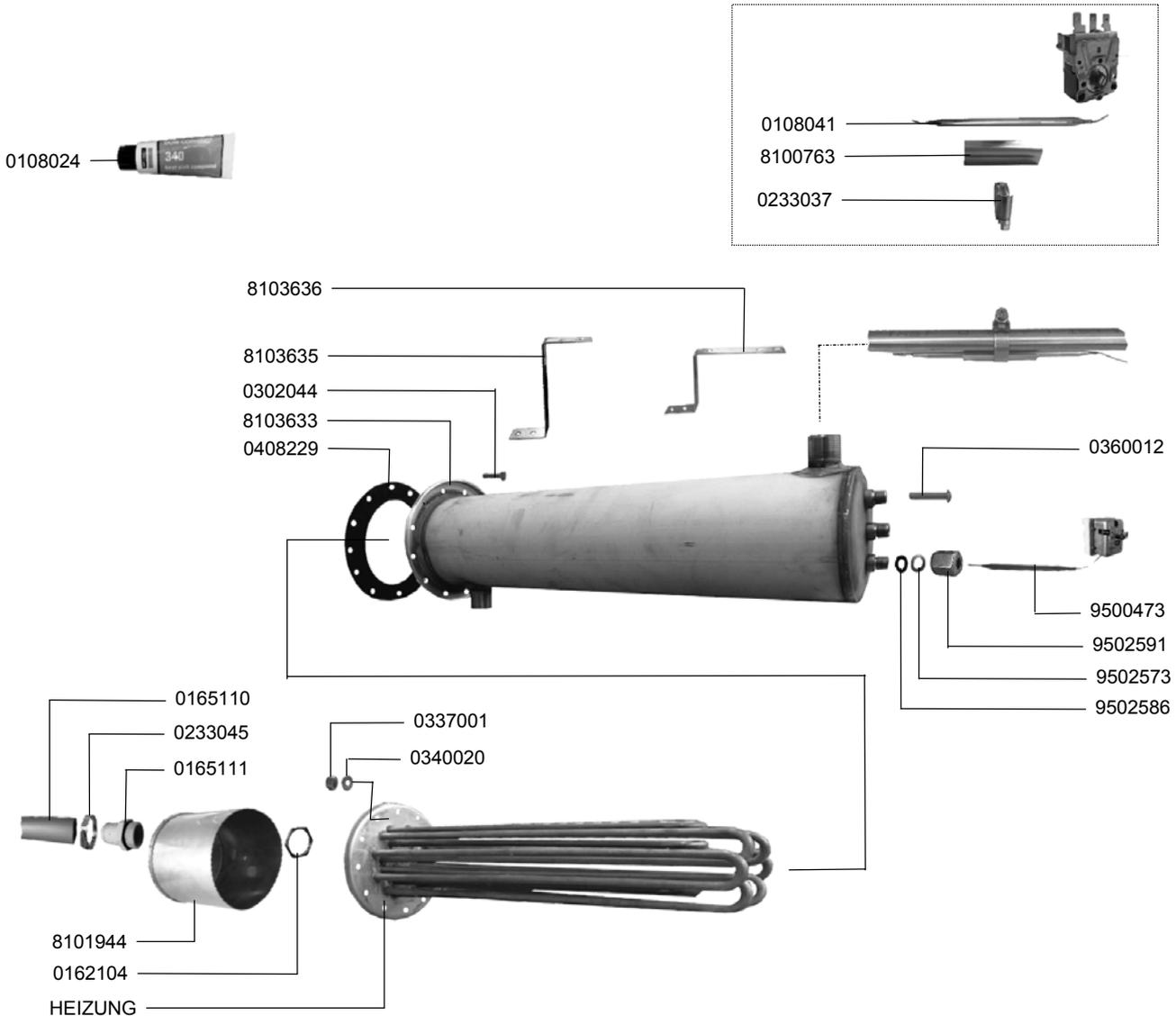

22.2 DURCHLAUFWASSERERWÄRMER ELT., EXTERNE THERMOSTATREGELUNG



22.2 BOILER ELT., EXTERNAL THERMOSTAT REGULATION

22.2 SURCHAUFFEUR ELT., AVEC REGULATION THERMOSTAT EXTERNE

IDENT.-NR. IDENT.-NO.	BEZEICHNUNG	DESIGNATION	DESIGNATION
* 0108041	THERMOSTAT	THERMOSTAT	THERMOSTAT
8100763	BEFESTIGUNGSBLECH	FIXATION	FIXATION
0233037	SCHLAUCHKLEMME 16-27	HOSE WIRE CLAMP 16-27	COLLIER DE SERRAGE 16-27
0360012	HALBRUNDNIET	ROUND HEAD RIVET	RIVET A TETE RONDE
* 9500473	TEMPERATURBEGRENZER	TEMPERATURE LIMITER	LIMITEUR DE TEMPERATURE
9502591	ÜBERWURFMUTTER	SLEEVE NUT	ECROU RACCORD
9502573	SCHEIBE	DISK	DISQUE
* 9502586	O-RING	O-RING	BAGUE
HEIZUNG	SIEHE ELEKTROSCHALTPLAN	SEE ELECTRIC WIRING DIAGRAM	VOIR SCHEMA ELECTRIQUE
0162104	GEGENMUTTER	COUNTERNUT	CONTRE-ECROU
8101944	SCHUTZABDECKUNG	PROTECTION COVER	RECOUVREMENT DE PROTECTION
0165111	VERSCHRAUBUNG	SCREWING	VISSAGE
0233045	SCHLAUCHKLEMME 20-32	HOSE WIRE CLAMP 20-32	COLLIER DE SERRAGE 20-32
0165110	SCHLAUCH	HOSE	TUYAU
0340020	SCHEIBE	DISK	DISQUE
0337001	SKT.MUTTER M5	HEXAGON NUT M5	ECROU A 6 PANS M5
* 0408229	DICHTUNG	PACKING	JOINT
8103633	BOILER	BOILER	SURCHAUFFEUR
0302044	SCHRAUBE M6X110	SCREW M6X110	VIS M6X110
8103635	BEFESTIGUNGSWINKEL	FIXATION ANGLE	ANGLE DE FIXATION
8103636	BEFESTIGUNGSWINKEL	FIXATION ANGLE	ANGLE DE FIXATION
0108024	LEITFÄHIGKEITSPASTE	CONDUCTIVE PASTE	PATE DE CONDUCTION

22.3 DURCHLAUFWASSERERWÄRMER DAMPF, PHW



22.3 BOILER STEAM, PUMP HOT WATER

22.3 SURCHAUFFEUR VAPEUR, EAU CHAUDE A POMPE

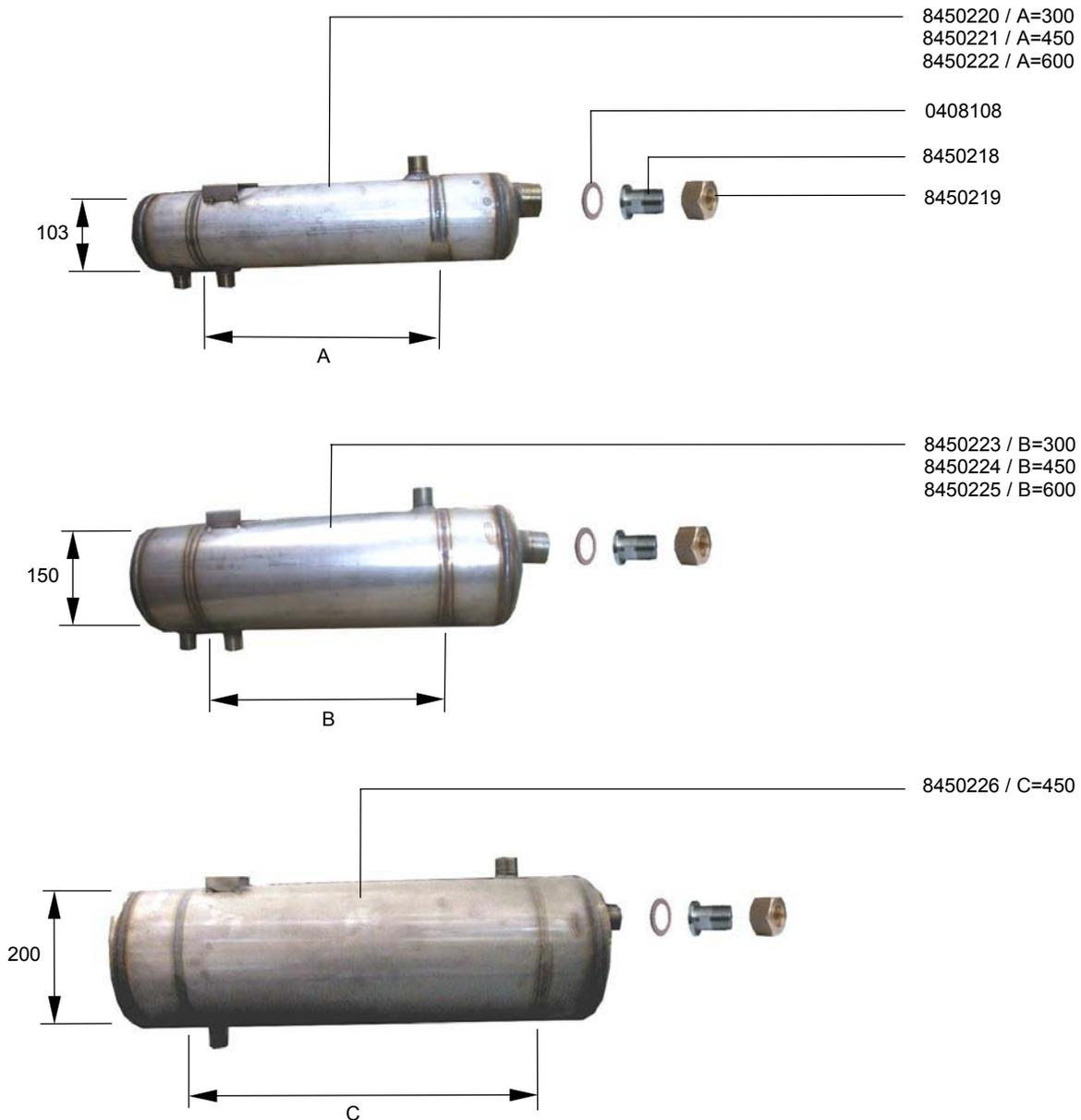

22.3 DURCHLAUFWASSERERWÄRMER DAMPF, PHW



22.3 BOILER STEAM, PUMP HOT WATER

22.3 SURCHAUFFEUR VAPEUR, EAU CHAUDE A POMPE

IDENT.-NR. IDENT.-NO.	BEZEICHNUNG	DESIGNATION	DESIGNATION
8450220	WÄRMETAUSCHER WT7X2/300/108/0,4	HEAT EXCHANGER WT7X2/300/108/0,4	ECHANGEUR DE CHALEUR WT7X2/300/108/0,4
8450221	WÄRMETAUSCHER WT7X2/450/108/0,6	HEAT EXCHANGER WT7X2/450/108/0,6	ECHANGEUR DE CHALEUR WT7X2/450/108/0,6
8450222	WÄRMETAUSCHER WT7X2/600/108/0,8	HEAT EXCHANGER WT7X2/600/108/0,8	ECHANGEUR DE CHALEUR WT7X2/600/108/0,8
* 0408108	DICHTUNG	PACKING	JOINT
8450218	REDUZIERNIPPEL	REDUCTION NIPPLE	NIPPLE DE REDUCTION
8450219	ÜBERWURFMUTTER	SLEEVE NUT	ECROU RACCORD
8450223	WÄRMETAUSCHER WT7X2/300/150/0,9	HEAT EXCHANGER WT7X2/300/150/0,9	ECHANGEUR DE CHALEUR WT7X2/300/150/0,9
8450224	WÄRMETAUSCHER WT7X2/450/150/1,4	HEAT EXCHANGER WT7X2/450/150/1,4	ECHANGEUR DE CHALEUR WT7X2/450/150/1,4
8450225	WÄRMETAUSCHER WT7X2/600/150/1,9	HEAT EXCHANGER WT7X2/600/150/1,9	ECHANGEUR DE CHALEUR WT7X2/600/150/1,9
8450226	WÄRMETAUSCHER WT7X2/450/200/1,4	HEAT EXCHANGER WT7X2/450/200/1,4	ECHANGEUR DE CHALEUR WT7X2/450/200/1,4

22.4.1. BOILER ELT., ELEKTRONIKREGELUNG



22.4.1. BOILER ELT., ELECTRONICALLY CONTROLLED

22.4.1. SURCHAFFEUR ELT., A CONTROLE ELECTRONIQUE

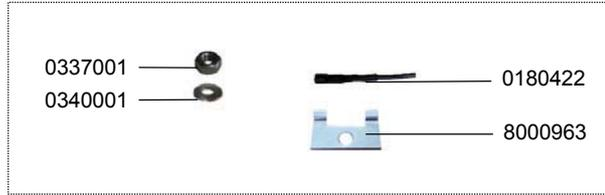

Detail X

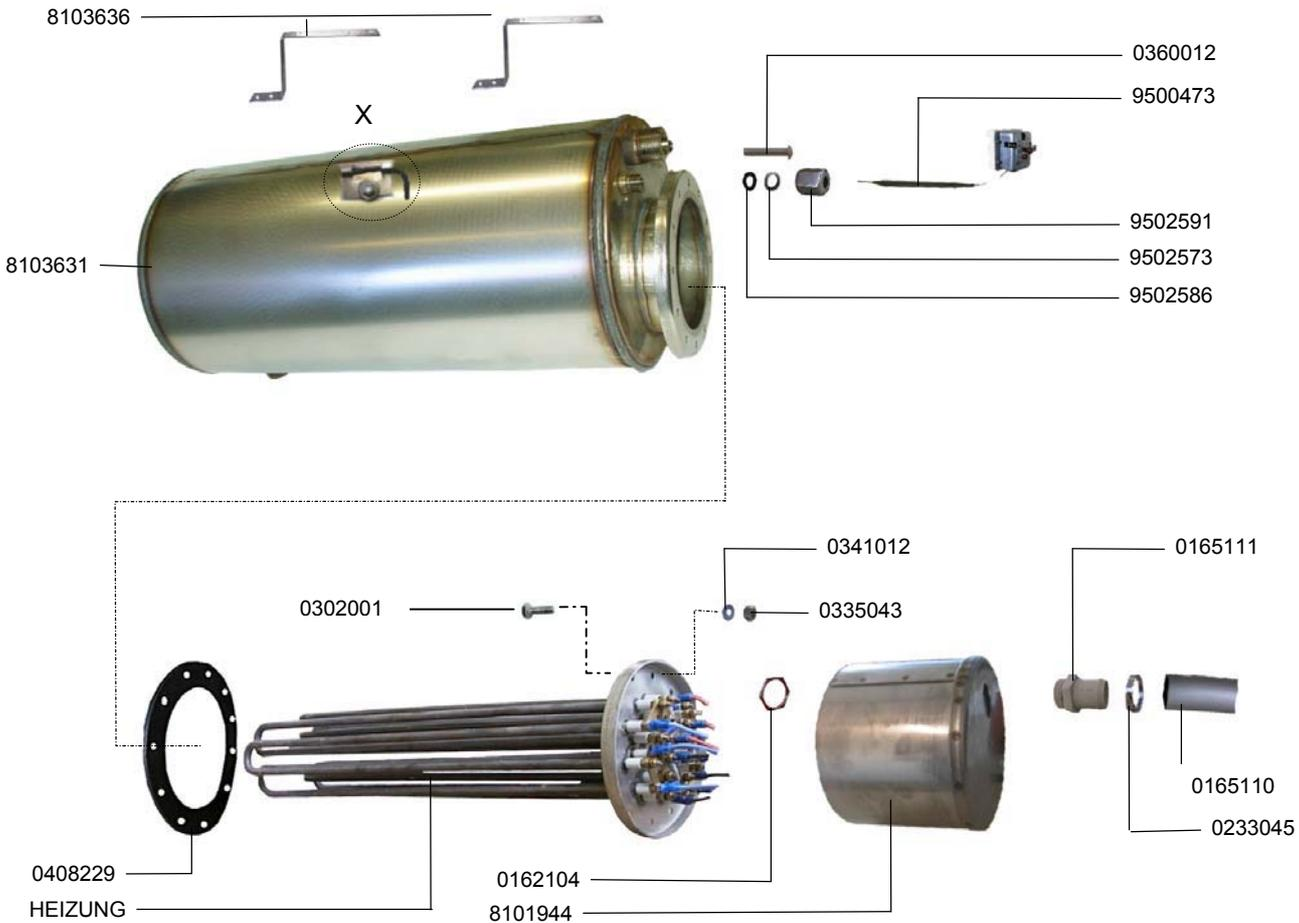

22.4.1. BOILER ELT., ELEKTRONIKREGELUNG



22.4.1. BOILER ELT., ELECTRONICALLY CONTROLLED

22.4.1. SURCHAFFEUR ELT., A CONTROLE ELECTRONIQUE

IDENT.-NR. IDENT.-NO.	BEZEICHNUNG	DESIGNATION	DESIGNATION
0337001	SKT.MUTTER M5	HEXAGON NUT M5	ECROU A 6 PANS M5
0340001	SCHEIBE	DISK	DISQUE
0180422	KABELBAUM	CABLE HARNESS	HARNAIS DE CABLES
8000963	HALTER	FIXATION	FIXATION
0360012	HALBRUNDNIET	ROUND HEAD RIVET	RIVET A TETE RONDE
* 9500473	TEMPERATURBEGRENZER	TEMPERATURE LIMITER	LIMITEUR DE TEMPERATURE
9502591	ÜBERWURFMUTTER	SLEEVE NUT	ECROU RACCORD
9502573	SCHEIBE	DISK	DISQUE
* 9502586	O-RING	O-RING	BAGUE
0341012	FEDERING	SPRING RING	BAGUET DE RESSORT
0335043	SKT.MUTTER M6	HEXAGON NUT M6	ECROU A 6 PANS M6
0165111	VERSCHRAUBUNG	SCREWING	VISSAGE
0165110	SCHLAUCH	HOSE	TUYAU
0233045	SCHLAUCHKLEMME 20-32	HOSE WIRE CLAMP 20-32	COLLIER DE SERRAGE 20-32
8101944	SCHUTZABDECKUNG	PROTECTION COVER	RECOUVREMENT DE PROTECTION
0162104	GEGENMUTTER	COUNTERNUT	CONTRE-ECROU
HEIZUNG	SIEHE ELEKTROSCHALTPLAN	SEE ELECTRIC WIRING DIAGRAM	VOIR SCHEMA ELECTRIQUE
* 0408229	DICHTUNG	PACKING	JOINT
0302001	SKT.SCHRAUBE M6X15	SCREW M6X15	VIS M6X15
8103631	BOILER	BOILER	SURCHAUFFEUR
8103636	BEFESTIGUNGSWINKEL	FIXATION ANGLE	ANGLE DE FIXATION
0108024	LEITFÄHIGKEITSPASTE	CONDUCTIVE PASTE	PATE DE CONDUCTION

22.5.1. BOILER ELT., EXTERNE THERMOSTATREGELUNG



22.5.1. BOILER ELT., EXTERNAL THERMOSTAT REGULATION

22.5.1. SURCHAUFFEUR ELT., AVEC REGULATION THERMOSTAT EXTERNE



0108024

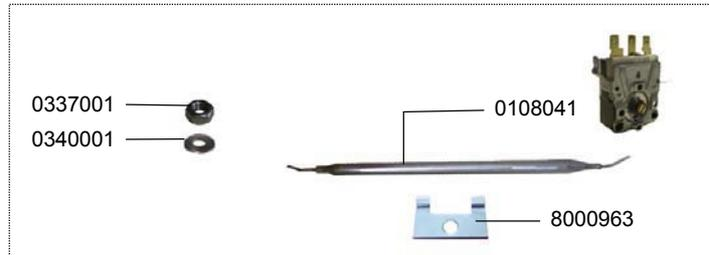

Detail X

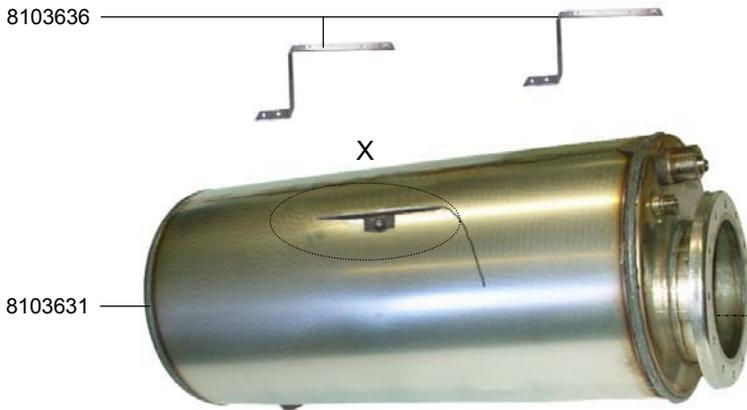

8103636

X

8103631

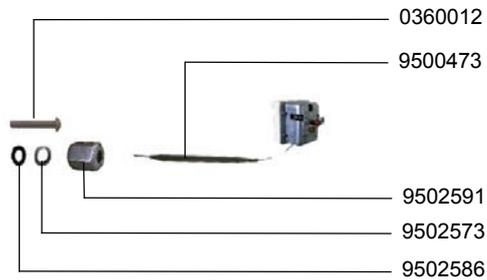

0360012

9500473

9502591

9502573

9502586

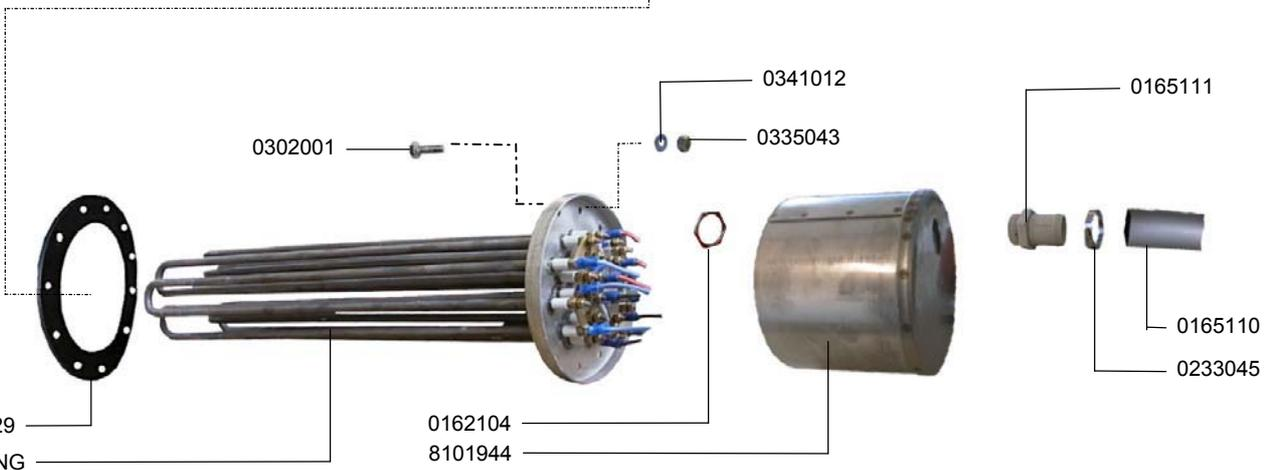

0302001

0341012

0335043

0165111

0408229

HEIZUNG

0162104

8101944

0165110

0233045

22.5.1. BOILER ELT., EXTERNE THERMOSTATREGELUNG



22.5.1. BOILER ELT., EXTERNAL THERMOSTAT REGULATION

22.5.1. SURCHAUFFEUR ELT., AVEC REGULATION THERMOSTAT EXTERNE

IDENT.-NR. IDENT.-NO.	BEZEICHNUNG	DESIGNATION	DESIGNATION
0337001	SKT.MUTTER M5	HEXAGON NUT M5	ECROU A 6 PANS M5
0340001	SCHEIBE	DISK	DISQUE
* 0108041	THERMOSTAT	THERMOSTAT	THERMOSTAT
8000963	HALTER	FIXATION	FIXATION
0360012	HALBRUNDNIET	ROUND HEAD RIVET	RIVET A TETE RONDE
* 9500473	TEMPERATURBEGRENZER	TEMPERATURE LIMITER	LIMITEUR DE TEMPERATURE
9502591	ÜBERWURFMUTTER	SLEEVE NUT	ECROU RACCORD
9502573	SCHEIBE	DISK	DISQUE
* 9502586	O-RING	O-RING	BAGUE
0341012	FEDERING	SPRING RING	BAGUET DE RESSORT
0335043	SKT.MUTTER M6	HEXAGON NUT M6	ECROU A 6 PANS M6
0165111	VERSCHRAUBUNG	SCREWING	VISSAGE
0165110	SCHLAUCH	HOSE	TUYAU
0233045	SCHLAUCHKLEMME 20-32	HOSE WIRE CLAMP 20-32	COLLIER DE SERRAGE 20-32
8101944	SCHUTZABDECKUNG	PROTECTION COVER	RECOUVREMENT DE PROTECTION
0162104	GEGENMUTTER	COUNTERNUT	CONTRE-ECROU
HEIZUNG	SIEHE ELEKTROSCHALTPLAN	SEE ELECTRIC WIRING DIAGRAM	VOIR SCHEMA ELECTRIQUE
* 0408229	DICHTUNG	PACKING	JOINT
0302001	SKT.SCHRAUBE M6X15	SCREW M6X15	VIS M6X15
8103631	BOILER	BOILER	SURCHAUFFEUR
8103636	BEFESTIGUNGSWINKEL	FIXATION ANGLE	ANGLE DE FIXATION
0108024	LEITFÄHIGKEITSPASTE	CONDUCTIVE PASTE	PATE DE CONDUCTION

22.6 PLATTENWÄRMETAUSCHER, HEISSWASSER



22.6 HEAT EXCHANGER PLATE SHAPED, HOT WATER

22.6 EXCHANGEUR DE CHALEUR A PLAQUES, EAU CHAUDE

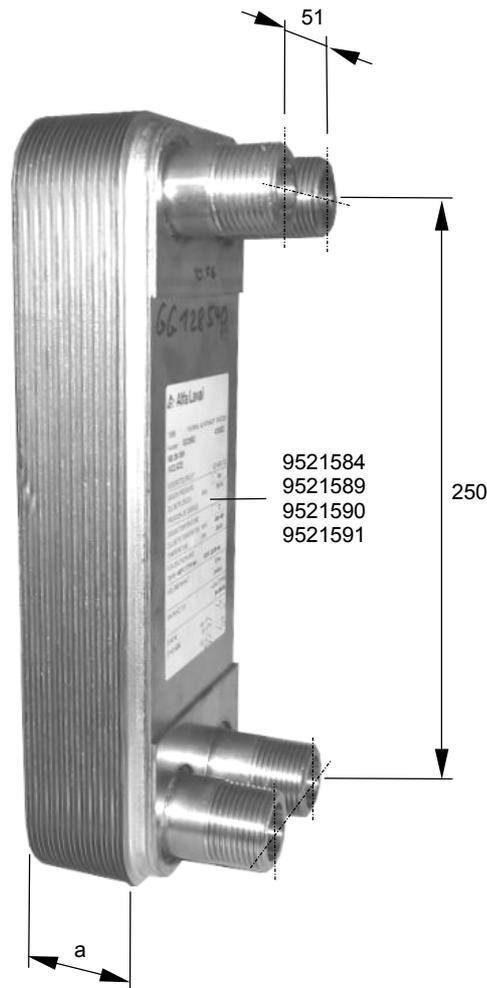

Ident-Nr.		a
9521584	Cu	52
9521589	Cu	40
9521590	Ni	52
9521591	Ni	40

IDENT.-NR. IDENT.-NO.	BEZEICHNUNG	DESIGNATION	DESIGNATION
9521584	PLATTENDURCHLAUFERHITZER KUPFERGELÖTET	PLATE-SHAPED BOILER SOLDERED WITH COPPER	SURCHAUFFEUR A PLAQUES SOUDE AU CUIVRE
9521589	PLATTENDURCHLAUFERHITZER KUPFERGELÖTET	PLATE-SHAPED BOILER SOLDERED WITH COPPER	SURCHAUFFEUR A PLAQUES SOUDE AU CUIVRE
9521590	PLATTENDURCHLAUFERHITZER NICKELGELÖTET	PLATE-SHAPED BOILER SOLDERED WITH NICKEL	SURCHAUFFEUR A PLAQUES SOUDE AU NICKEL
9521591	PLATTENDURCHLAUFERHITZER NICKELGELÖTET	PLATE-SHAPED BOILER SOLDERED WITH NICKEL	SURCHAUFFEUR A PLAQUES SOUDE AU NICKEL

23.1 RADIALGEBLÄSE



23.1 RADIAL FAN

23.1 VENTILATEUR RADIAL

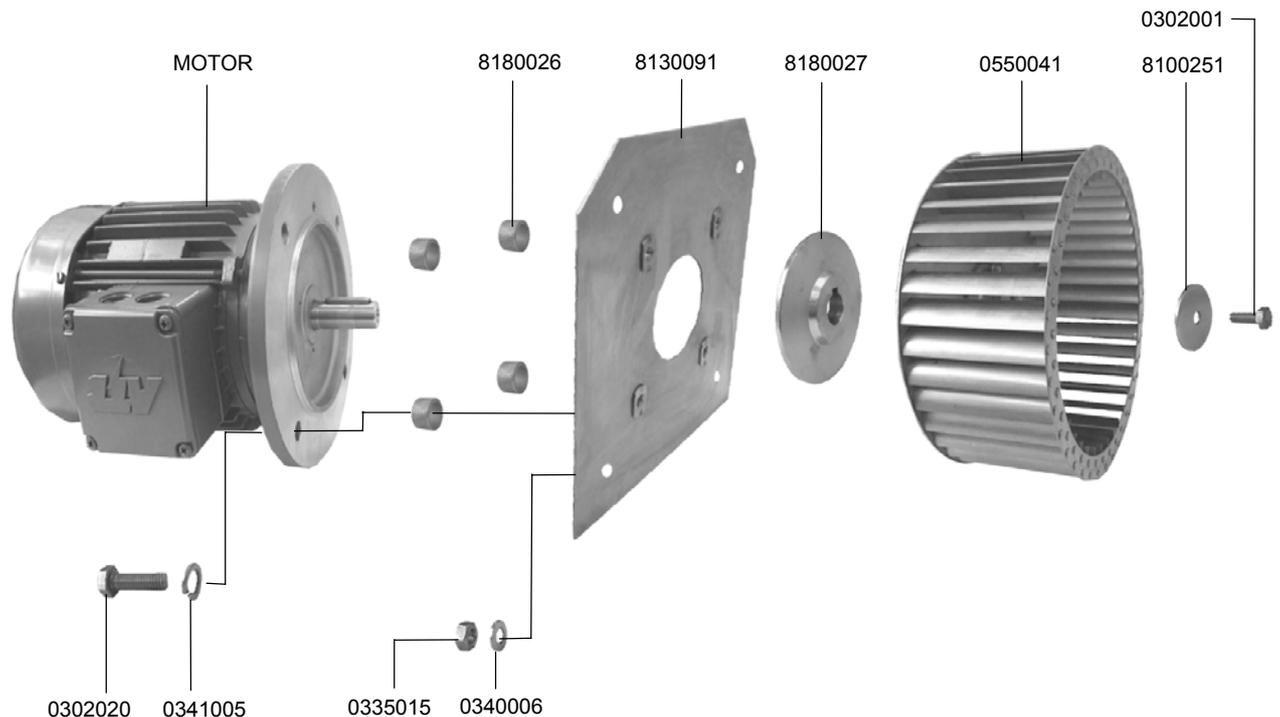

IDENT.-NR. IDENT.-NO.	BEZEICHNUNG	DESIGNATION	DESIGNATION
MOTOR	SIEHE ELEKTROSCHALTPLAN	SEE ELECTRIC WIRING DIAGRAM	VOIR SCHEMA ELECTRIQUE
8180026	DISTANZ LÜFTERMOTOR Ø17X10, 1.4301	DISTANCE PIECE F. EXTRACTION MOTOR Ø17X10, 1.4301	PIECE DE DISTANCE POUR VENTILATEUR Ø17X10, 1.4301
8130091	MOTORPLATTE FÜR MRL 280X280X2, 1.4301	MOTOR SUPPORT F. MRL-FAN 280X280X2, 1.4301	PLAQUE SUPPORT DE MOTEUR 280X280X2, 1.4301
8180027	SCHLEUDERSCHEIBE Ø90X19X11,5, CUZN	CENTRIFUGAL DISC Ø90X19X11,5, CUZN	RONDELLE CENTRIFUGE Ø90X19X11,5, CUZN
0550041	LÜFTERRAD 12504271022-E Ø225X100, 1.4301	VENTILATOR WHEEL WITH CENTER Ø225X100, 1.4301	ROUE DE VENTILATEUR AVEC MOYEU Ø225X100, 1.4301
0302001	SKT.-SCHRAUBE M6X15	HEXAGON SCREW M6X15	VIS A 6 PANS M6X15
8100251	U-SCHEIBE Ø34X7X2, 1.4301	FRONT DISC Ø34X7X2; 1.4301	RONDELLE Ø34X7X2, 1.4301
0340006	U-SCHEIBE MS. VERN. 8,4X18X2	WASHER BRASS NICKELED 8,4X18X2	RONDELLE EN LAITON NICKELE 8,4X18X2
0335015	SKT.-MUTTER M8	HEXAGON NUT M8	ECROU A 6 PANS M8
0341005	FEDERRING A10	FEATHER KEY A10	RONDELLE RESSORT A10
0302020	SKT.-SCHRAUBE M10X25	HEXAGON SCREW M10X25	VIS A 6 PANS M10X25

23.2 WASSERUMGEHUNG FÜR STÄRKELOSEPROGRAMM



23.2 WATER BY-PASS FOR STARCH REMOVING PROGRAMME

23.2 DEVIATION D'EAU POUR PROGRAMME A ENLEVER L'AMIDON

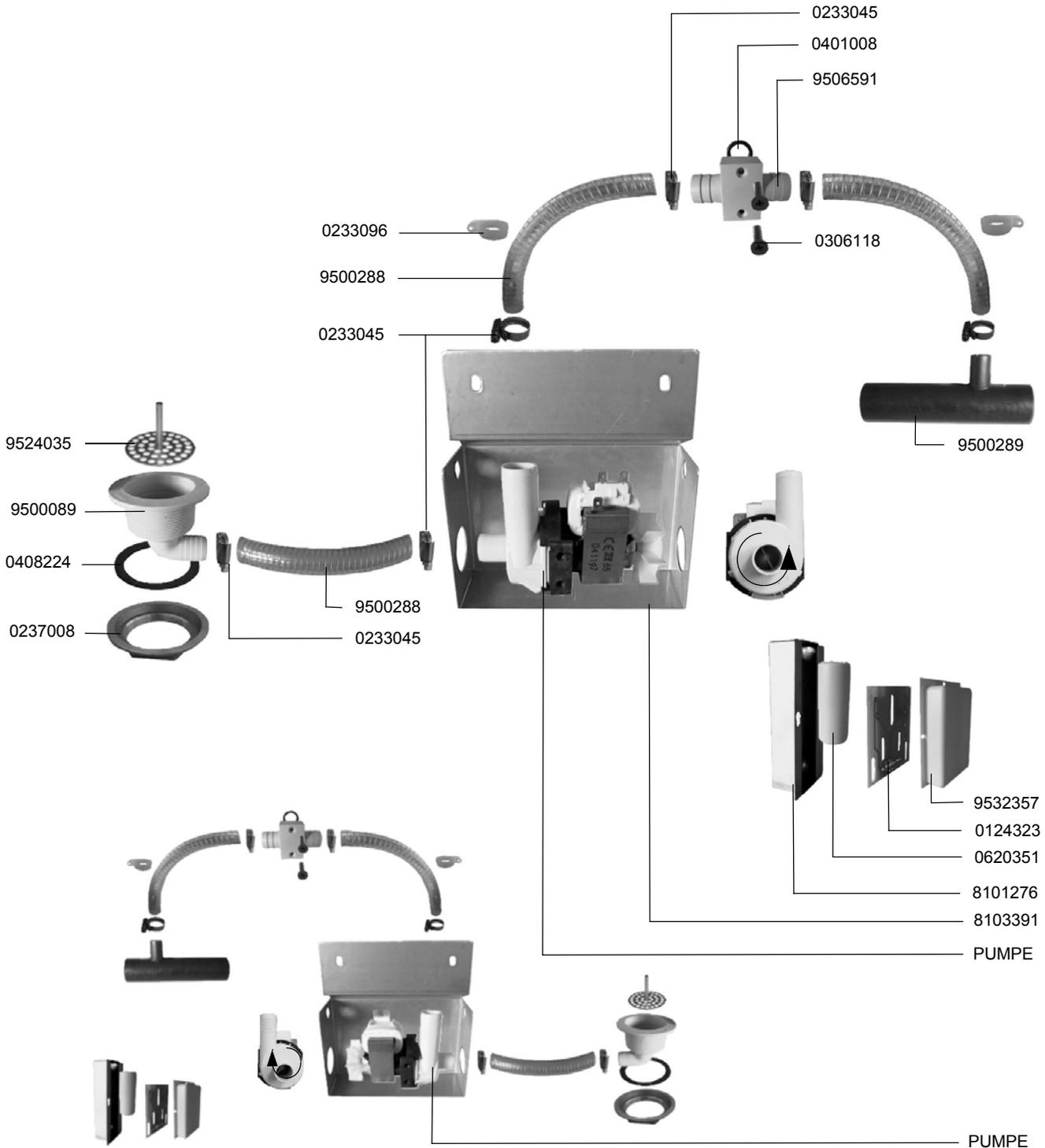

23.2 WASSERUMGEHUNG FÜR STÄRKELOSEPROGRAMM



23.2 WATER BY-PASS FOR STARCH REMOVING PROGRAMME

23.2 DEVIATION D' EAU POUR PROGRAMME A ENLEVER L'AMIDON

IDENT.-NR. IDENT.-NO.	BEZEICHNUNG	DESIGNATION	DESIGNATION
0233045	SCHLAUCHKLEMME 20-32	HOSE WIRE CLAMP 20-32	COLLIER DE SERRAGE 20-32
0401008	DICHTUNG	PACKING	JOINT
9506591	ENTLÜFTUNGSVENTIL	VENT VALVE	VALVE D' AERATION
0306118	SCHRAUBE M4X20	SCREW M4X20	VIS M4X20
9500289	ROHR	TUBE	TUYAU
0621068	ABDECKUNG	COVER	CE CONTROLE
0124323	CE STEUERUNG	CE CONTROL	FLOTTEUR K343
0620351	SCHWIMMER K343	FLOAT, PLASTIC K343	GUIDAGE POUR FLOTTEUR
8101276	SCHWIMMERFÜHRUNG 177X45X44	FLOAT GUIDE 177X45X44	SUPPORT DE POMPE
8103391	PUMPENHALTERUNG	PUMP SUPPORT	VOIR SCHEMA ELECTRIQUE
PUMPE	SIEHE ELEKTROSCHALTPLAN	SEE ELECTRIC WIRING DIAGRAM	TUYAU
9500288	SCHLAUCH	HOSE	ECROU 2"
0237008	MUTTER 2"	NUT 2"	JOINT
0408224	DICHTUNG	PACKING	VANNE DE VIDANGE
9500089	ABLAUFVENTIL	DRAIN VALVE	TAMIS POUR VIDANGE
9524035	SIEB FÜR ABLAUF	SIEVE FOR DRAIN	TAMIS PUR VIDAGNE
0233096	SCHLAUCHKLEMME	HOSE WIRE CLAMP	COLLIER DE SERRAGE

23.2.1 WASSERUMGEHUNG FÜR STÄRKELOSEPROGRAMM



23.2.1 WATER BY-PASS FOR STARCH REMOVING PROGRAMME

23.2.1 DEVIATION D'EAU POUR PROGRAMME A ENLEVER L'AMIDON

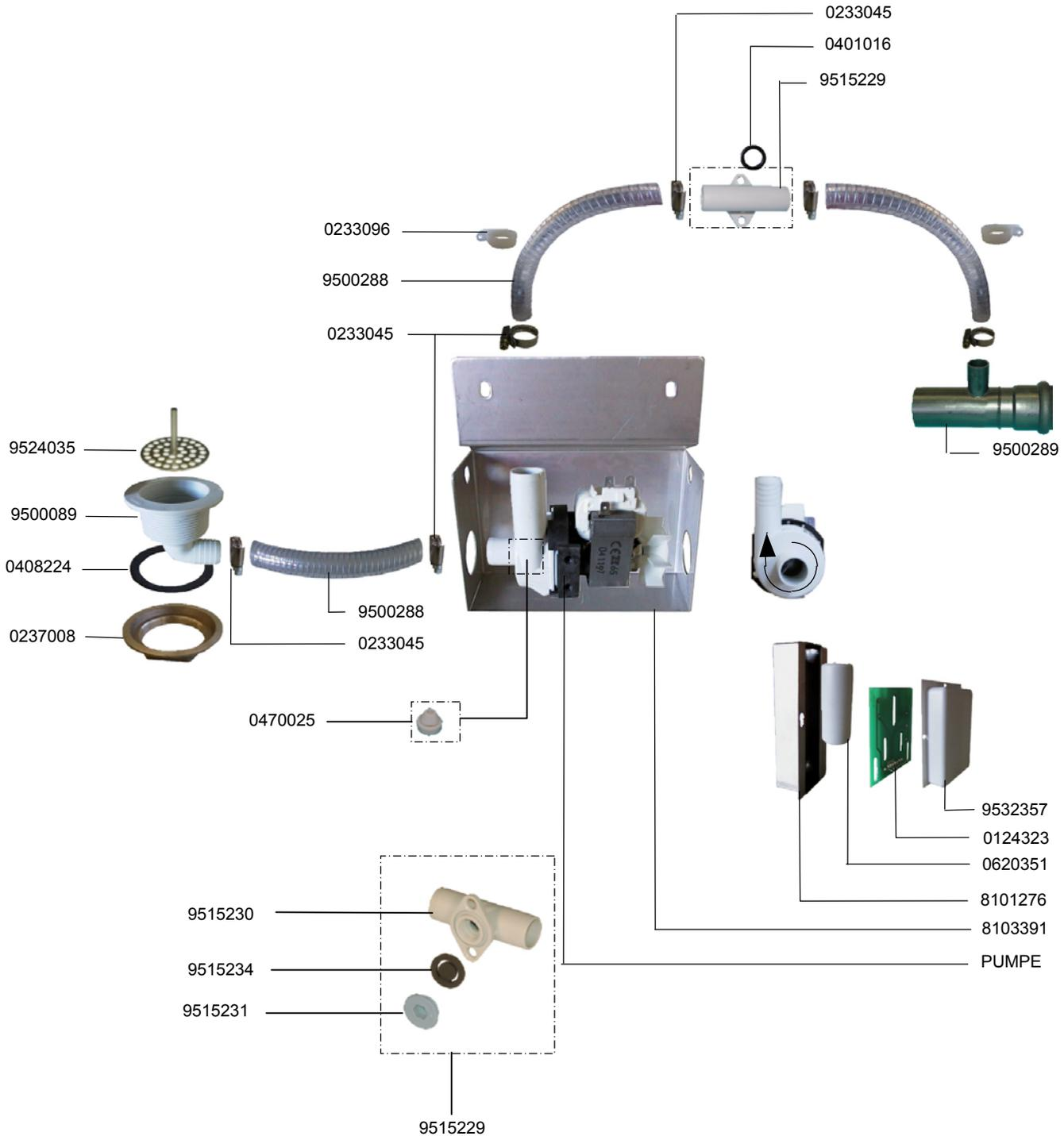

23.2.1 WASSERUMGEHUNG FÜR STÄRKE LÖSEPROGRAMM



23.2.1 WATER BY-PASS FOR STARCH REMOVING PROGRAMME

23.2.1 DEVIATION D' EAU POUR PROGRAMME A ENLEVER L'AMIDON

IDENT.-NR. IDENT.-NO.	BEZEICHNUNG	DESIGNATION	DESIGNATION
0233045	SCHLAUCHKLEMME 20-32	HOSE WIRE CLAMP 20-32	COLLIER DE SERRAGE 20-32
0401016	DICHTUNG	PACKING	JOINT
9515229	ENTLÜFTUNGSVENTIL	VENT VALVE	VALVE D' AERATION
9500289	ROHR	TUBE	TUYAU
9532357	ABDECKUNG	COVER	RECOUVREMENT
0124323	CE STEUERUNG	CE CONTROL	CE CONTROLE
* 0620351	SCHWIMMER K343	FLOAT, PLASTIC K343	FLOTTEUR K343
8101276	SCHWIMMERFÜHRUNG 177X45X44	FLOAT GUIDE 177X45X44	GUIDAGE POUR FLOTTEUR 177X45X44
8103391	PUMPENHALTERUNG	PUMP SUPPORT	SUPPORT DE POMPE
PUMPE	SIEHE ELEKTROSCHALTPLAN	SEE ELECTRIC WIRING DIAGRAM	VOIR SCHEMA ELECTRIQUE
9500288	SCHLAUCH	HOSE	TUYAU
0237008	MUTTER 2"	NUT 2"	ECROU 2"
0408224	DICHTUNG	PACKING	JOINT
9500089	ABLAUFVENTIL	DRAIN VALVE	VANNE DE VIDANGE
9524035	SIEB FÜR ABAUF	SIEVE FOR DRAIN	TAMIS POUR VIDANGE
0233096	SCHLAUCHKLEMME	HOSE WIRE CLAMP	COLLIER DE SERRAGE
9515231	VERSCHLUSSSCHRAUBE	SCREW PLUG	BOUCHON FILETE DE DECHARGE
0470025	GUMMIPUFFER	RUBBER BUFFER	TAMPON EN CAOUTCHOUC
9515234	DICHTUNG	PACKING	JOINT
9515229	ENTLÜFTUNGSVENTIL KPL	VENT VALVE CPL	VANNE D' AERATION CPL

23.3.1 MASCHINENSTOLLEN



23.3.1 FEET OF MACHINE

23.3.1 PIEDS DE MACHINE

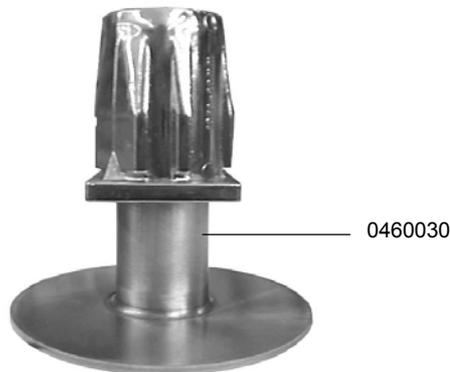
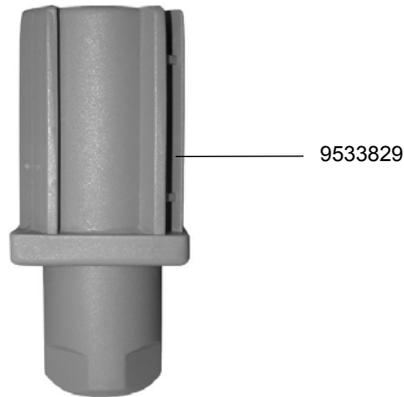

IDENT.-NR. IDENT.-NO.	BEZEICHNUNG	DESIGNATION	DESIGNATION
9533829	TISCHSTOLLEN KPL.	TABLE FEET CPL.	PIEDS DE TABLE CPL.
0460030	STELLFUSS NIRO CAMLOCK 1015-4003-1144	STANDING FEET CAMLOCK 1015-4003-1144	PIEDS NIRO CAMLOCK 1015-4003-1144

23.4 ROHRABDICHTUNG

23.4 TUBE PACKING

23.4 JOINT DE TUYAU

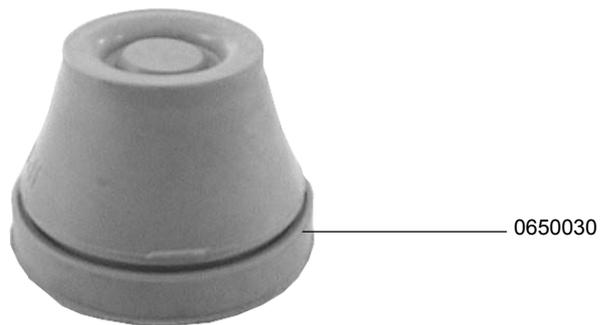

IDENT.-NR. IDENT.-NO.	BEZEICHNUNG	DESIGNATION	DESIGNATION
0650030	KABELDURCHFÜHRUNG	CABLE DUCT	TRAVERSEE DE CABLE

23.5 SCHWIMMERSCHALTER



23.5 FLOAT SWITCH

23.5 FLOTTEUR POUR NIVEAU DE BAC



IDENT.-NR. IDENT.-NO.	BEZEICHNUNG	DESIGNATION	DESIGNATION
* 0130024	SCHWIMMER	FLOAT	FLOTTEUR
8104009	MUTTER 3/4"	NUT 3/4"	ECROU 3/4"
8660097	SKT. MUTTER 3/4"	HEXAGONE SCREW 3/4"	ECROU A 6 PANS 3/4"

23.6 NIVEAUREGELUNG



23.6 LEVEL CONTROL

23.6 REGULATION DE NIVEAU

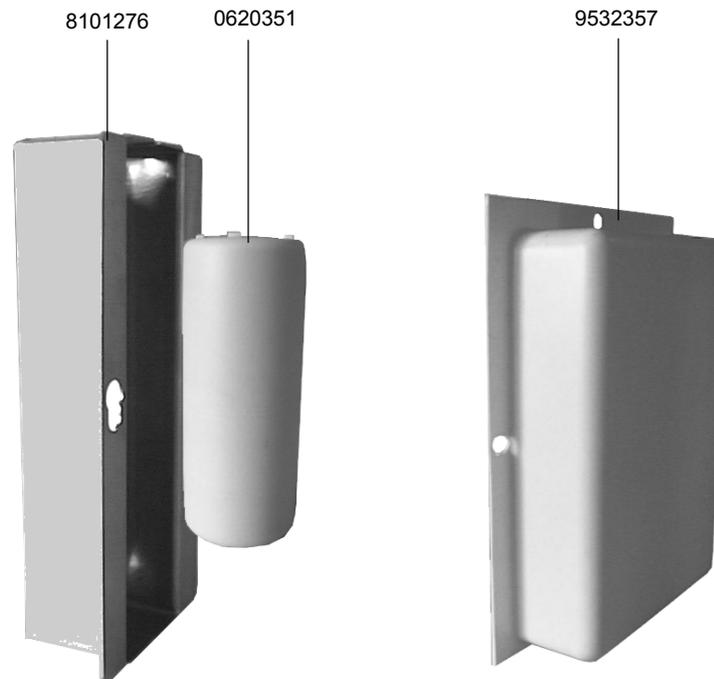

IDENT.-NR. IDENT.-NO.	BEZEICHNUNG	DESIGNATION	DESIGNATION
8101276	SCHWIMMERFÜHRUNG 177X45X44	FLOAT GUIDE 177X45X44	GUIDAGE POUR FLOTTEUR 177X45X44
* 0620351	SCHWIMMER K343	FLOAT, PLASTIC K343	FLOTTEUR K343
9532357	ABDECKUNG	COVER	RECOUVREMENT

23.7 WRASENABDICHTUNG FÜR TRANSPORTBAND



23.7 VAPEUR SEALING FOR TRANSPORT CONVEYOR

23.7 JOINT DE BUEES POUR CONVOYEUR DE TRANSPORT

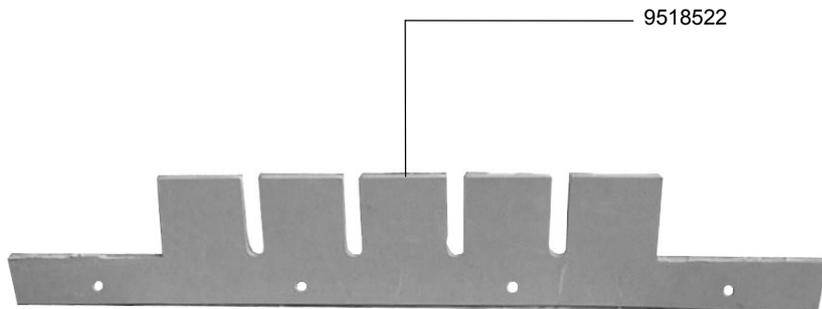
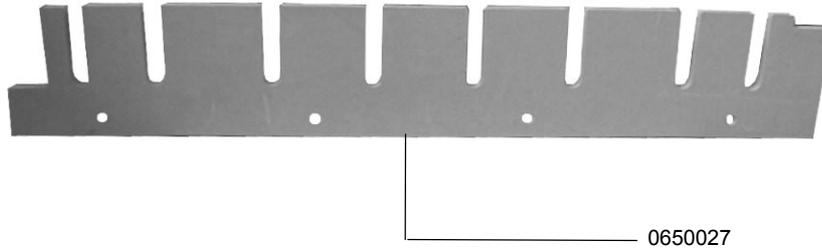

IDENT.-NR. IDENT.-NO.	BEZEICHNUNG	DESIGNATION	DESIGNATION
--------------------------	-------------	-------------	-------------

0650027	GUMMI 620X100X8	RUBBER 620X100X8	CAOUTCHOUC 620X100X8
9518522	GUMMISTREIFEN 620X100X8	RUBBER 620X100X8	CAOUTCHOUC 620X100X8

23.8 FROSTSCHUTZWÄCHTER



23.8 FROST PROTECTION

23.8 PROTECTEUR ANTI-GEL

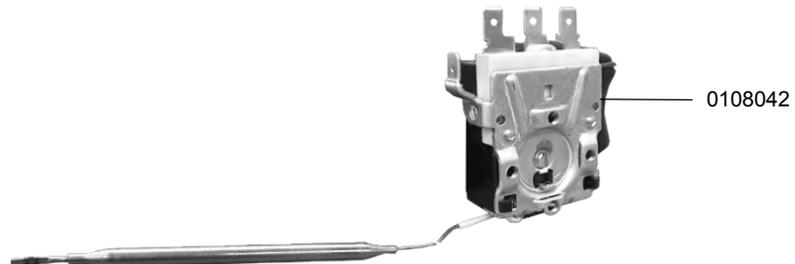
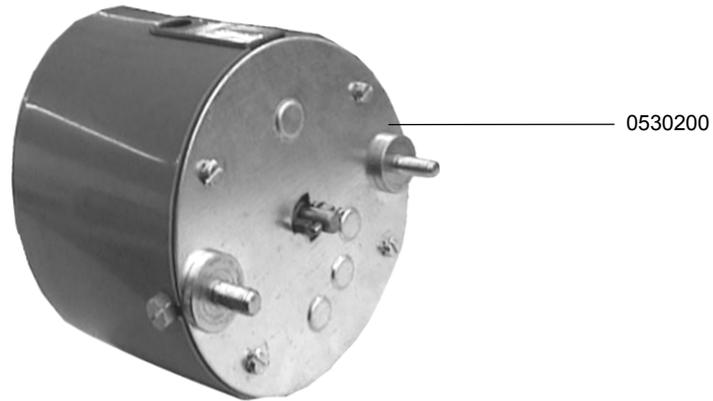

IDENT.-NR. IDENT.-NO.	BEZEICHNUNG	DESIGNATION	DESIGNATION
0530200	MOTOR	MOTOR	MOTEUR
* 0108042	TEMPERATURFÜHLER	TEMPERATURE PROBE	SONDE DE TEMPERATURE

23.9 ABWASSERLEITUNG FÜR UMKEHROSMOSEANLAGE



23.9 WASTE WATER PIPE FOR REVERSE OSMOSIS INSTALL.

23.9 CONDUITE D' EAU POUR INSTALLATION OSMOSE INVERSEE

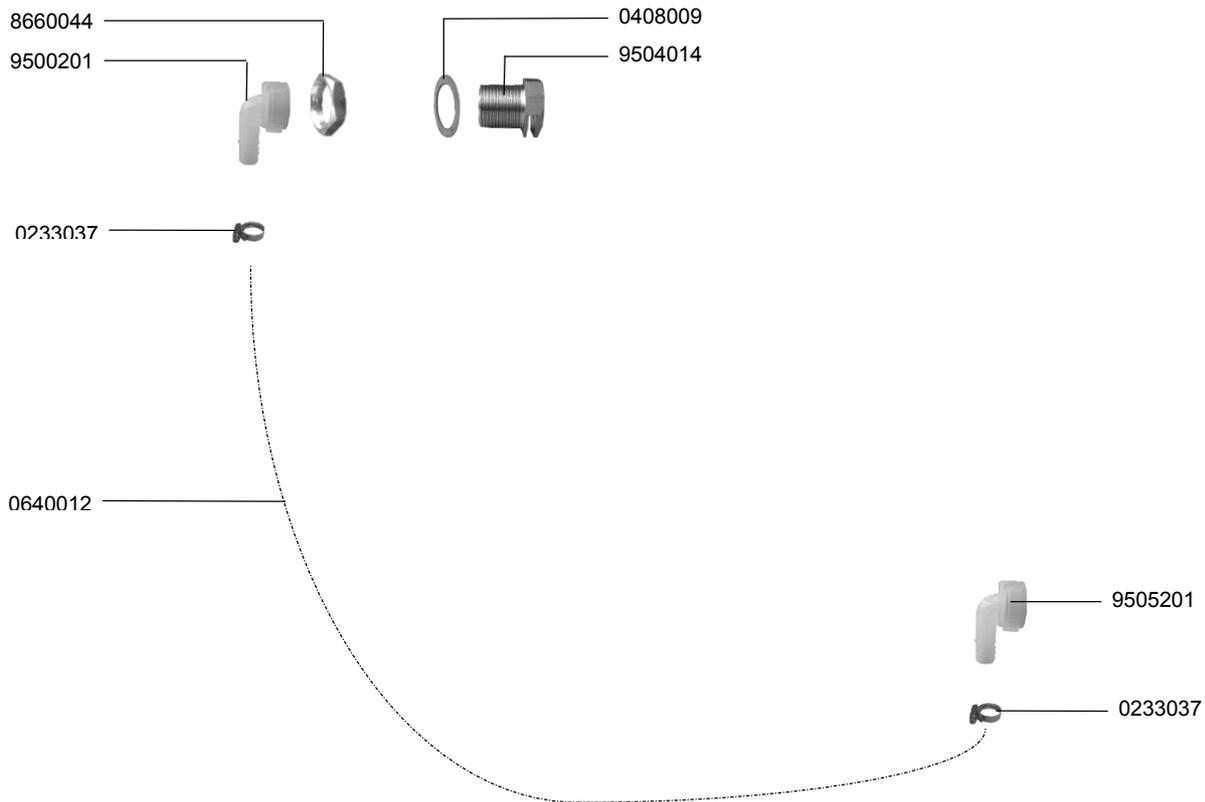

IDENT.-NR. IDENT.-NO.	BEZEICHNUNG	DESIGNATION	DESIGNATION
0408009	DICHTUNG	PACKING	JOINT
* 9504014	FLACHSTRAHLDÜSE	FLAT JET NOZZLE	GICLEUR A JET PLAIN
9505201	ANSCHLUSWINKEL	CONNECTION ANGLE	ANGLE DE CONNEXION
0233037	SCHLAUCHKLEMMME 16-27	HOSE WIRE CLAMP 16-27	COLLIER DE SERRAGE 16-27
0640012	SCHLAUCH	HOSE	TUYAU
8660044	SKT. MUTTER 3/4"	HEXAGON NUT 3/4"	ECROU A 6 PANS 3/4"

23.10 KLAPPENSCHALTER IM EINLAUFTUNNEL



23.10 FLAP SWITCH IN THE FEEDING TUNNEL

23.10 INTERRUPTEUR A CLAPET DANS LE TUNNEL D'ENTREE



IDENT.-NR. IDENT.-NO.	BEZEICHNUNG	DESIGNATION	DESIGNATION
0336050	HUTMUTTER M5	CAP NUT M5	ECROU BORGNE M5
8000963	HALTEBLECH	SUPPORT	SUPPORT
9542983	SCHALTER	SWITCH	INTERRUPTEUR
9542839	ROHRLEITUNG	PIPE LINE	CONDUITE
0408221	DICHTUNG 10*20*4	PACKING 10*20*4	JOINT 10*20*4

23.10.1 KLAPPENSCHALTER IM EINLAUFTUNNEL



23.10.1 FLAP SWITCH IN THE FEEDING TUNNEL

23.10.1 INTERRUPTEUR A CLAPET DANS LE TUNNEL D'ENTREE

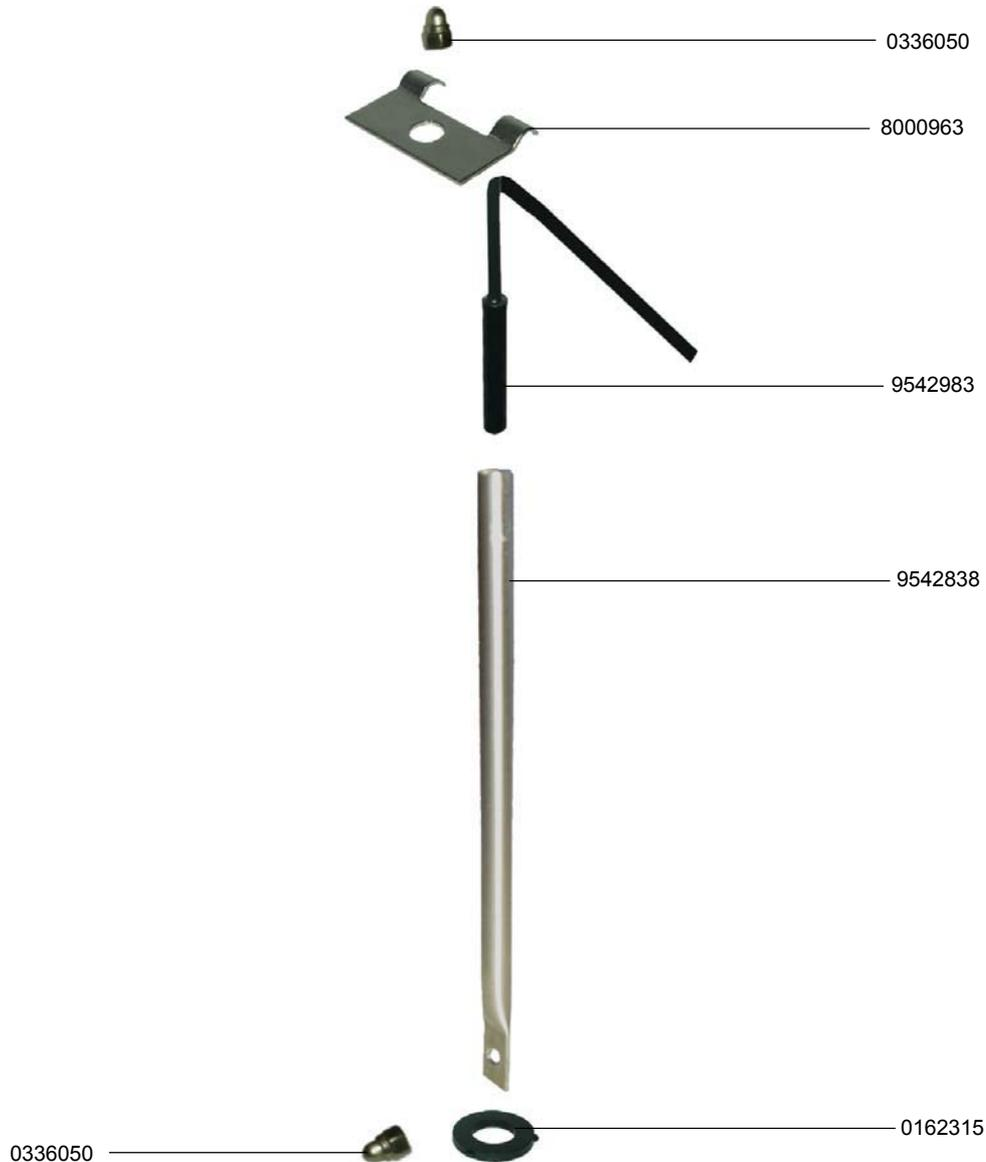

IDENT.-NR. IDENT.-NO.	BEZEICHNUNG	DESIGNATION	DESIGNATION
0336050	HUTMUTTER M5	CAP NUT M5	ECROU BORGNE M5
8000963	HALTEBLECH	SUPPORT	SUPPORT
9542983	SCHALTER	SWITCH	INTERRUPTEUR
9542838	ROHRLEITUNG	PIPE LINE	CONDUITE
0162315	DURCHFÜHRUNGSTÜLLE	BUSHING NIPPLE	DOUILLE DE TRAVERSEE

23.11 KABELFÜHRUNG IM EINLAUFTUNNEL



23.11 CABLE CHANNEL IN THE FEEDING TUNNEL

23.11 GUIDAGE DE CABLE DANS LE TUNNEL D'ENTREE



IDENT.-NR. IDENT.-NO.	BEZEICHNUNG	DESIGNATION	DESIGNATION
9542964	ROHRLEITUNG	PIPE LINE	CONDUITE
9543190	DURCHFÜHRUNGSTÜLLE	BUSHING NIPPLE	DOUILLE DE TRAVERSEE
9503984	FLANSCHPLATTE	FLANGE	FLASQUE
0401018	O-RING	O-RING	BAGUE

23.12 DRUCKSTEIGERUNGSPUMPE



23.12 BOOSTER PUMP

23.12 SURPRESSEUR

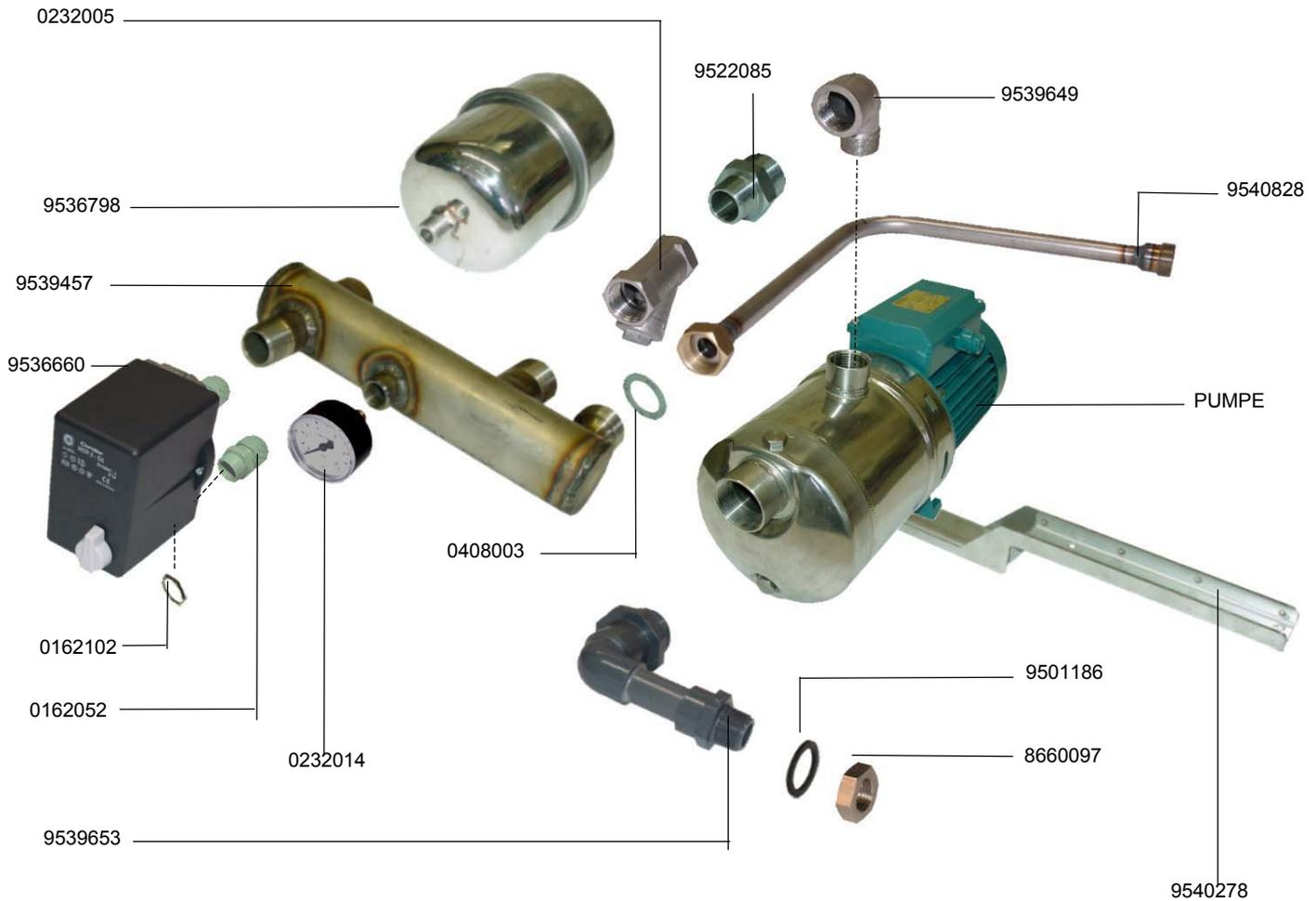

23.12 DRUCKSTEIGERUNGSPUMPE



23.12 BOOSTER PUMP

23.12 SURPRESSEUR

IDENT.-NR. IDENT.-NO.	BEZEICHNUNG	DESIGNATION	DESIGNATION
9539649	BOGEN 90°	90° CURVE	COURBE 90°
9540828	LEITUNG	DUCT	CONDUITE
PUMPE	SIEHE ELEKTROSCHALTPLAN	SEE ELECTRIC WIRING DIAGRAMM	VOIR SCHEMA ELECTRIQUE
9501186	DICHTUNG 37X27X2	PACKING 37X27X2	JOINT 37X27X2
8660097	SECHSKANTMUTTER R3/4°	NUT	ECROU
9540278	KONSOLE KPL.	CONSOLE CPL.	CONSOLE CPL.
9539653	ANSAUGLEITUNG	SUTTON HOSE	TUYAU DE SUTTON
0428003	DICHTUNG 17X24X15	PACKING 17X24X15	JOINT 17X24X15
0232014	MANOMETER	MANOMETER	MANOMÈTRE
0162052	VERSCHRAUBUNG PG 13,5	SCREWING PG 13,5	VISSAGE PG 13,5
0162102	GEGENMUTTER PG 13,5	NUT PG 13,5	ECROU PG 13,5
9536660	DRUCKSENSOR	PRESSURE SENSOR	DETECTEUR DE PRESSION
9539457	VERTEILERROHR	DISTRIBUTING PIPE	TUYAU DISTRIBUTEUR
9536798	DRUCKBEHÄLTER	PRESSURE TANK	RESERVOIR DE PRESSION
0232005	RÜCKSCHLAGVENTIL	CHECK VALVE	CLAPET ANTI-RETOUR
9522085	REDUZIERSTÜCK	REDUCER	REDUCTEUR

24.1.1 FÜLLEITUNG IN P-TANK, PUMPENKLARSPÜLUNG



24.1.1 FILLING PIPE INTO P-TANK, PUMP FINAL RINSE

24.1.1 TUYAU DE REMPLISSAGE POUR BAC P, RINCAGE FINAL A POMPE

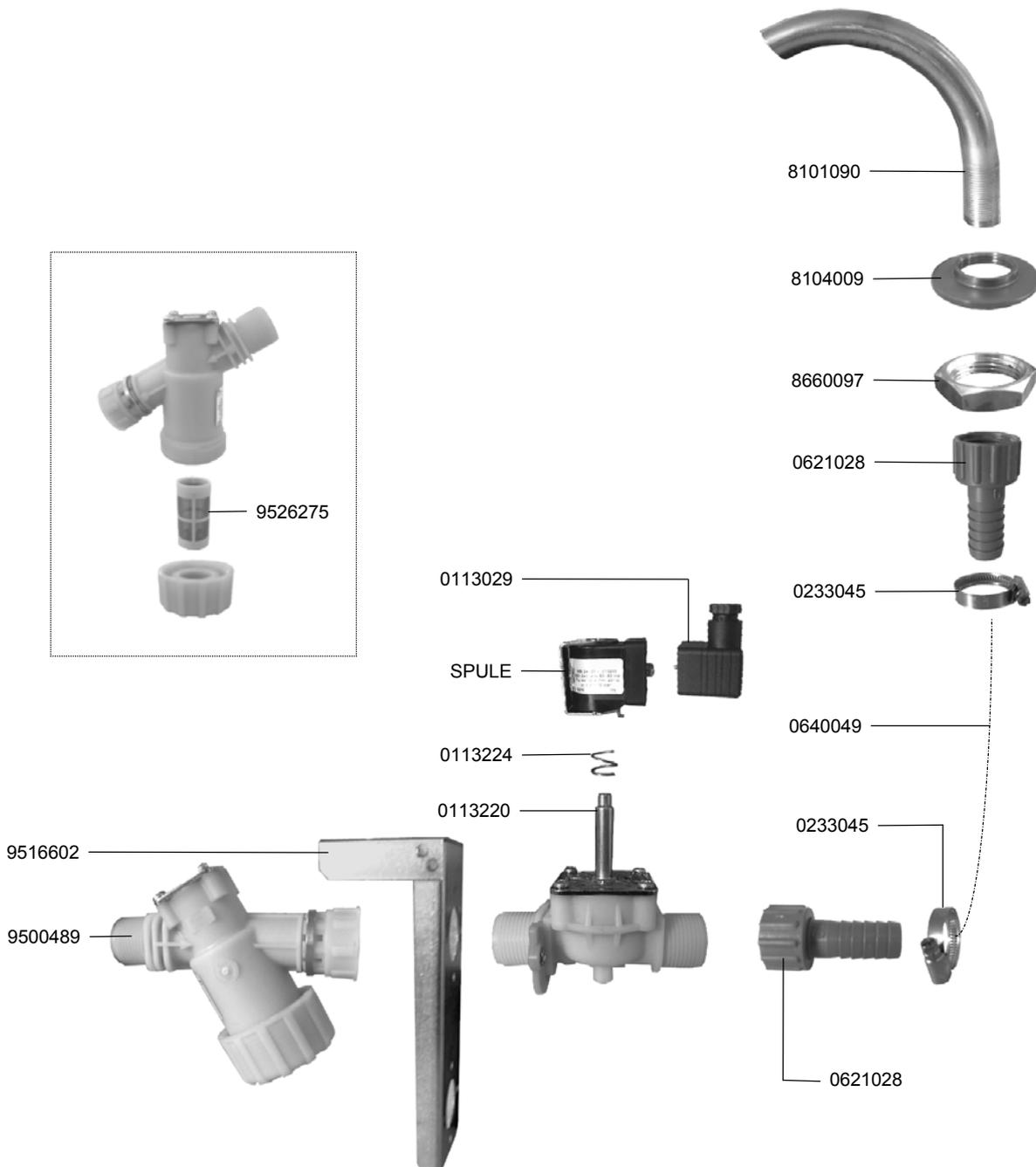

24.1.1 FÜLLEITUNG IN P-TANK, PUMPENKLARSPÜLUNG



24.1.1 FILLING PIPE INTO P-TANK, PUMP FINAL RINSE

24.1.1 TUYAU DE REMPLISSAGE POUR BAC P, RINCAGE FINAL A POMPE

IDENT.-NR. IDENT.-NO.	BEZEICHNUNG	DESIGNATION	DESIGNATION
8101090	FÜLLHAKEN	FILLING HOOK	CROCHET DE REMPLISSAGE
8104009	MUTTER	NUT	ECROU
8660097	SKT.MUTTER	HEXAGON NUT	ECROU A 6 PANS
0621028	ÜBERGANGSSTÜCK	CONNECTION PIECE	PIECE DE CONNEXION
0233045	SCHLAUCHKLEMME 20-32	HOSE WIRE CLAMP 20-32	COLLIER DE SERRAGE 20-32
0640049	SCHLAUCH	HOSE	TUYAU
9500489	SCHMUTZFÄNGER	DIRT TRAP	COLLRCTEUR DE BOUE
9516602	HALTERUNG	SUPPORT	SUPPORT
0113220	MAGNETVENTIL	SOLENOID VALVE	ELECTOVANNE
0113224	FEDER	SPRING	RESSORT
SPULE	SIEHE ELEKTROSCHALTPLAN	SEE ELECTRIC WIRING DIAGRAM	VOIR SCHEMA ELECTRIQUE
0113029	STECKBÜCHSE	TIP JACK	FICHE FEMELLE
9526275	SIEB	SIEVE	TAMIS

24.2.1 FÜLLEITUNG IN KWZ TANK



24.2.1 FILLING PIPE INTO KWZ TANK (FINAL RINSE TANK)

24.2.1 TUYAU DE REMPLISSAGE POUR BAC KWZ (BAC DE RINCAGE FINAL)

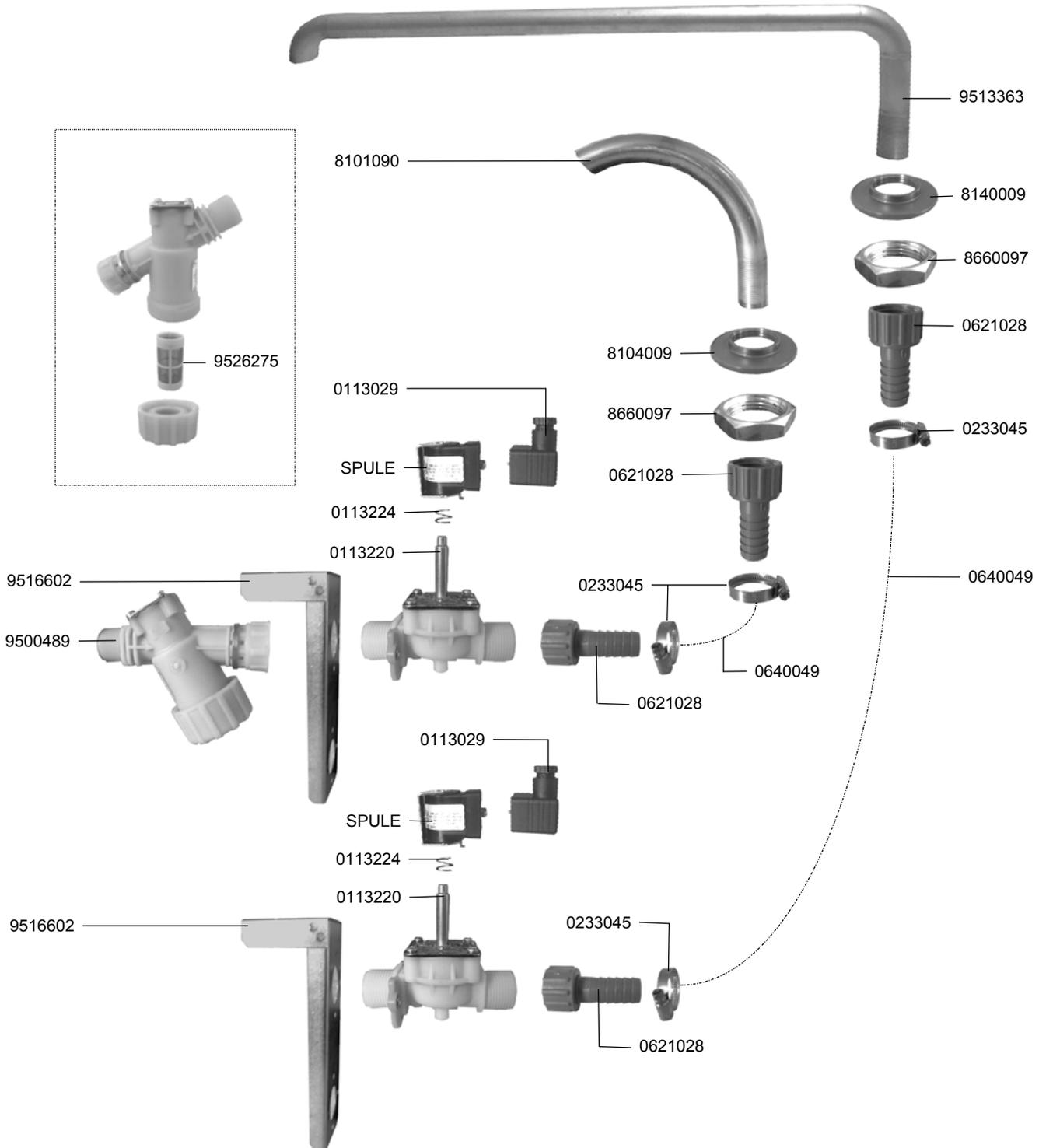

24.2.1 FÜLLEITUNG IN KWZ TANK



24.2.1 FILLING PIPE INTO KWZ TANK (FINAL RINSE TANK)

24.2.1 TUYAU DE REMPLISSAGE POUR BAC KWZ (BAC DE RINCAGE FINAL)

IDENT.-NR. IDENT.-NO.	BEZEICHNUNG	DESIGNATION	DESIGNATION
9513363	FÜLLHAKEN	FILLING HOOK	CROCHET DE REMPLISSAGE
8104009	MUTTER	NUT	ECROU
8660097	SKT.MUTTER	HEXAGON NUT	ECROU A 6 PANS
0621028	ÜBERGANGSSTÜCK	CONNECTION PIECE	PIECE DE CONNEXION
0233045	SCHLAUCHKLEMME 20-32	HOSE WIRE CLAMP 20-32	COLLIER DE SERRAGE 20-32
0640049	SCHLAUCH	HOSE	TUYAU
9516602	HALTERUNG	SUPPORT	SUPPORT
* 0113220	MAGNETVENTIL	SOLENOID VALVE	ELECTROVANNE
* 0113224	FEDER	SPRING	RESSORT
SPULE	SIEHE ELEKTROSCHALTPLAN	SEE ELECTRIC WIRING DIAGRAM	VOIR SCHEMA ELECTRIQUE
0113029	STECKBÜCHSE	TIP JACK	FICHE FEMELLE
9500489	SCHMUTZFÄNGER	DIRT TRAP	COLLRCTEUR DE BOUE
9526275	SIEB	SIEVE	TAMIS
8101090	FÜLLHAKEN	FILLING HOOK	CROCHET DE REMPLISSAGE