

13.2 BAUGRUPPEN/EINZELTEILE

13.2 COMPONENT BLOCKS/PIECE PARTS

BE13 2
1.1.92/TK

13.2 BLOCS/PIECES DETACHEES

IDENT. NR. IDENT. NO.	BEZEICHNUNG	DESIGNATION	DESIGNATION
0621003	TISCHSTOLLEN K 220/221	TABLE FEET K 220/221	PIEDS DE TABLE K 220/221
8000183	EINLEGEKREUZ FÜR ECKKORBTRÄGER	INSERTION CROSS FOR CORNER BASKET SUPPORT	CROIX SUPPORT DE PANIER EQUERRE
8000161	HAUBENFÜHRUNGSSCHIENEN	GUIDING RAILS/HOOD	RAILS DE CONDUITE/CAPOT
8000179	Korbträger Kpl. Eckaufstellung		
8001129	Frontblende für Folie		
8000833	Abdecksieb Tank 2 X je Maschine 451 X 270		
8001833	Rückwand Kpl.		
8000357	2 X Korblaufschiene		

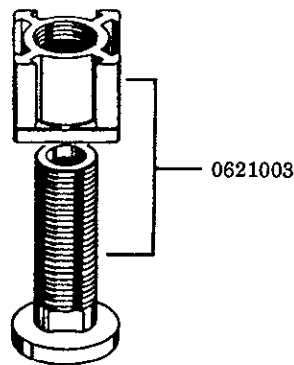

gültig ab 1.1.92
valid from 1.1.92 on
valable à partir du 1.1.92

* Diese Teile empfehlen wir auf Lager zu legen!
* We recommend to store these parts!
* Nous recommandons de prendre ces pièces en stock!

GRUPPE

1



MEIKO

**Geschirrspül-
automat** **DV 80**
**Mehrzweck-
waschautomat** **DV 120 B**

**Fließendes Spülen
im Durchschubverfahren**



Einbauboiler

m MEIKO

- | | |
|---------|---------------------------|
| 8400259 | Einbauboiler Kpl., 3 Kw |
| 8400260 | Einbauboiler Kpl., 6 KW |
| 8400261 | Einbauboiler Kpl., 7,5 KW |
| 8400229 | Einbauboiler Kpl., 9 KW |

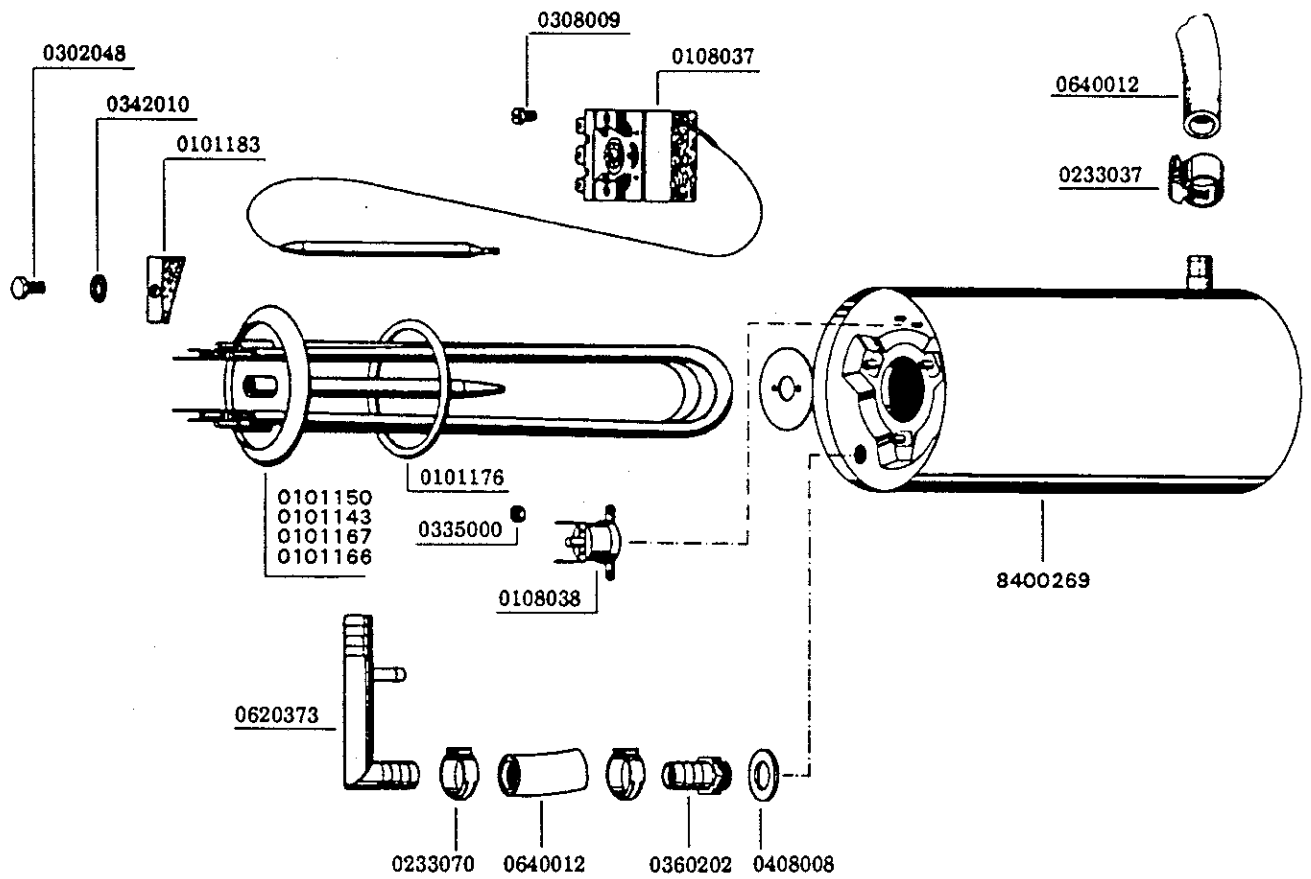

Elektroniksteuerung Spül 4

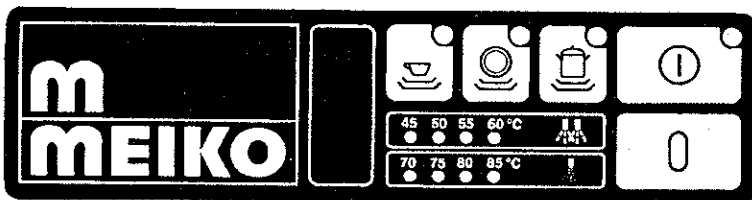

0467210

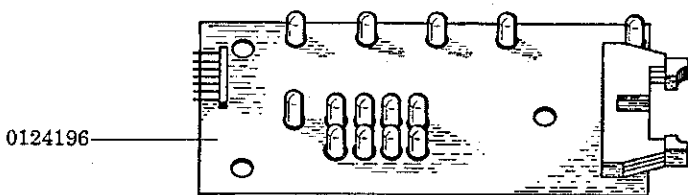

0124196

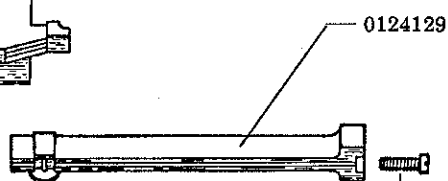

0124129

0308003

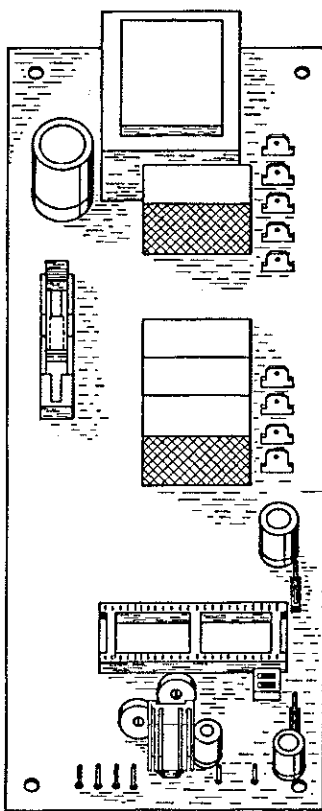

0180503

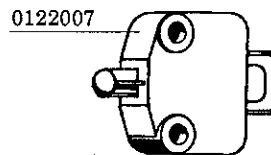

0122007

0124191

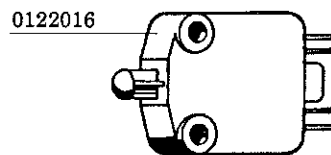

0122016

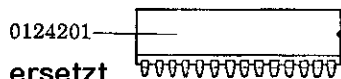

0124201

ersetzt durch 0124239

0180615 Fühler Temperaturanzeige
2 X 0160090 Stecker R 1,3-0,5



0122070

Elektroteile

DV 80 (ET12_3)

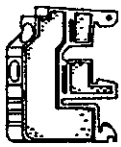

0153288

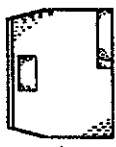

0153268

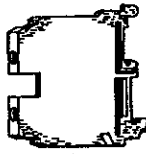

0153270
0153266

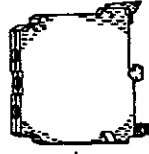

0153267



0145000
0145013

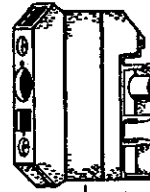

0153118

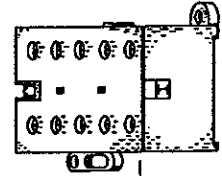

0135209

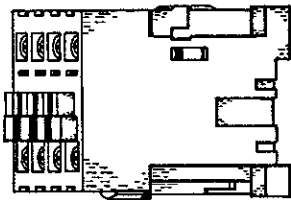

0135202

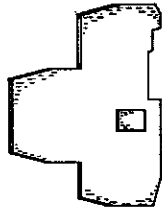

0153289

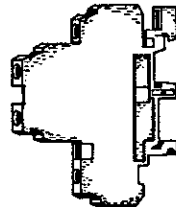

0153292
0153294

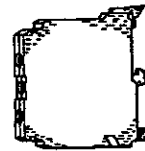

0153278

0621008 Schaltkastendeckel

Haubengestänge

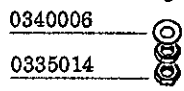
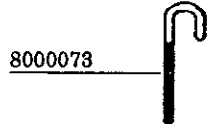
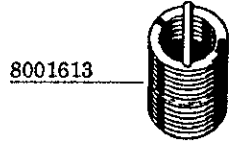
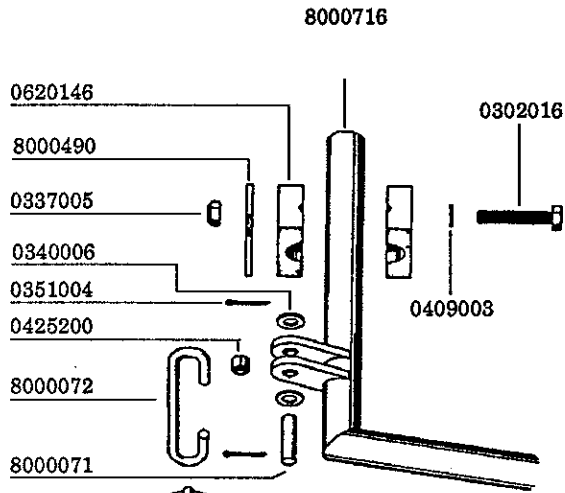

8001486 Bügel für Doppelwandig mit 3 Laschen !!

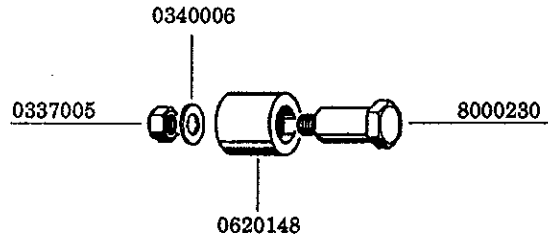

Klarspüldosiergerät

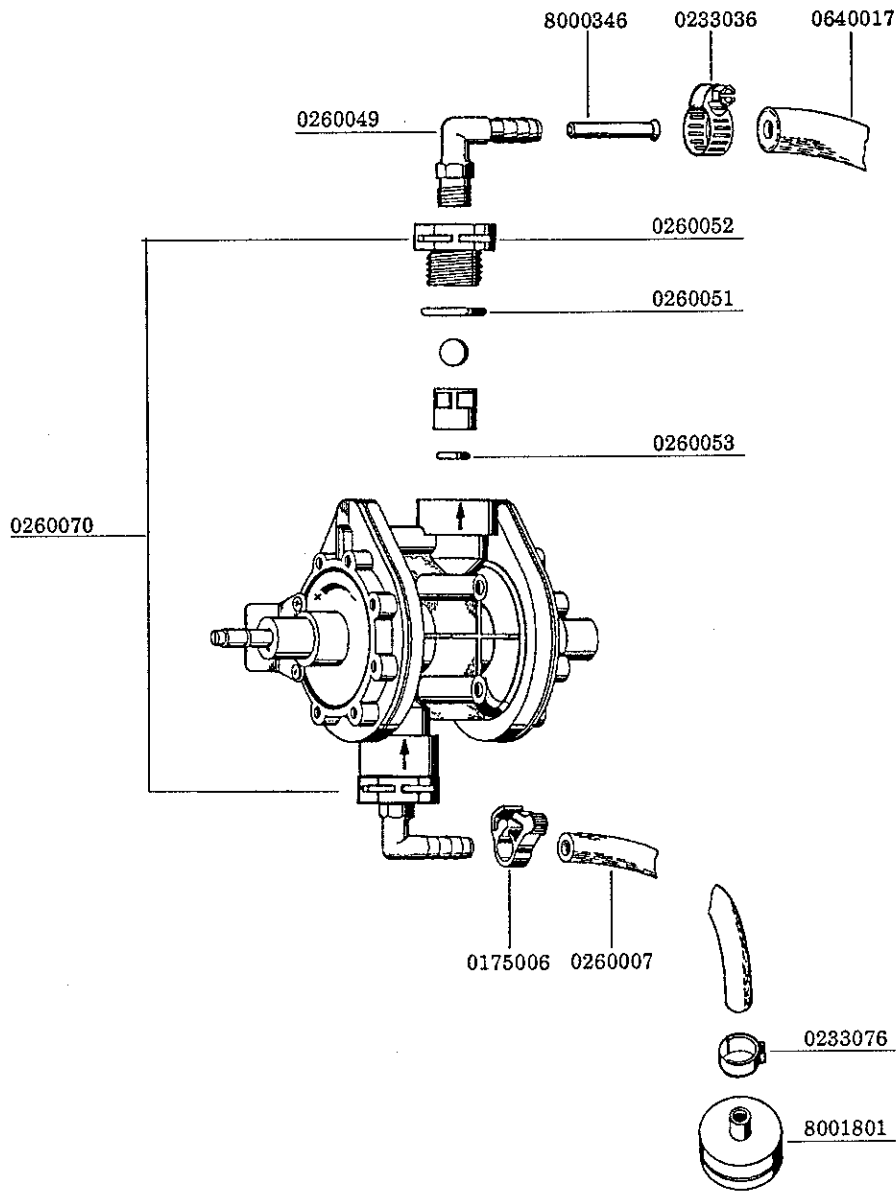



MV4 1
1.1.92/TK

4.1 MAGNETVENTIL

4.1 SOLENOID VALVE

4.1 ELECTROVANNE

IDENT. NR. IDENT. NO.	BEZEICHNUNG	DESIGNATION	DESIGNATION
* 0113223	MAGNETSPULE 220V, 50HZ	COIL 220 V, 50 HZ	BOBINE 220 V, 50 HZ
* 0113224	MAGNETVENTILFEDER	SPRING FOR SOLENOID VALVE	RESSORT
* 0113200	MAGNETVENTIL NW 10, ECKAUSFÜHRUNG	SOLENOID VALVE NW 10 CORNER EXECUTION	ELECTROVANNE NW 10 EXEC. EN ANGLE
0113098	MAGNETVENTILFILTERSIEB	FILTER SIEVE F. SOLENOID VALVE	TAMIS-FILTRE P. ELECTRO- VANNE
0640008	SCHLAUCH SCHWARZ, 1/2"	HOSE BLACK, 1/2"	TUYAU NOIR, 1/2"
0640012	SCHLAUCH GRAU, 1/2"	HOSE GREY, 1/2"	TUYAU FLEXIBLE GRIS, 1/2"
0233037	SCHLAUCHKLEMME 16 - 27	HOSE CLAMP 16 - 27	PINCE/TUYAUX SOUPLES 16-27
0233070	1-OHR-KLEMME	1-EAR CLAMP	BORNE A UNE OREILLE
0621035	T-STÜCK TS 13	T-PIECE TS 13	PIECE DE -T- TS 13

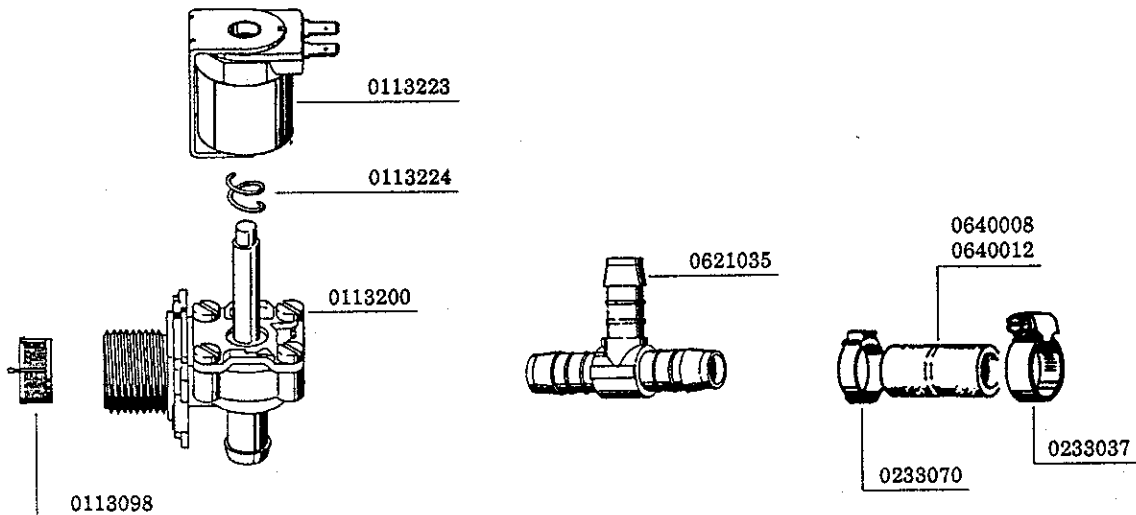

gültig ab 1.1.92
valid from 1.1.92 on
valable à partir du 1.1.92

- * Diese Teile empfehlen wir auf Lager zu legen!
- * We recommend to store these parts!
- * Nous recommandons de prendre ces pièces en stock!

Änderungen in Ausführung und Konstruktion vorbehalten.
We reserve the right to change execution and construction.
Nous nous réservons le droit de changer l'exécution et la construction.

6.1 NIVEAUREGELUNG

6.1 LEVEL CONTROL

6.1 REGULATION DE NIVEAU



NVR6 1
1.5.93/FH

IDENT. NR. IDENT. NO.	BEZEICHNUNG	DESIGNATION	DESIGNATION
* 0130008	NIVEAUSCHALTER 62/30	LEVEL SWITCH 62/30	INTERRUPTEUR DE NIVEAU 62/30
* 0233076	1-OHR-KLEMME 10,0 GER	1-EAR CLAMP 10,0 GER	BORNE A UNE OREILLE 10,0 GER
* 0260006	SCHLAUCH KLARSICHT 5 x 1,5	HOSE TRANSPARENT 5 x 1,5	TUYAU TRANSPARENT 5 x 1,5
* 0650001	GUMMISTUTZEN	RUBBER SOCKET	MANCHON EN CAOUTCHOUC
* 0233082	1-OHR-KLEMME 19,5 RER	1-EAR CLAMP 19,5 RER	BORNE A UNE OREILLE 19,5 RER
* 0620244	LUFTFALLE K244	AIR TRAP K 244	CHAMBRE DE COMPRESSION K 244

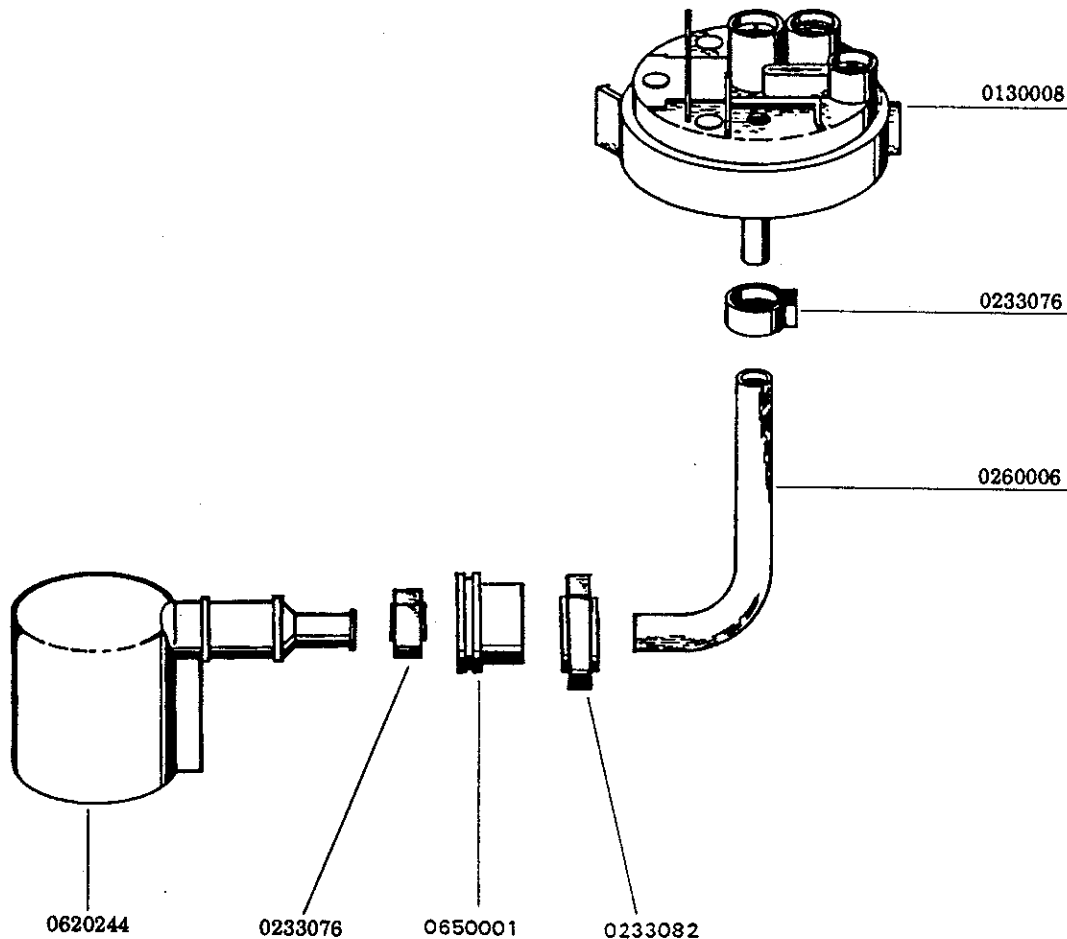

gültig ab 1.5.93
valid from 1.5.93 on
valable à partir du 1.5.93

* Diese Teile empfehlen wir auf Lager zu legen!
* We recommend to store these parts!
* Nous recommandons de prendre ces pièces en stock!

Änderungen in Ausführung und Konstruktion vorbehalten. * We reserve the right to change execution and construction. * Nous nous réservons le droit de changer l'exécution et la construction.

Pumpenansaugung

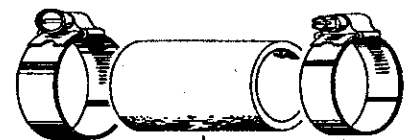
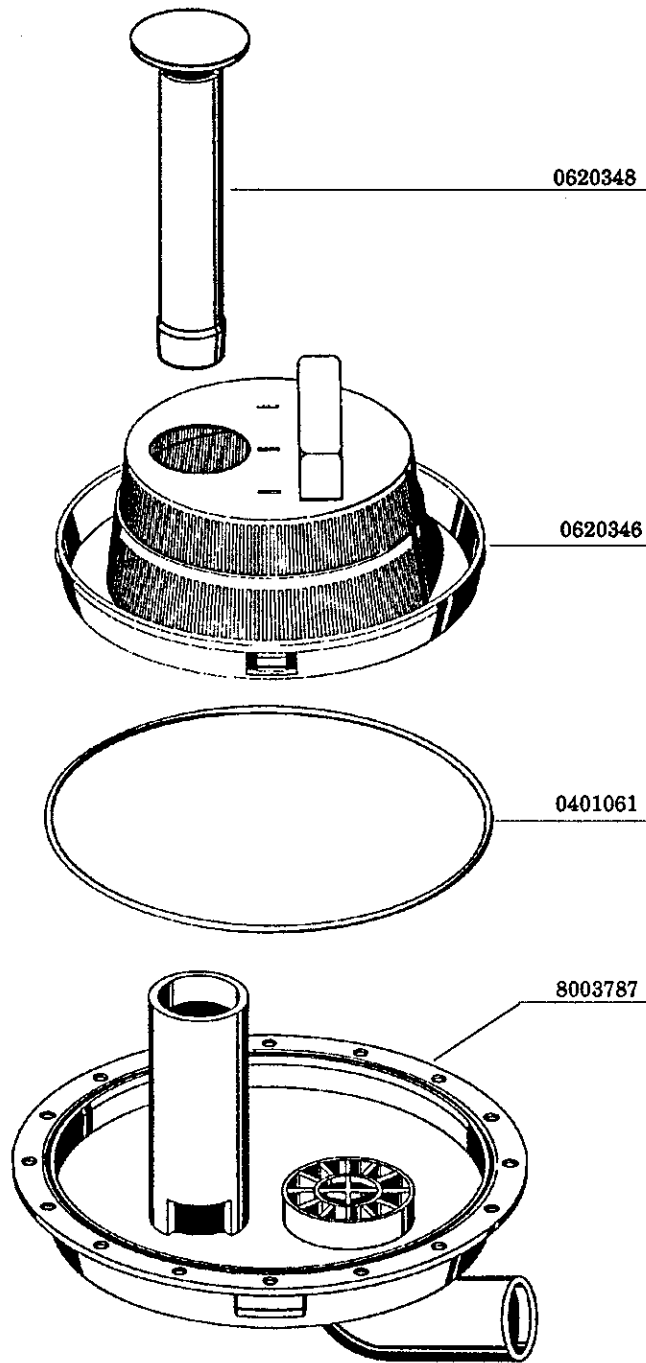

0233041

8002570

0233046

5.1 RÜCKSAUGEVERHINDERER

5.1 REFLUX PREVENTOR

RV5 1
1.1.92/RK

5.1 DISPOSITIF ANTI-RETOUR

IDENT. NR. IDENT. NO.	BEZEICHNUNG	DESIGNATION	DESIGNATION
8002731	RÜCKSAUGEVERHINDERER 1/2", KPL. (OHNE EW)	REFLUX PREVENTOR 1/2", COMPL. (WITHOUT EV)	DISPOSITIF ANTI-RETOUR 1/2", COMPL. (SANS EW)
* 0620334	RÜCKSAUGEVERHINDERER K 333	REFLUX PREVENTOR K 333	DISPOSITIF ANTI-RETOUR K 333
0340027	UNTERLEGSSCHEIBE 5,8X11X1 NACH DIN 522	WASHER 5,8X11X1 TO DIN 522	RONDELLE 5,8X11X1 SELON DIN 522
0337001	SECHSKANTMUTTER SELBST- SICHERND DIN 985-M5	HEXAGON NUT SELFFIXING DIN 985-M5	ECROU A SIX PANS, INDESSERRABLE DIN 985-M5
0640012	SCHLAUCH GRAU, 1/2"	HOSE GREY, 1/2"	TUYAU FLEXIBLE GRIS, 1/2"
0233070	1-OHR-KLEMME	1-EAR CLAMP	BORNE A UNE OREILLE
* 0620342	SCHLAUCHANSCHLUSS EINFACH, K 340	HOSE CONNECTION SIMPLE K 340	CONNEXION DE TUYAU, SIMPLE K 340
* 0620343	SCHLAUCHANSCHLUSS DOPPELT, K 341 (BEI EW)	HOSE CONNECTION DOUBLE K 341 (WITH EW)	CONNEXION DE TUYAU, DOUBLE K 341 (AVEC EW)
* 0217433	GUMMIDICHTUNG 17 X 24 X 2	RUBBER PACKING 17 X 24 X 2	JOINT EN CAOUTCHOUC 17X24X2
8660141	SECHSKANTMUTTER R 3/8" X 5	HEXAGON NUT R 3/8" X 5	ECROU A SIX PANS R 3/8" X 5

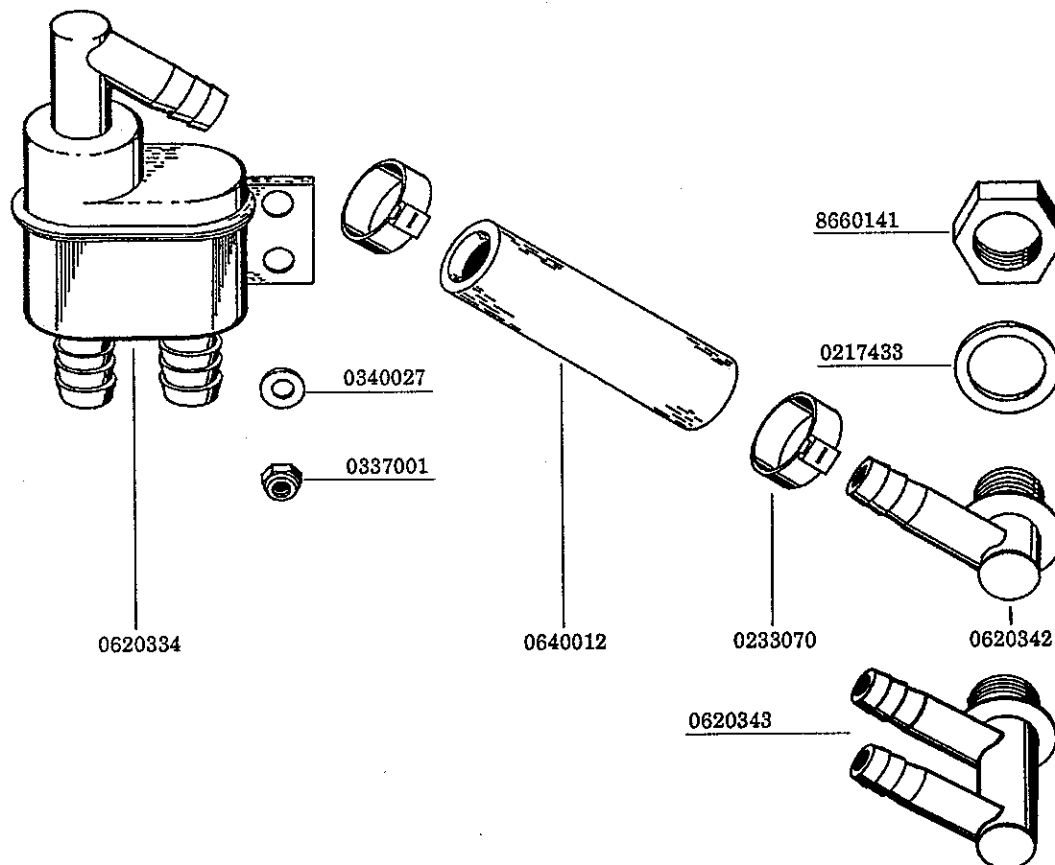

gültig ab 1.1.92
valid from 1.1.92 on
valable à partir du 1.1.92

* Diese Teile empfehlen wir auf Lager zu legen!
* We recommend to store these parts!
* Nous recommandons de prendre ces pièces en stock!



Steckbrief Geschirr- und Behälterspülautomat DV 120 B

13.6.1994/HK

Programmlaufzeit	gesamt 60/90/210 s waschen 44/74/194 s, abtropfen 6 s, spülen 10 s	
Korbgröße	500 x 500 mm	
Einschubhöhe	400 mm	
Schutzart des Automaten	IP 54	
Einbauboiler ab 10 °C	9 kW	Gesamtanschluß 10,1 kW
Einbauboiler ab 45 °C	7,5 kW	Gesamtanschluß 8,6 kW
Einbauboiler Inhalt	9 l	
Regler verstellbar 10-95 °C	Boilerheizung mit Tankheizung el. verriegelt	
Tankheizung	3 kW	55 - 60 °C fest eingestellt
Durchlaufmenge	min. 0,3 l/s bei 2,5 bar Fließdruck	
Erforderlicher Fließdruck	min. 2,5 bar vor dem Magnetventil	max. 5 bar
Nachspülwassermenge	3 l/Spülgang	
Tankinhalt	38 l	
Pumpenmotor	Typ 1241 Drehzahl 2800 U/min	1,1 kW Stromaufnahme 2,8 A
Umwälzleistung	625 l/min Werkstoff Premix A	Druck 7 mWS
Klarspülerdosiergerät	Typ N6	
Materialstärke	1 - 3 mm	
Werkstoff	1.4301 (CrNi18/10)	
Wärmeabgabe	bei 25 Programmabläufen/h: gesamt 18400 kJ/h fühlbar 5400 kJ/h latent 13000 kJ/h	
Lautstärke	70 dB (A)	
Gewicht netto	91 kg	
Dampfverbrauch bei NDD- Beheizung, 0,3-0,5 bar	Frischwasserzulauf 10 °C	max. 18 kg/h
	Frischwasserzulauf 45 °C	max. 10 kg/h
Werkstoff Wärmetauscher	1.4301/1.4571/1.4435	

9.2 TANKHEIZUNG

9.2 TANK HEATING

TH8 2
1.1.82/HK

9.2 CHAUFFAGE DE BAC

IDENT. NR. IDENT. NO.	BEZEICHNUNG	DESIGNATION	DESIGNATION
* 0101151	HEIZKÖRPER 3 KW, 220V	HEATING ELEMENT 3 KW, 220 V	RESISTANCE 3 KW, 220 V
* 0101176	HEIZKÖRPERDICHTUNG	HEATING ELEMENT PACKING	JOINT DE RESISTANCE
* 0108040	GUMMIMANSCHETTE	RUBBER PACKING	MANCHETTE EN CAOUTCHOUC
* 0108047	TEMPERATURREGLER 1 KONTAKT, DV 120 B	THERMOSTAT, 1 CONTACT, DV 120 B	REGULATEUR DE TEMPERATURE, 1 CONTACT, DV 120 B

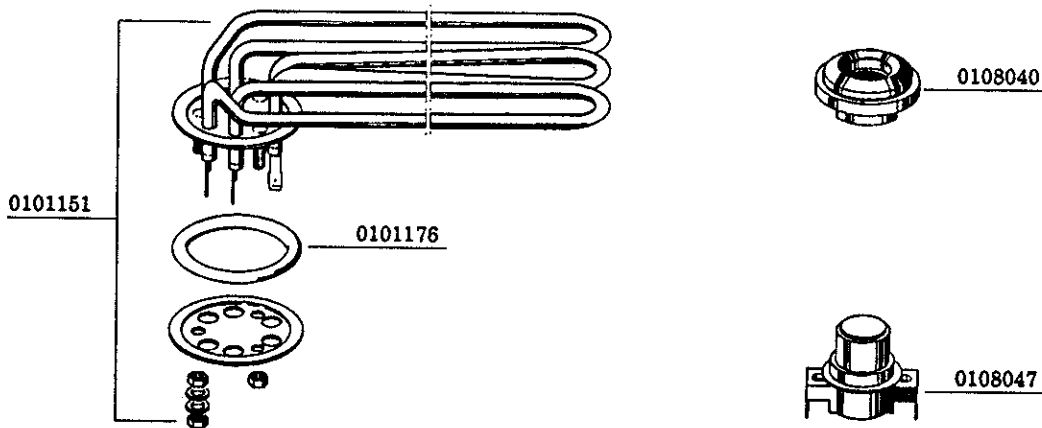

gültig ab 1.1.92
valid from 1.1.92 on
valable à partir du 1.1.92

- * Diese Teile empfehlen wir auf Lager zu legen!
- * We recommend to store these parts!
- * Nous recommandons de prendre ces pièces en stock!

Wasch und Nachspülsystem

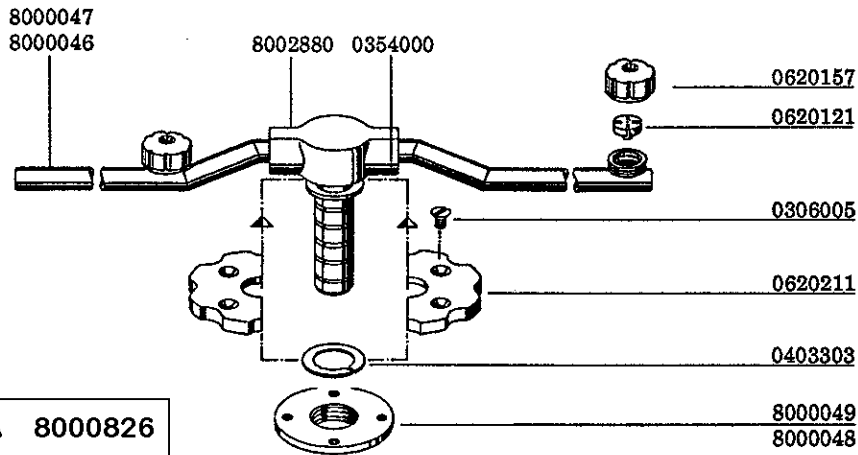

Steigrohr V2A 8000826

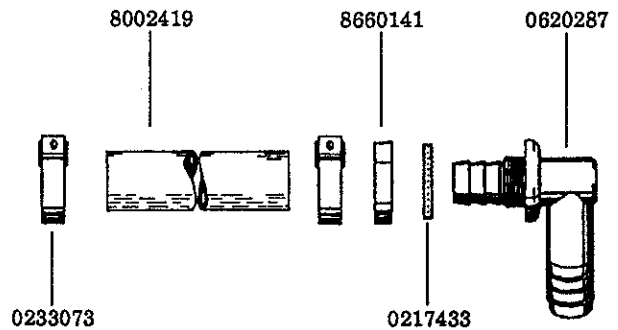
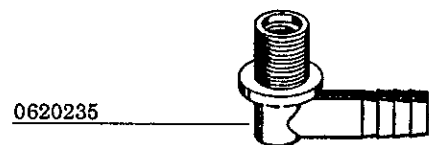
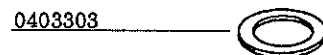
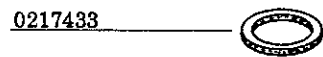
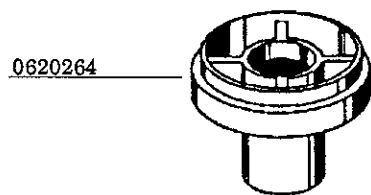
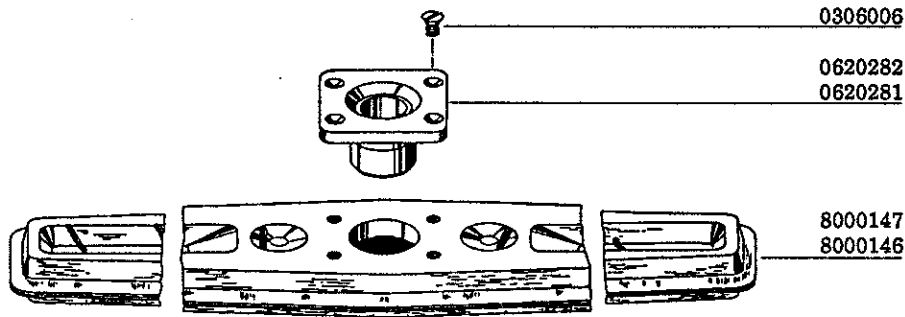

Waschpumpe

