

MEIKO Undercounter Dish and Glass Washing Machine



Spare Parts List

FV40.2

208V/230V 1/3-PHASE 60 HZ





CONTENTS

1.1		WASH PUMP	PAGE 3
	1.11	WASH SYSTEM	PAGE 5
2.1		BOOSTER PUMP	PAGE 7
3.1		SOLENOID / FILL VALVE SYSTEM	PAGE 8
	3.11	AIR GAP	PAGE 9
4.1		WASH TANK LEVEL CONTROL	PAGE 10
5.1		BUILT-IN BOOSTER HEATER	PAGE 11
6.1		WASH TANK HEATING	PAGE 13
7.1		CHEMICAL DOSING	PAGE 15
	7.11	CHEMICAL PICKUP TUBES	PAGE 17
	7.12	EXTERNAL DISPENSER TERMINAL BLOCK	PAGE 18
8.1		PUMPED DRAIN SYSTEM	PAGE 19
9.1		ELECTRONIC CONTROL	PAGE 21
	9.11	PLUGS AND PINS	PAGE 24
	9.12	ELECTRICAL SUPPLY CONNECTION BLOCK	PAGE 26
10.1		MACHINE PANELS / EXTERNAL PARTS	PAGE 27
	10.11	DOOR COUNTERWEIGHT	PAGE 29
11.1		OPTIONAL COMPONENTS	PAGE 30

LEGEND KEY FOR PARTS	
*	RECOMMENDED STOCKING PART
V	WEAR AND TEAR PART
MEIKO RESERVES THE RIGHT TO CHANGE EXECUTION AND CONSTRUCTION OF PARTS WITHOUT NOTICE.	

MEIKO USA Inc.
 1349 Heil Quaker Blvd.
 La Vergne, TN 37086
 Toll Free (800) 55-MEIKO (For general inquiries)
 24-Hour Service (800) 868-3840 or (615) 399-6600
 FAX (615) 399-6620
www.meiko.us
Info@meiko.us

1.1 WASH PUMP

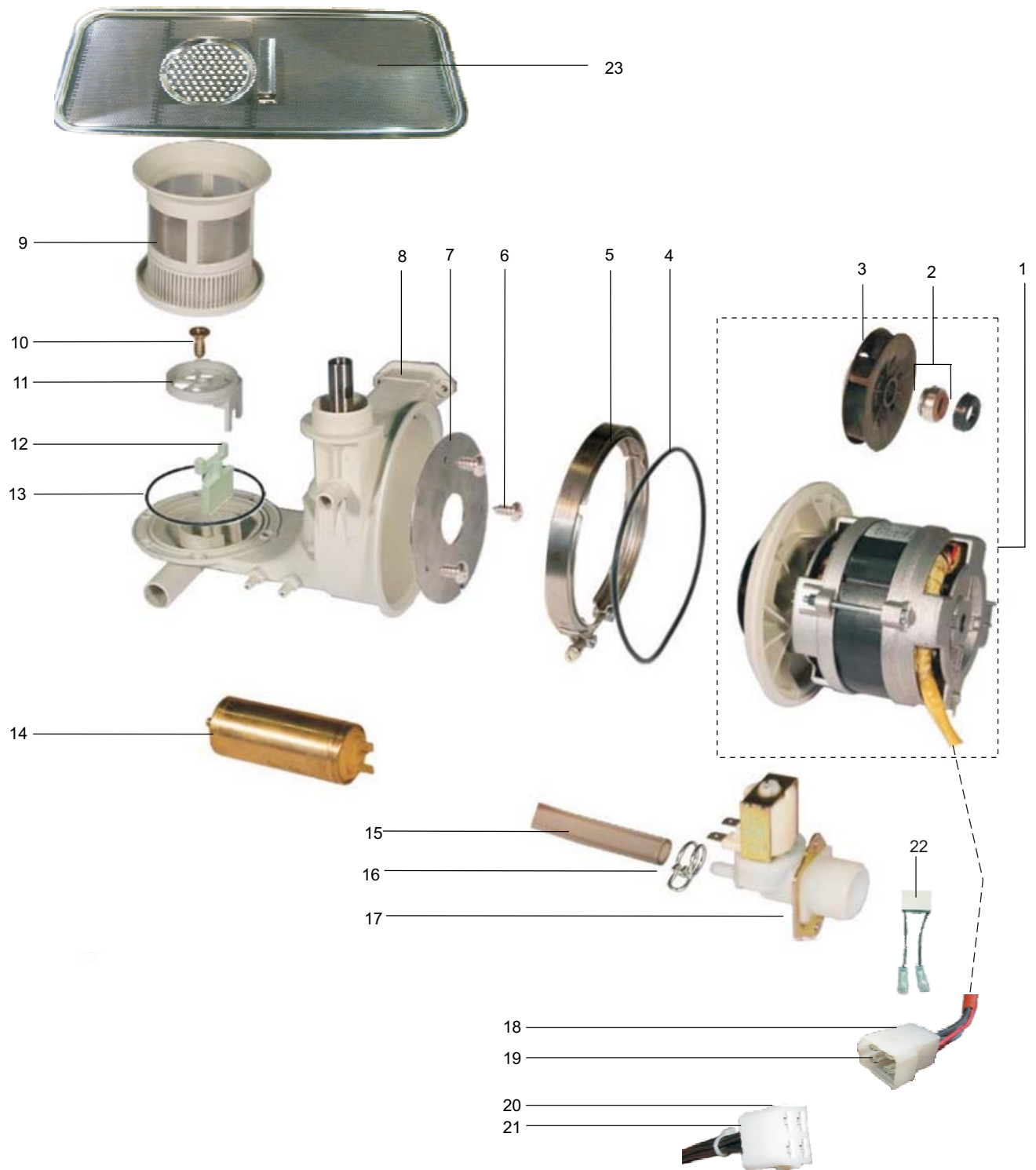



1.1 WASH PUMP

POS.	PART NUMBER	DESCRIPTION
1	9208273	WASH PUMP KIT 0.55 KW CPL. (INCLUDES START CAPACITOR AND O-RING)
2	9519539	SLIDING SEAL CPL.
3	9621795	PUMP WHEEL IMPELLAR 70MM 60 HZ
4	9515339	O-RING 145MM X 4MM
5	9640601	CLAMP FOR WASH PUMP
6	0330020	SCREW
7	9519224	PUMP BASE
8	9514632	PUMP HOUSING - FOR SERIAL NUMBER < 30003008
8	9677486	PUMP HOUSING - FOR SERIAL NUMBER > 30003007
9	9611991	SUCTION SIEVE CPL.
10	0330039	SCREW
11	9600024	DRAIN VALVE
12	9550670	FLAP
13	9515338	O-RING 96MM X 3MM
14	9610918	START CAPACITOR 12 μ F
15	0260007	HOSE, CLEAR
16	9655015	HOSE CLAMP
17	9544641	SOFT START VALVE
18	9537406	CONNECTOR (FEMALE)
19	9537431	CRIMP CONTACT (MALE)
20	9531742	CRIMP CONTACT (FEMALE)
21	9531643	CONNECTOR (MALE)
22	9549559	RUN CAPACITOR 0.47 μ F
23	9515464	WASH TANK SIEVE

1.11 WASH SYSTEM

FOR MACHINES WITH SERIAL NUMBER < 30002715

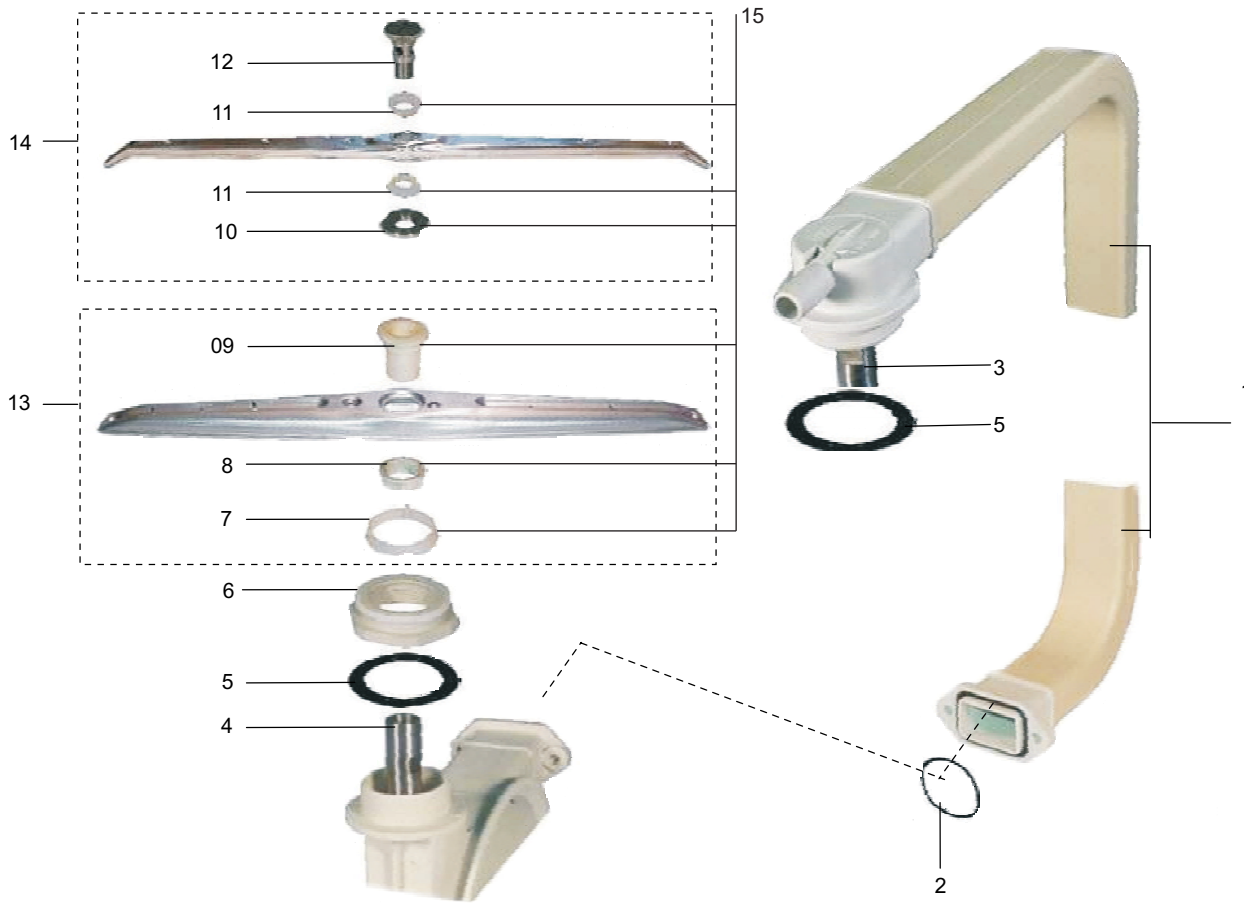

POS.	PART NUMBER	DESCRIPTION
1	9208434	ASCENDING PIPE ASSEMBLY
2	9515336	O-RING
3	9514452	UPPER BEARING JOURNAL
4	9514453	LOWER BEARING JOURNAL
5	9515334	SEALING PROFILE
6	9514101	NUT
7	9520931 V	RING
8	9517398 V	NUT
9	9517397 V	BEARING
10	9604483 V	SPACER, 6MM
11	9522439 V	BEARING
12	9517409	KNURLED SCREW
13	9517391	WASH ARM CPL.
14	9547257	FINAL RINSE ARM CPL.
15	9207851 * V	WASH / RINSE ARM BEARING KIT

1.11 WASH SYSTEM

FOR MACHINES WITH SERIAL NUMBER \geq 30002715

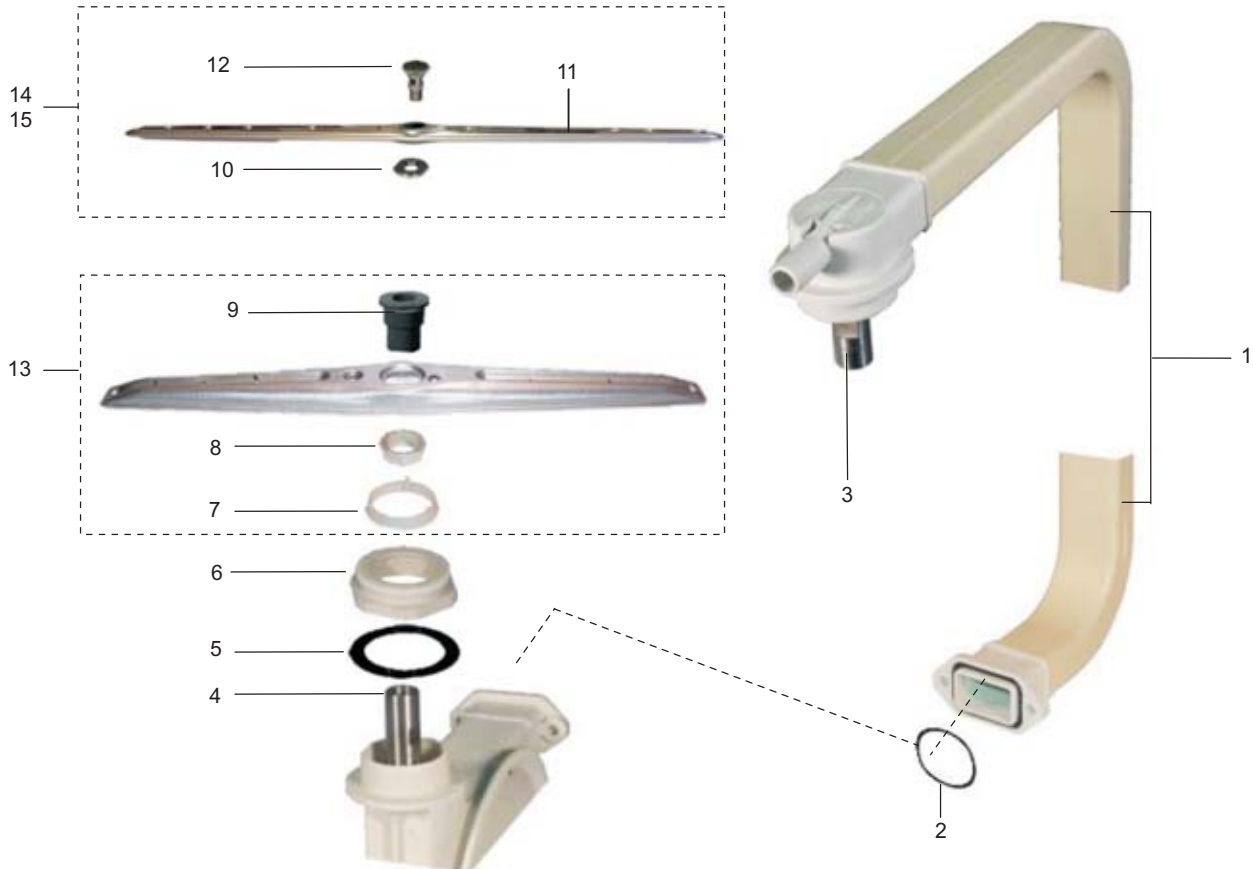

POS.	PART NUMBER	DESCRIPTION
1	9208434	ASCENDING PIPE ASSEMBLY
2	9515336	O-RING
3	9514452	UPPER BEARING NECK
4	9514453	LOWER BEARING NECK
5	9515334	SEALING PROFILE
6	9514101	NUT
7	9679658 V	RING
8	9517398 V	NUT
9	9671628 V	BEARING
10	9657135 V	SPACER, 6MM
11	9663288 V	FINAL RINSE ARM LOWER
11	9663408	FINAL RINSE ARM UPPER
12	9669732	KNURLED SCREW
13	9659321	WASH ARM ASSEMBLY CPL.
14	9679331	FINAL RINSE ARM BOTTOM ASSEMBLY CPL.
15	9679332	FINAL RINSE ARM TOP ASSEMBLY CPL.

2.1 BOOSTER PUMP

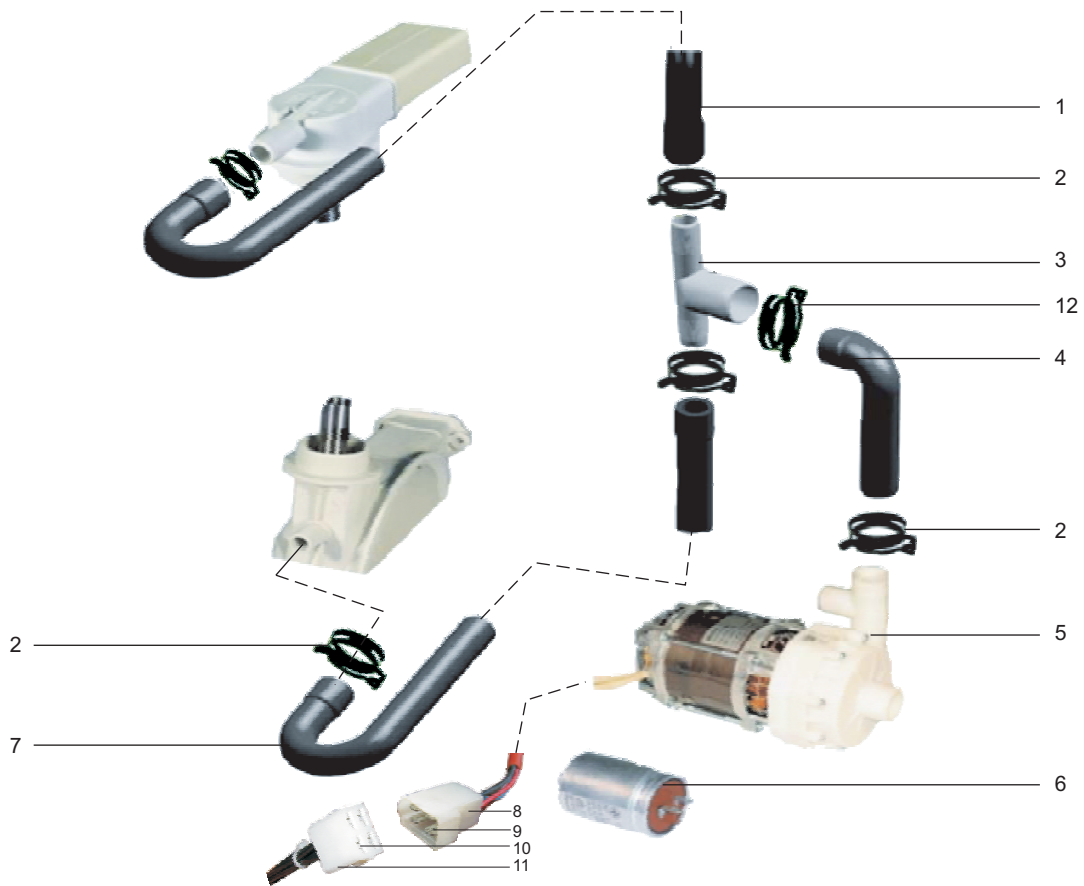

POS.	PART NUMBER	DESCRIPTION
1	9601256	HOSE CONNECTION
2	0233045	HOSE CLAMP
3	9601255	HOSE DISTRIBUTOR
4	9601259	HOSE CONNECTION
5	9207455 *	BOOSTER PUMP KIT WITH DRIP SHIELD
	9536916	PUMP WHEEL
	9662632	SLIDING SEAL CPL.
	9523260	O-RING
	9207340	DRIP SHIELD
6	9520030	CAPACITOR 5µF
7	9601257	HOSE CONNECTION
8	9537406	CONNECTOR (FEMALE)
9	9537431	CRIMP CONTACT (MALE)
10	9531742	CRIMP CONTACT (FEMALE)
11	9531643	CONNECTOR (MALE)
12	9607417	HOSE CLAMP

3.1 SOLENOID VALVE

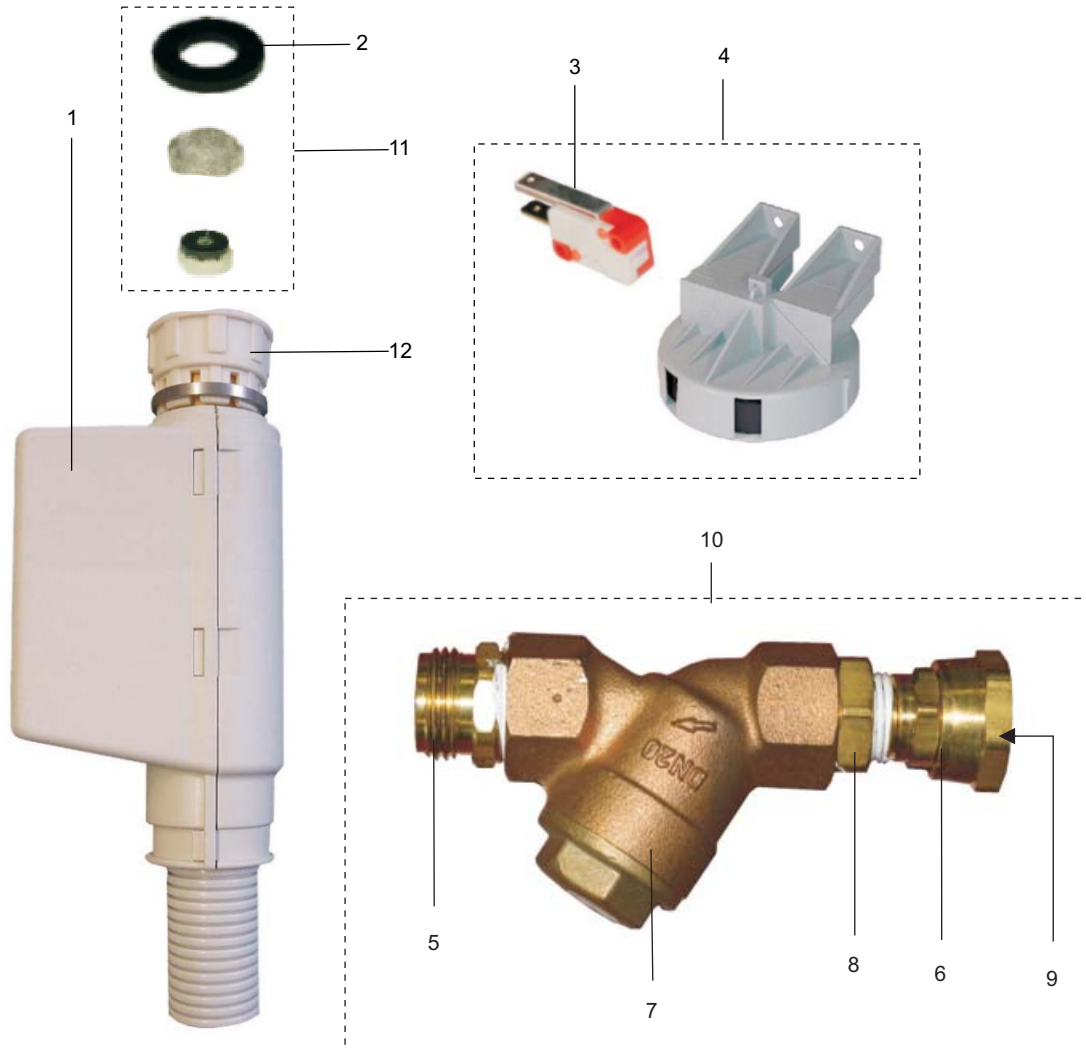

POS.	PART NUMBER	DESCRIPTION
1	9604365 *	AQUASTOP
2	9500321	GASKET
3	9622932	MICROSWITCH
4	9622935	FLOAT SWITCH FOR LEAKS
5	9250127	GARDEN HOSE ADAPTER 3/4" X 1/2" NPT
6	9207228	SWIVEL HOSE CONNECTOR 1/2"NPT
7	0225008	Y-STRAINER BRASS 3/4"
8	9250209	REDUCER BUSHING, BRASS 3/4" X 1/2"
9	9207230	HOSE GASKET
10	9207229	Y-STRAINER ASSEMBLY CPL.
11	9617744 *	AQUASTOP RESTRICTOR KIT (FV40.2)
12	9693544	CONNECTION PIECE GARDEN HOSE THREAD

3.11 AIR GAP

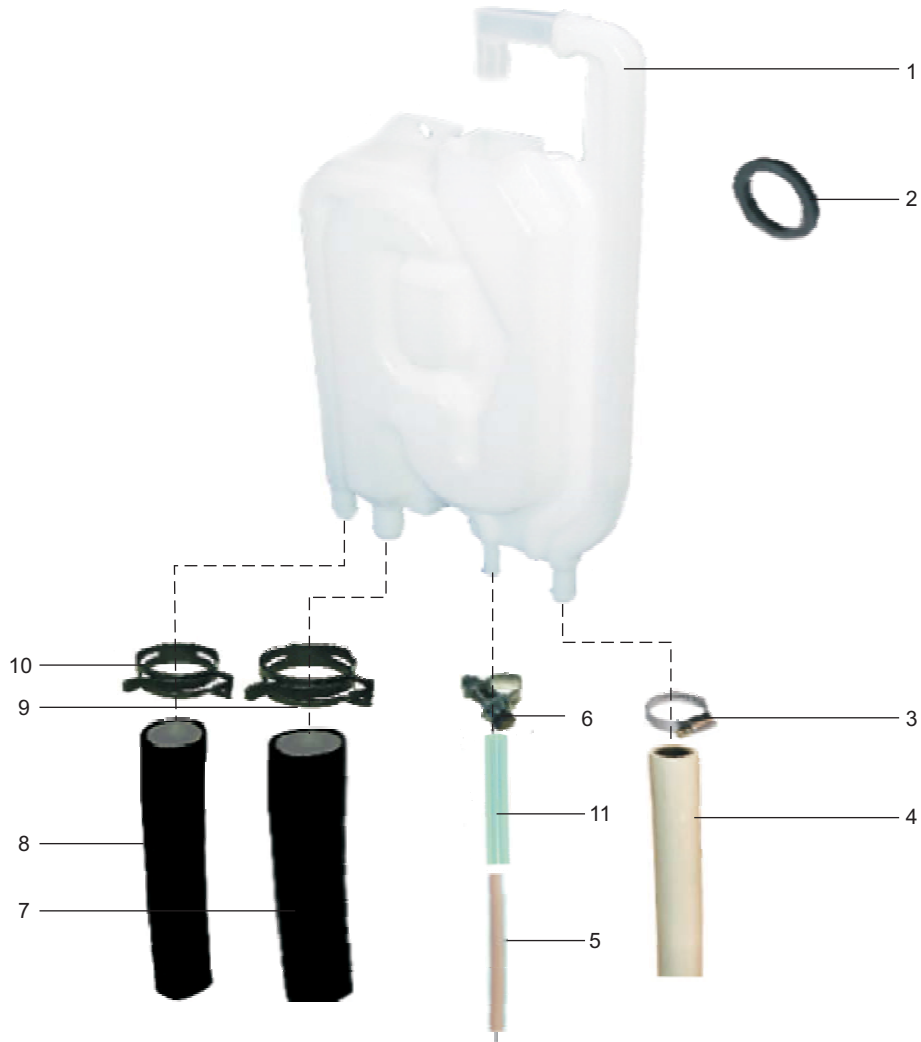

POS.	PART NUMBER	DESCRIPTION
1	9523195	AIR GAP
2	0650076	RUBBER SEAL
3	0233036	HOSE CLAMP
4	9207901	AQUASTOP LINE
5	9207253	HOSE - RED
6	9605930	HOSE CLAMP
7	9607590	HOSE 1/2"
8	9607596	HOSE COUPLING 3/8"
9	9607418	HOSE CLAMP 21 X 12
10	9609462	HOSE CLAMP 17 X 12
11	9207383	CLEAR HOSE ADAPTER 2.5" (MADE FROM 0260007)

4.1 WASH TANK LEVEL CONTROL

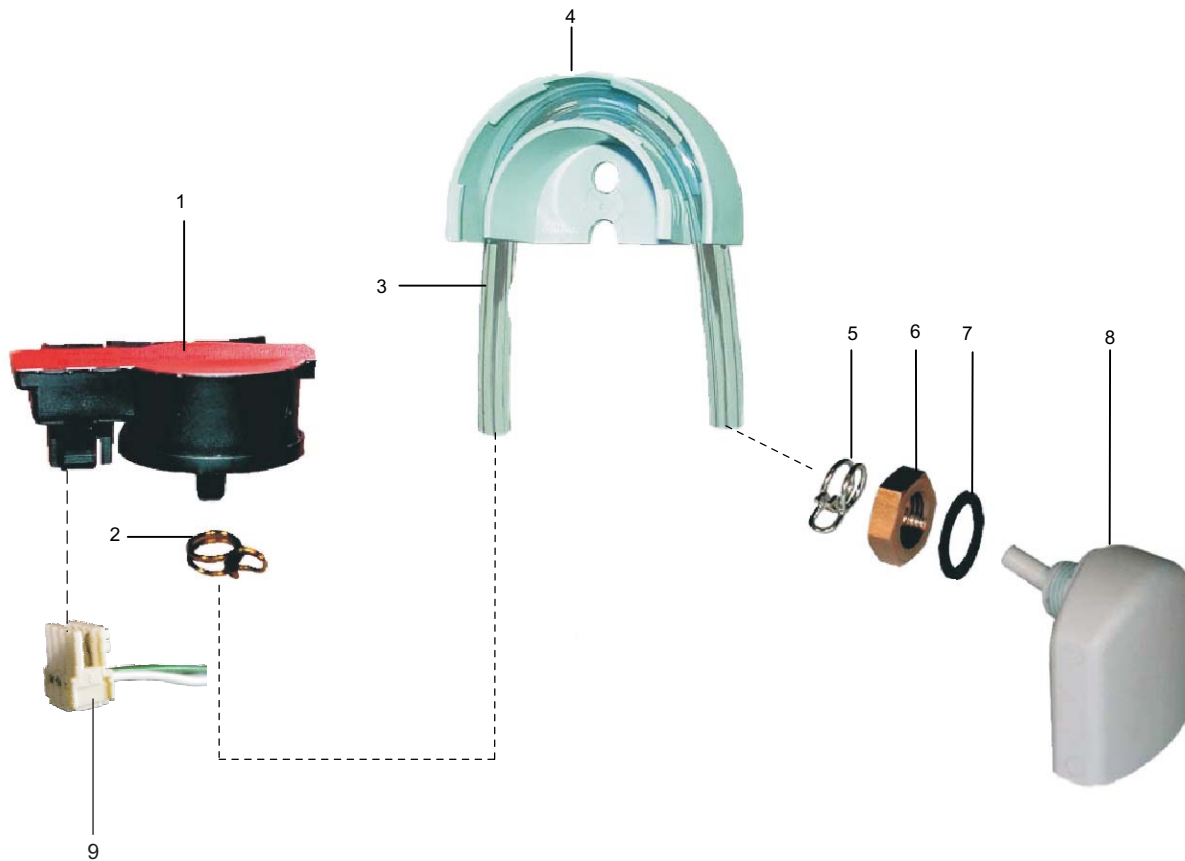

POS.	PART #	DESCRIPTION
1	9537961 *	PRESSURE SENSOR
2	9655080	HOSE CLAMP
3	0260006	HOSE
4	9601265	HOSE HOLDER
5	9655015	HOSE CLAMP
6	9515957	NUT 3/8"
7	9515964	FLAT SEAL
8	9515955	AIR TRAP
9	9538917	PLUG

5.1 BUILT-IN BOOSTER HEATER

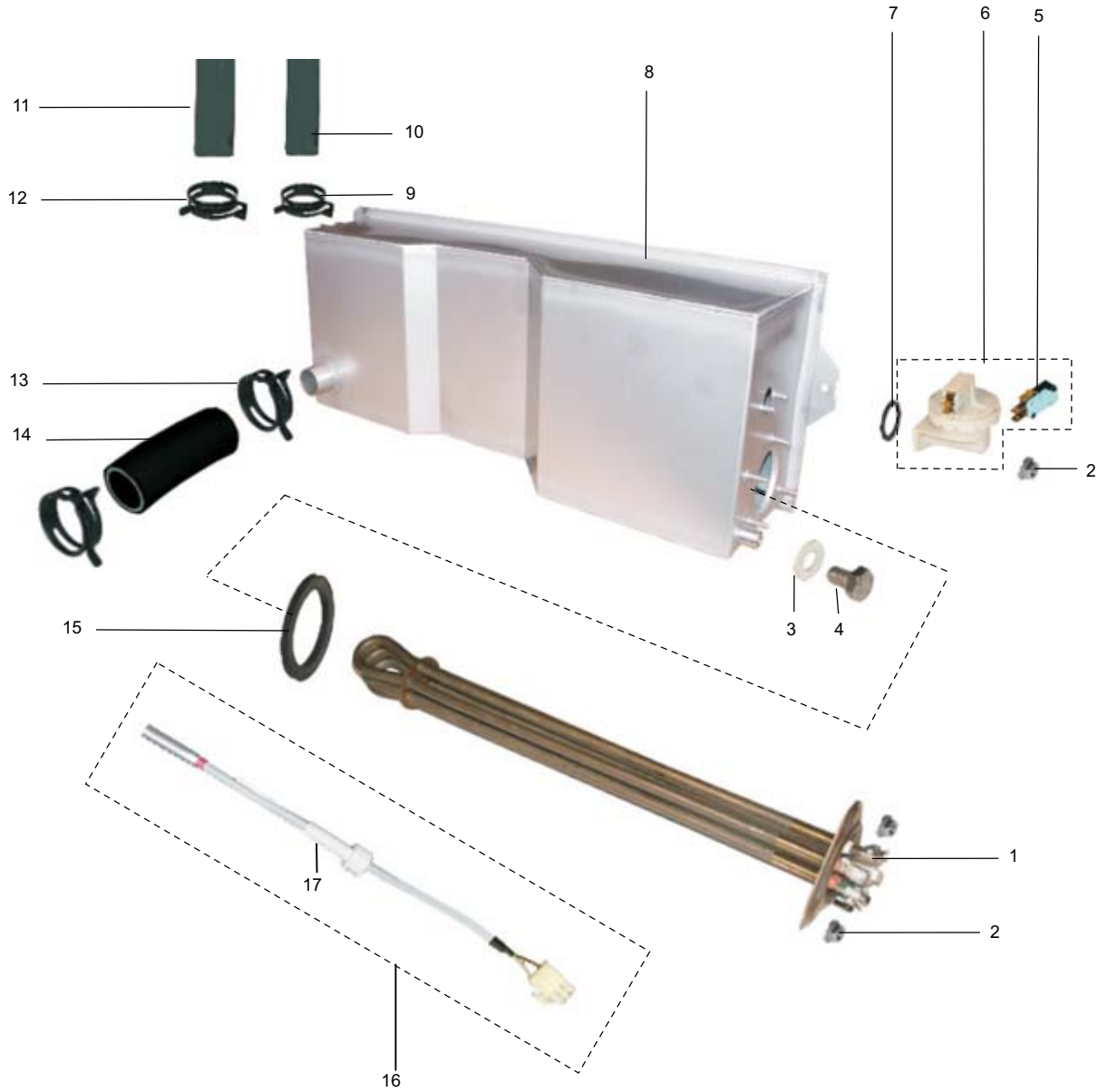



5.1 BUILT-IN BOOSTER HEATER

POS.	PART NUMBER	DESCRIPTION
1	9546195	HEATING ELEMENT, BOOSTER 240V 6.0 KW FOR SERIAL NUMBER < 30003008
1	9546193	HEATING ELEMENT, BOOSTER 240V 4.5 KW FOR SERIAL NUMBER > 30003007
2	0335008	NUT M5
3	0408001	PACKING RING
4	0302006	SCREW M8 X 15
5	0122103	MICROSWITCH
6	9207519 *	BOOSTER LEVEL SWITCH KIT WITH O-RING
7	0401014	O-RING
8	9603367	BOILER HOUSING CPL.
9	9609462	HOSE CLAMP
10	9607596	HOSE 3/8"
11	9607590	HOSE 1/2"
12	9607418	HOSE CLAMP
13	9607416	HOSE CLAMP
14	9005525	HOSE
15	0101176 *	HEATING ELEMENT GASKET
16	9640339 *	TEMPERATURE PROBE ASSEMBLY - BOOSTER TANK
16	9642324	TEMPERATURE PROBE ASSEMBLY WITH QUICK DISCONNECT UPGRADE
17	9634739	TEMPERATURE PROBE
18	9639301	CABLE CLIP

6.1 WASH TANK HEATING
FOR MACHINES WITH SERIAL NUMBER < 30003007

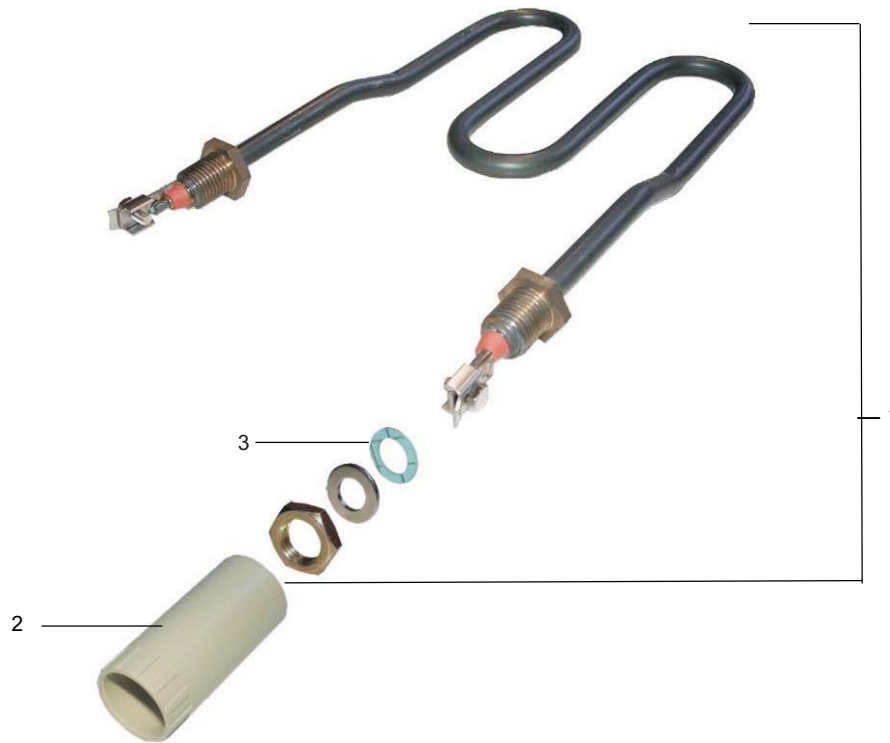

POS.	PART NUMBER	DESCRIPTION
1	9546105 *	HEATING ELEMENT
2	9548754	PROTECTION AGAINST CONTACT
3	0408008	PACKING

6.1 WASH TANK HEATING

FOR MACHINES WITH SERIAL NUMBER \geq 30003008

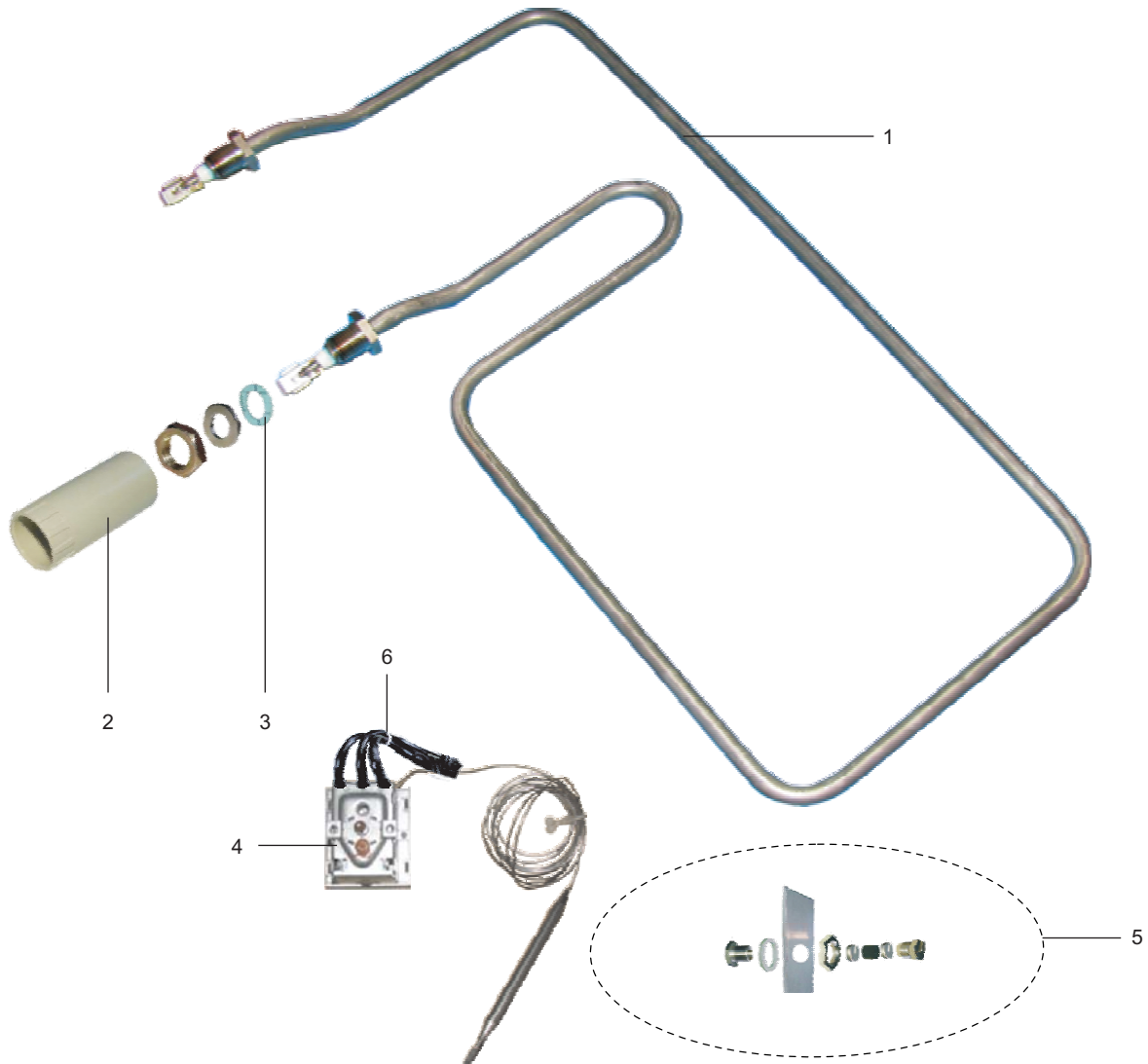

POS.	PART NUMBER	DESCRIPTION
1	9663154 *	HEATING ELEMENT 200-240V 4.0 KW ENERGY STAR
2	9548754	PROTECTION AGAINST CONTACT
3	0408008	PACKING
4	9675130 *	HI LIMIT THERMOSTAT
5	9546760	DUCT OF SEALS
6	9208245 *	HIGH LIMIT WIRE HARNESS WITH CONNECTORS

7.1 CHEMICAL DOSING

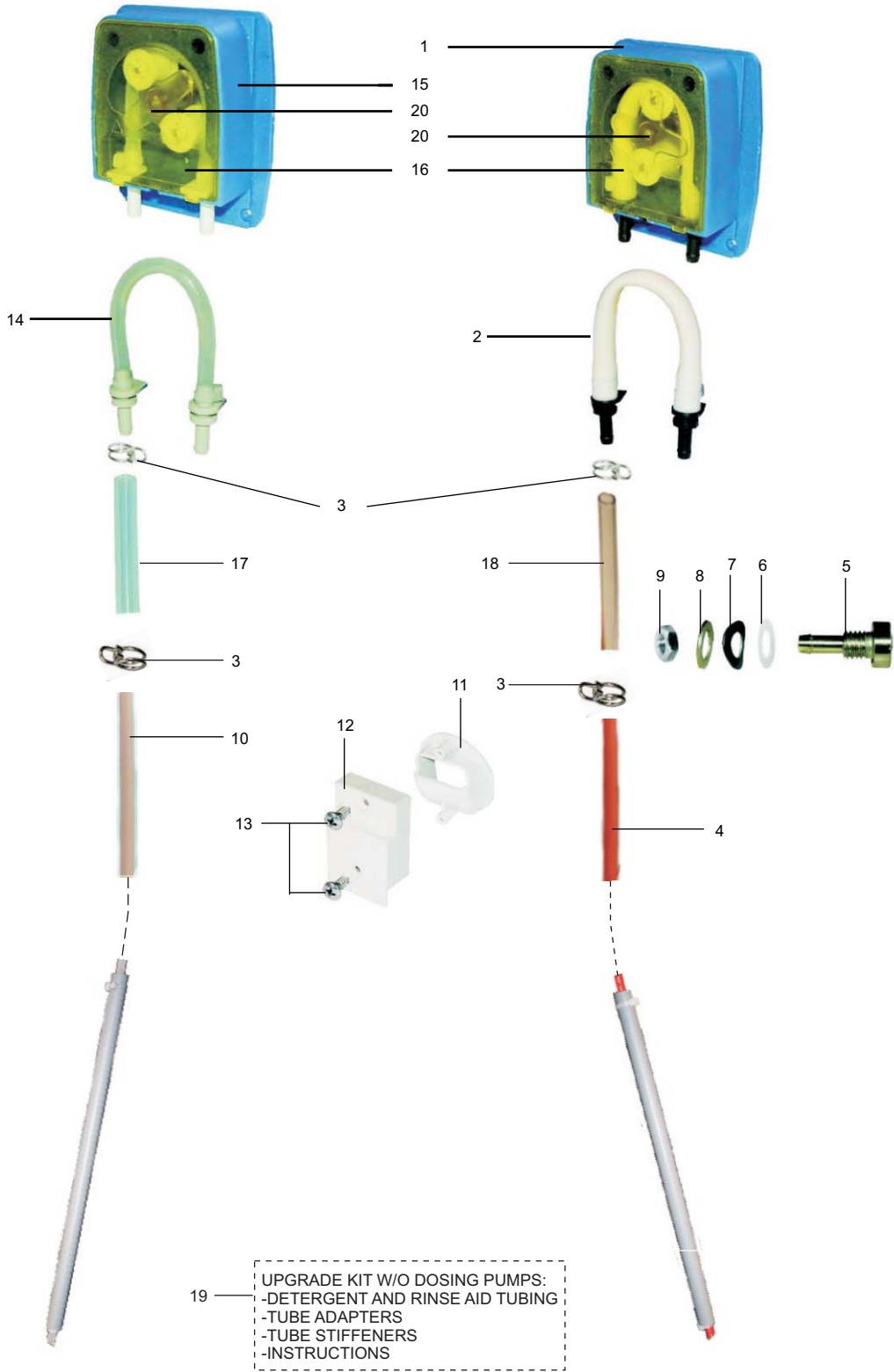



7.1 CHEMICAL DOSING

POS.	PART NUMBER	DESCRIPTION
1	9544292	DETERGENT DOSING PUMP CPL.
2	9511675 * V	DETERGENT SQUEEZE TUBE
3	9655015	HOSE CLAMP
4	9207252	DETERGENT TUBING RED
5	9541142	HOSE CONNECTION
6	9603787	FLAT PACKING
7	9603790	SPRING WASHER M10
8	0340005	WASHER
9	0335019	NUT M10
10	9207253	RINSE AID TUBING WHITE
11	9514088	HANDLE
12	9514089	HANDLE
13	0330022	SCREW
14	9544088 * V	RINSE AID SQUEEZE TUBE
15	9544293	RINSE AID DOSING PUMP CPL.
16	9203579	YELLOW DOSING PUMP COVER
17	9207382	BLUE HOSE ADAPTER 2.5" (MADE FROM 9538712)
18	9207383	CLEAR HOSE ADAPTER 2.5" (MADE FROM 0260007)
19	9207500 * V	CHEMICAL TUBING KIT
20	9533450	ROTOR, CHEMICAL PUMP



7.11 CHEMICAL PICKUP TUBES

FOR MACHINES SHIPPED BEFORE 4/28/2008 SERIAL NUMBER < 10113866	FOR MACHINES SHIPPED BETWEEN 4/28/2008 - 02/09/2010 SERIAL NUMBER > 10113866 AND < 30002244	FOR MACHINES SHIPPED AFTER 2/09/2010 SERIAL NUMBER ≥ 30002244
		

POS.	PART NUMBER	DESCRIPTION
1	8005393	SUCTION LANCE
2	9207250	TUBE STIFFENER
3	9666201	DETERGENT SUCTION LANCE WITH LEVEL SENSOR - 5 GALLON BUCKET
3	9686200	DETERGENT SUCTION LANCE WITH LEVEL SENSOR - 1 GALLON BUCKET

7.12 EXTERNAL DISPENSER TERMINAL BLOCK

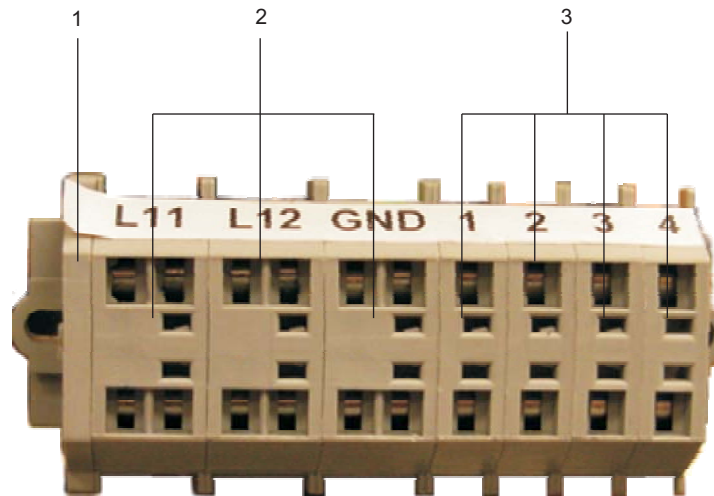

POS.	PART NUMBER	DESCRIPTION
1	0153037	DISTANCE PLATE
2	0153039	CLAMP 2.5MM
3	0153038	CLAMP
	0153099	HOLDER BRACKET

8.1 PUMPED DRAIN SYSTEM

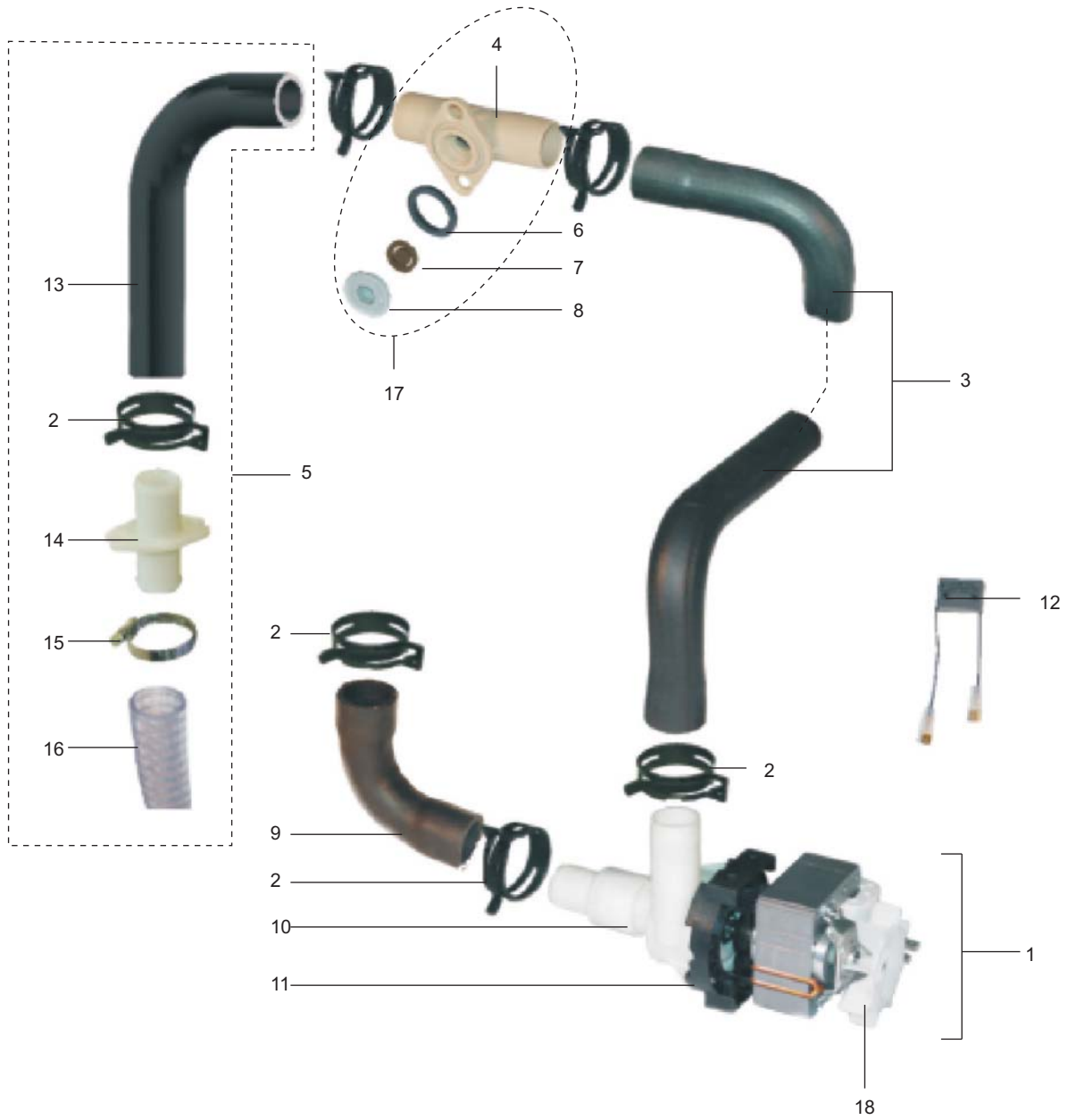



8.1 PUMPED DRAIN SYSTEM

POS.	PART NUMBER	DESCRIPTION
1	9207451 *	DRAIN PUMP KIT WITH DRIP SHIELD
	9207339	DRIP SHIELD
2	9607417	HOSE CLAMP
3	9517067	HOSE
4	9515230	VENT VALVE
5	9207373	DRAIN HOSE KIT
6	0401016	O-RING 21 X 2
7	9653648 * V	VALVE FLAP
8	9515231	SCREW
9	9514680	HOSE
10	9523849	PUMP HOUSING
11	9523850	O-RING
12	9550030	CAPACITOR
13	9641551	HOSE
14	9635791	DRAIN HOSE ADAPTER
15	0233045	HOSE CLAMP
16	9500288	DRAIN HOSE
17	9653649	DRAIN VENT VALVE ASSEMBLY
18	9507413	FAN, DRAIN PUMP

9.1 ELECTRONIC CONTROL

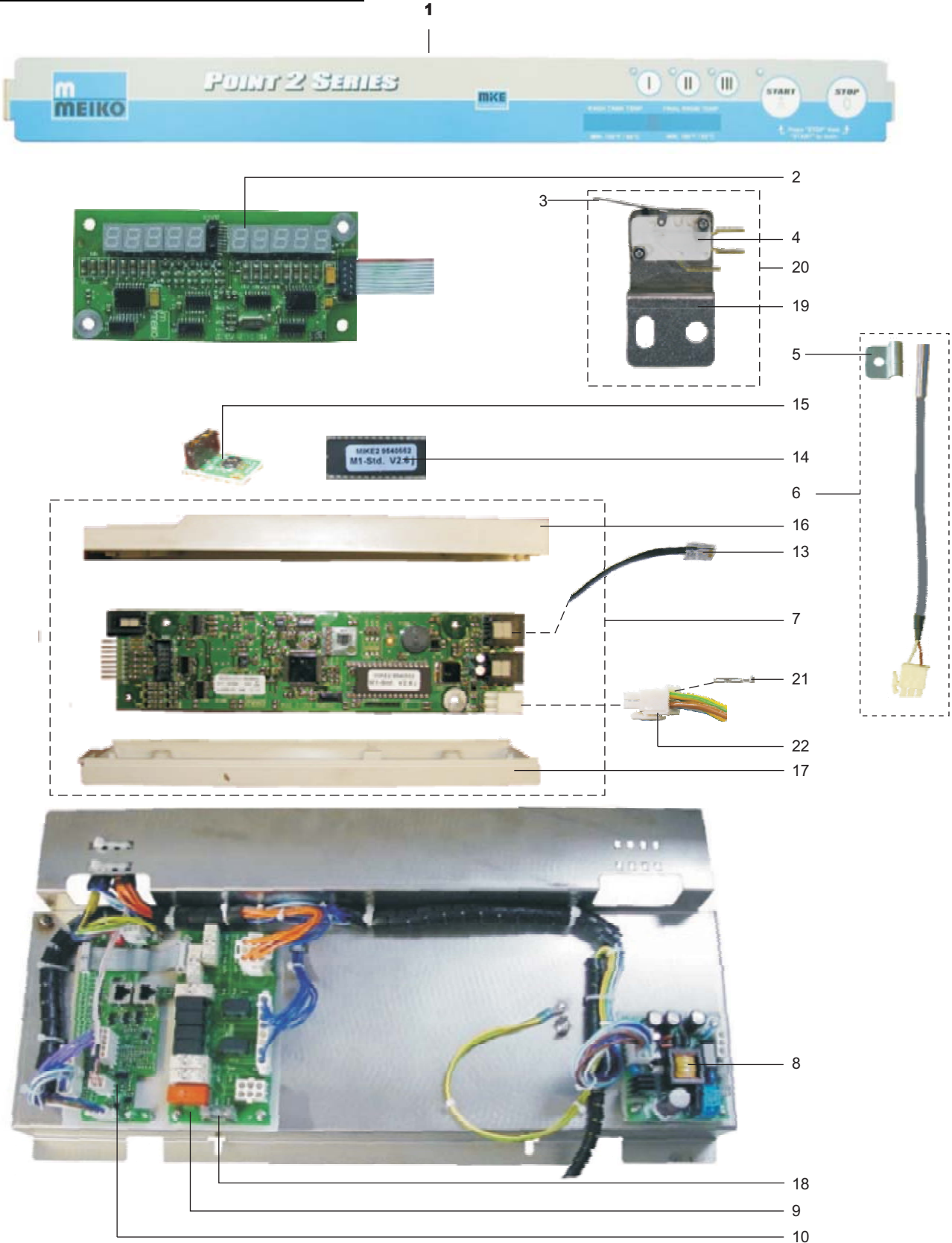

9.1 ELECTRONIC CONTROL

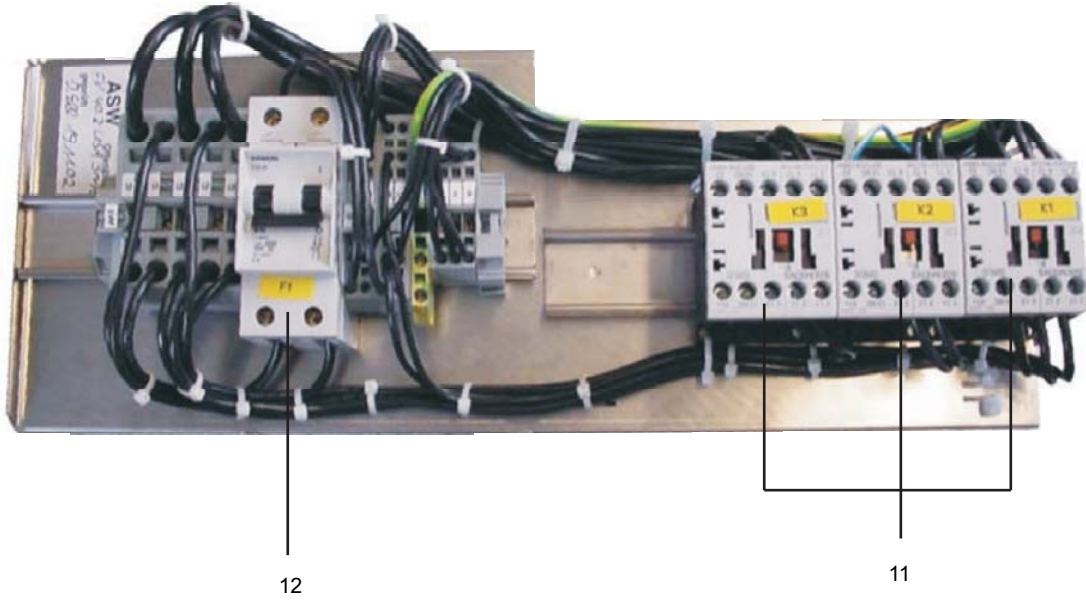



9.1 ELECTRONIC CONTROL

POS.	PART NUMBER	DESCRIPTION
1	9207357 *	TOUCHPAD KIT
2	9542049	DISPLAY PCB WITH HOUSING
	9541916	DISPLAY PCB HOUSING
3	0122106 *	LEVER
4	0122103 *	MICROSWITCH
5	9639363	SUPPORT FOR TEMPERATURE SENSOR
6	9640338 *	TANK TEMPERATURE SENSOR KIT
6	9649173	TANK TEMPERATURE SENSOR KIT WITH WIRE NUTS
7	9541525 *	CPU BOARD ASSEMBLY
8	9626264 *	POWER PACK
9	9618195 *	OUTPUT RELAY CIRCUIT BOARD
10	9618197 *	INPUT CIRCUIT BOARD
11	9547516 *	CONTACTOR
12	9542512	CIRCUIT BREAKER 10A
13	9635756	COMMUNICATION RIBBON CABLE
14	9604262	EPROM - FOR UNITS SHIPPED AFTER FEBRUARY 2010 NOTE: MUST PROVIDE SERIAL NUMBER WHEN ORDERING
14	9540552	EPROM - FOR UNITS SHIPPED BEFORE FEBRUARY 2010 NOTE: MUST PROVIDE SERIAL NUMBER WHEN ORDERING
15	9615751	EE-PROM NOTE: MUST PROVIDE SERIAL NUMBER WHEN ORDERING
16	9541139	CPU HOUSING TOP
17	9541141	CPU HOUSING BOTTOM
18	9611761	FUSE 16A 20MM
19	9520673	MOUNTING BRACKET
20	9520689	DOOR SWITCH ASSEMBLY
21	9539160	BUSH MOLEX PIN
22	9531644	PLUG-IN ELEMENT

9.11 PLUGS AND PINS

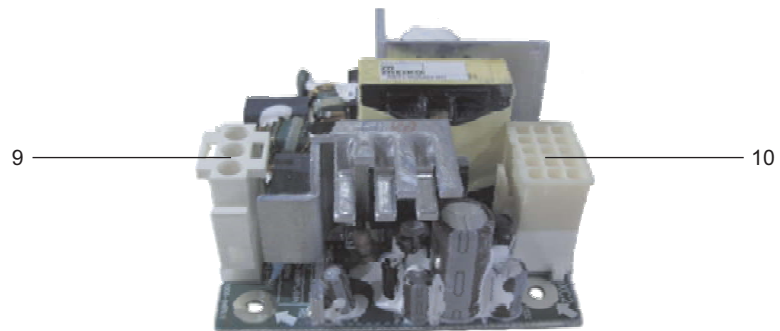
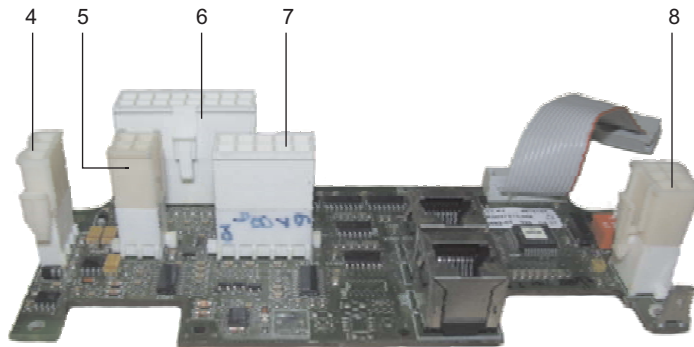
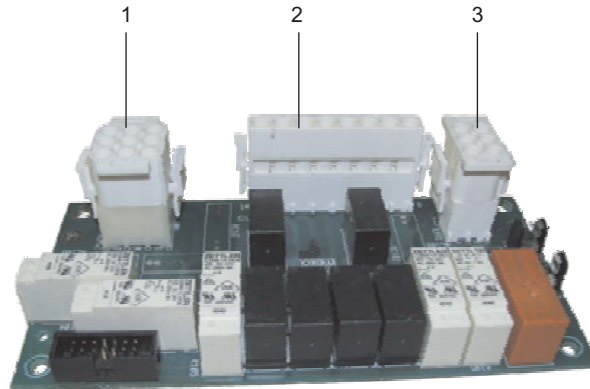



9.11 PLUGS AND PINS

POS.	PART NUMBER	DESCRIPTION
1	9532652	PLUG
1	9532535	MOLEX PIN
2	9537402	PLUG
2	9532535	MOLEX PIN
3	9532651	PLUG
3	9532535	MOLEX PIN
4	9537403	PLUG-IN ELEMENT
4	9539160	MOLEX PIN
5	9531644	PLUG-IN ELEMENT
5	9539160	MOLEX PIN
6	9537512	JACK HOUSING
6	9539160	MOLEX PIN
7	9537511	JACK HOUSING
7	9539160	MOLEX PIN
8	9531603	PLUG-IN ELEMENT
8	9539160	MOLEX PIN
8	9542753	MOLEX PIN
9	9532654	PLUG
9	9532535	MOLEX PIN
10	9537404	PLUG-IN ELEMENT
10	9539160	MOLEX PIN

9.12 ELECTRICAL SUPPLY TERMINAL BLOCK

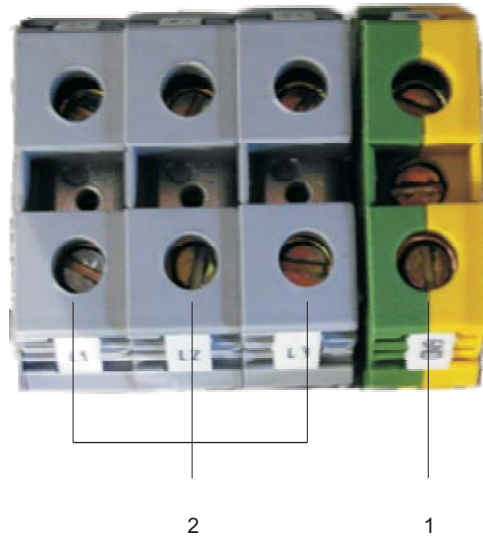

POS.	PART NUMBER	DESCRIPTION
1	0153287	GROUND CLAMP
2	0153285	CLAMP

10.1 PANEL / EXTERNAL PARTS

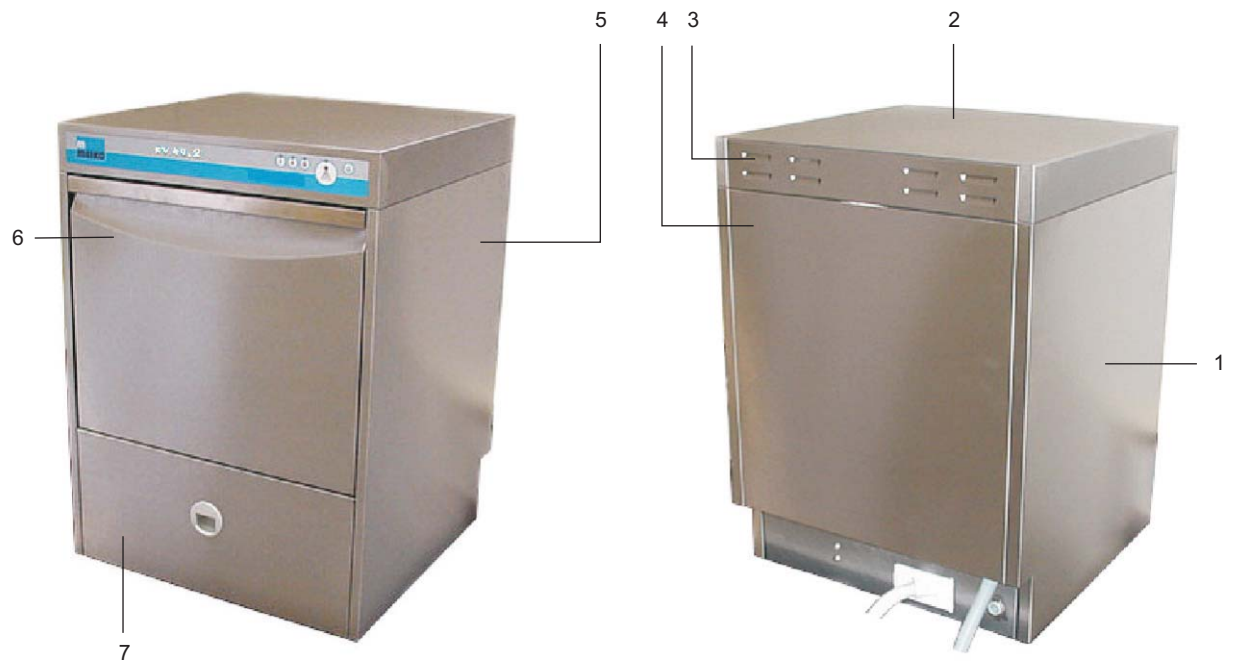

POS.	PART NUMBER	DESCRIPTION
1	9546902-03	LEFT SIDE PANEL
2	9006627	COVER
3	9550066	SUPPORT BRACKET FOR COVER
4	9516569	REAR PANEL
5	9546902-04	RIGHT SIDE PANEL
6	9514190	DOOR CPL.
7	9552510	FRONT SHEET
	0330020	SCREW FOR LOWER FRONT PANEL AND REAR PANEL
	0360061	SPEED CLIP FOR LOWER FRONT PANEL AND REAR PANEL SCREW

10.1 PANEL / EXTERNAL PARTS

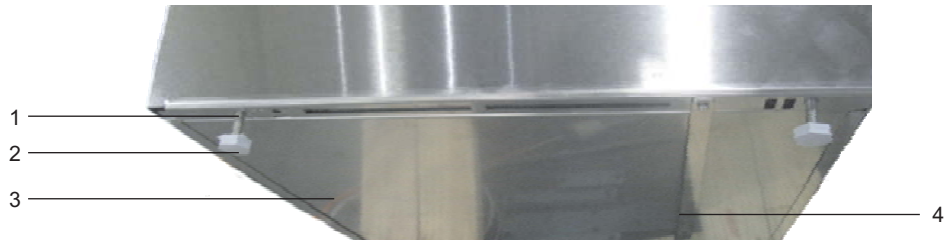

POS.	PART NUMBER	DESCRIPTION
1	0302014	BOLT FOR FOOT M8 X 100MM
	9500060	CAGE NUT FOR FOOT BOLT
2	9545688	PLASTIC FOOT
3	9006635	FLOOR PAN
4	9658173	FRAME STRAP
5	9675934 V	DOOR SEALING PROFILE
6	0306115	SCREW - TOP PANEL
	9533936	SPEED CLIP FOR SCREW - TOP PANEL

10.11 DOOR COUNTERWEIGHT

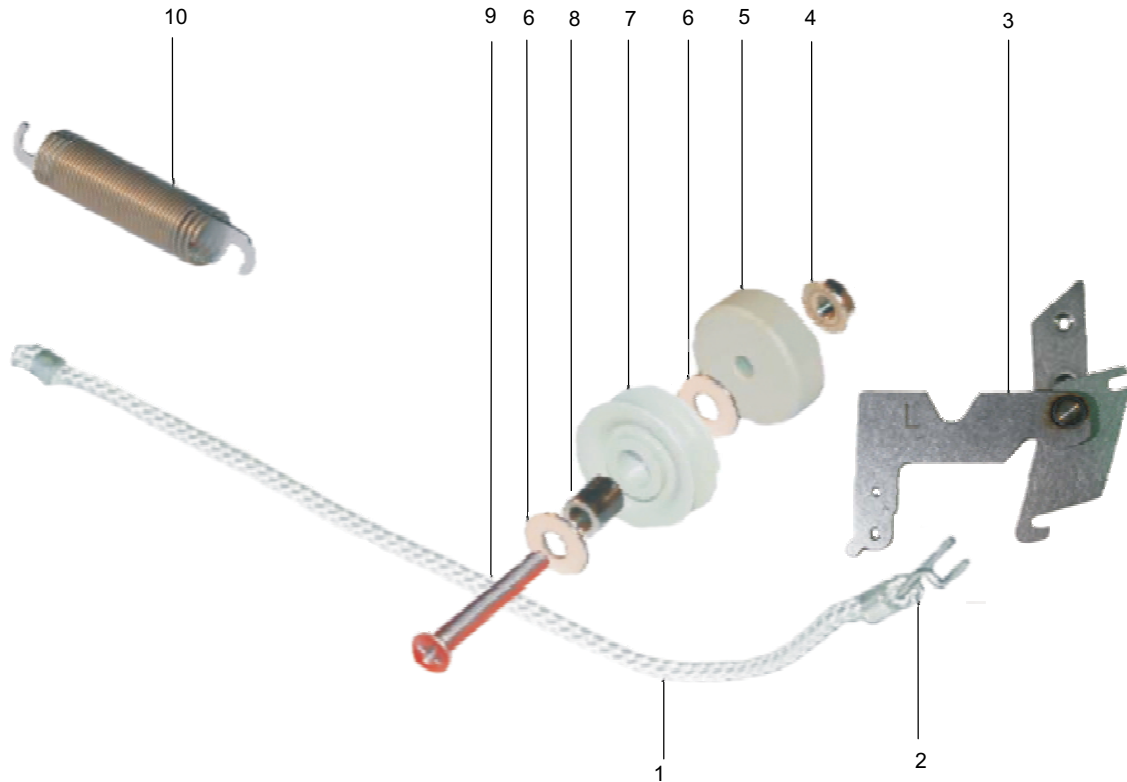

POS.	PART NUMBER	DESCRIPTION
1	0435151 V	TRACTION CABLE
2	0435150	TRACTION CABLE HOOK
3	9516557-04	DOOR HINGE LEFT CPL.
3	9516557-03	DOOR HINGE RIGHT CPL.
4	0335008	NUT M5
5	9520727	DISTANCE ROLL
6	0340020	WASHER
7	9600964	CABLE ROLLER
8	9520736	BEARING RING
9	0306122	SCREW M5 X 30
10	9521764	TENSION SPRING CPL.



11.1 DRAIN WATER TEMPERING KIT

OPTIONAL FOR S/N: ≥ 30001694

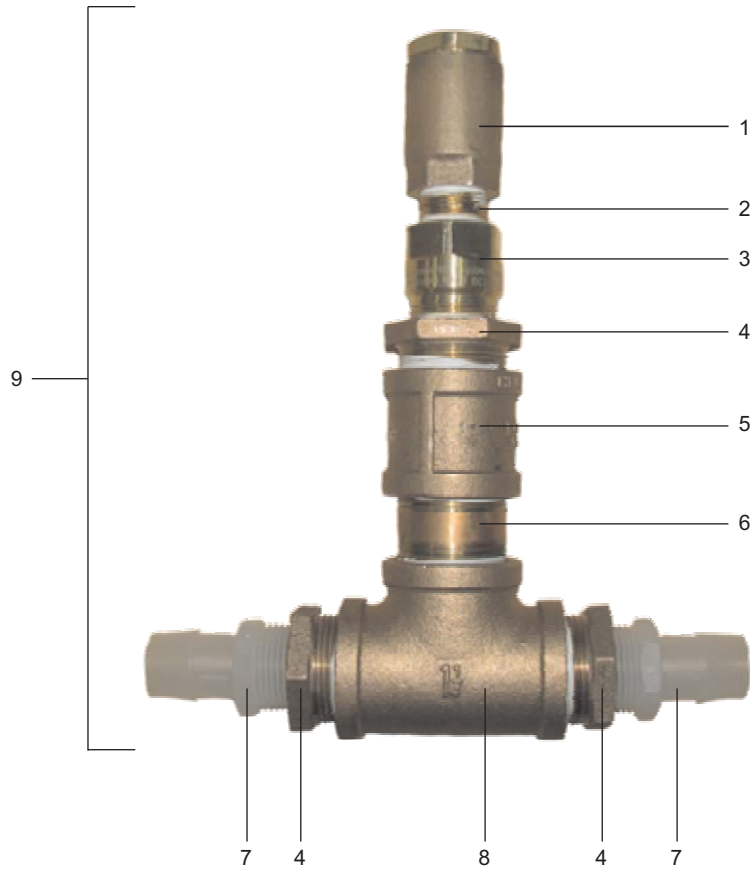

POS.	PART NUMBER	DESCRIPTION
1	9207587	DOUBLE CHECK VALVE
2	9250036	CLOSE NIPPLE, BRASS 3/4" NPT
3	9207588	TEMPERING VALVE 3/4"
4	9207862	REDUCER BUSHING, BRASS 1-1/4" NPT X 1" NPT
5	9207860	COUPLER, 1-1/4" NPT
6	9208155	CLOSE NIPPLE, BRASS 1-1/4" NPT
7	9250208	HOSE FITTING 1"
8	9207863	TEE, BRASS 1-1/4" NPT
9	9207591	DRAIN WATER TEMPERING KIT

11.1 DRAIN WATER TEMPERING KIT
 OPTIONAL FOR S/N: < 30001694

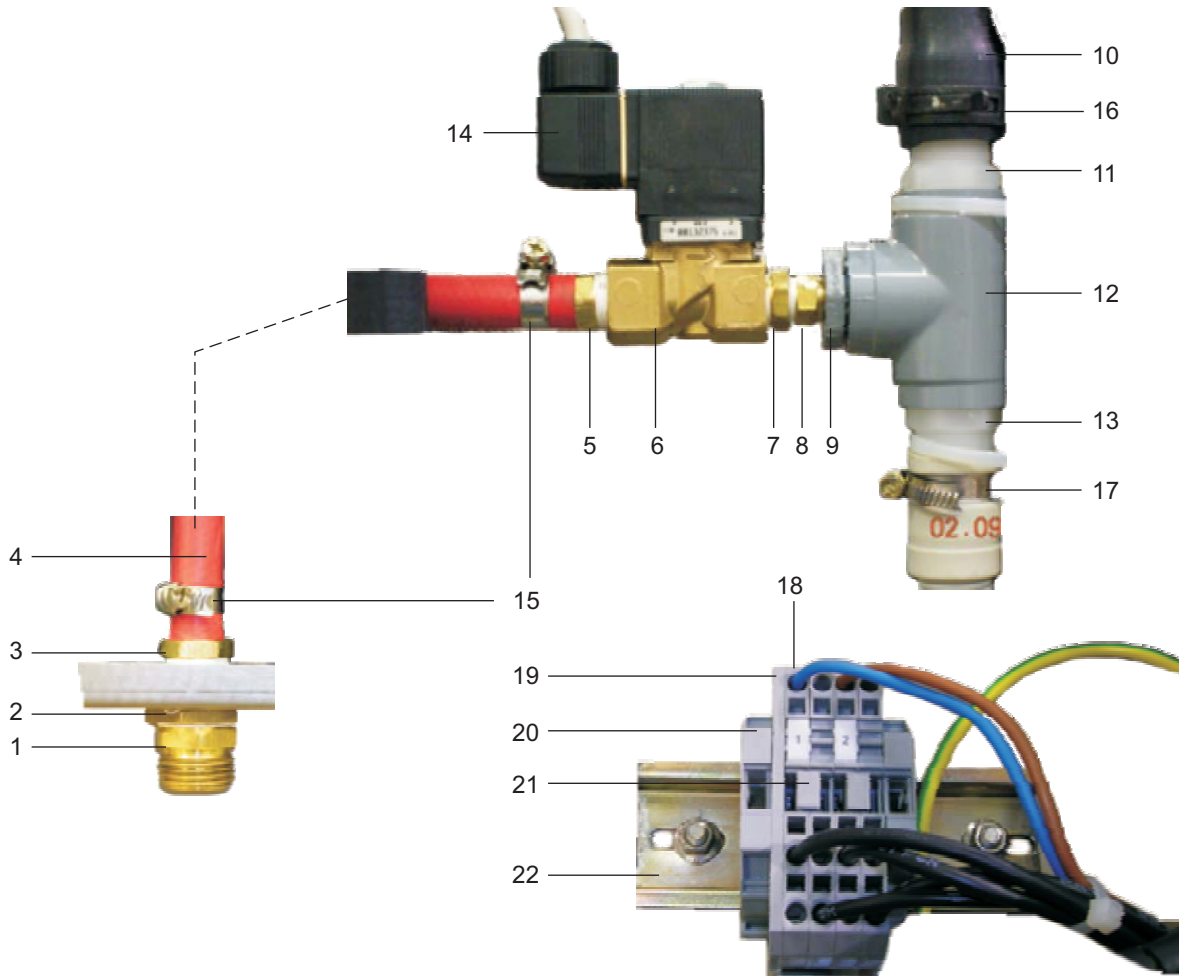



11.1 DRAIN WATER TEMPERING KIT

OPTIONAL FOR S/N: < 30001694

POS.	PART NUMBER	DESCRIPTION
1	9250127	GARDEN HOSE ADAPTER 3/4" X 1/2"NPT
2	8660463	BRASS NUT
3	9250172	HOSE BARB FITTING 3/8" HOSE X 1/2"MALE NPT
4	9207103	HOSE 3/8"
5	9250173	HOSE BARB FITTING 3/8" HOSE X 3/8" MALE NPT
6	9306463	SOLENOID VALVE 3/8" 240VAC
7		REDUCER, BRASS 3/8" X 1/4"
8	9250107	CHECK VALVE, BRASS 1/4"
9	9207065	REDUCER BUSHING 3/4" X 1/4" CPVC
10	9517067	HOSE
11	9250130	HOSE BARB 3/4" X 1" PVDF
12	9250126	TEE 3/4" CPVC SCHEDULE 80
13	9250111	HOSE BARB 3/4" X 3/4" PVDF
14	0113029	MINIATURE F PLUG
15	9609462	HOSE CLAMP 17 X 12
16	9607417	HOSE CLAMP 30 X 12
17	9616022	HOSE CLAMP 28 X 12
18	0153040	2-POSITION TERMINAL BLOCK
19	0153070	END PIECE
20	0153098	FINAL ANGLE
21	0153090	JUMPER
22	0153107	RAIL

11.1 ELECTRICAL SUPPLY POWER CORD KITS

OPTIONAL

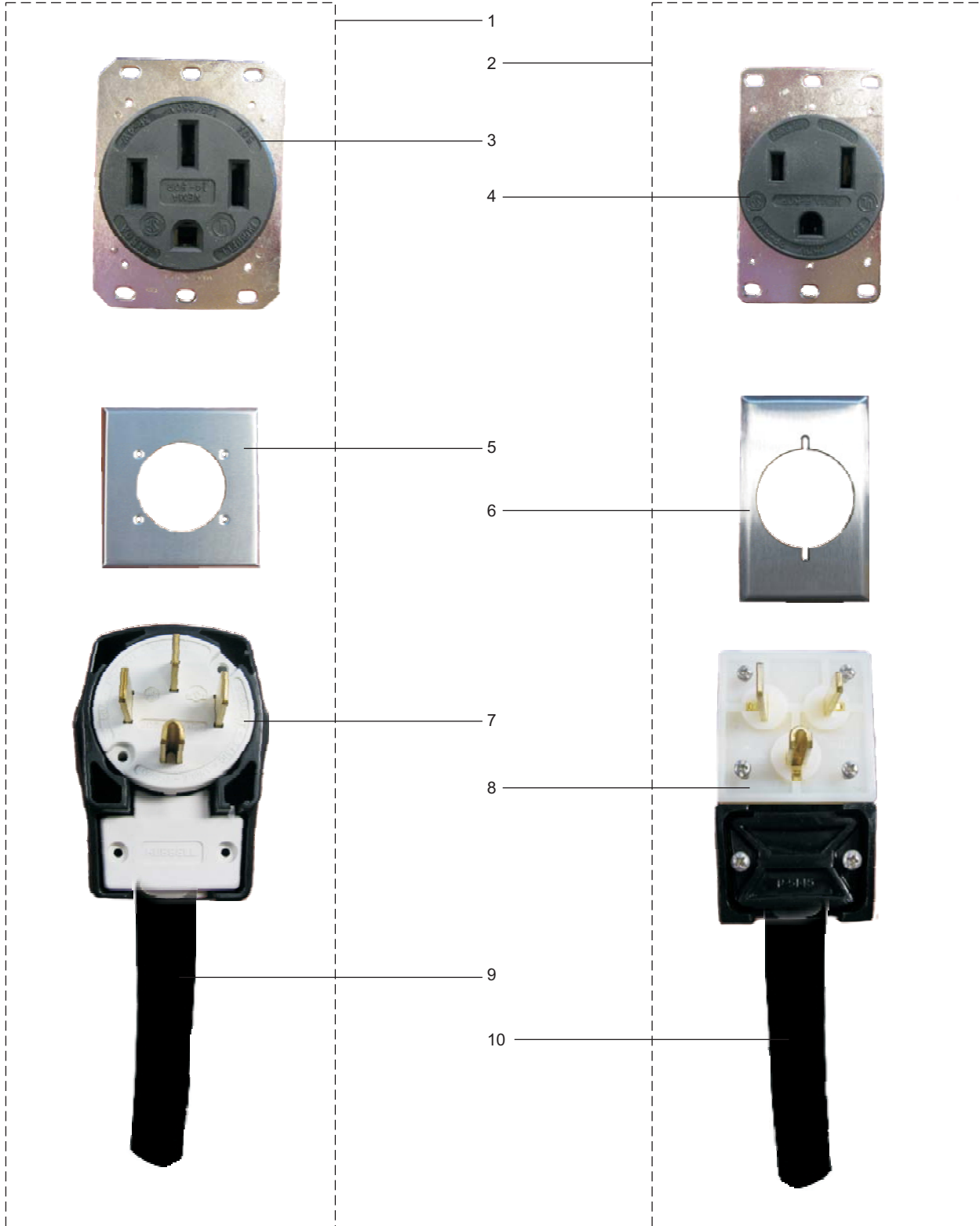



11.1 ELECTRICAL SUPPLY POWER CORD KITS

OPTIONAL

POS.	PART NUMBER	DESCRIPTION
1	9200006	POWER CORD KIT 208V - 240V 3-PHASE NEMA 14-50
2	9200005	POWER CORD KIT 208V - 240V 1-PHASE NEMA 6-50
3	9201009	RECEPTACLE 3-PHASE NEMA 14-50R
4	9201005	RECEPTACLE 1-PHASE NEMA 6-50R
5	9201012	WALL PLATE 3-PHASE OUTLET
6	9201007	WALL PLATE 1-PHASE OUTLET
7	9201010	PLUG 3-PHASE NEMA 14-50P
8	9201006	PLUG 1-PHASE NEMA 6-50P
9	9201011	CABLE 3-PHASE 4-WIRE
10	9201008	CABLE 1-PHASE 3-WIRE



The clean solution

MEIKO

1349 Heil Quaker Blvd.

La Vergne, TN 37086

Phone: (615) 399-6600

(800) 55-MEIKO

Fax: (615) 399-6620
