





































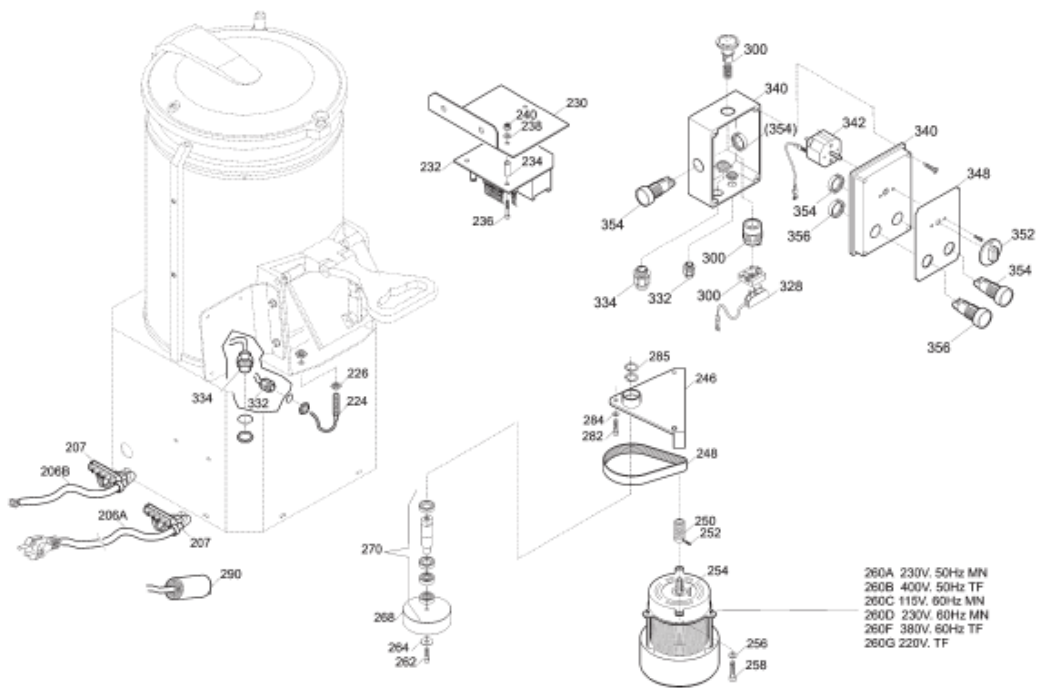















## PP 8 EXPO CE















	REF	ART	COD
	02	DECKEL FUER KARTOFFELSCHALMASCH.	RG04002
	04	KNOB FOR COVER_POTATO PEELER PP EX	RG04004
	08	FIXING SCREW FOR KNOB_P.PEELER EXPO	RG04008
	12	FAUCET FOR POTATO PEELER EXPO	RG04012
	14	RING - COVER POTATO PEELER PP8	RG08014
	16	SIDE ABRASIVE PP 8 EXPO	RG08016
	18	CARCASSA ACCIAIO INOX PLP EX 8	RG08018
	20	NUT FOR POTATO PEELER EXPO	RG04020
	22	FIXING SCREW FOR PP EXPO	RG04022
	24	WASHER FOR PP EXPO	RG04024
	25	PEELING DISC FOR PP 4/8 EXPO	RG04025
	30	CONTROLS SUPPORT _ PP EXPO	RG04030
	32	DADO PLP EX	RG04032
	34	RONDELLA PLP EX	RG04034
	36	FUORI PRODUZIONE-OUT OF PRODUCTION	00-OUT
	38	HANDLE SHAFT _ PP 8-15 EXPO	RG08038
	40	LEVER _ PP 8-15 EXPO	RG08040
	42	SHAFT _ PP EXPO	RG08042
	46	FUORI PRODUZIONE-OUT OF PRODUCTION	00-OUT
	48	FLAT PLATE _ PP EXPO	RG08048
	50	DOOR _ PP 8-15 EXPO	RG08050
	52	DOOR GASKET _ PP 8 EXPO	RG08052
	54	MAGNETIC SENSOR _ PP 8-15 EXPO	RG08054
	56	SHAFT FOR PP EXPO	RG08056
	58	WASHER	RG04058

	60	SCREW	RG08060
	62	SCREW	RG04062
	64	WASHER	RG04064
	68	SCREW	RG08068
	70	SCREW	RG04070
	74	FOOT BASE - PP4/PP8	RG04074
	76	PIEDINI CON ALETTA PLP EX 4/8	RG04076
	80	PIEDINI PLP EX 4/8	RG04080
	82	FONDO PLP EX 4/8	RG04082
	84	DRAIN PIPE FOR POTATO PEELER EXPO	RG04084
	90	SCREW	RG04090
	92	FASCIA LATERALE PLP EX 8	RG08092
	94	MICROSWITCH FOR PP EXPO	RG04094
	96	SCREW	RG04096
	98	NUT	RG04098
	112	FIXING SCREW FOR COVER_P.PEELER EXP	RG04112
	114	FIX.WASHER FOR COVER_P.PEELER EXPO	RG04114
	120	FIXING NUT FOR HINGE_P.PEELER EXPO	RG04120
	122	FIXING SCREW FOR MAGNET_P.PEELER EX	RG04122
	124	FIX.WASHER FOR MAGNET_P.PEELER EXPO	RG04124
	126	MAGNET-HOLDER FOR POTATO PEELER EX	RG04126
	128	MAGNETE X BOCCA ATHOS	IV5823050



**PP 8 EXPO CE**

	REF	ART	COD
	206A	1-PH POWER CORD FOR P.PEELER EXPO	RG04206A
	206B	CAVO ALIMENTAZIONE TF PLP EX	RG04206B
	207	MORSETTIERA CORTA PLP EX	RG04207
	224	MAGNETIC MICROSWITCH PPEXPO	RG04224
	226	NUT FOR MICROSWITCH	RG04226
	230	SUPPORTO SCHEDA COMANDO PLP EX	RG04230
	232	CIRCUIT BOARD 220/50 _ PP4-8-15 EXP	RG04232
	234	SPACER PP 4-8-15 EXPO	RG04234
	236	FIXING SCREW PP 4-8-15 EXPO	RG04236
	238	RONDELLA PLP EX	RG04238
	240	DADO PLP EX	RG04240
	246	MOTOR SUPPORT FOR PP 8 EXPO	RG08246
	248	RIEMEN FUER KARTOFFELSCHALER	RG08248
	250	PULLEY_SMALL PP 8 EXPO	RG08250
	252	PULLEY INSERT PP 8 EXPO	RG08252
	254	MOTOR INSERT PP 8 EXPO	RG08254
	256	WASHER FOR PP 4-8 EXPO	RG04256
	258	SCREW FOR PP 4-8 EXPO	RG04258
	260C	MOTORE MN 115V/60 HZ PLP EX 8	RG08260C
	260A	MOTOR 230/50/1 FOR PP 8 EXPO	RG08260A
	260D	MOTOR 230/60/1 FOR PP8	RG08260D
	260G	MOTORE TF 220 PLP EX 8	RG08260G
	260F	MOTORE TF 380V/60 HZ PLP EX 8	RG08260F
	260B	MOTOR 400V/50 HZ FOR PP 8 EXPO	RG08260B

	262	SCREW FOR PP 8 EXPO	RG08262
	264	WASHER FOR PP 8 EXPO	RG08264
	268	PULLEY FOR PP 8 EXPO	RG08268
	270	MITNEHMER SCHLEIFSCHEIBE PP8-15EX	RG08270
	282	VITE PLP EX 8	RG08282
	284	RONDELLA PLP EX 8	RG08284
	285	INNEURING FUER AUFSCH.	19330301
	290	KONDENSATOR PP8-15EXPO	RG08290
	300	EMERGENCY STOP BUTTON FOR BONE SAW	LF1034002
	328	EMERGENCY BUTTON CONTACT P/PEELER	RG04328
	332	STRAIN RELIEF FOR POTATO PEELER	RG04332
	334	STRAIN RELIEF FOR POTATO PEELER	RG04334
	340	PCB BOX FOR POTATO PEELER	RG04340
	342	TIMER+KNOB FOR PP EXPO	RG04342
	348	BUTTON TIMER FOR POTATO PEELER	RG04348
	352	TIMERGRIFF PP EXPO	RG04352
	354	STOP BUTTON _ SO/TC	LF1010705
	356	ON BUTTON _ SO/TC 22-32/IP	LF1034001