

- Ø 0.80 - 01188
- Ø 0.90 - 00391
- Ø 0.95 - 00980
- Ø 1.05 - 00979
- Ø 1.15 - 01189
- Ø 1.20 - 01636
- Ø 1.40 - 01192
- Ø 1.45 - 01637
- Ø 1.50 - 01193
- Ø 1.55 - 01194
- Ø 1.85 - 01638
- Ø 1.90 - 01044
- Ø 2.00 - 01197
- Ø 2.05 - 01639

3.5kW - 01671  
6kW - 01672

3.5kW - 01673  
6kW - 01674

3.5kW - 01675  
6kW - 01676

01140

- Ø 0.20 - 00435
- Ø 0.35 - 00436

00118

01677

- Ø 0.40 - 01640
- Ø 0.55 - 01208
- Ø REG.- 50022

01114 BLU  
01344 GREY

01062 BLU  
01345 GREY

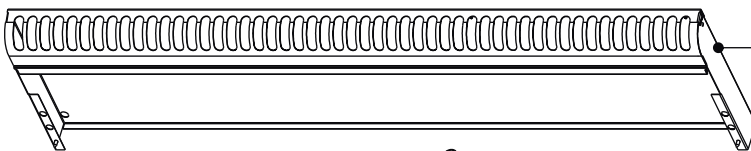
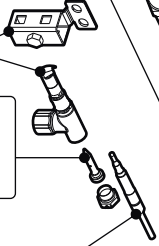

01051 - mod.700  
01052 - mod.1050

01153 BLU  
01335 GREY

00319-orange  
00052-lamp

01177

01178 - mod.700  
01179 - mod.1050

01678

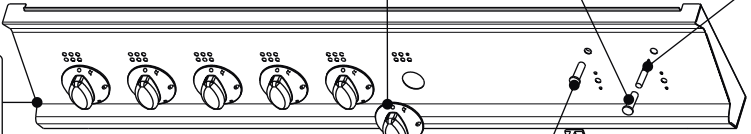

00053-green

01071

01057

01059 BLU  
01339 GREY

01056

01136

01610

01611 BLU  
01612 GREY

00305

00194

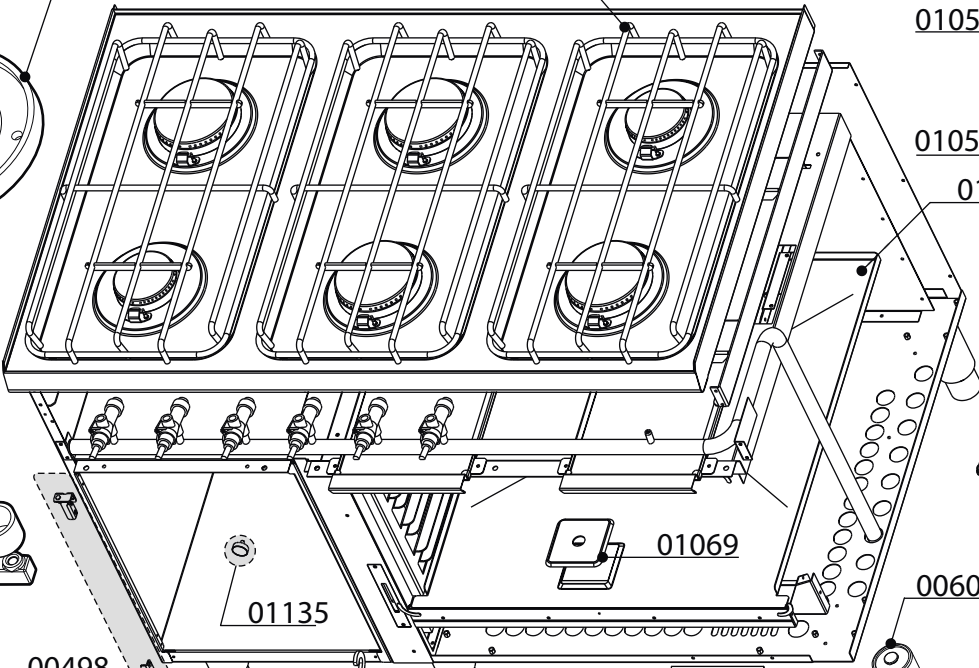
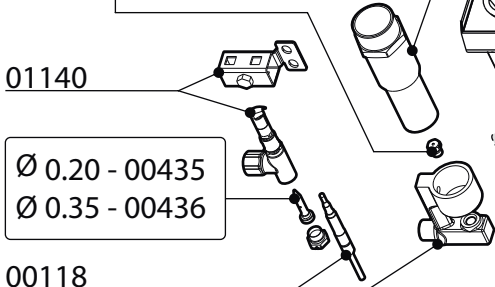

01069

01135

00602

00498

01068

01065

01055

00194

01064

01061

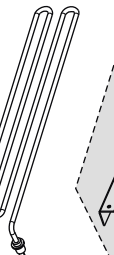

01067

01111 - (1350W)

01063

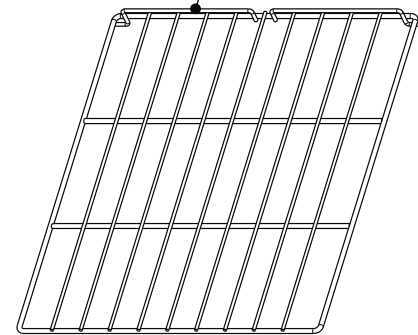

00052000 SIGNAL NEON LAMP  
00053000 GREEN LAMP HOLDER  
00118000 TERMOCOUPLE  
00194000 CONNECTING BLOCK  
00305000 SAFETY THERMOSTAT  
00319000 ORANGE LAMP HOLDER  
00435000 BY-PASS FOR PILOT  
00436000 PILOT NOZZLE  
00602000 FOOT  
01044000 NOZZLE  
01051000 FLUE 700 L7  
01055000 CABLE GLAND WITH NUT  
01056000 HOOK  
01057000 OVEN TRAY RUNNER  
01059000 CONTROL KNOB FOR OVEN HEATING ELEMENT L7  
01061000 GASKET FOR OVEN L7  
01062000 OVEN DOOR L7  
01063000 OVEN GRID L7  
01064000 OVEN SOCLE L7  
01065000 SUPPORT FOR OVEN TERMINAL  
01067000 RIGHT HINGE  
01068000 LEFT HINGE  
01069000 COVER  
01071000 SWITCH  
01111000 HEATING ELEMENT  
01136000 EXTRACTABLE OVEN BOTTOM  
01140000 TOP BURNER PILOT GROUP  
01153000 BLUE KNOB  
01189000 BURNER NOZZLE  
01197000 BURNER NOZZLE  
01208000 BY-PASS  
01318000 COOKER RIGHT SIDE L7  
01319000 COOKER LEFT SIDE L7  
01335000 ANTHRACITE KNOB PCG7/BMG7/FTG7/GRG7  
01339000 KNOB FOR OVEN HEATING ELEMENT ANTHRACITE  
01345000 OVEN DOOR ANTHRACITE L7  
01610000 WORKING THERMOSTAT OVEN L9  
01611000 OVEN THERMOSTAT BLUE KNOB L9  
01612000 OVEN THERMOSTAT ANTHRACITE KNOB L9  
01636000 BURNER NOZZLE D120  
01672000 BURNER COVER 6KW  
01674000 BURNER BODY 6KW  
01676000 BURNER VENTURI 6KW  
01677000 NOZZLE HOLDER  
01678000 ROD IRON PAN HOLDER L7\_ECO  
05001400 GAS COCK  
05002200 ADJUSTABLE BY-PASS