

01110 (2.6kW)
220x220

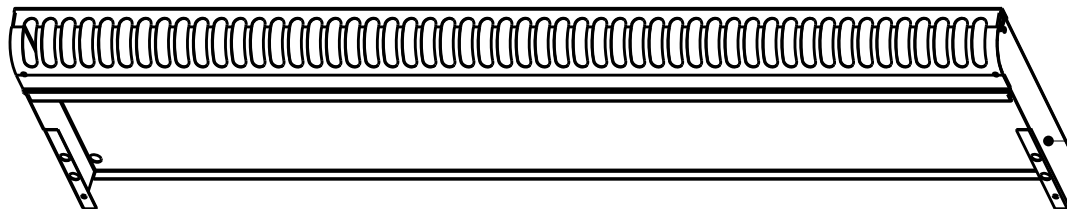

01107 (2.6kW) ø220
01108 (1.5kW) ø148
01670 (2kW) ø220

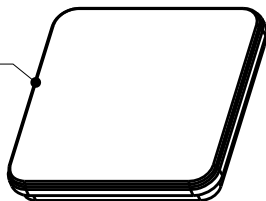
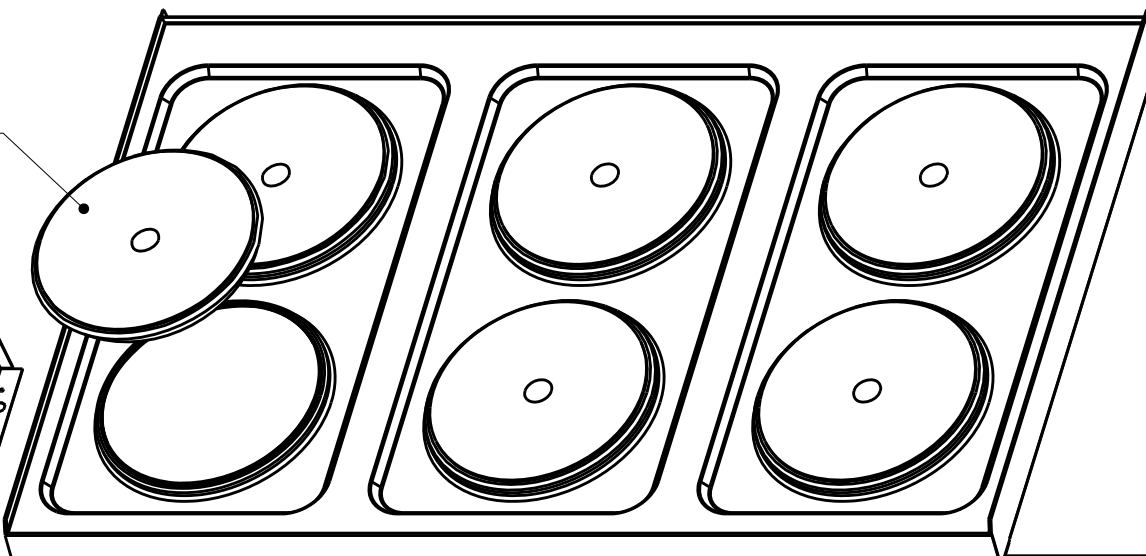

01050 (mod.350)
01051 (mod.700)
01052 (mod.1050)

01054

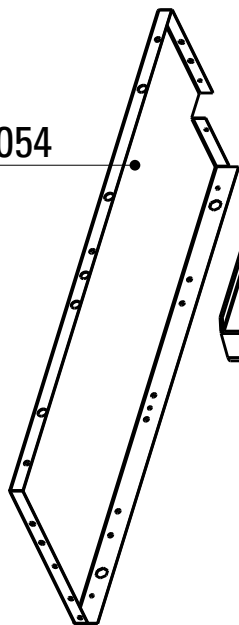

01053

00241 (PG 16)
01055 (PG 21)



01073



00291

01104 (mod.350)
01105 (mod.700)
01106 (mod.1050)

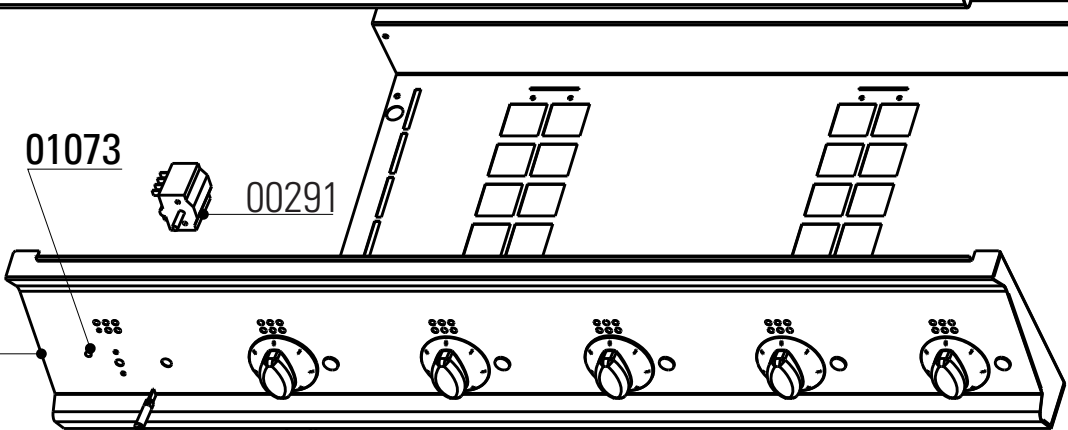

00052 - LAMP

00053 - GREEN



01109 - Blu
01330 - Grey

01101 (mod.350)
01102 (mod.700)
01103 (mod1050)

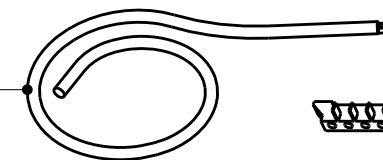

00311

00194

00018

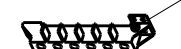

Artic./Item	Descrizione/Description			Modello/Model
616020	CUCINA ELETTRICA 6 PIASTRE QUADRE CON FORNO ELETTRICO GN2/1 6 SQUARE HOT PLATES ELECTRIC RANGE WITH GN2/1 ELECTRIC OVEN			PFS105E7
Cons./Recom.	Pos./Posit.	Ricambio/Replacement		Prezzo/Price List
	00291000	RC00291000	COMMUTATORE	SWITCH 18,64
	01052000	RC01052000	CAMINO 1050 L7	FLUE 1050 L7 129,99
	01110000	RC01110000	PIASTRA ELETTRICA SQUARE 2600W 230V	SQUARE HOT PLATE 365,55
	02029000	RC02029000	MANOPOLA PCE NERA	KNOB PCE 9,11
	02071000	RC02071000	MANOPOLA PCE GRIGIA	UNDERKNOB RAL7001 8,45
	501	RC02028000	PORTA FORNO GN2/1 TECNO70	DOOR W/HANDLE 259,40
	502	RC02082000	MANIGLIA FORNO	OVEN HANDLE 51,84
	503	RC01064000	ZOCCOLO FORNO L7	OVEN SOCLE L7 43,36
*	504	RC01782000	LAMPADA SEGN.NEON FASTON VERDE 230V	GREEN NEON LAMP 230V 5,69
	506a	RC02052000	MANOPOLA SELETTORE RES.PFE NERA	KNOB FOR HEATING ELEMENTS RAL7021 9,11
	506b	RC02053000	MANOPOLA SELETTORE RES.PFE GRIGIA	KNOB FOR HEATING ELEMENTS RAL7001 8,45
*	508	RC00052000	LAMPADA SEGN.NEON FASTON ARANCIO 230V	SIGNAL NEON LAMP 4,84
*	508	RC01783000	PORTALAMPADA TRASPARENTE D10	TRANSPARENT LAMP HOLDER D10 4,95
	509a	RC01835000	MANOPOLA PF NERA	KNOB 60°-270° 9,11
	509b	RC02054000	MANOPOLA PF GRIGIA	KNOB RAL7001 8,45
*	511	RC01610000	TERMOSTATO DI LAVORO FORNO	WORKING THERMOSTAT OVEN L9 77,35
*	512	RC01071000	COMMUTATORE	SWITCH 17,61
	513	RC01068000	CERNIERA SX PORTA FORNO GN C/P.RULLINO	LEFT HINGE 35,02
	514	RC01055000	PRESSACAVO PG21 CON DADO	CABLE GLAND WITH NUT 8,55
	515	RC00602000	PIEDE 1" 3/4 INOX	FOOT 33,99
	517	RC00194000	MORSETTIERA FV 122 B	CONNECTING BLOCK 8,55
	518	RC01067000	CERNIERA DX PORTA FORNO GN C/P.RULLINO	RIGHT HINGE 35,02
*	519	RC00305000	TERMOSTATO DI SICUREZZA	SAFETY THERMOSTAT 79,52

CODICI RICAMBIO PER FINITO / SPARE PARTS FOR THE FINISHED PRODUCT

Aggiornato al/Updated to 2/10/14

Artic./Item	Descrizione/Description	Modello/Model
616020	CUCINA ELETTRICA 6 PIASTRE QUADRE CON FORNO ELETTRICO GN2/1 6 SQUARE HOT PLATES ELECTRIC RANGE WITH GN2/1 ELECTRIC OVEN	PFS105E7

Cons./Recom.	Pos./Posit.	Ricambio/Replacement		Prezzo/Price List	
*	520	RC01111000	RESISTENZA ELETT. 1.35KW 230V	HEATING ELEMENT	53,77
	521	RC01826000	GUARNIZIONE TESSILE PER FORNO GN	TEXTILE GASKET FOR OVEN	48,94
	522	RC01057000	SUPPORTO GRIGLIA FORNO EL.STATICO	OVEN TRAY RUNNER	17,41
	523	RC01056000	PIOLINO SUPP.GRIGLIA FORNO EL.STATICO	HOOK	6,08
	525	RC01136000	FONDO FORNO ESTRAIBILE SMALTATO	EXTRACTABLE OVEN BOTTOM	19,57

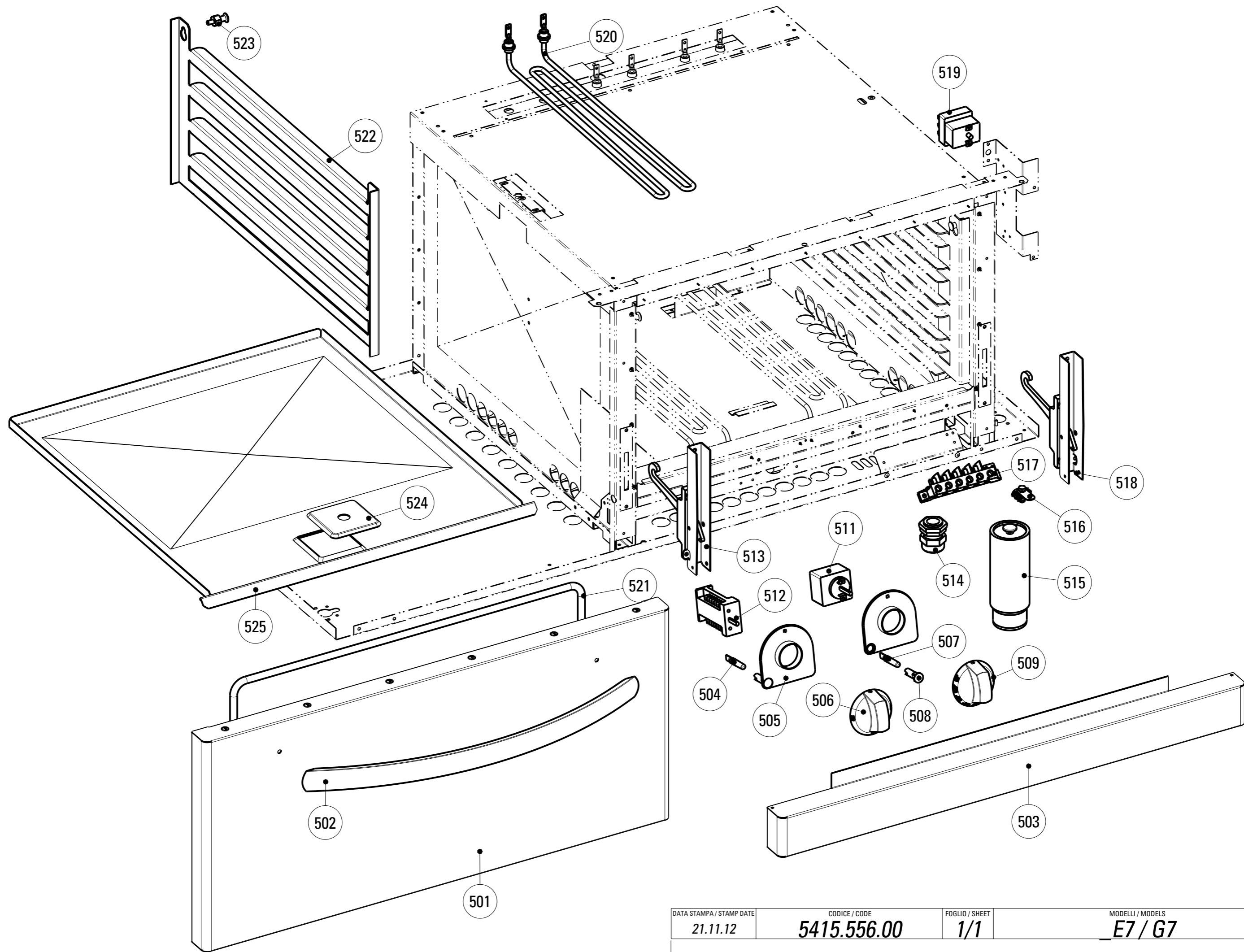

Artic./Item	Descrizione/Description			Modello/Model
616020	CUCINA ELETTRICA 6 PIASTRE QUADRE CON FORNO ELETTRICO GN2/1 6 SQUARE HOT PLATES ELECTRIC RANGE WITH GN2/1 ELECTRIC OVEN			PFS105E7
Cons./Recom.	Pos./Posit.	Ricambio/Replacement		Prezzo/Price List
	00291000	RC00291000	COMMUTATORE	SWITCH 18,64
	01052000	RC01052000	CAMINO 1050 L7	FLUE 1050 L7 129,99
	01110000	RC01110000	PIASTRA ELETTRICA SQUARE 2600W 230V	SQUARE HOT PLATE 365,55
	02029000	RC02029000	MANOPOLA PCE NERA	KNOB PCE 9,11
	02071000	RC02071000	MANOPOLA PCE GRIGIA	UNDERKNOB RAL7001 8,45
	501	RC02028000	PORTA FORNO GN2/1 TECNO70	DOOR W/HANDLE 259,40
	502	RC02082000	MANIGLIA FORNO	OVEN HANDLE 51,84
	503	RC01064000	ZOCCOLO FORNO L7	OVEN SOCLE L7 43,36
*	504	RC01782000	LAMPADA SEGN.NEON FASTON VERDE 230V	GREEN NEON LAMP 230V 5,69
	506a	RC02052000	MANOPOLA SELETTORE RES.PFE NERA	KNOB FOR HEATING ELEMENTS RAL7021 9,11
	506b	RC02053000	MANOPOLA SELETTORE RES.PFE GRIGIA	KNOB FOR HEATING ELEMENTS RAL7001 8,45
*	508	RC00052000	LAMPADA SEGN.NEON FASTON ARANCIO 230V	SIGNAL NEON LAMP 4,84
*	508	RC01783000	PORTALAMPADA TRASPARENTE D10	TRANSPARENT LAMP HOLDER D10 4,95
	509a	RC01835000	MANOPOLA PF NERA	KNOB 60°-270° 9,11
	509b	RC02054000	MANOPOLA PF GRIGIA	KNOB RAL7001 8,45
*	511	RC01610000	TERMOSTATO DI LAVORO FORNO	WORKING THERMOSTAT OVEN L9 77,35
*	512	RC01071000	COMMUTATORE	SWITCH 17,61
	513	RC01068000	CERNIERA SX PORTA FORNO GN C/P.RULLINO	LEFT HINGE 35,02
	514	RC01055000	PRESSACAVO PG21 CON DADO	CABLE GLAND WITH NUT 8,55
	515	RC00602000	PIEDE 1" 3/4 INOX	FOOT 33,99
	517	RC00194000	MORSETTIERA FV 122 B	CONNECTING BLOCK 8,55
	518	RC01067000	CERNIERA DX PORTA FORNO GN C/P.RULLINO	RIGHT HINGE 35,02
*	519	RC00305000	TERMOSTATO DI SICUREZZA	SAFETY THERMOSTAT 79,52

CODICI RICAMBIO PER FINITO / SPARE PARTS FOR THE FINISHED PRODUCT

Aggiornato al/Updated to 2/10/14

Artic./Item	Descrizione/Description		Modello/Model
616020	CUCINA ELETTRICA 6 PIASTRE QUADRE CON FORNO ELETTRICO GN2/1 6 SQUARE HOT PLATES ELECTRIC RANGE WITH GN2/1 ELECTRIC OVEN		PFS105E7
Cons./Recom.	Pos./Posit.	Ricambio/Replacement	Prezzo/Price List
*	520	RC01111000 RESISTENZA ELETT. 1.35KW 230V	HEATING ELEMENT 53,77
	521	RC01826000 GUARNIZIONE TESSILE PER FORNO GN	TEXTILE GASKET FOR OVEN 48,94
	522	RC01057000 SUPPORTO GRIGLIA FORNO EL.STATICO	OVEN TRAY RUNNER 17,41
	523	RC01056000 PIOLINO SUPP.GRIGLIA FORNO EL.STATICO	HOOK 6,08
	525	RC01136000 FONDO FORNO ESTRAIBILE SMALTATO	EXTRACTABLE OVEN BOTTOM 19,57