







Assembly code	Assembly revision	Assembly image
ASM4080A/0.D00	Door	
ASM2109B/0.D00	Cooking chamber	
ASM2110A/0.D00	External cover	
ASM2794A/0.D00	General overview	



**ASM4080A/0.D00 - Door**



ASM4080A/0.D00 - Door

REAR

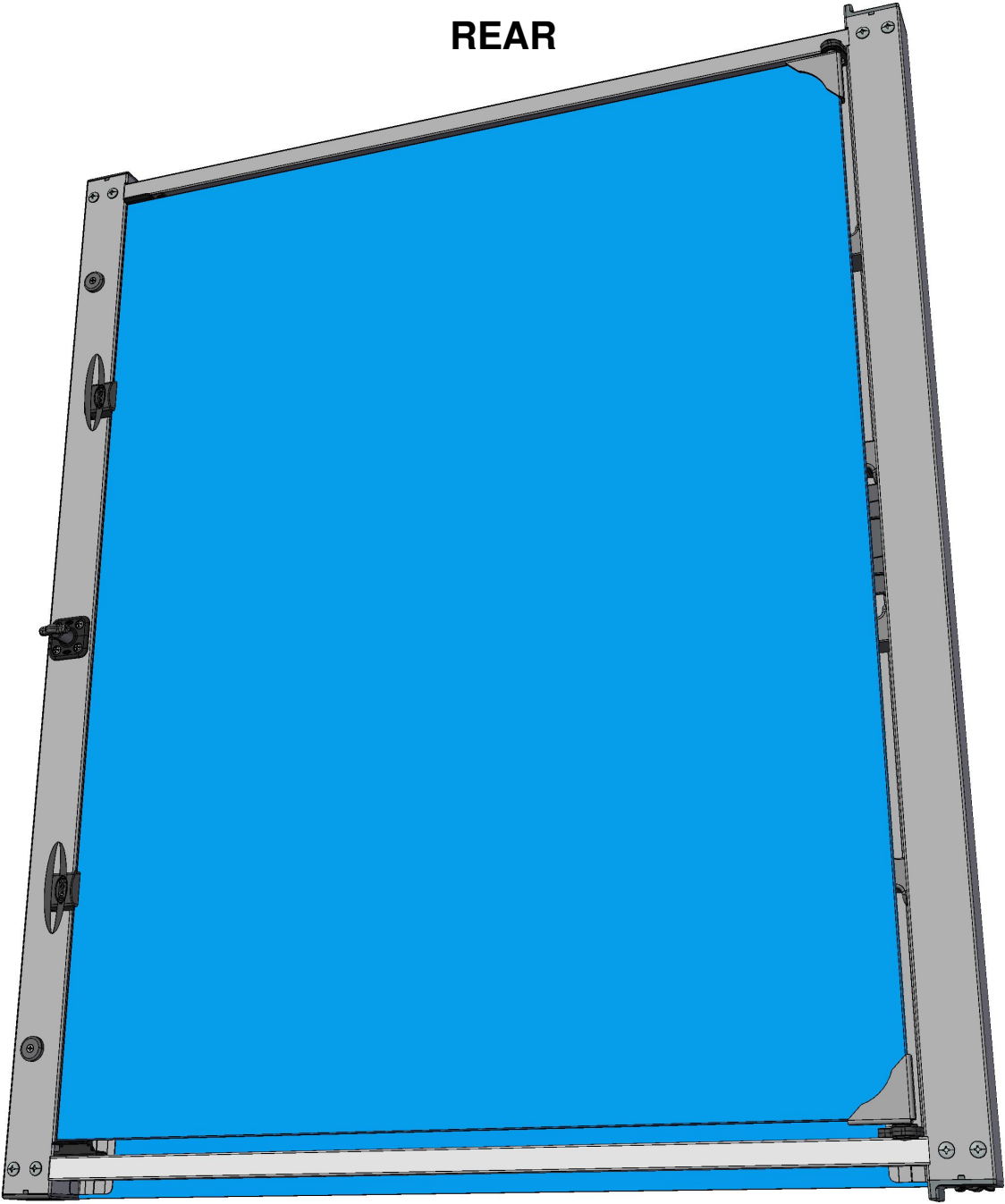









COMPONENT			SPARE PART																																																										
Code	Description	Image	Code	Description	Components list																																																								
VM1180B	CHEFTOP/BAKERTO P HANDLE SHAFT		KMG1030B	CT BT CL BL HANDLE KIT	<table border="1"> <thead> <tr> <th>Code</th> <th>Description</th> <th>Qty</th> <th>UOM</th> </tr> </thead> <tbody> <tr> <td>0H7321A0</td> <td>MM STAINLESS STEEL HANDLE COVE</td> <td>1</td> <td>PZ</td> </tr> <tr> <td>ED1072A0</td> <td></td> <td>1</td> <td>PZ</td> </tr> <tr> <td>RC1200A0</td> <td>ED=4 WIRE D.=0.5 COMPRESSIO N SPRING</td> <td>4</td> <td>PZ</td> </tr> <tr> <td>VI0239A1</td> <td>SELF-TAPPIN G SCREW 4.2X25 TCB+ INOX</td> <td>4</td> <td>PZ</td> </tr> <tr> <td>VI1220A1</td> <td>4,2X12 TCB SELF-TAPPIN G SCREW</td> <td>2</td> <td>PZ</td> </tr> <tr> <td>VM1182B1</td> <td>E S. CT BT HANDLE JUNCTION + PIN GUIDE</td> <td>1</td> <td>PZ</td> </tr> <tr> <td>VM1183B0</td> <td>CHEFTOP/BAK ERTOP HANDLE PIN</td> <td>1</td> <td>PZ</td> </tr> <tr> <td>VM1490A0</td> <td>CHEFTOP/BAK ERTOP HANDLE SCREWS COVER</td> <td>2</td> <td>PZ</td> </tr> <tr> <td>VM1695A0</td> <td>HANDLE POSITION PIN</td> <td>4</td> <td>PZ</td> </tr> <tr> <td>VM2245A0</td> <td>HANDLE SHAFT WITH LATCH</td> <td>1</td> <td>PZ</td> </tr> <tr> <td>VM2247A0</td> <td>HANDLE SHAFT COVER VM2245-2246</td> <td>1</td> <td>PZ</td> </tr> <tr> <td>VM2248B0</td> <td>CLOSING HANDLE KEY WITH LATCH</td> <td>1</td> <td>PZ</td> </tr> <tr> <td>VM2295A0</td> <td>STYLUS PEN FOR MM</td> <td>1</td> <td>PZ</td> </tr> </tbody> </table>	Code	Description	Qty	UOM	0H7321A0	MM STAINLESS STEEL HANDLE COVE	1	PZ	ED1072A0		1	PZ	RC1200A0	ED=4 WIRE D.=0.5 COMPRESSIO N SPRING	4	PZ	VI0239A1	SELF-TAPPIN G SCREW 4.2X25 TCB+ INOX	4	PZ	VI1220A1	4,2X12 TCB SELF-TAPPIN G SCREW	2	PZ	VM1182B1	E S. CT BT HANDLE JUNCTION + PIN GUIDE	1	PZ	VM1183B0	CHEFTOP/BAK ERTOP HANDLE PIN	1	PZ	VM1490A0	CHEFTOP/BAK ERTOP HANDLE SCREWS COVER	2	PZ	VM1695A0	HANDLE POSITION PIN	4	PZ	VM2245A0	HANDLE SHAFT WITH LATCH	1	PZ	VM2247A0	HANDLE SHAFT COVER VM2245-2246	1	PZ	VM2248B0	CLOSING HANDLE KEY WITH LATCH	1	PZ	VM2295A0	STYLUS PEN FOR MM	1	PZ
Code	Description	Qty	UOM																																																										
0H7321A0	MM STAINLESS STEEL HANDLE COVE	1	PZ																																																										
ED1072A0		1	PZ																																																										
RC1200A0	ED=4 WIRE D.=0.5 COMPRESSIO N SPRING	4	PZ																																																										
VI0239A1	SELF-TAPPIN G SCREW 4.2X25 TCB+ INOX	4	PZ																																																										
VI1220A1	4,2X12 TCB SELF-TAPPIN G SCREW	2	PZ																																																										
VM1182B1	E S. CT BT HANDLE JUNCTION + PIN GUIDE	1	PZ																																																										
VM1183B0	CHEFTOP/BAK ERTOP HANDLE PIN	1	PZ																																																										
VM1490A0	CHEFTOP/BAK ERTOP HANDLE SCREWS COVER	2	PZ																																																										
VM1695A0	HANDLE POSITION PIN	4	PZ																																																										
VM2245A0	HANDLE SHAFT WITH LATCH	1	PZ																																																										
VM2247A0	HANDLE SHAFT COVER VM2245-2246	1	PZ																																																										
VM2248B0	CLOSING HANDLE KEY WITH LATCH	1	PZ																																																										
VM2295A0	STYLUS PEN FOR MM	1	PZ																																																										
VM1181B	E SERIES CT BT HANDLE SHAFT CAP		KMG1030B	CT BT CL BL HANDLE KIT	<table border="1"> <thead> <tr> <th>Code</th> <th>Description</th> <th>Qty</th> <th>UOM</th> </tr> </thead> <tbody> <tr> <td>0H7321A0</td> <td>MM STAINLESS STEEL HANDLE COVE</td> <td>1</td> <td>PZ</td> </tr> <tr> <td>ED1072A0</td> <td></td> <td>1</td> <td>PZ</td> </tr> <tr> <td>RC1200A0</td> <td>ED=4 WIRE D.=0.5 COMPRESSIO N SPRING</td> <td>4</td> <td>PZ</td> </tr> </tbody> </table>	Code	Description	Qty	UOM	0H7321A0	MM STAINLESS STEEL HANDLE COVE	1	PZ	ED1072A0		1	PZ	RC1200A0	ED=4 WIRE D.=0.5 COMPRESSIO N SPRING	4	PZ																																								
Code	Description	Qty	UOM																																																										
0H7321A0	MM STAINLESS STEEL HANDLE COVE	1	PZ																																																										
ED1072A0		1	PZ																																																										
RC1200A0	ED=4 WIRE D.=0.5 COMPRESSIO N SPRING	4	PZ																																																										

COMPONENT			SPARE PART																																														
Code	Description	Image	Code	Description	Components list																																												
VM1181B	E SERIES CT BT HANDLE SHAFT CAP		KMG1030B	CT BT CL BL HANDLE KIT	<table border="1"> <thead> <tr> <th>Code</th> <th>Description</th> <th>Qty</th> <th>UOM</th> </tr> </thead> <tbody> <tr> <td>VI0239A1</td> <td>SELF-TAPPIN G SCREW 4.2X25 TCB+ INOX</td> <td>4</td> <td>PZ</td> </tr> <tr> <td>VI1220A1</td> <td>4,2X12 TCB SELF-TAPPIN G SCREW</td> <td>2</td> <td>PZ</td> </tr> <tr> <td>VM1182B1</td> <td>E S. CT BT HANDLE JUNCTION + PIN GUIDE</td> <td>1</td> <td>PZ</td> </tr> <tr> <td>VM1183B0</td> <td>CHEFTOP/BAK ERTOP HANDLE PIN</td> <td>1</td> <td>PZ</td> </tr> <tr> <td>VM1490A0</td> <td>CHEFTOP/BAK ERTOP HANDLE SCREWS COVER</td> <td>2</td> <td>PZ</td> </tr> <tr> <td>VM1695A0</td> <td>HANDLE POSITION PIN</td> <td>4</td> <td>PZ</td> </tr> <tr> <td>VM2245A0</td> <td>HANDLE SHAFT WITH LATCH</td> <td>1</td> <td>PZ</td> </tr> <tr> <td>VM2247A0</td> <td>HANDLE SHAFT COVER VM2245-2246</td> <td>1</td> <td>PZ</td> </tr> <tr> <td>VM2248B0</td> <td>CLOSING HANDLE KEY WITH LATCH</td> <td>1</td> <td>PZ</td> </tr> <tr> <td>VM2295A0</td> <td>STYLUS PEN FOR MM</td> <td>1</td> <td>PZ</td> </tr> </tbody> </table>	Code	Description	Qty	UOM	VI0239A1	SELF-TAPPIN G SCREW 4.2X25 TCB+ INOX	4	PZ	VI1220A1	4,2X12 TCB SELF-TAPPIN G SCREW	2	PZ	VM1182B1	E S. CT BT HANDLE JUNCTION + PIN GUIDE	1	PZ	VM1183B0	CHEFTOP/BAK ERTOP HANDLE PIN	1	PZ	VM1490A0	CHEFTOP/BAK ERTOP HANDLE SCREWS COVER	2	PZ	VM1695A0	HANDLE POSITION PIN	4	PZ	VM2245A0	HANDLE SHAFT WITH LATCH	1	PZ	VM2247A0	HANDLE SHAFT COVER VM2245-2246	1	PZ	VM2248B0	CLOSING HANDLE KEY WITH LATCH	1	PZ	VM2295A0	STYLUS PEN FOR MM	1	PZ
					Code	Description	Qty	UOM																																									
					VI0239A1	SELF-TAPPIN G SCREW 4.2X25 TCB+ INOX	4	PZ																																									
					VI1220A1	4,2X12 TCB SELF-TAPPIN G SCREW	2	PZ																																									
					VM1182B1	E S. CT BT HANDLE JUNCTION + PIN GUIDE	1	PZ																																									
					VM1183B0	CHEFTOP/BAK ERTOP HANDLE PIN	1	PZ																																									
					VM1490A0	CHEFTOP/BAK ERTOP HANDLE SCREWS COVER	2	PZ																																									
					VM1695A0	HANDLE POSITION PIN	4	PZ																																									
					VM2245A0	HANDLE SHAFT WITH LATCH	1	PZ																																									
					VM2247A0	HANDLE SHAFT COVER VM2245-2246	1	PZ																																									
					VM2248B0	CLOSING HANDLE KEY WITH LATCH	1	PZ																																									
VM2295A0	STYLUS PEN FOR MM	1	PZ																																														
VM1630A	INTERNAL GLASS PUSHING CAP		KVM1630A	CAP FOR INTERNAL GLASS 10 PCS KIT	<table border="1"> <thead> <tr> <th>Code</th> <th>Description</th> <th>Qty</th> <th>UOM</th> </tr> </thead> <tbody> <tr> <td>VM1630A0</td> <td>INTERNAL GLASS PUSHING CAP</td> <td>10</td> <td>PZ</td> </tr> </tbody> </table>	Code	Description	Qty	UOM	VM1630A0	INTERNAL GLASS PUSHING CAP	10	PZ																																				
Code	Description	Qty	UOM																																														
VM1630A0	INTERNAL GLASS PUSHING CAP	10	PZ																																														
VM1591A	GLASS BRACKET INT. XVC1004		KVM1591A	S.5E INT. GLASS H35 PUSHING BRACKET KIT	<table border="1"> <thead> <tr> <th>Code</th> <th>Description</th> <th>Qty</th> <th>UOM</th> </tr> </thead> <tbody> <tr> <td>VI1220A1</td> <td>4,2X12 TCB SELF-TAPPIN G SCREW</td> <td>2</td> <td>PZ</td> </tr> <tr> <td>VM1591A0</td> <td>GLASS BRACKET INT. XVC1004</td> <td>1</td> <td>PZ</td> </tr> <tr> <td>VM1630A0</td> <td>INTERNAL GLASS PUSHING CAP</td> <td>2</td> <td>PZ</td> </tr> </tbody> </table>	Code	Description	Qty	UOM	VI1220A1	4,2X12 TCB SELF-TAPPIN G SCREW	2	PZ	VM1591A0	GLASS BRACKET INT. XVC1004	1	PZ	VM1630A0	INTERNAL GLASS PUSHING CAP	2	PZ																												
					Code	Description	Qty	UOM																																									
					VI1220A1	4,2X12 TCB SELF-TAPPIN G SCREW	2	PZ																																									
VM1591A0	GLASS BRACKET INT. XVC1004	1	PZ																																														
VM1630A0	INTERNAL GLASS PUSHING CAP	2	PZ																																														



COMPONENT			SPARE PART										
Code	Description	Image	Code	Description	Components list								
VM1511A	XBC/XVC SLEEK DOOR PIN BUSHING		KVM1511A	BUSHING KIT VM1511A0 5PC	<table border="1"> <thead> <tr> <th>Code</th> <th>Description</th> <th>Qty</th> <th>UOM</th> </tr> </thead> <tbody> <tr> <td>VM1511A0</td> <td>XBC/XVC SLEEK DOOR PIN BUSHING</td> <td>5</td> <td>PZ</td> </tr> </tbody> </table>	Code	Description	Qty	UOM	VM1511A0	XBC/XVC SLEEK DOOR PIN BUSHING	5	PZ
Code	Description	Qty	UOM										
VM1511A0	XBC/XVC SLEEK DOOR PIN BUSHING	5	PZ										
VM1510A	XBC/XVC GROOVED DOOR PIN BUSHING		KVM1510A	GROOVED DOOR PIN BUSHING 5 PCS KIT	<table border="1"> <thead> <tr> <th>Code</th> <th>Description</th> <th>Qty</th> <th>UOM</th> </tr> </thead> <tbody> <tr> <td>VM1510A0</td> <td>XBC/XVC GROOVED DOOR PIN BUSHING</td> <td>5</td> <td>PZ</td> </tr> </tbody> </table>	Code	Description	Qty	UOM	VM1510A0	XBC/XVC GROOVED DOOR PIN BUSHING	5	PZ
Code	Description	Qty	UOM										
VM1510A0	XBC/XVC GROOVED DOOR PIN BUSHING	5	PZ										
TB2384B	BAKERLUX CHEFLUX DOOR UPPER LISTEL		TB2384B0	BAKERLUX CHEFLUX DOOR UPPER LISTEL									
TB2404A	BAKERLUX CHEFLUX DOOR LOWER LISTEL		TB2404A0	BAKERLUX CHEFLUX DOOR LOWER LISTEL									
VM1977A	CL BL DOOR UPPER FULCRUM-CAP		KVM1977A	CL BL DOOR UPPER FULCRUM-CAP KIT	<table border="1"> <thead> <tr> <th>Code</th> <th>Description</th> <th>Qty</th> <th>UOM</th> </tr> </thead> <tbody> <tr> <td>VM1977A0</td> <td>CL BL DOOR UPPER FULCRUM-CA</td> <td>1</td> <td>PZ</td> </tr> </tbody> </table>	Code	Description	Qty	UOM	VM1977A0	CL BL DOOR UPPER FULCRUM-CA	1	PZ
Code	Description	Qty	UOM										
VM1977A0	CL BL DOOR UPPER FULCRUM-CA	1	PZ										



COMPONENT			SPARE PART																																																																						
Code	Description	Image	Code	Description	Components list																																																																				
VM1978A	CL BL DOOR LOWER FULCRUM-CAP		KDR1254A	XB893 XV893 COMPLETE DOOR	<table border="1"> <thead> <tr> <th>Code</th> <th>Description</th> <th>Qty</th> <th>UOM</th> </tr> </thead> <tbody> <tr> <td>0H6575A1</td> <td>XB89- XV EXTERNAL GLASS HOLDING PROFILE</td> <td>2</td> <td>PZ</td> </tr> <tr> <td>0H7321A0</td> <td>MM STAINLESS STEEL HANDLE COVE</td> <td>1</td> <td>PZ</td> </tr> <tr> <td>CR1085A0</td> <td>INTERNAL GLASS UPPER HINGE</td> <td>1</td> <td>PZ</td> </tr> <tr> <td>CR1086A0</td> <td>INTERNAL GLASS LOWER HINGE</td> <td>1</td> <td>PZ</td> </tr> <tr> <td>ED1072A0</td> <td></td> <td>1</td> <td>PZ</td> </tr> <tr> <td>GN1181A0</td> <td>INTERNAL GLASS HINGE SEAL</td> <td>2</td> <td>PZ</td> </tr> <tr> <td>RC1200A0</td> <td>ED=4 WIRE D.=0.5 COMPRESSIO N SPRING</td> <td>8</td> <td>PZ</td> </tr> <tr> <td>SL1110A0</td> <td>BIADHESIVE PIN 3M VHB 9473-PC</td> <td>1</td> <td>PZ</td> </tr> <tr> <td>TB2384B0</td> <td>BAKERLUX CHEFLUX DOOR UPPER LISTEL</td> <td>1</td> <td>PZ</td> </tr> <tr> <td>TB2385A0</td> <td>BL CL 89- RIGHT DOOR COLUMN 50X50X1.2</td> <td>1</td> <td>PZ</td> </tr> <tr> <td>TB2386A0</td> <td>BL CL 89- LEFT DOOR COLUMN 50X50X1.2</td> <td>1</td> <td>PZ</td> </tr> <tr> <td>TB2404A0</td> <td>BAKERLUX CHEFLUX DOOR LOWER LISTEL</td> <td>1</td> <td>PZ</td> </tr> <tr> <td>VI0239A1</td> <td>SELF-TAPPIN G SCREW 4.2X25 TCB+ INOX</td> <td>4</td> <td>PZ</td> </tr> <tr> <td>VI1070A0</td> <td>SCREW M4X16 TSP/UNI7688 INOX</td> <td>1</td> <td>PZ</td> </tr> <tr> <td>VI1075A0</td> <td>NUT M4 H=4 UNI5587 INOX</td> <td>1</td> <td>PZ</td> </tr> <tr> <td>VI1220A1</td> <td>4,2X12 TCB SELF-TAPPIN G SCREW</td> <td>28</td> <td>PZ</td> </tr> </tbody> </table>	Code	Description	Qty	UOM	0H6575A1	XB89- XV EXTERNAL GLASS HOLDING PROFILE	2	PZ	0H7321A0	MM STAINLESS STEEL HANDLE COVE	1	PZ	CR1085A0	INTERNAL GLASS UPPER HINGE	1	PZ	CR1086A0	INTERNAL GLASS LOWER HINGE	1	PZ	ED1072A0		1	PZ	GN1181A0	INTERNAL GLASS HINGE SEAL	2	PZ	RC1200A0	ED=4 WIRE D.=0.5 COMPRESSIO N SPRING	8	PZ	SL1110A0	BIADHESIVE PIN 3M VHB 9473-PC	1	PZ	TB2384B0	BAKERLUX CHEFLUX DOOR UPPER LISTEL	1	PZ	TB2385A0	BL CL 89- RIGHT DOOR COLUMN 50X50X1.2	1	PZ	TB2386A0	BL CL 89- LEFT DOOR COLUMN 50X50X1.2	1	PZ	TB2404A0	BAKERLUX CHEFLUX DOOR LOWER LISTEL	1	PZ	VI0239A1	SELF-TAPPIN G SCREW 4.2X25 TCB+ INOX	4	PZ	VI1070A0	SCREW M4X16 TSP/UNI7688 INOX	1	PZ	VI1075A0	NUT M4 H=4 UNI5587 INOX	1	PZ	VI1220A1	4,2X12 TCB SELF-TAPPIN G SCREW	28	PZ
Code	Description	Qty	UOM																																																																						
0H6575A1	XB89- XV EXTERNAL GLASS HOLDING PROFILE	2	PZ																																																																						
0H7321A0	MM STAINLESS STEEL HANDLE COVE	1	PZ																																																																						
CR1085A0	INTERNAL GLASS UPPER HINGE	1	PZ																																																																						
CR1086A0	INTERNAL GLASS LOWER HINGE	1	PZ																																																																						
ED1072A0		1	PZ																																																																						
GN1181A0	INTERNAL GLASS HINGE SEAL	2	PZ																																																																						
RC1200A0	ED=4 WIRE D.=0.5 COMPRESSIO N SPRING	8	PZ																																																																						
SL1110A0	BIADHESIVE PIN 3M VHB 9473-PC	1	PZ																																																																						
TB2384B0	BAKERLUX CHEFLUX DOOR UPPER LISTEL	1	PZ																																																																						
TB2385A0	BL CL 89- RIGHT DOOR COLUMN 50X50X1.2	1	PZ																																																																						
TB2386A0	BL CL 89- LEFT DOOR COLUMN 50X50X1.2	1	PZ																																																																						
TB2404A0	BAKERLUX CHEFLUX DOOR LOWER LISTEL	1	PZ																																																																						
VI0239A1	SELF-TAPPIN G SCREW 4.2X25 TCB+ INOX	4	PZ																																																																						
VI1070A0	SCREW M4X16 TSP/UNI7688 INOX	1	PZ																																																																						
VI1075A0	NUT M4 H=4 UNI5587 INOX	1	PZ																																																																						
VI1220A1	4,2X12 TCB SELF-TAPPIN G SCREW	28	PZ																																																																						



COMPONENT			SPARE PART																																																																										
Code	Description	Image	Code	Description	Components list																																																																								
VM1978A	CL BL DOOR LOWER FULCRUM-CAP		KDR1254A	XB893 XV893 COMPLETE DOOR	<table border="1"> <thead> <tr> <th>Code</th> <th>Description</th> <th>Qty</th> <th>UOM</th> </tr> </thead> <tbody> <tr> <td>VI1300A0</td> <td>SCREW M6X12 T1/2T+INOX</td> <td>12</td> <td>PZ</td> </tr> <tr> <td>VI1310A0</td> <td>ZINC THREAD INSERT M6 FTR/E</td> <td>8</td> <td>PZ</td> </tr> <tr> <td>VI1340A0</td> <td>M6 ST. STEEL THREADED INSERT</td> <td>4</td> <td>PZ</td> </tr> <tr> <td>VI1810A0</td> <td>M6X6 STAINLESS STEEL FLATHEAD SCREW</td> <td>6</td> <td>PZ</td> </tr> <tr> <td>VM1182B1</td> <td>E.S. CT BT HANDLE JUNCTION + PIN GUIDE</td> <td>1</td> <td>PZ</td> </tr> <tr> <td>VM1183B0</td> <td>CHEFTOP/BAK ERTOP HANDLE PIN</td> <td>1</td> <td>PZ</td> </tr> <tr> <td>VM1490A0</td> <td>CHEFTOP/BAK ERTOP HANDLE SCREWS COVER</td> <td>2</td> <td>PZ</td> </tr> <tr> <td>VM1510A0</td> <td>XBC/XVC GROOVED DOOR PIN BUSHING</td> <td>1</td> <td>PZ</td> </tr> <tr> <td>VM1511A0</td> <td>XBC/XVC SLEEK DOOR PIN BUSHING</td> <td>1</td> <td>PZ</td> </tr> <tr> <td>VM1591A0</td> <td>GLASS BRACKET INT. XVC1004</td> <td>1</td> <td>PZ</td> </tr> <tr> <td>VM1630A0</td> <td>INTERNAL GLASS PUSHING CAP</td> <td>2</td> <td>PZ</td> </tr> <tr> <td>VM1680A0</td> <td>INTERNAL GLASS HINGE</td> <td>2</td> <td>PZ</td> </tr> <tr> <td>VM1695A0</td> <td>HANDLE POSITION PIN</td> <td>4</td> <td>PZ</td> </tr> <tr> <td>VM1976A0</td> <td>CL BL DOOR COLUMN BLANKING CA</td> <td>2</td> <td>PZ</td> </tr> <tr> <td>VM1977A0</td> <td>CL BL DOOR UPPER FULCRUM-CA</td> <td>1</td> <td>PZ</td> </tr> <tr> <td>VM1978A0</td> <td>CL BL DOOR LOWER FULCRUM-CA</td> <td>1</td> <td>PZ</td> </tr> <tr> <td>VM2000A0</td> <td>M4 SOCKET HEAD SCREW COVER</td> <td>6</td> <td>PZ</td> </tr> </tbody> </table>	Code	Description	Qty	UOM	VI1300A0	SCREW M6X12 T1/2T+INOX	12	PZ	VI1310A0	ZINC THREAD INSERT M6 FTR/E	8	PZ	VI1340A0	M6 ST. STEEL THREADED INSERT	4	PZ	VI1810A0	M6X6 STAINLESS STEEL FLATHEAD SCREW	6	PZ	VM1182B1	E.S. CT BT HANDLE JUNCTION + PIN GUIDE	1	PZ	VM1183B0	CHEFTOP/BAK ERTOP HANDLE PIN	1	PZ	VM1490A0	CHEFTOP/BAK ERTOP HANDLE SCREWS COVER	2	PZ	VM1510A0	XBC/XVC GROOVED DOOR PIN BUSHING	1	PZ	VM1511A0	XBC/XVC SLEEK DOOR PIN BUSHING	1	PZ	VM1591A0	GLASS BRACKET INT. XVC1004	1	PZ	VM1630A0	INTERNAL GLASS PUSHING CAP	2	PZ	VM1680A0	INTERNAL GLASS HINGE	2	PZ	VM1695A0	HANDLE POSITION PIN	4	PZ	VM1976A0	CL BL DOOR COLUMN BLANKING CA	2	PZ	VM1977A0	CL BL DOOR UPPER FULCRUM-CA	1	PZ	VM1978A0	CL BL DOOR LOWER FULCRUM-CA	1	PZ	VM2000A0	M4 SOCKET HEAD SCREW COVER	6	PZ
Code	Description	Qty	UOM																																																																										
VI1300A0	SCREW M6X12 T1/2T+INOX	12	PZ																																																																										
VI1310A0	ZINC THREAD INSERT M6 FTR/E	8	PZ																																																																										
VI1340A0	M6 ST. STEEL THREADED INSERT	4	PZ																																																																										
VI1810A0	M6X6 STAINLESS STEEL FLATHEAD SCREW	6	PZ																																																																										
VM1182B1	E.S. CT BT HANDLE JUNCTION + PIN GUIDE	1	PZ																																																																										
VM1183B0	CHEFTOP/BAK ERTOP HANDLE PIN	1	PZ																																																																										
VM1490A0	CHEFTOP/BAK ERTOP HANDLE SCREWS COVER	2	PZ																																																																										
VM1510A0	XBC/XVC GROOVED DOOR PIN BUSHING	1	PZ																																																																										
VM1511A0	XBC/XVC SLEEK DOOR PIN BUSHING	1	PZ																																																																										
VM1591A0	GLASS BRACKET INT. XVC1004	1	PZ																																																																										
VM1630A0	INTERNAL GLASS PUSHING CAP	2	PZ																																																																										
VM1680A0	INTERNAL GLASS HINGE	2	PZ																																																																										
VM1695A0	HANDLE POSITION PIN	4	PZ																																																																										
VM1976A0	CL BL DOOR COLUMN BLANKING CA	2	PZ																																																																										
VM1977A0	CL BL DOOR UPPER FULCRUM-CA	1	PZ																																																																										
VM1978A0	CL BL DOOR LOWER FULCRUM-CA	1	PZ																																																																										
VM2000A0	M4 SOCKET HEAD SCREW COVER	6	PZ																																																																										



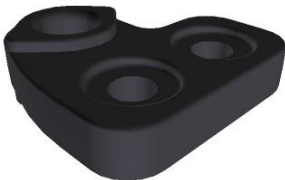

COMPONENT			SPARE PART																																										
Code	Description	Image	Code	Description	Components list																																								
VM1978A	CL BL DOOR LOWER FULCRUM-CAP		KDR1254A	XB893 XV893 COMPLETE DOOR	<table border="1"> <thead> <tr> <th>Code</th> <th>Description</th> <th>Qty</th> <th>UOM</th> </tr> </thead> <tbody> <tr> <td>VM2008A0</td> <td>SPACER FOR MICROSWITC</td> <td>1</td> <td>PZ</td> </tr> <tr> <td>VM2042A0</td> <td>INTERNAL GLASS LATERAL LOCKING SYSTEM</td> <td>2</td> <td>PZ</td> </tr> <tr> <td>VM2043A0</td> <td>UPPER - LOWER GLASS SUPPORT</td> <td>2</td> <td>PZ</td> </tr> <tr> <td>VM2245A0</td> <td>HANDLE SHAFT WITH LATCH</td> <td>1</td> <td>PZ</td> </tr> <tr> <td>VM2247A0</td> <td>HANDLE SHAFT COVER VM2245-2246</td> <td>1</td> <td>PZ</td> </tr> <tr> <td>VT1140A0</td> <td>XB893/895 XBC804/805 INTERNAL GLASS</td> <td>1</td> <td>PZ</td> </tr> <tr> <td>VT1140A0</td> <td>XB893/895 XBC804/805 INTERNAL GLASS</td> <td>1</td> <td>PZ</td> </tr> <tr> <td>VT1254A0</td> <td>OUTER GLASS XB89- XC89-</td> <td>1</td> <td>PZ</td> </tr> <tr> <td>VT1254A0</td> <td>OUTER GLASS XB89- XC89-</td> <td>1</td> <td>PZ</td> </tr> </tbody> </table>	Code	Description	Qty	UOM	VM2008A0	SPACER FOR MICROSWITC	1	PZ	VM2042A0	INTERNAL GLASS LATERAL LOCKING SYSTEM	2	PZ	VM2043A0	UPPER - LOWER GLASS SUPPORT	2	PZ	VM2245A0	HANDLE SHAFT WITH LATCH	1	PZ	VM2247A0	HANDLE SHAFT COVER VM2245-2246	1	PZ	VT1140A0	XB893/895 XBC804/805 INTERNAL GLASS	1	PZ	VT1140A0	XB893/895 XBC804/805 INTERNAL GLASS	1	PZ	VT1254A0	OUTER GLASS XB89- XC89-	1	PZ	VT1254A0	OUTER GLASS XB89- XC89-	1	PZ
Code	Description	Qty	UOM																																										
VM2008A0	SPACER FOR MICROSWITC	1	PZ																																										
VM2042A0	INTERNAL GLASS LATERAL LOCKING SYSTEM	2	PZ																																										
VM2043A0	UPPER - LOWER GLASS SUPPORT	2	PZ																																										
VM2245A0	HANDLE SHAFT WITH LATCH	1	PZ																																										
VM2247A0	HANDLE SHAFT COVER VM2245-2246	1	PZ																																										
VT1140A0	XB893/895 XBC804/805 INTERNAL GLASS	1	PZ																																										
VT1140A0	XB893/895 XBC804/805 INTERNAL GLASS	1	PZ																																										
VT1254A0	OUTER GLASS XB89- XC89-	1	PZ																																										
VT1254A0	OUTER GLASS XB89- XC89-	1	PZ																																										
VM1976A	CL BL DOOR COLUMN BLANKING CAP		KVM1976A	CL BL DOOR COLUMN BLANKING CAP KIT	<table border="1"> <thead> <tr> <th>Code</th> <th>Description</th> <th>Qty</th> <th>UOM</th> </tr> </thead> <tbody> <tr> <td>VM1976A0</td> <td>CL BL DOOR COLUMN BLANKING CA</td> <td>1</td> <td>PZ</td> </tr> </tbody> </table>	Code	Description	Qty	UOM	VM1976A0	CL BL DOOR COLUMN BLANKING CA	1	PZ																																
Code	Description	Qty	UOM																																										
VM1976A0	CL BL DOOR COLUMN BLANKING CA	1	PZ																																										
VM1680A	INTERNAL GLASS HINGE		KVM1680A	INTERNAL GLASS HINGE SUPPORT KI	<table border="1"> <thead> <tr> <th>Code</th> <th>Description</th> <th>Qty</th> <th>UOM</th> </tr> </thead> <tbody> <tr> <td>VM1680A0</td> <td>INTERNAL GLASS HINGE</td> <td>2</td> <td>PZ</td> </tr> </tbody> </table>	Code	Description	Qty	UOM	VM1680A0	INTERNAL GLASS HINGE	2	PZ																																
Code	Description	Qty	UOM																																										
VM1680A0	INTERNAL GLASS HINGE	2	PZ																																										

COMPONENT			SPARE PART																																		
Code	Description	Image	Code	Description	Components list																																
VM2043A	UPPER - LOWER GLASS SUPPORT		KVM2043A	UPPER - LOWER GLASS SUPPORT 2 PCS KIT	<table border="1"> <thead> <tr> <th>Code</th> <th>Description</th> <th>Qty</th> <th>UOM</th> </tr> </thead> <tbody> <tr> <td>VM2043A0</td> <td>UPPER - LOWER GLASS SUPPORT</td> <td>2</td> <td>PZ</td> </tr> </tbody> </table>	Code	Description	Qty	UOM	VM2043A0	UPPER - LOWER GLASS SUPPORT	2	PZ																								
Code	Description	Qty	UOM																																		
VM2043A0	UPPER - LOWER GLASS SUPPORT	2	PZ																																		
VM2008A	SPACER FOR MICROSWITCH		KVM2008A	MICROSWITCH SPACER KIT	<table border="1"> <thead> <tr> <th>Code</th> <th>Description</th> <th>Qty</th> <th>UOM</th> </tr> </thead> <tbody> <tr> <td>VM2008A0</td> <td>SPACER FOR MICROSWITCH</td> <td>2</td> <td>PZ</td> </tr> </tbody> </table>	Code	Description	Qty	UOM	VM2008A0	SPACER FOR MICROSWITCH	2	PZ																								
Code	Description	Qty	UOM																																		
VM2008A0	SPACER FOR MICROSWITCH	2	PZ																																		
VM2042A	INTERNAL GLASS LATERAL LOCKING SYSTEM		KVM2042A	INTERNAL GLASS SPRING STOPPER KIT	<table border="1"> <thead> <tr> <th>Code</th> <th>Description</th> <th>Qty</th> <th>UOM</th> </tr> </thead> <tbody> <tr> <td>RC1200A0</td> <td>ED=4 WIRE D.=0.5 COMPRESSIO N SPRING</td> <td>2</td> <td>PZ</td> </tr> <tr> <td>VI1220A1</td> <td>4,2X12 TCB SELF-TAPPIN G SCREW</td> <td>2</td> <td>PZ</td> </tr> <tr> <td>VM2042A0</td> <td>INTERNAL GLASS LATERAL LOCKING SYSTEM</td> <td>1</td> <td>PZ</td> </tr> </tbody> </table>	Code	Description	Qty	UOM	RC1200A0	ED=4 WIRE D.=0.5 COMPRESSIO N SPRING	2	PZ	VI1220A1	4,2X12 TCB SELF-TAPPIN G SCREW	2	PZ	VM2042A0	INTERNAL GLASS LATERAL LOCKING SYSTEM	1	PZ																
Code	Description	Qty	UOM																																		
RC1200A0	ED=4 WIRE D.=0.5 COMPRESSIO N SPRING	2	PZ																																		
VI1220A1	4,2X12 TCB SELF-TAPPIN G SCREW	2	PZ																																		
VM2042A0	INTERNAL GLASS LATERAL LOCKING SYSTEM	1	PZ																																		
VM1620A	LED BAR LOWER SUPPORT		KLP1007A	L200 LED BAR KIT	<table border="1"> <thead> <tr> <th>Code</th> <th>Description</th> <th>Qty</th> <th>UOM</th> </tr> </thead> <tbody> <tr> <td>CE1455A0</td> <td>TIP END FITTING</td> <td>2</td> <td>PZ</td> </tr> <tr> <td>CE1730A0</td> <td>PVC CABLE NP 2 X AWG22 STYLE 2095</td> <td>4.500</td> <td>M</td> </tr> <tr> <td>CE1735A0</td> <td>MINIFIT FEMALE END FITTING</td> <td>2</td> <td>PZ</td> </tr> <tr> <td>CE1740A0</td> <td>MINIFIT MALE END FITTING</td> <td>4</td> <td>PZ</td> </tr> <tr> <td>CE1745A0</td> <td>2 WAYS FEMALE MINIFIT CONNECTOR</td> <td>2</td> <td>PZ</td> </tr> <tr> <td>CE1750A0</td> <td>3 WAYS MALE MINIFIT CONNECTOR</td> <td>1</td> <td>PZ</td> </tr> <tr> <td>LP1007A0</td> <td>LED LIGHT BAR L200</td> <td>1</td> <td>PZ</td> </tr> </tbody> </table>	Code	Description	Qty	UOM	CE1455A0	TIP END FITTING	2	PZ	CE1730A0	PVC CABLE NP 2 X AWG22 STYLE 2095	4.500	M	CE1735A0	MINIFIT FEMALE END FITTING	2	PZ	CE1740A0	MINIFIT MALE END FITTING	4	PZ	CE1745A0	2 WAYS FEMALE MINIFIT CONNECTOR	2	PZ	CE1750A0	3 WAYS MALE MINIFIT CONNECTOR	1	PZ	LP1007A0	LED LIGHT BAR L200	1	PZ
Code	Description	Qty	UOM																																		
CE1455A0	TIP END FITTING	2	PZ																																		
CE1730A0	PVC CABLE NP 2 X AWG22 STYLE 2095	4.500	M																																		
CE1735A0	MINIFIT FEMALE END FITTING	2	PZ																																		
CE1740A0	MINIFIT MALE END FITTING	4	PZ																																		
CE1745A0	2 WAYS FEMALE MINIFIT CONNECTOR	2	PZ																																		
CE1750A0	3 WAYS MALE MINIFIT CONNECTOR	1	PZ																																		
LP1007A0	LED LIGHT BAR L200	1	PZ																																		



COMPONENT			SPARE PART																																											
Code	Description	Image	Code	Description	Components list																																									
VM1620A	LED BAR LOWER SUPPORT		KLP1007A	L200 LED BAR KIT	<table border="1"> <thead> <tr> <th>Code</th> <th>Description</th> <th>Qty</th> <th>UOM</th> </tr> </thead> <tbody> <tr> <td>VM1620A0</td> <td>LED BAR LOWER SUPPORT</td> <td>1</td> <td>PZ</td> </tr> <tr> <td>VM1621A0</td> <td>LED BAR UPPER SUPPORT</td> <td>1</td> <td>PZ</td> </tr> </tbody> </table>	Code	Description	Qty	UOM	VM1620A0	LED BAR LOWER SUPPORT	1	PZ	VM1621A0	LED BAR UPPER SUPPORT	1	PZ																													
			Code	Description	Qty	UOM																																								
			VM1620A0	LED BAR LOWER SUPPORT	1	PZ																																								
VM1621A0	LED BAR UPPER SUPPORT	1	PZ																																											
KLP1004B	L1000 LED BAR KIT	<table border="1"> <thead> <tr> <th>Code</th> <th>Description</th> <th>Qty</th> <th>UOM</th> </tr> </thead> <tbody> <tr> <td>CE1730A0</td> <td>PVC CABLE NP 2 X AWG22 STYLE 2095</td> <td>1</td> <td>M</td> </tr> <tr> <td>CE1735A0</td> <td>MINIFIT FEMALE END FITTING</td> <td>2</td> <td>PZ</td> </tr> <tr> <td>CE1740A0</td> <td>MINIFIT MALE END FITTING</td> <td>2</td> <td>PZ</td> </tr> <tr> <td>CE1745A0</td> <td>2 WAYS FEMALE MINIFIT CONNECTOR</td> <td>1</td> <td>PZ</td> </tr> <tr> <td>CE1750A0</td> <td>3 WAYS MALE MINIFIT CONNECTOR</td> <td>1</td> <td>PZ</td> </tr> <tr> <td>IP1385A1</td> <td>CORNER POLYSTYRENE PACKING 110X80X2000</td> <td>2.200</td> <td>M</td> </tr> <tr> <td>LP1004B0</td> <td>LEB LIGHTING BAR L1000</td> <td>1</td> <td>PZ</td> </tr> <tr> <td>VM1059A1</td> <td>HEAT SHRINK FILM H800</td> <td>1.300</td> <td>M</td> </tr> <tr> <td>VM1620A0</td> <td>LED BAR LOWER SUPPORT</td> <td>1</td> <td>PZ</td> </tr> <tr> <td>VM1621A0</td> <td>LED BAR UPPER SUPPORT</td> <td>1</td> <td>PZ</td> </tr> </tbody> </table>	Code	Description	Qty	UOM	CE1730A0	PVC CABLE NP 2 X AWG22 STYLE 2095	1	M	CE1735A0	MINIFIT FEMALE END FITTING	2	PZ	CE1740A0	MINIFIT MALE END FITTING	2	PZ	CE1745A0	2 WAYS FEMALE MINIFIT CONNECTOR	1	PZ	CE1750A0	3 WAYS MALE MINIFIT CONNECTOR	1	PZ	IP1385A1	CORNER POLYSTYRENE PACKING 110X80X2000	2.200	M	LP1004B0	LEB LIGHTING BAR L1000	1	PZ	VM1059A1	HEAT SHRINK FILM H800	1.300	M	VM1620A0	LED BAR LOWER SUPPORT	1	PZ	VM1621A0	LED BAR UPPER SUPPORT	1	PZ
Code	Description	Qty	UOM																																											
CE1730A0	PVC CABLE NP 2 X AWG22 STYLE 2095	1	M																																											
CE1735A0	MINIFIT FEMALE END FITTING	2	PZ																																											
CE1740A0	MINIFIT MALE END FITTING	2	PZ																																											
CE1745A0	2 WAYS FEMALE MINIFIT CONNECTOR	1	PZ																																											
CE1750A0	3 WAYS MALE MINIFIT CONNECTOR	1	PZ																																											
IP1385A1	CORNER POLYSTYRENE PACKING 110X80X2000	2.200	M																																											
LP1004B0	LEB LIGHTING BAR L1000	1	PZ																																											
VM1059A1	HEAT SHRINK FILM H800	1.300	M																																											
VM1620A0	LED BAR LOWER SUPPORT	1	PZ																																											
VM1621A0	LED BAR UPPER SUPPORT	1	PZ																																											
KLP1003B	2017 LED BAR KIT	<table border="1"> <thead> <tr> <th>Code</th> <th>Description</th> <th>Qty</th> <th>UOM</th> </tr> </thead> <tbody> <tr> <td>CE1730A0</td> <td>PVC CABLE NP 2 X AWG22 STYLE 2095</td> <td>1</td> <td>M</td> </tr> <tr> <td>CE1735A0</td> <td>MINIFIT FEMALE END FITTING</td> <td>2</td> <td>PZ</td> </tr> <tr> <td>CE1740A0</td> <td>MINIFIT MALE END FITTING</td> <td>2</td> <td>PZ</td> </tr> <tr> <td>CE1745A0</td> <td>2 WAYS FEMALE MINIFIT CONNECTOR</td> <td>1</td> <td>PZ</td> </tr> <tr> <td>CE1750A0</td> <td>3 WAYS MALE MINIFIT CONNECTOR</td> <td>1</td> <td>PZ</td> </tr> <tr> <td>LP1003B0</td> <td>LED LIGHT BAR L600</td> <td>1</td> <td>PZ</td> </tr> </tbody> </table>	Code	Description	Qty	UOM	CE1730A0	PVC CABLE NP 2 X AWG22 STYLE 2095	1	M	CE1735A0	MINIFIT FEMALE END FITTING	2	PZ	CE1740A0	MINIFIT MALE END FITTING	2	PZ	CE1745A0	2 WAYS FEMALE MINIFIT CONNECTOR	1	PZ	CE1750A0	3 WAYS MALE MINIFIT CONNECTOR	1	PZ	LP1003B0	LED LIGHT BAR L600	1	PZ																
Code	Description	Qty	UOM																																											
CE1730A0	PVC CABLE NP 2 X AWG22 STYLE 2095	1	M																																											
CE1735A0	MINIFIT FEMALE END FITTING	2	PZ																																											
CE1740A0	MINIFIT MALE END FITTING	2	PZ																																											
CE1745A0	2 WAYS FEMALE MINIFIT CONNECTOR	1	PZ																																											
CE1750A0	3 WAYS MALE MINIFIT CONNECTOR	1	PZ																																											
LP1003B0	LED LIGHT BAR L600	1	PZ																																											



COMPONENT			SPARE PART																																		
Code	Description	Image	Code	Description	Components list																																
VM1620A	LED BAR LOWER SUPPORT		KLP1003B	2017 LED BAR KIT	<table border="1"> <thead> <tr> <th>Code</th> <th>Description</th> <th>Qty</th> <th>UOM</th> </tr> </thead> <tbody> <tr> <td>VM1620A0</td> <td>LED BAR LOWER SUPPORT</td> <td>1</td> <td>PZ</td> </tr> <tr> <td>VM1621A0</td> <td>LED BAR UPPER SUPPORT</td> <td>1</td> <td>PZ</td> </tr> <tr> <td>VM1794A0</td> <td>250X4.8 PA66 BLACK CLAMP</td> <td>2</td> <td>PZ</td> </tr> <tr> <td>VM2103A0</td> <td>CLAMP LOCK</td> <td>2</td> <td>PZ</td> </tr> </tbody> </table>	Code	Description	Qty	UOM	VM1620A0	LED BAR LOWER SUPPORT	1	PZ	VM1621A0	LED BAR UPPER SUPPORT	1	PZ	VM1794A0	250X4.8 PA66 BLACK CLAMP	2	PZ	VM2103A0	CLAMP LOCK	2	PZ												
					Code	Description	Qty	UOM																													
					VM1620A0	LED BAR LOWER SUPPORT	1	PZ																													
					VM1621A0	LED BAR UPPER SUPPORT	1	PZ																													
			VM1794A0	250X4.8 PA66 BLACK CLAMP	2	PZ																															
			VM2103A0	CLAMP LOCK	2	PZ																															
			KLP1002B	L400 LED BAR KIT	<table border="1"> <thead> <tr> <th>Code</th> <th>Description</th> <th>Qty</th> <th>UOM</th> </tr> </thead> <tbody> <tr> <td>CE1455A0</td> <td>TIP END FITTING</td> <td>2</td> <td>PZ</td> </tr> <tr> <td>CE1730A0</td> <td>PVC CABLE NP 2 X AWG22 STYLE 2095</td> <td>4.500</td> <td>M</td> </tr> <tr> <td>CE1735A0</td> <td>MINIFIT FEMALE END FITTING</td> <td>2</td> <td>PZ</td> </tr> <tr> <td>CE1740A0</td> <td>MINIFIT MALE END FITTING</td> <td>4</td> <td>PZ</td> </tr> <tr> <td>CE1745A0</td> <td>2 WAYS FEMALE MINIFIT CONNECTOR</td> <td>2</td> <td>PZ</td> </tr> <tr> <td>CE1750A0</td> <td>3 WAYS MALE MINIFIT CONNECTOR</td> <td>1</td> <td>PZ</td> </tr> <tr> <td>LP1002B0</td> <td>LED LIGHTING BAR L400</td> <td>1</td> <td>PZ</td> </tr> </tbody> </table>	Code	Description	Qty	UOM	CE1455A0	TIP END FITTING	2	PZ	CE1730A0	PVC CABLE NP 2 X AWG22 STYLE 2095	4.500	M	CE1735A0	MINIFIT FEMALE END FITTING	2	PZ	CE1740A0	MINIFIT MALE END FITTING	4	PZ	CE1745A0	2 WAYS FEMALE MINIFIT CONNECTOR	2	PZ	CE1750A0	3 WAYS MALE MINIFIT CONNECTOR	1	PZ	LP1002B0	LED LIGHTING BAR L400	1	PZ
					Code	Description	Qty	UOM																													
					CE1455A0	TIP END FITTING	2	PZ																													
					CE1730A0	PVC CABLE NP 2 X AWG22 STYLE 2095	4.500	M																													
					CE1735A0	MINIFIT FEMALE END FITTING	2	PZ																													
					CE1740A0	MINIFIT MALE END FITTING	4	PZ																													
CE1745A0	2 WAYS FEMALE MINIFIT CONNECTOR	2			PZ																																
CE1750A0	3 WAYS MALE MINIFIT CONNECTOR	1			PZ																																
LP1002B0	LED LIGHTING BAR L400	1	PZ																																		
KLP1001B	L300 LED BAR KIT	<table border="1"> <thead> <tr> <th>Code</th> <th>Description</th> <th>Qty</th> <th>UOM</th> </tr> </thead> <tbody> <tr> <td>VM1620A0</td> <td>LED BAR LOWER SUPPORT</td> <td>1</td> <td>PZ</td> </tr> <tr> <td>VM1621A0</td> <td>LED BAR UPPER SUPPORT</td> <td>1</td> <td>PZ</td> </tr> <tr> <td>CE1455A0</td> <td>TIP END FITTING</td> <td>2</td> <td>PZ</td> </tr> </tbody> </table>	Code	Description	Qty	UOM	VM1620A0	LED BAR LOWER SUPPORT	1	PZ	VM1621A0	LED BAR UPPER SUPPORT	1	PZ	CE1455A0	TIP END FITTING	2	PZ																			
		Code	Description	Qty	UOM																																
		VM1620A0	LED BAR LOWER SUPPORT	1	PZ																																
		VM1621A0	LED BAR UPPER SUPPORT	1	PZ																																
CE1455A0	TIP END FITTING	2	PZ																																		
KLP1001B	L300 LED BAR KIT	<table border="1"> <thead> <tr> <th>Code</th> <th>Description</th> <th>Qty</th> <th>UOM</th> </tr> </thead> <tbody> <tr> <td>CE1730A0</td> <td>PVC CABLE NP 2 X AWG22 STYLE 2095</td> <td>4.500</td> <td>M</td> </tr> <tr> <td>CE1735A0</td> <td>MINIFIT FEMALE END FITTING</td> <td>2</td> <td>PZ</td> </tr> <tr> <td>CE1740A0</td> <td>MINIFIT MALE END FITTING</td> <td>4</td> <td>PZ</td> </tr> </tbody> </table>	Code	Description	Qty	UOM	CE1730A0	PVC CABLE NP 2 X AWG22 STYLE 2095	4.500	M	CE1735A0	MINIFIT FEMALE END FITTING	2	PZ	CE1740A0	MINIFIT MALE END FITTING	4	PZ																			
		Code	Description	Qty	UOM																																
		CE1730A0	PVC CABLE NP 2 X AWG22 STYLE 2095	4.500	M																																
		CE1735A0	MINIFIT FEMALE END FITTING	2	PZ																																
CE1740A0	MINIFIT MALE END FITTING	4	PZ																																		
KLP1001B	L300 LED BAR KIT	<table border="1"> <thead> <tr> <th>Code</th> <th>Description</th> <th>Qty</th> <th>UOM</th> </tr> </thead> <tbody> <tr> <td>CE1745A0</td> <td>2 WAYS FEMALE MINIFIT CONNECTOR</td> <td>2</td> <td>PZ</td> </tr> <tr> <td>CE1750A0</td> <td>3 WAYS MALE MINIFIT CONNECTOR</td> <td>1</td> <td>PZ</td> </tr> <tr> <td>CE1750A0</td> <td>3 WAYS MALE MINIFIT CONNECTOR</td> <td>1</td> <td>PZ</td> </tr> </tbody> </table>	Code	Description	Qty	UOM	CE1745A0	2 WAYS FEMALE MINIFIT CONNECTOR	2	PZ	CE1750A0	3 WAYS MALE MINIFIT CONNECTOR	1	PZ	CE1750A0	3 WAYS MALE MINIFIT CONNECTOR	1	PZ																			
		Code	Description	Qty	UOM																																
		CE1745A0	2 WAYS FEMALE MINIFIT CONNECTOR	2	PZ																																
		CE1750A0	3 WAYS MALE MINIFIT CONNECTOR	1	PZ																																
CE1750A0	3 WAYS MALE MINIFIT CONNECTOR	1	PZ																																		

COMPONENT			SPARE PART																																										
Code	Description	Image	Code	Description	Components list																																								
VM1620A	LED BAR LOWER SUPPORT		KLP1001B	L300 LED BAR KIT	<table border="1"> <thead> <tr> <th>Code</th> <th>Description</th> <th>Qty</th> <th>UOM</th> </tr> </thead> <tbody> <tr> <td>LP1001B0</td> <td>LED LIGHTING BAR L300</td> <td>1</td> <td>PZ</td> </tr> <tr> <td>VM1620A0</td> <td>LED BAR LOWER SUPPORT</td> <td>1</td> <td>PZ</td> </tr> <tr> <td>VM1621A0</td> <td>LED BAR UPPER SUPPORT</td> <td>1</td> <td>PZ</td> </tr> </tbody> </table>	Code	Description	Qty	UOM	LP1001B0	LED LIGHTING BAR L300	1	PZ	VM1620A0	LED BAR LOWER SUPPORT	1	PZ	VM1621A0	LED BAR UPPER SUPPORT	1	PZ																								
			Code	Description	Qty	UOM																																							
LP1001B0	LED LIGHTING BAR L300	1	PZ																																										
VM1620A0	LED BAR LOWER SUPPORT	1	PZ																																										
VM1621A0	LED BAR UPPER SUPPORT	1	PZ																																										
KLP1000A	L100 LED BAR KIT	<table border="1"> <thead> <tr> <th>Code</th> <th>Description</th> <th>Qty</th> <th>UOM</th> </tr> </thead> <tbody> <tr> <td>LP1000A0</td> <td>LED LIGHTING BAR L100</td> <td>1</td> <td>PZ</td> </tr> <tr> <td>VM1620A0</td> <td>LED BAR LOWER SUPPORT</td> <td>1</td> <td>PZ</td> </tr> <tr> <td>VM1621A0</td> <td>LED BAR UPPER SUPPORT</td> <td>1</td> <td>PZ</td> </tr> </tbody> </table>	Code	Description	Qty	UOM	LP1000A0	LED LIGHTING BAR L100	1	PZ	VM1620A0	LED BAR LOWER SUPPORT	1	PZ	VM1621A0	LED BAR UPPER SUPPORT	1	PZ																											
Code	Description	Qty	UOM																																										
LP1000A0	LED LIGHTING BAR L100	1	PZ																																										
VM1620A0	LED BAR LOWER SUPPORT	1	PZ																																										
VM1621A0	LED BAR UPPER SUPPORT	1	PZ																																										
VM1621A	LED BAR UPPER SUPPORT		KLP1007A	L200 LED BAR KIT	<table border="1"> <thead> <tr> <th>Code</th> <th>Description</th> <th>Qty</th> <th>UOM</th> </tr> </thead> <tbody> <tr> <td>CE1455A0</td> <td>TIP END FITTING</td> <td>2</td> <td>PZ</td> </tr> <tr> <td>CE1730A0</td> <td>PVC CABLE NP 2 X AWG22 STYLE 2095</td> <td>4.500</td> <td>M</td> </tr> <tr> <td>CE1735A0</td> <td>MINIFIT FEMALE END FITTING</td> <td>2</td> <td>PZ</td> </tr> <tr> <td>CE1740A0</td> <td>MINIFIT MALE END FITTING</td> <td>4</td> <td>PZ</td> </tr> <tr> <td>CE1745A0</td> <td>2 WAYS FEMALE MINIFIT CONNECTOR</td> <td>2</td> <td>PZ</td> </tr> <tr> <td>CE1750A0</td> <td>3 WAYS MALE MINIFIT CONNECTOR</td> <td>1</td> <td>PZ</td> </tr> <tr> <td>LP1007A0</td> <td>LED LIGHT BAR L200</td> <td>1</td> <td>PZ</td> </tr> <tr> <td>VM1620A0</td> <td>LED BAR LOWER SUPPORT</td> <td>1</td> <td>PZ</td> </tr> <tr> <td>VM1621A0</td> <td>LED BAR UPPER SUPPORT</td> <td>1</td> <td>PZ</td> </tr> </tbody> </table>	Code	Description	Qty	UOM	CE1455A0	TIP END FITTING	2	PZ	CE1730A0	PVC CABLE NP 2 X AWG22 STYLE 2095	4.500	M	CE1735A0	MINIFIT FEMALE END FITTING	2	PZ	CE1740A0	MINIFIT MALE END FITTING	4	PZ	CE1745A0	2 WAYS FEMALE MINIFIT CONNECTOR	2	PZ	CE1750A0	3 WAYS MALE MINIFIT CONNECTOR	1	PZ	LP1007A0	LED LIGHT BAR L200	1	PZ	VM1620A0	LED BAR LOWER SUPPORT	1	PZ	VM1621A0	LED BAR UPPER SUPPORT	1	PZ
			Code	Description	Qty	UOM																																							
CE1455A0	TIP END FITTING	2	PZ																																										
CE1730A0	PVC CABLE NP 2 X AWG22 STYLE 2095	4.500	M																																										
CE1735A0	MINIFIT FEMALE END FITTING	2	PZ																																										
CE1740A0	MINIFIT MALE END FITTING	4	PZ																																										
CE1745A0	2 WAYS FEMALE MINIFIT CONNECTOR	2	PZ																																										
CE1750A0	3 WAYS MALE MINIFIT CONNECTOR	1	PZ																																										
LP1007A0	LED LIGHT BAR L200	1	PZ																																										
VM1620A0	LED BAR LOWER SUPPORT	1	PZ																																										
VM1621A0	LED BAR UPPER SUPPORT	1	PZ																																										
KLP1004B	L1000 LED BAR KIT	<table border="1"> <thead> <tr> <th>Code</th> <th>Description</th> <th>Qty</th> <th>UOM</th> </tr> </thead> <tbody> <tr> <td>CE1730A0</td> <td>PVC CABLE NP 2 X AWG22 STYLE 2095</td> <td>1</td> <td>M</td> </tr> <tr> <td>CE1735A0</td> <td>MINIFIT FEMALE END FITTING</td> <td>2</td> <td>PZ</td> </tr> <tr> <td>CE1740A0</td> <td>MINIFIT MALE END FITTING</td> <td>2</td> <td>PZ</td> </tr> </tbody> </table>	Code	Description	Qty	UOM	CE1730A0	PVC CABLE NP 2 X AWG22 STYLE 2095	1	M	CE1735A0	MINIFIT FEMALE END FITTING	2	PZ	CE1740A0	MINIFIT MALE END FITTING	2	PZ																											
Code	Description	Qty	UOM																																										
CE1730A0	PVC CABLE NP 2 X AWG22 STYLE 2095	1	M																																										
CE1735A0	MINIFIT FEMALE END FITTING	2	PZ																																										
CE1740A0	MINIFIT MALE END FITTING	2	PZ																																										





COMPONENT			SPARE PART																																											
Code	Description	Image	Code	Description	Components list																																									
VM1621A	LED BAR UPPER SUPPORT		KLP1004B	L1000 LED BAR KIT	<table border="1"> <thead> <tr> <th>Code</th> <th>Description</th> <th>Qty</th> <th>UOM</th> </tr> </thead> <tbody> <tr> <td>CE1745A0</td> <td>2 WAYS FEMALE MINIFIT CONNECTOR</td> <td>1</td> <td>PZ</td> </tr> <tr> <td>CE1750A0</td> <td>3 WAYS MALE MINIFIT CONNECTOR</td> <td>1</td> <td>PZ</td> </tr> <tr> <td>IP1385A1</td> <td>CORNER POLYSTYREN E PACKING 110X80X2000</td> <td>2.200</td> <td>M</td> </tr> <tr> <td>LP1004B0</td> <td>LEB LIGHTING BAR L1000</td> <td>1</td> <td>PZ</td> </tr> <tr> <td>VM1059A1</td> <td>HEAT SHRINK FILM H800</td> <td>1.300</td> <td>M</td> </tr> <tr> <td>VM1620A0</td> <td>LED BAR LOWER SUPPORT</td> <td>1</td> <td>PZ</td> </tr> <tr> <td>VM1621A0</td> <td>LED BAR UPPER SUPPORT</td> <td>1</td> <td>PZ</td> </tr> </tbody> </table>	Code	Description	Qty	UOM	CE1745A0	2 WAYS FEMALE MINIFIT CONNECTOR	1	PZ	CE1750A0	3 WAYS MALE MINIFIT CONNECTOR	1	PZ	IP1385A1	CORNER POLYSTYREN E PACKING 110X80X2000	2.200	M	LP1004B0	LEB LIGHTING BAR L1000	1	PZ	VM1059A1	HEAT SHRINK FILM H800	1.300	M	VM1620A0	LED BAR LOWER SUPPORT	1	PZ	VM1621A0	LED BAR UPPER SUPPORT	1	PZ									
			Code	Description	Qty	UOM																																								
			CE1745A0	2 WAYS FEMALE MINIFIT CONNECTOR	1	PZ																																								
CE1750A0	3 WAYS MALE MINIFIT CONNECTOR	1	PZ																																											
IP1385A1	CORNER POLYSTYREN E PACKING 110X80X2000	2.200	M																																											
LP1004B0	LEB LIGHTING BAR L1000	1	PZ																																											
VM1059A1	HEAT SHRINK FILM H800	1.300	M																																											
VM1620A0	LED BAR LOWER SUPPORT	1	PZ																																											
VM1621A0	LED BAR UPPER SUPPORT	1	PZ																																											
KLP1003B	2017 LED BAR KIT	<table border="1"> <thead> <tr> <th>Code</th> <th>Description</th> <th>Qty</th> <th>UOM</th> </tr> </thead> <tbody> <tr> <td>CE1730A0</td> <td>PVC CABLE NP 2 X AWG22 STYLE 2095</td> <td>1</td> <td>M</td> </tr> <tr> <td>CE1735A0</td> <td>MINIFIT FEMALE END FITTING</td> <td>2</td> <td>PZ</td> </tr> <tr> <td>CE1740A0</td> <td>MINIFIT MALE END FITTING</td> <td>2</td> <td>PZ</td> </tr> <tr> <td>CE1745A0</td> <td>2 WAYS FEMALE MINIFIT CONNECTOR</td> <td>1</td> <td>PZ</td> </tr> <tr> <td>CE1750A0</td> <td>3 WAYS MALE MINIFIT CONNECTOR</td> <td>1</td> <td>PZ</td> </tr> <tr> <td>LP1003B0</td> <td>LED LIGHT BAR L600</td> <td>1</td> <td>PZ</td> </tr> <tr> <td>VM1620A0</td> <td>LED BAR LOWER SUPPORT</td> <td>1</td> <td>PZ</td> </tr> <tr> <td>VM1621A0</td> <td>LED BAR UPPER SUPPORT</td> <td>1</td> <td>PZ</td> </tr> <tr> <td>VM1794A0</td> <td>250X4.8 PA66 BLACK CLAMP</td> <td>2</td> <td>PZ</td> </tr> <tr> <td>VM2103A0</td> <td>CLAMP LOCK</td> <td>2</td> <td>PZ</td> </tr> </tbody> </table>	Code	Description	Qty	UOM	CE1730A0	PVC CABLE NP 2 X AWG22 STYLE 2095	1	M	CE1735A0	MINIFIT FEMALE END FITTING	2	PZ	CE1740A0	MINIFIT MALE END FITTING	2	PZ	CE1745A0	2 WAYS FEMALE MINIFIT CONNECTOR	1	PZ	CE1750A0	3 WAYS MALE MINIFIT CONNECTOR	1	PZ	LP1003B0	LED LIGHT BAR L600	1	PZ	VM1620A0	LED BAR LOWER SUPPORT	1	PZ	VM1621A0	LED BAR UPPER SUPPORT	1	PZ	VM1794A0	250X4.8 PA66 BLACK CLAMP	2	PZ	VM2103A0	CLAMP LOCK	2	PZ
Code	Description	Qty	UOM																																											
CE1730A0	PVC CABLE NP 2 X AWG22 STYLE 2095	1	M																																											
CE1735A0	MINIFIT FEMALE END FITTING	2	PZ																																											
CE1740A0	MINIFIT MALE END FITTING	2	PZ																																											
CE1745A0	2 WAYS FEMALE MINIFIT CONNECTOR	1	PZ																																											
CE1750A0	3 WAYS MALE MINIFIT CONNECTOR	1	PZ																																											
LP1003B0	LED LIGHT BAR L600	1	PZ																																											
VM1620A0	LED BAR LOWER SUPPORT	1	PZ																																											
VM1621A0	LED BAR UPPER SUPPORT	1	PZ																																											
VM1794A0	250X4.8 PA66 BLACK CLAMP	2	PZ																																											
VM2103A0	CLAMP LOCK	2	PZ																																											
KLP1002B	L400 LED BAR KIT	<table border="1"> <thead> <tr> <th>Code</th> <th>Description</th> <th>Qty</th> <th>UOM</th> </tr> </thead> <tbody> <tr> <td>CE1455A0</td> <td>TIP END FITTING</td> <td>2</td> <td>PZ</td> </tr> </tbody> </table>	Code	Description	Qty	UOM	CE1455A0	TIP END FITTING	2	PZ																																				
Code	Description	Qty	UOM																																											
CE1455A0	TIP END FITTING	2	PZ																																											



COMPONENT			SPARE PART																																																																																												
Code	Description	Image	Code	Description	Components list																																																																																										
VM1621A	LED BAR UPPER SUPPORT		KLP1002B	L400 LED BAR KIT	<table border="1"> <thead> <tr> <th>Code</th> <th>Description</th> <th>Qty</th> <th>UOM</th> </tr> </thead> <tbody> <tr> <td>CE1730A0</td> <td>PVC CABLE NP 2 X AWG22 STYLE 2095</td> <td>4.500</td> <td>M</td> </tr> <tr> <td>CE1735A0</td> <td>MINIFIT FEMALE END FITTING</td> <td>2</td> <td>PZ</td> </tr> <tr> <td>CE1740A0</td> <td>MINIFIT MALE END FITTING</td> <td>4</td> <td>PZ</td> </tr> <tr> <td>CE1745A0</td> <td>2 WAYS FEMALE MINIFIT CONNECTOR</td> <td>2</td> <td>PZ</td> </tr> <tr> <td>CE1750A0</td> <td>3 WAYS MALE MINIFIT CONNECTOR</td> <td>1</td> <td>PZ</td> </tr> <tr> <td>LP1002B0</td> <td>LED LIGHTING BAR L400</td> <td>1</td> <td>PZ</td> </tr> <tr> <td>VM1620A0</td> <td>LED BAR LOWER SUPPORT</td> <td>1</td> <td>PZ</td> </tr> <tr> <td>VM1621A0</td> <td>LED BAR UPPER SUPPORT</td> <td>1</td> <td>PZ</td> </tr> </tbody> </table>	Code	Description	Qty	UOM	CE1730A0	PVC CABLE NP 2 X AWG22 STYLE 2095	4.500	M	CE1735A0	MINIFIT FEMALE END FITTING	2	PZ	CE1740A0	MINIFIT MALE END FITTING	4	PZ	CE1745A0	2 WAYS FEMALE MINIFIT CONNECTOR	2	PZ	CE1750A0	3 WAYS MALE MINIFIT CONNECTOR	1	PZ	LP1002B0	LED LIGHTING BAR L400	1	PZ	VM1620A0	LED BAR LOWER SUPPORT	1	PZ	VM1621A0	LED BAR UPPER SUPPORT	1	PZ	KLP1001B	L300 LED BAR KIT	<table border="1"> <thead> <tr> <th>Code</th> <th>Description</th> <th>Qty</th> <th>UOM</th> </tr> </thead> <tbody> <tr> <td>CE1455A0</td> <td>TIP END FITTING</td> <td>2</td> <td>PZ</td> </tr> <tr> <td>CE1730A0</td> <td>PVC CABLE NP 2 X AWG22 STYLE 2095</td> <td>4.500</td> <td>M</td> </tr> <tr> <td>CE1735A0</td> <td>MINIFIT FEMALE END FITTING</td> <td>2</td> <td>PZ</td> </tr> <tr> <td>CE1740A0</td> <td>MINIFIT MALE END FITTING</td> <td>4</td> <td>PZ</td> </tr> <tr> <td>CE1745A0</td> <td>2 WAYS FEMALE MINIFIT CONNECTOR</td> <td>2</td> <td>PZ</td> </tr> <tr> <td>CE1750A0</td> <td>3 WAYS MALE MINIFIT CONNECTOR</td> <td>1</td> <td>PZ</td> </tr> <tr> <td>LP1001B0</td> <td>LED LIGHTING BAR L300</td> <td>1</td> <td>PZ</td> </tr> <tr> <td>VM1620A0</td> <td>LED BAR LOWER SUPPORT</td> <td>1</td> <td>PZ</td> </tr> <tr> <td>VM1621A0</td> <td>LED BAR UPPER SUPPORT</td> <td>1</td> <td>PZ</td> </tr> </tbody> </table>	Code	Description	Qty	UOM	CE1455A0	TIP END FITTING	2	PZ	CE1730A0	PVC CABLE NP 2 X AWG22 STYLE 2095	4.500	M	CE1735A0	MINIFIT FEMALE END FITTING	2	PZ	CE1740A0	MINIFIT MALE END FITTING	4	PZ	CE1745A0	2 WAYS FEMALE MINIFIT CONNECTOR	2	PZ	CE1750A0	3 WAYS MALE MINIFIT CONNECTOR	1	PZ	LP1001B0	LED LIGHTING BAR L300	1	PZ	VM1620A0	LED BAR LOWER SUPPORT	1	PZ	VM1621A0	LED BAR UPPER SUPPORT	1	PZ	KLP1000A	L100 LED BAR KIT	<table border="1"> <thead> <tr> <th>Code</th> <th>Description</th> <th>Qty</th> <th>UOM</th> </tr> </thead> <tbody> <tr> <td>LP1000A0</td> <td>LED LIGHTING BAR L100</td> <td>1</td> <td>PZ</td> </tr> </tbody> </table>	Code	Description	Qty	UOM	LP1000A0	LED LIGHTING BAR L100	1	PZ
			Code	Description	Qty	UOM																																																																																									
			CE1730A0	PVC CABLE NP 2 X AWG22 STYLE 2095	4.500	M																																																																																									
CE1735A0	MINIFIT FEMALE END FITTING	2	PZ																																																																																												
CE1740A0	MINIFIT MALE END FITTING	4	PZ																																																																																												
CE1745A0	2 WAYS FEMALE MINIFIT CONNECTOR	2	PZ																																																																																												
CE1750A0	3 WAYS MALE MINIFIT CONNECTOR	1	PZ																																																																																												
LP1002B0	LED LIGHTING BAR L400	1	PZ																																																																																												
VM1620A0	LED BAR LOWER SUPPORT	1	PZ																																																																																												
VM1621A0	LED BAR UPPER SUPPORT	1	PZ																																																																																												
Code	Description	Qty	UOM																																																																																												
CE1455A0	TIP END FITTING	2	PZ																																																																																												
CE1730A0	PVC CABLE NP 2 X AWG22 STYLE 2095	4.500	M																																																																																												
CE1735A0	MINIFIT FEMALE END FITTING	2	PZ																																																																																												
CE1740A0	MINIFIT MALE END FITTING	4	PZ																																																																																												
CE1745A0	2 WAYS FEMALE MINIFIT CONNECTOR	2	PZ																																																																																												
CE1750A0	3 WAYS MALE MINIFIT CONNECTOR	1	PZ																																																																																												
LP1001B0	LED LIGHTING BAR L300	1	PZ																																																																																												
VM1620A0	LED BAR LOWER SUPPORT	1	PZ																																																																																												
VM1621A0	LED BAR UPPER SUPPORT	1	PZ																																																																																												
Code	Description	Qty	UOM																																																																																												
LP1000A0	LED LIGHTING BAR L100	1	PZ																																																																																												



COMPONENT			SPARE PART																																										
Code	Description	Image	Code	Description	Components list																																								
VM1621A	LED BAR UPPER SUPPORT		KLP1000A	L100 LED BAR KIT	<table border="1"> <thead> <tr> <th>Code</th> <th>Description</th> <th>Qty</th> <th>UOM</th> </tr> </thead> <tbody> <tr> <td>VM1620A0</td> <td>LED BAR LOWER SUPPORT</td> <td>1</td> <td>PZ</td> </tr> <tr> <td>VM1621A0</td> <td>LED BAR UPPER SUPPORT</td> <td>1</td> <td>PZ</td> </tr> </tbody> </table>	Code	Description	Qty	UOM	VM1620A0	LED BAR LOWER SUPPORT	1	PZ	VM1621A0	LED BAR UPPER SUPPORT	1	PZ																												
Code	Description	Qty	UOM																																										
VM1620A0	LED BAR LOWER SUPPORT	1	PZ																																										
VM1621A0	LED BAR UPPER SUPPORT	1	PZ																																										
LP1044A	LUX LED BAR		KLP1044A	LUX LED BAR KIT	<table border="1"> <thead> <tr> <th>Code</th> <th>Description</th> <th>Qty</th> <th>UOM</th> </tr> </thead> <tbody> <tr> <td>CE1455A0</td> <td>TIP END FITTING</td> <td>2</td> <td>PZ</td> </tr> <tr> <td>CE1730A0</td> <td>PVC CABLE NP 2 X AWG22 STYLE 2095</td> <td>4.500</td> <td>M</td> </tr> <tr> <td>CE1735A0</td> <td>MINIFIT FEMALE END FITTING</td> <td>2</td> <td>PZ</td> </tr> <tr> <td>CE1740A0</td> <td>MINIFIT MALE END FITTING</td> <td>4</td> <td>PZ</td> </tr> <tr> <td>CE1745A0</td> <td>2 WAYS FEMALE MINIFIT CONNECTOR</td> <td>2</td> <td>PZ</td> </tr> <tr> <td>CE1750A0</td> <td>3 WAYS MALE MINIFIT CONNECTOR</td> <td>1</td> <td>PZ</td> </tr> <tr> <td>LP1044A0</td> <td>LUX LED BAR</td> <td>1</td> <td>PZ</td> </tr> <tr> <td>VM1620A0</td> <td>LED BAR LOWER SUPPORT</td> <td>1</td> <td>PZ</td> </tr> <tr> <td>VM1621A0</td> <td>LED BAR UPPER SUPPORT</td> <td>1</td> <td>PZ</td> </tr> </tbody> </table>	Code	Description	Qty	UOM	CE1455A0	TIP END FITTING	2	PZ	CE1730A0	PVC CABLE NP 2 X AWG22 STYLE 2095	4.500	M	CE1735A0	MINIFIT FEMALE END FITTING	2	PZ	CE1740A0	MINIFIT MALE END FITTING	4	PZ	CE1745A0	2 WAYS FEMALE MINIFIT CONNECTOR	2	PZ	CE1750A0	3 WAYS MALE MINIFIT CONNECTOR	1	PZ	LP1044A0	LUX LED BAR	1	PZ	VM1620A0	LED BAR LOWER SUPPORT	1	PZ	VM1621A0	LED BAR UPPER SUPPORT	1	PZ
Code	Description	Qty	UOM																																										
CE1455A0	TIP END FITTING	2	PZ																																										
CE1730A0	PVC CABLE NP 2 X AWG22 STYLE 2095	4.500	M																																										
CE1735A0	MINIFIT FEMALE END FITTING	2	PZ																																										
CE1740A0	MINIFIT MALE END FITTING	4	PZ																																										
CE1745A0	2 WAYS FEMALE MINIFIT CONNECTOR	2	PZ																																										
CE1750A0	3 WAYS MALE MINIFIT CONNECTOR	1	PZ																																										
LP1044A0	LUX LED BAR	1	PZ																																										
VM1620A0	LED BAR LOWER SUPPORT	1	PZ																																										
VM1621A0	LED BAR UPPER SUPPORT	1	PZ																																										
TB3095A	BL CL 89 RIGHT COLUMN		TB3095A0	BL CL 89 RIGHT COLUMN																																									





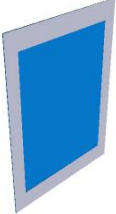



COMPONENT			SPARE PART																																		
Code	Description	Image	Code	Description	Components list																																
TB3093A	BL CL 89 LEFT COLUMN		TB3093A0	BL CL 89 LEFT COLUMN																																	
VT1254A	OUTER GLASS XB89- XC89-		KVT1254AR	XB89-XV893 LED EXTERNAL GLASS KIT	<table border="1"> <thead> <tr> <th>Code</th> <th>Description</th> <th>Qty</th> <th>UOM</th> </tr> </thead> <tbody> <tr> <td>0H7530A0</td> <td>XB89- XV EXTERNAL GLASS HOLDING PROFILE</td> <td>2</td> <td>PZ</td> </tr> <tr> <td>IP1385A1</td> <td>CORNER POLYSTYRENE PACKING 110X80X2000</td> <td>3.450</td> <td>M</td> </tr> <tr> <td>IP1508A1</td> <td>POLYSTYRENE U SHAPED PROFILE 2000X60X60</td> <td>3</td> <td>M</td> </tr> <tr> <td>SL1156A0</td> <td>NOZZLE FOR SILICON GUN</td> <td>1.200</td> <td>PZ</td> </tr> <tr> <td>VM1059A1</td> <td>HEAT SHRINK FILM H800</td> <td>1.700</td> <td>M</td> </tr> <tr> <td>VT1254A0</td> <td>OUTER GLASS XB89- XC89-</td> <td>1</td> <td>PZ</td> </tr> <tr> <td>VT1254A0</td> <td>OUTER GLASS XB89- XC89-</td> <td>1</td> <td>PZ</td> </tr> </tbody> </table>	Code	Description	Qty	UOM	0H7530A0	XB89- XV EXTERNAL GLASS HOLDING PROFILE	2	PZ	IP1385A1	CORNER POLYSTYRENE PACKING 110X80X2000	3.450	M	IP1508A1	POLYSTYRENE U SHAPED PROFILE 2000X60X60	3	M	SL1156A0	NOZZLE FOR SILICON GUN	1.200	PZ	VM1059A1	HEAT SHRINK FILM H800	1.700	M	VT1254A0	OUTER GLASS XB89- XC89-	1	PZ	VT1254A0	OUTER GLASS XB89- XC89-	1	PZ
Code	Description	Qty	UOM																																		
0H7530A0	XB89- XV EXTERNAL GLASS HOLDING PROFILE	2	PZ																																		
IP1385A1	CORNER POLYSTYRENE PACKING 110X80X2000	3.450	M																																		
IP1508A1	POLYSTYRENE U SHAPED PROFILE 2000X60X60	3	M																																		
SL1156A0	NOZZLE FOR SILICON GUN	1.200	PZ																																		
VM1059A1	HEAT SHRINK FILM H800	1.700	M																																		
VT1254A0	OUTER GLASS XB89- XC89-	1	PZ																																		
VT1254A0	OUTER GLASS XB89- XC89-	1	PZ																																		
			KVT1254A	XB89- XV893 EXTERNAL GLASS KIT	<table border="1"> <thead> <tr> <th>Code</th> <th>Description</th> <th>Qty</th> <th>UOM</th> </tr> </thead> <tbody> <tr> <td>0H6575A1</td> <td>XB89- XV EXTERNAL GLASS HOLDING PROFILE</td> <td>2</td> <td>PZ</td> </tr> <tr> <td>IP1385A1</td> <td>CORNER POLYSTYRENE PACKING 110X80X2000</td> <td>2.180</td> <td>M</td> </tr> <tr> <td>IP1508A1</td> <td>POLYSTYRENE U SHAPED PROFILE 2000X60X60</td> <td>1.270</td> <td>M</td> </tr> <tr> <td>SL1155A1</td> <td>SILICON BICOMPONENT LOCTITE</td> <td>0.200</td> <td>ML</td> </tr> <tr> <td>SL1156A0</td> <td>NOZZLE FOR SILICON GUN</td> <td>1</td> <td>PZ</td> </tr> <tr> <td>VT1254A0</td> <td>OUTER GLASS XB89- XC89-</td> <td>1</td> <td>PZ</td> </tr> <tr> <td>VT1254A0</td> <td>OUTER GLASS XB89- XC89-</td> <td>1</td> <td>PZ</td> </tr> </tbody> </table>	Code	Description	Qty	UOM	0H6575A1	XB89- XV EXTERNAL GLASS HOLDING PROFILE	2	PZ	IP1385A1	CORNER POLYSTYRENE PACKING 110X80X2000	2.180	M	IP1508A1	POLYSTYRENE U SHAPED PROFILE 2000X60X60	1.270	M	SL1155A1	SILICON BICOMPONENT LOCTITE	0.200	ML	SL1156A0	NOZZLE FOR SILICON GUN	1	PZ	VT1254A0	OUTER GLASS XB89- XC89-	1	PZ	VT1254A0	OUTER GLASS XB89- XC89-	1	PZ
Code	Description	Qty	UOM																																		
0H6575A1	XB89- XV EXTERNAL GLASS HOLDING PROFILE	2	PZ																																		
IP1385A1	CORNER POLYSTYRENE PACKING 110X80X2000	2.180	M																																		
IP1508A1	POLYSTYRENE U SHAPED PROFILE 2000X60X60	1.270	M																																		
SL1155A1	SILICON BICOMPONENT LOCTITE	0.200	ML																																		
SL1156A0	NOZZLE FOR SILICON GUN	1	PZ																																		
VT1254A0	OUTER GLASS XB89- XC89-	1	PZ																																		
VT1254A0	OUTER GLASS XB89- XC89-	1	PZ																																		



COMPONENT			SPARE PART																																														
Code	Description	Image	Code	Description	Components list																																												
CR1085A	INTERNAL GLASS UPPER HINGE		KVM0012A	4-5-5E S. INT. GLASS OPENING SYSTEM KIT	<table border="1"> <thead> <tr> <th>Code</th> <th>Description</th> <th>Qty</th> <th>UOM</th> </tr> </thead> <tbody> <tr> <td>CR1085A0</td> <td>INTERNAL GLASS UPPER HINGE</td> <td>1</td> <td>PZ</td> </tr> <tr> <td>CR1086A0</td> <td>INTERNAL GLASS LOWER HINGE</td> <td>1</td> <td>PZ</td> </tr> <tr> <td>GN1181A0</td> <td>INTERNAL GLASS HINGE SEAL</td> <td>2</td> <td>PZ</td> </tr> <tr> <td>VI1220A1</td> <td>4,2X12 TCB SELF-TAPPIN G SCREW</td> <td>5</td> <td>PZ</td> </tr> <tr> <td>VI1300A0</td> <td>SCREW M6X12 T1/2T+INOX</td> <td>4</td> <td>PZ</td> </tr> <tr> <td>VI1810A0</td> <td>M6X6 STAINLESS STEEL FLATHEAD SCREW</td> <td>6</td> <td>PZ</td> </tr> <tr> <td>VI1950A0</td> <td>ST. STEEL 4,2X13 TCB SELF-DRILLIN G SCREW</td> <td>6</td> <td>PZ</td> </tr> <tr> <td>VM1680A0</td> <td>INTERNAL GLASS HINGE</td> <td>2</td> <td>PZ</td> </tr> <tr> <td>VM2042A0</td> <td>INTERNAL GLASS LATERAL LOCKING SYSTEM</td> <td>2</td> <td>PZ</td> </tr> <tr> <td>VM2043A0</td> <td>UPPER - LOWER GLASS SUPPORT</td> <td>2</td> <td>PZ</td> </tr> </tbody> </table>	Code	Description	Qty	UOM	CR1085A0	INTERNAL GLASS UPPER HINGE	1	PZ	CR1086A0	INTERNAL GLASS LOWER HINGE	1	PZ	GN1181A0	INTERNAL GLASS HINGE SEAL	2	PZ	VI1220A1	4,2X12 TCB SELF-TAPPIN G SCREW	5	PZ	VI1300A0	SCREW M6X12 T1/2T+INOX	4	PZ	VI1810A0	M6X6 STAINLESS STEEL FLATHEAD SCREW	6	PZ	VI1950A0	ST. STEEL 4,2X13 TCB SELF-DRILLIN G SCREW	6	PZ	VM1680A0	INTERNAL GLASS HINGE	2	PZ	VM2042A0	INTERNAL GLASS LATERAL LOCKING SYSTEM	2	PZ	VM2043A0	UPPER - LOWER GLASS SUPPORT	2	PZ
			Code	Description	Qty	UOM																																											
CR1085A0	INTERNAL GLASS UPPER HINGE	1	PZ																																														
CR1086A0	INTERNAL GLASS LOWER HINGE	1	PZ																																														
GN1181A0	INTERNAL GLASS HINGE SEAL	2	PZ																																														
VI1220A1	4,2X12 TCB SELF-TAPPIN G SCREW	5	PZ																																														
VI1300A0	SCREW M6X12 T1/2T+INOX	4	PZ																																														
VI1810A0	M6X6 STAINLESS STEEL FLATHEAD SCREW	6	PZ																																														
VI1950A0	ST. STEEL 4,2X13 TCB SELF-DRILLIN G SCREW	6	PZ																																														
VM1680A0	INTERNAL GLASS HINGE	2	PZ																																														
VM2042A0	INTERNAL GLASS LATERAL LOCKING SYSTEM	2	PZ																																														
VM2043A0	UPPER - LOWER GLASS SUPPORT	2	PZ																																														
KCR1085A	INTERNAL GLASS UPPER HINGE KIT	<table border="1"> <thead> <tr> <th>Code</th> <th>Description</th> <th>Qty</th> <th>UOM</th> </tr> </thead> <tbody> <tr> <td>CR1085A0</td> <td>INTERNAL GLASS UPPER HINGE</td> <td>1</td> <td>PZ</td> </tr> <tr> <td>GN1181A0</td> <td>INTERNAL GLASS HINGE SEAL</td> <td>1</td> <td>PZ</td> </tr> <tr> <td>VI1810A0</td> <td>M6X6 STAINLESS STEEL FLATHEAD SCREW</td> <td>3</td> <td>PZ</td> </tr> </tbody> </table>	Code	Description	Qty	UOM	CR1085A0	INTERNAL GLASS UPPER HINGE	1	PZ	GN1181A0	INTERNAL GLASS HINGE SEAL	1	PZ	VI1810A0	M6X6 STAINLESS STEEL FLATHEAD SCREW	3	PZ																															
Code	Description	Qty	UOM																																														
CR1085A0	INTERNAL GLASS UPPER HINGE	1	PZ																																														
GN1181A0	INTERNAL GLASS HINGE SEAL	1	PZ																																														
VI1810A0	M6X6 STAINLESS STEEL FLATHEAD SCREW	3	PZ																																														



COMPONENT			SPARE PART																																														
Code	Description	Image	Code	Description	Components list																																												
GN1181A	INTERNAL GLASS HINGE SEAL		KGN1181A	INT. GLASS HINGE GASKET 2 PCS KIT	<table border="1"> <thead> <tr> <th>Code</th> <th>Description</th> <th>Qty</th> <th>UOM</th> </tr> </thead> <tbody> <tr> <td>GN1181A0</td> <td>INTERNAL GLASS HINGE SEAL</td> <td>2</td> <td>PZ</td> </tr> </tbody> </table>	Code	Description	Qty	UOM	GN1181A0	INTERNAL GLASS HINGE SEAL	2	PZ																																				
Code	Description	Qty	UOM																																														
GN1181A0	INTERNAL GLASS HINGE SEAL	2	PZ																																														
GN1181A	INTERNAL GLASS HINGE SEAL		KGN1181A	INT. GLASS HINGE GASKET 2 PCS KIT	<table border="1"> <thead> <tr> <th>Code</th> <th>Description</th> <th>Qty</th> <th>UOM</th> </tr> </thead> <tbody> <tr> <td>GN1181A0</td> <td>INTERNAL GLASS HINGE SEAL</td> <td>2</td> <td>PZ</td> </tr> </tbody> </table>	Code	Description	Qty	UOM	GN1181A0	INTERNAL GLASS HINGE SEAL	2	PZ																																				
Code	Description	Qty	UOM																																														
GN1181A0	INTERNAL GLASS HINGE SEAL	2	PZ																																														
CR1086A	INTERNAL GLASS LOWER HINGE		KVM0012A	4-5-5E S. INT. GLASS OPENING SYSTEM KIT	<table border="1"> <thead> <tr> <th>Code</th> <th>Description</th> <th>Qty</th> <th>UOM</th> </tr> </thead> <tbody> <tr> <td>CR1085A0</td> <td>INTERNAL GLASS UPPER HINGE</td> <td>1</td> <td>PZ</td> </tr> <tr> <td>CR1086A0</td> <td>INTERNAL GLASS LOWER HINGE</td> <td>1</td> <td>PZ</td> </tr> <tr> <td>GN1181A0</td> <td>INTERNAL GLASS HINGE SEAL</td> <td>2</td> <td>PZ</td> </tr> <tr> <td>VI1220A1</td> <td>4,2X12 TCB SELF-TAPPIN G SCREW</td> <td>5</td> <td>PZ</td> </tr> <tr> <td>VI1300A0</td> <td>SCREW M6X12 T1/2T+INOX</td> <td>4</td> <td>PZ</td> </tr> <tr> <td>VI1810A0</td> <td>M6X6 STAINLESS STEEL FLATHEAD SCREW</td> <td>6</td> <td>PZ</td> </tr> <tr> <td>VI1950A0</td> <td>ST. STEEL 4,2X13 TCB SELF-DRILLIN G SCREW</td> <td>6</td> <td>PZ</td> </tr> <tr> <td>VM1680A0</td> <td>INTERNAL GLASS HINGE</td> <td>2</td> <td>PZ</td> </tr> <tr> <td>VM2042A0</td> <td>INTERNAL GLASS LATERAL LOCKING SYSTEM</td> <td>2</td> <td>PZ</td> </tr> <tr> <td>VM2043A0</td> <td>UPPER - LOWER GLASS SUPPORT</td> <td>2</td> <td>PZ</td> </tr> </tbody> </table>	Code	Description	Qty	UOM	CR1085A0	INTERNAL GLASS UPPER HINGE	1	PZ	CR1086A0	INTERNAL GLASS LOWER HINGE	1	PZ	GN1181A0	INTERNAL GLASS HINGE SEAL	2	PZ	VI1220A1	4,2X12 TCB SELF-TAPPIN G SCREW	5	PZ	VI1300A0	SCREW M6X12 T1/2T+INOX	4	PZ	VI1810A0	M6X6 STAINLESS STEEL FLATHEAD SCREW	6	PZ	VI1950A0	ST. STEEL 4,2X13 TCB SELF-DRILLIN G SCREW	6	PZ	VM1680A0	INTERNAL GLASS HINGE	2	PZ	VM2042A0	INTERNAL GLASS LATERAL LOCKING SYSTEM	2	PZ	VM2043A0	UPPER - LOWER GLASS SUPPORT	2	PZ
Code	Description	Qty	UOM																																														
CR1085A0	INTERNAL GLASS UPPER HINGE	1	PZ																																														
CR1086A0	INTERNAL GLASS LOWER HINGE	1	PZ																																														
GN1181A0	INTERNAL GLASS HINGE SEAL	2	PZ																																														
VI1220A1	4,2X12 TCB SELF-TAPPIN G SCREW	5	PZ																																														
VI1300A0	SCREW M6X12 T1/2T+INOX	4	PZ																																														
VI1810A0	M6X6 STAINLESS STEEL FLATHEAD SCREW	6	PZ																																														
VI1950A0	ST. STEEL 4,2X13 TCB SELF-DRILLIN G SCREW	6	PZ																																														
VM1680A0	INTERNAL GLASS HINGE	2	PZ																																														
VM2042A0	INTERNAL GLASS LATERAL LOCKING SYSTEM	2	PZ																																														
VM2043A0	UPPER - LOWER GLASS SUPPORT	2	PZ																																														

COMPONENT			SPARE PART																						
Code	Description	Image	Code	Description	Components list																				
CR1086A	INTERNAL GLASS LOWER HINGE		KCR1086A	INTERNAL GLASS LOWER HINGE KIT	<table border="1"> <thead> <tr> <th>Code</th> <th>Description</th> <th>Qty</th> <th>UOM</th> </tr> </thead> <tbody> <tr> <td>CR1086A0</td> <td>INTERNAL GLASS LOWER HINGE</td> <td>1</td> <td>PZ</td> </tr> <tr> <td>GN1181A0</td> <td>INTERNAL GLASS HINGE SEAL</td> <td>1</td> <td>PZ</td> </tr> <tr> <td>VI1810A0</td> <td>M6X6 STAINLESS STEEL FLATHEAD SCREW</td> <td>3</td> <td>PZ</td> </tr> </tbody> </table>	Code	Description	Qty	UOM	CR1086A0	INTERNAL GLASS LOWER HINGE	1	PZ	GN1181A0	INTERNAL GLASS HINGE SEAL	1	PZ	VI1810A0	M6X6 STAINLESS STEEL FLATHEAD SCREW	3	PZ				
Code	Description	Qty	UOM																						
CR1086A0	INTERNAL GLASS LOWER HINGE	1	PZ																						
GN1181A0	INTERNAL GLASS HINGE SEAL	1	PZ																						
VI1810A0	M6X6 STAINLESS STEEL FLATHEAD SCREW	3	PZ																						
VT1140A	XB893/895 XBC804/805 INTERNAL GLASS		KVT1140A	XB893/895 XBC804/805 INTERNAL GLASS KI	<table border="1"> <thead> <tr> <th>Code</th> <th>Description</th> <th>Qty</th> <th>UOM</th> </tr> </thead> <tbody> <tr> <td>IP1508A1</td> <td>POLYSTYREN E U SHAPED PROFILE 2000X60X60</td> <td>2</td> <td>M</td> </tr> <tr> <td>VM1059A1</td> <td>HEAT SHRINK FILM H800</td> <td>1.500</td> <td>M</td> </tr> <tr> <td>VT1140A0</td> <td>XB893/895 XBC804/805 INTERNAL GLASS</td> <td>1</td> <td>PZ</td> </tr> <tr> <td>VT1140A0</td> <td>XB893/895 XBC804/805 INTERNAL GLASS</td> <td>1</td> <td>PZ</td> </tr> </tbody> </table>	Code	Description	Qty	UOM	IP1508A1	POLYSTYREN E U SHAPED PROFILE 2000X60X60	2	M	VM1059A1	HEAT SHRINK FILM H800	1.500	M	VT1140A0	XB893/895 XBC804/805 INTERNAL GLASS	1	PZ	VT1140A0	XB893/895 XBC804/805 INTERNAL GLASS	1	PZ
Code	Description	Qty	UOM																						
IP1508A1	POLYSTYREN E U SHAPED PROFILE 2000X60X60	2	M																						
VM1059A1	HEAT SHRINK FILM H800	1.500	M																						
VT1140A0	XB893/895 XBC804/805 INTERNAL GLASS	1	PZ																						
VT1140A0	XB893/895 XBC804/805 INTERNAL GLASS	1	PZ																						

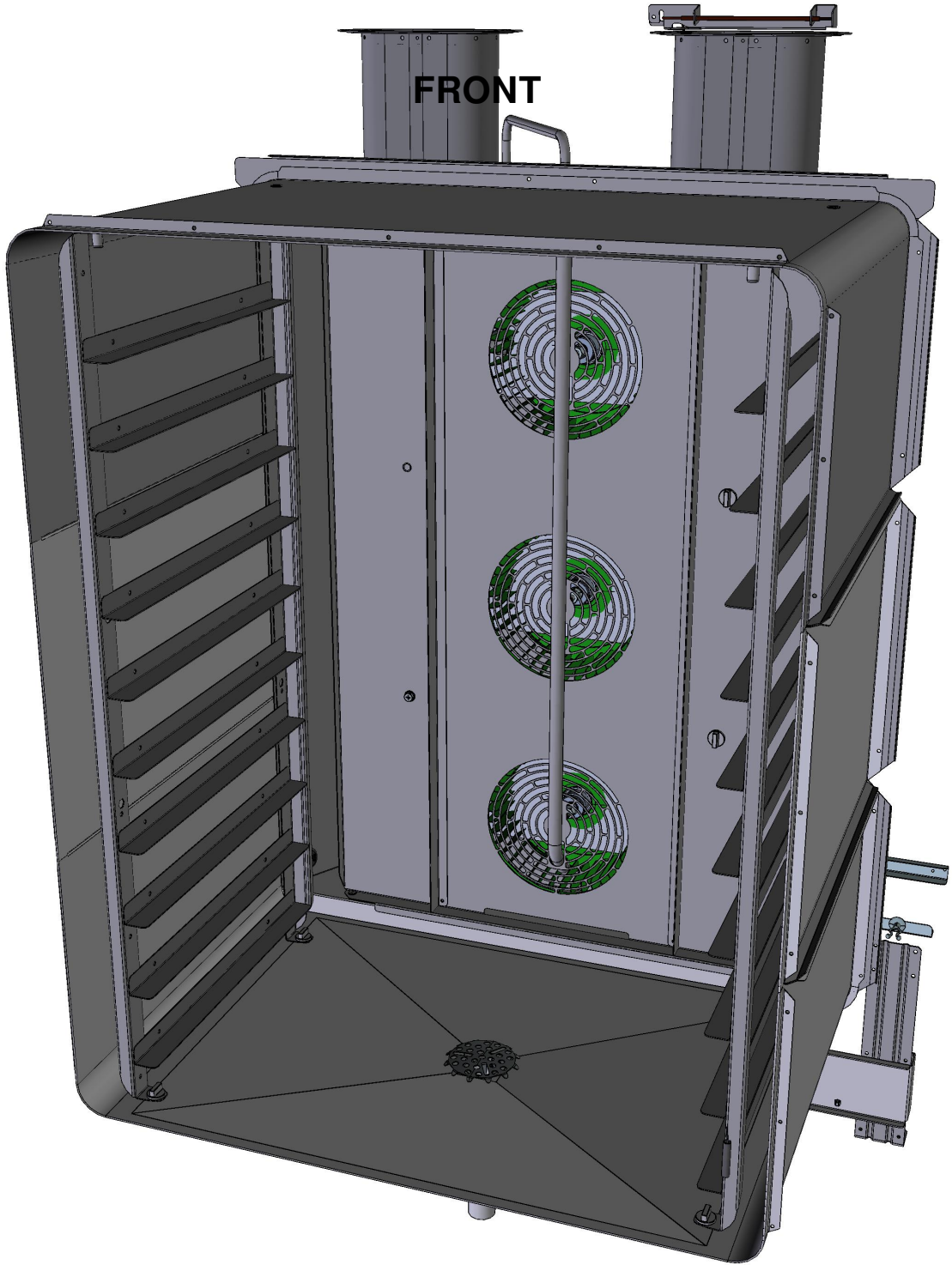

**ASM2109B/0.D00 - Cooking chamber**

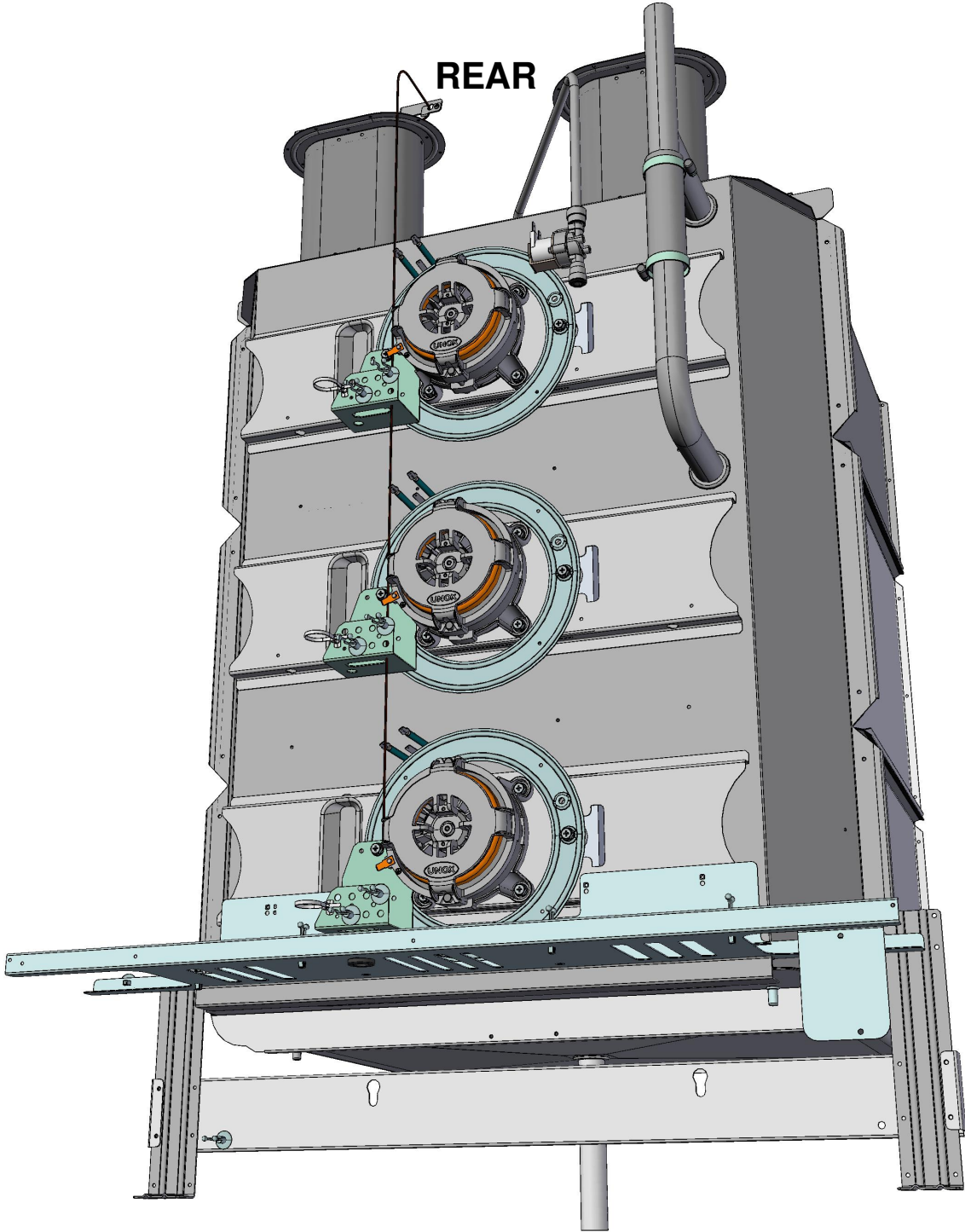

**ASM2109B/0.D00 - Cooking chamber**





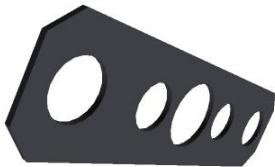

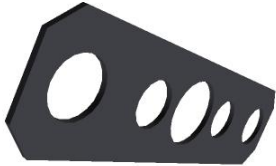
COMPONENT			SPARE PART																							
Code	Description	Image	Code	Description	Components list																					
0H4820A	BULB HOLDING BRACKET																									
0H2551A	XBC/XVC ST.STEEL DRAIN COVER		0H2551A0	XBC/XVC ST.STEEL DRAIN COVER																						
GN1326A	ELEMENT SEALING		KRS1274A	100W MOTOR BRAKING ELEMENT KIT	<table border="1"> <thead> <tr> <th>Code</th> <th>Description</th> <th>Qty</th> <th>UOM</th> </tr> </thead> <tbody> <tr> <td>GN1326A1</td> <td>ELEMENT SEALING</td> <td>1</td> <td>PZ</td> </tr> <tr> <td>RS1274A0</td> <td>100W 60V 1 TURN FLAT ELEMENT</td> <td>1</td> <td>PZ</td> </tr> <tr> <td>SL1045A0</td> <td>S53 BLACK SILICONE - 80ML CARTRIDGE</td> <td>1</td> <td>PZ</td> </tr> <tr> <td>VI1220A1</td> <td>4,2X12 TCB SELF-TAPPIN G SCREW</td> <td>2</td> <td>PZ</td> </tr> </tbody> </table>	Code	Description	Qty	UOM	GN1326A1	ELEMENT SEALING	1	PZ	RS1274A0	100W 60V 1 TURN FLAT ELEMENT	1	PZ	SL1045A0	S53 BLACK SILICONE - 80ML CARTRIDGE	1	PZ	VI1220A1	4,2X12 TCB SELF-TAPPIN G SCREW	2	PZ	
			Code	Description	Qty	UOM																				
GN1326A1	ELEMENT SEALING	1	PZ																							
RS1274A0	100W 60V 1 TURN FLAT ELEMENT	1	PZ																							
SL1045A0	S53 BLACK SILICONE - 80ML CARTRIDGE	1	PZ																							
VI1220A1	4,2X12 TCB SELF-TAPPIN G SCREW	2	PZ																							
KRS1261A	122W MOTOR BRAKING ELEMENT KIT	<table border="1"> <thead> <tr> <th>Code</th> <th>Description</th> <th>Qty</th> <th>UOM</th> </tr> </thead> <tbody> <tr> <td>GN1326A1</td> <td>ELEMENT SEALING</td> <td>1</td> <td>PZ</td> </tr> <tr> <td>RS1261A0</td> <td>BAKERLUX/CH EFLUX MOTOR BREAKING ELEMENT</td> <td>1</td> <td>PZ</td> </tr> <tr> <td>SL1045A0</td> <td>S53 BLACK SILICONE - 80ML CARTRIDGE</td> <td>1</td> <td>PZ</td> </tr> <tr> <td>VI1220A1</td> <td>4,2X12 TCB SELF-TAPPIN G SCREW</td> <td>2</td> <td>PZ</td> </tr> <tr> <td>VM2147A0</td> <td>ESD SPONGE PINK SMOOTH 410X343X15 M</td> <td>1</td> <td>PZ</td> </tr> </tbody> </table>	Code	Description	Qty	UOM	GN1326A1	ELEMENT SEALING	1	PZ	RS1261A0	BAKERLUX/CH EFLUX MOTOR BREAKING ELEMENT	1	PZ	SL1045A0	S53 BLACK SILICONE - 80ML CARTRIDGE	1	PZ	VI1220A1	4,2X12 TCB SELF-TAPPIN G SCREW	2	PZ	VM2147A0	ESD SPONGE PINK SMOOTH 410X343X15 M	1	PZ
Code	Description	Qty	UOM																							
GN1326A1	ELEMENT SEALING	1	PZ																							
RS1261A0	BAKERLUX/CH EFLUX MOTOR BREAKING ELEMENT	1	PZ																							
SL1045A0	S53 BLACK SILICONE - 80ML CARTRIDGE	1	PZ																							
VI1220A1	4,2X12 TCB SELF-TAPPIN G SCREW	2	PZ																							
VM2147A0	ESD SPONGE PINK SMOOTH 410X343X15 M	1	PZ																							

COMPONENT			SPARE PART																														
Code	Description	Image	Code	Description	Components list																												
GN1326A	ELEMENT SEALING		KRS1215A	147W MOTOR BRAKING ELEMENT KIT	<table border="1"> <thead> <tr> <th>Code</th> <th>Description</th> <th>Qty</th> <th>UOM</th> </tr> </thead> <tbody> <tr> <td>GN1326A1</td> <td>ELEMENT SEALING</td> <td>1</td> <td>PZ</td> </tr> <tr> <td>RS1215A1</td> <td>147W 105V BRAKING ELEMENT</td> <td>1</td> <td>PZ</td> </tr> <tr> <td>SL1045A0</td> <td>S53 BLACK SILICONE - 80ML CARTRIDGE</td> <td>1</td> <td>PZ</td> </tr> <tr> <td>VI1220A1</td> <td>4,2X12 TCB SELF-TAPPIN G SCREW</td> <td>2</td> <td>PZ</td> </tr> </tbody> </table>	Code	Description	Qty	UOM	GN1326A1	ELEMENT SEALING	1	PZ	RS1215A1	147W 105V BRAKING ELEMENT	1	PZ	SL1045A0	S53 BLACK SILICONE - 80ML CARTRIDGE	1	PZ	VI1220A1	4,2X12 TCB SELF-TAPPIN G SCREW	2	PZ								
			Code	Description	Qty	UOM																											
			GN1326A1	ELEMENT SEALING	1	PZ																											
			RS1215A1	147W 105V BRAKING ELEMENT	1	PZ																											
			SL1045A0	S53 BLACK SILICONE - 80ML CARTRIDGE	1	PZ																											
			VI1220A1	4,2X12 TCB SELF-TAPPIN G SCREW	2	PZ																											
			KRS1095A	1.2KW HEATING ELEMENT KIT	<table border="1"> <thead> <tr> <th>Code</th> <th>Description</th> <th>Qty</th> <th>UOM</th> </tr> </thead> <tbody> <tr> <td>GN1326A1</td> <td>ELEMENT SEALING</td> <td>1</td> <td>PZ</td> </tr> <tr> <td>IP1385A1</td> <td>CORNER POLYSTYREN E PACKING 110X80X2000</td> <td>0.500</td> <td>M</td> </tr> <tr> <td>RS1095A1</td> <td>HEATING ELEMENT 1200W 230V</td> <td>1</td> <td>PZ</td> </tr> <tr> <td>SL1045A0</td> <td>S53 BLACK SILICONE - 80ML CARTRIDGE</td> <td>1</td> <td>PZ</td> </tr> <tr> <td>VI1220A1</td> <td>4,2X12 TCB SELF-TAPPIN G SCREW</td> <td>2</td> <td>PZ</td> </tr> <tr> <td>VM1059A1</td> <td>HEAT SHRINK FILM H800</td> <td>1.200</td> <td>M</td> </tr> </tbody> </table>	Code	Description	Qty	UOM	GN1326A1	ELEMENT SEALING	1	PZ	IP1385A1	CORNER POLYSTYREN E PACKING 110X80X2000	0.500	M	RS1095A1	HEATING ELEMENT 1200W 230V	1	PZ	SL1045A0	S53 BLACK SILICONE - 80ML CARTRIDGE	1	PZ	VI1220A1	4,2X12 TCB SELF-TAPPIN G SCREW	2	PZ	VM1059A1	HEAT SHRINK FILM H800	1.200	M
			Code	Description	Qty	UOM																											
			GN1326A1	ELEMENT SEALING	1	PZ																											
			IP1385A1	CORNER POLYSTYREN E PACKING 110X80X2000	0.500	M																											
			RS1095A1	HEATING ELEMENT 1200W 230V	1	PZ																											
			SL1045A0	S53 BLACK SILICONE - 80ML CARTRIDGE	1	PZ																											
VI1220A1	4,2X12 TCB SELF-TAPPIN G SCREW	2	PZ																														
VM1059A1	HEAT SHRINK FILM H800	1.200	M																														
KRS1012A	1365W 120V HEATING ELEMENT KIT	<table border="1"> <thead> <tr> <th>Code</th> <th>Description</th> <th>Qty</th> <th>UOM</th> </tr> </thead> <tbody> <tr> <td>GN1326A1</td> <td>ELEMENT SEALING</td> <td>1</td> <td>PZ</td> </tr> <tr> <td>RS1012A0</td> <td>CIRCULAR ELEMENT 1365W 120V</td> <td>1</td> <td>PZ</td> </tr> <tr> <td>VI1220A1</td> <td>4,2X12 TCB SELF-TAPPIN G SCREW</td> <td>5</td> <td>PZ</td> </tr> <tr> <td>VM1794A0</td> <td>250X4.8 PA66 BLACK CLAMP</td> <td>2</td> <td>PZ</td> </tr> <tr> <td>VM2103A0</td> <td>CLAMP LOCK</td> <td>2</td> <td>PZ</td> </tr> </tbody> </table>	Code	Description	Qty	UOM	GN1326A1	ELEMENT SEALING	1	PZ	RS1012A0	CIRCULAR ELEMENT 1365W 120V	1	PZ	VI1220A1	4,2X12 TCB SELF-TAPPIN G SCREW	5	PZ	VM1794A0	250X4.8 PA66 BLACK CLAMP	2	PZ	VM2103A0	CLAMP LOCK	2	PZ							
Code	Description	Qty	UOM																														
GN1326A1	ELEMENT SEALING	1	PZ																														
RS1012A0	CIRCULAR ELEMENT 1365W 120V	1	PZ																														
VI1220A1	4,2X12 TCB SELF-TAPPIN G SCREW	5	PZ																														
VM1794A0	250X4.8 PA66 BLACK CLAMP	2	PZ																														
VM2103A0	CLAMP LOCK	2	PZ																														
KRS1011A	ROBERTA/LISA HEATING ELEMENT KIT	<table border="1"> <thead> <tr> <th>Code</th> <th>Description</th> <th>Qty</th> <th>UOM</th> </tr> </thead> <tbody> <tr> <td>GN1326A1</td> <td>ELEMENT SEALING</td> <td>1</td> <td>PZ</td> </tr> <tr> <td>RS1011A0</td> <td>2560W 220-230V HEATING ELEMENT</td> <td>1</td> <td>PZ</td> </tr> </tbody> </table>	Code	Description	Qty	UOM	GN1326A1	ELEMENT SEALING	1	PZ	RS1011A0	2560W 220-230V HEATING ELEMENT	1	PZ																			
Code	Description	Qty	UOM																														
GN1326A1	ELEMENT SEALING	1	PZ																														
RS1011A0	2560W 220-230V HEATING ELEMENT	1	PZ																														

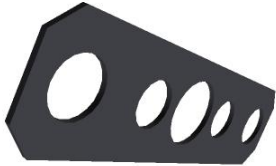

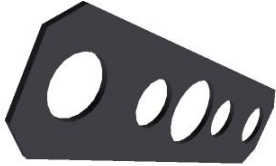
COMPONENT			SPARE PART																										
Code	Description	Image	Code	Description	Components list																								
GN1326A	ELEMENT SEALING		KRS1011A	ROBERTA/LISA HEATING ELEMENT KIT	<table border="1"> <thead> <tr> <th>Code</th> <th>Description</th> <th>Qty</th> <th>UOM</th> </tr> </thead> <tbody> <tr> <td>SL1045A0</td> <td>S53 BLACK SILICONE - 80ML CARTRIDGE</td> <td>1</td> <td>PZ</td> </tr> <tr> <td>V11220A1</td> <td>4,2X12 TCB SELF-TAPPIN G SCREW</td> <td>5</td> <td>PZ</td> </tr> <tr> <td>VM1794A0</td> <td>250X4.8 PA66 BLACK CLAMP</td> <td>2</td> <td>PZ</td> </tr> <tr> <td>VM2103A0</td> <td>CLAMP LOCK</td> <td>2</td> <td>PZ</td> </tr> </tbody> </table>	Code	Description	Qty	UOM	SL1045A0	S53 BLACK SILICONE - 80ML CARTRIDGE	1	PZ	V11220A1	4,2X12 TCB SELF-TAPPIN G SCREW	5	PZ	VM1794A0	250X4.8 PA66 BLACK CLAMP	2	PZ	VM2103A0	CLAMP LOCK	2	PZ				
			Code	Description	Qty	UOM																							
			SL1045A0	S53 BLACK SILICONE - 80ML CARTRIDGE	1	PZ																							
			V11220A1	4,2X12 TCB SELF-TAPPIN G SCREW	5	PZ																							
			VM1794A0	250X4.8 PA66 BLACK CLAMP	2	PZ																							
			VM2103A0	CLAMP LOCK	2	PZ																							
			KRS0090A	HEATING ELEMENT 1.26KW	<table border="1"> <thead> <tr> <th>Code</th> <th>Description</th> <th>Qty</th> <th>UOM</th> </tr> </thead> <tbody> <tr> <td>GN1326A1</td> <td>ELEMENT SEALING</td> <td>1</td> <td>PZ</td> </tr> <tr> <td>RS0090A0</td> <td>CIRC. HEAT. ELEMENT 1260W 220-230</td> <td>1</td> <td>PZ</td> </tr> <tr> <td>V11220A1</td> <td>4,2X12 TCB SELF-TAPPIN G SCREW</td> <td>3</td> <td>PZ</td> </tr> <tr> <td>VM1794A0</td> <td>250X4.8 PA66 BLACK CLAMP</td> <td>2</td> <td>PZ</td> </tr> <tr> <td>VM2103A0</td> <td>CLAMP LOCK</td> <td>2</td> <td>PZ</td> </tr> </tbody> </table>	Code	Description	Qty	UOM	GN1326A1	ELEMENT SEALING	1	PZ	RS0090A0	CIRC. HEAT. ELEMENT 1260W 220-230	1	PZ	V11220A1	4,2X12 TCB SELF-TAPPIN G SCREW	3	PZ	VM1794A0	250X4.8 PA66 BLACK CLAMP	2	PZ	VM2103A0	CLAMP LOCK	2	PZ
			Code	Description	Qty	UOM																							
			GN1326A1	ELEMENT SEALING	1	PZ																							
			RS0090A0	CIRC. HEAT. ELEMENT 1260W 220-230	1	PZ																							
			V11220A1	4,2X12 TCB SELF-TAPPIN G SCREW	3	PZ																							
			VM1794A0	250X4.8 PA66 BLACK CLAMP	2	PZ																							
			VM2103A0	CLAMP LOCK	2	PZ																							
			KRS0050A	HEATING ELEMENT KIT 0.5KW	<table border="1"> <thead> <tr> <th>Code</th> <th>Description</th> <th>Qty</th> <th>UOM</th> </tr> </thead> <tbody> <tr> <td>GN1326A1</td> <td>ELEMENT SEALING</td> <td>1</td> <td>PZ</td> </tr> <tr> <td>IP1075A1</td> <td></td> <td>1</td> <td>PZ</td> </tr> <tr> <td>IP1080A1</td> <td></td> <td>1</td> <td>PZ</td> </tr> <tr> <td>RS0050A0</td> <td>HEAT. ELEMENT 500W 220-230V LIEV</td> <td>1</td> <td>PZ</td> </tr> <tr> <td>V11220A1</td> <td>4,2X12 TCB SELF-TAPPIN G SCREW</td> <td>2</td> <td>PZ</td> </tr> </tbody> </table>	Code	Description	Qty	UOM	GN1326A1	ELEMENT SEALING	1	PZ	IP1075A1		1	PZ	IP1080A1		1	PZ	RS0050A0	HEAT. ELEMENT 500W 220-230V LIEV	1	PZ	V11220A1	4,2X12 TCB SELF-TAPPIN G SCREW	2	PZ
			Code	Description	Qty	UOM																							
			GN1326A1	ELEMENT SEALING	1	PZ																							
IP1075A1		1	PZ																										
IP1080A1		1	PZ																										
RS0050A0	HEAT. ELEMENT 500W 220-230V LIEV	1	PZ																										
V11220A1	4,2X12 TCB SELF-TAPPIN G SCREW	2	PZ																										
KRS0011A	HEATING ELEMENT 1.465KW RS0011A	<table border="1"> <thead> <tr> <th>Code</th> <th>Description</th> <th>Qty</th> <th>UOM</th> </tr> </thead> <tbody> <tr> <td>GN1326A1</td> <td>ELEMENT SEALING</td> <td>1</td> <td>PZ</td> </tr> <tr> <td>RS0011A0</td> <td>CIRC.HEAT. ELEMENT 1465W 220-230</td> <td>1</td> <td>PZ</td> </tr> <tr> <td>V11220A1</td> <td>4,2X12 TCB SELF-TAPPIN G SCREW</td> <td>3</td> <td>PZ</td> </tr> <tr> <td>VM1794A0</td> <td>250X4.8 PA66 BLACK CLAMP</td> <td>2</td> <td>PZ</td> </tr> <tr> <td>VM2103A0</td> <td>CLAMP LOCK</td> <td>2</td> <td>PZ</td> </tr> </tbody> </table>	Code	Description	Qty	UOM	GN1326A1	ELEMENT SEALING	1	PZ	RS0011A0	CIRC.HEAT. ELEMENT 1465W 220-230	1	PZ	V11220A1	4,2X12 TCB SELF-TAPPIN G SCREW	3	PZ	VM1794A0	250X4.8 PA66 BLACK CLAMP	2	PZ	VM2103A0	CLAMP LOCK	2	PZ			
Code	Description	Qty	UOM																										
GN1326A1	ELEMENT SEALING	1	PZ																										
RS0011A0	CIRC.HEAT. ELEMENT 1465W 220-230	1	PZ																										
V11220A1	4,2X12 TCB SELF-TAPPIN G SCREW	3	PZ																										
VM1794A0	250X4.8 PA66 BLACK CLAMP	2	PZ																										
VM2103A0	CLAMP LOCK	2	PZ																										
KRS0010A	KIT HEATING ELEMENT RS10010A	<table border="1"> <thead> <tr> <th>Code</th> <th>Description</th> <th>Qty</th> <th>UOM</th> </tr> </thead> <tbody> <tr> <td>GN1326A1</td> <td>ELEMENT SEALING</td> <td>1</td> <td>PZ</td> </tr> <tr> <td>IP1075A1</td> <td></td> <td>1</td> <td>PZ</td> </tr> </tbody> </table>	Code	Description	Qty	UOM	GN1326A1	ELEMENT SEALING	1	PZ	IP1075A1		1	PZ															
Code	Description	Qty	UOM																										
GN1326A1	ELEMENT SEALING	1	PZ																										
IP1075A1		1	PZ																										

COMPONENT			SPARE PART																																																						
Code	Description	Image	Code	Description	Components list																																																				
GN1326A	ELEMENT SEALING		KRS0010A	KIT HEATING ELEMENT RS10010A	<table border="1"> <thead> <tr> <th>Code</th> <th>Description</th> <th>Qty</th> <th>UOM</th> </tr> </thead> <tbody> <tr> <td>IP1080A1</td> <td></td> <td>5</td> <td>PZ</td> </tr> <tr> <td>RS0010A0</td> <td>CIRC.HEAT. ELEMENT 2560W - 220-230 V</td> <td>1</td> <td>PZ</td> </tr> <tr> <td>VI1220A1</td> <td>4,2X12 TCB SELF-TAPPIN G SCREW</td> <td>3</td> <td>PZ</td> </tr> </tbody> </table>	Code	Description	Qty	UOM	IP1080A1		5	PZ	RS0010A0	CIRC.HEAT. ELEMENT 2560W - 220-230 V	1	PZ	VI1220A1	4,2X12 TCB SELF-TAPPIN G SCREW	3	PZ																																				
			Code	Description	Qty	UOM																																																			
IP1080A1		5	PZ																																																						
RS0010A0	CIRC.HEAT. ELEMENT 2560W - 220-230 V	1	PZ																																																						
VI1220A1	4,2X12 TCB SELF-TAPPIN G SCREW	3	PZ																																																						
KGN1326A	HEATING ELEMENT GASKET 5 PCS KIT	<table border="1"> <thead> <tr> <th>Code</th> <th>Description</th> <th>Qty</th> <th>UOM</th> </tr> </thead> <tbody> <tr> <td>GN1326A1</td> <td>ELEMENT SEALING</td> <td>5</td> <td>PZ</td> </tr> </tbody> </table>	Code	Description	Qty	UOM	GN1326A1	ELEMENT SEALING	5	PZ																																															
Code	Description	Qty	UOM																																																						
GN1326A1	ELEMENT SEALING	5	PZ																																																						
VM1465A	CHEFTOP TEMPERATURE PROBE COVER		VM1465A0	CHEFTOP TEMPERATURE PROBE COVER																																																					
RC1378A	HOSE CLAMP		KVE1135A	SERIES 5/5E VENTURI KIT	<table border="1"> <thead> <tr> <th>Code</th> <th>Description</th> <th>Qty</th> <th>UOM</th> </tr> </thead> <tbody> <tr> <td>GN1556A0</td> <td>MM VENTURI SEAL</td> <td>1</td> <td>PZ</td> </tr> <tr> <td>RC1378A0</td> <td>HOSE CLAMP</td> <td>2</td> <td>PZ</td> </tr> <tr> <td>TB1520A0</td> <td>INT. Ø=38 TH=4 DRAIN BLACK RUBBER PIPE</td> <td>0.050</td> <td>M</td> </tr> <tr> <td>VE1135A0</td> <td>220 V 50/60 HZ VENTURI ACTUATOR</td> <td>1</td> <td>PZ</td> </tr> <tr> <td>VI1032A0</td> <td>SCREW M4X16 TCB+ INOX</td> <td>1</td> <td>PZ</td> </tr> <tr> <td>VI1511A0</td> <td>STAINLESS STEEL WASHER 4.2X12X1</td> <td>2</td> <td>PZ</td> </tr> <tr> <td>VI1850A0</td> <td>M4X6 NICKEL PLATED FIXING SCRE</td> <td>2</td> <td>PZ</td> </tr> <tr> <td>VI1865A0</td> <td>5X10 TCB+ SELF-THREADI NG SCREW</td> <td>3</td> <td>PZ</td> </tr> <tr> <td>VM1565B0</td> <td>VENTURI LOWER COIL SUPPORT</td> <td>1</td> <td>PZ</td> </tr> <tr> <td>VM1566A0</td> <td>VENTURI UPPER COIL SUPPORT</td> <td>1</td> <td>PZ</td> </tr> <tr> <td>VM1567A0</td> <td>VENTURI LOWER BUSHING</td> <td>1</td> <td>PZ</td> </tr> <tr> <td>VM1568A0</td> <td>VENTURI PLATE SPACE</td> <td>1</td> <td>PZ</td> </tr> </tbody> </table>	Code	Description	Qty	UOM	GN1556A0	MM VENTURI SEAL	1	PZ	RC1378A0	HOSE CLAMP	2	PZ	TB1520A0	INT. Ø=38 TH=4 DRAIN BLACK RUBBER PIPE	0.050	M	VE1135A0	220 V 50/60 HZ VENTURI ACTUATOR	1	PZ	VI1032A0	SCREW M4X16 TCB+ INOX	1	PZ	VI1511A0	STAINLESS STEEL WASHER 4.2X12X1	2	PZ	VI1850A0	M4X6 NICKEL PLATED FIXING SCRE	2	PZ	VI1865A0	5X10 TCB+ SELF-THREADI NG SCREW	3	PZ	VM1565B0	VENTURI LOWER COIL SUPPORT	1	PZ	VM1566A0	VENTURI UPPER COIL SUPPORT	1	PZ	VM1567A0	VENTURI LOWER BUSHING	1	PZ	VM1568A0	VENTURI PLATE SPACE	1	PZ
					Code	Description	Qty	UOM																																																	
					GN1556A0	MM VENTURI SEAL	1	PZ																																																	
					RC1378A0	HOSE CLAMP	2	PZ																																																	
					TB1520A0	INT. Ø=38 TH=4 DRAIN BLACK RUBBER PIPE	0.050	M																																																	
					VE1135A0	220 V 50/60 HZ VENTURI ACTUATOR	1	PZ																																																	
					VI1032A0	SCREW M4X16 TCB+ INOX	1	PZ																																																	
					VI1511A0	STAINLESS STEEL WASHER 4.2X12X1	2	PZ																																																	
					VI1850A0	M4X6 NICKEL PLATED FIXING SCRE	2	PZ																																																	
					VI1865A0	5X10 TCB+ SELF-THREADI NG SCREW	3	PZ																																																	
					VM1565B0	VENTURI LOWER COIL SUPPORT	1	PZ																																																	
					VM1566A0	VENTURI UPPER COIL SUPPORT	1	PZ																																																	
					VM1567A0	VENTURI LOWER BUSHING	1	PZ																																																	
					VM1568A0	VENTURI PLATE SPACE	1	PZ																																																	









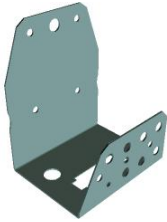

COMPONENT			SPARE PART																																																																														
Code	Description	Image	Code	Description	Components list																																																																												
GN1312A	RUBBER CABLE-PASSING DE=26 DI=15 SP=10		KVL0001A	LM TOP CLEANING SYSTEM KIT	<table border="1"> <thead> <tr> <th>Code</th> <th>Description</th> <th>Qty</th> <th>UOM</th> </tr> </thead> <tbody> <tr> <td>0H1226B0</td> <td>LINEMISSTOP WASHING SYTEM CIRCUIT COVE</td> <td>1</td> <td>PZ</td> </tr> <tr> <td>GN1312A0</td> <td>RUBBER CABLE-PASSI NG DE=26 DI=15 SP=10</td> <td>1</td> <td>PZ</td> </tr> <tr> <td>GN1526A0</td> <td>INT. D.=6.9 TH=1.8 O-RIN</td> <td>1</td> <td>PZ</td> </tr> <tr> <td>RC1019A0</td> <td>D=10 ELASTIC CLAMP</td> <td>5</td> <td>PZ</td> </tr> <tr> <td>RC1242A0</td> <td>D=10 CLOSED CAP</td> <td>2</td> <td>PZ</td> </tr> <tr> <td>RC1381A0</td> <td>BIFILAR PIPE CLIP D10.7</td> <td>3</td> <td>PZ</td> </tr> <tr> <td>TB2343A0</td> <td>9X6 PVC TRANSPAREN T PIPE</td> <td>1.650</td> <td>M</td> </tr> <tr> <td>TB2820A0</td> <td>PIPE EPDM FOR WASHING SYSTEM</td> <td>0.990</td> <td>M</td> </tr> <tr> <td>VH1220A1</td> <td>4,2X12 TCB SELF-TAPPIN G SCREW</td> <td>1</td> <td>PZ</td> </tr> <tr> <td>VL1019A0</td> <td>VIBRATION PUMP</td> <td>1</td> <td>PZ</td> </tr> <tr> <td>VL1041C0</td> <td>DETERGENT CAP WITH Ø12 HOLE</td> <td>1</td> <td>PZ</td> </tr> <tr> <td>VL1047A1</td> <td>D6 PIPE HOLDER - D8 J.G. TERMINAL</td> <td>1</td> <td>PZ</td> </tr> <tr> <td>VL1053B0</td> <td>ONE WASHING SYS EXT DISTRIBUTOR</td> <td>1</td> <td>PZ</td> </tr> <tr> <td>VL1054B0</td> <td>ONE WASHING SYS INLET DISTRIBUTOR</td> <td>1</td> <td>PZ</td> </tr> <tr> <td>VL1061A0</td> <td>HOLD DOWN WEIGHT+NET FILTER+NON- RET. V.</td> <td>1</td> <td>PZ</td> </tr> <tr> <td>VL1128A0</td> <td>BARBED CHECK VALVE D6</td> <td>2</td> <td>PZ</td> </tr> <tr> <td>VM1066A0</td> <td>SADDLE CLIP FOR CABLES PASSING</td> <td>3</td> <td>PZ</td> </tr> <tr> <td>VM1088A0</td> <td>NYLON CLICK CLAMP D7.9-D9.2</td> <td>1</td> <td>PZ</td> </tr> </tbody> </table>	Code	Description	Qty	UOM	0H1226B0	LINEMISSTOP WASHING SYTEM CIRCUIT COVE	1	PZ	GN1312A0	RUBBER CABLE-PASSI NG DE=26 DI=15 SP=10	1	PZ	GN1526A0	INT. D.=6.9 TH=1.8 O-RIN	1	PZ	RC1019A0	D=10 ELASTIC CLAMP	5	PZ	RC1242A0	D=10 CLOSED CAP	2	PZ	RC1381A0	BIFILAR PIPE CLIP D10.7	3	PZ	TB2343A0	9X6 PVC TRANSPAREN T PIPE	1.650	M	TB2820A0	PIPE EPDM FOR WASHING SYSTEM	0.990	M	VH1220A1	4,2X12 TCB SELF-TAPPIN G SCREW	1	PZ	VL1019A0	VIBRATION PUMP	1	PZ	VL1041C0	DETERGENT CAP WITH Ø12 HOLE	1	PZ	VL1047A1	D6 PIPE HOLDER - D8 J.G. TERMINAL	1	PZ	VL1053B0	ONE WASHING SYS EXT DISTRIBUTOR	1	PZ	VL1054B0	ONE WASHING SYS INLET DISTRIBUTOR	1	PZ	VL1061A0	HOLD DOWN WEIGHT+NET FILTER+NON- RET. V.	1	PZ	VL1128A0	BARBED CHECK VALVE D6	2	PZ	VM1066A0	SADDLE CLIP FOR CABLES PASSING	3	PZ	VM1088A0	NYLON CLICK CLAMP D7.9-D9.2	1	PZ
Code	Description	Qty	UOM																																																																														
0H1226B0	LINEMISSTOP WASHING SYTEM CIRCUIT COVE	1	PZ																																																																														
GN1312A0	RUBBER CABLE-PASSI NG DE=26 DI=15 SP=10	1	PZ																																																																														
GN1526A0	INT. D.=6.9 TH=1.8 O-RIN	1	PZ																																																																														
RC1019A0	D=10 ELASTIC CLAMP	5	PZ																																																																														
RC1242A0	D=10 CLOSED CAP	2	PZ																																																																														
RC1381A0	BIFILAR PIPE CLIP D10.7	3	PZ																																																																														
TB2343A0	9X6 PVC TRANSPAREN T PIPE	1.650	M																																																																														
TB2820A0	PIPE EPDM FOR WASHING SYSTEM	0.990	M																																																																														
VH1220A1	4,2X12 TCB SELF-TAPPIN G SCREW	1	PZ																																																																														
VL1019A0	VIBRATION PUMP	1	PZ																																																																														
VL1041C0	DETERGENT CAP WITH Ø12 HOLE	1	PZ																																																																														
VL1047A1	D6 PIPE HOLDER - D8 J.G. TERMINAL	1	PZ																																																																														
VL1053B0	ONE WASHING SYS EXT DISTRIBUTOR	1	PZ																																																																														
VL1054B0	ONE WASHING SYS INLET DISTRIBUTOR	1	PZ																																																																														
VL1061A0	HOLD DOWN WEIGHT+NET FILTER+NON- RET. V.	1	PZ																																																																														
VL1128A0	BARBED CHECK VALVE D6	2	PZ																																																																														
VM1066A0	SADDLE CLIP FOR CABLES PASSING	3	PZ																																																																														
VM1088A0	NYLON CLICK CLAMP D7.9-D9.2	1	PZ																																																																														

COMPONENT			SPARE PART																						
Code	Description	Image	Code	Description	Components list																				
GN1312A	RUBBER CABLE-PASSING DE=26 DI=15 SP=10		KVL0001A	LM TOP CLEANING SYSTEM KIT	<table border="1"> <thead> <tr> <th>Code</th> <th>Description</th> <th>Qty</th> <th>UOM</th> </tr> </thead> <tbody> <tr> <td>VM1605A0</td> <td>CLIP TWIST LOCK DIAM. 10,2-12,7 MM</td> <td>1</td> <td>PZ</td> </tr> <tr> <td>VM2172A0</td> <td>PUMP LOCKING CLIP</td> <td>1</td> <td>PZ</td> </tr> </tbody> </table>	Code	Description	Qty	UOM	VM1605A0	CLIP TWIST LOCK DIAM. 10,2-12,7 MM	1	PZ	VM2172A0	PUMP LOCKING CLIP	1	PZ								
Code	Description	Qty	UOM																						
VM1605A0	CLIP TWIST LOCK DIAM. 10,2-12,7 MM	1	PZ																						
VM2172A0	PUMP LOCKING CLIP	1	PZ																						
EL1252A	1 WAY WATER VALVE + J.G. CONNECTION		KEL1252A	EL2 JG D8-D10 1 WAY SOLENOID VALVE KIT	<table border="1"> <thead> <tr> <th>Code</th> <th>Description</th> <th>Qty</th> <th>UOM</th> </tr> </thead> <tbody> <tr> <td>EL1252A1</td> <td>1 WAY WATER VALVE + J.G. CONNECTION</td> <td>1</td> <td>PZ</td> </tr> </tbody> </table>	Code	Description	Qty	UOM	EL1252A1	1 WAY WATER VALVE + J.G. CONNECTION	1	PZ												
Code	Description	Qty	UOM																						
EL1252A1	1 WAY WATER VALVE + J.G. CONNECTION	1	PZ																						
VM1610A	CLIP TWIST LOCK DIAM. 7,6-10,2 MM		VM1610A0	CLIP TWIST LOCK DIAM. 7,6-10,2 MM																					
GN1140A	MOTOR HOLDER GASKET		KGN1140A	5 PCS. MOTOR HOLDER GASKET KI	<table border="1"> <thead> <tr> <th>Code</th> <th>Description</th> <th>Qty</th> <th>UOM</th> </tr> </thead> <tbody> <tr> <td>GN1140A2</td> <td>MOTOR HOLDER GASKET</td> <td>5</td> <td>PZ</td> </tr> </tbody> </table>	Code	Description	Qty	UOM	GN1140A2	MOTOR HOLDER GASKET	5	PZ												
Code	Description	Qty	UOM																						
GN1140A2	MOTOR HOLDER GASKET	5	PZ																						
OH4305A	ST. STEEL MOTOR SHAFT SEALING DIS		KOH4305A	SEALING DISC FOR MOTOR SHAFT KIT	<table border="1"> <thead> <tr> <th>Code</th> <th>Description</th> <th>Qty</th> <th>UOM</th> </tr> </thead> <tbody> <tr> <td>OH4305A1</td> <td>ST. STEEL MOTOR SHAFT SEALING DISC</td> <td>1</td> <td>PZ</td> </tr> <tr> <td>GN1140A2</td> <td>MOTOR HOLDER GASKET</td> <td>1</td> <td>PZ</td> </tr> <tr> <td>SL1045A0</td> <td>S53 BLACK SILICONE - 80ML CARTRIDGE</td> <td>1</td> <td>PZ</td> </tr> <tr> <td>VI1220A1</td> <td>4,2X12 TCB SELF-TAPPIN G SCREW</td> <td>3</td> <td>PZ</td> </tr> </tbody> </table>	Code	Description	Qty	UOM	OH4305A1	ST. STEEL MOTOR SHAFT SEALING DISC	1	PZ	GN1140A2	MOTOR HOLDER GASKET	1	PZ	SL1045A0	S53 BLACK SILICONE - 80ML CARTRIDGE	1	PZ	VI1220A1	4,2X12 TCB SELF-TAPPIN G SCREW	3	PZ
Code	Description	Qty	UOM																						
OH4305A1	ST. STEEL MOTOR SHAFT SEALING DISC	1	PZ																						
GN1140A2	MOTOR HOLDER GASKET	1	PZ																						
SL1045A0	S53 BLACK SILICONE - 80ML CARTRIDGE	1	PZ																						
VI1220A1	4,2X12 TCB SELF-TAPPIN G SCREW	3	PZ																						



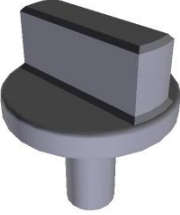

COMPONENT			SPARE PART																																										
Code	Description	Image	Code	Description	Components list																																								
VN1130A	330W 230V 50/60HZ MOTOR		KVN1130A	330W 230V 50/60HZ MOTOR KIT	<table border="1"> <thead> <tr> <th>Code</th> <th>Description</th> <th>Qty</th> <th>UOM</th> </tr> </thead> <tbody> <tr> <td>0H4305A1</td> <td>ST. STEEL MOTOR SHAFT SEALING DISC</td> <td>1</td> <td>PZ</td> </tr> <tr> <td>GN1140A2</td> <td>MOTOR HOLDER GASKET</td> <td>1</td> <td>PZ</td> </tr> <tr> <td>V11045A0</td> <td>16X8,4 TH=1,6 ST.STEEL WASHER</td> <td>1</td> <td>PZ</td> </tr> <tr> <td>V11256A0</td> <td>M8 DIN 980M ST. STEEL SELF LOCKING NUT</td> <td>1</td> <td>PZ</td> </tr> <tr> <td>VM1794A0</td> <td>250X4,8 PA66 BLACK CLAMP</td> <td>4</td> <td>PZ</td> </tr> <tr> <td>VM2103A0</td> <td>CLAMP LOCK</td> <td>4</td> <td>PZ</td> </tr> <tr> <td>VM2196A0</td> <td>MOTOR NUT FIXING BUSHING</td> <td>1</td> <td>PZ</td> </tr> <tr> <td>VN1130A1</td> <td>330W 230V 50/60HZ MOTO</td> <td>1</td> <td>PZ</td> </tr> <tr> <td>VN1130A1</td> <td>330W 230V 50/60HZ MOTO</td> <td>1</td> <td>PZ</td> </tr> </tbody> </table>	Code	Description	Qty	UOM	0H4305A1	ST. STEEL MOTOR SHAFT SEALING DISC	1	PZ	GN1140A2	MOTOR HOLDER GASKET	1	PZ	V11045A0	16X8,4 TH=1,6 ST.STEEL WASHER	1	PZ	V11256A0	M8 DIN 980M ST. STEEL SELF LOCKING NUT	1	PZ	VM1794A0	250X4,8 PA66 BLACK CLAMP	4	PZ	VM2103A0	CLAMP LOCK	4	PZ	VM2196A0	MOTOR NUT FIXING BUSHING	1	PZ	VN1130A1	330W 230V 50/60HZ MOTO	1	PZ	VN1130A1	330W 230V 50/60HZ MOTO	1	PZ
					Code	Description	Qty	UOM																																					
					0H4305A1	ST. STEEL MOTOR SHAFT SEALING DISC	1	PZ																																					
					GN1140A2	MOTOR HOLDER GASKET	1	PZ																																					
					V11045A0	16X8,4 TH=1,6 ST.STEEL WASHER	1	PZ																																					
					V11256A0	M8 DIN 980M ST. STEEL SELF LOCKING NUT	1	PZ																																					
					VM1794A0	250X4,8 PA66 BLACK CLAMP	4	PZ																																					
					VM2103A0	CLAMP LOCK	4	PZ																																					
					VM2196A0	MOTOR NUT FIXING BUSHING	1	PZ																																					
					VN1130A1	330W 230V 50/60HZ MOTO	1	PZ																																					
VN1130A1	330W 230V 50/60HZ MOTO	1	PZ																																										
VN1030A	Ø196 H81 38 BLADES MOTOR FA		KVN1030A	SERIES 5/5E XVC-XBC D196 H81 FAN KIT	<table border="1"> <thead> <tr> <th>Code</th> <th>Description</th> <th>Qty</th> <th>UOM</th> </tr> </thead> <tbody> <tr> <td>V11256A0</td> <td>M8 DIN 980M ST. STEEL SELF LOCKING NUT</td> <td>1</td> <td>PZ</td> </tr> <tr> <td>VM2196A0</td> <td>MOTOR NUT FIXING BUSHING</td> <td>1</td> <td>PZ</td> </tr> <tr> <td>VN1030A5</td> <td>Ø196 H81 38 BLADES MOTOR FAN</td> <td>1</td> <td>PZ</td> </tr> <tr> <td>VN1030A5</td> <td>Ø196 H81 38 BLADES MOTOR FAN</td> <td>1</td> <td>PZ</td> </tr> </tbody> </table>	Code	Description	Qty	UOM	V11256A0	M8 DIN 980M ST. STEEL SELF LOCKING NUT	1	PZ	VM2196A0	MOTOR NUT FIXING BUSHING	1	PZ	VN1030A5	Ø196 H81 38 BLADES MOTOR FAN	1	PZ	VN1030A5	Ø196 H81 38 BLADES MOTOR FAN	1	PZ																				
					Code	Description	Qty	UOM																																					
					V11256A0	M8 DIN 980M ST. STEEL SELF LOCKING NUT	1	PZ																																					
					VM2196A0	MOTOR NUT FIXING BUSHING	1	PZ																																					
VN1030A5	Ø196 H81 38 BLADES MOTOR FAN	1	PZ																																										
VN1030A5	Ø196 H81 38 BLADES MOTOR FAN	1	PZ																																										
VM1610A	CLIP TWIST LOCK DIAM. 7,6-10,2 MM		VM1610A0	CLIP TWIST LOCK DIAM. 7,6-10,2 MM																																									



COMPONENT			SPARE PART																										
Code	Description	Image	Code	Description	Components list																								
0H6741A	AISI-304 WIRING SUPPORT BRACKET		0H6741A0	AISI-304 WIRING SUPPORT BRACKET																									
0H6740A	AISI-304 MOTOR PROTECTING PANE																												
TB1515A	EXTERNAL HUMIDITY PIPE + RC1165A0		TB1515A1	EXTERNAL HUMIDITY PIPE + RC1165A0																									
0H6334A	BL CL COOKING CHAMBER HOLDING BRACKET		0H6334A0	BL CL COOKING CHAMBER HOLDING BRACKET																									
RS1261A	BAKERLUX\CHEFLUX MOTOR BREAKING ELEMEN		KRS1261A	122W MOTOR BREAKING ELEMENT KIT	<table border="1"> <thead> <tr> <th>Code</th> <th>Description</th> <th>Qty</th> <th>UOM</th> </tr> </thead> <tbody> <tr> <td>GN1326A1</td> <td>ELEMENT SEALING</td> <td>1</td> <td>PZ</td> </tr> <tr> <td>RS1261A0</td> <td>BAKERLUX\CH EFLUX MOTOR BREAKING ELEMENT</td> <td>1</td> <td>PZ</td> </tr> <tr> <td>SL1045A0</td> <td>S53 BLACK SILICONE - 80ML CARTRIDGE</td> <td>1</td> <td>PZ</td> </tr> <tr> <td>V11220A1</td> <td>4,2X12 TCB SELF-TAPPIN G SCREW</td> <td>2</td> <td>PZ</td> </tr> <tr> <td>VM2147A0</td> <td>ESD SPONGE PINK SMOOTH 410X343X15 M</td> <td>1</td> <td>PZ</td> </tr> </tbody> </table>	Code	Description	Qty	UOM	GN1326A1	ELEMENT SEALING	1	PZ	RS1261A0	BAKERLUX\CH EFLUX MOTOR BREAKING ELEMENT	1	PZ	SL1045A0	S53 BLACK SILICONE - 80ML CARTRIDGE	1	PZ	V11220A1	4,2X12 TCB SELF-TAPPIN G SCREW	2	PZ	VM2147A0	ESD SPONGE PINK SMOOTH 410X343X15 M	1	PZ
Code	Description	Qty	UOM																										
GN1326A1	ELEMENT SEALING	1	PZ																										
RS1261A0	BAKERLUX\CH EFLUX MOTOR BREAKING ELEMENT	1	PZ																										
SL1045A0	S53 BLACK SILICONE - 80ML CARTRIDGE	1	PZ																										
V11220A1	4,2X12 TCB SELF-TAPPIN G SCREW	2	PZ																										
VM2147A0	ESD SPONGE PINK SMOOTH 410X343X15 M	1	PZ																										

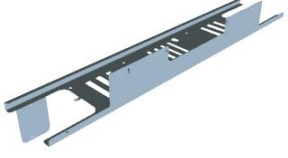

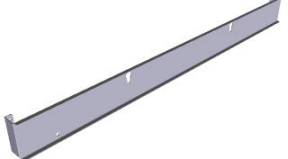
COMPONENT			SPARE PART																						
Code	Description	Image	Code	Description	Components list																				
VM1820A	LATERAL SUPPORTS M6 FIXING BOLT		KVM1820A	THUMB SCREW 10PCS KIT	<table border="1"> <thead> <tr> <th>Code</th> <th>Description</th> <th>Qty</th> <th>UOM</th> </tr> </thead> <tbody> <tr> <td>VM1820A0</td> <td>LATERAL SUPPORTS M6 FIXING BOLT</td> <td>10</td> <td>PZ</td> </tr> </tbody> </table>	Code	Description	Qty	UOM	VM1820A0	LATERAL SUPPORTS M6 FIXING BOLT	10	PZ												
Code	Description	Qty	UOM																						
VM1820A0	LATERAL SUPPORTS M6 FIXING BOLT	10	PZ																						
GRL1265A	LEFT LATERAL SUPPORT 10 600X40		KGRL1265A	10TRAYS 60X40 LATERAL SUPPORT KIT	<table border="1"> <thead> <tr> <th>Code</th> <th>Description</th> <th>Qty</th> <th>UOM</th> </tr> </thead> <tbody> <tr> <td>0H4215A0</td> <td>TRAYS GUIDE PROFILE L372.5 BT</td> <td>20</td> <td>PZ</td> </tr> <tr> <td>0H4420A0</td> <td>STAINLESS STEEL CORE TEMPERATUR</td> <td>1</td> <td>PZ</td> </tr> <tr> <td>0H6709A1</td> <td>0H6495A+0H6 496A FLAT SUPPORTING PROFILE</td> <td>2</td> <td>PZ</td> </tr> <tr> <td>0H6710A1</td> <td>0H6497A+0H6 498A FLAT SUPPORTING PROFILE</td> <td>2</td> <td>PZ</td> </tr> </tbody> </table>	Code	Description	Qty	UOM	0H4215A0	TRAYS GUIDE PROFILE L372.5 BT	20	PZ	0H4420A0	STAINLESS STEEL CORE TEMPERATUR	1	PZ	0H6709A1	0H6495A+0H6 496A FLAT SUPPORTING PROFILE	2	PZ	0H6710A1	0H6497A+0H6 498A FLAT SUPPORTING PROFILE	2	PZ
Code	Description	Qty	UOM																						
0H4215A0	TRAYS GUIDE PROFILE L372.5 BT	20	PZ																						
0H4420A0	STAINLESS STEEL CORE TEMPERATUR	1	PZ																						
0H6709A1	0H6495A+0H6 496A FLAT SUPPORTING PROFILE	2	PZ																						
0H6710A1	0H6497A+0H6 498A FLAT SUPPORTING PROFILE	2	PZ																						
GRL1266A	RIGHT LATERAL SUPPORT 10 600X40		KGRL1265A	10TRAYS 60X40 LATERAL SUPPORT KIT	<table border="1"> <thead> <tr> <th>Code</th> <th>Description</th> <th>Qty</th> <th>UOM</th> </tr> </thead> <tbody> <tr> <td>0H4215A0</td> <td>TRAYS GUIDE PROFILE L372.5 BT</td> <td>20</td> <td>PZ</td> </tr> <tr> <td>0H4420A0</td> <td>STAINLESS STEEL CORE TEMPERATUR</td> <td>1</td> <td>PZ</td> </tr> <tr> <td>0H6709A1</td> <td>0H6495A+0H6 496A FLAT SUPPORTING PROFILE</td> <td>2</td> <td>PZ</td> </tr> <tr> <td>0H6710A1</td> <td>0H6497A+0H6 498A FLAT SUPPORTING PROFILE</td> <td>2</td> <td>PZ</td> </tr> </tbody> </table>	Code	Description	Qty	UOM	0H4215A0	TRAYS GUIDE PROFILE L372.5 BT	20	PZ	0H4420A0	STAINLESS STEEL CORE TEMPERATUR	1	PZ	0H6709A1	0H6495A+0H6 496A FLAT SUPPORTING PROFILE	2	PZ	0H6710A1	0H6497A+0H6 498A FLAT SUPPORTING PROFILE	2	PZ
Code	Description	Qty	UOM																						
0H4215A0	TRAYS GUIDE PROFILE L372.5 BT	20	PZ																						
0H4420A0	STAINLESS STEEL CORE TEMPERATUR	1	PZ																						
0H6709A1	0H6495A+0H6 496A FLAT SUPPORTING PROFILE	2	PZ																						
0H6710A1	0H6497A+0H6 498A FLAT SUPPORTING PROFILE	2	PZ																						
TB2191A	XB89- XV89- INTERNAL HUMIDITY PIPE		TB2191A0	XB89- XV89- INTERNAL HUMIDITY PIPE																					



COMPONENT			SPARE PART										
Code	Description	Image	Code	Description	Components list								
0H6568C	LUX BURNER SUPPORT PLATE		0H6568C0	LUX BURNER SUPPORT PLATE									
0H4075A	XBC614/814G GLASS WOOL PRESS PLATE		0H4075A0	XBC614/814G GLASS WOOL PRESS PLATE									
0H6573A	BURNER LOWER HOLDING PANEL		0H6573A0	BURNER LOWER HOLDING PANEL									
0H6711B	EXHAUST FUMES THERMOSTAT SUPPORT												
TR1142A	EXHAUST FUMES THERMOSTAT		KTR1142A	EXHAUST FUMES THERMOSTAT KIT	<table border="1"> <thead> <tr> <th>Code</th> <th>Description</th> <th>Qty</th> <th>UOM</th> </tr> </thead> <tbody> <tr> <td>TR1142A0</td> <td>EXHAUST FUMES THERMOSTAT</td> <td>1</td> <td>PZ</td> </tr> </tbody> </table>	Code	Description	Qty	UOM	TR1142A0	EXHAUST FUMES THERMOSTAT	1	PZ
Code	Description	Qty	UOM										
TR1142A0	EXHAUST FUMES THERMOSTAT	1	PZ										



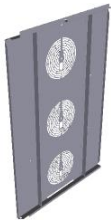

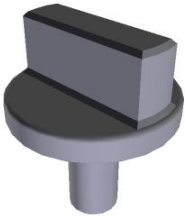
COMPONENT			SPARE PART										
Code	Description	Image	Code	Description	Components list								
0N1135A	GAS BAFFLE FORK												
0G1517B	XB813G XV813G FAN GUARD												
0G1330A	XBC GAS SERIE ST. STEEL FAN GUARD SPACER												
VM1820A	LATERAL SUPPORTS M6 FIXING BOLT		KVM1820A	THUMB SCREW 10PCS KIT	<table border="1"> <thead> <tr> <th>Code</th> <th>Description</th> <th>Qty</th> <th>UOM</th> </tr> </thead> <tbody> <tr> <td>VM1820A0</td> <td>LATERAL SUPPORTS M6 FIXING BOLT</td> <td>10</td> <td>PZ</td> </tr> </tbody> </table>	Code	Description	Qty	UOM	VM1820A0	LATERAL SUPPORTS M6 FIXING BOLT	10	PZ
Code	Description	Qty	UOM										
VM1820A0	LATERAL SUPPORTS M6 FIXING BOLT	10	PZ										

ASM2110A/0.D00 - External cover

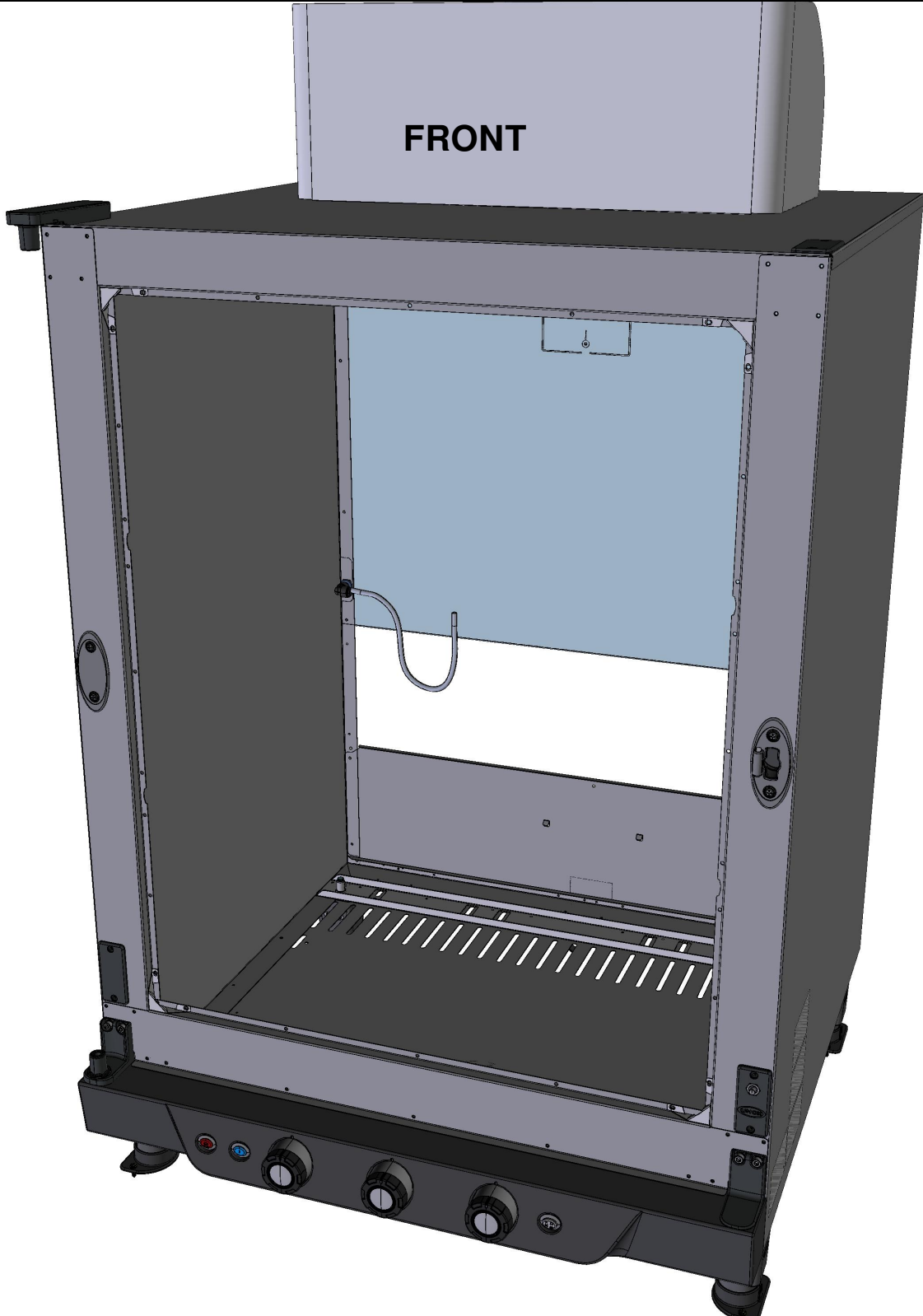

**ASM2110A/0.D00 - External cover**

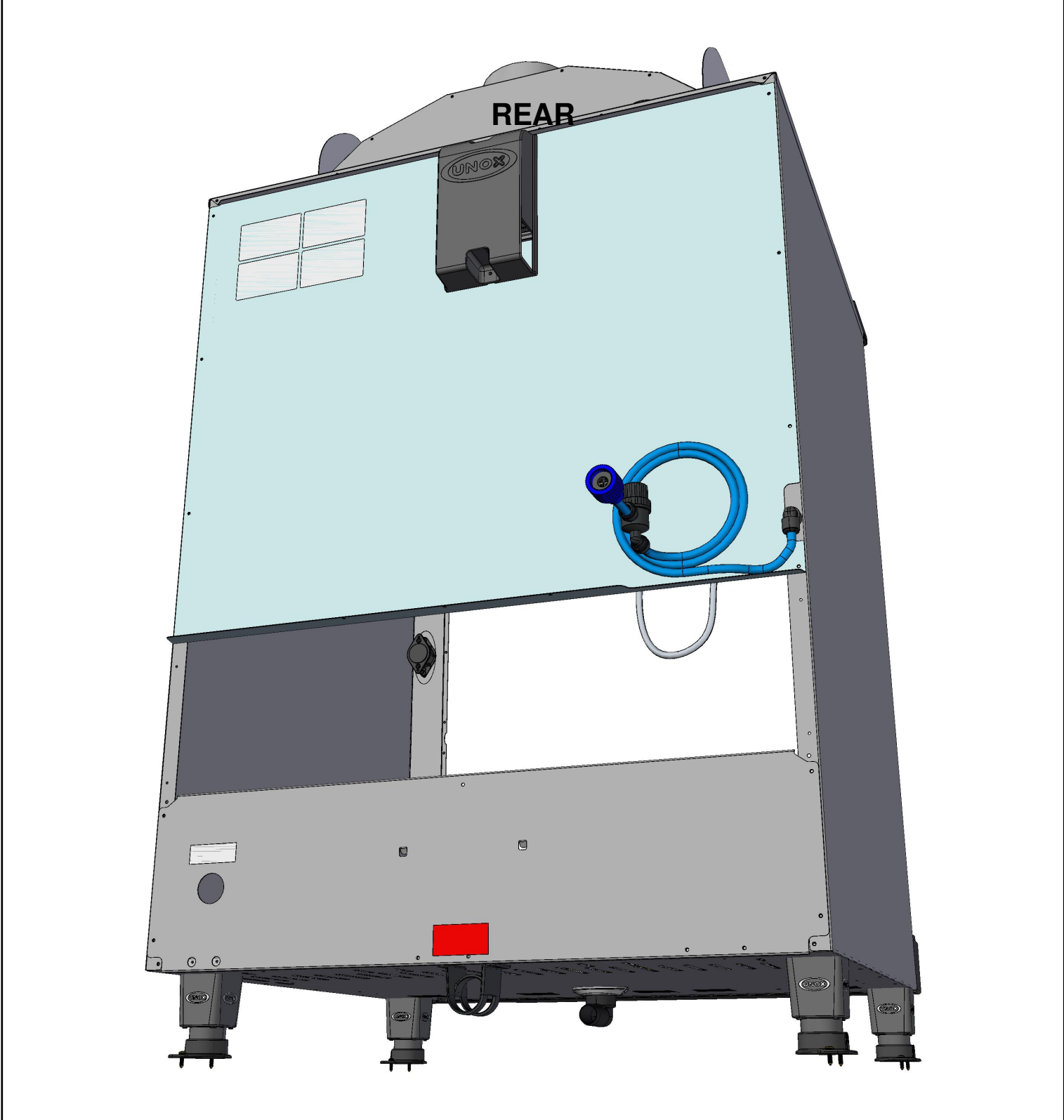





COMPONENT			SPARE PART																						
Code	Description	Image	Code	Description	Components list																				
0H1450A	XB-XV-XG ST. STEEL MUFFLE FRONT CORNER		0H1450A0	XB-XV-XG ST. STEEL MUFFLE FRONT CORNER																					
EL1195B	Ø8F-Ø8M ELBOW CONNECTION		KEL1195A	Ø8F-Ø8M JG ELBOW FITTING 10 PCS KIT	<table border="1"> <thead> <tr> <th>Code</th> <th>Description</th> <th>Qty</th> <th>UOM</th> </tr> </thead> <tbody> <tr> <td>EL1195A0</td> <td>ELBOW UNION Ø8F-Ø8M</td> <td>10</td> <td>PZ</td> </tr> </tbody> </table>	Code	Description	Qty	UOM	EL1195A0	ELBOW UNION Ø8F-Ø8M	10	PZ												
Code	Description	Qty	UOM																						
EL1195A0	ELBOW UNION Ø8F-Ø8M	10	PZ																						
RC1002A	JG 10M-8F TERMINAL REDUCTION FITTIN		KRC1002A	G Ø10M-Ø8F REDUCING SPIGOT 10 PCS KIT	<table border="1"> <thead> <tr> <th>Code</th> <th>Description</th> <th>Qty</th> <th>UOM</th> </tr> </thead> <tbody> <tr> <td>RC1002A0</td> <td>JG 10M-8F TERMINAL REDUCTION FITTING</td> <td>10</td> <td>PZ</td> </tr> </tbody> </table>	Code	Description	Qty	UOM	RC1002A0	JG 10M-8F TERMINAL REDUCTION FITTING	10	PZ												
Code	Description	Qty	UOM																						
RC1002A0	JG 10M-8F TERMINAL REDUCTION FITTING	10	PZ																						
VN1165A	230VAC 50/60HZ COOLING DOWN FA		KVN1165A	S.5E ADVANCE/MM 230V COOLING FAN KIT	<table border="1"> <thead> <tr> <th>Code</th> <th>Description</th> <th>Qty</th> <th>UOM</th> </tr> </thead> <tbody> <tr> <td>VI1099A0</td> <td>SELF-DRILLIN G SCREW 4.8X13 TCB+ Z</td> <td>4</td> <td>PZ</td> </tr> <tr> <td>VM1555A2</td> <td>CT BT COOLING FAN SUPPORT</td> <td>1</td> <td>PZ</td> </tr> <tr> <td>VN1165A0</td> <td>230VAC 50/60HZ COOLING DOWN FAN</td> <td>1</td> <td>PZ</td> </tr> <tr> <td>VN1165A0</td> <td>230VAC 50/60HZ COOLING DOWN FAN</td> <td>1</td> <td>PZ</td> </tr> </tbody> </table>	Code	Description	Qty	UOM	VI1099A0	SELF-DRILLIN G SCREW 4.8X13 TCB+ Z	4	PZ	VM1555A2	CT BT COOLING FAN SUPPORT	1	PZ	VN1165A0	230VAC 50/60HZ COOLING DOWN FAN	1	PZ	VN1165A0	230VAC 50/60HZ COOLING DOWN FAN	1	PZ
Code	Description	Qty	UOM																						
VI1099A0	SELF-DRILLIN G SCREW 4.8X13 TCB+ Z	4	PZ																						
VM1555A2	CT BT COOLING FAN SUPPORT	1	PZ																						
VN1165A0	230VAC 50/60HZ COOLING DOWN FAN	1	PZ																						
VN1165A0	230VAC 50/60HZ COOLING DOWN FAN	1	PZ																						



COMPONENT			SPARE PART																		
Code	Description	Image	Code	Description	Components list																
VM2039A	DRAIN BEND FIXING RING		KVL1026A	DRAIN PIPE BEND KI	<table border="1"> <thead> <tr> <th>Code</th> <th>Description</th> <th>Qty</th> <th>UOM</th> </tr> </thead> <tbody> <tr> <td>GN1400A0</td> <td>U-TRAP SEAL</td> <td>1</td> <td>PZ</td> </tr> <tr> <td>VL1026A0</td> <td>BEND FOR DRAIN PIPE</td> <td>1</td> <td>PZ</td> </tr> <tr> <td>VM2039A0</td> <td>DRAIN BEND FIXING RING</td> <td>1</td> <td>PZ</td> </tr> </tbody> </table>	Code	Description	Qty	UOM	GN1400A0	U-TRAP SEAL	1	PZ	VL1026A0	BEND FOR DRAIN PIPE	1	PZ	VM2039A0	DRAIN BEND FIXING RING	1	PZ
					Code	Description	Qty	UOM													
GN1400A0	U-TRAP SEAL	1	PZ																		
VL1026A0	BEND FOR DRAIN PIPE	1	PZ																		
VM2039A0	DRAIN BEND FIXING RING	1	PZ																		
0H3790A	CHIMNEY HOLDING PLATE		0H3790A0	CHIMNEY HOLDING PLATE																	
GN1275A	XBC/XVC BLACK CHIMNEY SEALING		KGN1275A	KIT GUARNIZIONE CAMINO SILICONE NERO 4PZ	<table border="1"> <thead> <tr> <th>Code</th> <th>Description</th> <th>Qty</th> <th>UOM</th> </tr> </thead> <tbody> <tr> <td>GN1275A0</td> <td>XBC/XVC BLACK CHIMNEY SEALING</td> <td>4</td> <td>PZ</td> </tr> </tbody> </table>	Code	Description	Qty	UOM	GN1275A0	XBC/XVC BLACK CHIMNEY SEALING	4	PZ								
Code	Description	Qty	UOM																		
GN1275A0	XBC/XVC BLACK CHIMNEY SEALING	4	PZ																		
VE1295A	MK 16A 230V DOOR MICROSWITCH		KVE1295A	16A 230V DOOR MICROSWITCH KIT	<table border="1"> <thead> <tr> <th>Code</th> <th>Description</th> <th>Qty</th> <th>UOM</th> </tr> </thead> <tbody> <tr> <td>VE1295A0</td> <td>MK 16A 230V DOOR MICROSWITC</td> <td>1</td> <td>PZ</td> </tr> </tbody> </table>	Code	Description	Qty	UOM	VE1295A0	MK 16A 230V DOOR MICROSWITC	1	PZ								
Code	Description	Qty	UOM																		
VE1295A0	MK 16A 230V DOOR MICROSWITC	1	PZ																		
VM1200A	DOOR MECHANIC MICROSWITCH SUPPORT PLATE		VM1200A0	DOOR MECHANIC MICROSWITCH SUPPORT PLATE																	







COMPONENT			SPARE PART		
Code	Description	Image	Code	Description	Components list
0E1331B	CHEFLUX-BAKERLU X EXTERNAL BOTTOM PANEL		0E1331B0	CHEFLUX-BAKERLU X EXTERNAL BOTTOM PANEL	
0H2560A	XBC/XVC ZINC PLAT. DOOR COUNTERBRACKET		0H2560A0	XBC/XVC ZINC PLAT. DOOR COUNTERBRACKET	
0H6240A	BAKERLUX CHEFLUX ST. STEEL CONTROL PANEL		0H6240A0	BAKERLUX CHEFLUX ST. STEEL CONTROL PANEL	
0H6333A	BL CL THREADED DOOR COUNTER BRACKET		0H6333A0	BL CL THREADED DOOR COUNTER BRACKET	
TB2808A	TB1815A0-D8 H2O SOLENOID LUX 0,5M		TB2808A0	TB1815A0-D8 H2O SOLENOID LUX 0,5M	

COMPONENT			SPARE PART																		
Code	Description	Image	Code	Description	Components list																
RC1365A	3/4"-10 JG FEMALE CONNECTION		KRC1365A	3/4"-10 OR 8 JG WATER CONNECTION KIT	<table border="1"> <thead> <tr> <th>Code</th> <th>Description</th> <th>Qty</th> <th>UOM</th> </tr> </thead> <tbody> <tr> <td>GN1200A1</td> <td>3/4 CONNECTION SEAL D=24 RUBBER+NET</td> <td>1</td> <td>PZ</td> </tr> <tr> <td>RC1002A0</td> <td>JG 10M-8F TERMINAL REDUCTION FITTING</td> <td>1</td> <td>PZ</td> </tr> <tr> <td>RC1365A0</td> <td>3/4"-10 JG FEMALE CONNECTION</td> <td>1</td> <td>PZ</td> </tr> </tbody> </table>	Code	Description	Qty	UOM	GN1200A1	3/4 CONNECTION SEAL D=24 RUBBER+NET	1	PZ	RC1002A0	JG 10M-8F TERMINAL REDUCTION FITTING	1	PZ	RC1365A0	3/4"-10 JG FEMALE CONNECTION	1	PZ
Code	Description	Qty	UOM																		
GN1200A1	3/4 CONNECTION SEAL D=24 RUBBER+NET	1	PZ																		
RC1002A0	JG 10M-8F TERMINAL REDUCTION FITTING	1	PZ																		
RC1365A0	3/4"-10 JG FEMALE CONNECTION	1	PZ																		
VL1034B	MESH WATER FILTER D10		KVL1034C	Ø8-Ø10 MESH100 WATER FILTER KIT	<table border="1"> <thead> <tr> <th>Code</th> <th>Description</th> <th>Qty</th> <th>UOM</th> </tr> </thead> <tbody> <tr> <td>RC1002A0</td> <td>JG 10M-8F TERMINAL REDUCTION FITTING</td> <td>2</td> <td>PZ</td> </tr> <tr> <td>VL1034C0</td> <td>MESH WATER FILTER D10</td> <td>1</td> <td>PZ</td> </tr> <tr> <td>VL1062C0</td> <td>PRESSURE REDUCER-FILTER LOCKING FORK</td> <td>1</td> <td>PZ</td> </tr> </tbody> </table>	Code	Description	Qty	UOM	RC1002A0	JG 10M-8F TERMINAL REDUCTION FITTING	2	PZ	VL1034C0	MESH WATER FILTER D10	1	PZ	VL1062C0	PRESSURE REDUCER-FILTER LOCKING FORK	1	PZ
Code	Description	Qty	UOM																		
RC1002A0	JG 10M-8F TERMINAL REDUCTION FITTING	2	PZ																		
VL1034C0	MESH WATER FILTER D10	1	PZ																		
VL1062C0	PRESSURE REDUCER-FILTER LOCKING FORK	1	PZ																		
TB2237A	Ø10 WATER MAIN CONNECTION PIPE		KTB2599A	Ø10 PET WATER PIPE TB2243A0 100M KIT	<table border="1"> <thead> <tr> <th>Code</th> <th>Description</th> <th>Qty</th> <th>UOM</th> </tr> </thead> <tbody> <tr> <td>TB2243A0</td> <td>Ø10 PET PIPE</td> <td>100</td> <td>M</td> </tr> <tr> <td>VM1059A1</td> <td>HEAT SHRINK FILM H800</td> <td>1.500</td> <td>M</td> </tr> </tbody> </table>	Code	Description	Qty	UOM	TB2243A0	Ø10 PET PIPE	100	M	VM1059A1	HEAT SHRINK FILM H800	1.500	M				
					Code	Description	Qty	UOM													
					TB2243A0	Ø10 PET PIPE	100	M													
VM1059A1	HEAT SHRINK FILM H800	1.500	M																		
KTB2598A	Ø10 PET HUMIDITY PIPE TB2243A0 3 M KIT	<table border="1"> <thead> <tr> <th>Code</th> <th>Description</th> <th>Qty</th> <th>UOM</th> </tr> </thead> <tbody> <tr> <td>TB2243A0</td> <td>Ø10 PET PIPE</td> <td>3</td> <td>M</td> </tr> </tbody> </table>	Code	Description	Qty	UOM	TB2243A0	Ø10 PET PIPE	3	M											
Code	Description	Qty	UOM																		
TB2243A0	Ø10 PET PIPE	3	M																		
KTB2237A	1,5M D10 TB2243A CONNECTION PIPE	<table border="1"> <thead> <tr> <th>Code</th> <th>Description</th> <th>Qty</th> <th>UOM</th> </tr> </thead> <tbody> <tr> <td>TB2243A0</td> <td>Ø10 PET PIPE</td> <td>1.500</td> <td>M</td> </tr> </tbody> </table>	Code	Description	Qty	UOM	TB2243A0	Ø10 PET PIPE	1.500	M											
Code	Description	Qty	UOM																		
TB2243A0	Ø10 PET PIPE	1.500	M																		
RC1360A	10 - 10 JG ELBOW FITTING		KRC1360A	KIT Ø10 - Ø10 JG ELBOW FITTING 10 PCS KIT	<table border="1"> <thead> <tr> <th>Code</th> <th>Description</th> <th>Qty</th> <th>UOM</th> </tr> </thead> <tbody> <tr> <td>RC1360A0</td> <td>10 - 10 JG ELBOW FITTING</td> <td>10</td> <td>PZ</td> </tr> </tbody> </table>	Code	Description	Qty	UOM	RC1360A0	10 - 10 JG ELBOW FITTING	10	PZ								
Code	Description	Qty	UOM																		
RC1360A0	10 - 10 JG ELBOW FITTING	10	PZ																		









COMPONENT			SPARE PART																		
Code	Description	Image	Code	Description	Components list																
EL1349A	CLIP TO FIX Ø10 MM CONNECTION JOIN		KEL1349A	Ø10 FITTING LOCKING CLIPS 10 PCS KIT	<table border="1"> <thead> <tr> <th>Code</th> <th>Description</th> <th>Qty</th> <th>UOM</th> </tr> </thead> <tbody> <tr> <td>EL1349A0</td> <td>CLIP TO FIX Ø10 MM CONNECTION JOINT</td> <td>10</td> <td>PZ</td> </tr> </tbody> </table>	Code	Description	Qty	UOM	EL1349A0	CLIP TO FIX Ø10 MM CONNECTION JOINT	10	PZ								
Code	Description	Qty	UOM																		
EL1349A0	CLIP TO FIX Ø10 MM CONNECTION JOINT	10	PZ																		
0D2210A	LEFT SIDE PANEL BL CL 89-		0D2210A0	LEFT SIDE PANEL BL CL 89-																	
0D2211A	XB893 XV893 MANUAL EXTERNAL RIGHT PANEL		0D2211A0	XB893 XV893 MANUAL EXTERNAL RIGHT PANEL																	
PD1066B	BI-COMPONENT FOOT H100 (E SERIES FOOT)		KPD1066B	E SERIES OVEN H100 FOOT KIT	<table border="1"> <thead> <tr> <th>Code</th> <th>Description</th> <th>Qty</th> <th>UOM</th> </tr> </thead> <tbody> <tr> <td>PD1063A0</td> <td>CT BT FOOT STOP BRACKE</td> <td>1</td> <td>PZ</td> </tr> <tr> <td>PD1066B0</td> <td>BI-COMPONE NT FOOT H100 (E SERIES FOOT)</td> <td>1</td> <td>PZ</td> </tr> <tr> <td>VI1220A1</td> <td>4,2X12 TCB SELF-TAPPIN G SCREW</td> <td>5</td> <td>PZ</td> </tr> </tbody> </table>	Code	Description	Qty	UOM	PD1063A0	CT BT FOOT STOP BRACKE	1	PZ	PD1066B0	BI-COMPONE NT FOOT H100 (E SERIES FOOT)	1	PZ	VI1220A1	4,2X12 TCB SELF-TAPPIN G SCREW	5	PZ
Code	Description	Qty	UOM																		
PD1063A0	CT BT FOOT STOP BRACKE	1	PZ																		
PD1066B0	BI-COMPONE NT FOOT H100 (E SERIES FOOT)	1	PZ																		
VI1220A1	4,2X12 TCB SELF-TAPPIN G SCREW	5	PZ																		
PD1063A	CT BT FOOT STOP BRACKET		KPD1063A	OVEN FOOT STOPPING BRACKET KIT	<table border="1"> <thead> <tr> <th>Code</th> <th>Description</th> <th>Qty</th> <th>UOM</th> </tr> </thead> <tbody> <tr> <td>PD1063A0</td> <td>CT BT FOOT STOP BRACKE</td> <td>4</td> <td>PZ</td> </tr> <tr> <td>VI1950A0</td> <td>ST. STEEL 4,2X13 TCB SELF-DRILLIN G SCREW</td> <td>8</td> <td>PZ</td> </tr> </tbody> </table>	Code	Description	Qty	UOM	PD1063A0	CT BT FOOT STOP BRACKE	4	PZ	VI1950A0	ST. STEEL 4,2X13 TCB SELF-DRILLIN G SCREW	8	PZ				
Code	Description	Qty	UOM																		
PD1063A0	CT BT FOOT STOP BRACKE	4	PZ																		
VI1950A0	ST. STEEL 4,2X13 TCB SELF-DRILLIN G SCREW	8	PZ																		

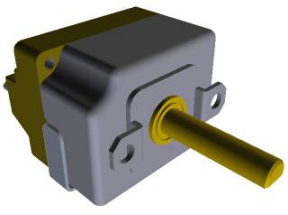

COMPONENT			SPARE PART																						
Code	Description	Image	Code	Description	Components list																				
0D2209B	CHEF-BAKERLUX GAS EXTERNAL UPPER COVER		0D2209B0	CHEF-BAKERLUX GAS EXTERNAL UPPER COVER																					
0H6569A	CHEF-BAKERLUX GAS EXTERNAL BACK COVER		0H6569A0	CHEF-BAKERLUX GAS EXTERNAL BACK COVER																					
VM1762A	INNER LAMP SUPPORT		KVM1762A	LAMP INTERNAL SUPPORT KIT	<table border="1"> <thead> <tr> <th>Code</th> <th>Description</th> <th>Qty</th> <th>UOM</th> </tr> </thead> <tbody> <tr> <td>VM1762A0</td> <td>INNER LAMP SUPPORT</td> <td>1</td> <td>PZ</td> </tr> </tbody> </table>	Code	Description	Qty	UOM	VM1762A0	INNER LAMP SUPPORT	1	PZ												
Code	Description	Qty	UOM																						
VM1762A0	INNER LAMP SUPPORT	1	PZ																						
VE1530A	GOLD THERMOMETER BLUE LIGHT COVER		KLP1012A	BLUE LIGHT THERMOMETER KIT	<table border="1"> <thead> <tr> <th>Code</th> <th>Description</th> <th>Qty</th> <th>UOM</th> </tr> </thead> <tbody> <tr> <td>VE1170A0</td> <td>D16 OPAQUE NICKEL ELLIPTICAL SUPPORT</td> <td>1</td> <td>PZ</td> </tr> <tr> <td>VE1530A0</td> <td>GOLD THERMOMETE R BLUE LIGHT COVER</td> <td>1</td> <td>PZ</td> </tr> <tr> <td>VE1535A1</td> <td>230V WHITE LED</td> <td>1</td> <td>PZ</td> </tr> <tr> <td>VM1762A0</td> <td>INNER LAMP SUPPORT</td> <td>1</td> <td>PZ</td> </tr> </tbody> </table>	Code	Description	Qty	UOM	VE1170A0	D16 OPAQUE NICKEL ELLIPTICAL SUPPORT	1	PZ	VE1530A0	GOLD THERMOMETE R BLUE LIGHT COVER	1	PZ	VE1535A1	230V WHITE LED	1	PZ	VM1762A0	INNER LAMP SUPPORT	1	PZ
Code	Description	Qty	UOM																						
VE1170A0	D16 OPAQUE NICKEL ELLIPTICAL SUPPORT	1	PZ																						
VE1530A0	GOLD THERMOMETE R BLUE LIGHT COVER	1	PZ																						
VE1535A1	230V WHITE LED	1	PZ																						
VM1762A0	INNER LAMP SUPPORT	1	PZ																						
TM1005A	MI2 60 MIN 250V 16A TIMER		KTM1005A	60 MIN TIMER KIT	<table border="1"> <thead> <tr> <th>Code</th> <th>Description</th> <th>Qty</th> <th>UOM</th> </tr> </thead> <tbody> <tr> <td>TM1005A0</td> <td>MI2 60 MIN 250V 16A TIME</td> <td>1</td> <td>PZ</td> </tr> <tr> <td>V11850A0</td> <td>M4X6 NICKEL PLATED FIXING SCRE</td> <td>2</td> <td>PZ</td> </tr> </tbody> </table>	Code	Description	Qty	UOM	TM1005A0	MI2 60 MIN 250V 16A TIME	1	PZ	V11850A0	M4X6 NICKEL PLATED FIXING SCRE	2	PZ								
Code	Description	Qty	UOM																						
TM1005A0	MI2 60 MIN 250V 16A TIME	1	PZ																						
V11850A0	M4X6 NICKEL PLATED FIXING SCRE	2	PZ																						

COMPONENT			SPARE PART																																																		
Code	Description	Image	Code	Description	Components list																																																
TR1100A	269°C 55.19052.80 ADJUSTABLE THERMOSTAT		KTR1100A	269°C THERMOSTAT KIT	<table border="1"> <thead> <tr> <th>Code</th> <th>Description</th> <th>Qty</th> <th>UOM</th> </tr> </thead> <tbody> <tr> <td>TR1100A0</td> <td>269°C 55.19052.80 ADJUSTABLE THERMOSTAT</td> <td>1</td> <td>PZ</td> </tr> <tr> <td>VI1850A0</td> <td>M4X6 NICKEL PLATED FIXING SCREW</td> <td>2</td> <td>PZ</td> </tr> </tbody> </table>	Code	Description	Qty	UOM	TR1100A0	269°C 55.19052.80 ADJUSTABLE THERMOSTAT	1	PZ	VI1850A0	M4X6 NICKEL PLATED FIXING SCREW	2	PZ																																				
Code	Description	Qty	UOM																																																		
TR1100A0	269°C 55.19052.80 ADJUSTABLE THERMOSTAT	1	PZ																																																		
VI1850A0	M4X6 NICKEL PLATED FIXING SCREW	2	PZ																																																		
TM1001C	15 SEC 120V ELECTRONIC BUZZER		KTM1001C	15 SEC BUZZER KIT	<table border="1"> <thead> <tr> <th>Code</th> <th>Description</th> <th>Qty</th> <th>UOM</th> </tr> </thead> <tbody> <tr> <td>TM1001C2</td> <td>15 SEC 120V ELECTRONIC BUZZER</td> <td>1</td> <td>PZ</td> </tr> <tr> <td>VI1220A1</td> <td>4,2X12 TCB SELF-TAPPIN G SCREW</td> <td>3</td> <td>PZ</td> </tr> <tr> <td>VI1850A0</td> <td>M4X6 NICKEL PLATED FIXING SCREW</td> <td>3</td> <td>PZ</td> </tr> <tr> <td>VM1745A0</td> <td>CARD SUPPORT</td> <td>3</td> <td>PZ</td> </tr> </tbody> </table>	Code	Description	Qty	UOM	TM1001C2	15 SEC 120V ELECTRONIC BUZZER	1	PZ	VI1220A1	4,2X12 TCB SELF-TAPPIN G SCREW	3	PZ	VI1850A0	M4X6 NICKEL PLATED FIXING SCREW	3	PZ	VM1745A0	CARD SUPPORT	3	PZ																												
Code	Description	Qty	UOM																																																		
TM1001C2	15 SEC 120V ELECTRONIC BUZZER	1	PZ																																																		
VI1220A1	4,2X12 TCB SELF-TAPPIN G SCREW	3	PZ																																																		
VI1850A0	M4X6 NICKEL PLATED FIXING SCREW	3	PZ																																																		
VM1745A0	CARD SUPPORT	3	PZ																																																		
VE1535A	230V WHITE LED		KVE1535A  KVE0105A  KVE0104A	LED LIGHT 1 PC. KIT  CLOUD LED LIGHT+COVER+SUP PORT KIT  NEUTRAL GREEN LIGHT KIT	<table border="1"> <thead> <tr> <th>Code</th> <th>Description</th> <th>Qty</th> <th>UOM</th> </tr> </thead> <tbody> <tr> <td>VE1535A1</td> <td>230V WHITE LED</td> <td>1</td> <td>PZ</td> </tr> </tbody> </table> <table border="1"> <thead> <tr> <th>Code</th> <th>Description</th> <th>Qty</th> <th>UOM</th> </tr> </thead> <tbody> <tr> <td>VE1535A1</td> <td>230V WHITE LED</td> <td>1</td> <td>PZ</td> </tr> <tr> <td>VM1761A0</td> <td>D16 BLACK ELLIPTICAL SUPPORT</td> <td>1</td> <td>PZ</td> </tr> <tr> <td>VM1762A0</td> <td>INNER LAMP SUPPORT</td> <td>1</td> <td>PZ</td> </tr> <tr> <td>VM1903A0</td> <td>GREEN PILOT WITH GOLD "CLOUD"</td> <td>1</td> <td>PZ</td> </tr> </tbody> </table> <table border="1"> <thead> <tr> <th>Code</th> <th>Description</th> <th>Qty</th> <th>UOM</th> </tr> </thead> <tbody> <tr> <td>VE1535A1</td> <td>230V WHITE LED</td> <td>1</td> <td>PZ</td> </tr> <tr> <td>VM1761A0</td> <td>D16 BLACK ELLIPTICAL SUPPORT</td> <td>1</td> <td>PZ</td> </tr> <tr> <td>VM1762A0</td> <td>INNER LAMP SUPPORT</td> <td>1</td> <td>PZ</td> </tr> <tr> <td>VM1902A0</td> <td>NEUTRAL GREEN PLASTIC COVER FOR</td> <td>1</td> <td>PZ</td> </tr> </tbody> </table>	Code	Description	Qty	UOM	VE1535A1	230V WHITE LED	1	PZ	Code	Description	Qty	UOM	VE1535A1	230V WHITE LED	1	PZ	VM1761A0	D16 BLACK ELLIPTICAL SUPPORT	1	PZ	VM1762A0	INNER LAMP SUPPORT	1	PZ	VM1903A0	GREEN PILOT WITH GOLD "CLOUD"	1	PZ	Code	Description	Qty	UOM	VE1535A1	230V WHITE LED	1	PZ	VM1761A0	D16 BLACK ELLIPTICAL SUPPORT	1	PZ	VM1762A0	INNER LAMP SUPPORT	1	PZ	VM1902A0	NEUTRAL GREEN PLASTIC COVER FOR	1	PZ
Code	Description	Qty	UOM																																																		
VE1535A1	230V WHITE LED	1	PZ																																																		
Code	Description	Qty	UOM																																																		
VE1535A1	230V WHITE LED	1	PZ																																																		
VM1761A0	D16 BLACK ELLIPTICAL SUPPORT	1	PZ																																																		
VM1762A0	INNER LAMP SUPPORT	1	PZ																																																		
VM1903A0	GREEN PILOT WITH GOLD "CLOUD"	1	PZ																																																		
Code	Description	Qty	UOM																																																		
VE1535A1	230V WHITE LED	1	PZ																																																		
VM1761A0	D16 BLACK ELLIPTICAL SUPPORT	1	PZ																																																		
VM1762A0	INNER LAMP SUPPORT	1	PZ																																																		
VM1902A0	NEUTRAL GREEN PLASTIC COVER FOR	1	PZ																																																		



COMPONENT			SPARE PART																											
Code	Description	Image	Code	Description	Components list																									
VE1535A	230V WHITE LED		KVE0102A	GOLDEN FLAME LIGHT COVER KIT	<table border="1"> <thead> <tr> <th>Code</th> <th>Description</th> <th>Qty</th> <th>UOM</th> </tr> </thead> <tbody> <tr> <td>VE1535A1</td> <td>230V WHITE LED</td> <td>1</td> <td>PZ</td> </tr> <tr> <td>VM1761A0</td> <td>D16 BLACK ELLIPTICAL SUPPORT</td> <td>1</td> <td>PZ</td> </tr> <tr> <td>VM1762A0</td> <td>INNER LAMP SUPPORT</td> <td>1</td> <td>PZ</td> </tr> <tr> <td>VM1767A0</td> <td>GREEN PILOT LIGHT W/ GOLD FLAME</td> <td>1</td> <td>PZ</td> </tr> </tbody> </table>	Code	Description	Qty	UOM	VE1535A1	230V WHITE LED	1	PZ	VM1761A0	D16 BLACK ELLIPTICAL SUPPORT	1	PZ	VM1762A0	INNER LAMP SUPPORT	1	PZ	VM1767A0	GREEN PILOT LIGHT W/ GOLD FLAME	1	PZ					
			Code	Description	Qty	UOM																								
			VE1535A1	230V WHITE LED	1	PZ																								
			VM1761A0	D16 BLACK ELLIPTICAL SUPPORT	1	PZ																								
			VM1762A0	INNER LAMP SUPPORT	1	PZ																								
			VM1767A0	GREEN PILOT LIGHT W/ GOLD FLAME	1	PZ																								
			KVE0101A	SINUSOID LIGHT GREEN COVER KIT	<table border="1"> <thead> <tr> <th>Code</th> <th>Description</th> <th>Qty</th> <th>UOM</th> </tr> </thead> <tbody> <tr> <td>VE1535A1</td> <td>230V WHITE LED</td> <td>1</td> <td>PZ</td> </tr> <tr> <td>VM1761A0</td> <td>D16 BLACK ELLIPTICAL SUPPORT</td> <td>1</td> <td>PZ</td> </tr> <tr> <td>VM1762A0</td> <td>INNER LAMP SUPPORT</td> <td>1</td> <td>PZ</td> </tr> <tr> <td>VM1765A0</td> <td>GREEN PILOT WITH GOLD SINUSOIDE</td> <td>1</td> <td>PZ</td> </tr> </tbody> </table>	Code	Description	Qty	UOM	VE1535A1	230V WHITE LED	1	PZ	VM1761A0	D16 BLACK ELLIPTICAL SUPPORT	1	PZ	VM1762A0	INNER LAMP SUPPORT	1	PZ	VM1765A0	GREEN PILOT WITH GOLD SINUSOIDE	1	PZ					
			Code	Description	Qty	UOM																								
			VE1535A1	230V WHITE LED	1	PZ																								
			VM1761A0	D16 BLACK ELLIPTICAL SUPPORT	1	PZ																								
			VM1762A0	INNER LAMP SUPPORT	1	PZ																								
			VM1765A0	GREEN PILOT WITH GOLD SINUSOIDE	1	PZ																								
KVE0100A	THERMOMETER LIGHT COVER KIT	<table border="1"> <thead> <tr> <th>Code</th> <th>Description</th> <th>Qty</th> <th>UOM</th> </tr> </thead> <tbody> <tr> <td>VE1530A0</td> <td>GOLD THERMOMETE R BLUE LIGHT COVER</td> <td>1</td> <td>PZ</td> </tr> <tr> <td>VE1535A1</td> <td>230V WHITE LED</td> <td>1</td> <td>PZ</td> </tr> <tr> <td>VM1761A0</td> <td>D16 BLACK ELLIPTICAL SUPPORT</td> <td>1</td> <td>PZ</td> </tr> <tr> <td>VM1762A0</td> <td>INNER LAMP SUPPORT</td> <td>1</td> <td>PZ</td> </tr> </tbody> </table>	Code	Description	Qty	UOM	VE1530A0	GOLD THERMOMETE R BLUE LIGHT COVER	1	PZ	VE1535A1	230V WHITE LED	1	PZ	VM1761A0	D16 BLACK ELLIPTICAL SUPPORT	1	PZ	VM1762A0	INNER LAMP SUPPORT	1	PZ								
Code	Description	Qty	UOM																											
VE1530A0	GOLD THERMOMETE R BLUE LIGHT COVER	1	PZ																											
VE1535A1	230V WHITE LED	1	PZ																											
VM1761A0	D16 BLACK ELLIPTICAL SUPPORT	1	PZ																											
VM1762A0	INNER LAMP SUPPORT	1	PZ																											
KVE0011A	XP KNOBS AND LIGHTS KIT	<table border="1"> <thead> <tr> <th>Code</th> <th>Description</th> <th>Qty</th> <th>UOM</th> </tr> </thead> <tbody> <tr> <td>MN1105A0</td> <td>120-400C XP THERMOSTAT KNOB</td> <td>1</td> <td>PZ</td> </tr> <tr> <td>MN1110A0</td> <td>XP NEUTRAL INDEX DIAL</td> <td>1</td> <td>PZ</td> </tr> <tr> <td>VE1530A0</td> <td>GOLD THERMOMETE R BLUE LIGHT COVER</td> <td>1</td> <td>PZ</td> </tr> <tr> <td>VE1535A1</td> <td>230V WHITE LED</td> <td>1</td> <td>PZ</td> </tr> <tr> <td>VE1561A0</td> <td>NA/NA BIPOLAR SWITCH</td> <td>1</td> <td>PZ</td> </tr> <tr> <td>VM1761A0</td> <td>D16 BLACK ELLIPTICAL SUPPORT</td> <td>2</td> <td>PZ</td> </tr> </tbody> </table>	Code	Description	Qty	UOM	MN1105A0	120-400C XP THERMOSTAT KNOB	1	PZ	MN1110A0	XP NEUTRAL INDEX DIAL	1	PZ	VE1530A0	GOLD THERMOMETE R BLUE LIGHT COVER	1	PZ	VE1535A1	230V WHITE LED	1	PZ	VE1561A0	NA/NA BIPOLAR SWITCH	1	PZ	VM1761A0	D16 BLACK ELLIPTICAL SUPPORT	2	PZ
Code	Description	Qty	UOM																											
MN1105A0	120-400C XP THERMOSTAT KNOB	1	PZ																											
MN1110A0	XP NEUTRAL INDEX DIAL	1	PZ																											
VE1530A0	GOLD THERMOMETE R BLUE LIGHT COVER	1	PZ																											
VE1535A1	230V WHITE LED	1	PZ																											
VE1561A0	NA/NA BIPOLAR SWITCH	1	PZ																											
VM1761A0	D16 BLACK ELLIPTICAL SUPPORT	2	PZ																											



COMPONENT			SPARE PART																																			
Code	Description	Image	Code	Description	Components list																																	
VE1535A	230V WHITE LED		KVE0011A	XP KNOBS AND LIGHTS KIT	<table border="1"> <thead> <tr> <th>Code</th> <th>Description</th> <th>Qty</th> <th>UOM</th> </tr> </thead> <tbody> <tr> <td>VM1782A0</td> <td>INNER LAMP SUPPORT</td> <td>1</td> <td>PZ</td> </tr> <tr> <td>VM1776A0</td> <td>GOLD "0-1" MATT SILVER KEY</td> <td>1</td> <td>PZ</td> </tr> </tbody> </table>	Code	Description	Qty	UOM	VM1782A0	INNER LAMP SUPPORT	1	PZ	VM1776A0	GOLD "0-1" MATT SILVER KEY	1	PZ																					
			Code	Description	Qty	UOM																																
			VM1782A0	INNER LAMP SUPPORT	1	PZ																																
VM1776A0	GOLD "0-1" MATT SILVER KEY	1	PZ																																			
KVE0008A	XL PILOT BLUE LIGHTS KIT	<table border="1"> <thead> <tr> <th>Code</th> <th>Description</th> <th>Qty</th> <th>UOM</th> </tr> </thead> <tbody> <tr> <td>VE1530A0</td> <td>GOLD THERMOMETE R BLUE LIGHT COVER</td> <td>1</td> <td>PZ</td> </tr> <tr> <td>VE1535A1</td> <td>230V WHITE LED</td> <td>1</td> <td>PZ</td> </tr> <tr> <td>VE1561A0</td> <td>NA/NA BIPOLAR SWITCH</td> <td>1</td> <td>PZ</td> </tr> <tr> <td>VE1562A0</td> <td>UNIPOLAR NA PUSH BUTTO</td> <td>1</td> <td>PZ</td> </tr> <tr> <td>VM1761A0</td> <td>D16 BLACK ELLIPTICAL SUPPORT</td> <td>3</td> <td>PZ</td> </tr> <tr> <td>VM1782A0</td> <td>INNER LAMP SUPPORT</td> <td>1</td> <td>PZ</td> </tr> <tr> <td>VM1775A0</td> <td>OPAQUE SILVER KEY WITH GOLD "CLOUD"</td> <td>1</td> <td>PZ</td> </tr> <tr> <td>VM1776A0</td> <td>GOLD "0-1" MATT SILVER KEY</td> <td>1</td> <td>PZ</td> </tr> </tbody> </table>	Code	Description	Qty	UOM	VE1530A0	GOLD THERMOMETE R BLUE LIGHT COVER	1	PZ	VE1535A1	230V WHITE LED	1	PZ	VE1561A0	NA/NA BIPOLAR SWITCH	1	PZ	VE1562A0	UNIPOLAR NA PUSH BUTTO	1	PZ	VM1761A0	D16 BLACK ELLIPTICAL SUPPORT	3	PZ	VM1782A0	INNER LAMP SUPPORT	1	PZ	VM1775A0	OPAQUE SILVER KEY WITH GOLD "CLOUD"	1	PZ	VM1776A0	GOLD "0-1" MATT SILVER KEY	1	PZ
Code	Description	Qty	UOM																																			
VE1530A0	GOLD THERMOMETE R BLUE LIGHT COVER	1	PZ																																			
VE1535A1	230V WHITE LED	1	PZ																																			
VE1561A0	NA/NA BIPOLAR SWITCH	1	PZ																																			
VE1562A0	UNIPOLAR NA PUSH BUTTO	1	PZ																																			
VM1761A0	D16 BLACK ELLIPTICAL SUPPORT	3	PZ																																			
VM1782A0	INNER LAMP SUPPORT	1	PZ																																			
VM1775A0	OPAQUE SILVER KEY WITH GOLD "CLOUD"	1	PZ																																			
VM1776A0	GOLD "0-1" MATT SILVER KEY	1	PZ																																			
KVE0007A	XF-XG LED AND LED COVERS KIT	<table border="1"> <thead> <tr> <th>Code</th> <th>Description</th> <th>Qty</th> <th>UOM</th> </tr> </thead> <tbody> <tr> <td>VE1530A0</td> <td>GOLD THERMOMETE R BLUE LIGHT COVER</td> <td>1</td> <td>PZ</td> </tr> <tr> <td>VE1535A1</td> <td>230V WHITE LED</td> <td>1</td> <td>PZ</td> </tr> <tr> <td>VE1562A0</td> <td>UNIPOLAR NA PUSH BUTTO</td> <td>1</td> <td>PZ</td> </tr> <tr> <td>VE1585A0</td> <td>BLUE LIGHT COVER GOLD SINUSOID</td> <td>1</td> <td>PZ</td> </tr> <tr> <td>VM1761A0</td> <td>D16 BLACK ELLIPTICAL SUPPORT</td> <td>5</td> <td>PZ</td> </tr> <tr> <td>VM1762A0</td> <td>INNER LAMP SUPPORT</td> <td>4</td> <td>PZ</td> </tr> <tr> <td>VM1767A0</td> <td>GREEN PILOT LIGHT W/ GOLD FLAME</td> <td>1</td> <td>PZ</td> </tr> <tr> <td>VM1774A0</td> <td>SILVER OPAQUE KEY W/ GOLD FLAME</td> <td>1</td> <td>PZ</td> </tr> </tbody> </table>	Code	Description	Qty	UOM	VE1530A0	GOLD THERMOMETE R BLUE LIGHT COVER	1	PZ	VE1535A1	230V WHITE LED	1	PZ	VE1562A0	UNIPOLAR NA PUSH BUTTO	1	PZ	VE1585A0	BLUE LIGHT COVER GOLD SINUSOID	1	PZ	VM1761A0	D16 BLACK ELLIPTICAL SUPPORT	5	PZ	VM1762A0	INNER LAMP SUPPORT	4	PZ	VM1767A0	GREEN PILOT LIGHT W/ GOLD FLAME	1	PZ	VM1774A0	SILVER OPAQUE KEY W/ GOLD FLAME	1	PZ
Code	Description	Qty	UOM																																			
VE1530A0	GOLD THERMOMETE R BLUE LIGHT COVER	1	PZ																																			
VE1535A1	230V WHITE LED	1	PZ																																			
VE1562A0	UNIPOLAR NA PUSH BUTTO	1	PZ																																			
VE1585A0	BLUE LIGHT COVER GOLD SINUSOID	1	PZ																																			
VM1761A0	D16 BLACK ELLIPTICAL SUPPORT	5	PZ																																			
VM1762A0	INNER LAMP SUPPORT	4	PZ																																			
VM1767A0	GREEN PILOT LIGHT W/ GOLD FLAME	1	PZ																																			
VM1774A0	SILVER OPAQUE KEY W/ GOLD FLAME	1	PZ																																			



COMPONENT			SPARE PART																										
Code	Description	Image	Code	Description	Components list																								
VE1535A	230V WHITE LED		KVE0007A	XF-XG LED AND LED COVERS KIT	<table border="1"> <thead> <tr> <th>Code</th> <th>Description</th> <th>Qty</th> <th>UOM</th> </tr> </thead> <tbody> <tr> <td>VM1775A0</td> <td>OPAQUE SILVER KEY WITH GOLD "CLOUD"</td> <td>1</td> <td>PZ</td> </tr> <tr> <td>VM1902A0</td> <td>NEUTRAL GREEN PLASTIC COVER FOR</td> <td>1</td> <td>PZ</td> </tr> <tr> <td>VM1903A0</td> <td>GREEN PILOT WITH GOLD "CLOUD"</td> <td>1</td> <td>PZ</td> </tr> </tbody> </table>	Code	Description	Qty	UOM	VM1775A0	OPAQUE SILVER KEY WITH GOLD "CLOUD"	1	PZ	VM1902A0	NEUTRAL GREEN PLASTIC COVER FOR	1	PZ	VM1903A0	GREEN PILOT WITH GOLD "CLOUD"	1	PZ								
			Code	Description	Qty	UOM																							
			VM1775A0	OPAQUE SILVER KEY WITH GOLD "CLOUD"	1	PZ																							
			VM1902A0	NEUTRAL GREEN PLASTIC COVER FOR	1	PZ																							
			VM1903A0	GREEN PILOT WITH GOLD "CLOUD"	1	PZ																							
			KLP1014A	SINUSOID LED LIGHT+COVER+SUPPORT KIT	<table border="1"> <thead> <tr> <th>Code</th> <th>Description</th> <th>Qty</th> <th>UOM</th> </tr> </thead> <tbody> <tr> <td>VE1170A0</td> <td>D16 OPAQUE NICKEL ELLIPTICAL SUPPORT</td> <td>2</td> <td>PZ</td> </tr> <tr> <td>VE1535A1</td> <td>230V WHITE LED</td> <td>2</td> <td>PZ</td> </tr> <tr> <td>VE1585A0</td> <td>BLUE LIGHT COVER GOLD SINUSOID</td> <td>2</td> <td>PZ</td> </tr> <tr> <td>VM1762A0</td> <td>INNER LAMP SUPPORT</td> <td>2</td> <td>PZ</td> </tr> <tr> <td>VM2009A0</td> <td>ELLIPTICAL SILVER SUPPORT D16</td> <td>1</td> <td>PZ</td> </tr> </tbody> </table>	Code	Description	Qty	UOM	VE1170A0	D16 OPAQUE NICKEL ELLIPTICAL SUPPORT	2	PZ	VE1535A1	230V WHITE LED	2	PZ	VE1585A0	BLUE LIGHT COVER GOLD SINUSOID	2	PZ	VM1762A0	INNER LAMP SUPPORT	2	PZ	VM2009A0	ELLIPTICAL SILVER SUPPORT D16	1	PZ
			Code	Description	Qty	UOM																							
			VE1170A0	D16 OPAQUE NICKEL ELLIPTICAL SUPPORT	2	PZ																							
			VE1535A1	230V WHITE LED	2	PZ																							
			VE1585A0	BLUE LIGHT COVER GOLD SINUSOID	2	PZ																							
			VM1762A0	INNER LAMP SUPPORT	2	PZ																							
			VM2009A0	ELLIPTICAL SILVER SUPPORT D16	1	PZ																							
KLP1012A	BLUE LIGHT THERMOMETER KIT	<table border="1"> <thead> <tr> <th>Code</th> <th>Description</th> <th>Qty</th> <th>UOM</th> </tr> </thead> <tbody> <tr> <td>VE1170A0</td> <td>D16 OPAQUE NICKEL ELLIPTICAL SUPPORT</td> <td>1</td> <td>PZ</td> </tr> <tr> <td>VE1530A0</td> <td>GOLD THERMOMETE R BLUE LIGHT COVER</td> <td>1</td> <td>PZ</td> </tr> <tr> <td>VE1535A1</td> <td>230V WHITE LED</td> <td>1</td> <td>PZ</td> </tr> <tr> <td>VM1762A0</td> <td>INNER LAMP SUPPORT</td> <td>1</td> <td>PZ</td> </tr> </tbody> </table>	Code	Description	Qty	UOM	VE1170A0	D16 OPAQUE NICKEL ELLIPTICAL SUPPORT	1	PZ	VE1530A0	GOLD THERMOMETE R BLUE LIGHT COVER	1	PZ	VE1535A1	230V WHITE LED	1	PZ	VM1762A0	INNER LAMP SUPPORT	1	PZ							
Code	Description	Qty	UOM																										
VE1170A0	D16 OPAQUE NICKEL ELLIPTICAL SUPPORT	1	PZ																										
VE1530A0	GOLD THERMOMETE R BLUE LIGHT COVER	1	PZ																										
VE1535A1	230V WHITE LED	1	PZ																										
VM1762A0	INNER LAMP SUPPORT	1	PZ																										
KLP1010A	THERMOSTAT GREEN LIGHT KIT	<table border="1"> <thead> <tr> <th>Code</th> <th>Description</th> <th>Qty</th> <th>UOM</th> </tr> </thead> <tbody> <tr> <td>VE1170A0</td> <td>D16 OPAQUE NICKEL ELLIPTICAL SUPPORT</td> <td>1</td> <td>PZ</td> </tr> <tr> <td>VE1535A1</td> <td>230V WHITE LED</td> <td>1</td> <td>PZ</td> </tr> <tr> <td>VM1762A0</td> <td>INNER LAMP SUPPORT</td> <td>1</td> <td>PZ</td> </tr> <tr> <td>VM1764A0</td> <td>GREEN PILOT WITH GOLD THERMOMETE</td> <td>1</td> <td>PZ</td> </tr> </tbody> </table>	Code	Description	Qty	UOM	VE1170A0	D16 OPAQUE NICKEL ELLIPTICAL SUPPORT	1	PZ	VE1535A1	230V WHITE LED	1	PZ	VM1762A0	INNER LAMP SUPPORT	1	PZ	VM1764A0	GREEN PILOT WITH GOLD THERMOMETE	1	PZ							
Code	Description	Qty	UOM																										
VE1170A0	D16 OPAQUE NICKEL ELLIPTICAL SUPPORT	1	PZ																										
VE1535A1	230V WHITE LED	1	PZ																										
VM1762A0	INNER LAMP SUPPORT	1	PZ																										
VM1764A0	GREEN PILOT WITH GOLD THERMOMETE	1	PZ																										



COMPONENT			SPARE PART																														
Code	Description	Image	Code	Description	Components list																												
VM2009A	ELLIPTICAL SILVER SUPPORT D16		KVM2009A	D16 SILVER ELLIPTICAL SUPPORT KIT	<table border="1"> <thead> <tr> <th>Code</th> <th>Description</th> <th>Qty</th> <th>UOM</th> </tr> </thead> <tbody> <tr> <td>VM2009A0</td> <td>ELLIPTICAL SILVER SUPPORT D16</td> <td>1</td> <td>PZ</td> </tr> </tbody> </table>	Code	Description	Qty	UOM	VM2009A0	ELLIPTICAL SILVER SUPPORT D16	1	PZ																				
Code	Description	Qty	UOM																														
VM2009A0	ELLIPTICAL SILVER SUPPORT D16	1	PZ																														
VE1624B	RED PILOT LIGHT W/ GOLD FLAME																																
VE1561A	NA/NA BIPOLAR SWITCH		KVE0108A	XP ON-OFF SWITCH KIT	<table border="1"> <thead> <tr> <th>Code</th> <th>Description</th> <th>Qty</th> <th>UOM</th> </tr> </thead> <tbody> <tr> <td>VE1170A0</td> <td>D16 OPAQUE NICKEL ELLIPTICAL SUPPORT</td> <td>1</td> <td>PZ</td> </tr> <tr> <td>VE1561A0</td> <td>NA/NA BIPOLAR SWITCH</td> <td>1</td> <td>PZ</td> </tr> <tr> <td>VM1761A0</td> <td>D16 BLACK ELLIPTICAL SUPPORT</td> <td>1</td> <td>PZ</td> </tr> <tr> <td>VM1776A0</td> <td>GOLD "0-1" MATT SILVER KEY</td> <td>1</td> <td>PZ</td> </tr> </tbody> </table>	Code	Description	Qty	UOM	VE1170A0	D16 OPAQUE NICKEL ELLIPTICAL SUPPORT	1	PZ	VE1561A0	NA/NA BIPOLAR SWITCH	1	PZ	VM1761A0	D16 BLACK ELLIPTICAL SUPPORT	1	PZ	VM1776A0	GOLD "0-1" MATT SILVER KEY	1	PZ								
Code	Description	Qty	UOM																														
VE1170A0	D16 OPAQUE NICKEL ELLIPTICAL SUPPORT	1	PZ																														
VE1561A0	NA/NA BIPOLAR SWITCH	1	PZ																														
VM1761A0	D16 BLACK ELLIPTICAL SUPPORT	1	PZ																														
VM1776A0	GOLD "0-1" MATT SILVER KEY	1	PZ																														
VM1972A	BAKERLUX/CHEFLUX MANUAL CONTROL PANEL		KVM1972A	CL/BL MANUAL CONTROL BOARD KIT	<table border="1"> <thead> <tr> <th>Code</th> <th>Description</th> <th>Qty</th> <th>UOM</th> </tr> </thead> <tbody> <tr> <td>VE1530A0</td> <td>GOLD THERMOMETE R BLUE LIGHT COVER</td> <td>1</td> <td>PZ</td> </tr> <tr> <td>VE1535A1</td> <td>230V WHITE LED</td> <td>2</td> <td>PZ</td> </tr> <tr> <td>VE1561A0</td> <td>NA/NA BIPOLAR SWITCH</td> <td>1</td> <td>PZ</td> </tr> <tr> <td>VE1585A0</td> <td>BLUE LIGHT COVER GOLD SINUSOID</td> <td>1</td> <td>PZ</td> </tr> <tr> <td>VM1762A0</td> <td>INNER LAMP SUPPORT</td> <td>2</td> <td>PZ</td> </tr> <tr> <td>VM1794A0</td> <td>250X4.8 PA66 BLACK CLAMP</td> <td>2</td> <td>PZ</td> </tr> </tbody> </table>	Code	Description	Qty	UOM	VE1530A0	GOLD THERMOMETE R BLUE LIGHT COVER	1	PZ	VE1535A1	230V WHITE LED	2	PZ	VE1561A0	NA/NA BIPOLAR SWITCH	1	PZ	VE1585A0	BLUE LIGHT COVER GOLD SINUSOID	1	PZ	VM1762A0	INNER LAMP SUPPORT	2	PZ	VM1794A0	250X4.8 PA66 BLACK CLAMP	2	PZ
Code	Description	Qty	UOM																														
VE1530A0	GOLD THERMOMETE R BLUE LIGHT COVER	1	PZ																														
VE1535A1	230V WHITE LED	2	PZ																														
VE1561A0	NA/NA BIPOLAR SWITCH	1	PZ																														
VE1585A0	BLUE LIGHT COVER GOLD SINUSOID	1	PZ																														
VM1762A0	INNER LAMP SUPPORT	2	PZ																														
VM1794A0	250X4.8 PA66 BLACK CLAMP	2	PZ																														

COMPONENT			SPARE PART																						
Code	Description	Image	Code	Description	Components list																				
VM1972A	BAKERLUX/CHEFLUX MANUAL CONTROL PANEL		KVM1972A	CL/BL MANUAL CONTROL BOARD KIT	<table border="1"> <thead> <tr> <th>Code</th> <th>Description</th> <th>Qty</th> <th>UOM</th> </tr> </thead> <tbody> <tr> <td>VM1972A0</td> <td>BAKERLUX/CH EFLUX MANUAL CONTROL PANEL</td> <td>1</td> <td>PZ</td> </tr> <tr> <td>VM2007A0</td> <td>FAN SPEED SILVER BUTTON</td> <td>1</td> <td>PZ</td> </tr> <tr> <td>VM2009A0</td> <td>ELLIPTICAL SILVER SUPPORT D16</td> <td>3</td> <td>PZ</td> </tr> <tr> <td>VM2103A0</td> <td>CLAMP LOCK</td> <td>2</td> <td>PZ</td> </tr> </tbody> </table>	Code	Description	Qty	UOM	VM1972A0	BAKERLUX/CH EFLUX MANUAL CONTROL PANEL	1	PZ	VM2007A0	FAN SPEED SILVER BUTTON	1	PZ	VM2009A0	ELLIPTICAL SILVER SUPPORT D16	3	PZ	VM2103A0	CLAMP LOCK	2	PZ
Code	Description	Qty	UOM																						
VM1972A0	BAKERLUX/CH EFLUX MANUAL CONTROL PANEL	1	PZ																						
VM2007A0	FAN SPEED SILVER BUTTON	1	PZ																						
VM2009A0	ELLIPTICAL SILVER SUPPORT D16	3	PZ																						
VM2103A0	CLAMP LOCK	2	PZ																						
VM2007A	FAN SPEED SILVER BUTTON		KVM2007A	FAN SPEED BUTTON KIT	<table border="1"> <thead> <tr> <th>Code</th> <th>Description</th> <th>Qty</th> <th>UOM</th> </tr> </thead> <tbody> <tr> <td>VM2007A0</td> <td>FAN SPEED SILVER BUTTON</td> <td>1</td> <td>PZ</td> </tr> </tbody> </table>	Code	Description	Qty	UOM	VM2007A0	FAN SPEED SILVER BUTTON	1	PZ												
Code	Description	Qty	UOM																						
VM2007A0	FAN SPEED SILVER BUTTON	1	PZ																						
VE1556A	THERMAL SWITCH 240V		KVE1556A	ENERGY REGULATOR KIT EX-VE023	<table border="1"> <thead> <tr> <th>Code</th> <th>Description</th> <th>Qty</th> <th>UOM</th> </tr> </thead> <tbody> <tr> <td>MN1000A0</td> <td>SILVER INDEX KNOB</td> <td>1</td> <td>PZ</td> </tr> <tr> <td>MN1085A0</td> <td>PLASTIC DIAL ENERGY REGULATOR</td> <td>1</td> <td>PZ</td> </tr> <tr> <td>VE1556A0</td> <td>THERMAL SWITCH 240V</td> <td>1</td> <td>PZ</td> </tr> <tr> <td>VI1850A0</td> <td>M4X6 NICKEL PLATED FIXING SCREW</td> <td>2</td> <td>PZ</td> </tr> </tbody> </table>	Code	Description	Qty	UOM	MN1000A0	SILVER INDEX KNOB	1	PZ	MN1085A0	PLASTIC DIAL ENERGY REGULATOR	1	PZ	VE1556A0	THERMAL SWITCH 240V	1	PZ	VI1850A0	M4X6 NICKEL PLATED FIXING SCREW	2	PZ
Code	Description	Qty	UOM																						
MN1000A0	SILVER INDEX KNOB	1	PZ																						
MN1085A0	PLASTIC DIAL ENERGY REGULATOR	1	PZ																						
VE1556A0	THERMAL SWITCH 240V	1	PZ																						
VI1850A0	M4X6 NICKEL PLATED FIXING SCREW	2	PZ																						
MN1112A	CHEFLUX BAKERLUX TIMER KNOB		KMN1112A	CHEFLUX/BAKERLUX TIMER KNOB KIT	<table border="1"> <thead> <tr> <th>Code</th> <th>Description</th> <th>Qty</th> <th>UOM</th> </tr> </thead> <tbody> <tr> <td>MN1112A1</td> <td>CHEFLUX BAKERLUX TIMER KNOB</td> <td>1</td> <td>PZ</td> </tr> </tbody> </table>	Code	Description	Qty	UOM	MN1112A1	CHEFLUX BAKERLUX TIMER KNOB	1	PZ												
Code	Description	Qty	UOM																						
MN1112A1	CHEFLUX BAKERLUX TIMER KNOB	1	PZ																						





COMPONENT			SPARE PART										
Code	Description	Image	Code	Description	Components list								
MN1111A	CHEFLUX BAKERLUX THERMOSTAT KNO		KMN1111A	CL/BL THERMOSTAT KNOB (CELSIUS)	<table border="1"> <thead> <tr> <th>Code</th> <th>Description</th> <th>Qty</th> <th>UOM</th> </tr> </thead> <tbody> <tr> <td>MN1111A1</td> <td>CHEFLUX BAKERLUX THERMOSTAT KNOB</td> <td>1</td> <td>PZ</td> </tr> </tbody> </table>	Code	Description	Qty	UOM	MN1111A1	CHEFLUX BAKERLUX THERMOSTAT KNOB	1	PZ
Code	Description	Qty	UOM										
MN1111A1	CHEFLUX BAKERLUX THERMOSTAT KNOB	1	PZ										
MN1113A	CHEFLUX BAKERLUX HUMIDITY CONTROL KNOB		KMN1113A	CL/BL HUMIDITY CONTROL KNOB KIT	<table border="1"> <thead> <tr> <th>Code</th> <th>Description</th> <th>Qty</th> <th>UOM</th> </tr> </thead> <tbody> <tr> <td>MN1113A2</td> <td>CHEFLUX BAKERLUX HUMIDITY CONTROL KNOB</td> <td>1</td> <td>PZ</td> </tr> </tbody> </table>	Code	Description	Qty	UOM	MN1113A2	CHEFLUX BAKERLUX HUMIDITY CONTROL KNOB	1	PZ
Code	Description	Qty	UOM										
MN1113A2	CHEFLUX BAKERLUX HUMIDITY CONTROL KNOB	1	PZ										
0N1371B	CHEF-BAKERLUX GAS FUMES DRAFT SWITCH												
0N1047A	XG DRAFT SWITCH ENTRANCE RING		0N1047A0	XG DRAFT SWITCH ENTRANCE RING									
0N1356A	XVC FUMES SWITCH SIDE PLATE		0N1356A0	XVC FUMES SWITCH SIDE PLATE									

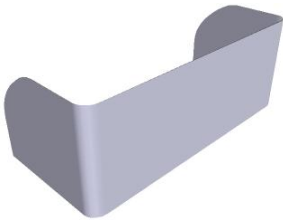
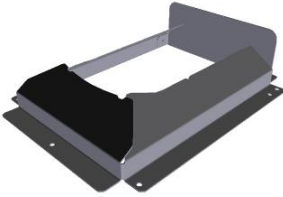
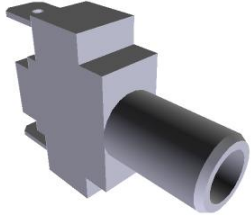

COMPONENT			SPARE PART																						
Code	Description	Image	Code	Description	Components list																				
0N1210A	XVC GAS DRAFT STOPPER EXTERNAL COVER																								
0N1379A	HEAT EXCHANGER LATERAL PANEL		0N1379A0	HEAT EXCHANGER LATERAL PANEL																					
VE1562A	UNIPOLAR NA PUSH BUTTON		KVE0107A	SILVER CLOUD LIGHT COVER KIT	<table border="1"> <thead> <tr> <th>Code</th> <th>Description</th> <th>Qty</th> <th>UOM</th> </tr> </thead> <tbody> <tr> <td>VE1170A0</td> <td>D16 OPAQUE NICKEL ELLIPTICAL SUPPORT</td> <td>1</td> <td>PZ</td> </tr> <tr> <td>VE1562A0</td> <td>UNIPOLAR NA PUSH BUTTO</td> <td>1</td> <td>PZ</td> </tr> <tr> <td>VM1761A0</td> <td>D16 BLACK ELLIPTICAL SUPPORT</td> <td>1</td> <td>PZ</td> </tr> <tr> <td>VM1775A0</td> <td>OPAQUE SILVER KEY WITH GOLD "CLOUD"</td> <td>1</td> <td>PZ</td> </tr> </tbody> </table>	Code	Description	Qty	UOM	VE1170A0	D16 OPAQUE NICKEL ELLIPTICAL SUPPORT	1	PZ	VE1562A0	UNIPOLAR NA PUSH BUTTO	1	PZ	VM1761A0	D16 BLACK ELLIPTICAL SUPPORT	1	PZ	VM1775A0	OPAQUE SILVER KEY WITH GOLD "CLOUD"	1	PZ
Code	Description	Qty	UOM																						
VE1170A0	D16 OPAQUE NICKEL ELLIPTICAL SUPPORT	1	PZ																						
VE1562A0	UNIPOLAR NA PUSH BUTTO	1	PZ																						
VM1761A0	D16 BLACK ELLIPTICAL SUPPORT	1	PZ																						
VM1775A0	OPAQUE SILVER KEY WITH GOLD "CLOUD"	1	PZ																						
			KVE0106A	SILVER FLAME LIGHT COVER KIT	<table border="1"> <thead> <tr> <th>Code</th> <th>Description</th> <th>Qty</th> <th>UOM</th> </tr> </thead> <tbody> <tr> <td>VE1562A0</td> <td>UNIPOLAR NA PUSH BUTTO</td> <td>1</td> <td>PZ</td> </tr> <tr> <td>VM1761A0</td> <td>D16 BLACK ELLIPTICAL SUPPORT</td> <td>1</td> <td>PZ</td> </tr> <tr> <td>VM1774A0</td> <td>SILVER OPAQUE KEY W/ GOLD FLAME</td> <td>1</td> <td>PZ</td> </tr> </tbody> </table>	Code	Description	Qty	UOM	VE1562A0	UNIPOLAR NA PUSH BUTTO	1	PZ	VM1761A0	D16 BLACK ELLIPTICAL SUPPORT	1	PZ	VM1774A0	SILVER OPAQUE KEY W/ GOLD FLAME	1	PZ				
Code	Description	Qty	UOM																						
VE1562A0	UNIPOLAR NA PUSH BUTTO	1	PZ																						
VM1761A0	D16 BLACK ELLIPTICAL SUPPORT	1	PZ																						
VM1774A0	SILVER OPAQUE KEY W/ GOLD FLAME	1	PZ																						
			KVE0008A	XL PILOT BLUE LIGHTS KIT	<table border="1"> <thead> <tr> <th>Code</th> <th>Description</th> <th>Qty</th> <th>UOM</th> </tr> </thead> <tbody> <tr> <td>VE1530A0</td> <td>GOLD THERMOMETE R BLUE LIGHT COVER</td> <td>1</td> <td>PZ</td> </tr> <tr> <td>VE1535A1</td> <td>230V WHITE LED</td> <td>1</td> <td>PZ</td> </tr> </tbody> </table>	Code	Description	Qty	UOM	VE1530A0	GOLD THERMOMETE R BLUE LIGHT COVER	1	PZ	VE1535A1	230V WHITE LED	1	PZ								
Code	Description	Qty	UOM																						
VE1530A0	GOLD THERMOMETE R BLUE LIGHT COVER	1	PZ																						
VE1535A1	230V WHITE LED	1	PZ																						









COMPONENT			SPARE PART																																															
Code	Description	Image	Code	Description	Components list																																													
VE1562A	UNIPOLAR NA PUSH BUTTON		KVE0008A	XL PILOT BLUE LIGHTS KIT	<table border="1"> <thead> <tr> <th>Code</th> <th>Description</th> <th>Qty</th> <th>UOM</th> </tr> </thead> <tbody> <tr> <td>VE1561A0</td> <td>NA/NA BIPOLAR SWITCH</td> <td>1</td> <td>PZ</td> </tr> <tr> <td>VE1562A0</td> <td>UNIPOLAR NA PUSH BUTTO</td> <td>1</td> <td>PZ</td> </tr> <tr> <td>VM1761A0</td> <td>D16 BLACK ELLIPTICAL SUPPORT</td> <td>3</td> <td>PZ</td> </tr> <tr> <td>VM1762A0</td> <td>INNER LAMP SUPPORT</td> <td>1</td> <td>PZ</td> </tr> <tr> <td>VM1775A0</td> <td>OPAQUE SILVER KEY WITH GOLD "CLOUD"</td> <td>1</td> <td>PZ</td> </tr> <tr> <td>VM1776A0</td> <td>GOLD "0-1" MATT SILVER KEY</td> <td>1</td> <td>PZ</td> </tr> </tbody> </table>	Code	Description	Qty	UOM	VE1561A0	NA/NA BIPOLAR SWITCH	1	PZ	VE1562A0	UNIPOLAR NA PUSH BUTTO	1	PZ	VM1761A0	D16 BLACK ELLIPTICAL SUPPORT	3	PZ	VM1762A0	INNER LAMP SUPPORT	1	PZ	VM1775A0	OPAQUE SILVER KEY WITH GOLD "CLOUD"	1	PZ	VM1776A0	GOLD "0-1" MATT SILVER KEY	1	PZ																	
			Code	Description	Qty	UOM																																												
VE1561A0	NA/NA BIPOLAR SWITCH	1	PZ																																															
VE1562A0	UNIPOLAR NA PUSH BUTTO	1	PZ																																															
VM1761A0	D16 BLACK ELLIPTICAL SUPPORT	3	PZ																																															
VM1762A0	INNER LAMP SUPPORT	1	PZ																																															
VM1775A0	OPAQUE SILVER KEY WITH GOLD "CLOUD"	1	PZ																																															
VM1776A0	GOLD "0-1" MATT SILVER KEY	1	PZ																																															
KVE0007A	XF-XG LED AND LED COVERS KIT	<table border="1"> <thead> <tr> <th>Code</th> <th>Description</th> <th>Qty</th> <th>UOM</th> </tr> </thead> <tbody> <tr> <td>VE1530A0</td> <td>GOLD THERMOMETE R BLUE LIGHT COVER</td> <td>1</td> <td>PZ</td> </tr> <tr> <td>VE1535A1</td> <td>230V WHITE LED</td> <td>1</td> <td>PZ</td> </tr> <tr> <td>VE1562A0</td> <td>UNIPOLAR NA PUSH BUTTO</td> <td>1</td> <td>PZ</td> </tr> <tr> <td>VE1585A0</td> <td>BLUE LIGHT COVER GOLD SINUSOID</td> <td>1</td> <td>PZ</td> </tr> <tr> <td>VM1761A0</td> <td>D16 BLACK ELLIPTICAL SUPPORT</td> <td>5</td> <td>PZ</td> </tr> <tr> <td>VM1762A0</td> <td>INNER LAMP SUPPORT</td> <td>4</td> <td>PZ</td> </tr> <tr> <td>VM1767A0</td> <td>GREEN PILOT LIGHT W/ GOLD FLAME</td> <td>1</td> <td>PZ</td> </tr> <tr> <td>VM1774A0</td> <td>SILVER OPAQUE KEY W/ GOLD FLAME</td> <td>1</td> <td>PZ</td> </tr> <tr> <td>VM1775A0</td> <td>OPAQUE SILVER KEY WITH GOLD "CLOUD"</td> <td>1</td> <td>PZ</td> </tr> <tr> <td>VM1902A0</td> <td>NEUTRAL GREEN PLASTIC COVER FOR</td> <td>1</td> <td>PZ</td> </tr> <tr> <td>VM1903A0</td> <td>GREEN PILOT WITH GOLD "CLOUD"</td> <td>1</td> <td>PZ</td> </tr> </tbody> </table>	Code	Description	Qty	UOM	VE1530A0	GOLD THERMOMETE R BLUE LIGHT COVER	1	PZ	VE1535A1	230V WHITE LED	1	PZ	VE1562A0	UNIPOLAR NA PUSH BUTTO	1	PZ	VE1585A0	BLUE LIGHT COVER GOLD SINUSOID	1	PZ	VM1761A0	D16 BLACK ELLIPTICAL SUPPORT	5	PZ	VM1762A0	INNER LAMP SUPPORT	4	PZ	VM1767A0	GREEN PILOT LIGHT W/ GOLD FLAME	1	PZ	VM1774A0	SILVER OPAQUE KEY W/ GOLD FLAME	1	PZ	VM1775A0	OPAQUE SILVER KEY WITH GOLD "CLOUD"	1	PZ	VM1902A0	NEUTRAL GREEN PLASTIC COVER FOR	1	PZ	VM1903A0	GREEN PILOT WITH GOLD "CLOUD"	1	PZ
Code	Description	Qty	UOM																																															
VE1530A0	GOLD THERMOMETE R BLUE LIGHT COVER	1	PZ																																															
VE1535A1	230V WHITE LED	1	PZ																																															
VE1562A0	UNIPOLAR NA PUSH BUTTO	1	PZ																																															
VE1585A0	BLUE LIGHT COVER GOLD SINUSOID	1	PZ																																															
VM1761A0	D16 BLACK ELLIPTICAL SUPPORT	5	PZ																																															
VM1762A0	INNER LAMP SUPPORT	4	PZ																																															
VM1767A0	GREEN PILOT LIGHT W/ GOLD FLAME	1	PZ																																															
VM1774A0	SILVER OPAQUE KEY W/ GOLD FLAME	1	PZ																																															
VM1775A0	OPAQUE SILVER KEY WITH GOLD "CLOUD"	1	PZ																																															
VM1902A0	NEUTRAL GREEN PLASTIC COVER FOR	1	PZ																																															
VM1903A0	GREEN PILOT WITH GOLD "CLOUD"	1	PZ																																															



COMPONENT			SPARE PART										
Code	Description	Image	Code	Description	Components list								
VM2009A	ELLIPTICAL SILVER SUPPORT D16		KVM2009A	D16 SILVER ELLIPTICAL SUPPORT KIT	<table border="1"> <thead> <tr> <th>Code</th> <th>Description</th> <th>Qty</th> <th>UOM</th> </tr> </thead> <tbody> <tr> <td>VM2009A0</td> <td>ELLIPTICAL SILVER SUPPORT D16</td> <td>1</td> <td>PZ</td> </tr> </tbody> </table>	Code	Description	Qty	UOM	VM2009A0	ELLIPTICAL SILVER SUPPORT D16	1	PZ
Code	Description	Qty	UOM										
VM2009A0	ELLIPTICAL SILVER SUPPORT D16	1	PZ										
VM2078A	SILVER MATT KEY W/ BLACK FLAME		VM2078A0	SILVER MATT KEY W/ BLACK FLAME									
0F1463A	CHEF-BAKERLUX 89- EXTERNAL BACK PANEL		0F1463A0	CHEF-BAKERLUX 89- EXTERNAL BACK PANEL									
VI1081A	M6X25 STAINLESS STEEL SCREW		KVI1081A	10PCS. M6X25 ST.STEEL SCREW KI	<table border="1"> <thead> <tr> <th>Code</th> <th>Description</th> <th>Qty</th> <th>UOM</th> </tr> </thead> <tbody> <tr> <td>VI1081A0</td> <td>M6X25 STAINLESS STEEL SCREW</td> <td>10</td> <td>PZ</td> </tr> </tbody> </table>	Code	Description	Qty	UOM	VI1081A0	M6X25 STAINLESS STEEL SCREW	10	PZ
Code	Description	Qty	UOM										
VI1081A0	M6X25 STAINLESS STEEL SCREW	10	PZ										
VM2035A	DRAIN PIPE SUPPORT		KVM2035A	DRAIN PIPE SUPPORT 2 PCS. KI	<table border="1"> <thead> <tr> <th>Code</th> <th>Description</th> <th>Qty</th> <th>UOM</th> </tr> </thead> <tbody> <tr> <td>VM2035A0</td> <td>DRAIN PIPE SUPPORT</td> <td>2</td> <td>PZ</td> </tr> </tbody> </table>	Code	Description	Qty	UOM	VM2035A0	DRAIN PIPE SUPPORT	2	PZ
Code	Description	Qty	UOM										
VM2035A0	DRAIN PIPE SUPPORT	2	PZ										





COMPONENT			SPARE PART																										
Code	Description	Image	Code	Description	Components list																								
VM1190A	CT BT RIGHT DOOR SPRING LATCH		KVM1190A	CHEFTOP/BAKERTO P DOOR RIGHT LATCH KIT	<table border="1"> <thead> <tr> <th>Code</th> <th>Description</th> <th>Qty</th> <th>UOM</th> </tr> </thead> <tbody> <tr> <td>VI0239A1</td> <td>SELF-TAPPIN G SCREW 4.2X25 TCB+ INOX</td> <td>2</td> <td>PZ</td> </tr> <tr> <td>VI1220A1</td> <td>4,2X12 TCB SELF-TAPPIN G SCREW</td> <td>2</td> <td>PZ</td> </tr> <tr> <td>VM1190A2</td> <td>CT BT RIGHT DOOR SPRING LATCH</td> <td>1</td> <td>PZ</td> </tr> <tr> <td>VM1192A1</td> <td>CT BT DOOR SPRING LATCH BACK COVER</td> <td>1</td> <td>PZ</td> </tr> <tr> <td>VM1460A0</td> <td>XBC/XVC RIGHT DOOR LATCH CAP</td> <td>1</td> <td>PZ</td> </tr> </tbody> </table>	Code	Description	Qty	UOM	VI0239A1	SELF-TAPPIN G SCREW 4.2X25 TCB+ INOX	2	PZ	VI1220A1	4,2X12 TCB SELF-TAPPIN G SCREW	2	PZ	VM1190A2	CT BT RIGHT DOOR SPRING LATCH	1	PZ	VM1192A1	CT BT DOOR SPRING LATCH BACK COVER	1	PZ	VM1460A0	XBC/XVC RIGHT DOOR LATCH CAP	1	PZ
					Code	Description	Qty	UOM																					
					VI0239A1	SELF-TAPPIN G SCREW 4.2X25 TCB+ INOX	2	PZ																					
					VI1220A1	4,2X12 TCB SELF-TAPPIN G SCREW	2	PZ																					
					VM1190A2	CT BT RIGHT DOOR SPRING LATCH	1	PZ																					
VM1192A1	CT BT DOOR SPRING LATCH BACK COVER	1	PZ																										
VM1460A0	XBC/XVC RIGHT DOOR LATCH CAP	1	PZ																										
VM1240A	NYLON SUPPORT CAP		KVM1240A	4 PCS COUNTER BRACKET SUPPORT CAP KIT	<table border="1"> <thead> <tr> <th>Code</th> <th>Description</th> <th>Qty</th> <th>UOM</th> </tr> </thead> <tbody> <tr> <td>VM1240A0</td> <td>NYLON SUPPORT CAP</td> <td>4</td> <td>PZ</td> </tr> </tbody> </table>	Code	Description	Qty	UOM	VM1240A0	NYLON SUPPORT CAP	4	PZ																
					Code	Description	Qty	UOM																					
					VM1240A0	NYLON SUPPORT CAP	4	PZ																					
					VM1195A	HOLES BLANKING PLATE XVC204/304/504/704		VM1195A0	HOLES BLANKING PLATE XVC204/304/504/704																				
VM1505A	WALL PASSING WITH DIAPHRAGM		KVM1505A	THROUGH-WALL CONNECTION+DIAPHRAGM KIT	<table border="1"> <thead> <tr> <th>Code</th> <th>Description</th> <th>Qty</th> <th>UOM</th> </tr> </thead> <tbody> <tr> <td>VI1220A1</td> <td>4,2X12 TCB SELF-TAPPIN G SCREW</td> <td>1</td> <td>PZ</td> </tr> <tr> <td>VM1505A0</td> <td>WALL PASSING WITH DIAPHRAGM</td> <td>3</td> <td>PZ</td> </tr> <tr> <td>VM2055A0</td> <td>UPPER THROUGH-WALL CONNECTION</td> <td>1</td> <td>PZ</td> </tr> <tr> <td>VM2056A0</td> <td>LOWER THROUGH-WALL CONNECTION</td> <td>1</td> <td>PZ</td> </tr> </tbody> </table>	Code	Description	Qty	UOM	VI1220A1	4,2X12 TCB SELF-TAPPIN G SCREW	1	PZ	VM1505A0	WALL PASSING WITH DIAPHRAGM	3	PZ	VM2055A0	UPPER THROUGH-WALL CONNECTION	1	PZ	VM2056A0	LOWER THROUGH-WALL CONNECTION	1	PZ				
					Code	Description	Qty	UOM																					
					VI1220A1	4,2X12 TCB SELF-TAPPIN G SCREW	1	PZ																					
					VM1505A0	WALL PASSING WITH DIAPHRAGM	3	PZ																					
VM2055A0	UPPER THROUGH-WALL CONNECTION	1	PZ																										
VM2056A0	LOWER THROUGH-WALL CONNECTION	1	PZ																										

COMPONENT			SPARE PART																										
Code	Description	Image	Code	Description	Components list																								
VM1192A	CT BT DOOR SPRING LATCH BACK COVER		KVM1191A	CHEFTOP/BAKERTO P DOOR LEFT LATCH KIT	<table border="1"> <thead> <tr> <th>Code</th> <th>Description</th> <th>Qty</th> <th>UOM</th> </tr> </thead> <tbody> <tr> <td>VI0239A1</td> <td>SELF-TAPPIN G SCREW 4.2X25 TCB+ INOX</td> <td>2</td> <td>PZ</td> </tr> <tr> <td>VI1220A1</td> <td>4,2X12 TCB SELF-TAPPIN G SCREW</td> <td>2</td> <td>PZ</td> </tr> <tr> <td>VM1191A2</td> <td>CT BT LEFT DOOR SPRING LATCH</td> <td>1</td> <td>PZ</td> </tr> <tr> <td>VM1192A1</td> <td>CT BT DOOR SPRING LATCH BACK COVER</td> <td>1</td> <td>PZ</td> </tr> <tr> <td>VM1460A0</td> <td>XBC/XVC RIGHT DOOR LATCH CAP</td> <td>1</td> <td>PZ</td> </tr> </tbody> </table>	Code	Description	Qty	UOM	VI0239A1	SELF-TAPPIN G SCREW 4.2X25 TCB+ INOX	2	PZ	VI1220A1	4,2X12 TCB SELF-TAPPIN G SCREW	2	PZ	VM1191A2	CT BT LEFT DOOR SPRING LATCH	1	PZ	VM1192A1	CT BT DOOR SPRING LATCH BACK COVER	1	PZ	VM1460A0	XBC/XVC RIGHT DOOR LATCH CAP	1	PZ
			Code	Description	Qty	UOM																							
VI0239A1	SELF-TAPPIN G SCREW 4.2X25 TCB+ INOX	2	PZ																										
VI1220A1	4,2X12 TCB SELF-TAPPIN G SCREW	2	PZ																										
VM1191A2	CT BT LEFT DOOR SPRING LATCH	1	PZ																										
VM1192A1	CT BT DOOR SPRING LATCH BACK COVER	1	PZ																										
VM1460A0	XBC/XVC RIGHT DOOR LATCH CAP	1	PZ																										
KVM1190A	CHEFTOP/BAKERTO P DOOR RIGHT LATCH KIT	<table border="1"> <thead> <tr> <th>Code</th> <th>Description</th> <th>Qty</th> <th>UOM</th> </tr> </thead> <tbody> <tr> <td>VI0239A1</td> <td>SELF-TAPPIN G SCREW 4.2X25 TCB+ INOX</td> <td>2</td> <td>PZ</td> </tr> <tr> <td>VI1220A1</td> <td>4,2X12 TCB SELF-TAPPIN G SCREW</td> <td>2</td> <td>PZ</td> </tr> <tr> <td>VM1190A2</td> <td>CT BT RIGHT DOOR SPRING LATCH</td> <td>1</td> <td>PZ</td> </tr> <tr> <td>VM1192A1</td> <td>CT BT DOOR SPRING LATCH BACK COVER</td> <td>1</td> <td>PZ</td> </tr> <tr> <td>VM1460A0</td> <td>XBC/XVC RIGHT DOOR LATCH CAP</td> <td>1</td> <td>PZ</td> </tr> </tbody> </table>	Code	Description	Qty	UOM	VI0239A1	SELF-TAPPIN G SCREW 4.2X25 TCB+ INOX	2	PZ	VI1220A1	4,2X12 TCB SELF-TAPPIN G SCREW	2	PZ	VM1190A2	CT BT RIGHT DOOR SPRING LATCH	1	PZ	VM1192A1	CT BT DOOR SPRING LATCH BACK COVER	1	PZ	VM1460A0	XBC/XVC RIGHT DOOR LATCH CAP	1	PZ			
Code	Description	Qty	UOM																										
VI0239A1	SELF-TAPPIN G SCREW 4.2X25 TCB+ INOX	2	PZ																										
VI1220A1	4,2X12 TCB SELF-TAPPIN G SCREW	2	PZ																										
VM1190A2	CT BT RIGHT DOOR SPRING LATCH	1	PZ																										
VM1192A1	CT BT DOOR SPRING LATCH BACK COVER	1	PZ																										
VM1460A0	XBC/XVC RIGHT DOOR LATCH CAP	1	PZ																										
VM1191A	CT BT LEFT DOOR SPRING LATCH		KVM1191A	CHEFTOP/BAKERTO P DOOR LEFT LATCH KIT	<table border="1"> <thead> <tr> <th>Code</th> <th>Description</th> <th>Qty</th> <th>UOM</th> </tr> </thead> <tbody> <tr> <td>VI0239A1</td> <td>SELF-TAPPIN G SCREW 4.2X25 TCB+ INOX</td> <td>2</td> <td>PZ</td> </tr> <tr> <td>VI1220A1</td> <td>4,2X12 TCB SELF-TAPPIN G SCREW</td> <td>2</td> <td>PZ</td> </tr> <tr> <td>VM1191A2</td> <td>CT BT LEFT DOOR SPRING LATCH</td> <td>1</td> <td>PZ</td> </tr> <tr> <td>VM1192A1</td> <td>CT BT DOOR SPRING LATCH BACK COVER</td> <td>1</td> <td>PZ</td> </tr> <tr> <td>VM1460A0</td> <td>XBC/XVC RIGHT DOOR LATCH CAP</td> <td>1</td> <td>PZ</td> </tr> </tbody> </table>	Code	Description	Qty	UOM	VI0239A1	SELF-TAPPIN G SCREW 4.2X25 TCB+ INOX	2	PZ	VI1220A1	4,2X12 TCB SELF-TAPPIN G SCREW	2	PZ	VM1191A2	CT BT LEFT DOOR SPRING LATCH	1	PZ	VM1192A1	CT BT DOOR SPRING LATCH BACK COVER	1	PZ	VM1460A0	XBC/XVC RIGHT DOOR LATCH CAP	1	PZ
Code	Description	Qty	UOM																										
VI0239A1	SELF-TAPPIN G SCREW 4.2X25 TCB+ INOX	2	PZ																										
VI1220A1	4,2X12 TCB SELF-TAPPIN G SCREW	2	PZ																										
VM1191A2	CT BT LEFT DOOR SPRING LATCH	1	PZ																										
VM1192A1	CT BT DOOR SPRING LATCH BACK COVER	1	PZ																										
VM1460A0	XBC/XVC RIGHT DOOR LATCH CAP	1	PZ																										



COMPONENT			SPARE PART														
Code	Description	Image	Code	Description	Components list												
VM1165B	CT BT DOOR UPPER BRACKET		KVM1165B	CT BT CL BL DOOR UPPER BRACKET KI	<table border="1"> <thead> <tr> <th>Code</th> <th>Description</th> <th>Qty</th> <th>UOM</th> </tr> </thead> <tbody> <tr> <td>VM1165B0</td> <td>CT BT DOOR UPPER BRACKET</td> <td>1</td> <td>PZ</td> </tr> </tbody> </table>	Code	Description	Qty	UOM	VM1165B0	CT BT DOOR UPPER BRACKET	1	PZ				
Code	Description	Qty	UOM														
VM1165B0	CT BT DOOR UPPER BRACKET	1	PZ														
VM1166A	CAP FOR DOOR UPPER STIRRUP XVC204/304/5		KVM1166A	DOOR UPPER BRACKET COVER KI	<table border="1"> <thead> <tr> <th>Code</th> <th>Description</th> <th>Qty</th> <th>UOM</th> </tr> </thead> <tbody> <tr> <td>VM1166A0</td> <td>CAP FOR DOOR UPPER STIRRUP XVC204/304/5</td> <td>1</td> <td>PZ</td> </tr> </tbody> </table>	Code	Description	Qty	UOM	VM1166A0	CAP FOR DOOR UPPER STIRRUP XVC204/304/5	1	PZ				
Code	Description	Qty	UOM														
VM1166A0	CAP FOR DOOR UPPER STIRRUP XVC204/304/5	1	PZ														
VM1460A	XBC/XVC RIGHT DOOR LATCH CAP		KVM1460A	XBC/XVC RIGHT DOOR LATCH CAP KIT	<table border="1"> <thead> <tr> <th>Code</th> <th>Description</th> <th>Qty</th> <th>UOM</th> </tr> </thead> <tbody> <tr> <td>VI0239A1</td> <td>SELF-TAPPIN G SCREW 4.2X25 TCB+ INOX</td> <td>2</td> <td>PZ</td> </tr> <tr> <td>VM1460A0</td> <td>XBC/XVC RIGHT DOOR LATCH CAP</td> <td>1</td> <td>PZ</td> </tr> </tbody> </table>	Code	Description	Qty	UOM	VI0239A1	SELF-TAPPIN G SCREW 4.2X25 TCB+ INOX	2	PZ	VM1460A0	XBC/XVC RIGHT DOOR LATCH CAP	1	PZ
Code	Description	Qty	UOM														
VI0239A1	SELF-TAPPIN G SCREW 4.2X25 TCB+ INOX	2	PZ														
VM1460A0	XBC/XVC RIGHT DOOR LATCH CAP	1	PZ														
VM1461A	XBC/XVC LEFT DOOR LATCH CAP		VM1461A0	XBC/XVC LEFT DOOR LATCH CAP													
VM1975A	DOOR SUPPORT LOWER BRACKET		KVM1975A	CL BL DOOR LOWER BRACKET KIT	<table border="1"> <thead> <tr> <th>Code</th> <th>Description</th> <th>Qty</th> <th>UOM</th> </tr> </thead> <tbody> <tr> <td>VM1975A0</td> <td>DOOR SUPPORT LOWER BRACKET</td> <td>1</td> <td>PZ</td> </tr> </tbody> </table>	Code	Description	Qty	UOM	VM1975A0	DOOR SUPPORT LOWER BRACKET	1	PZ				
Code	Description	Qty	UOM														
VM1975A0	DOOR SUPPORT LOWER BRACKET	1	PZ														



COMPONENT			SPARE PART										
Code	Description	Image	Code	Description	Components list								
VM1974A	BOARD CLOSING PLATE		VM1974A0	BOARD CLOSING PLATE									
VM2028A	20X10X4 RUBBER WASHER		KVM2028A	20X10X4 RUBBER WASHER 5 PCS. KIT	<table border="1"> <thead> <tr> <th>Code</th> <th>Description</th> <th>Qty</th> <th>UOM</th> </tr> </thead> <tbody> <tr> <td>VM2028A0</td> <td>20X10X4 RUBBER WASHER</td> <td>5</td> <td>PZ</td> </tr> </tbody> </table>	Code	Description	Qty	UOM	VM2028A0	20X10X4 RUBBER WASHER	5	PZ
Code	Description	Qty	UOM										
VM2028A0	20X10X4 RUBBER WASHER	5	PZ										





**ASM2794A/0.D00 - General overview**

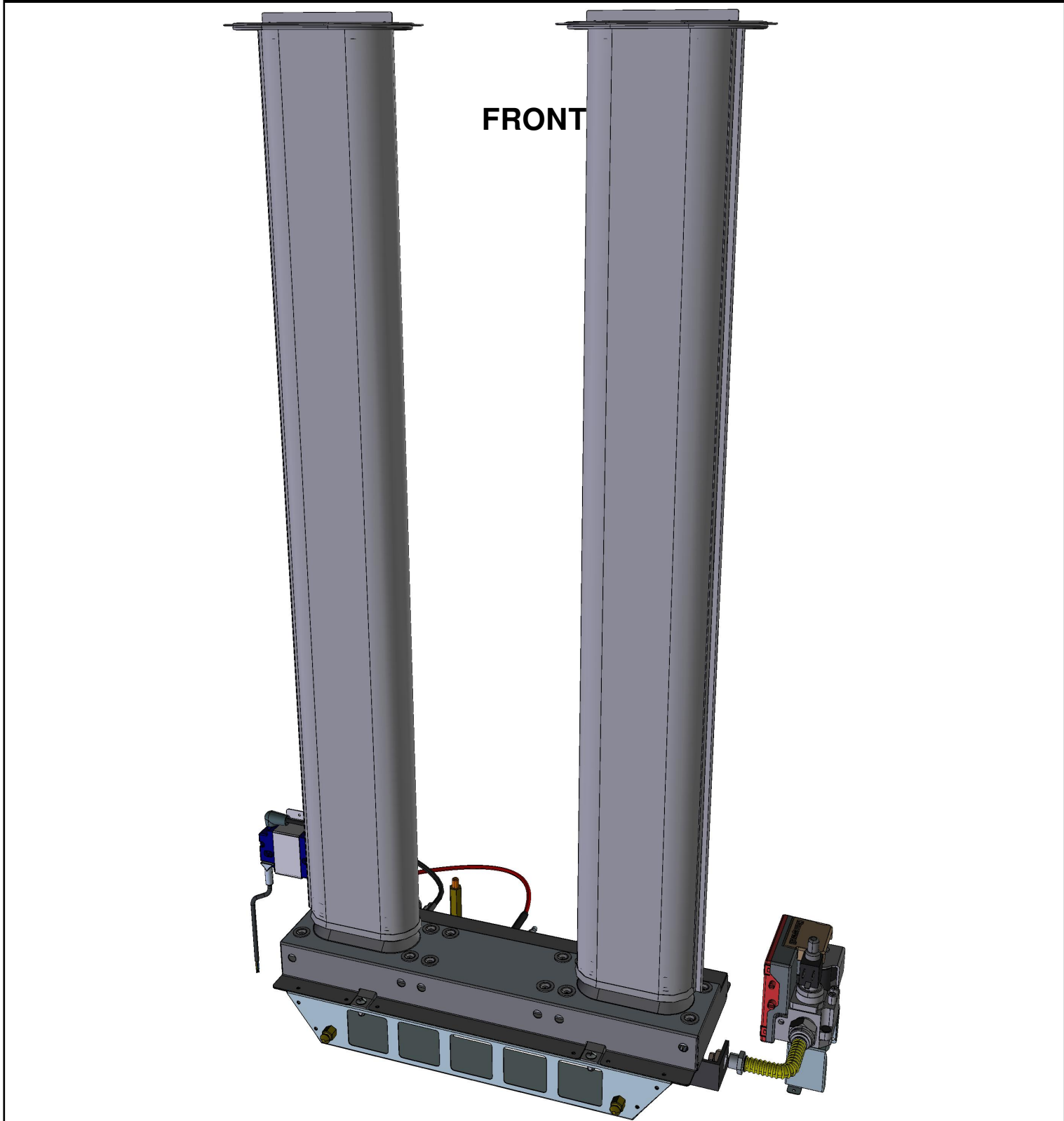





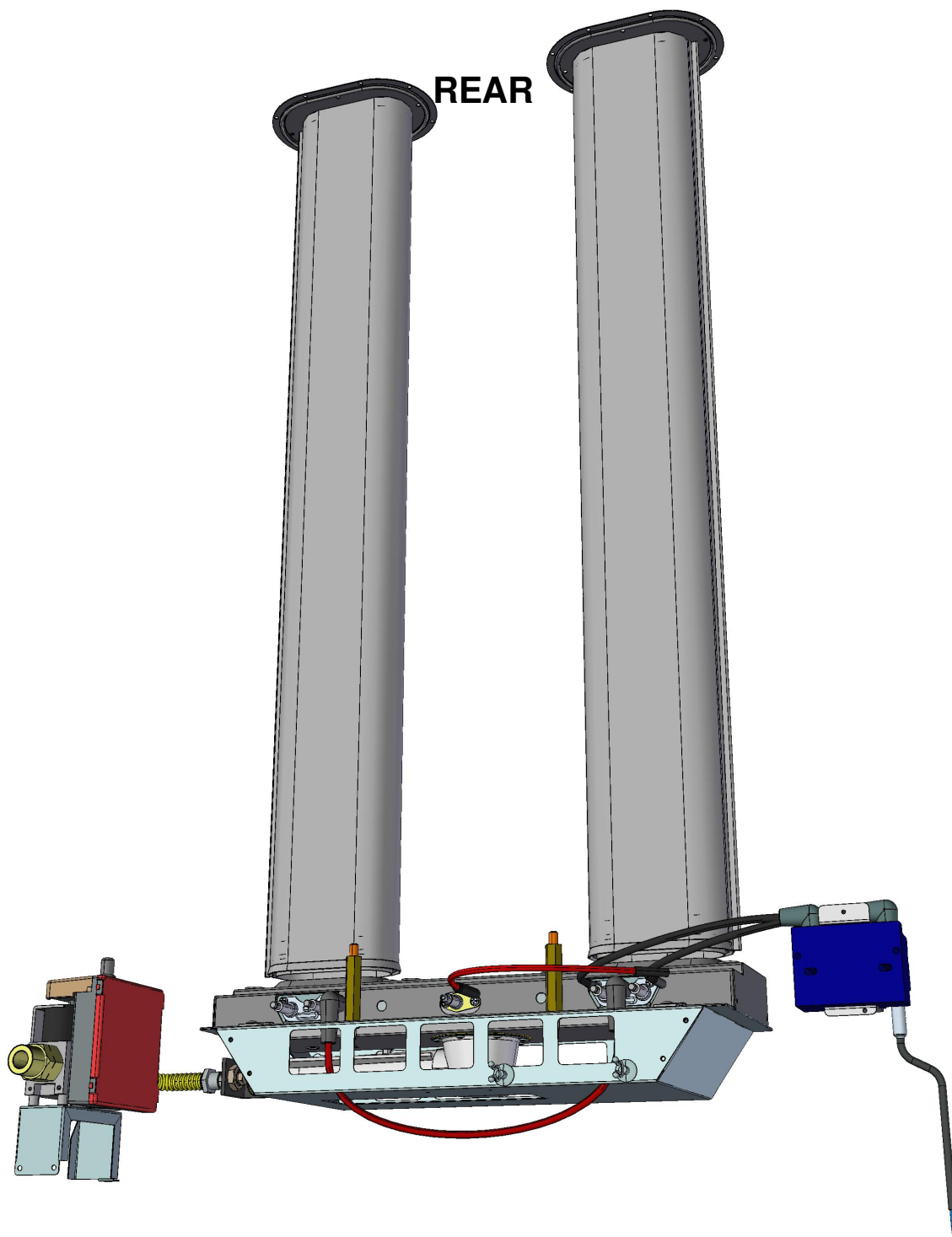

**ASM2794A/0.D00 - General overview**





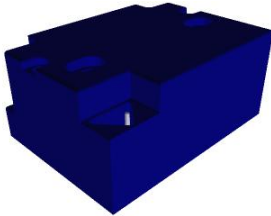

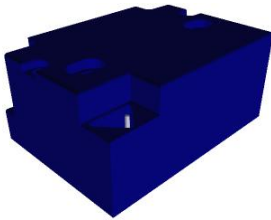
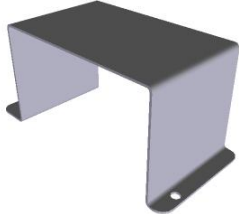

COMPONENT			SPARE PART																										
Code	Description	Image	Code	Description	Components list																								
VM1610A	CLIP TWIST LOCK DIAM. 7,6-10,2 MM		VM1610A0	CLIP TWIST LOCK DIAM. 7,6-10,2 MM																									
BR1230A	START UP SENSOR CANDLE		KBR1230A	XG SERIES SPARK DETECTION CANDLE KIT	<table border="1"> <thead> <tr> <th>Code</th> <th>Description</th> <th>Qty</th> <th>UOM</th> </tr> </thead> <tbody> <tr> <td>BR1230A0</td> <td>START UP SENSOR CANDLE</td> <td>1</td> <td>PZ</td> </tr> </tbody> </table>	Code	Description	Qty	UOM	BR1230A0	START UP SENSOR CANDLE	1	PZ																
Code	Description	Qty	UOM																										
BR1230A0	START UP SENSOR CANDLE	1	PZ																										
BR1310A	XBC-XVC DOUBLE START UP CANDLE		KBR1310A	XBC-XVC DOUBLE START UP CANDLE 2PCS. KIT	<table border="1"> <thead> <tr> <th>Code</th> <th>Description</th> <th>Qty</th> <th>UOM</th> </tr> </thead> <tbody> <tr> <td>BR1310A0</td> <td>XBC-XVC DOUBLE START UP CANDLE</td> <td>2</td> <td>PZ</td> </tr> </tbody> </table>	Code	Description	Qty	UOM	BR1310A0	XBC-XVC DOUBLE START UP CANDLE	2	PZ																
Code	Description	Qty	UOM																										
BR1310A0	XBC-XVC DOUBLE START UP CANDLE	2	PZ																										
EL1414A	TWO-STAGE GAS SOLENOID VALVE		KEL1414A	BISTABLE GAS VALVE KIT	<table border="1"> <thead> <tr> <th>Code</th> <th>Description</th> <th>Qty</th> <th>UOM</th> </tr> </thead> <tbody> <tr> <td>EL1414A0</td> <td>TWO-STAGE GAS SOLENOID VALVE</td> <td>1</td> <td>PZ</td> </tr> <tr> <td>RC1045A1</td> <td>3/4 FEMALE-3/4 STRAIGHT GAS FITTING</td> <td>1</td> <td>PZ</td> </tr> <tr> <td>RC1325A1</td> <td>FLEXIBLE GAS JOINT 3/8 EST-M13X1</td> <td>1</td> <td>PZ</td> </tr> <tr> <td>VI1130A0</td> <td>ALUMINIUM BUSHING 24X18X1,5 TO HOLD GAS</td> <td>2</td> <td>PZ</td> </tr> <tr> <td>VM2147A0</td> <td>ESD SPONGE PINK SMOOTH 410X343X15 M</td> <td>1</td> <td>PZ</td> </tr> </tbody> </table>	Code	Description	Qty	UOM	EL1414A0	TWO-STAGE GAS SOLENOID VALVE	1	PZ	RC1045A1	3/4 FEMALE-3/4 STRAIGHT GAS FITTING	1	PZ	RC1325A1	FLEXIBLE GAS JOINT 3/8 EST-M13X1	1	PZ	VI1130A0	ALUMINIUM BUSHING 24X18X1,5 TO HOLD GAS	2	PZ	VM2147A0	ESD SPONGE PINK SMOOTH 410X343X15 M	1	PZ
Code	Description	Qty	UOM																										
EL1414A0	TWO-STAGE GAS SOLENOID VALVE	1	PZ																										
RC1045A1	3/4 FEMALE-3/4 STRAIGHT GAS FITTING	1	PZ																										
RC1325A1	FLEXIBLE GAS JOINT 3/8 EST-M13X1	1	PZ																										
VI1130A0	ALUMINIUM BUSHING 24X18X1,5 TO HOLD GAS	2	PZ																										
VM2147A0	ESD SPONGE PINK SMOOTH 410X343X15 M	1	PZ																										

COMPONENT			SPARE PART																																						
Code	Description	Image	Code	Description	Components list																																				
VE1055A	HLL 220-240V 5 SEC IGNITION BOX		KVE1055A	IGNITION BOX KIT	<table border="1"> <thead> <tr> <th>Code</th> <th>Description</th> <th>Qty</th> <th>UOM</th> </tr> </thead> <tbody> <tr> <td>VE1055A1</td> <td>HLL 220-240V 5 SEC IGNITION BOX</td> <td>1</td> <td>PZ</td> </tr> <tr> <td>VE1060A0</td> <td>COVER FOR VE1055A0</td> <td>1</td> <td>PZ</td> </tr> </tbody> </table>	Code	Description	Qty	UOM	VE1055A1	HLL 220-240V 5 SEC IGNITION BOX	1	PZ	VE1060A0	COVER FOR VE1055A0	1	PZ																								
Code	Description	Qty	UOM																																						
VE1055A1	HLL 220-240V 5 SEC IGNITION BOX	1	PZ																																						
VE1060A0	COVER FOR VE1055A0	1	PZ																																						
VE1060A	COVER FOR VE1055A0		VE1060A0	COVER FOR VE1055A0																																					
0H6572B	CHEF-BAKERLUX GAS VALVE SUPPORT																																								
VE1625A	5E SERIES GAS LIGHTER		KVE0009B	EUROPE VERSION GAS IGNITER KIT	<table border="1"> <thead> <tr> <th>Code</th> <th>Description</th> <th>Qty</th> <th>UOM</th> </tr> </thead> <tbody> <tr> <td>0H5126A0</td> <td>IGNITER FIXING OMEG</td> <td>1</td> <td>PZ</td> </tr> <tr> <td>0H6825A0</td> <td>METAL CLAMP</td> <td>1</td> <td>PZ</td> </tr> <tr> <td>CE1390A0</td> <td>YELLOW CABLE UNIP RUBB.SIL. Ø 0.75 MMQ</td> <td>0.260</td> <td>M</td> </tr> <tr> <td>CE1395A0</td> <td>6,3 X 0,8 ♂MALE FASTO</td> <td>4</td> <td>PZ</td> </tr> <tr> <td>CE1661A0</td> <td>MALE FASTON COVER 6,3X0,</td> <td>4</td> <td>PZ</td> </tr> <tr> <td>CE1777A1</td> <td>HV START UP CABLE L=700 WITH SILICON CAP</td> <td>2</td> <td>PZ</td> </tr> <tr> <td>CE1782A0</td> <td>HV L=300 BRIDGE FIDA CABLE</td> <td>1</td> <td>PZ</td> </tr> <tr> <td>CE1792A0</td> <td>FLAME DETECTOR CANDLE CABL</td> <td>1</td> <td>PZ</td> </tr> </tbody> </table>	Code	Description	Qty	UOM	0H5126A0	IGNITER FIXING OMEG	1	PZ	0H6825A0	METAL CLAMP	1	PZ	CE1390A0	YELLOW CABLE UNIP RUBB.SIL. Ø 0.75 MMQ	0.260	M	CE1395A0	6,3 X 0,8 ♂MALE FASTO	4	PZ	CE1661A0	MALE FASTON COVER 6,3X0,	4	PZ	CE1777A1	HV START UP CABLE L=700 WITH SILICON CAP	2	PZ	CE1782A0	HV L=300 BRIDGE FIDA CABLE	1	PZ	CE1792A0	FLAME DETECTOR CANDLE CABL	1	PZ
Code	Description	Qty	UOM																																						
0H5126A0	IGNITER FIXING OMEG	1	PZ																																						
0H6825A0	METAL CLAMP	1	PZ																																						
CE1390A0	YELLOW CABLE UNIP RUBB.SIL. Ø 0.75 MMQ	0.260	M																																						
CE1395A0	6,3 X 0,8 ♂MALE FASTO	4	PZ																																						
CE1661A0	MALE FASTON COVER 6,3X0,	4	PZ																																						
CE1777A1	HV START UP CABLE L=700 WITH SILICON CAP	2	PZ																																						
CE1782A0	HV L=300 BRIDGE FIDA CABLE	1	PZ																																						
CE1792A0	FLAME DETECTOR CANDLE CABL	1	PZ																																						

COMPONENT			SPARE PART																																						
Code	Description	Image	Code	Description	Components list																																				
VE1625A	5E SERIES GAS LIGHTER		KVE0009B	EUROPE VERSION GAS IGNITER KIT	<table border="1"> <thead> <tr> <th>Code</th> <th>Description</th> <th>Qty</th> <th>UOM</th> </tr> </thead> <tbody> <tr> <td>CE1811A1</td> <td>LIGHTER CONNECTING CABLE PLUG 90°</td> <td>1</td> <td>PZ</td> </tr> <tr> <td>GN1328A1</td> <td>BACK BLACK ADESIVE GASKET 8X3</td> <td>0.500</td> <td>M</td> </tr> <tr> <td>VE1625A0</td> <td>5E SERIES GAS LIGHTER</td> <td>1</td> <td>PZ</td> </tr> <tr> <td>VI1220A1</td> <td>4,2X12 TCB SELF-TAPPIN G SCREW</td> <td>2</td> <td>PZ</td> </tr> <tr> <td>VI1950A0</td> <td>ST. STEEL 4,2X13 TCB SELF-DRILLIN G SCREW</td> <td>1</td> <td>PZ</td> </tr> <tr> <td>VM1255A1</td> <td>THREAD-COV ERING CAP MARUTEX</td> <td>1</td> <td>PZ</td> </tr> </tbody> </table>	Code	Description	Qty	UOM	CE1811A1	LIGHTER CONNECTING CABLE PLUG 90°	1	PZ	GN1328A1	BACK BLACK ADESIVE GASKET 8X3	0.500	M	VE1625A0	5E SERIES GAS LIGHTER	1	PZ	VI1220A1	4,2X12 TCB SELF-TAPPIN G SCREW	2	PZ	VI1950A0	ST. STEEL 4,2X13 TCB SELF-DRILLIN G SCREW	1	PZ	VM1255A1	THREAD-COV ERING CAP MARUTEX	1	PZ								
					Code	Description	Qty	UOM																																	
					CE1811A1	LIGHTER CONNECTING CABLE PLUG 90°	1	PZ																																	
					GN1328A1	BACK BLACK ADESIVE GASKET 8X3	0.500	M																																	
					VE1625A0	5E SERIES GAS LIGHTER	1	PZ																																	
					VI1220A1	4,2X12 TCB SELF-TAPPIN G SCREW	2	PZ																																	
					VI1950A0	ST. STEEL 4,2X13 TCB SELF-DRILLIN G SCREW	1	PZ																																	
VM1255A1	THREAD-COV ERING CAP MARUTEX	1	PZ																																						
0H5126A	IGNITER FIXING OMEGA		0H5126A0	IGNITER FIXING OMEGA																																					
CE1777A	HV START UP CABLE L=700 WITH SILICON CAP		KVE0013A	AUSTRALIAN VERSION GAS IGNITER KIT	<table border="1"> <thead> <tr> <th>Code</th> <th>Description</th> <th>Qty</th> <th>UOM</th> </tr> </thead> <tbody> <tr> <td>0H5126A0</td> <td>IGNITER FIXING OMEG</td> <td>1</td> <td>PZ</td> </tr> <tr> <td>CE1777A1</td> <td>HV START UP CABLE L=700 WITH SILICON CAP</td> <td>2</td> <td>PZ</td> </tr> <tr> <td>CE1782A0</td> <td>HV L=300 BRIDGE FIDA CABLE</td> <td>1</td> <td>PZ</td> </tr> <tr> <td>CE1789A0</td> <td>LIGHTER POWER SUPPLY FIDA CABLE</td> <td>1</td> <td>PZ</td> </tr> <tr> <td>CE1792A0</td> <td>FLAME DETECTOR CANDLE CABL</td> <td>1</td> <td>PZ</td> </tr> <tr> <td>GN1328A1</td> <td>BACK BLACK ADESIVE GASKET 8X3</td> <td>0.500</td> <td>M</td> </tr> <tr> <td>VE1621A0</td> <td>FIDA LIGHTER</td> <td>1</td> <td>PZ</td> </tr> <tr> <td>VI1220A1</td> <td>4,2X12 TCB SELF-TAPPIN G SCREW</td> <td>2</td> <td>PZ</td> </tr> </tbody> </table>	Code	Description	Qty	UOM	0H5126A0	IGNITER FIXING OMEG	1	PZ	CE1777A1	HV START UP CABLE L=700 WITH SILICON CAP	2	PZ	CE1782A0	HV L=300 BRIDGE FIDA CABLE	1	PZ	CE1789A0	LIGHTER POWER SUPPLY FIDA CABLE	1	PZ	CE1792A0	FLAME DETECTOR CANDLE CABL	1	PZ	GN1328A1	BACK BLACK ADESIVE GASKET 8X3	0.500	M	VE1621A0	FIDA LIGHTER	1	PZ	VI1220A1	4,2X12 TCB SELF-TAPPIN G SCREW	2	PZ
					Code	Description	Qty	UOM																																	
					0H5126A0	IGNITER FIXING OMEG	1	PZ																																	
					CE1777A1	HV START UP CABLE L=700 WITH SILICON CAP	2	PZ																																	
					CE1782A0	HV L=300 BRIDGE FIDA CABLE	1	PZ																																	
					CE1789A0	LIGHTER POWER SUPPLY FIDA CABLE	1	PZ																																	
					CE1792A0	FLAME DETECTOR CANDLE CABL	1	PZ																																	
					GN1328A1	BACK BLACK ADESIVE GASKET 8X3	0.500	M																																	
					VE1621A0	FIDA LIGHTER	1	PZ																																	
					VI1220A1	4,2X12 TCB SELF-TAPPIN G SCREW	2	PZ																																	

COMPONENT			SPARE PART																																											
Code	Description	Image	Code	Description	Components list																																									
CE1777A	HV START UP CABLE L=700 WITH SILICON CAP		KVE0010A	USA VERSION GAS IGNITER KIT	<table border="1"> <thead> <tr> <th>Code</th> <th>Description</th> <th>Qty</th> <th>UOM</th> </tr> </thead> <tbody> <tr> <td>0H7457A1</td> <td>SHIELD- META</td> <td>1</td> <td>PZ</td> </tr> <tr> <td>CE1056A0</td> <td>IC POWER CABLE UNIT GAS USA MM</td> <td>2</td> <td>PZ</td> </tr> <tr> <td>CE1057B0</td> <td>MM USA GAS-IGNITER CONTROL EV CABLE</td> <td>2</td> <td>PZ</td> </tr> <tr> <td>CE1059A1</td> <td>3P-6.35MM FLAME DETECTOR 10KV CABLE</td> <td>2</td> <td>PZ</td> </tr> <tr> <td>CE1777A1</td> <td>HV START UP CABLE L=700 WITH SILICON CAP</td> <td>4</td> <td>PZ</td> </tr> <tr> <td>GN1328A1</td> <td>BACK BLACK ADESIVE GASKET 8X3</td> <td>0.500</td> <td>M</td> </tr> <tr> <td>VE1637A0</td> <td>FLAME CONTROL BOARD</td> <td>2</td> <td>PZ</td> </tr> <tr> <td>VI1220A1</td> <td>4,2X12 TCB SELF-TAPPIN G SCREW</td> <td>4</td> <td>PZ</td> </tr> </tbody> </table>	Code	Description	Qty	UOM	0H7457A1	SHIELD- META	1	PZ	CE1056A0	IC POWER CABLE UNIT GAS USA MM	2	PZ	CE1057B0	MM USA GAS-IGNITER CONTROL EV CABLE	2	PZ	CE1059A1	3P-6.35MM FLAME DETECTOR 10KV CABLE	2	PZ	CE1777A1	HV START UP CABLE L=700 WITH SILICON CAP	4	PZ	GN1328A1	BACK BLACK ADESIVE GASKET 8X3	0.500	M	VE1637A0	FLAME CONTROL BOARD	2	PZ	VI1220A1	4,2X12 TCB SELF-TAPPIN G SCREW	4	PZ					
			Code	Description	Qty	UOM																																								
0H7457A1	SHIELD- META	1	PZ																																											
CE1056A0	IC POWER CABLE UNIT GAS USA MM	2	PZ																																											
CE1057B0	MM USA GAS-IGNITER CONTROL EV CABLE	2	PZ																																											
CE1059A1	3P-6.35MM FLAME DETECTOR 10KV CABLE	2	PZ																																											
CE1777A1	HV START UP CABLE L=700 WITH SILICON CAP	4	PZ																																											
GN1328A1	BACK BLACK ADESIVE GASKET 8X3	0.500	M																																											
VE1637A0	FLAME CONTROL BOARD	2	PZ																																											
VI1220A1	4,2X12 TCB SELF-TAPPIN G SCREW	4	PZ																																											
KVE0009B	EUROPE VERSION GAS IGNITER KIT	<table border="1"> <thead> <tr> <th>Code</th> <th>Description</th> <th>Qty</th> <th>UOM</th> </tr> </thead> <tbody> <tr> <td>0H5126A0</td> <td>IGNITER FIXING OMEG</td> <td>1</td> <td>PZ</td> </tr> <tr> <td>0H6825A0</td> <td>METAL CLAMP</td> <td>1</td> <td>PZ</td> </tr> <tr> <td>CE1390A0</td> <td>YELLOW CABLE UNIP RUBB.SIL. Ø 0,75 MMQ</td> <td>0.260</td> <td>M</td> </tr> <tr> <td>CE1395A0</td> <td>6,3 X 0,8 IMALE FASTO</td> <td>4</td> <td>PZ</td> </tr> <tr> <td>CE1661A0</td> <td>MALE FASTON COVER 6,3X0,</td> <td>4</td> <td>PZ</td> </tr> <tr> <td>CE1777A1</td> <td>HV START UP CABLE L=700 WITH SILICON CAP</td> <td>2</td> <td>PZ</td> </tr> <tr> <td>CE1782A0</td> <td>HV L=300 BRIDGE FIDA CABLE</td> <td>1</td> <td>PZ</td> </tr> <tr> <td>CE1792A0</td> <td>FLAME DETECTOR CANDLE CABL</td> <td>1</td> <td>PZ</td> </tr> <tr> <td>CE1811A1</td> <td>LIGHTER CONNECTING CABLE PLUG 90°</td> <td>1</td> <td>PZ</td> </tr> <tr> <td>GN1328A1</td> <td>BACK BLACK ADESIVE GASKET 8X3</td> <td>0.500</td> <td>M</td> </tr> </tbody> </table>	Code	Description	Qty	UOM	0H5126A0	IGNITER FIXING OMEG	1	PZ	0H6825A0	METAL CLAMP	1	PZ	CE1390A0	YELLOW CABLE UNIP RUBB.SIL. Ø 0,75 MMQ	0.260	M	CE1395A0	6,3 X 0,8 IMALE FASTO	4	PZ	CE1661A0	MALE FASTON COVER 6,3X0,	4	PZ	CE1777A1	HV START UP CABLE L=700 WITH SILICON CAP	2	PZ	CE1782A0	HV L=300 BRIDGE FIDA CABLE	1	PZ	CE1792A0	FLAME DETECTOR CANDLE CABL	1	PZ	CE1811A1	LIGHTER CONNECTING CABLE PLUG 90°	1	PZ	GN1328A1	BACK BLACK ADESIVE GASKET 8X3	0.500	M
Code	Description	Qty	UOM																																											
0H5126A0	IGNITER FIXING OMEG	1	PZ																																											
0H6825A0	METAL CLAMP	1	PZ																																											
CE1390A0	YELLOW CABLE UNIP RUBB.SIL. Ø 0,75 MMQ	0.260	M																																											
CE1395A0	6,3 X 0,8 IMALE FASTO	4	PZ																																											
CE1661A0	MALE FASTON COVER 6,3X0,	4	PZ																																											
CE1777A1	HV START UP CABLE L=700 WITH SILICON CAP	2	PZ																																											
CE1782A0	HV L=300 BRIDGE FIDA CABLE	1	PZ																																											
CE1792A0	FLAME DETECTOR CANDLE CABL	1	PZ																																											
CE1811A1	LIGHTER CONNECTING CABLE PLUG 90°	1	PZ																																											
GN1328A1	BACK BLACK ADESIVE GASKET 8X3	0.500	M																																											

COMPONENT			SPARE PART																						
Code	Description	Image	Code	Description	Components list																				
CE1777A	HV START UP CABLE L=700 WITH SILICON CAP		KVE0009B	EUROPE VERSION GAS IGNITER KIT	<table border="1"> <thead> <tr> <th>Code</th> <th>Description</th> <th>Qty</th> <th>UOM</th> </tr> </thead> <tbody> <tr> <td>VE1625A0</td> <td>5E SERIES GAS LIGHTER</td> <td>1</td> <td>PZ</td> </tr> <tr> <td>VI1220A1</td> <td>4,2X12 TCB SELF-TAPPIN G SCREW</td> <td>2</td> <td>PZ</td> </tr> <tr> <td>VI1950A0</td> <td>ST. STEEL 4,2X13 TCB SELF-DRILLIN G SCREW</td> <td>1</td> <td>PZ</td> </tr> <tr> <td>VM1255A1</td> <td>THREAD-COV ERING CAP MARUTEX</td> <td>1</td> <td>PZ</td> </tr> </tbody> </table>	Code	Description	Qty	UOM	VE1625A0	5E SERIES GAS LIGHTER	1	PZ	VI1220A1	4,2X12 TCB SELF-TAPPIN G SCREW	2	PZ	VI1950A0	ST. STEEL 4,2X13 TCB SELF-DRILLIN G SCREW	1	PZ	VM1255A1	THREAD-COV ERING CAP MARUTEX	1	PZ
			Code	Description	Qty	UOM																			
VE1625A0	5E SERIES GAS LIGHTER	1	PZ																						
VI1220A1	4,2X12 TCB SELF-TAPPIN G SCREW	2	PZ																						
VI1950A0	ST. STEEL 4,2X13 TCB SELF-DRILLIN G SCREW	1	PZ																						
VM1255A1	THREAD-COV ERING CAP MARUTEX	1	PZ																						
KCE1777A	EUROPE VERSION HV START UP CABLES KIT	<table border="1"> <thead> <tr> <th>Code</th> <th>Description</th> <th>Qty</th> <th>UOM</th> </tr> </thead> <tbody> <tr> <td>CE1777A1</td> <td>HV START UP CABLE L=700 WITH SILICON CAP</td> <td>2</td> <td>PZ</td> </tr> <tr> <td>CE1782A0</td> <td>HV L=300 BRIDGE FIDA CABLE</td> <td>1</td> <td>PZ</td> </tr> </tbody> </table>	Code	Description	Qty	UOM	CE1777A1	HV START UP CABLE L=700 WITH SILICON CAP	2	PZ	CE1782A0	HV L=300 BRIDGE FIDA CABLE	1	PZ											
Code	Description	Qty	UOM																						
CE1777A1	HV START UP CABLE L=700 WITH SILICON CAP	2	PZ																						
CE1782A0	HV L=300 BRIDGE FIDA CABLE	1	PZ																						
0N1135A	GAS BAFFLE FORK																								
0N1235A	XBC814G BAFFLE		0N1235A0	XBC814G BAFFLE																					