

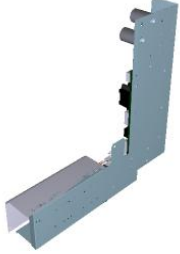





Assembly code	Assembly revision	Assembly image
ASM3069A/0.D04	Electrical system	
ASM3007A/0.D06	Door	
ASM1745B/0.D01	Cooking chamber	
ASM1771B/0.D01	External cover	

ASM3069A/0.D04 - Electrical system

FRONT

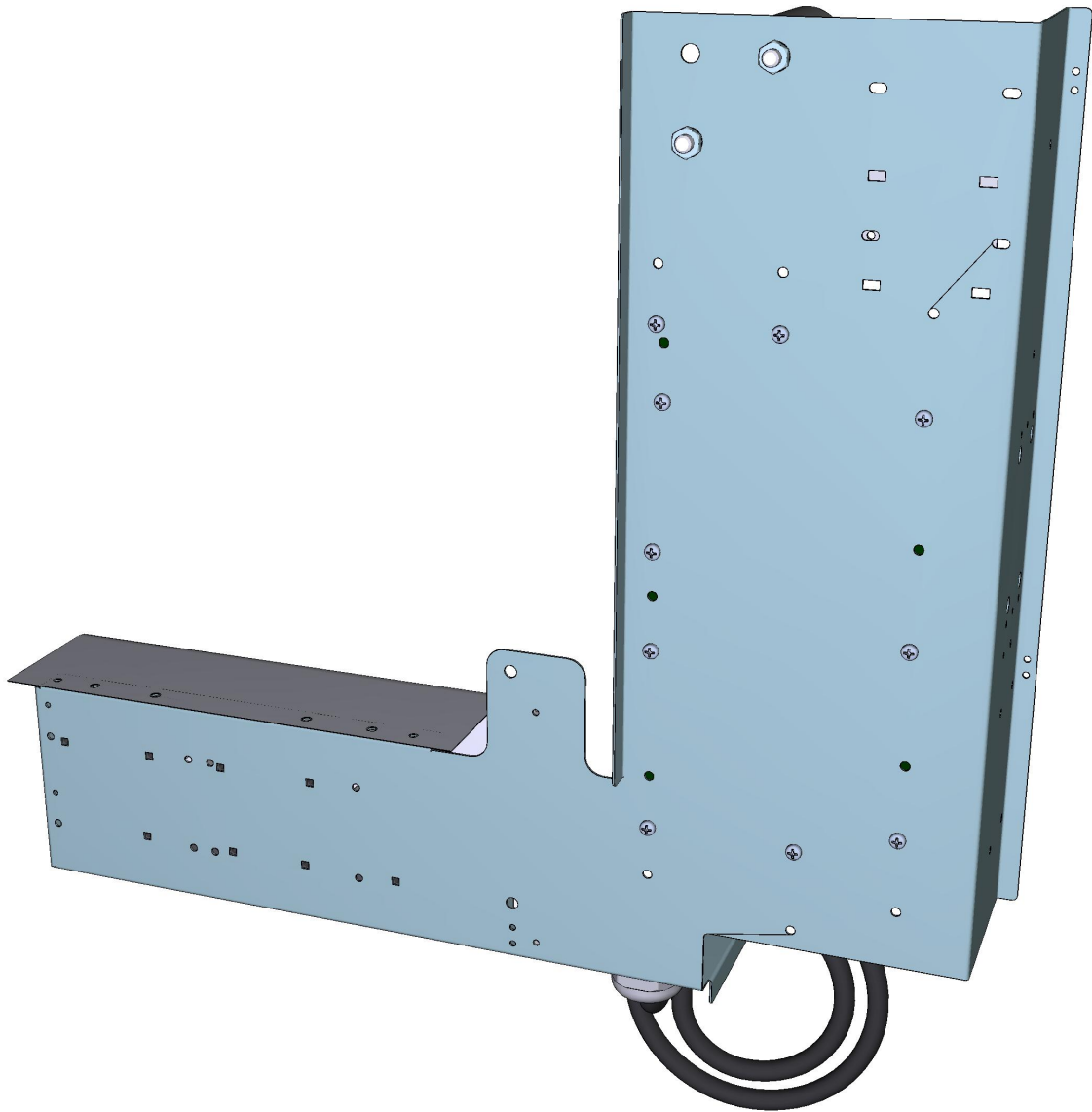



ASM3069A/0.D04 - Electrical system

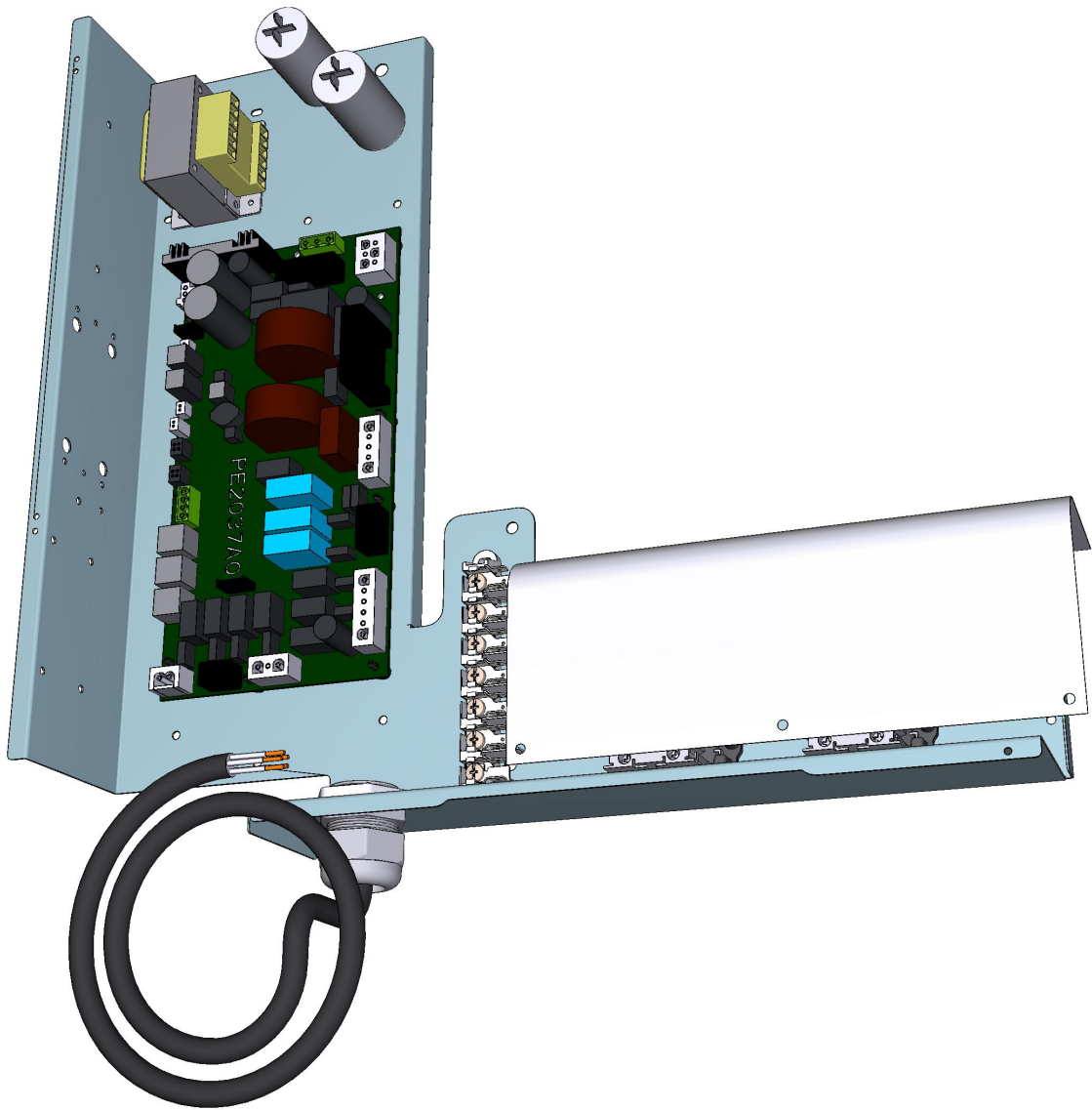

REAR

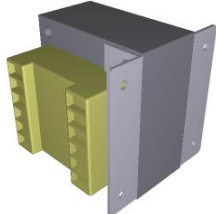

COMPONENT			SPARE PART																						
Code	Description	Image	Code	Description	Components list																				
CN1003A	6,3 UF MOTOR CAPACITOR		KCN1003A	6,3 UF MOTOR CAPACITOR KIT	<table border="1"> <thead> <tr> <th>Code</th> <th>Description</th> <th>Qty</th> <th>UOM</th> </tr> </thead> <tbody> <tr> <td>CN1003A0</td> <td>6,3 UF MOTOR CAPACITOR</td> <td>1</td> <td>PZ</td> </tr> <tr> <td>VI1931A0</td> <td>M8 NUT+INDENTE D WASHER D=8 X COND.</td> <td>1</td> <td>PZ</td> </tr> <tr> <td>VI1932A0</td> <td>M8 NUT+INDENTE D WASHER D=8 X COND.</td> <td>1</td> <td>PZ</td> </tr> <tr> <td>VM1224A0</td> <td></td> <td>0.200</td> <td>M</td> </tr> </tbody> </table>	Code	Description	Qty	UOM	CN1003A0	6,3 UF MOTOR CAPACITOR	1	PZ	VI1931A0	M8 NUT+INDENTE D WASHER D=8 X COND.	1	PZ	VI1932A0	M8 NUT+INDENTE D WASHER D=8 X COND.	1	PZ	VM1224A0		0.200	M
					Code	Description	Qty	UOM																	
CN1003A0	6,3 UF MOTOR CAPACITOR	1	PZ																						
VI1931A0	M8 NUT+INDENTE D WASHER D=8 X COND.	1	PZ																						
VI1932A0	M8 NUT+INDENTE D WASHER D=8 X COND.	1	PZ																						
VM1224A0		0.200	M																						
VE1115A	20 A 230V 4 POLES MINICONTACTOR		KVE1115A	20A 230V 4 POLES MINICONTACTOR KI	<table border="1"> <thead> <tr> <th>Code</th> <th>Description</th> <th>Qty</th> <th>UOM</th> </tr> </thead> <tbody> <tr> <td>VE1115A0</td> <td>20 A 230V 4 POLES MINICONTACTOR</td> <td>1</td> <td>PZ</td> </tr> <tr> <td>VM1075A1</td> <td>PLASTIC CLIP TO FIX CONTACTORS</td> <td>4</td> <td>PZ</td> </tr> <tr> <td>VM1224A0</td> <td></td> <td>0.250</td> <td>M</td> </tr> </tbody> </table>	Code	Description	Qty	UOM	VE1115A0	20 A 230V 4 POLES MINICONTACTOR	1	PZ	VM1075A1	PLASTIC CLIP TO FIX CONTACTORS	4	PZ	VM1224A0		0.250	M				
Code	Description	Qty	UOM																						
VE1115A0	20 A 230V 4 POLES MINICONTACTOR	1	PZ																						
VM1075A1	PLASTIC CLIP TO FIX CONTACTORS	4	PZ																						
VM1224A0		0.250	M																						
VM1056A	SMALL CONTACTOR BRACKET VE1115A		VM1056A0	SMALL CONTACTOR BRACKET VE1115A																					
MR1004A	41A 450V 7 POLES TERMINAL		KMR1004A	7FTW 1+2+3/4+5+6 TERMINAL BLOCK KIT	<table border="1"> <thead> <tr> <th>Code</th> <th>Description</th> <th>Qty</th> <th>UOM</th> </tr> </thead> <tbody> <tr> <td>MR1004A1</td> <td>41A 450V 7 POLES TERMINAL</td> <td>1</td> <td>PZ</td> </tr> <tr> <td>VM1224A0</td> <td></td> <td>0.300</td> <td>M</td> </tr> </tbody> </table>	Code	Description	Qty	UOM	MR1004A1	41A 450V 7 POLES TERMINAL	1	PZ	VM1224A0		0.300	M								
Code	Description	Qty	UOM																						
MR1004A1	41A 450V 7 POLES TERMINAL	1	PZ																						
VM1224A0		0.300	M																						
VE1644A	PG 29 STRAIN RELIEF NUT		VE1644A0	PG 29 STRAIN RELIEF NUT																					

COMPONENT			SPARE PART																						
Code	Description	Image	Code	Description	Components list																				
VE1645A	REDUCED PG 29 STRAIN RELIEF		OUTOFPRODUCTIO																						
CE1355A	CABLE 5 X 2,5 MMQ H07RNF L = 1,5 MT		KCE1355A	CONNECTOR KIT	<table border="1"> <thead> <tr> <th>Code</th> <th>Description</th> <th>Qty</th> <th>UOM</th> </tr> </thead> <tbody> <tr> <td>CE1355A1</td> <td>CABLE 5 X 2,5 MMQ H07RNF L = 1,5 MT</td> <td>1</td> <td>PZ</td> </tr> <tr> <td>VM1224A0</td> <td></td> <td>0.350</td> <td>M</td> </tr> </tbody> </table>	Code	Description	Qty	UOM	CE1355A1	CABLE 5 X 2,5 MMQ H07RNF L = 1,5 MT	1	PZ	VM1224A0		0.350	M								
Code	Description	Qty	UOM																						
CE1355A1	CABLE 5 X 2,5 MMQ H07RNF L = 1,5 MT	1	PZ																						
VM1224A0		0.350	M																						
VM1745A	CARD SUPPORT		KVM1745A	BOARD SUPPORT 10 PCS KIT	<table border="1"> <thead> <tr> <th>Code</th> <th>Description</th> <th>Qty</th> <th>UOM</th> </tr> </thead> <tbody> <tr> <td>VM1224A0</td> <td></td> <td>0.200</td> <td>M</td> </tr> <tr> <td>VM1745A0</td> <td>CARD SUPPORT</td> <td>10</td> <td>PZ</td> </tr> </tbody> </table>	Code	Description	Qty	UOM	VM1224A0		0.200	M	VM1745A0	CARD SUPPORT	10	PZ								
Code	Description	Qty	UOM																						
VM1224A0		0.200	M																						
VM1745A0	CARD SUPPORT	10	PZ																						
PE2037A	MIND.MAPS ONE POWER CARD		KPE2037A	MIND.MAPS ONE POWER BOARD KIT	<table border="1"> <thead> <tr> <th>Code</th> <th>Description</th> <th>Qty</th> <th>UOM</th> </tr> </thead> <tbody> <tr> <td>PE2037A0</td> <td>MIND.MAPS ONE POWER CARD</td> <td>1</td> <td>PZ</td> </tr> <tr> <td>VI1850A0</td> <td>M4X6 NICKEL PLATED FIXING SCRE</td> <td>9</td> <td>PZ</td> </tr> <tr> <td>VM1745A0</td> <td>CARD SUPPORT</td> <td>9</td> <td>PZ</td> </tr> <tr> <td>VM2147A0</td> <td>410X343X15 MM PINK SMOOTH ESD SPONGE</td> <td>1</td> <td>PZ</td> </tr> </tbody> </table>	Code	Description	Qty	UOM	PE2037A0	MIND.MAPS ONE POWER CARD	1	PZ	VI1850A0	M4X6 NICKEL PLATED FIXING SCRE	9	PZ	VM1745A0	CARD SUPPORT	9	PZ	VM2147A0	410X343X15 MM PINK SMOOTH ESD SPONGE	1	PZ
Code	Description	Qty	UOM																						
PE2037A0	MIND.MAPS ONE POWER CARD	1	PZ																						
VI1850A0	M4X6 NICKEL PLATED FIXING SCRE	9	PZ																						
VM1745A0	CARD SUPPORT	9	PZ																						
VM2147A0	410X343X15 MM PINK SMOOTH ESD SPONGE	1	PZ																						
VE1639A	TRANSFORMER 230-12VAC 60VA		KVE1639A	230-12VAC 60VA TRANSFORMER KIT	<table border="1"> <thead> <tr> <th>Code</th> <th>Description</th> <th>Qty</th> <th>UOM</th> </tr> </thead> <tbody> <tr> <td>VE1639A0</td> <td>TRANSFORME R 230-12VAC 60VA</td> <td>1</td> <td>PZ</td> </tr> <tr> <td>VI1950A0</td> <td>ST. STEEL 4,2X13 TCB SELF-DRILLIN G SCREW</td> <td>4</td> <td>PZ</td> </tr> </tbody> </table>	Code	Description	Qty	UOM	VE1639A0	TRANSFORME R 230-12VAC 60VA	1	PZ	VI1950A0	ST. STEEL 4,2X13 TCB SELF-DRILLIN G SCREW	4	PZ								
Code	Description	Qty	UOM																						
VE1639A0	TRANSFORME R 230-12VAC 60VA	1	PZ																						
VI1950A0	ST. STEEL 4,2X13 TCB SELF-DRILLIN G SCREW	4	PZ																						

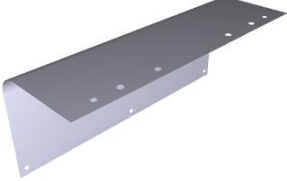

COMPONENT			SPARE PART		
<i>Code</i>	<i>Description</i>	<i>Image</i>	<i>Code</i>	<i>Description</i>	<i>Components list</i>
VM2387A	MM XEVC REMOTE CONTROL SWITCH PROTECTION		VM2387A0	MM XEVC REMOTE CONTROL SWITCH PROTECTION	
0H7371A	XEBC MM COMPONENTS HOLDING PLATE		0H7371A0	XEBC MM COMPONENTS HOLDING PLATE	

ASM3007A/0.D06 - Door

FRONT

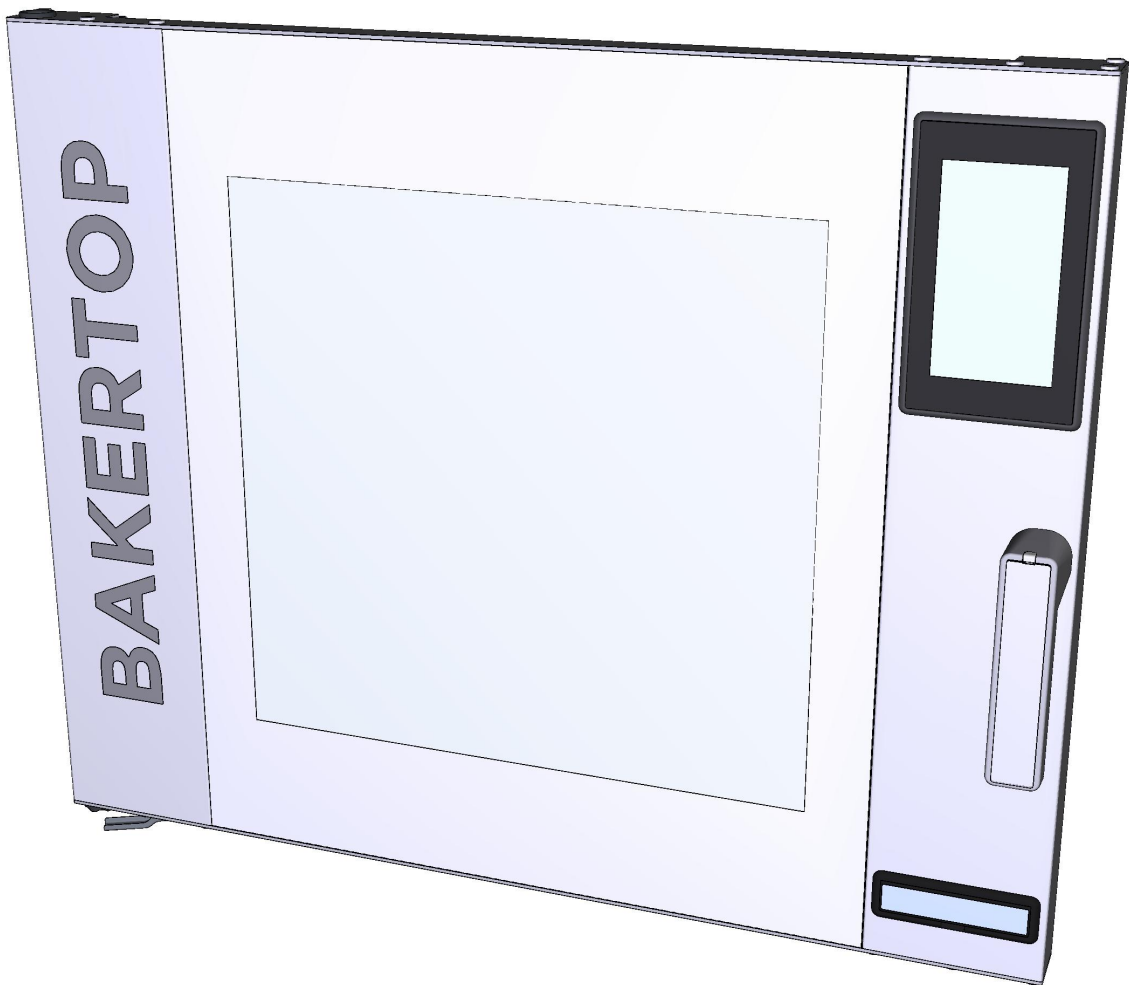

ASM3007A/0.D06 - Door

REAR

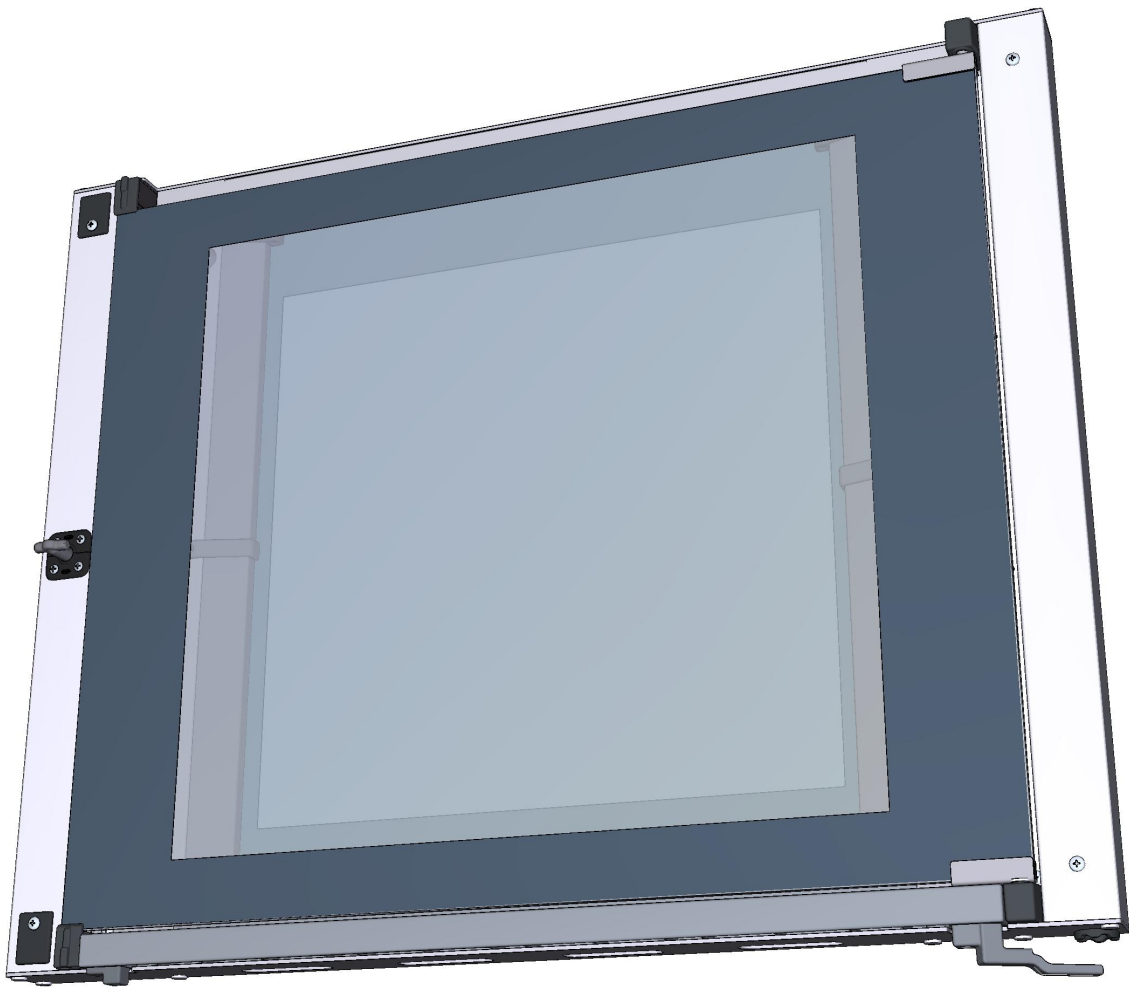







COMPONENT			SPARE PART																																																																																						
Code	Description	Image	Code	Description	Components list																																																																																				
VM2274A	GROOVED BUSHING		KVM2274A	GROOVED PIN BUSHING KIT	<table border="1"> <thead> <tr> <th>Code</th> <th>Description</th> <th>Qty</th> <th>UOM</th> </tr> </thead> <tbody> <tr> <td>VM1224A0</td> <td></td> <td>0.150</td> <td>M</td> </tr> <tr> <td>VM2274A0</td> <td>GROOVED BUSHING</td> <td>1</td> <td>PZ</td> </tr> </tbody> </table>	Code	Description	Qty	UOM	VM1224A0		0.150	M	VM2274A0	GROOVED BUSHING	1	PZ																																																																								
			Code	Description	Qty	UOM																																																																																			
VM1224A0		0.150	M																																																																																						
VM2274A0	GROOVED BUSHING	1	PZ																																																																																						
K0B1126AR	BAKERTOP MM RIGHT DOOR LOWER BEAM KIT	<table border="1"> <thead> <tr> <th>Code</th> <th>Description</th> <th>Qty</th> <th>UOM</th> </tr> </thead> <tbody> <tr> <td>0B1126A0</td> <td>DOOR LOWER FRAME SHAPE 860 MM</td> <td>1</td> <td>PZ</td> </tr> <tr> <td>0B1126A1</td> <td></td> <td>1</td> <td>PZ</td> </tr> <tr> <td>RC1200A0</td> <td>ED=4 WIRE D.=0.5 COMPRESSIO N SPRING</td> <td>2</td> <td>PZ</td> </tr> <tr> <td>VI1220A1</td> <td>4,2X12 TCB SELF-TAPPIN G SCREW</td> <td>1</td> <td>PZ</td> </tr> <tr> <td>VI1996A0</td> <td>M5X35 SCREW</td> <td>7</td> <td>PZ</td> </tr> <tr> <td>VM1794A0</td> <td>250X4.8 PA66 BLACK CLAMP</td> <td>2</td> <td>PZ</td> </tr> <tr> <td>VM2103A0</td> <td>CLAMP LOCK</td> <td>2</td> <td>PZ</td> </tr> <tr> <td>VM2259A1</td> <td>6 SERIES DOOR LOWER LEFT CAP</td> <td>1</td> <td>PZ</td> </tr> <tr> <td>VM2261A1</td> <td>6 SERIES DOOR LOWER RIGHT CAP</td> <td>1</td> <td>PZ</td> </tr> <tr> <td>VM2267A0</td> <td>INTERNAL GLASS LOCKING SYSTEM SLIDER</td> <td>1</td> <td>PZ</td> </tr> <tr> <td>VM2269A0</td> <td>INTERNAL GLASS LOCKING SYSTEM CAP</td> <td>1</td> <td>PZ</td> </tr> <tr> <td>VM2274A0</td> <td>GROOVED BUSHING</td> <td>1</td> <td>PZ</td> </tr> <tr> <td>VM2305A0</td> <td>6 SERIES DOOR CAP FIXING PAWL</td> <td>7</td> <td>PZ</td> </tr> </tbody> </table>	Code	Description	Qty	UOM	0B1126A0	DOOR LOWER FRAME SHAPE 860 MM	1	PZ	0B1126A1		1	PZ	RC1200A0	ED=4 WIRE D.=0.5 COMPRESSIO N SPRING	2	PZ	VI1220A1	4,2X12 TCB SELF-TAPPIN G SCREW	1	PZ	VI1996A0	M5X35 SCREW	7	PZ	VM1794A0	250X4.8 PA66 BLACK CLAMP	2	PZ	VM2103A0	CLAMP LOCK	2	PZ	VM2259A1	6 SERIES DOOR LOWER LEFT CAP	1	PZ	VM2261A1	6 SERIES DOOR LOWER RIGHT CAP	1	PZ	VM2267A0	INTERNAL GLASS LOCKING SYSTEM SLIDER	1	PZ	VM2269A0	INTERNAL GLASS LOCKING SYSTEM CAP	1	PZ	VM2274A0	GROOVED BUSHING	1	PZ	VM2305A0	6 SERIES DOOR CAP FIXING PAWL	7	PZ	K0B1126AL	EU AND 2/1 MM LEFT DOOR LOWER BEAM KIT	<table border="1"> <thead> <tr> <th>Code</th> <th>Description</th> <th>Qty</th> <th>UOM</th> </tr> </thead> <tbody> <tr> <td>0B1126A0</td> <td>DOOR LOWER FRAME SHAPE 860 MM</td> <td>1</td> <td>PZ</td> </tr> <tr> <td>0B1126A1</td> <td></td> <td>1</td> <td>PZ</td> </tr> <tr> <td>RC1200A0</td> <td>ED=4 WIRE D.=0.5 COMPRESSIO N SPRING</td> <td>2</td> <td>PZ</td> </tr> <tr> <td>VI1220A1</td> <td>4,2X12 TCB SELF-TAPPIN G SCREW</td> <td>1</td> <td>PZ</td> </tr> <tr> <td>VI1996A0</td> <td>M5X35 SCREW</td> <td>7</td> <td>PZ</td> </tr> <tr> <td>VM1794A0</td> <td>250X4.8 PA66 BLACK CLAMP</td> <td>2</td> <td>PZ</td> </tr> </tbody> </table>	Code	Description	Qty	UOM	0B1126A0	DOOR LOWER FRAME SHAPE 860 MM	1	PZ	0B1126A1		1	PZ	RC1200A0	ED=4 WIRE D.=0.5 COMPRESSIO N SPRING	2	PZ	VI1220A1	4,2X12 TCB SELF-TAPPIN G SCREW	1	PZ	VI1996A0	M5X35 SCREW	7	PZ	VM1794A0	250X4.8 PA66 BLACK CLAMP	2	PZ
Code	Description	Qty	UOM																																																																																						
0B1126A0	DOOR LOWER FRAME SHAPE 860 MM	1	PZ																																																																																						
0B1126A1		1	PZ																																																																																						
RC1200A0	ED=4 WIRE D.=0.5 COMPRESSIO N SPRING	2	PZ																																																																																						
VI1220A1	4,2X12 TCB SELF-TAPPIN G SCREW	1	PZ																																																																																						
VI1996A0	M5X35 SCREW	7	PZ																																																																																						
VM1794A0	250X4.8 PA66 BLACK CLAMP	2	PZ																																																																																						
VM2103A0	CLAMP LOCK	2	PZ																																																																																						
VM2259A1	6 SERIES DOOR LOWER LEFT CAP	1	PZ																																																																																						
VM2261A1	6 SERIES DOOR LOWER RIGHT CAP	1	PZ																																																																																						
VM2267A0	INTERNAL GLASS LOCKING SYSTEM SLIDER	1	PZ																																																																																						
VM2269A0	INTERNAL GLASS LOCKING SYSTEM CAP	1	PZ																																																																																						
VM2274A0	GROOVED BUSHING	1	PZ																																																																																						
VM2305A0	6 SERIES DOOR CAP FIXING PAWL	7	PZ																																																																																						
Code	Description	Qty	UOM																																																																																						
0B1126A0	DOOR LOWER FRAME SHAPE 860 MM	1	PZ																																																																																						
0B1126A1		1	PZ																																																																																						
RC1200A0	ED=4 WIRE D.=0.5 COMPRESSIO N SPRING	2	PZ																																																																																						
VI1220A1	4,2X12 TCB SELF-TAPPIN G SCREW	1	PZ																																																																																						
VI1996A0	M5X35 SCREW	7	PZ																																																																																						
VM1794A0	250X4.8 PA66 BLACK CLAMP	2	PZ																																																																																						





COMPONENT			SPARE PART																																										
Code	Description	Image	Code	Description	Components list																																								
VM2274A	GROOVED BUSHING		K0B1126AL	EU AND 2/1 MM LEFT DOOR LOWER BEAM KIT	<table border="1"> <thead> <tr> <th>Code</th> <th>Description</th> <th>Qty</th> <th>UOM</th> </tr> </thead> <tbody> <tr> <td>VM2103A0</td> <td>CLAMP LOCK</td> <td>2</td> <td>PZ</td> </tr> <tr> <td>VM2267A0</td> <td>INTERNAL GLASS LOCKING SYSTEM SLIDER</td> <td>1</td> <td>PZ</td> </tr> <tr> <td>VM2269A0</td> <td>INTERNAL GLASS LOCKING SYSTEM CAP</td> <td>1</td> <td>PZ</td> </tr> <tr> <td>VM2274A0</td> <td>GROOVED BUSHING</td> <td>1</td> <td>PZ</td> </tr> <tr> <td>VM2305A0</td> <td>6 SERIES DOOR CAP FIXING PAWL</td> <td>7</td> <td>PZ</td> </tr> <tr> <td>VM2384A0</td> <td>MM LEFT DOOR RIGHT LOWER CAP</td> <td>1</td> <td>PZ</td> </tr> <tr> <td>VM2384A0</td> <td>MM LEFT DOOR RIGHT LOWER CAP</td> <td>1</td> <td>PZ</td> </tr> <tr> <td>VM2386A1</td> <td>LEFT MM DOOR LOWER LEFT CAP</td> <td>1</td> <td>PZ</td> </tr> <tr> <td>VM2386A1</td> <td>LEFT MM DOOR LOWER LEFT CAP</td> <td>1</td> <td>PZ</td> </tr> </tbody> </table>	Code	Description	Qty	UOM	VM2103A0	CLAMP LOCK	2	PZ	VM2267A0	INTERNAL GLASS LOCKING SYSTEM SLIDER	1	PZ	VM2269A0	INTERNAL GLASS LOCKING SYSTEM CAP	1	PZ	VM2274A0	GROOVED BUSHING	1	PZ	VM2305A0	6 SERIES DOOR CAP FIXING PAWL	7	PZ	VM2384A0	MM LEFT DOOR RIGHT LOWER CAP	1	PZ	VM2384A0	MM LEFT DOOR RIGHT LOWER CAP	1	PZ	VM2386A1	LEFT MM DOOR LOWER LEFT CAP	1	PZ	VM2386A1	LEFT MM DOOR LOWER LEFT CAP	1	PZ
			Code	Description	Qty	UOM																																							
VM2103A0	CLAMP LOCK	2	PZ																																										
VM2267A0	INTERNAL GLASS LOCKING SYSTEM SLIDER	1	PZ																																										
VM2269A0	INTERNAL GLASS LOCKING SYSTEM CAP	1	PZ																																										
VM2274A0	GROOVED BUSHING	1	PZ																																										
VM2305A0	6 SERIES DOOR CAP FIXING PAWL	7	PZ																																										
VM2384A0	MM LEFT DOOR RIGHT LOWER CAP	1	PZ																																										
VM2384A0	MM LEFT DOOR RIGHT LOWER CAP	1	PZ																																										
VM2386A1	LEFT MM DOOR LOWER LEFT CAP	1	PZ																																										
VM2386A1	LEFT MM DOOR LOWER LEFT CAP	1	PZ																																										
K0B1122AR	CHEFTOP MM RIGHT DOOR LOWER BEAM KIT	<table border="1"> <thead> <tr> <th>Code</th> <th>Description</th> <th>Qty</th> <th>UOM</th> </tr> </thead> <tbody> <tr> <td>0B1122A0</td> <td>750MM DOOR LOWER FRAME SHAPE</td> <td>1</td> <td>PZ</td> </tr> <tr> <td>0B1122A1</td> <td>750MM DOOR LOWER FRAME SHAPE</td> <td>1</td> <td>PZ</td> </tr> <tr> <td>RC1200A0</td> <td>ED=4 WIRE D.=0.5 COMPRESSIO N SPRING</td> <td>2</td> <td>PZ</td> </tr> <tr> <td>VI1220A1</td> <td>4,2X12 TCB SELF-TAPPIN G SCREW</td> <td>1</td> <td>PZ</td> </tr> <tr> <td>VI1996A0</td> <td>M5X35 SCREW</td> <td>7</td> <td>PZ</td> </tr> <tr> <td>VM1794A0</td> <td>250X4.8 PA66 BLACK CLAMP</td> <td>2</td> <td>PZ</td> </tr> <tr> <td>VM2103A0</td> <td>CLAMP LOCK</td> <td>2</td> <td>PZ</td> </tr> <tr> <td>VM2259A1</td> <td>6 SERIES DOOR LOWER LEFT CAP</td> <td>1</td> <td>PZ</td> </tr> <tr> <td>VM2261A1</td> <td>6 SERIES DOOR LOWER RIGHT CAP</td> <td>1</td> <td>PZ</td> </tr> </tbody> </table>	Code	Description	Qty	UOM	0B1122A0	750MM DOOR LOWER FRAME SHAPE	1	PZ	0B1122A1	750MM DOOR LOWER FRAME SHAPE	1	PZ	RC1200A0	ED=4 WIRE D.=0.5 COMPRESSIO N SPRING	2	PZ	VI1220A1	4,2X12 TCB SELF-TAPPIN G SCREW	1	PZ	VI1996A0	M5X35 SCREW	7	PZ	VM1794A0	250X4.8 PA66 BLACK CLAMP	2	PZ	VM2103A0	CLAMP LOCK	2	PZ	VM2259A1	6 SERIES DOOR LOWER LEFT CAP	1	PZ	VM2261A1	6 SERIES DOOR LOWER RIGHT CAP	1	PZ			
Code	Description	Qty	UOM																																										
0B1122A0	750MM DOOR LOWER FRAME SHAPE	1	PZ																																										
0B1122A1	750MM DOOR LOWER FRAME SHAPE	1	PZ																																										
RC1200A0	ED=4 WIRE D.=0.5 COMPRESSIO N SPRING	2	PZ																																										
VI1220A1	4,2X12 TCB SELF-TAPPIN G SCREW	1	PZ																																										
VI1996A0	M5X35 SCREW	7	PZ																																										
VM1794A0	250X4.8 PA66 BLACK CLAMP	2	PZ																																										
VM2103A0	CLAMP LOCK	2	PZ																																										
VM2259A1	6 SERIES DOOR LOWER LEFT CAP	1	PZ																																										
VM2261A1	6 SERIES DOOR LOWER RIGHT CAP	1	PZ																																										





COMPONENT			SPARE PART																																																															
Code	Description	Image	Code	Description	Components list																																																													
VM2274A	GROOVED BUSHING		K0B1122AR	CHEFTOP MM RIGHT DOOR LOWER BEAM KIT	<table border="1"> <thead> <tr> <th>Code</th> <th>Description</th> <th>Qty</th> <th>UOM</th> </tr> </thead> <tbody> <tr> <td>VM2267A0</td> <td>INTERNAL GLASS LOCKING SYSTEM SLIDER</td> <td>1</td> <td>PZ</td> </tr> <tr> <td>VM2269A0</td> <td>INTERNAL GLASS LOCKING SYSTEM CAP</td> <td>1</td> <td>PZ</td> </tr> <tr> <td>VM2274A0</td> <td>GROOVED BUSHING</td> <td>1</td> <td>PZ</td> </tr> <tr> <td>VM2305A0</td> <td>6 SERIES DOOR CAP FIXING PAWL</td> <td>7</td> <td>PZ</td> </tr> </tbody> </table>	Code	Description	Qty	UOM	VM2267A0	INTERNAL GLASS LOCKING SYSTEM SLIDER	1	PZ	VM2269A0	INTERNAL GLASS LOCKING SYSTEM CAP	1	PZ	VM2274A0	GROOVED BUSHING	1	PZ	VM2305A0	6 SERIES DOOR CAP FIXING PAWL	7	PZ																																									
			Code	Description	Qty	UOM																																																												
VM2267A0	INTERNAL GLASS LOCKING SYSTEM SLIDER	1	PZ																																																															
VM2269A0	INTERNAL GLASS LOCKING SYSTEM CAP	1	PZ																																																															
VM2274A0	GROOVED BUSHING	1	PZ																																																															
VM2305A0	6 SERIES DOOR CAP FIXING PAWL	7	PZ																																																															
K0B1122AL	CHEFTOP MM LEFT DOOR LOWER BEAM KIT	<table border="1"> <thead> <tr> <th>Code</th> <th>Description</th> <th>Qty</th> <th>UOM</th> </tr> </thead> <tbody> <tr> <td>0B1122A0</td> <td>750MM DOOR LOWER FRAME SHAPE</td> <td>1</td> <td>PZ</td> </tr> <tr> <td>0B1122A1</td> <td>750MM DOOR LOWER FRAME SHAPE</td> <td>1</td> <td>PZ</td> </tr> <tr> <td>RC1200A0</td> <td>ED=4 WIRE D.=0.5 COMPRESSION N SPRING</td> <td>2</td> <td>PZ</td> </tr> <tr> <td>V11220A1</td> <td>4,2X12 TCB SELF-TAPPING G SCREW</td> <td>1</td> <td>PZ</td> </tr> <tr> <td>V11996A0</td> <td>M5X35 SCREW</td> <td>7</td> <td>PZ</td> </tr> <tr> <td>VM1794A0</td> <td>250X4.8 PA66 BLACK CLAMP</td> <td>2</td> <td>PZ</td> </tr> <tr> <td>VM2103A0</td> <td>CLAMP LOCK</td> <td>2</td> <td>PZ</td> </tr> <tr> <td>VM2267A0</td> <td>INTERNAL GLASS LOCKING SYSTEM SLIDER</td> <td>1</td> <td>PZ</td> </tr> <tr> <td>VM2269A0</td> <td>INTERNAL GLASS LOCKING SYSTEM CAP</td> <td>1</td> <td>PZ</td> </tr> <tr> <td>VM2274A0</td> <td>GROOVED BUSHING</td> <td>1</td> <td>PZ</td> </tr> <tr> <td>VM2305A0</td> <td>6 SERIES DOOR CAP FIXING PAWL</td> <td>7</td> <td>PZ</td> </tr> <tr> <td>VM2384A0</td> <td>MM LEFT DOOR RIGHT LOWER CAP</td> <td>1</td> <td>PZ</td> </tr> <tr> <td>VM2384A0</td> <td>MM LEFT DOOR RIGHT LOWER CAP</td> <td>1</td> <td>PZ</td> </tr> <tr> <td>VM2386A1</td> <td>LEFT MM DOOR LOWER LEFT CAP</td> <td>1</td> <td>PZ</td> </tr> <tr> <td>VM2386A1</td> <td>LEFT MM DOOR LOWER LEFT CAP</td> <td>1</td> <td>PZ</td> </tr> </tbody> </table>	Code	Description	Qty	UOM	0B1122A0	750MM DOOR LOWER FRAME SHAPE	1	PZ	0B1122A1	750MM DOOR LOWER FRAME SHAPE	1	PZ	RC1200A0	ED=4 WIRE D.=0.5 COMPRESSION N SPRING	2	PZ	V11220A1	4,2X12 TCB SELF-TAPPING G SCREW	1	PZ	V11996A0	M5X35 SCREW	7	PZ	VM1794A0	250X4.8 PA66 BLACK CLAMP	2	PZ	VM2103A0	CLAMP LOCK	2	PZ	VM2267A0	INTERNAL GLASS LOCKING SYSTEM SLIDER	1	PZ	VM2269A0	INTERNAL GLASS LOCKING SYSTEM CAP	1	PZ	VM2274A0	GROOVED BUSHING	1	PZ	VM2305A0	6 SERIES DOOR CAP FIXING PAWL	7	PZ	VM2384A0	MM LEFT DOOR RIGHT LOWER CAP	1	PZ	VM2384A0	MM LEFT DOOR RIGHT LOWER CAP	1	PZ	VM2386A1	LEFT MM DOOR LOWER LEFT CAP	1	PZ	VM2386A1	LEFT MM DOOR LOWER LEFT CAP	1	PZ
Code	Description	Qty	UOM																																																															
0B1122A0	750MM DOOR LOWER FRAME SHAPE	1	PZ																																																															
0B1122A1	750MM DOOR LOWER FRAME SHAPE	1	PZ																																																															
RC1200A0	ED=4 WIRE D.=0.5 COMPRESSION N SPRING	2	PZ																																																															
V11220A1	4,2X12 TCB SELF-TAPPING G SCREW	1	PZ																																																															
V11996A0	M5X35 SCREW	7	PZ																																																															
VM1794A0	250X4.8 PA66 BLACK CLAMP	2	PZ																																																															
VM2103A0	CLAMP LOCK	2	PZ																																																															
VM2267A0	INTERNAL GLASS LOCKING SYSTEM SLIDER	1	PZ																																																															
VM2269A0	INTERNAL GLASS LOCKING SYSTEM CAP	1	PZ																																																															
VM2274A0	GROOVED BUSHING	1	PZ																																																															
VM2305A0	6 SERIES DOOR CAP FIXING PAWL	7	PZ																																																															
VM2384A0	MM LEFT DOOR RIGHT LOWER CAP	1	PZ																																																															
VM2384A0	MM LEFT DOOR RIGHT LOWER CAP	1	PZ																																																															
VM2386A1	LEFT MM DOOR LOWER LEFT CAP	1	PZ																																																															
VM2386A1	LEFT MM DOOR LOWER LEFT CAP	1	PZ																																																															

COMPONENT			SPARE PART																																																														
Code	Description	Image	Code	Description	Components list																																																												
VM2305A	6 SERIES DOOR CAP FIXING PAWL		KVM2305A	MM FIXING DOOR THUB SCREWS 10 PCS KIT	<table border="1"> <thead> <tr> <th>Code</th> <th>Description</th> <th>Qty</th> <th>UOM</th> </tr> </thead> <tbody> <tr> <td>VM1224A0</td> <td></td> <td>0.200</td> <td>M</td> </tr> <tr> <td>VM2305A0</td> <td>6 SERIES DOOR CAP FIXING PAWL</td> <td>10</td> <td>PZ</td> </tr> </tbody> </table>	Code	Description	Qty	UOM	VM1224A0		0.200	M	VM2305A0	6 SERIES DOOR CAP FIXING PAWL	10	PZ																																																
Code	Description	Qty	UOM																																																														
VM1224A0		0.200	M																																																														
VM2305A0	6 SERIES DOOR CAP FIXING PAWL	10	PZ																																																														
VI1996A	M5X35 SCREW		VI1996A0	M5X35 SCREW																																																													
VM2259A	6 SERIES DOOR LOWER LEFT CAP		<p>KVM2259A</p> <p>K0B1126AR</p>	<p>MIND MAPS DOOR LEFT LOWER CAP KI</p> <p>BAKERTOP MM RIGHT DOOR LOWER BEAM KIT</p>	<table border="1"> <thead> <tr> <th>Code</th> <th>Description</th> <th>Qty</th> <th>UOM</th> </tr> </thead> <tbody> <tr> <td>VI1996A0</td> <td>M5X35 SCREW</td> <td>3</td> <td>PZ</td> </tr> <tr> <td>VM1224A0</td> <td></td> <td>0.250</td> <td>M</td> </tr> <tr> <td>VM2259A1</td> <td>6 SERIES DOOR LOWER LEFT CAP</td> <td>1</td> <td>PZ</td> </tr> <tr> <td>VM2305A0</td> <td>6 SERIES DOOR CAP FIXING PAWL</td> <td>3</td> <td>PZ</td> </tr> </tbody> </table> <table border="1"> <thead> <tr> <th>Code</th> <th>Description</th> <th>Qty</th> <th>UOM</th> </tr> </thead> <tbody> <tr> <td>0B1126A0</td> <td>DOOR LOWER FRAME SHAPE 860 MM</td> <td>1</td> <td>PZ</td> </tr> <tr> <td>0B1126A1</td> <td></td> <td>1</td> <td>PZ</td> </tr> <tr> <td>RC1200A0</td> <td>ED=4 WIRE D.=0.5 COMPRESSIO N SPRING</td> <td>2</td> <td>PZ</td> </tr> <tr> <td>VI1220A1</td> <td>4.2X12 TCB SELF-TAPPIN G SCREW</td> <td>1</td> <td>PZ</td> </tr> <tr> <td>VI1996A0</td> <td>M5X35 SCREW</td> <td>7</td> <td>PZ</td> </tr> <tr> <td>VM1794A0</td> <td>250X4.8 PA66 BLACK CLAMP</td> <td>2</td> <td>PZ</td> </tr> <tr> <td>VM2103A0</td> <td>CLAMP LOCK</td> <td>2</td> <td>PZ</td> </tr> <tr> <td>VM2259A1</td> <td>6 SERIES DOOR LOWER LEFT CAP</td> <td>1</td> <td>PZ</td> </tr> <tr> <td>VM2261A1</td> <td>6 SERIES DOOR LOWER RIGHT CAP</td> <td>1</td> <td>PZ</td> </tr> </tbody> </table>	Code	Description	Qty	UOM	VI1996A0	M5X35 SCREW	3	PZ	VM1224A0		0.250	M	VM2259A1	6 SERIES DOOR LOWER LEFT CAP	1	PZ	VM2305A0	6 SERIES DOOR CAP FIXING PAWL	3	PZ	Code	Description	Qty	UOM	0B1126A0	DOOR LOWER FRAME SHAPE 860 MM	1	PZ	0B1126A1		1	PZ	RC1200A0	ED=4 WIRE D.=0.5 COMPRESSIO N SPRING	2	PZ	VI1220A1	4.2X12 TCB SELF-TAPPIN G SCREW	1	PZ	VI1996A0	M5X35 SCREW	7	PZ	VM1794A0	250X4.8 PA66 BLACK CLAMP	2	PZ	VM2103A0	CLAMP LOCK	2	PZ	VM2259A1	6 SERIES DOOR LOWER LEFT CAP	1	PZ	VM2261A1	6 SERIES DOOR LOWER RIGHT CAP	1	PZ
Code	Description	Qty	UOM																																																														
VI1996A0	M5X35 SCREW	3	PZ																																																														
VM1224A0		0.250	M																																																														
VM2259A1	6 SERIES DOOR LOWER LEFT CAP	1	PZ																																																														
VM2305A0	6 SERIES DOOR CAP FIXING PAWL	3	PZ																																																														
Code	Description	Qty	UOM																																																														
0B1126A0	DOOR LOWER FRAME SHAPE 860 MM	1	PZ																																																														
0B1126A1		1	PZ																																																														
RC1200A0	ED=4 WIRE D.=0.5 COMPRESSIO N SPRING	2	PZ																																																														
VI1220A1	4.2X12 TCB SELF-TAPPIN G SCREW	1	PZ																																																														
VI1996A0	M5X35 SCREW	7	PZ																																																														
VM1794A0	250X4.8 PA66 BLACK CLAMP	2	PZ																																																														
VM2103A0	CLAMP LOCK	2	PZ																																																														
VM2259A1	6 SERIES DOOR LOWER LEFT CAP	1	PZ																																																														
VM2261A1	6 SERIES DOOR LOWER RIGHT CAP	1	PZ																																																														

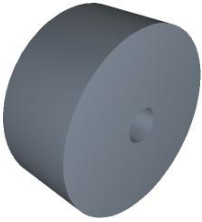

COMPONENT			SPARE PART																																																															
Code	Description	Image	Code	Description	Components list																																																													
VM2259A	6 SERIES DOOR LOWER LEFT CAP		K0B1126AR	BAKERTOP MM RIGHT DOOR LOWER BEAM KIT	<table border="1"> <thead> <tr> <th>Code</th> <th>Description</th> <th>Qty</th> <th>UOM</th> </tr> </thead> <tbody> <tr> <td>VM2267A0</td> <td>INTERNAL GLASS LOCKING SYSTEM SLIDER</td> <td>1</td> <td>PZ</td> </tr> <tr> <td>VM2269A0</td> <td>INTERNAL GLASS LOCKING SYSTEM CAP</td> <td>1</td> <td>PZ</td> </tr> <tr> <td>VM2274A0</td> <td>GROOVED BUSHING</td> <td>1</td> <td>PZ</td> </tr> <tr> <td>VM2305A0</td> <td>6 SERIES DOOR CAP FIXING PAWL</td> <td>7</td> <td>PZ</td> </tr> </tbody> </table>	Code	Description	Qty	UOM	VM2267A0	INTERNAL GLASS LOCKING SYSTEM SLIDER	1	PZ	VM2269A0	INTERNAL GLASS LOCKING SYSTEM CAP	1	PZ	VM2274A0	GROOVED BUSHING	1	PZ	VM2305A0	6 SERIES DOOR CAP FIXING PAWL	7	PZ																																									
			Code	Description	Qty	UOM																																																												
VM2267A0	INTERNAL GLASS LOCKING SYSTEM SLIDER	1	PZ																																																															
VM2269A0	INTERNAL GLASS LOCKING SYSTEM CAP	1	PZ																																																															
VM2274A0	GROOVED BUSHING	1	PZ																																																															
VM2305A0	6 SERIES DOOR CAP FIXING PAWL	7	PZ																																																															
K0B1126AL	EU AND 2/1 MM LEFT DOOR LOWER BEAM KIT	<table border="1"> <thead> <tr> <th>Code</th> <th>Description</th> <th>Qty</th> <th>UOM</th> </tr> </thead> <tbody> <tr> <td>0B1126A0</td> <td>DOOR LOWER FRAME SHAPE 860 MM</td> <td>1</td> <td>PZ</td> </tr> <tr> <td>0B1126A1</td> <td></td> <td>1</td> <td>PZ</td> </tr> <tr> <td>RC1200A0</td> <td>ED=4 WIRE D.=0.5 COMPRESSIO N SPRING</td> <td>2</td> <td>PZ</td> </tr> <tr> <td>VI1220A1</td> <td>4,2X12 TCB SELF-TAPPIN G SCREW</td> <td>1</td> <td>PZ</td> </tr> <tr> <td>VI1996A0</td> <td>M5X35 SCREW</td> <td>7</td> <td>PZ</td> </tr> <tr> <td>VM1794A0</td> <td>250X4.8 PA66 BLACK CLAMP</td> <td>2</td> <td>PZ</td> </tr> <tr> <td>VM2103A0</td> <td>CLAMP LOCK</td> <td>2</td> <td>PZ</td> </tr> <tr> <td>VM2267A0</td> <td>INTERNAL GLASS LOCKING SYSTEM SLIDER</td> <td>1</td> <td>PZ</td> </tr> <tr> <td>VM2269A0</td> <td>INTERNAL GLASS LOCKING SYSTEM CAP</td> <td>1</td> <td>PZ</td> </tr> <tr> <td>VM2274A0</td> <td>GROOVED BUSHING</td> <td>1</td> <td>PZ</td> </tr> <tr> <td>VM2305A0</td> <td>6 SERIES DOOR CAP FIXING PAWL</td> <td>7</td> <td>PZ</td> </tr> <tr> <td>VM2384A0</td> <td>MM LEFT DOOR RIGHT LOWER CAP</td> <td>1</td> <td>PZ</td> </tr> <tr> <td>VM2384A0</td> <td>MM LEFT DOOR RIGHT LOWER CAP</td> <td>1</td> <td>PZ</td> </tr> <tr> <td>VM2386A1</td> <td>LEFT MM DOOR LOWER LEFT CAP</td> <td>1</td> <td>PZ</td> </tr> <tr> <td>VM2386A1</td> <td>LEFT MM DOOR LOWER LEFT CAP</td> <td>1</td> <td>PZ</td> </tr> </tbody> </table>	Code	Description	Qty	UOM	0B1126A0	DOOR LOWER FRAME SHAPE 860 MM	1	PZ	0B1126A1		1	PZ	RC1200A0	ED=4 WIRE D.=0.5 COMPRESSIO N SPRING	2	PZ	VI1220A1	4,2X12 TCB SELF-TAPPIN G SCREW	1	PZ	VI1996A0	M5X35 SCREW	7	PZ	VM1794A0	250X4.8 PA66 BLACK CLAMP	2	PZ	VM2103A0	CLAMP LOCK	2	PZ	VM2267A0	INTERNAL GLASS LOCKING SYSTEM SLIDER	1	PZ	VM2269A0	INTERNAL GLASS LOCKING SYSTEM CAP	1	PZ	VM2274A0	GROOVED BUSHING	1	PZ	VM2305A0	6 SERIES DOOR CAP FIXING PAWL	7	PZ	VM2384A0	MM LEFT DOOR RIGHT LOWER CAP	1	PZ	VM2384A0	MM LEFT DOOR RIGHT LOWER CAP	1	PZ	VM2386A1	LEFT MM DOOR LOWER LEFT CAP	1	PZ	VM2386A1	LEFT MM DOOR LOWER LEFT CAP	1	PZ
Code	Description	Qty	UOM																																																															
0B1126A0	DOOR LOWER FRAME SHAPE 860 MM	1	PZ																																																															
0B1126A1		1	PZ																																																															
RC1200A0	ED=4 WIRE D.=0.5 COMPRESSIO N SPRING	2	PZ																																																															
VI1220A1	4,2X12 TCB SELF-TAPPIN G SCREW	1	PZ																																																															
VI1996A0	M5X35 SCREW	7	PZ																																																															
VM1794A0	250X4.8 PA66 BLACK CLAMP	2	PZ																																																															
VM2103A0	CLAMP LOCK	2	PZ																																																															
VM2267A0	INTERNAL GLASS LOCKING SYSTEM SLIDER	1	PZ																																																															
VM2269A0	INTERNAL GLASS LOCKING SYSTEM CAP	1	PZ																																																															
VM2274A0	GROOVED BUSHING	1	PZ																																																															
VM2305A0	6 SERIES DOOR CAP FIXING PAWL	7	PZ																																																															
VM2384A0	MM LEFT DOOR RIGHT LOWER CAP	1	PZ																																																															
VM2384A0	MM LEFT DOOR RIGHT LOWER CAP	1	PZ																																																															
VM2386A1	LEFT MM DOOR LOWER LEFT CAP	1	PZ																																																															
VM2386A1	LEFT MM DOOR LOWER LEFT CAP	1	PZ																																																															

COMPONENT			SPARE PART																																																																																									
Code	Description	Image	Code	Description	Components list																																																																																							
VM2259A	6 SERIES DOOR LOWER LEFT CAP		K0B1122AR	CHEFTOP MM RIGHT DOOR LOWER BEAM KIT	<table border="1"> <thead> <tr> <th>Code</th> <th>Description</th> <th>Qty</th> <th>UOM</th> </tr> </thead> <tbody> <tr> <td>0B1122A0</td> <td>750MM DOOR LOWER FRAME SHAPE</td> <td>1</td> <td>PZ</td> </tr> <tr> <td>0B1122A1</td> <td>750MM DOOR LOWER FRAME SHAPE</td> <td>1</td> <td>PZ</td> </tr> <tr> <td>RC1200A0</td> <td>ED=4 WIRE D.=0.5 COMPRESSIO N SPRING</td> <td>2</td> <td>PZ</td> </tr> <tr> <td>VI1220A1</td> <td>4,2X12 TCB SELF-TAPPIN G SCREW</td> <td>1</td> <td>PZ</td> </tr> <tr> <td>VI1996A0</td> <td>M5X35 SCREW</td> <td>7</td> <td>PZ</td> </tr> <tr> <td>VM1794A0</td> <td>250X4.8 PA66 BLACK CLAMP</td> <td>2</td> <td>PZ</td> </tr> <tr> <td>VM2103A0</td> <td>CLAMP LOCK</td> <td>2</td> <td>PZ</td> </tr> <tr> <td>VM2259A1</td> <td>6 SERIES DOOR LOWER LEFT CAP</td> <td>1</td> <td>PZ</td> </tr> <tr> <td>VM2261A1</td> <td>6 SERIES DOOR LOWER RIGHT CAP</td> <td>1</td> <td>PZ</td> </tr> <tr> <td>VM2267A0</td> <td>INTERNAL GLASS LOCKING SYSTEM SLIDER</td> <td>1</td> <td>PZ</td> </tr> <tr> <td>VM2269A0</td> <td>INTERNAL GLASS LOCKING SYSTEM CAP</td> <td>1</td> <td>PZ</td> </tr> <tr> <td>VM2274A0</td> <td>GROOVED BUSHING</td> <td>1</td> <td>PZ</td> </tr> <tr> <td>VM2305A0</td> <td>6 SERIES DOOR CAP FIXING PAWL</td> <td>7</td> <td>PZ</td> </tr> </tbody> </table>	Code	Description	Qty	UOM	0B1122A0	750MM DOOR LOWER FRAME SHAPE	1	PZ	0B1122A1	750MM DOOR LOWER FRAME SHAPE	1	PZ	RC1200A0	ED=4 WIRE D.=0.5 COMPRESSIO N SPRING	2	PZ	VI1220A1	4,2X12 TCB SELF-TAPPIN G SCREW	1	PZ	VI1996A0	M5X35 SCREW	7	PZ	VM1794A0	250X4.8 PA66 BLACK CLAMP	2	PZ	VM2103A0	CLAMP LOCK	2	PZ	VM2259A1	6 SERIES DOOR LOWER LEFT CAP	1	PZ	VM2261A1	6 SERIES DOOR LOWER RIGHT CAP	1	PZ	VM2267A0	INTERNAL GLASS LOCKING SYSTEM SLIDER	1	PZ	VM2269A0	INTERNAL GLASS LOCKING SYSTEM CAP	1	PZ	VM2274A0	GROOVED BUSHING	1	PZ	VM2305A0	6 SERIES DOOR CAP FIXING PAWL	7	PZ	K0B1122AL	CHEFTOP MM LEFT DOOR LOWER BEAM KIT	<table border="1"> <thead> <tr> <th>Code</th> <th>Description</th> <th>Qty</th> <th>UOM</th> </tr> </thead> <tbody> <tr> <td>0B1122A0</td> <td>750MM DOOR LOWER FRAME SHAPE</td> <td>1</td> <td>PZ</td> </tr> <tr> <td>0B1122A1</td> <td>750MM DOOR LOWER FRAME SHAPE</td> <td>1</td> <td>PZ</td> </tr> <tr> <td>RC1200A0</td> <td>ED=4 WIRE D.=0.5 COMPRESSIO N SPRING</td> <td>2</td> <td>PZ</td> </tr> <tr> <td>VI1220A1</td> <td>4,2X12 TCB SELF-TAPPIN G SCREW</td> <td>1</td> <td>PZ</td> </tr> <tr> <td>VI1996A0</td> <td>M5X35 SCREW</td> <td>7</td> <td>PZ</td> </tr> <tr> <td>VM1794A0</td> <td>250X4.8 PA66 BLACK CLAMP</td> <td>2</td> <td>PZ</td> </tr> </tbody> </table>	Code	Description	Qty	UOM	0B1122A0	750MM DOOR LOWER FRAME SHAPE	1	PZ	0B1122A1	750MM DOOR LOWER FRAME SHAPE	1	PZ	RC1200A0	ED=4 WIRE D.=0.5 COMPRESSIO N SPRING	2	PZ	VI1220A1	4,2X12 TCB SELF-TAPPIN G SCREW	1	PZ	VI1996A0	M5X35 SCREW	7	PZ	VM1794A0	250X4.8 PA66 BLACK CLAMP	2	PZ
			Code	Description	Qty	UOM																																																																																						
0B1122A0	750MM DOOR LOWER FRAME SHAPE	1	PZ																																																																																									
0B1122A1	750MM DOOR LOWER FRAME SHAPE	1	PZ																																																																																									
RC1200A0	ED=4 WIRE D.=0.5 COMPRESSIO N SPRING	2	PZ																																																																																									
VI1220A1	4,2X12 TCB SELF-TAPPIN G SCREW	1	PZ																																																																																									
VI1996A0	M5X35 SCREW	7	PZ																																																																																									
VM1794A0	250X4.8 PA66 BLACK CLAMP	2	PZ																																																																																									
VM2103A0	CLAMP LOCK	2	PZ																																																																																									
VM2259A1	6 SERIES DOOR LOWER LEFT CAP	1	PZ																																																																																									
VM2261A1	6 SERIES DOOR LOWER RIGHT CAP	1	PZ																																																																																									
VM2267A0	INTERNAL GLASS LOCKING SYSTEM SLIDER	1	PZ																																																																																									
VM2269A0	INTERNAL GLASS LOCKING SYSTEM CAP	1	PZ																																																																																									
VM2274A0	GROOVED BUSHING	1	PZ																																																																																									
VM2305A0	6 SERIES DOOR CAP FIXING PAWL	7	PZ																																																																																									
Code	Description	Qty	UOM																																																																																									
0B1122A0	750MM DOOR LOWER FRAME SHAPE	1	PZ																																																																																									
0B1122A1	750MM DOOR LOWER FRAME SHAPE	1	PZ																																																																																									
RC1200A0	ED=4 WIRE D.=0.5 COMPRESSIO N SPRING	2	PZ																																																																																									
VI1220A1	4,2X12 TCB SELF-TAPPIN G SCREW	1	PZ																																																																																									
VI1996A0	M5X35 SCREW	7	PZ																																																																																									
VM1794A0	250X4.8 PA66 BLACK CLAMP	2	PZ																																																																																									

COMPONENT			SPARE PART																																										
Code	Description	Image	Code	Description	Components list																																								
VM2259A	6 SERIES DOOR LOWER LEFT CAP		K0B1122AL	CHEFTOP MM LEFT DOOR LOWER BEAM KIT	<table border="1"> <thead> <tr> <th>Code</th> <th>Description</th> <th>Qty</th> <th>UOM</th> </tr> </thead> <tbody> <tr> <td>VM2103A0</td> <td>CLAMP LOCK</td> <td>2</td> <td>PZ</td> </tr> <tr> <td>VM2267A0</td> <td>INTERNAL GLASS LOCKING SYSTEM SLIDER</td> <td>1</td> <td>PZ</td> </tr> <tr> <td>VM2269A0</td> <td>INTERNAL GLASS LOCKING SYSTEM CAP</td> <td>1</td> <td>PZ</td> </tr> <tr> <td>VM2274A0</td> <td>GROOVED BUSHING</td> <td>1</td> <td>PZ</td> </tr> <tr> <td>VM2305A0</td> <td>6 SERIES DOOR CAP FIXING PAWL</td> <td>7</td> <td>PZ</td> </tr> <tr> <td>VM2384A0</td> <td>MM LEFT DOOR RIGHT LOWER CAP</td> <td>1</td> <td>PZ</td> </tr> <tr> <td>VM2384A0</td> <td>MM LEFT DOOR RIGHT LOWER CAP</td> <td>1</td> <td>PZ</td> </tr> <tr> <td>VM2386A1</td> <td>LEFT MM DOOR LOWER LEFT CAP</td> <td>1</td> <td>PZ</td> </tr> <tr> <td>VM2386A1</td> <td>LEFT MM DOOR LOWER LEFT CAP</td> <td>1</td> <td>PZ</td> </tr> </tbody> </table>	Code	Description	Qty	UOM	VM2103A0	CLAMP LOCK	2	PZ	VM2267A0	INTERNAL GLASS LOCKING SYSTEM SLIDER	1	PZ	VM2269A0	INTERNAL GLASS LOCKING SYSTEM CAP	1	PZ	VM2274A0	GROOVED BUSHING	1	PZ	VM2305A0	6 SERIES DOOR CAP FIXING PAWL	7	PZ	VM2384A0	MM LEFT DOOR RIGHT LOWER CAP	1	PZ	VM2384A0	MM LEFT DOOR RIGHT LOWER CAP	1	PZ	VM2386A1	LEFT MM DOOR LOWER LEFT CAP	1	PZ	VM2386A1	LEFT MM DOOR LOWER LEFT CAP	1	PZ
					Code	Description	Qty	UOM																																					
					VM2103A0	CLAMP LOCK	2	PZ																																					
					VM2267A0	INTERNAL GLASS LOCKING SYSTEM SLIDER	1	PZ																																					
					VM2269A0	INTERNAL GLASS LOCKING SYSTEM CAP	1	PZ																																					
					VM2274A0	GROOVED BUSHING	1	PZ																																					
					VM2305A0	6 SERIES DOOR CAP FIXING PAWL	7	PZ																																					
					VM2384A0	MM LEFT DOOR RIGHT LOWER CAP	1	PZ																																					
					VM2384A0	MM LEFT DOOR RIGHT LOWER CAP	1	PZ																																					
					VM2386A1	LEFT MM DOOR LOWER LEFT CAP	1	PZ																																					
VM2386A1	LEFT MM DOOR LOWER LEFT CAP	1	PZ																																										
VM2305A	6 SERIES DOOR CAP FIXING PAWL		KVM2305A	MM FIXING DOOR THUB SCREWS 10 PCS KIT	<table border="1"> <thead> <tr> <th>Code</th> <th>Description</th> <th>Qty</th> <th>UOM</th> </tr> </thead> <tbody> <tr> <td>VM1224A0</td> <td></td> <td>0.200</td> <td>M</td> </tr> <tr> <td>VM2305A0</td> <td>6 SERIES DOOR CAP FIXING PAWL</td> <td>10</td> <td>PZ</td> </tr> </tbody> </table>	Code	Description	Qty	UOM	VM1224A0		0.200	M	VM2305A0	6 SERIES DOOR CAP FIXING PAWL	10	PZ																												
					Code	Description	Qty	UOM																																					
VM1224A0		0.200	M																																										
VM2305A0	6 SERIES DOOR CAP FIXING PAWL	10	PZ																																										
VM2269A	INTERNAL GLASS LOCKING SYSTEM CAP		KVM2269A	INNER GLASS FIXING CAP KIT	<table border="1"> <thead> <tr> <th>Code</th> <th>Description</th> <th>Qty</th> <th>UOM</th> </tr> </thead> <tbody> <tr> <td>VM1224A0</td> <td></td> <td>0.200</td> <td>M</td> </tr> <tr> <td>VM2269A0</td> <td>INTERNAL GLASS LOCKING SYSTEM CAP</td> <td>2</td> <td>PZ</td> </tr> </tbody> </table>	Code	Description	Qty	UOM	VM1224A0		0.200	M	VM2269A0	INTERNAL GLASS LOCKING SYSTEM CAP	2	PZ																												
Code	Description	Qty	UOM																																										
VM1224A0		0.200	M																																										
VM2269A0	INTERNAL GLASS LOCKING SYSTEM CAP	2	PZ																																										

COMPONENT			SPARE PART														
Code	Description	Image	Code	Description	Components list												
VE1030A	MAGNET FOR DOOR MICROSWITCH D=22,9MM		KVE1030A	2 PCS MAGNET KIT FOR DOOR SWITCH	<table border="1"> <thead> <tr> <th>Code</th> <th>Description</th> <th>Qty</th> <th>UOM</th> </tr> </thead> <tbody> <tr> <td>VE1030A1</td> <td>MAGNET FOR DOOR MICROSWITCH D=22,9MM</td> <td>2</td> <td>PZ</td> </tr> <tr> <td>VM1224A0</td> <td></td> <td>0.150</td> <td>M</td> </tr> </tbody> </table>	Code	Description	Qty	UOM	VE1030A1	MAGNET FOR DOOR MICROSWITCH D=22,9MM	2	PZ	VM1224A0		0.150	M
					Code	Description	Qty	UOM									
VE1030A1	MAGNET FOR DOOR MICROSWITCH D=22,9MM	2	PZ														
VM1224A0		0.150	M														
<table border="1"> <thead> <tr> <th>Code</th> <th>Description</th> <th>Qty</th> <th>UOM</th> </tr> </thead> <tbody> <tr> <td>VE1020A2</td> <td>MAGNETIC DOOR MICROSWITCH</td> <td>1</td> <td>PZ</td> </tr> <tr> <td>VE1030A1</td> <td>MAGNET FOR DOOR MICROSWITCH H D=22,9MM</td> <td>4</td> <td>PZ</td> </tr> <tr> <td>VM1224A0</td> <td></td> <td>0.250</td> <td>M</td> </tr> </tbody> </table>	Code	Description	Qty	UOM	VE1020A2	MAGNETIC DOOR MICROSWITCH	1	PZ	VE1030A1	MAGNET FOR DOOR MICROSWITCH H D=22,9MM	4	PZ	VM1224A0		0.250	M	
Code	Description	Qty	UOM														
VE1020A2	MAGNETIC DOOR MICROSWITCH	1	PZ														
VE1030A1	MAGNET FOR DOOR MICROSWITCH H D=22,9MM	4	PZ														
VM1224A0		0.250	M														
VM2268A	DOOR MAGNET COVER		KVM2268A	DOOR MAGNET COVER KIT	<table border="1"> <thead> <tr> <th>Code</th> <th>Description</th> <th>Qty</th> <th>UOM</th> </tr> </thead> <tbody> <tr> <td>VM1224A0</td> <td></td> <td>0.200</td> <td>M</td> </tr> <tr> <td>VM2268A0</td> <td>DOOR MAGNET COVER</td> <td>1</td> <td>PZ</td> </tr> </tbody> </table>	Code	Description	Qty	UOM	VM1224A0		0.200	M	VM2268A0	DOOR MAGNET COVER	1	PZ
Code	Description	Qty	UOM														
VM1224A0		0.200	M														
VM2268A0	DOOR MAGNET COVER	1	PZ														
VI1996A	M5X35 SCREW		VI1996A0	M5X35 SCREW													
VM2262A	6 SERIES DOOR UPPER RIGHT CAP		KVM2262A	MIND.MAPS DOOR RIGHT UPPER CAP KIT	<table border="1"> <thead> <tr> <th>Code</th> <th>Description</th> <th>Qty</th> <th>UOM</th> </tr> </thead> <tbody> <tr> <td>VM1224A0</td> <td></td> <td>0.250</td> <td>M</td> </tr> <tr> <td>VM2262A1</td> <td>6 SERIES DOOR UPPER RIGHT CAP</td> <td>1</td> <td>PZ</td> </tr> </tbody> </table>	Code	Description	Qty	UOM	VM1224A0		0.250	M	VM2262A1	6 SERIES DOOR UPPER RIGHT CAP	1	PZ
Code	Description	Qty	UOM														
VM1224A0		0.250	M														
VM2262A1	6 SERIES DOOR UPPER RIGHT CAP	1	PZ														



COMPONENT			SPARE PART																		
Code	Description	Image	Code	Description	Components list																
VM2267A	INTERNAL GLASS LOCKING SYSTEM SLIDER		VM2267A0	INTERNAL GLASS LOCKING SYSTEM SLIDER																	
VM2305A	6 SERIES DOOR CAP FIXING PAWL		KVM2305A	MM FIXING DOOR THUB SCREWS 10 PCS KIT	<table border="1"> <thead> <tr> <th>Code</th> <th>Description</th> <th>Qty</th> <th>UOM</th> </tr> </thead> <tbody> <tr> <td>VM1224A0</td> <td></td> <td>0.200</td> <td>M</td> </tr> <tr> <td>VM2305A0</td> <td>6 SERIES DOOR CAP FIXING PAWL</td> <td>10</td> <td>PZ</td> </tr> </tbody> </table>	Code	Description	Qty	UOM	VM1224A0		0.200	M	VM2305A0	6 SERIES DOOR CAP FIXING PAWL	10	PZ				
Code	Description	Qty	UOM																		
VM1224A0		0.200	M																		
VM2305A0	6 SERIES DOOR CAP FIXING PAWL	10	PZ																		
VM2269A	INTERNAL GLASS LOCKING SYSTEM CAP		KVM2269A	INNER GLASS FIXING CAP KIT	<table border="1"> <thead> <tr> <th>Code</th> <th>Description</th> <th>Qty</th> <th>UOM</th> </tr> </thead> <tbody> <tr> <td>VM1224A0</td> <td></td> <td>0.200</td> <td>M</td> </tr> <tr> <td>VM2269A0</td> <td>INTERNAL GLASS LOCKING SYSTEM CAP</td> <td>2</td> <td>PZ</td> </tr> </tbody> </table>	Code	Description	Qty	UOM	VM1224A0		0.200	M	VM2269A0	INTERNAL GLASS LOCKING SYSTEM CAP	2	PZ				
Code	Description	Qty	UOM																		
VM1224A0		0.200	M																		
VM2269A0	INTERNAL GLASS LOCKING SYSTEM CAP	2	PZ																		
VE1030A	MAGNET FOR DOOR MICROSWITCH D=22,9MM		KVE1030A	2 PCS MAGNET KIT FOR DOOR SWITCH	<table border="1"> <thead> <tr> <th>Code</th> <th>Description</th> <th>Qty</th> <th>UOM</th> </tr> </thead> <tbody> <tr> <td>VE1030A1</td> <td>MAGNET FOR DOOR MICROSWITCH H D=22,9MM</td> <td>2</td> <td>PZ</td> </tr> <tr> <td>VM1224A0</td> <td></td> <td>0.150</td> <td>M</td> </tr> </tbody> </table>	Code	Description	Qty	UOM	VE1030A1	MAGNET FOR DOOR MICROSWITCH H D=22,9MM	2	PZ	VM1224A0		0.150	M				
Code	Description	Qty	UOM																		
VE1030A1	MAGNET FOR DOOR MICROSWITCH H D=22,9MM	2	PZ																		
VM1224A0		0.150	M																		
			KVE1020A	MICROSWITCH KIT	<table border="1"> <thead> <tr> <th>Code</th> <th>Description</th> <th>Qty</th> <th>UOM</th> </tr> </thead> <tbody> <tr> <td>VE1020A2</td> <td>MAGNETIC DOOR MICROSWITCH</td> <td>1</td> <td>PZ</td> </tr> <tr> <td>VE1030A1</td> <td>MAGNET FOR DOOR MICROSWITCH H D=22,9MM</td> <td>4</td> <td>PZ</td> </tr> <tr> <td>VM1224A0</td> <td></td> <td>0.250</td> <td>M</td> </tr> </tbody> </table>	Code	Description	Qty	UOM	VE1020A2	MAGNETIC DOOR MICROSWITCH	1	PZ	VE1030A1	MAGNET FOR DOOR MICROSWITCH H D=22,9MM	4	PZ	VM1224A0		0.250	M
Code	Description	Qty	UOM																		
VE1020A2	MAGNETIC DOOR MICROSWITCH	1	PZ																		
VE1030A1	MAGNET FOR DOOR MICROSWITCH H D=22,9MM	4	PZ																		
VM1224A0		0.250	M																		

COMPONENT			SPARE PART																																																														
Code	Description	Image	Code	Description	Components list																																																												
VM2268A	DOOR MAGNET COVER		KVM2268A	DOOR MAGNET COVER KIT	<table border="1"> <thead> <tr> <th>Code</th> <th>Description</th> <th>Qty</th> <th>UOM</th> </tr> </thead> <tbody> <tr> <td>VM1224A0</td> <td></td> <td>0.200</td> <td>M</td> </tr> <tr> <td>VM2268A0</td> <td>DOOR MAGNET COVER</td> <td>1</td> <td>PZ</td> </tr> </tbody> </table>	Code	Description	Qty	UOM	VM1224A0		0.200	M	VM2268A0	DOOR MAGNET COVER	1	PZ																																																
Code	Description	Qty	UOM																																																														
VM1224A0		0.200	M																																																														
VM2268A0	DOOR MAGNET COVER	1	PZ																																																														
VI1996A	M5X35 SCREW		VI1996A0	M5X35 SCREW																																																													
VM2261A	6 SERIES DOOR LOWER RIGHT CAP		KVM2261A K0B1126AR	MIND.MAPS DOOR RIGHT LOWER CAP KIT BAKERTOP MM RIGHT DOOR LOWER BEAM KIT	<table border="1"> <thead> <tr> <th>Code</th> <th>Description</th> <th>Qty</th> <th>UOM</th> </tr> </thead> <tbody> <tr> <td>VI1996A0</td> <td>M5X35 SCREW</td> <td>3</td> <td>PZ</td> </tr> <tr> <td>VM1224A0</td> <td></td> <td>0.250</td> <td>M</td> </tr> <tr> <td>VM2261A1</td> <td>6 SERIES DOOR LOWER RIGHT CAP</td> <td>1</td> <td>PZ</td> </tr> <tr> <td>VM2305A0</td> <td>6 SERIES DOOR CAP FIXING PAWL</td> <td>3</td> <td>PZ</td> </tr> </tbody> </table> <table border="1"> <thead> <tr> <th>Code</th> <th>Description</th> <th>Qty</th> <th>UOM</th> </tr> </thead> <tbody> <tr> <td>0B1126A0</td> <td>DOOR LOWER FRAME SHAPE 860 MM</td> <td>1</td> <td>PZ</td> </tr> <tr> <td>0B1126A1</td> <td></td> <td>1</td> <td>PZ</td> </tr> <tr> <td>RC1200A0</td> <td>ED=4 WIRE D.=0.5 COMPRESSIO N SPRING</td> <td>2</td> <td>PZ</td> </tr> <tr> <td>VI1220A1</td> <td>4.2X12 TCB SELF-TAPPIN G SCREW</td> <td>1</td> <td>PZ</td> </tr> <tr> <td>VI1996A0</td> <td>M5X35 SCREW</td> <td>7</td> <td>PZ</td> </tr> <tr> <td>VM1794A0</td> <td>250X4.8 PA66 BLACK CLAMP</td> <td>2</td> <td>PZ</td> </tr> <tr> <td>VM2103A0</td> <td>CLAMP LOCK</td> <td>2</td> <td>PZ</td> </tr> <tr> <td>VM2259A1</td> <td>6 SERIES DOOR LOWER LEFT CAP</td> <td>1</td> <td>PZ</td> </tr> <tr> <td>VM2261A1</td> <td>6 SERIES DOOR LOWER RIGHT CAP</td> <td>1</td> <td>PZ</td> </tr> </tbody> </table>	Code	Description	Qty	UOM	VI1996A0	M5X35 SCREW	3	PZ	VM1224A0		0.250	M	VM2261A1	6 SERIES DOOR LOWER RIGHT CAP	1	PZ	VM2305A0	6 SERIES DOOR CAP FIXING PAWL	3	PZ	Code	Description	Qty	UOM	0B1126A0	DOOR LOWER FRAME SHAPE 860 MM	1	PZ	0B1126A1		1	PZ	RC1200A0	ED=4 WIRE D.=0.5 COMPRESSIO N SPRING	2	PZ	VI1220A1	4.2X12 TCB SELF-TAPPIN G SCREW	1	PZ	VI1996A0	M5X35 SCREW	7	PZ	VM1794A0	250X4.8 PA66 BLACK CLAMP	2	PZ	VM2103A0	CLAMP LOCK	2	PZ	VM2259A1	6 SERIES DOOR LOWER LEFT CAP	1	PZ	VM2261A1	6 SERIES DOOR LOWER RIGHT CAP	1	PZ
Code	Description	Qty	UOM																																																														
VI1996A0	M5X35 SCREW	3	PZ																																																														
VM1224A0		0.250	M																																																														
VM2261A1	6 SERIES DOOR LOWER RIGHT CAP	1	PZ																																																														
VM2305A0	6 SERIES DOOR CAP FIXING PAWL	3	PZ																																																														
Code	Description	Qty	UOM																																																														
0B1126A0	DOOR LOWER FRAME SHAPE 860 MM	1	PZ																																																														
0B1126A1		1	PZ																																																														
RC1200A0	ED=4 WIRE D.=0.5 COMPRESSIO N SPRING	2	PZ																																																														
VI1220A1	4.2X12 TCB SELF-TAPPIN G SCREW	1	PZ																																																														
VI1996A0	M5X35 SCREW	7	PZ																																																														
VM1794A0	250X4.8 PA66 BLACK CLAMP	2	PZ																																																														
VM2103A0	CLAMP LOCK	2	PZ																																																														
VM2259A1	6 SERIES DOOR LOWER LEFT CAP	1	PZ																																																														
VM2261A1	6 SERIES DOOR LOWER RIGHT CAP	1	PZ																																																														



COMPONENT			SPARE PART																																																															
Code	Description	Image	Code	Description	Components list																																																													
VM2261A	6 SERIES DOOR LOWER RIGHT CAP		K0B1126AR	BAKERTOP MM RIGHT DOOR LOWER BEAM KIT	<table border="1"> <thead> <tr> <th>Code</th> <th>Description</th> <th>Qty</th> <th>UOM</th> </tr> </thead> <tbody> <tr> <td>VM2267A0</td> <td>INTERNAL GLASS LOCKING SYSTEM SLIDER</td> <td>1</td> <td>PZ</td> </tr> <tr> <td>VM2269A0</td> <td>INTERNAL GLASS LOCKING SYSTEM CAP</td> <td>1</td> <td>PZ</td> </tr> <tr> <td>VM2274A0</td> <td>GROOVED BUSHING</td> <td>1</td> <td>PZ</td> </tr> <tr> <td>VM2305A0</td> <td>6 SERIES DOOR CAP FIXING PAWL</td> <td>7</td> <td>PZ</td> </tr> </tbody> </table>	Code	Description	Qty	UOM	VM2267A0	INTERNAL GLASS LOCKING SYSTEM SLIDER	1	PZ	VM2269A0	INTERNAL GLASS LOCKING SYSTEM CAP	1	PZ	VM2274A0	GROOVED BUSHING	1	PZ	VM2305A0	6 SERIES DOOR CAP FIXING PAWL	7	PZ																																									
			Code	Description	Qty	UOM																																																												
VM2267A0	INTERNAL GLASS LOCKING SYSTEM SLIDER	1	PZ																																																															
VM2269A0	INTERNAL GLASS LOCKING SYSTEM CAP	1	PZ																																																															
VM2274A0	GROOVED BUSHING	1	PZ																																																															
VM2305A0	6 SERIES DOOR CAP FIXING PAWL	7	PZ																																																															
K0B1126AL	EU AND 2/1 MM LEFT DOOR LOWER BEAM KIT	<table border="1"> <thead> <tr> <th>Code</th> <th>Description</th> <th>Qty</th> <th>UOM</th> </tr> </thead> <tbody> <tr> <td>0B1126A0</td> <td>DOOR LOWER FRAME SHAPE 860 MM</td> <td>1</td> <td>PZ</td> </tr> <tr> <td>0B1126A1</td> <td></td> <td>1</td> <td>PZ</td> </tr> <tr> <td>RC1200A0</td> <td>ED=4 WIRE D.=0.5 COMPRESSIO N SPRING</td> <td>2</td> <td>PZ</td> </tr> <tr> <td>VI1220A1</td> <td>4,2X12 TCB SELF-TAPPIN G SCREW</td> <td>1</td> <td>PZ</td> </tr> <tr> <td>VI1996A0</td> <td>M5X35 SCREW</td> <td>7</td> <td>PZ</td> </tr> <tr> <td>VM1794A0</td> <td>250X4.8 PA66 BLACK CLAMP</td> <td>2</td> <td>PZ</td> </tr> <tr> <td>VM2103A0</td> <td>CLAMP LOCK</td> <td>2</td> <td>PZ</td> </tr> <tr> <td>VM2267A0</td> <td>INTERNAL GLASS LOCKING SYSTEM SLIDER</td> <td>1</td> <td>PZ</td> </tr> <tr> <td>VM2269A0</td> <td>INTERNAL GLASS LOCKING SYSTEM CAP</td> <td>1</td> <td>PZ</td> </tr> <tr> <td>VM2274A0</td> <td>GROOVED BUSHING</td> <td>1</td> <td>PZ</td> </tr> <tr> <td>VM2305A0</td> <td>6 SERIES DOOR CAP FIXING PAWL</td> <td>7</td> <td>PZ</td> </tr> <tr> <td>VM2384A0</td> <td>MM LEFT DOOR RIGHT LOWER CAP</td> <td>1</td> <td>PZ</td> </tr> <tr> <td>VM2384A0</td> <td>MM LEFT DOOR RIGHT LOWER CAP</td> <td>1</td> <td>PZ</td> </tr> <tr> <td>VM2386A1</td> <td>LEFT MM DOOR LOWER LEFT CAP</td> <td>1</td> <td>PZ</td> </tr> <tr> <td>VM2386A1</td> <td>LEFT MM DOOR LOWER LEFT CAP</td> <td>1</td> <td>PZ</td> </tr> </tbody> </table>	Code	Description	Qty	UOM	0B1126A0	DOOR LOWER FRAME SHAPE 860 MM	1	PZ	0B1126A1		1	PZ	RC1200A0	ED=4 WIRE D.=0.5 COMPRESSIO N SPRING	2	PZ	VI1220A1	4,2X12 TCB SELF-TAPPIN G SCREW	1	PZ	VI1996A0	M5X35 SCREW	7	PZ	VM1794A0	250X4.8 PA66 BLACK CLAMP	2	PZ	VM2103A0	CLAMP LOCK	2	PZ	VM2267A0	INTERNAL GLASS LOCKING SYSTEM SLIDER	1	PZ	VM2269A0	INTERNAL GLASS LOCKING SYSTEM CAP	1	PZ	VM2274A0	GROOVED BUSHING	1	PZ	VM2305A0	6 SERIES DOOR CAP FIXING PAWL	7	PZ	VM2384A0	MM LEFT DOOR RIGHT LOWER CAP	1	PZ	VM2384A0	MM LEFT DOOR RIGHT LOWER CAP	1	PZ	VM2386A1	LEFT MM DOOR LOWER LEFT CAP	1	PZ	VM2386A1	LEFT MM DOOR LOWER LEFT CAP	1	PZ
Code	Description	Qty	UOM																																																															
0B1126A0	DOOR LOWER FRAME SHAPE 860 MM	1	PZ																																																															
0B1126A1		1	PZ																																																															
RC1200A0	ED=4 WIRE D.=0.5 COMPRESSIO N SPRING	2	PZ																																																															
VI1220A1	4,2X12 TCB SELF-TAPPIN G SCREW	1	PZ																																																															
VI1996A0	M5X35 SCREW	7	PZ																																																															
VM1794A0	250X4.8 PA66 BLACK CLAMP	2	PZ																																																															
VM2103A0	CLAMP LOCK	2	PZ																																																															
VM2267A0	INTERNAL GLASS LOCKING SYSTEM SLIDER	1	PZ																																																															
VM2269A0	INTERNAL GLASS LOCKING SYSTEM CAP	1	PZ																																																															
VM2274A0	GROOVED BUSHING	1	PZ																																																															
VM2305A0	6 SERIES DOOR CAP FIXING PAWL	7	PZ																																																															
VM2384A0	MM LEFT DOOR RIGHT LOWER CAP	1	PZ																																																															
VM2384A0	MM LEFT DOOR RIGHT LOWER CAP	1	PZ																																																															
VM2386A1	LEFT MM DOOR LOWER LEFT CAP	1	PZ																																																															
VM2386A1	LEFT MM DOOR LOWER LEFT CAP	1	PZ																																																															

COMPONENT			SPARE PART																																																																																									
Code	Description	Image	Code	Description	Components list																																																																																							
VM2261A	6 SERIES DOOR LOWER RIGHT CAP		K0B1122AR	CHEFTOP MM RIGHT DOOR LOWER BEAM KIT	<table border="1"> <thead> <tr> <th>Code</th> <th>Description</th> <th>Qty</th> <th>UOM</th> </tr> </thead> <tbody> <tr> <td>0B1122A0</td> <td>750MM DOOR LOWER FRAME SHAPE</td> <td>1</td> <td>PZ</td> </tr> <tr> <td>0B1122A1</td> <td>750MM DOOR LOWER FRAME SHAPE</td> <td>1</td> <td>PZ</td> </tr> <tr> <td>RC1200A0</td> <td>ED=4 WIRE D.=0.5 COMPRESSIO N SPRING</td> <td>2</td> <td>PZ</td> </tr> <tr> <td>VI1220A1</td> <td>4,2X12 TCB SELF-TAPPIN G SCREW</td> <td>1</td> <td>PZ</td> </tr> <tr> <td>VI1996A0</td> <td>M5X35 SCREW</td> <td>7</td> <td>PZ</td> </tr> <tr> <td>VM1794A0</td> <td>250X4.8 PA66 BLACK CLAMP</td> <td>2</td> <td>PZ</td> </tr> <tr> <td>VM2103A0</td> <td>CLAMP LOCK</td> <td>2</td> <td>PZ</td> </tr> <tr> <td>VM2259A1</td> <td>6 SERIES DOOR LOWER LEFT CAP</td> <td>1</td> <td>PZ</td> </tr> <tr> <td>VM2261A1</td> <td>6 SERIES DOOR LOWER RIGHT CAP</td> <td>1</td> <td>PZ</td> </tr> <tr> <td>VM2267A0</td> <td>INTERNAL GLASS LOCKING SYSTEM SLIDER</td> <td>1</td> <td>PZ</td> </tr> <tr> <td>VM2269A0</td> <td>INTERNAL GLASS LOCKING SYSTEM CAP</td> <td>1</td> <td>PZ</td> </tr> <tr> <td>VM2274A0</td> <td>GROOVED BUSHING</td> <td>1</td> <td>PZ</td> </tr> <tr> <td>VM2305A0</td> <td>6 SERIES DOOR CAP FIXING PAWL</td> <td>7</td> <td>PZ</td> </tr> </tbody> </table>	Code	Description	Qty	UOM	0B1122A0	750MM DOOR LOWER FRAME SHAPE	1	PZ	0B1122A1	750MM DOOR LOWER FRAME SHAPE	1	PZ	RC1200A0	ED=4 WIRE D.=0.5 COMPRESSIO N SPRING	2	PZ	VI1220A1	4,2X12 TCB SELF-TAPPIN G SCREW	1	PZ	VI1996A0	M5X35 SCREW	7	PZ	VM1794A0	250X4.8 PA66 BLACK CLAMP	2	PZ	VM2103A0	CLAMP LOCK	2	PZ	VM2259A1	6 SERIES DOOR LOWER LEFT CAP	1	PZ	VM2261A1	6 SERIES DOOR LOWER RIGHT CAP	1	PZ	VM2267A0	INTERNAL GLASS LOCKING SYSTEM SLIDER	1	PZ	VM2269A0	INTERNAL GLASS LOCKING SYSTEM CAP	1	PZ	VM2274A0	GROOVED BUSHING	1	PZ	VM2305A0	6 SERIES DOOR CAP FIXING PAWL	7	PZ	K0B1122AL	CHEFTOP MM LEFT DOOR LOWER BEAM KIT	<table border="1"> <thead> <tr> <th>Code</th> <th>Description</th> <th>Qty</th> <th>UOM</th> </tr> </thead> <tbody> <tr> <td>0B1122A0</td> <td>750MM DOOR LOWER FRAME SHAPE</td> <td>1</td> <td>PZ</td> </tr> <tr> <td>0B1122A1</td> <td>750MM DOOR LOWER FRAME SHAPE</td> <td>1</td> <td>PZ</td> </tr> <tr> <td>RC1200A0</td> <td>ED=4 WIRE D.=0.5 COMPRESSIO N SPRING</td> <td>2</td> <td>PZ</td> </tr> <tr> <td>VI1220A1</td> <td>4,2X12 TCB SELF-TAPPIN G SCREW</td> <td>1</td> <td>PZ</td> </tr> <tr> <td>VI1996A0</td> <td>M5X35 SCREW</td> <td>7</td> <td>PZ</td> </tr> <tr> <td>VM1794A0</td> <td>250X4.8 PA66 BLACK CLAMP</td> <td>2</td> <td>PZ</td> </tr> </tbody> </table>	Code	Description	Qty	UOM	0B1122A0	750MM DOOR LOWER FRAME SHAPE	1	PZ	0B1122A1	750MM DOOR LOWER FRAME SHAPE	1	PZ	RC1200A0	ED=4 WIRE D.=0.5 COMPRESSIO N SPRING	2	PZ	VI1220A1	4,2X12 TCB SELF-TAPPIN G SCREW	1	PZ	VI1996A0	M5X35 SCREW	7	PZ	VM1794A0	250X4.8 PA66 BLACK CLAMP	2	PZ
			Code	Description	Qty	UOM																																																																																						
0B1122A0	750MM DOOR LOWER FRAME SHAPE	1	PZ																																																																																									
0B1122A1	750MM DOOR LOWER FRAME SHAPE	1	PZ																																																																																									
RC1200A0	ED=4 WIRE D.=0.5 COMPRESSIO N SPRING	2	PZ																																																																																									
VI1220A1	4,2X12 TCB SELF-TAPPIN G SCREW	1	PZ																																																																																									
VI1996A0	M5X35 SCREW	7	PZ																																																																																									
VM1794A0	250X4.8 PA66 BLACK CLAMP	2	PZ																																																																																									
VM2103A0	CLAMP LOCK	2	PZ																																																																																									
VM2259A1	6 SERIES DOOR LOWER LEFT CAP	1	PZ																																																																																									
VM2261A1	6 SERIES DOOR LOWER RIGHT CAP	1	PZ																																																																																									
VM2267A0	INTERNAL GLASS LOCKING SYSTEM SLIDER	1	PZ																																																																																									
VM2269A0	INTERNAL GLASS LOCKING SYSTEM CAP	1	PZ																																																																																									
VM2274A0	GROOVED BUSHING	1	PZ																																																																																									
VM2305A0	6 SERIES DOOR CAP FIXING PAWL	7	PZ																																																																																									
Code	Description	Qty	UOM																																																																																									
0B1122A0	750MM DOOR LOWER FRAME SHAPE	1	PZ																																																																																									
0B1122A1	750MM DOOR LOWER FRAME SHAPE	1	PZ																																																																																									
RC1200A0	ED=4 WIRE D.=0.5 COMPRESSIO N SPRING	2	PZ																																																																																									
VI1220A1	4,2X12 TCB SELF-TAPPIN G SCREW	1	PZ																																																																																									
VI1996A0	M5X35 SCREW	7	PZ																																																																																									
VM1794A0	250X4.8 PA66 BLACK CLAMP	2	PZ																																																																																									



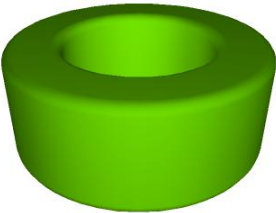

COMPONENT			SPARE PART																																										
Code	Description	Image	Code	Description	Components list																																								
VM2261A	6 SERIES DOOR LOWER RIGHT CAP		K0B1122AL	CHEFTOP MM LEFT DOOR LOWER BEAM KIT	<table border="1"> <thead> <tr> <th>Code</th> <th>Description</th> <th>Qty</th> <th>UOM</th> </tr> </thead> <tbody> <tr> <td>VM2103A0</td> <td>CLAMP LOCK</td> <td>2</td> <td>PZ</td> </tr> <tr> <td>VM2267A0</td> <td>INTERNAL GLASS LOCKING SYSTEM SLIDER</td> <td>1</td> <td>PZ</td> </tr> <tr> <td>VM2269A0</td> <td>INTERNAL GLASS LOCKING SYSTEM CAP</td> <td>1</td> <td>PZ</td> </tr> <tr> <td>VM2274A0</td> <td>GROOVED BUSHING</td> <td>1</td> <td>PZ</td> </tr> <tr> <td>VM2305A0</td> <td>6 SERIES DOOR CAP FIXING PAWL</td> <td>7</td> <td>PZ</td> </tr> <tr> <td>VM2384A0</td> <td>MM LEFT DOOR RIGHT LOWER CAP</td> <td>1</td> <td>PZ</td> </tr> <tr> <td>VM2384A0</td> <td>MM LEFT DOOR RIGHT LOWER CAP</td> <td>1</td> <td>PZ</td> </tr> <tr> <td>VM2386A1</td> <td>LEFT MM DOOR LOWER LEFT CAP</td> <td>1</td> <td>PZ</td> </tr> <tr> <td>VM2386A1</td> <td>LEFT MM DOOR LOWER LEFT CAP</td> <td>1</td> <td>PZ</td> </tr> </tbody> </table>	Code	Description	Qty	UOM	VM2103A0	CLAMP LOCK	2	PZ	VM2267A0	INTERNAL GLASS LOCKING SYSTEM SLIDER	1	PZ	VM2269A0	INTERNAL GLASS LOCKING SYSTEM CAP	1	PZ	VM2274A0	GROOVED BUSHING	1	PZ	VM2305A0	6 SERIES DOOR CAP FIXING PAWL	7	PZ	VM2384A0	MM LEFT DOOR RIGHT LOWER CAP	1	PZ	VM2384A0	MM LEFT DOOR RIGHT LOWER CAP	1	PZ	VM2386A1	LEFT MM DOOR LOWER LEFT CAP	1	PZ	VM2386A1	LEFT MM DOOR LOWER LEFT CAP	1	PZ
Code	Description	Qty	UOM																																										
VM2103A0	CLAMP LOCK	2	PZ																																										
VM2267A0	INTERNAL GLASS LOCKING SYSTEM SLIDER	1	PZ																																										
VM2269A0	INTERNAL GLASS LOCKING SYSTEM CAP	1	PZ																																										
VM2274A0	GROOVED BUSHING	1	PZ																																										
VM2305A0	6 SERIES DOOR CAP FIXING PAWL	7	PZ																																										
VM2384A0	MM LEFT DOOR RIGHT LOWER CAP	1	PZ																																										
VM2384A0	MM LEFT DOOR RIGHT LOWER CAP	1	PZ																																										
VM2386A1	LEFT MM DOOR LOWER LEFT CAP	1	PZ																																										
VM2386A1	LEFT MM DOOR LOWER LEFT CAP	1	PZ																																										
VM2267A	INTERNAL GLASS LOCKING SYSTEM SLIDER		VM2267A0	INTERNAL GLASS LOCKING SYSTEM SLIDER																																									
LP1020A	6 SERIES L400 LED LIGHT BAR - E583		KLP1020A	L400 E583 LED LIGHT BAR KIT	<table border="1"> <thead> <tr> <th>Code</th> <th>Description</th> <th>Qty</th> <th>UOM</th> </tr> </thead> <tbody> <tr> <td>IP1385A1</td> <td>CORNER POLYSTYREN E PACKING 110X80X2000</td> <td>1.240</td> <td>M</td> </tr> <tr> <td>LP1020A0</td> <td>6 SERIES L400 LED LIGHT BAR - E583</td> <td>1</td> <td>PZ</td> </tr> <tr> <td>VM1059A1</td> <td>HEAT SHRINK FILM H800</td> <td>1.240</td> <td>M</td> </tr> </tbody> </table>	Code	Description	Qty	UOM	IP1385A1	CORNER POLYSTYREN E PACKING 110X80X2000	1.240	M	LP1020A0	6 SERIES L400 LED LIGHT BAR - E583	1	PZ	VM1059A1	HEAT SHRINK FILM H800	1.240	M																								
Code	Description	Qty	UOM																																										
IP1385A1	CORNER POLYSTYREN E PACKING 110X80X2000	1.240	M																																										
LP1020A0	6 SERIES L400 LED LIGHT BAR - E583	1	PZ																																										
VM1059A1	HEAT SHRINK FILM H800	1.240	M																																										







COMPONENT			SPARE PART																																		
Code	Description	Image	Code	Description	Components list																																
LP1026A	L=583 S6 NO LED LIGHT BAR COVER		KLP1026A	L583 MM NO LED LIGHT HOLDER KIT	<table border="1"> <thead> <tr> <th>Code</th> <th>Description</th> <th>Qty</th> <th>UOM</th> </tr> </thead> <tbody> <tr> <td>IP1385A1</td> <td>CORNER POLYSTYREN E PACKING 110X80X2000</td> <td>1.240</td> <td>M</td> </tr> <tr> <td>LP1026A0</td> <td>L=583 S6 NO LED LIGHT BAR COVER</td> <td>1</td> <td>PZ</td> </tr> <tr> <td>VM1059A1</td> <td>HEAT SHRINK FILM H800</td> <td>1.240</td> <td>M</td> </tr> <tr> <td>VM1794A0</td> <td>250X4.8 PA66 BLACK CLAMP</td> <td>2</td> <td>PZ</td> </tr> <tr> <td>VM2103A0</td> <td>CLAMP LOCK</td> <td>2</td> <td>PZ</td> </tr> </tbody> </table>	Code	Description	Qty	UOM	IP1385A1	CORNER POLYSTYREN E PACKING 110X80X2000	1.240	M	LP1026A0	L=583 S6 NO LED LIGHT BAR COVER	1	PZ	VM1059A1	HEAT SHRINK FILM H800	1.240	M	VM1794A0	250X4.8 PA66 BLACK CLAMP	2	PZ	VM2103A0	CLAMP LOCK	2	PZ								
Code	Description	Qty	UOM																																		
IP1385A1	CORNER POLYSTYREN E PACKING 110X80X2000	1.240	M																																		
LP1026A0	L=583 S6 NO LED LIGHT BAR COVER	1	PZ																																		
VM1059A1	HEAT SHRINK FILM H800	1.240	M																																		
VM1794A0	250X4.8 PA66 BLACK CLAMP	2	PZ																																		
VM2103A0	CLAMP LOCK	2	PZ																																		
CE1285A	EMI ROUND FERRITE MOD.2643801502		CE1285A0	EMI ROUND FERRITE MOD.2643801502																																	
CE1310A	POWER - CONTROL BOARD CONNECTING CABL		KCE1310A	CONTROL-POWER CONNECTION CABLE KIT	<table border="1"> <thead> <tr> <th>Code</th> <th>Description</th> <th>Qty</th> <th>UOM</th> </tr> </thead> <tbody> <tr> <td>CE1285A0</td> <td>EMI ROUND FERRITE MOD.26438015 02</td> <td>1</td> <td>PZ</td> </tr> <tr> <td>CE1290A0</td> <td>EXTRACTABL E FEMALE TERMINAL CPF 5/4</td> <td>1</td> <td>PZ</td> </tr> <tr> <td>CE1455A0</td> <td>TIP END FITTING</td> <td>4</td> <td>PZ</td> </tr> <tr> <td>CE1725A0</td> <td>ROBOTICS SILICON PIPE 4X0,5 MMQ</td> <td>4</td> <td>M</td> </tr> <tr> <td>CE1735A0</td> <td>MINIFIT FEMALE END FITTING</td> <td>4</td> <td>PZ</td> </tr> <tr> <td>CE1755A0</td> <td>4 WAYS MALE MINIFIT CONNECTOR</td> <td>1</td> <td>PZ</td> </tr> <tr> <td>VM1224A0</td> <td></td> <td>0.350</td> <td>M</td> </tr> </tbody> </table>	Code	Description	Qty	UOM	CE1285A0	EMI ROUND FERRITE MOD.26438015 02	1	PZ	CE1290A0	EXTRACTABL E FEMALE TERMINAL CPF 5/4	1	PZ	CE1455A0	TIP END FITTING	4	PZ	CE1725A0	ROBOTICS SILICON PIPE 4X0,5 MMQ	4	M	CE1735A0	MINIFIT FEMALE END FITTING	4	PZ	CE1755A0	4 WAYS MALE MINIFIT CONNECTOR	1	PZ	VM1224A0		0.350	M
Code	Description	Qty	UOM																																		
CE1285A0	EMI ROUND FERRITE MOD.26438015 02	1	PZ																																		
CE1290A0	EXTRACTABL E FEMALE TERMINAL CPF 5/4	1	PZ																																		
CE1455A0	TIP END FITTING	4	PZ																																		
CE1725A0	ROBOTICS SILICON PIPE 4X0,5 MMQ	4	M																																		
CE1735A0	MINIFIT FEMALE END FITTING	4	PZ																																		
CE1755A0	4 WAYS MALE MINIFIT CONNECTOR	1	PZ																																		
VM1224A0		0.350	M																																		
CE1053B	MM MICROFIT LED BAR POWER SUPPLY CABLE		KCE1053B	LED BAR EXTENSION CABLE KIT	<table border="1"> <thead> <tr> <th>Code</th> <th>Description</th> <th>Qty</th> <th>UOM</th> </tr> </thead> <tbody> <tr> <td>CE1053B0</td> <td>MM MICROFIT LED BAR POWER SUPPLY CABL</td> <td>1</td> <td>PZ</td> </tr> </tbody> </table>	Code	Description	Qty	UOM	CE1053B0	MM MICROFIT LED BAR POWER SUPPLY CABL	1	PZ																								
Code	Description	Qty	UOM																																		
CE1053B0	MM MICROFIT LED BAR POWER SUPPLY CABL	1	PZ																																		

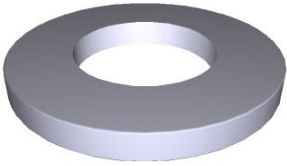

COMPONENT			SPARE PART																																		
Code	Description	Image	Code	Description	Components list																																
VM2312A	6 S. DRIP PROFILE DRAIN LEFT PIPE		KVM2312A	M.M. DRIP TRAY LEFT DRAIN PIPE KI	<table border="1"> <thead> <tr> <th>Code</th> <th>Description</th> <th>Qty</th> <th>UOM</th> </tr> </thead> <tbody> <tr> <td>VM1224A0</td> <td></td> <td>0.150</td> <td>M</td> </tr> <tr> <td>VM2312A0</td> <td>6 S. DRIP PROFILE DRAIN LEFT PIPE</td> <td>1</td> <td>PZ</td> </tr> </tbody> </table>	Code	Description	Qty	UOM	VM1224A0		0.150	M	VM2312A0	6 S. DRIP PROFILE DRAIN LEFT PIPE	1	PZ																				
Code	Description	Qty	UOM																																		
VM1224A0		0.150	M																																		
VM2312A0	6 S. DRIP PROFILE DRAIN LEFT PIPE	1	PZ																																		
VM2314A	6 S. DRIP PROFILE CAP		KVM2314A	MIND.MAPS DRIP TRAY CAP	<table border="1"> <thead> <tr> <th>Code</th> <th>Description</th> <th>Qty</th> <th>UOM</th> </tr> </thead> <tbody> <tr> <td>VM1224A0</td> <td></td> <td>0.200</td> <td>M</td> </tr> <tr> <td>VM2314A0</td> <td>6 S. DRIP PROFILE CAP</td> <td>1</td> <td>PZ</td> </tr> </tbody> </table>	Code	Description	Qty	UOM	VM1224A0		0.200	M	VM2314A0	6 S. DRIP PROFILE CAP	1	PZ																				
Code	Description	Qty	UOM																																		
VM1224A0		0.200	M																																		
VM2314A0	6 S. DRIP PROFILE CAP	1	PZ																																		
VM2285A	860 SERIES DRIP PROFILE		KVM2285A	860 SERIES DRIP PROFILE KIT	<table border="1"> <thead> <tr> <th>Code</th> <th>Description</th> <th>Qty</th> <th>UOM</th> </tr> </thead> <tbody> <tr> <td>VM2285A0</td> <td>860 SERIES DRIP PROFILE</td> <td>1</td> <td>PZ</td> </tr> </tbody> </table>	Code	Description	Qty	UOM	VM2285A0	860 SERIES DRIP PROFILE	1	PZ																								
Code	Description	Qty	UOM																																		
VM2285A0	860 SERIES DRIP PROFILE	1	PZ																																		
VT1291A	XEBC-06EU-E EXTERNAL GLASS		KVT1291A	06EU EXTERNAL GLASS KIT	<table border="1"> <thead> <tr> <th>Code</th> <th>Description</th> <th>Qty</th> <th>UOM</th> </tr> </thead> <tbody> <tr> <td>OB1167A0</td> <td>EXT. GLASS SUPPORT PROFILE</td> <td>2</td> <td>PZ</td> </tr> <tr> <td>IP1508A1</td> <td>POLYSTYREN E U SHAPED PROFILE 2000X60X60</td> <td>1</td> <td>M</td> </tr> <tr> <td>SL1155A1</td> <td>LOCTITE BICOMPONENT SILICON</td> <td>150</td> <td>ML</td> </tr> <tr> <td>SL1156A0</td> <td>NOZZLE FOR SILICON GUN</td> <td>1</td> <td>PZ</td> </tr> <tr> <td>VM1059A1</td> <td>HEAT SHRINK FILM H800</td> <td>1.500</td> <td>M</td> </tr> <tr> <td>VT1291A0</td> <td>XEBC-06EU-E EXTERNAL GLASS</td> <td>1</td> <td>PZ</td> </tr> <tr> <td>VT1291A0</td> <td>XEBC-06EU-E EXTERNAL GLASS</td> <td>1</td> <td>PZ</td> </tr> </tbody> </table>	Code	Description	Qty	UOM	OB1167A0	EXT. GLASS SUPPORT PROFILE	2	PZ	IP1508A1	POLYSTYREN E U SHAPED PROFILE 2000X60X60	1	M	SL1155A1	LOCTITE BICOMPONENT SILICON	150	ML	SL1156A0	NOZZLE FOR SILICON GUN	1	PZ	VM1059A1	HEAT SHRINK FILM H800	1.500	M	VT1291A0	XEBC-06EU-E EXTERNAL GLASS	1	PZ	VT1291A0	XEBC-06EU-E EXTERNAL GLASS	1	PZ
Code	Description	Qty	UOM																																		
OB1167A0	EXT. GLASS SUPPORT PROFILE	2	PZ																																		
IP1508A1	POLYSTYREN E U SHAPED PROFILE 2000X60X60	1	M																																		
SL1155A1	LOCTITE BICOMPONENT SILICON	150	ML																																		
SL1156A0	NOZZLE FOR SILICON GUN	1	PZ																																		
VM1059A1	HEAT SHRINK FILM H800	1.500	M																																		
VT1291A0	XEBC-06EU-E EXTERNAL GLASS	1	PZ																																		
VT1291A0	XEBC-06EU-E EXTERNAL GLASS	1	PZ																																		









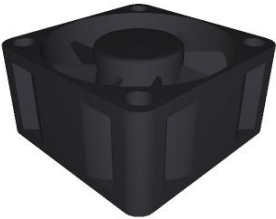

COMPONENT			SPARE PART																						
Code	Description	Image	Code	Description	Components list																				
VI1034A	STAINLESS STEEL WASHER 8.4X16X1		VI1034A0	STAINLESS STEEL WASHER 8.4X16X1																					
CE1052A	CABLE CONNECTION CONTROL - USB MM 750MM		KCE1052A	CONTROL BOARD-USB 650 CONN. CABLE KIT	<table border="1"> <thead> <tr> <th>Code</th> <th>Description</th> <th>Qty</th> <th>UOM</th> </tr> </thead> <tbody> <tr> <td>CE1052A1</td> <td>CABLE CONNECTION CONTROL - USB MM 750M</td> <td>1</td> <td>PZ</td> </tr> <tr> <td>VM1224A0</td> <td></td> <td>0.350</td> <td>M</td> </tr> </tbody> </table>	Code	Description	Qty	UOM	CE1052A1	CABLE CONNECTION CONTROL - USB MM 750M	1	PZ	VM1224A0		0.350	M								
Code	Description	Qty	UOM																						
CE1052A1	CABLE CONNECTION CONTROL - USB MM 750M	1	PZ																						
VM1224A0		0.350	M																						
VM2410A	PLATE TO STOP EXTRUDED LED BAR		KVM2410A	PLATE TO STOP EXTRUDED LED BAR 2P KIT	<table border="1"> <thead> <tr> <th>Code</th> <th>Description</th> <th>Qty</th> <th>UOM</th> </tr> </thead> <tbody> <tr> <td>0B1190A0</td> <td>PLATE TO STOP EXTRUDED LED BAR</td> <td>2</td> <td>PZ</td> </tr> <tr> <td>VM1224A0</td> <td></td> <td>0.200</td> <td>M</td> </tr> <tr> <td>VM2410A0</td> <td>PLATE TO STOP EXTRUDED LED BAR</td> <td>2</td> <td>PZ</td> </tr> <tr> <td>VM2410A0</td> <td>PLATE TO STOP EXTRUDED LED BAR</td> <td>2</td> <td>PZ</td> </tr> </tbody> </table>	Code	Description	Qty	UOM	0B1190A0	PLATE TO STOP EXTRUDED LED BAR	2	PZ	VM1224A0		0.200	M	VM2410A0	PLATE TO STOP EXTRUDED LED BAR	2	PZ	VM2410A0	PLATE TO STOP EXTRUDED LED BAR	2	PZ
Code	Description	Qty	UOM																						
0B1190A0	PLATE TO STOP EXTRUDED LED BAR	2	PZ																						
VM1224A0		0.200	M																						
VM2410A0	PLATE TO STOP EXTRUDED LED BAR	2	PZ																						
VM2410A0	PLATE TO STOP EXTRUDED LED BAR	2	PZ																						
VM2305A	6 SERIES DOOR CAP FIXING PAWL		KVM2305A	MM FIXING DOOR THUB SCREWS 10 PCS KIT	<table border="1"> <thead> <tr> <th>Code</th> <th>Description</th> <th>Qty</th> <th>UOM</th> </tr> </thead> <tbody> <tr> <td>VM1224A0</td> <td></td> <td>0.200</td> <td>M</td> </tr> <tr> <td>VM2305A0</td> <td>6 SERIES DOOR CAP FIXING PAWL</td> <td>10</td> <td>PZ</td> </tr> </tbody> </table>	Code	Description	Qty	UOM	VM1224A0		0.200	M	VM2305A0	6 SERIES DOOR CAP FIXING PAWL	10	PZ								
Code	Description	Qty	UOM																						
VM1224A0		0.200	M																						
VM2305A0	6 SERIES DOOR CAP FIXING PAWL	10	PZ																						
VM2275A	SMOOTH BUSHING		KVM2275A	SMOOTH PIN BUSHING KIT	<table border="1"> <thead> <tr> <th>Code</th> <th>Description</th> <th>Qty</th> <th>UOM</th> </tr> </thead> <tbody> <tr> <td>VM1224A0</td> <td></td> <td>0.150</td> <td>M</td> </tr> <tr> <td>VM2275A0</td> <td>SMOOTH BUSHING</td> <td>1</td> <td>PZ</td> </tr> </tbody> </table>	Code	Description	Qty	UOM	VM1224A0		0.150	M	VM2275A0	SMOOTH BUSHING	1	PZ								
Code	Description	Qty	UOM																						
VM1224A0		0.150	M																						
VM2275A0	SMOOTH BUSHING	1	PZ																						







COMPONENT			SPARE PART																		
Code	Description	Image	Code	Description	Components list																
VI1996A	M5X35 SCREW		VI1996A0	M5X35 SCREW																	
VM2260A	6 SERIES DOOR UPPER LEFT CAP		KVM2260A	MIND.MAPS DOOR LEFT UPPER CAP KI	<table border="1"> <thead> <tr> <th>Code</th> <th>Description</th> <th>Qty</th> <th>UOM</th> </tr> </thead> <tbody> <tr> <td>VM1224A0</td> <td></td> <td>0.250</td> <td>M</td> </tr> <tr> <td>VM2260A1</td> <td>6 SERIES DOOR UPPER LEFT CAP</td> <td>1</td> <td>PZ</td> </tr> </tbody> </table>	Code	Description	Qty	UOM	VM1224A0		0.250	M	VM2260A1	6 SERIES DOOR UPPER LEFT CAP	1	PZ				
Code	Description	Qty	UOM																		
VM1224A0		0.250	M																		
VM2260A1	6 SERIES DOOR UPPER LEFT CAP	1	PZ																		
OB1167A			OUTOFPRODUCTIO																		
PE2046A	MM POWER SWITCH AND USB BOARD		KPE2046A	MIND.MAPS USB-RESET SUPPORT KIT	<table border="1"> <thead> <tr> <th>Code</th> <th>Description</th> <th>Qty</th> <th>UOM</th> </tr> </thead> <tbody> <tr> <td>PE2046A2</td> <td>MM POWER SWITCH AND USB BOARD</td> <td>1</td> <td>PZ</td> </tr> <tr> <td>VI1220A1</td> <td>4,2X12 TCB SELF-TAPPIN G SCREW</td> <td>2</td> <td>PZ</td> </tr> <tr> <td>VM2147A0</td> <td>410X343X15 MM PINK SMOOTH ESD SPONGE</td> <td>0.250</td> <td>PZ</td> </tr> </tbody> </table>	Code	Description	Qty	UOM	PE2046A2	MM POWER SWITCH AND USB BOARD	1	PZ	VI1220A1	4,2X12 TCB SELF-TAPPIN G SCREW	2	PZ	VM2147A0	410X343X15 MM PINK SMOOTH ESD SPONGE	0.250	PZ
Code	Description	Qty	UOM																		
PE2046A2	MM POWER SWITCH AND USB BOARD	1	PZ																		
VI1220A1	4,2X12 TCB SELF-TAPPIN G SCREW	2	PZ																		
VM2147A0	410X343X15 MM PINK SMOOTH ESD SPONGE	0.250	PZ																		
VM2518A	BOARD COOLING FAN SUPPORT		KVM2518A	PANEL COOLING FAN SUPPORT KIT	<table border="1"> <thead> <tr> <th>Code</th> <th>Description</th> <th>Qty</th> <th>UOM</th> </tr> </thead> <tbody> <tr> <td>VM1224A0</td> <td></td> <td>0.150</td> <td>M</td> </tr> <tr> <td>VM2518A0</td> <td>BOARD COOLING FAN SUPPORT</td> <td>1</td> <td>PZ</td> </tr> <tr> <td>VM2518A0</td> <td>BOARD COOLING FAN SUPPORT</td> <td>1</td> <td>PZ</td> </tr> </tbody> </table>	Code	Description	Qty	UOM	VM1224A0		0.150	M	VM2518A0	BOARD COOLING FAN SUPPORT	1	PZ	VM2518A0	BOARD COOLING FAN SUPPORT	1	PZ
Code	Description	Qty	UOM																		
VM1224A0		0.150	M																		
VM2518A0	BOARD COOLING FAN SUPPORT	1	PZ																		
VM2518A0	BOARD COOLING FAN SUPPORT	1	PZ																		









COMPONENT			SPARE PART																						
Code	Description	Image	Code	Description	Components list																				
VN1179A	CONTROL BOARD 40X40X20MM 12V COOLING FAN		KVN1179A	CONTROL BOARD COOLING FAN KIT	<table border="1"> <thead> <tr> <th>Code</th> <th>Description</th> <th>Qty</th> <th>UOM</th> </tr> </thead> <tbody> <tr> <td>VM1224A0</td> <td></td> <td>0.150</td> <td>M</td> </tr> <tr> <td>VN1179A0</td> <td>CONTROL BOARD 40X40X20MM 12V COOLING FAN</td> <td>1</td> <td>PZ</td> </tr> <tr> <td>VN1179A0</td> <td>CONTROL BOARD 40X40X20MM 12V COOLING FAN</td> <td>1</td> <td>PZ</td> </tr> <tr> <td>VN1179A1</td> <td>CONTROL BOARD 40X40X20MM 12V COOLING FAN</td> <td>1</td> <td>PZ</td> </tr> </tbody> </table>	Code	Description	Qty	UOM	VM1224A0		0.150	M	VN1179A0	CONTROL BOARD 40X40X20MM 12V COOLING FAN	1	PZ	VN1179A0	CONTROL BOARD 40X40X20MM 12V COOLING FAN	1	PZ	VN1179A1	CONTROL BOARD 40X40X20MM 12V COOLING FAN	1	PZ
Code	Description	Qty	UOM																						
VM1224A0		0.150	M																						
VN1179A0	CONTROL BOARD 40X40X20MM 12V COOLING FAN	1	PZ																						
VN1179A0	CONTROL BOARD 40X40X20MM 12V COOLING FAN	1	PZ																						
VN1179A1	CONTROL BOARD 40X40X20MM 12V COOLING FAN	1	PZ																						
0B1112A	0711 RIGHT - DOOR LEFT INT COLUMN		0B1112A2	0711 RIGHT - DOOR LEFT INT COLUMN																					
0B1113A	XEVC-0711-E RIGHT EXT DOOR COLUMN		0B1113A0	XEVC-0711-E RIGHT EXT DOOR COLUMN																					
0B1114A	0711 RIGHT - DOOR RIGHT INT COLUMN		OUTOFPRODUCTIO																						

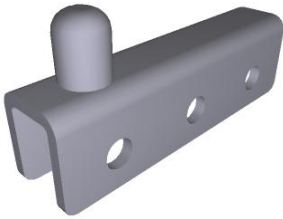

COMPONENT			SPARE PART																										
Code	Description	Image	Code	Description	Components list																								
PE2042A	MM ONE VERSION CONTROL BOARD		KPE2042A	MIND.MAPS ONE CONTROL BOARD KIT	<table border="1"> <thead> <tr> <th>Code</th> <th>Description</th> <th>Qty</th> <th>UOM</th> </tr> </thead> <tbody> <tr> <td>PE2042A4</td> <td>MM ONE VERSION CONTROL BOARD</td> <td>1</td> <td>PZ</td> </tr> <tr> <td>PE2042A5</td> <td>MM ONE VERSION CONTROL BOARD</td> <td>1</td> <td>PZ</td> </tr> <tr> <td>VI1074A0</td> <td></td> <td>2</td> <td>PZ</td> </tr> <tr> <td>VI2000A0</td> <td>SCREW M4X22 TCB+ INOX</td> <td>4</td> <td>PZ</td> </tr> <tr> <td>VM2147A0</td> <td>410X343X15 MM PINK SMOOTH ESD SPONGE</td> <td>1</td> <td>PZ</td> </tr> </tbody> </table>	Code	Description	Qty	UOM	PE2042A4	MM ONE VERSION CONTROL BOARD	1	PZ	PE2042A5	MM ONE VERSION CONTROL BOARD	1	PZ	VI1074A0		2	PZ	VI2000A0	SCREW M4X22 TCB+ INOX	4	PZ	VM2147A0	410X343X15 MM PINK SMOOTH ESD SPONGE	1	PZ
Code	Description	Qty	UOM																										
PE2042A4	MM ONE VERSION CONTROL BOARD	1	PZ																										
PE2042A5	MM ONE VERSION CONTROL BOARD	1	PZ																										
VI1074A0		2	PZ																										
VI2000A0	SCREW M4X22 TCB+ INOX	4	PZ																										
VM2147A0	410X343X15 MM PINK SMOOTH ESD SPONGE	1	PZ																										
VM1630A	XB/XV/XVC/XG TERMINAL COVERING BOX		KVM1630A	CAP FOR INTERNAL GLASS 10 PCS KIT	<table border="1"> <thead> <tr> <th>Code</th> <th>Description</th> <th>Qty</th> <th>UOM</th> </tr> </thead> <tbody> <tr> <td>VM1224A0</td> <td></td> <td>0.200</td> <td>M</td> </tr> <tr> <td>VM1630A0</td> <td>INTERNAL GLASS PUSHING CAP</td> <td>10</td> <td>PZ</td> </tr> </tbody> </table>	Code	Description	Qty	UOM	VM1224A0		0.200	M	VM1630A0	INTERNAL GLASS PUSHING CAP	10	PZ												
Code	Description	Qty	UOM																										
VM1224A0		0.200	M																										
VM1630A0	INTERNAL GLASS PUSHING CAP	10	PZ																										
VM2315A			KVM2315A	3 PCS MM INTERNAL GLASS SUPPORT KIT	<table border="1"> <thead> <tr> <th>Code</th> <th>Description</th> <th>Qty</th> <th>UOM</th> </tr> </thead> <tbody> <tr> <td>VI1220A1</td> <td>4,2X12 TCB SELF-TAPPIN G SCREW</td> <td>3</td> <td>PZ</td> </tr> <tr> <td>VM1224A0</td> <td></td> <td>0.200</td> <td>M</td> </tr> <tr> <td>VM1630A0</td> <td>INTERNAL GLASS PUSHING CAP</td> <td>3</td> <td>PZ</td> </tr> <tr> <td>VM2315A0</td> <td>MIND.MAPS INTERNAL GLASS CAP SUPPORT</td> <td>3</td> <td>PZ</td> </tr> </tbody> </table>	Code	Description	Qty	UOM	VI1220A1	4,2X12 TCB SELF-TAPPIN G SCREW	3	PZ	VM1224A0		0.200	M	VM1630A0	INTERNAL GLASS PUSHING CAP	3	PZ	VM2315A0	MIND.MAPS INTERNAL GLASS CAP SUPPORT	3	PZ				
Code	Description	Qty	UOM																										
VI1220A1	4,2X12 TCB SELF-TAPPIN G SCREW	3	PZ																										
VM1224A0		0.200	M																										
VM1630A0	INTERNAL GLASS PUSHING CAP	3	PZ																										
VM2315A0	MIND.MAPS INTERNAL GLASS CAP SUPPORT	3	PZ																										
0B1219A	MM DOUBLE GLASS DOOR INT UPPER BEAM 860		0B1219A1	MM DOUBLE GLASS DOOR INT UPPER BEAM 860																									

COMPONENT			SPARE PART																																																										
Code	Description	Image	Code	Description	Components list																																																								
OB1126A			K0B1126AR	BAKERTOP MM RIGHT DOOR LOWER BEAM KIT	<table border="1"> <thead> <tr> <th>Code</th> <th>Description</th> <th>Qty</th> <th>UOM</th> </tr> </thead> <tbody> <tr> <td>OB1126A0</td> <td>DOOR LOWER FRAME SHAPE 860 MM</td> <td>1</td> <td>PZ</td> </tr> <tr> <td>OB1126A1</td> <td></td> <td>1</td> <td>PZ</td> </tr> <tr> <td>RC1200A0</td> <td>ED=4 WIRE D.=0.5 COMPRESSIO N SPRING</td> <td>2</td> <td>PZ</td> </tr> <tr> <td>VI1220A1</td> <td>4,2X12 TCB SELF-TAPPIN G SCREW</td> <td>1</td> <td>PZ</td> </tr> <tr> <td>VI1996A0</td> <td>M5X35 SCREW</td> <td>7</td> <td>PZ</td> </tr> <tr> <td>VM1794A0</td> <td>250X4.8 PA66 BLACK CLAMP</td> <td>2</td> <td>PZ</td> </tr> <tr> <td>VM2103A0</td> <td>CLAMP LOCK</td> <td>2</td> <td>PZ</td> </tr> <tr> <td>VM2259A1</td> <td>6 SERIES DOOR LOWER LEFT CAP</td> <td>1</td> <td>PZ</td> </tr> <tr> <td>VM2261A1</td> <td>6 SERIES DOOR LOWER RIGHT CAP</td> <td>1</td> <td>PZ</td> </tr> <tr> <td>VM2267A0</td> <td>INTERNAL GLASS LOCKING SYSTEM SLIDER</td> <td>1</td> <td>PZ</td> </tr> <tr> <td>VM2269A0</td> <td>INTERNAL GLASS LOCKING SYSTEM CAP</td> <td>1</td> <td>PZ</td> </tr> <tr> <td>VM2274A0</td> <td>GROOVED BUSHING</td> <td>1</td> <td>PZ</td> </tr> <tr> <td>VM2305A0</td> <td>6 SERIES DOOR CAP FIXING PAWL</td> <td>7</td> <td>PZ</td> </tr> </tbody> </table>	Code	Description	Qty	UOM	OB1126A0	DOOR LOWER FRAME SHAPE 860 MM	1	PZ	OB1126A1		1	PZ	RC1200A0	ED=4 WIRE D.=0.5 COMPRESSIO N SPRING	2	PZ	VI1220A1	4,2X12 TCB SELF-TAPPIN G SCREW	1	PZ	VI1996A0	M5X35 SCREW	7	PZ	VM1794A0	250X4.8 PA66 BLACK CLAMP	2	PZ	VM2103A0	CLAMP LOCK	2	PZ	VM2259A1	6 SERIES DOOR LOWER LEFT CAP	1	PZ	VM2261A1	6 SERIES DOOR LOWER RIGHT CAP	1	PZ	VM2267A0	INTERNAL GLASS LOCKING SYSTEM SLIDER	1	PZ	VM2269A0	INTERNAL GLASS LOCKING SYSTEM CAP	1	PZ	VM2274A0	GROOVED BUSHING	1	PZ	VM2305A0	6 SERIES DOOR CAP FIXING PAWL	7	PZ
			Code	Description	Qty	UOM																																																							
OB1126A0	DOOR LOWER FRAME SHAPE 860 MM	1	PZ																																																										
OB1126A1		1	PZ																																																										
RC1200A0	ED=4 WIRE D.=0.5 COMPRESSIO N SPRING	2	PZ																																																										
VI1220A1	4,2X12 TCB SELF-TAPPIN G SCREW	1	PZ																																																										
VI1996A0	M5X35 SCREW	7	PZ																																																										
VM1794A0	250X4.8 PA66 BLACK CLAMP	2	PZ																																																										
VM2103A0	CLAMP LOCK	2	PZ																																																										
VM2259A1	6 SERIES DOOR LOWER LEFT CAP	1	PZ																																																										
VM2261A1	6 SERIES DOOR LOWER RIGHT CAP	1	PZ																																																										
VM2267A0	INTERNAL GLASS LOCKING SYSTEM SLIDER	1	PZ																																																										
VM2269A0	INTERNAL GLASS LOCKING SYSTEM CAP	1	PZ																																																										
VM2274A0	GROOVED BUSHING	1	PZ																																																										
VM2305A0	6 SERIES DOOR CAP FIXING PAWL	7	PZ																																																										
			K0B1126AL	EU AND 2/1 MM LEFT DOOR LOWER BEAM KIT	<table border="1"> <thead> <tr> <th>Code</th> <th>Description</th> <th>Qty</th> <th>UOM</th> </tr> </thead> <tbody> <tr> <td>OB1126A0</td> <td>DOOR LOWER FRAME SHAPE 860 MM</td> <td>1</td> <td>PZ</td> </tr> <tr> <td>OB1126A1</td> <td></td> <td>1</td> <td>PZ</td> </tr> <tr> <td>RC1200A0</td> <td>ED=4 WIRE D.=0.5 COMPRESSIO N SPRING</td> <td>2</td> <td>PZ</td> </tr> <tr> <td>VI1220A1</td> <td>4,2X12 TCB SELF-TAPPIN G SCREW</td> <td>1</td> <td>PZ</td> </tr> <tr> <td>VI1996A0</td> <td>M5X35 SCREW</td> <td>7</td> <td>PZ</td> </tr> <tr> <td>VM1794A0</td> <td>250X4.8 PA66 BLACK CLAMP</td> <td>2</td> <td>PZ</td> </tr> <tr> <td>VM2103A0</td> <td>CLAMP LOCK</td> <td>2</td> <td>PZ</td> </tr> </tbody> </table>	Code	Description	Qty	UOM	OB1126A0	DOOR LOWER FRAME SHAPE 860 MM	1	PZ	OB1126A1		1	PZ	RC1200A0	ED=4 WIRE D.=0.5 COMPRESSIO N SPRING	2	PZ	VI1220A1	4,2X12 TCB SELF-TAPPIN G SCREW	1	PZ	VI1996A0	M5X35 SCREW	7	PZ	VM1794A0	250X4.8 PA66 BLACK CLAMP	2	PZ	VM2103A0	CLAMP LOCK	2	PZ																								
Code	Description	Qty	UOM																																																										
OB1126A0	DOOR LOWER FRAME SHAPE 860 MM	1	PZ																																																										
OB1126A1		1	PZ																																																										
RC1200A0	ED=4 WIRE D.=0.5 COMPRESSIO N SPRING	2	PZ																																																										
VI1220A1	4,2X12 TCB SELF-TAPPIN G SCREW	1	PZ																																																										
VI1996A0	M5X35 SCREW	7	PZ																																																										
VM1794A0	250X4.8 PA66 BLACK CLAMP	2	PZ																																																										
VM2103A0	CLAMP LOCK	2	PZ																																																										

COMPONENT			SPARE PART																																						
Code	Description	Image	Code	Description	Components list																																				
0B1126A			K0B1126AL	EU AND 2/1 MM LEFT DOOR LOWER BEAM KIT	<table border="1"> <thead> <tr> <th>Code</th> <th>Description</th> <th>Qty</th> <th>UOM</th> </tr> </thead> <tbody> <tr> <td>VM2267A0</td> <td>INTERNAL GLASS LOCKING SYSTEM SLIDER</td> <td>1</td> <td>PZ</td> </tr> <tr> <td>VM2269A0</td> <td>INTERNAL GLASS LOCKING SYSTEM CAP</td> <td>1</td> <td>PZ</td> </tr> <tr> <td>VM2274A0</td> <td>GROOVED BUSHING</td> <td>1</td> <td>PZ</td> </tr> <tr> <td>VM2305A0</td> <td>6 SERIES DOOR CAP FIXING PAWL</td> <td>7</td> <td>PZ</td> </tr> <tr> <td>VM2384A0</td> <td>MM LEFT DOOR RIGHT LOWER CAP</td> <td>1</td> <td>PZ</td> </tr> <tr> <td>VM2384A0</td> <td>MM LEFT DOOR RIGHT LOWER CAP</td> <td>1</td> <td>PZ</td> </tr> <tr> <td>VM2386A1</td> <td>LEFT MM DOOR LOWER LEFT CAP</td> <td>1</td> <td>PZ</td> </tr> <tr> <td>VM2386A1</td> <td>LEFT MM DOOR LOWER LEFT CAP</td> <td>1</td> <td>PZ</td> </tr> </tbody> </table>	Code	Description	Qty	UOM	VM2267A0	INTERNAL GLASS LOCKING SYSTEM SLIDER	1	PZ	VM2269A0	INTERNAL GLASS LOCKING SYSTEM CAP	1	PZ	VM2274A0	GROOVED BUSHING	1	PZ	VM2305A0	6 SERIES DOOR CAP FIXING PAWL	7	PZ	VM2384A0	MM LEFT DOOR RIGHT LOWER CAP	1	PZ	VM2384A0	MM LEFT DOOR RIGHT LOWER CAP	1	PZ	VM2386A1	LEFT MM DOOR LOWER LEFT CAP	1	PZ	VM2386A1	LEFT MM DOOR LOWER LEFT CAP	1	PZ
Code	Description	Qty	UOM																																						
VM2267A0	INTERNAL GLASS LOCKING SYSTEM SLIDER	1	PZ																																						
VM2269A0	INTERNAL GLASS LOCKING SYSTEM CAP	1	PZ																																						
VM2274A0	GROOVED BUSHING	1	PZ																																						
VM2305A0	6 SERIES DOOR CAP FIXING PAWL	7	PZ																																						
VM2384A0	MM LEFT DOOR RIGHT LOWER CAP	1	PZ																																						
VM2384A0	MM LEFT DOOR RIGHT LOWER CAP	1	PZ																																						
VM2386A1	LEFT MM DOOR LOWER LEFT CAP	1	PZ																																						
VM2386A1	LEFT MM DOOR LOWER LEFT CAP	1	PZ																																						
0B1175A	XEBC-06EU-E LEFT EXT DOOR COLUMN		0B1175A0	XEBC-06EU-E LEFT EXT DOOR COLUMN																																					
0B1218A			0B1218A1																																						

COMPONENT			SPARE PART																																		
Code	Description	Image	Code	Description	Components list																																
CR1103A	INTERNAL GLASS ST. STEEL UPPER HINGE		XRF033	MM ONE INT GLASS HINGES RETROFIT KIT	<table border="1"> <thead> <tr> <th>Code</th> <th>Description</th> <th>Qty</th> <th>UOM</th> </tr> </thead> <tbody> <tr> <td>0H1928A0</td> <td></td> <td>1</td> <td>PZ</td> </tr> <tr> <td>CR1103A0</td> <td>INTERNAL GLASS ST. STEEL UPPER HINGE</td> <td>1</td> <td>PZ</td> </tr> <tr> <td>CR1104A0</td> <td>INTERNAL GLASS ST. STEEL LOWER HINGE</td> <td>1</td> <td>PZ</td> </tr> <tr> <td>GN1182A1</td> <td>INTERNAL GLASS HINGE</td> <td>2</td> <td>PZ</td> </tr> <tr> <td>VI1810A0</td> <td>M6X6 STAINLESS STEEL FLATHEAD SCREW</td> <td>6</td> <td>PZ</td> </tr> <tr> <td>VM1224A0</td> <td></td> <td>0.300</td> <td>M</td> </tr> <tr> <td>VM2399A0</td> <td>DOOR HINGES HEADLESS SCREWS COVER</td> <td>2</td> <td>PZ</td> </tr> </tbody> </table>	Code	Description	Qty	UOM	0H1928A0		1	PZ	CR1103A0	INTERNAL GLASS ST. STEEL UPPER HINGE	1	PZ	CR1104A0	INTERNAL GLASS ST. STEEL LOWER HINGE	1	PZ	GN1182A1	INTERNAL GLASS HINGE	2	PZ	VI1810A0	M6X6 STAINLESS STEEL FLATHEAD SCREW	6	PZ	VM1224A0		0.300	M	VM2399A0	DOOR HINGES HEADLESS SCREWS COVER	2	PZ
					Code	Description	Qty	UOM																													
					0H1928A0		1	PZ																													
					CR1103A0	INTERNAL GLASS ST. STEEL UPPER HINGE	1	PZ																													
					CR1104A0	INTERNAL GLASS ST. STEEL LOWER HINGE	1	PZ																													
					GN1182A1	INTERNAL GLASS HINGE	2	PZ																													
					VI1810A0	M6X6 STAINLESS STEEL FLATHEAD SCREW	6	PZ																													
					VM1224A0		0.300	M																													
					VM2399A0	DOOR HINGES HEADLESS SCREWS COVER	2	PZ																													
					VM2399A	DOOR HINGES HEADLESS SCREWS COVER		VM2399A0	DOOR HINGES HEADLESS SCREWS COVER																												
VM2476A	BL SP H6 INTERNAL GLASS HINGE GASKET		KVM2476A	INTERNAL GLASS HINGE SEAL 2PCS KIT	<table border="1"> <thead> <tr> <th>Code</th> <th>Description</th> <th>Qty</th> <th>UOM</th> </tr> </thead> <tbody> <tr> <td>SL1045A0</td> <td>S57 BLACK SILICONE - 80ML CARTRIDGE</td> <td>1</td> <td>PZ</td> </tr> <tr> <td>VM2476A0</td> <td>BL SP H6 INTERNAL GLASS HINGE GASKET</td> <td>2</td> <td>PZ</td> </tr> <tr> <td>VM2476A0</td> <td>BL SP H6 INTERNAL GLASS HINGE GASKET</td> <td>2</td> <td>PZ</td> </tr> </tbody> </table>	Code	Description	Qty	UOM	SL1045A0	S57 BLACK SILICONE - 80ML CARTRIDGE	1	PZ	VM2476A0	BL SP H6 INTERNAL GLASS HINGE GASKET	2	PZ	VM2476A0	BL SP H6 INTERNAL GLASS HINGE GASKET	2	PZ																
					Code	Description	Qty	UOM																													
					SL1045A0	S57 BLACK SILICONE - 80ML CARTRIDGE	1	PZ																													
VM2476A0	BL SP H6 INTERNAL GLASS HINGE GASKET	2	PZ																																		
VM2476A0	BL SP H6 INTERNAL GLASS HINGE GASKET	2	PZ																																		

COMPONENT			SPARE PART																																		
Code	Description	Image	Code	Description	Components list																																
CR1104A	INTERNAL GLASS ST. STEEL LOWER HINGE		XRF033	MM ONE INT GLASS HINGES RETROFIT KIT	<table border="1"> <thead> <tr> <th>Code</th> <th>Description</th> <th>Qty</th> <th>UOM</th> </tr> </thead> <tbody> <tr> <td>0H1928A0</td> <td></td> <td>1</td> <td>PZ</td> </tr> <tr> <td>CR1103A0</td> <td>INTERNAL GLASS ST. STEEL UPPER HINGE</td> <td>1</td> <td>PZ</td> </tr> <tr> <td>CR1104A0</td> <td>INTERNAL GLASS ST. STEEL LOWER HINGE</td> <td>1</td> <td>PZ</td> </tr> <tr> <td>GN1182A1</td> <td>INTERNAL GLASS HINGE</td> <td>2</td> <td>PZ</td> </tr> <tr> <td>VI1810A0</td> <td>M6X6 STAINLESS STEEL FLATHEAD SCREW</td> <td>6</td> <td>PZ</td> </tr> <tr> <td>VM1224A0</td> <td></td> <td>0.300</td> <td>M</td> </tr> <tr> <td>VM2399A0</td> <td>DOOR HINGES HEADLESS SCREWS COVER</td> <td>2</td> <td>PZ</td> </tr> </tbody> </table>	Code	Description	Qty	UOM	0H1928A0		1	PZ	CR1103A0	INTERNAL GLASS ST. STEEL UPPER HINGE	1	PZ	CR1104A0	INTERNAL GLASS ST. STEEL LOWER HINGE	1	PZ	GN1182A1	INTERNAL GLASS HINGE	2	PZ	VI1810A0	M6X6 STAINLESS STEEL FLATHEAD SCREW	6	PZ	VM1224A0		0.300	M	VM2399A0	DOOR HINGES HEADLESS SCREWS COVER	2	PZ
Code	Description	Qty	UOM																																		
0H1928A0		1	PZ																																		
CR1103A0	INTERNAL GLASS ST. STEEL UPPER HINGE	1	PZ																																		
CR1104A0	INTERNAL GLASS ST. STEEL LOWER HINGE	1	PZ																																		
GN1182A1	INTERNAL GLASS HINGE	2	PZ																																		
VI1810A0	M6X6 STAINLESS STEEL FLATHEAD SCREW	6	PZ																																		
VM1224A0		0.300	M																																		
VM2399A0	DOOR HINGES HEADLESS SCREWS COVER	2	PZ																																		
VM2399A	DOOR HINGES HEADLESS SCREWS COVER		VM2399A0	DOOR HINGES HEADLESS SCREWS COVER																																	
VM2476A	BL SP H6 INTERNAL GLASS HINGE GASKET		KVM2476A	INTERNAL GLASS HINGE SEAL 2PCS KIT	<table border="1"> <thead> <tr> <th>Code</th> <th>Description</th> <th>Qty</th> <th>UOM</th> </tr> </thead> <tbody> <tr> <td>SL1045A0</td> <td>S57 BLACK SILICONE - 80ML CARTRIDGE</td> <td>1</td> <td>PZ</td> </tr> <tr> <td>VM2476A0</td> <td>BL SP H6 INTERNAL GLASS HINGE GASKET</td> <td>2</td> <td>PZ</td> </tr> <tr> <td>VM2476A0</td> <td>BL SP H6 INTERNAL GLASS HINGE GASKET</td> <td>2</td> <td>PZ</td> </tr> </tbody> </table>	Code	Description	Qty	UOM	SL1045A0	S57 BLACK SILICONE - 80ML CARTRIDGE	1	PZ	VM2476A0	BL SP H6 INTERNAL GLASS HINGE GASKET	2	PZ	VM2476A0	BL SP H6 INTERNAL GLASS HINGE GASKET	2	PZ																
Code	Description	Qty	UOM																																		
SL1045A0	S57 BLACK SILICONE - 80ML CARTRIDGE	1	PZ																																		
VM2476A0	BL SP H6 INTERNAL GLASS HINGE GASKET	2	PZ																																		
VM2476A0	BL SP H6 INTERNAL GLASS HINGE GASKET	2	PZ																																		

COMPONENT			SPARE PART																																																										
Code	Description	Image	Code	Description	Components list																																																								
VT1294B			KVT1294B	06EU INTERNAL SINGLE GLASS KIT	<table border="1"> <thead> <tr> <th>Code</th> <th>Description</th> <th>Qty</th> <th>UOM</th> </tr> </thead> <tbody> <tr> <td>IP1508A1</td> <td>POLYSTYREN E U SHAPED PROFILE 2000X60X60</td> <td>1</td> <td>M</td> </tr> <tr> <td>VM1059A1</td> <td>HEAT SHRINK FILM H800</td> <td>1.500</td> <td>M</td> </tr> <tr> <td>VT1294B0</td> <td></td> <td>1</td> <td>PZ</td> </tr> </tbody> </table>	Code	Description	Qty	UOM	IP1508A1	POLYSTYREN E U SHAPED PROFILE 2000X60X60	1	M	VM1059A1	HEAT SHRINK FILM H800	1.500	M	VT1294B0		1	PZ																																								
Code	Description	Qty	UOM																																																										
IP1508A1	POLYSTYREN E U SHAPED PROFILE 2000X60X60	1	M																																																										
VM1059A1	HEAT SHRINK FILM H800	1.500	M																																																										
VT1294B0		1	PZ																																																										
MG1083A	MIND.MAPS DOOR COMPLETE HANDLE		KMG1083A	MIND.MAPS SERIES HANDLE KIT	<table border="1"> <thead> <tr> <th>Code</th> <th>Description</th> <th>Qty</th> <th>UOM</th> </tr> </thead> <tbody> <tr> <td>0H7321A0</td> <td>MM STAINLESS STEEL HANDLE COVE</td> <td>1</td> <td>PZ</td> </tr> <tr> <td>RC1200A0</td> <td>ED=4 WIRE D=0.5 COMPRESSIO N SPRING</td> <td>4</td> <td>PZ</td> </tr> <tr> <td>VI0239A1</td> <td>SELF-TAPPIN G SCREW 4.2X25 TCB+ INOX</td> <td>8</td> <td>PZ</td> </tr> <tr> <td>VI1220A1</td> <td>4,2X12 TCB SELF-TAPPIN G SCREW</td> <td>2</td> <td>PZ</td> </tr> <tr> <td>VM1182B1</td> <td>E S. CT BT HANDLE JUNCTION + PIN GUIDE</td> <td>1</td> <td>PZ</td> </tr> <tr> <td>VM1183B0</td> <td>CHEFTOP/BAK ERTOP HANDLE PIN</td> <td>1</td> <td>PZ</td> </tr> <tr> <td>VM1183B1</td> <td>CT BT HANDLE PIN</td> <td>1</td> <td>PZ</td> </tr> <tr> <td>VM1183C0</td> <td>CT BT HANDLE T-SHAPED PIN KIT</td> <td>1</td> <td>PZ</td> </tr> <tr> <td>VM1490A0</td> <td>CHEFTOP/BAK ERTOP HANDLE SCREWS COVER</td> <td>2</td> <td>PZ</td> </tr> <tr> <td>VM1695A0</td> <td>HANDLE POSITION PIN</td> <td>4</td> <td>PZ</td> </tr> <tr> <td>VM2245A0</td> <td>HANDLE SHAFT WITH LATCH</td> <td>1</td> <td>PZ</td> </tr> <tr> <td>VM2247A0</td> <td>HANDLE SHAFT COVER VM2245-2246</td> <td>1</td> <td>PZ</td> </tr> <tr> <td>VM2247B0</td> <td>HANDLE SHAFT COVER VM2245-2246</td> <td>1</td> <td>PZ</td> </tr> </tbody> </table>	Code	Description	Qty	UOM	0H7321A0	MM STAINLESS STEEL HANDLE COVE	1	PZ	RC1200A0	ED=4 WIRE D=0.5 COMPRESSIO N SPRING	4	PZ	VI0239A1	SELF-TAPPIN G SCREW 4.2X25 TCB+ INOX	8	PZ	VI1220A1	4,2X12 TCB SELF-TAPPIN G SCREW	2	PZ	VM1182B1	E S. CT BT HANDLE JUNCTION + PIN GUIDE	1	PZ	VM1183B0	CHEFTOP/BAK ERTOP HANDLE PIN	1	PZ	VM1183B1	CT BT HANDLE PIN	1	PZ	VM1183C0	CT BT HANDLE T-SHAPED PIN KIT	1	PZ	VM1490A0	CHEFTOP/BAK ERTOP HANDLE SCREWS COVER	2	PZ	VM1695A0	HANDLE POSITION PIN	4	PZ	VM2245A0	HANDLE SHAFT WITH LATCH	1	PZ	VM2247A0	HANDLE SHAFT COVER VM2245-2246	1	PZ	VM2247B0	HANDLE SHAFT COVER VM2245-2246	1	PZ
Code	Description	Qty	UOM																																																										
0H7321A0	MM STAINLESS STEEL HANDLE COVE	1	PZ																																																										
RC1200A0	ED=4 WIRE D=0.5 COMPRESSIO N SPRING	4	PZ																																																										
VI0239A1	SELF-TAPPIN G SCREW 4.2X25 TCB+ INOX	8	PZ																																																										
VI1220A1	4,2X12 TCB SELF-TAPPIN G SCREW	2	PZ																																																										
VM1182B1	E S. CT BT HANDLE JUNCTION + PIN GUIDE	1	PZ																																																										
VM1183B0	CHEFTOP/BAK ERTOP HANDLE PIN	1	PZ																																																										
VM1183B1	CT BT HANDLE PIN	1	PZ																																																										
VM1183C0	CT BT HANDLE T-SHAPED PIN KIT	1	PZ																																																										
VM1490A0	CHEFTOP/BAK ERTOP HANDLE SCREWS COVER	2	PZ																																																										
VM1695A0	HANDLE POSITION PIN	4	PZ																																																										
VM2245A0	HANDLE SHAFT WITH LATCH	1	PZ																																																										
VM2247A0	HANDLE SHAFT COVER VM2245-2246	1	PZ																																																										
VM2247B0	HANDLE SHAFT COVER VM2245-2246	1	PZ																																																										



COMPONENT			SPARE PART														
Code	Description	Image	Code	Description	Components list												
MG1083A	MIND.MAPS DOOR COMPLETE HANDLE		KMG1083A	MIND.MAPS SERIES HANDLE KIT	<table border="1"> <thead> <tr> <th>Code</th> <th>Description</th> <th>Qty</th> <th>UOM</th> </tr> </thead> <tbody> <tr> <td>VM2248B0</td> <td>HANDLE WITH LATCH CLOSING KEY</td> <td>1</td> <td>PZ</td> </tr> <tr> <td>VM2295A0</td> <td>STYLUS PEN FOR MM</td> <td>1</td> <td>PZ</td> </tr> </tbody> </table>	Code	Description	Qty	UOM	VM2248B0	HANDLE WITH LATCH CLOSING KEY	1	PZ	VM2295A0	STYLUS PEN FOR MM	1	PZ
Code	Description	Qty	UOM														
VM2248B0	HANDLE WITH LATCH CLOSING KEY	1	PZ														
VM2295A0	STYLUS PEN FOR MM	1	PZ														

ASM1745B/0.D01 - Cooking chamber

FRONT

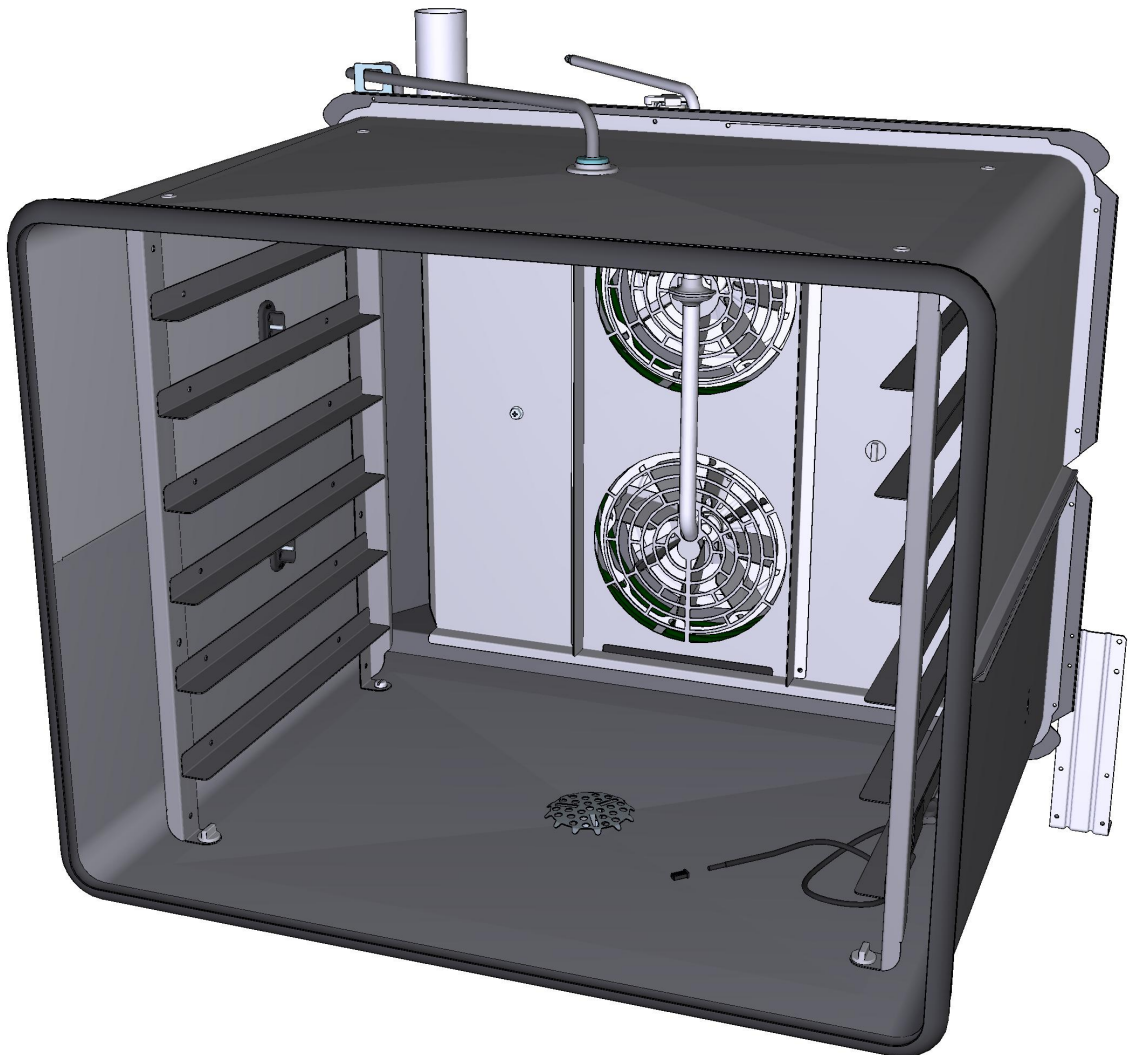

ASM1745B/0.D01 - Cooking chamber

REAR

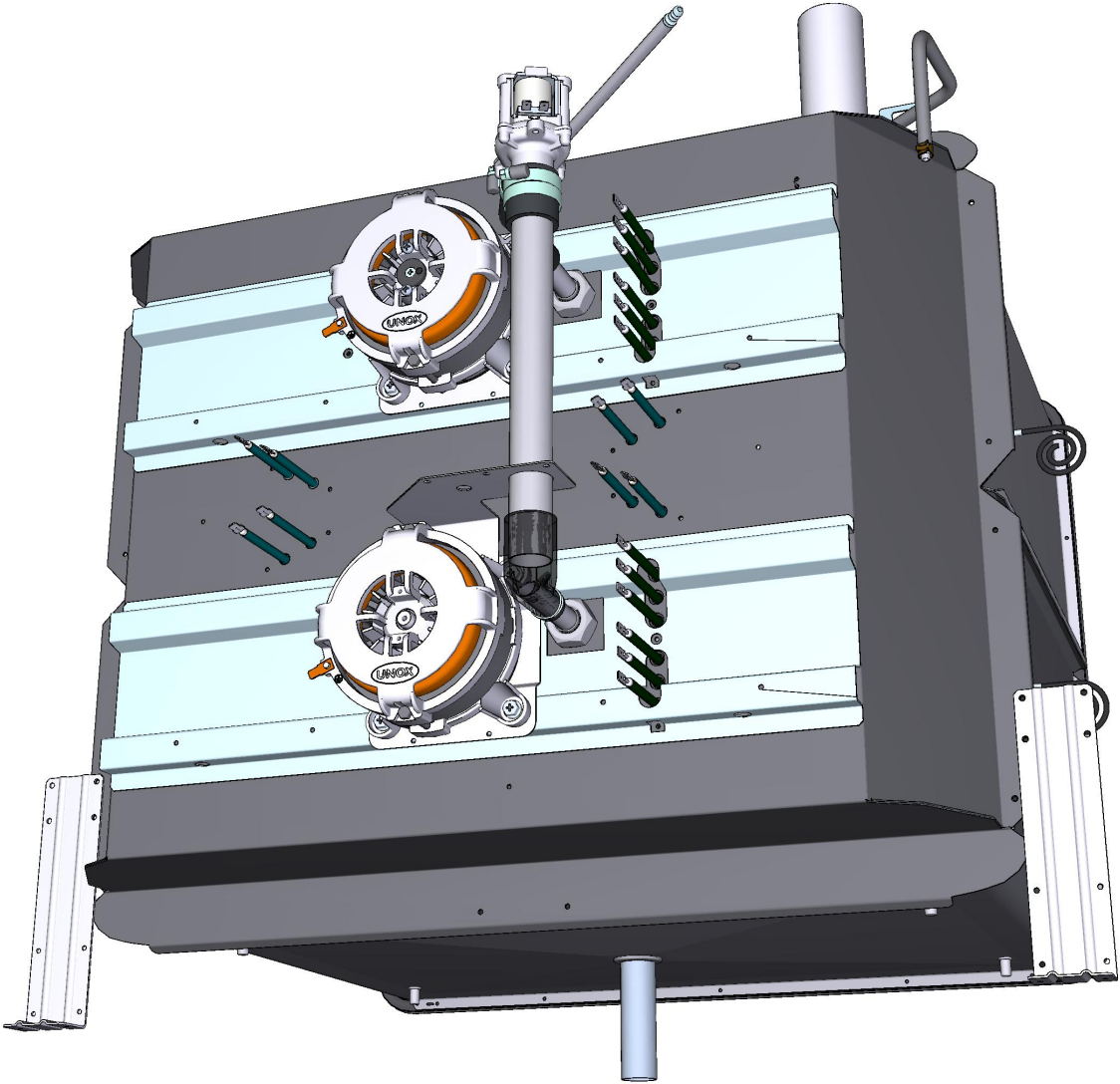

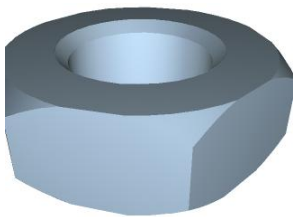
COMPONENT			SPARE PART																																										
Code	Description	Image	Code	Description	Components list																																								
RC1170A	STAINLESS STEEL NUT M14 H=8 CH=22		KRC1170A	M14 H8 CH22 NUT - 10 PCS. KIT	<table border="1"> <thead> <tr> <th>Code</th> <th>Description</th> <th>Qty</th> <th>UOM</th> </tr> </thead> <tbody> <tr> <td>RC1170A1</td> <td>STAINLESS STEEL NUT M14 H=8 CH=22</td> <td>10</td> <td>PZ</td> </tr> <tr> <td>VM1224A0</td> <td></td> <td>0.200</td> <td>M</td> </tr> </tbody> </table>	Code	Description	Qty	UOM	RC1170A1	STAINLESS STEEL NUT M14 H=8 CH=22	10	PZ	VM1224A0		0.200	M																												
Code	Description	Qty	UOM																																										
RC1170A1	STAINLESS STEEL NUT M14 H=8 CH=22	10	PZ																																										
VM1224A0		0.200	M																																										
RS1215A	147W 105V BRAKING ELEMENT		<p>KRS1215A</p> <p>KRS0026A</p>	<p>147W MOTOR BRAKING ELEMENT KIT</p> <p>BIG-L 147W MOTOR BRAKING ELEMENT KIT</p>	<table border="1"> <thead> <tr> <th>Code</th> <th>Description</th> <th>Qty</th> <th>UOM</th> </tr> </thead> <tbody> <tr> <td>GN1326A1</td> <td>ELEMENT SEALING</td> <td>1</td> <td>PZ</td> </tr> <tr> <td>RS1215A1</td> <td>147W 105V BRAKING ELEMENT</td> <td>1</td> <td>PZ</td> </tr> <tr> <td>SL1045A0</td> <td>S57 BLACK SILICONE - 80ML CARTRIDGE</td> <td>1</td> <td>PZ</td> </tr> <tr> <td>VI1220A1</td> <td>4,2X12 TCB SELF-TAPPIN G SCREW</td> <td>2</td> <td>PZ</td> </tr> </tbody> </table> <table border="1"> <thead> <tr> <th>Code</th> <th>Description</th> <th>Qty</th> <th>UOM</th> </tr> </thead> <tbody> <tr> <td>GN1672A0</td> <td></td> <td>1</td> <td>PZ</td> </tr> <tr> <td>RS1215A1</td> <td>147W 105V BRAKING ELEMENT</td> <td>1</td> <td>PZ</td> </tr> <tr> <td>SL1045A0</td> <td>S57 BLACK SILICONE - 80ML CARTRIDGE</td> <td>1</td> <td>PZ</td> </tr> <tr> <td>VI1220A1</td> <td>4,2X12 TCB SELF-TAPPIN G SCREW</td> <td>2</td> <td>PZ</td> </tr> </tbody> </table>	Code	Description	Qty	UOM	GN1326A1	ELEMENT SEALING	1	PZ	RS1215A1	147W 105V BRAKING ELEMENT	1	PZ	SL1045A0	S57 BLACK SILICONE - 80ML CARTRIDGE	1	PZ	VI1220A1	4,2X12 TCB SELF-TAPPIN G SCREW	2	PZ	Code	Description	Qty	UOM	GN1672A0		1	PZ	RS1215A1	147W 105V BRAKING ELEMENT	1	PZ	SL1045A0	S57 BLACK SILICONE - 80ML CARTRIDGE	1	PZ	VI1220A1	4,2X12 TCB SELF-TAPPIN G SCREW	2	PZ
Code	Description	Qty	UOM																																										
GN1326A1	ELEMENT SEALING	1	PZ																																										
RS1215A1	147W 105V BRAKING ELEMENT	1	PZ																																										
SL1045A0	S57 BLACK SILICONE - 80ML CARTRIDGE	1	PZ																																										
VI1220A1	4,2X12 TCB SELF-TAPPIN G SCREW	2	PZ																																										
Code	Description	Qty	UOM																																										
GN1672A0		1	PZ																																										
RS1215A1	147W 105V BRAKING ELEMENT	1	PZ																																										
SL1045A0	S57 BLACK SILICONE - 80ML CARTRIDGE	1	PZ																																										
VI1220A1	4,2X12 TCB SELF-TAPPIN G SCREW	2	PZ																																										
GN1326A	ELEMENT SEALING		KRS1274A	100W MOTOR BRAKING ELEMENT KIT	<table border="1"> <thead> <tr> <th>Code</th> <th>Description</th> <th>Qty</th> <th>UOM</th> </tr> </thead> <tbody> <tr> <td>GN1326A1</td> <td>ELEMENT SEALING</td> <td>1</td> <td>PZ</td> </tr> <tr> <td>RS1274A0</td> <td>100W 60V 1 TURN FLAT ELEMENT</td> <td>1</td> <td>PZ</td> </tr> <tr> <td>SL1045A0</td> <td>S57 BLACK SILICONE - 80ML CARTRIDGE</td> <td>1</td> <td>PZ</td> </tr> <tr> <td>VI1220A1</td> <td>4,2X12 TCB SELF-TAPPIN G SCREW</td> <td>2</td> <td>PZ</td> </tr> </tbody> </table>	Code	Description	Qty	UOM	GN1326A1	ELEMENT SEALING	1	PZ	RS1274A0	100W 60V 1 TURN FLAT ELEMENT	1	PZ	SL1045A0	S57 BLACK SILICONE - 80ML CARTRIDGE	1	PZ	VI1220A1	4,2X12 TCB SELF-TAPPIN G SCREW	2	PZ																				
Code	Description	Qty	UOM																																										
GN1326A1	ELEMENT SEALING	1	PZ																																										
RS1274A0	100W 60V 1 TURN FLAT ELEMENT	1	PZ																																										
SL1045A0	S57 BLACK SILICONE - 80ML CARTRIDGE	1	PZ																																										
VI1220A1	4,2X12 TCB SELF-TAPPIN G SCREW	2	PZ																																										

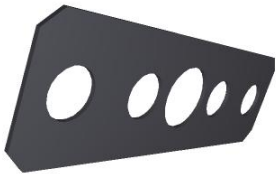

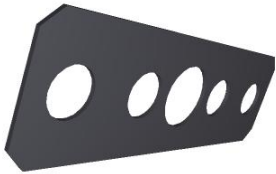
COMPONENT			SPARE PART																														
Code	Description	Image	Code	Description	Components list																												
GN1326A	ELEMENT SEALING		KRS1261A	122W MOTOR BRAKING ELEMENT KIT	<table border="1"> <thead> <tr> <th>Code</th> <th>Description</th> <th>Qty</th> <th>UOM</th> </tr> </thead> <tbody> <tr> <td>GN1326A1</td> <td>ELEMENT SEALING</td> <td>1</td> <td>PZ</td> </tr> <tr> <td>RS1261A0</td> <td>BAKERLUX/CH EFLUX MOTOR BRAKING ELEMENT</td> <td>1</td> <td>PZ</td> </tr> <tr> <td>SL1045A0</td> <td>S57 BLACK SILICONE - 80ML CARTRIDGE</td> <td>1</td> <td>PZ</td> </tr> <tr> <td>VI1220A1</td> <td>4,2X12 TCB SELF-TAPPIN G SCREW</td> <td>2</td> <td>PZ</td> </tr> <tr> <td>VM2147A0</td> <td>410X343X15 MM PINK SMOOTH ESD SPONGE</td> <td>1</td> <td>PZ</td> </tr> </tbody> </table>	Code	Description	Qty	UOM	GN1326A1	ELEMENT SEALING	1	PZ	RS1261A0	BAKERLUX/CH EFLUX MOTOR BRAKING ELEMENT	1	PZ	SL1045A0	S57 BLACK SILICONE - 80ML CARTRIDGE	1	PZ	VI1220A1	4,2X12 TCB SELF-TAPPIN G SCREW	2	PZ	VM2147A0	410X343X15 MM PINK SMOOTH ESD SPONGE	1	PZ				
					Code	Description	Qty	UOM																									
					GN1326A1	ELEMENT SEALING	1	PZ																									
					RS1261A0	BAKERLUX/CH EFLUX MOTOR BRAKING ELEMENT	1	PZ																									
					SL1045A0	S57 BLACK SILICONE - 80ML CARTRIDGE	1	PZ																									
					VI1220A1	4,2X12 TCB SELF-TAPPIN G SCREW	2	PZ																									
					VM2147A0	410X343X15 MM PINK SMOOTH ESD SPONGE	1	PZ																									
					KRS1215A	147W MOTOR BRAKING ELEMENT KIT	<table border="1"> <thead> <tr> <th>Code</th> <th>Description</th> <th>Qty</th> <th>UOM</th> </tr> </thead> <tbody> <tr> <td>GN1326A1</td> <td>ELEMENT SEALING</td> <td>1</td> <td>PZ</td> </tr> <tr> <td>RS1215A1</td> <td>147W 105V BRAKING ELEMENT</td> <td>1</td> <td>PZ</td> </tr> <tr> <td>SL1045A0</td> <td>S57 BLACK SILICONE - 80ML CARTRIDGE</td> <td>1</td> <td>PZ</td> </tr> <tr> <td>VI1220A1</td> <td>4,2X12 TCB SELF-TAPPIN G SCREW</td> <td>2</td> <td>PZ</td> </tr> </tbody> </table>	Code	Description	Qty	UOM	GN1326A1	ELEMENT SEALING	1	PZ	RS1215A1	147W 105V BRAKING ELEMENT	1	PZ	SL1045A0	S57 BLACK SILICONE - 80ML CARTRIDGE	1	PZ	VI1220A1	4,2X12 TCB SELF-TAPPIN G SCREW	2	PZ						
							Code	Description	Qty	UOM																							
			GN1326A1	ELEMENT SEALING			1	PZ																									
			RS1215A1	147W 105V BRAKING ELEMENT			1	PZ																									
			SL1045A0	S57 BLACK SILICONE - 80ML CARTRIDGE			1	PZ																									
			VI1220A1	4,2X12 TCB SELF-TAPPIN G SCREW			2	PZ																									
			KRS1095A	1.2KW HEATING ELEMENT KIT	<table border="1"> <thead> <tr> <th>Code</th> <th>Description</th> <th>Qty</th> <th>UOM</th> </tr> </thead> <tbody> <tr> <td>GN1326A1</td> <td>ELEMENT SEALING</td> <td>1</td> <td>PZ</td> </tr> <tr> <td>IP1385A1</td> <td>CORNER POLYSTYREN E PACKING 110X80X2000</td> <td>0.500</td> <td>M</td> </tr> <tr> <td>RS1095A1</td> <td>HEATING ELEMENT 1200W 230V</td> <td>1</td> <td>PZ</td> </tr> <tr> <td>SL1045A0</td> <td>S57 BLACK SILICONE - 80ML CARTRIDGE</td> <td>1</td> <td>PZ</td> </tr> <tr> <td>VI1220A1</td> <td>4,2X12 TCB SELF-TAPPIN G SCREW</td> <td>2</td> <td>PZ</td> </tr> <tr> <td>VM1059A1</td> <td>HEAT SHRINK FILM H800</td> <td>1.200</td> <td>M</td> </tr> </tbody> </table>	Code	Description	Qty	UOM	GN1326A1	ELEMENT SEALING	1	PZ	IP1385A1	CORNER POLYSTYREN E PACKING 110X80X2000	0.500	M	RS1095A1	HEATING ELEMENT 1200W 230V	1	PZ	SL1045A0	S57 BLACK SILICONE - 80ML CARTRIDGE	1	PZ	VI1220A1	4,2X12 TCB SELF-TAPPIN G SCREW	2	PZ	VM1059A1	HEAT SHRINK FILM H800	1.200	M
					Code	Description	Qty	UOM																									
GN1326A1	ELEMENT SEALING	1			PZ																												
IP1385A1	CORNER POLYSTYREN E PACKING 110X80X2000	0.500			M																												
RS1095A1	HEATING ELEMENT 1200W 230V	1			PZ																												
SL1045A0	S57 BLACK SILICONE - 80ML CARTRIDGE	1			PZ																												
VI1220A1	4,2X12 TCB SELF-TAPPIN G SCREW	2			PZ																												
VM1059A1	HEAT SHRINK FILM H800	1.200			M																												

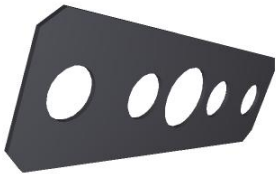
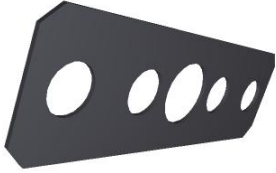

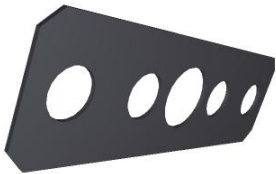
COMPONENT			SPARE PART																														
Code	Description	Image	Code	Description	Components list																												
GN1326A	ELEMENT SEALING		KRS1012A	1365W 120V HEATING ELEMENT KIT	<table border="1"> <thead> <tr> <th>Code</th> <th>Description</th> <th>Qty</th> <th>UOM</th> </tr> </thead> <tbody> <tr> <td>GN1326A1</td> <td>ELEMENT SEALING</td> <td>1</td> <td>PZ</td> </tr> <tr> <td>RS1012A0</td> <td>CIRCULAR ELEMENT 1365W 120V</td> <td>1</td> <td>PZ</td> </tr> <tr> <td>VI1220A1</td> <td>4,2X12 TCB SELF-TAPPIN G SCREW</td> <td>5</td> <td>PZ</td> </tr> <tr> <td>VM1794A0</td> <td>250X4.8 PA66 BLACK CLAMP</td> <td>2</td> <td>PZ</td> </tr> <tr> <td>VM2103A0</td> <td>CLAMP LOCK</td> <td>2</td> <td>PZ</td> </tr> </tbody> </table>	Code	Description	Qty	UOM	GN1326A1	ELEMENT SEALING	1	PZ	RS1012A0	CIRCULAR ELEMENT 1365W 120V	1	PZ	VI1220A1	4,2X12 TCB SELF-TAPPIN G SCREW	5	PZ	VM1794A0	250X4.8 PA66 BLACK CLAMP	2	PZ	VM2103A0	CLAMP LOCK	2	PZ				
			Code	Description	Qty	UOM																											
			GN1326A1	ELEMENT SEALING	1	PZ																											
			RS1012A0	CIRCULAR ELEMENT 1365W 120V	1	PZ																											
			VI1220A1	4,2X12 TCB SELF-TAPPIN G SCREW	5	PZ																											
			VM1794A0	250X4.8 PA66 BLACK CLAMP	2	PZ																											
			VM2103A0	CLAMP LOCK	2	PZ																											
			KRS1011A	ROBERTA/LISA HEATING ELEMENT KIT	<table border="1"> <thead> <tr> <th>Code</th> <th>Description</th> <th>Qty</th> <th>UOM</th> </tr> </thead> <tbody> <tr> <td>GN1326A1</td> <td>ELEMENT SEALING</td> <td>1</td> <td>PZ</td> </tr> <tr> <td>RS1011A0</td> <td>2560W 220-230V HEATING ELEMENT</td> <td>1</td> <td>PZ</td> </tr> <tr> <td>SL1045A0</td> <td>S57 BLACK SILICONE - 80ML CARTRIDGE</td> <td>1</td> <td>PZ</td> </tr> <tr> <td>VI1220A1</td> <td>4,2X12 TCB SELF-TAPPIN G SCREW</td> <td>5</td> <td>PZ</td> </tr> <tr> <td>VM1794A0</td> <td>250X4.8 PA66 BLACK CLAMP</td> <td>2</td> <td>PZ</td> </tr> <tr> <td>VM2103A0</td> <td>CLAMP LOCK</td> <td>2</td> <td>PZ</td> </tr> </tbody> </table>	Code	Description	Qty	UOM	GN1326A1	ELEMENT SEALING	1	PZ	RS1011A0	2560W 220-230V HEATING ELEMENT	1	PZ	SL1045A0	S57 BLACK SILICONE - 80ML CARTRIDGE	1	PZ	VI1220A1	4,2X12 TCB SELF-TAPPIN G SCREW	5	PZ	VM1794A0	250X4.8 PA66 BLACK CLAMP	2	PZ	VM2103A0	CLAMP LOCK	2	PZ
			Code	Description	Qty	UOM																											
			GN1326A1	ELEMENT SEALING	1	PZ																											
			RS1011A0	2560W 220-230V HEATING ELEMENT	1	PZ																											
			SL1045A0	S57 BLACK SILICONE - 80ML CARTRIDGE	1	PZ																											
VI1220A1	4,2X12 TCB SELF-TAPPIN G SCREW	5	PZ																														
VM1794A0	250X4.8 PA66 BLACK CLAMP	2	PZ																														
VM2103A0	CLAMP LOCK	2	PZ																														
KRS0090A	HEATING ELEMENT 1.26KW	<table border="1"> <thead> <tr> <th>Code</th> <th>Description</th> <th>Qty</th> <th>UOM</th> </tr> </thead> <tbody> <tr> <td>GN1326A1</td> <td>ELEMENT SEALING</td> <td>1</td> <td>PZ</td> </tr> <tr> <td>RS0090A0</td> <td>CIRC. HEAT. ELEMENT 1260W 220-230</td> <td>1</td> <td>PZ</td> </tr> <tr> <td>VI1220A1</td> <td>4,2X12 TCB SELF-TAPPIN G SCREW</td> <td>3</td> <td>PZ</td> </tr> <tr> <td>VM1794A0</td> <td>250X4.8 PA66 BLACK CLAMP</td> <td>2</td> <td>PZ</td> </tr> <tr> <td>VM2103A0</td> <td>CLAMP LOCK</td> <td>2</td> <td>PZ</td> </tr> </tbody> </table>	Code	Description	Qty	UOM	GN1326A1	ELEMENT SEALING	1	PZ	RS0090A0	CIRC. HEAT. ELEMENT 1260W 220-230	1	PZ	VI1220A1	4,2X12 TCB SELF-TAPPIN G SCREW	3	PZ	VM1794A0	250X4.8 PA66 BLACK CLAMP	2	PZ	VM2103A0	CLAMP LOCK	2	PZ							
Code	Description	Qty	UOM																														
GN1326A1	ELEMENT SEALING	1	PZ																														
RS0090A0	CIRC. HEAT. ELEMENT 1260W 220-230	1	PZ																														
VI1220A1	4,2X12 TCB SELF-TAPPIN G SCREW	3	PZ																														
VM1794A0	250X4.8 PA66 BLACK CLAMP	2	PZ																														
VM2103A0	CLAMP LOCK	2	PZ																														
KRS0050A	HEATING ELEMENT KIT 0.5KW	<table border="1"> <thead> <tr> <th>Code</th> <th>Description</th> <th>Qty</th> <th>UOM</th> </tr> </thead> <tbody> <tr> <td>GN1326A1</td> <td>ELEMENT SEALING</td> <td>1</td> <td>PZ</td> </tr> <tr> <td>IP1075A1</td> <td></td> <td>1</td> <td>PZ</td> </tr> <tr> <td>IP1080A1</td> <td></td> <td>1</td> <td>PZ</td> </tr> <tr> <td>RS0050A0</td> <td>HEAT. ELEMENT 500W 220-230V LIEV</td> <td>1</td> <td>PZ</td> </tr> <tr> <td>VI1220A1</td> <td>4,2X12 TCB SELF-TAPPIN G SCREW</td> <td>2</td> <td>PZ</td> </tr> </tbody> </table>	Code	Description	Qty	UOM	GN1326A1	ELEMENT SEALING	1	PZ	IP1075A1		1	PZ	IP1080A1		1	PZ	RS0050A0	HEAT. ELEMENT 500W 220-230V LIEV	1	PZ	VI1220A1	4,2X12 TCB SELF-TAPPIN G SCREW	2	PZ							
Code	Description	Qty	UOM																														
GN1326A1	ELEMENT SEALING	1	PZ																														
IP1075A1		1	PZ																														
IP1080A1		1	PZ																														
RS0050A0	HEAT. ELEMENT 500W 220-230V LIEV	1	PZ																														
VI1220A1	4,2X12 TCB SELF-TAPPIN G SCREW	2	PZ																														

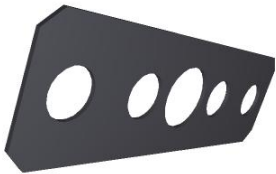

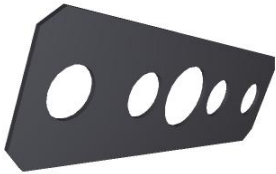

COMPONENT			SPARE PART																										
Code	Description	Image	Code	Description	Components list																								
GN1326A	ELEMENT SEALING		KRS0011A	HEATING ELEMENT 1.465KW RS0011A	<table border="1"> <thead> <tr> <th>Code</th> <th>Description</th> <th>Qty</th> <th>UOM</th> </tr> </thead> <tbody> <tr> <td>GN1326A1</td> <td>ELEMENT SEALING</td> <td>1</td> <td>PZ</td> </tr> <tr> <td>RS0011A0</td> <td>CIRC.HEAT. ELEMENT 1465W 220-230</td> <td>1</td> <td>PZ</td> </tr> <tr> <td>VI1220A1</td> <td>4,2X12 TCB SELF-TAPPIN G SCREW</td> <td>3</td> <td>PZ</td> </tr> <tr> <td>VM1794A0</td> <td>250X4.8 PA66 BLACK CLAMP</td> <td>2</td> <td>PZ</td> </tr> <tr> <td>VM2103A0</td> <td>CLAMP LOCK</td> <td>2</td> <td>PZ</td> </tr> </tbody> </table>	Code	Description	Qty	UOM	GN1326A1	ELEMENT SEALING	1	PZ	RS0011A0	CIRC.HEAT. ELEMENT 1465W 220-230	1	PZ	VI1220A1	4,2X12 TCB SELF-TAPPIN G SCREW	3	PZ	VM1794A0	250X4.8 PA66 BLACK CLAMP	2	PZ	VM2103A0	CLAMP LOCK	2	PZ
			Code	Description	Qty	UOM																							
			GN1326A1	ELEMENT SEALING	1	PZ																							
RS0011A0	CIRC.HEAT. ELEMENT 1465W 220-230	1	PZ																										
VI1220A1	4,2X12 TCB SELF-TAPPIN G SCREW	3	PZ																										
VM1794A0	250X4.8 PA66 BLACK CLAMP	2	PZ																										
VM2103A0	CLAMP LOCK	2	PZ																										
KRS0010A	KIT HEATING ELEMENT RS10010A	<table border="1"> <thead> <tr> <th>Code</th> <th>Description</th> <th>Qty</th> <th>UOM</th> </tr> </thead> <tbody> <tr> <td>GN1326A1</td> <td>ELEMENT SEALING</td> <td>1</td> <td>PZ</td> </tr> <tr> <td>IP1075A1</td> <td></td> <td>1</td> <td>PZ</td> </tr> <tr> <td>IP1080A1</td> <td></td> <td>5</td> <td>PZ</td> </tr> <tr> <td>RS0010A0</td> <td>CIRC.HEAT. ELEMENT 2560W - 220-230 V</td> <td>1</td> <td>PZ</td> </tr> <tr> <td>VI1220A1</td> <td>4,2X12 TCB SELF-TAPPIN G SCREW</td> <td>3</td> <td>PZ</td> </tr> </tbody> </table>	Code	Description	Qty	UOM	GN1326A1	ELEMENT SEALING	1	PZ	IP1075A1		1	PZ	IP1080A1		5	PZ	RS0010A0	CIRC.HEAT. ELEMENT 2560W - 220-230 V	1	PZ	VI1220A1	4,2X12 TCB SELF-TAPPIN G SCREW	3	PZ			
Code	Description	Qty	UOM																										
GN1326A1	ELEMENT SEALING	1	PZ																										
IP1075A1		1	PZ																										
IP1080A1		5	PZ																										
RS0010A0	CIRC.HEAT. ELEMENT 2560W - 220-230 V	1	PZ																										
VI1220A1	4,2X12 TCB SELF-TAPPIN G SCREW	3	PZ																										
KGN1326A	HEATING ELEMENT GASKET 5 PCS KIT	<table border="1"> <thead> <tr> <th>Code</th> <th>Description</th> <th>Qty</th> <th>UOM</th> </tr> </thead> <tbody> <tr> <td>GN1326A1</td> <td>ELEMENT SEALING</td> <td>5</td> <td>PZ</td> </tr> <tr> <td>VM1224A0</td> <td></td> <td>0.200</td> <td>M</td> </tr> </tbody> </table>	Code	Description	Qty	UOM	GN1326A1	ELEMENT SEALING	5	PZ	VM1224A0		0.200	M															
Code	Description	Qty	UOM																										
GN1326A1	ELEMENT SEALING	5	PZ																										
VM1224A0		0.200	M																										
GN1326A	ELEMENT SEALING		KRS1274A	100W MOTOR BRAKING ELEMENT KIT	<table border="1"> <thead> <tr> <th>Code</th> <th>Description</th> <th>Qty</th> <th>UOM</th> </tr> </thead> <tbody> <tr> <td>GN1326A1</td> <td>ELEMENT SEALING</td> <td>1</td> <td>PZ</td> </tr> <tr> <td>RS1274A0</td> <td>100W 60V 1 TURN FLAT ELEMENT</td> <td>1</td> <td>PZ</td> </tr> <tr> <td>SL1045A0</td> <td>S57 BLACK SILICONE - 80ML CARTRIDGE</td> <td>1</td> <td>PZ</td> </tr> <tr> <td>VI1220A1</td> <td>4,2X12 TCB SELF-TAPPIN G SCREW</td> <td>2</td> <td>PZ</td> </tr> </tbody> </table>	Code	Description	Qty	UOM	GN1326A1	ELEMENT SEALING	1	PZ	RS1274A0	100W 60V 1 TURN FLAT ELEMENT	1	PZ	SL1045A0	S57 BLACK SILICONE - 80ML CARTRIDGE	1	PZ	VI1220A1	4,2X12 TCB SELF-TAPPIN G SCREW	2	PZ				
			Code	Description	Qty	UOM																							
GN1326A1	ELEMENT SEALING	1	PZ																										
RS1274A0	100W 60V 1 TURN FLAT ELEMENT	1	PZ																										
SL1045A0	S57 BLACK SILICONE - 80ML CARTRIDGE	1	PZ																										
VI1220A1	4,2X12 TCB SELF-TAPPIN G SCREW	2	PZ																										
KRS1261A	122W MOTOR BREAKING ELEMENT KIT	<table border="1"> <thead> <tr> <th>Code</th> <th>Description</th> <th>Qty</th> <th>UOM</th> </tr> </thead> <tbody> <tr> <td>GN1326A1</td> <td>ELEMENT SEALING</td> <td>1</td> <td>PZ</td> </tr> <tr> <td>RS1261A0</td> <td>BAKERLUX/CH EFLUX MOTOR BREAKING ELEMENT</td> <td>1</td> <td>PZ</td> </tr> </tbody> </table>	Code	Description	Qty	UOM	GN1326A1	ELEMENT SEALING	1	PZ	RS1261A0	BAKERLUX/CH EFLUX MOTOR BREAKING ELEMENT	1	PZ															
Code	Description	Qty	UOM																										
GN1326A1	ELEMENT SEALING	1	PZ																										
RS1261A0	BAKERLUX/CH EFLUX MOTOR BREAKING ELEMENT	1	PZ																										

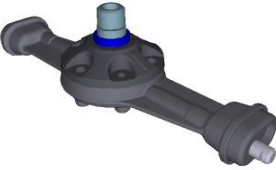

COMPONENT			SPARE PART																											
Code	Description	Image	Code	Description	Components list																									
GN1326A	ELEMENT SEALING		KRS1261A	122W MOTOR BRAKING ELEMENT KIT	<table border="1"> <thead> <tr> <th>Code</th> <th>Description</th> <th>Qty</th> <th>UOM</th> </tr> </thead> <tbody> <tr> <td>SL1045A0</td> <td>S57 BLACK SILICONE - 80ML CARTRIDGE</td> <td>1</td> <td>PZ</td> </tr> <tr> <td>VI1220A1</td> <td>4,2X12 TCB SELF-TAPPIN G SCREW</td> <td>2</td> <td>PZ</td> </tr> <tr> <td>VM2147A0</td> <td>410X343X15 MM PINK SMOOTH ESD SPONGE</td> <td>1</td> <td>PZ</td> </tr> </tbody> </table>	Code	Description	Qty	UOM	SL1045A0	S57 BLACK SILICONE - 80ML CARTRIDGE	1	PZ	VI1220A1	4,2X12 TCB SELF-TAPPIN G SCREW	2	PZ	VM2147A0	410X343X15 MM PINK SMOOTH ESD SPONGE	1	PZ									
			Code	Description	Qty	UOM																								
			SL1045A0	S57 BLACK SILICONE - 80ML CARTRIDGE	1	PZ																								
			VI1220A1	4,2X12 TCB SELF-TAPPIN G SCREW	2	PZ																								
			VM2147A0	410X343X15 MM PINK SMOOTH ESD SPONGE	1	PZ																								
			KRS1215A	147W MOTOR BRAKING ELEMENT KIT	<table border="1"> <thead> <tr> <th>Code</th> <th>Description</th> <th>Qty</th> <th>UOM</th> </tr> </thead> <tbody> <tr> <td>GN1326A1</td> <td>ELEMENT SEALING</td> <td>1</td> <td>PZ</td> </tr> <tr> <td>RS1215A1</td> <td>147W 105V BRAKING ELEMENT</td> <td>1</td> <td>PZ</td> </tr> <tr> <td>SL1045A0</td> <td>S57 BLACK SILICONE - 80ML CARTRIDGE</td> <td>1</td> <td>PZ</td> </tr> <tr> <td>VI1220A1</td> <td>4,2X12 TCB SELF-TAPPIN G SCREW</td> <td>2</td> <td>PZ</td> </tr> </tbody> </table>	Code	Description	Qty	UOM	GN1326A1	ELEMENT SEALING	1	PZ	RS1215A1	147W 105V BRAKING ELEMENT	1	PZ	SL1045A0	S57 BLACK SILICONE - 80ML CARTRIDGE	1	PZ	VI1220A1	4,2X12 TCB SELF-TAPPIN G SCREW	2	PZ					
			Code	Description	Qty	UOM																								
			GN1326A1	ELEMENT SEALING	1	PZ																								
			RS1215A1	147W 105V BRAKING ELEMENT	1	PZ																								
			SL1045A0	S57 BLACK SILICONE - 80ML CARTRIDGE	1	PZ																								
			VI1220A1	4,2X12 TCB SELF-TAPPIN G SCREW	2	PZ																								
			KRS1095A	1.2KW HEATING ELEMENT KIT	<table border="1"> <thead> <tr> <th>Code</th> <th>Description</th> <th>Qty</th> <th>UOM</th> </tr> </thead> <tbody> <tr> <td>GN1326A1</td> <td>ELEMENT SEALING</td> <td>1</td> <td>PZ</td> </tr> <tr> <td>IP1385A1</td> <td>CORNER POLYSTYREN E PACKING 110X80X2000</td> <td>0.500</td> <td>M</td> </tr> <tr> <td>RS1095A1</td> <td>HEATING ELEMENT 1200W 230V</td> <td>1</td> <td>PZ</td> </tr> <tr> <td>SL1045A0</td> <td>S57 BLACK SILICONE - 80ML CARTRIDGE</td> <td>1</td> <td>PZ</td> </tr> <tr> <td>VI1220A1</td> <td>4,2X12 TCB SELF-TAPPIN G SCREW</td> <td>2</td> <td>PZ</td> </tr> <tr> <td>VM1059A1</td> <td>HEAT SHRINK FILM H800</td> <td>1.200</td> <td>M</td> </tr> </tbody> </table>	Code	Description	Qty	UOM	GN1326A1	ELEMENT SEALING	1	PZ	IP1385A1	CORNER POLYSTYREN E PACKING 110X80X2000	0.500	M	RS1095A1	HEATING ELEMENT 1200W 230V	1	PZ	SL1045A0	S57 BLACK SILICONE - 80ML CARTRIDGE	1	PZ	VI1220A1	4,2X12 TCB SELF-TAPPIN G SCREW	2	PZ	VM1059A1
Code	Description	Qty	UOM																											
GN1326A1	ELEMENT SEALING	1	PZ																											
IP1385A1	CORNER POLYSTYREN E PACKING 110X80X2000	0.500	M																											
RS1095A1	HEATING ELEMENT 1200W 230V	1	PZ																											
SL1045A0	S57 BLACK SILICONE - 80ML CARTRIDGE	1	PZ																											
VI1220A1	4,2X12 TCB SELF-TAPPIN G SCREW	2	PZ																											
VM1059A1	HEAT SHRINK FILM H800	1.200	M																											
KRS1012A	1365W 120V HEATING ELEMENT KIT	<table border="1"> <thead> <tr> <th>Code</th> <th>Description</th> <th>Qty</th> <th>UOM</th> </tr> </thead> <tbody> <tr> <td>GN1326A1</td> <td>ELEMENT SEALING</td> <td>1</td> <td>PZ</td> </tr> <tr> <td>RS1012A0</td> <td>CIRCULAR ELEMENT 1365W 120V</td> <td>1</td> <td>PZ</td> </tr> </tbody> </table>	Code	Description	Qty	UOM	GN1326A1	ELEMENT SEALING	1	PZ	RS1012A0	CIRCULAR ELEMENT 1365W 120V	1	PZ																
Code	Description	Qty	UOM																											
GN1326A1	ELEMENT SEALING	1	PZ																											
RS1012A0	CIRCULAR ELEMENT 1365W 120V	1	PZ																											

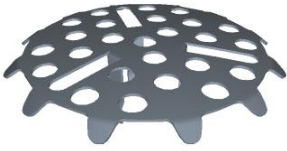
COMPONENT			SPARE PART																														
Code	Description	Image	Code	Description	Components list																												
GN1326A	ELEMENT SEALING		KRS1012A	1365W 120V HEATING ELEMENT KIT	<table border="1"> <thead> <tr> <th>Code</th> <th>Description</th> <th>Qty</th> <th>UOM</th> </tr> </thead> <tbody> <tr> <td>VI1220A1</td> <td>4,2X12 TCB SELF-TAPPIN G SCREW</td> <td>5</td> <td>PZ</td> </tr> <tr> <td>VM1794A0</td> <td>250X4.8 PA66 BLACK CLAMP</td> <td>2</td> <td>PZ</td> </tr> <tr> <td>VM2103A0</td> <td>CLAMP LOCK</td> <td>2</td> <td>PZ</td> </tr> </tbody> </table>	Code	Description	Qty	UOM	VI1220A1	4,2X12 TCB SELF-TAPPIN G SCREW	5	PZ	VM1794A0	250X4.8 PA66 BLACK CLAMP	2	PZ	VM2103A0	CLAMP LOCK	2	PZ												
			Code	Description	Qty	UOM																											
			VI1220A1	4,2X12 TCB SELF-TAPPIN G SCREW	5	PZ																											
			VM1794A0	250X4.8 PA66 BLACK CLAMP	2	PZ																											
			VM2103A0	CLAMP LOCK	2	PZ																											
			KRS1011A	ROBERTA/LISA HEATING ELEMENT KIT	<table border="1"> <thead> <tr> <th>Code</th> <th>Description</th> <th>Qty</th> <th>UOM</th> </tr> </thead> <tbody> <tr> <td>GN1326A1</td> <td>ELEMENT SEALING</td> <td>1</td> <td>PZ</td> </tr> <tr> <td>RS1011A0</td> <td>2560W 220-230V HEATING ELEMENT</td> <td>1</td> <td>PZ</td> </tr> <tr> <td>SL1045A0</td> <td>S57 BLACK SILICONE - 80ML CARTRIDGE</td> <td>1</td> <td>PZ</td> </tr> <tr> <td>VI1220A1</td> <td>4,2X12 TCB SELF-TAPPIN G SCREW</td> <td>5</td> <td>PZ</td> </tr> <tr> <td>VM1794A0</td> <td>250X4.8 PA66 BLACK CLAMP</td> <td>2</td> <td>PZ</td> </tr> <tr> <td>VM2103A0</td> <td>CLAMP LOCK</td> <td>2</td> <td>PZ</td> </tr> </tbody> </table>	Code	Description	Qty	UOM	GN1326A1	ELEMENT SEALING	1	PZ	RS1011A0	2560W 220-230V HEATING ELEMENT	1	PZ	SL1045A0	S57 BLACK SILICONE - 80ML CARTRIDGE	1	PZ	VI1220A1	4,2X12 TCB SELF-TAPPIN G SCREW	5	PZ	VM1794A0	250X4.8 PA66 BLACK CLAMP	2	PZ	VM2103A0	CLAMP LOCK	2	PZ
			Code	Description	Qty	UOM																											
			GN1326A1	ELEMENT SEALING	1	PZ																											
			RS1011A0	2560W 220-230V HEATING ELEMENT	1	PZ																											
			SL1045A0	S57 BLACK SILICONE - 80ML CARTRIDGE	1	PZ																											
			VI1220A1	4,2X12 TCB SELF-TAPPIN G SCREW	5	PZ																											
			VM1794A0	250X4.8 PA66 BLACK CLAMP	2	PZ																											
VM2103A0	CLAMP LOCK	2	PZ																														
KRS0090A	HEATING ELEMENT 1.26KW	<table border="1"> <thead> <tr> <th>Code</th> <th>Description</th> <th>Qty</th> <th>UOM</th> </tr> </thead> <tbody> <tr> <td>GN1326A1</td> <td>ELEMENT SEALING</td> <td>1</td> <td>PZ</td> </tr> <tr> <td>RS0090A0</td> <td>CIRC. HEAT. ELEMENT 1260W 220-230</td> <td>1</td> <td>PZ</td> </tr> <tr> <td>VI1220A1</td> <td>4,2X12 TCB SELF-TAPPIN G SCREW</td> <td>3</td> <td>PZ</td> </tr> <tr> <td>VM1794A0</td> <td>250X4.8 PA66 BLACK CLAMP</td> <td>2</td> <td>PZ</td> </tr> <tr> <td>VM2103A0</td> <td>CLAMP LOCK</td> <td>2</td> <td>PZ</td> </tr> </tbody> </table>	Code	Description	Qty	UOM	GN1326A1	ELEMENT SEALING	1	PZ	RS0090A0	CIRC. HEAT. ELEMENT 1260W 220-230	1	PZ	VI1220A1	4,2X12 TCB SELF-TAPPIN G SCREW	3	PZ	VM1794A0	250X4.8 PA66 BLACK CLAMP	2	PZ	VM2103A0	CLAMP LOCK	2	PZ							
Code	Description	Qty	UOM																														
GN1326A1	ELEMENT SEALING	1	PZ																														
RS0090A0	CIRC. HEAT. ELEMENT 1260W 220-230	1	PZ																														
VI1220A1	4,2X12 TCB SELF-TAPPIN G SCREW	3	PZ																														
VM1794A0	250X4.8 PA66 BLACK CLAMP	2	PZ																														
VM2103A0	CLAMP LOCK	2	PZ																														
KRS0050A	HEATING ELEMENT KIT 0.5KW	<table border="1"> <thead> <tr> <th>Code</th> <th>Description</th> <th>Qty</th> <th>UOM</th> </tr> </thead> <tbody> <tr> <td>GN1326A1</td> <td>ELEMENT SEALING</td> <td>1</td> <td>PZ</td> </tr> <tr> <td>IP1075A1</td> <td></td> <td>1</td> <td>PZ</td> </tr> <tr> <td>IP1080A1</td> <td></td> <td>1</td> <td>PZ</td> </tr> <tr> <td>RS0050A0</td> <td>HEAT. ELEMENT 500W 220-230V LIEV</td> <td>1</td> <td>PZ</td> </tr> <tr> <td>VI1220A1</td> <td>4,2X12 TCB SELF-TAPPIN G SCREW</td> <td>2</td> <td>PZ</td> </tr> </tbody> </table>	Code	Description	Qty	UOM	GN1326A1	ELEMENT SEALING	1	PZ	IP1075A1		1	PZ	IP1080A1		1	PZ	RS0050A0	HEAT. ELEMENT 500W 220-230V LIEV	1	PZ	VI1220A1	4,2X12 TCB SELF-TAPPIN G SCREW	2	PZ							
Code	Description	Qty	UOM																														
GN1326A1	ELEMENT SEALING	1	PZ																														
IP1075A1		1	PZ																														
IP1080A1		1	PZ																														
RS0050A0	HEAT. ELEMENT 500W 220-230V LIEV	1	PZ																														
VI1220A1	4,2X12 TCB SELF-TAPPIN G SCREW	2	PZ																														
KRS0011A	HEATING ELEMENT 1.465KW RS0011A	<table border="1"> <thead> <tr> <th>Code</th> <th>Description</th> <th>Qty</th> <th>UOM</th> </tr> </thead> <tbody> <tr> <td>GN1326A1</td> <td>ELEMENT SEALING</td> <td>1</td> <td>PZ</td> </tr> </tbody> </table>	Code	Description	Qty	UOM	GN1326A1	ELEMENT SEALING	1	PZ																							
Code	Description	Qty	UOM																														
GN1326A1	ELEMENT SEALING	1	PZ																														

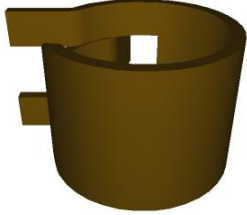
COMPONENT			SPARE PART																							
Code	Description	Image	Code	Description	Components list																					
GN1326A	ELEMENT SEALING		KRS0011A	HEATING ELEMENT 1.465KW RS0011A	<table border="1"> <thead> <tr> <th>Code</th> <th>Description</th> <th>Qty</th> <th>UOM</th> </tr> </thead> <tbody> <tr> <td>RS0011A0</td> <td>CIRC.HEAT. ELEMENT 1465W 220-230</td> <td>1</td> <td>PZ</td> </tr> <tr> <td>VI1220A1</td> <td>4,2X12 TCB SELF-TAPPIN G SCREW</td> <td>3</td> <td>PZ</td> </tr> <tr> <td>VM1794A0</td> <td>250X4.8 PA66 BLACK CLAMP</td> <td>2</td> <td>PZ</td> </tr> <tr> <td>VM2103A0</td> <td>CLAMP LOCK</td> <td>2</td> <td>PZ</td> </tr> </tbody> </table>	Code	Description	Qty	UOM	RS0011A0	CIRC.HEAT. ELEMENT 1465W 220-230	1	PZ	VI1220A1	4,2X12 TCB SELF-TAPPIN G SCREW	3	PZ	VM1794A0	250X4.8 PA66 BLACK CLAMP	2	PZ	VM2103A0	CLAMP LOCK	2	PZ	
			Code	Description	Qty	UOM																				
			RS0011A0	CIRC.HEAT. ELEMENT 1465W 220-230	1	PZ																				
VI1220A1	4,2X12 TCB SELF-TAPPIN G SCREW	3	PZ																							
VM1794A0	250X4.8 PA66 BLACK CLAMP	2	PZ																							
VM2103A0	CLAMP LOCK	2	PZ																							
KRS0010A	KIT HEATING ELEMENT RS10010A	<table border="1"> <thead> <tr> <th>Code</th> <th>Description</th> <th>Qty</th> <th>UOM</th> </tr> </thead> <tbody> <tr> <td>GN1326A1</td> <td>ELEMENT SEALING</td> <td>1</td> <td>PZ</td> </tr> <tr> <td>IP1075A1</td> <td></td> <td>1</td> <td>PZ</td> </tr> <tr> <td>IP1080A1</td> <td></td> <td>5</td> <td>PZ</td> </tr> <tr> <td>RS0010A0</td> <td>CIRC.HEAT. ELEMENT 2560W - 220-230 V</td> <td>1</td> <td>PZ</td> </tr> <tr> <td>VI1220A1</td> <td>4,2X12 TCB SELF-TAPPIN G SCREW</td> <td>3</td> <td>PZ</td> </tr> </tbody> </table>	Code	Description	Qty	UOM	GN1326A1	ELEMENT SEALING	1	PZ	IP1075A1		1	PZ	IP1080A1		5	PZ	RS0010A0	CIRC.HEAT. ELEMENT 2560W - 220-230 V	1	PZ	VI1220A1	4,2X12 TCB SELF-TAPPIN G SCREW	3	PZ
Code	Description	Qty	UOM																							
GN1326A1	ELEMENT SEALING	1	PZ																							
IP1075A1		1	PZ																							
IP1080A1		5	PZ																							
RS0010A0	CIRC.HEAT. ELEMENT 2560W - 220-230 V	1	PZ																							
VI1220A1	4,2X12 TCB SELF-TAPPIN G SCREW	3	PZ																							
KGN1326A	HEATING ELEMENT GASKET 5 PCS KIT	<table border="1"> <thead> <tr> <th>Code</th> <th>Description</th> <th>Qty</th> <th>UOM</th> </tr> </thead> <tbody> <tr> <td>GN1326A1</td> <td>ELEMENT SEALING</td> <td>5</td> <td>PZ</td> </tr> <tr> <td>VM1224A0</td> <td></td> <td>0.200</td> <td>M</td> </tr> </tbody> </table>	Code	Description	Qty	UOM	GN1326A1	ELEMENT SEALING	5	PZ	VM1224A0		0.200	M												
Code	Description	Qty	UOM																							
GN1326A1	ELEMENT SEALING	5	PZ																							
VM1224A0		0.200	M																							
RS1274A	100W 60V 1 TURN FLAT ELEMENT		KRS1274A	100W MOTOR BRAKING ELEMENT KIT	<table border="1"> <thead> <tr> <th>Code</th> <th>Description</th> <th>Qty</th> <th>UOM</th> </tr> </thead> <tbody> <tr> <td>GN1326A1</td> <td>ELEMENT SEALING</td> <td>1</td> <td>PZ</td> </tr> <tr> <td>RS1274A0</td> <td>100W 60V 1 TURN FLAT ELEMENT</td> <td>1</td> <td>PZ</td> </tr> <tr> <td>SL1045A0</td> <td>S57 BLACK SILICONE - 80ML CARTRIDGE</td> <td>1</td> <td>PZ</td> </tr> <tr> <td>VI1220A1</td> <td>4,2X12 TCB SELF-TAPPIN G SCREW</td> <td>2</td> <td>PZ</td> </tr> </tbody> </table>	Code	Description	Qty	UOM	GN1326A1	ELEMENT SEALING	1	PZ	RS1274A0	100W 60V 1 TURN FLAT ELEMENT	1	PZ	SL1045A0	S57 BLACK SILICONE - 80ML CARTRIDGE	1	PZ	VI1220A1	4,2X12 TCB SELF-TAPPIN G SCREW	2	PZ	
			Code	Description	Qty	UOM																				
GN1326A1	ELEMENT SEALING	1	PZ																							
RS1274A0	100W 60V 1 TURN FLAT ELEMENT	1	PZ																							
SL1045A0	S57 BLACK SILICONE - 80ML CARTRIDGE	1	PZ																							
VI1220A1	4,2X12 TCB SELF-TAPPIN G SCREW	2	PZ																							
KRS0025A	BIG-L 100W MOTOR BRAKING ELEMENT KIT	<table border="1"> <thead> <tr> <th>Code</th> <th>Description</th> <th>Qty</th> <th>UOM</th> </tr> </thead> <tbody> <tr> <td>GN1672A0</td> <td></td> <td>1</td> <td>PZ</td> </tr> <tr> <td>RS1274A0</td> <td>100W 60V 1 TURN FLAT ELEMENT</td> <td>1</td> <td>PZ</td> </tr> <tr> <td>SL1045A0</td> <td>S57 BLACK SILICONE - 80ML CARTRIDGE</td> <td>1</td> <td>PZ</td> </tr> <tr> <td>VI1220A1</td> <td>4,2X12 TCB SELF-TAPPIN G SCREW</td> <td>2</td> <td>PZ</td> </tr> </tbody> </table>	Code	Description	Qty	UOM	GN1672A0		1	PZ	RS1274A0	100W 60V 1 TURN FLAT ELEMENT	1	PZ	SL1045A0	S57 BLACK SILICONE - 80ML CARTRIDGE	1	PZ	VI1220A1	4,2X12 TCB SELF-TAPPIN G SCREW	2	PZ				
Code	Description	Qty	UOM																							
GN1672A0		1	PZ																							
RS1274A0	100W 60V 1 TURN FLAT ELEMENT	1	PZ																							
SL1045A0	S57 BLACK SILICONE - 80ML CARTRIDGE	1	PZ																							
VI1220A1	4,2X12 TCB SELF-TAPPIN G SCREW	2	PZ																							

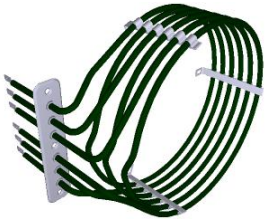

COMPONENT			SPARE PART																																														
Code	Description	Image	Code	Description	Components list																																												
GN1531A	THERMOSTAT BULB INLET SEALING		KTR1136A	330 °C SAFETY THERMOSTAT KIT	<table border="1"> <thead> <tr> <th>Code</th> <th>Description</th> <th>Qty</th> <th>UOM</th> </tr> </thead> <tbody> <tr> <td>0H7030A0</td> <td>THERMOSTAT BULB INLET COVER</td> <td>1</td> <td>PZ</td> </tr> <tr> <td>GN1531A0</td> <td>THERMOSTAT BULB INLET SEALING</td> <td>1</td> <td>PZ</td> </tr> <tr> <td>SL1045A0</td> <td>S57 BLACK SILICONE - 80ML CARTRIDGE</td> <td>1</td> <td>PZ</td> </tr> <tr> <td>TR1136A0</td> <td>330 °C 1 POLE SAFETY THERMOSTAT</td> <td>1</td> <td>PZ</td> </tr> <tr> <td>VI1220A1</td> <td>4,2X12 TCB SELF-TAPPING SCREW</td> <td>3</td> <td>PZ</td> </tr> </tbody> </table>	Code	Description	Qty	UOM	0H7030A0	THERMOSTAT BULB INLET COVER	1	PZ	GN1531A0	THERMOSTAT BULB INLET SEALING	1	PZ	SL1045A0	S57 BLACK SILICONE - 80ML CARTRIDGE	1	PZ	TR1136A0	330 °C 1 POLE SAFETY THERMOSTAT	1	PZ	VI1220A1	4,2X12 TCB SELF-TAPPING SCREW	3	PZ																				
					Code	Description	Qty	UOM																																									
					0H7030A0	THERMOSTAT BULB INLET COVER	1	PZ																																									
					GN1531A0	THERMOSTAT BULB INLET SEALING	1	PZ																																									
					SL1045A0	S57 BLACK SILICONE - 80ML CARTRIDGE	1	PZ																																									
TR1136A0	330 °C 1 POLE SAFETY THERMOSTAT	1	PZ																																														
VI1220A1	4,2X12 TCB SELF-TAPPING SCREW	3	PZ																																														
0H7030A	THERMOSTAT BULB INLET COVER		K0H7030A	THERMOSTAT BULB INLET COVER KIT	<table border="1"> <thead> <tr> <th>Code</th> <th>Description</th> <th>Qty</th> <th>UOM</th> </tr> </thead> <tbody> <tr> <td>0H7030A0</td> <td>THERMOSTAT BULB INLET COVER</td> <td>1</td> <td>PZ</td> </tr> <tr> <td>VM1224A0</td> <td></td> <td>0.200</td> <td>M</td> </tr> </tbody> </table>	Code	Description	Qty	UOM	0H7030A0	THERMOSTAT BULB INLET COVER	1	PZ	VM1224A0		0.200	M																																
Code	Description				Qty	UOM																																											
0H7030A0	THERMOSTAT BULB INLET COVER	1	PZ																																														
VM1224A0		0.200	M																																														
VL1037A	WASHING SYSTEM ROTOR		KVL1037A	WASHING SYSTEM ROTOR KIT	<table border="1"> <thead> <tr> <th>Code</th> <th>Description</th> <th>Qty</th> <th>UOM</th> </tr> </thead> <tbody> <tr> <td>GN1416B0</td> <td>WASHING SYSTEM ROTOR BEARING</td> <td>1</td> <td>PZ</td> </tr> <tr> <td>TF1065B0</td> <td>WASHING SYSTEM ROTOR PIVOT</td> <td>1</td> <td>PZ</td> </tr> <tr> <td>TF1066A1</td> <td>WASHING SYSTEM ROTOR BUSH</td> <td>1</td> <td>PZ</td> </tr> <tr> <td>UG1005B1</td> <td>LONG RAY ROTOR WATER NOZZL</td> <td>1</td> <td>PZ</td> </tr> <tr> <td>UG1006B3</td> <td>LONG RAY ROTOR WATER NOZZL</td> <td>1</td> <td>PZ</td> </tr> <tr> <td>VI1220A1</td> <td>4,2X12 TCB SELF-TAPPING SCREW</td> <td>8</td> <td>PZ</td> </tr> <tr> <td>VM1224A0</td> <td></td> <td>0.250</td> <td>M</td> </tr> <tr> <td>VM1955C0</td> <td>WASHING SYSTEM ROTOR</td> <td>1</td> <td>PZ</td> </tr> <tr> <td>VM1985C1</td> <td>WASHING SYSTEM ROTOR COVE</td> <td>1</td> <td>PZ</td> </tr> <tr> <td>VM1986A0</td> <td>NOZZLE COVE</td> <td>2</td> <td>PZ</td> </tr> </tbody> </table>	Code	Description	Qty	UOM	GN1416B0	WASHING SYSTEM ROTOR BEARING	1	PZ	TF1065B0	WASHING SYSTEM ROTOR PIVOT	1	PZ	TF1066A1	WASHING SYSTEM ROTOR BUSH	1	PZ	UG1005B1	LONG RAY ROTOR WATER NOZZL	1	PZ	UG1006B3	LONG RAY ROTOR WATER NOZZL	1	PZ	VI1220A1	4,2X12 TCB SELF-TAPPING SCREW	8	PZ	VM1224A0		0.250	M	VM1955C0	WASHING SYSTEM ROTOR	1	PZ	VM1985C1	WASHING SYSTEM ROTOR COVE	1	PZ	VM1986A0	NOZZLE COVE	2	PZ
					Code	Description	Qty	UOM																																									
					GN1416B0	WASHING SYSTEM ROTOR BEARING	1	PZ																																									
					TF1065B0	WASHING SYSTEM ROTOR PIVOT	1	PZ																																									
					TF1066A1	WASHING SYSTEM ROTOR BUSH	1	PZ																																									
					UG1005B1	LONG RAY ROTOR WATER NOZZL	1	PZ																																									
					UG1006B3	LONG RAY ROTOR WATER NOZZL	1	PZ																																									
					VI1220A1	4,2X12 TCB SELF-TAPPING SCREW	8	PZ																																									
					VM1224A0		0.250	M																																									
					VM1955C0	WASHING SYSTEM ROTOR	1	PZ																																									
VM1985C1	WASHING SYSTEM ROTOR COVE	1	PZ																																														
VM1986A0	NOZZLE COVE	2	PZ																																														



COMPONENT			SPARE PART														
Code	Description	Image	Code	Description	Components list												
0H2551A	XBC/XVC ST.STEEL DRAIN COVER		K0H2551A	DRAIN COVER KIT	<table border="1"> <thead> <tr> <th>Code</th> <th>Description</th> <th>Qty</th> <th>UOM</th> </tr> </thead> <tbody> <tr> <td>0H2551A0</td> <td>XBC/XVC ST.STEEL DRAIN COVER</td> <td>1</td> <td>PZ</td> </tr> <tr> <td>VM1224A0</td> <td></td> <td>0.200</td> <td>M</td> </tr> </tbody> </table>	Code	Description	Qty	UOM	0H2551A0	XBC/XVC ST.STEEL DRAIN COVER	1	PZ	VM1224A0		0.200	M
Code	Description	Qty	UOM														
0H2551A0	XBC/XVC ST.STEEL DRAIN COVER	1	PZ														
VM1224A0		0.200	M														
VM1820A	LATERAL SUPPORTS M6 FIXING BOLT		KVM1820A	THUMB SCREW 10PCS KIT	<table border="1"> <thead> <tr> <th>Code</th> <th>Description</th> <th>Qty</th> <th>UOM</th> </tr> </thead> <tbody> <tr> <td>VM1224A0</td> <td></td> <td>0.200</td> <td>M</td> </tr> <tr> <td>VM1820A0</td> <td>LATERAL SUPPORTS M6 FIXING BOLT</td> <td>10</td> <td>PZ</td> </tr> </tbody> </table>	Code	Description	Qty	UOM	VM1224A0		0.200	M	VM1820A0	LATERAL SUPPORTS M6 FIXING BOLT	10	PZ
Code	Description	Qty	UOM														
VM1224A0		0.200	M														
VM1820A0	LATERAL SUPPORTS M6 FIXING BOLT	10	PZ														
RC1019A	D=10 ELASTIC CLAM		KRC1019A	Ø10 ZINC PLATED ELASTIC CLAMP 15 PCS KIT	<table border="1"> <thead> <tr> <th>Code</th> <th>Description</th> <th>Qty</th> <th>UOM</th> </tr> </thead> <tbody> <tr> <td>RC1019A0</td> <td>D=10 ELASTIC CLAMP</td> <td>17</td> <td>PZ</td> </tr> <tr> <td>VM1224A0</td> <td></td> <td>0.200</td> <td>M</td> </tr> </tbody> </table>	Code	Description	Qty	UOM	RC1019A0	D=10 ELASTIC CLAMP	17	PZ	VM1224A0		0.200	M
Code	Description	Qty	UOM														
RC1019A0	D=10 ELASTIC CLAMP	17	PZ														
VM1224A0		0.200	M														
VM2331A	FAN GUARD-TRAYS HOLDER PIN		KVM2331A	KIT FAN GUARD-TRAYS HOLDER PIN	<table border="1"> <thead> <tr> <th>Code</th> <th>Description</th> <th>Qty</th> <th>UOM</th> </tr> </thead> <tbody> <tr> <td>VM1224A0</td> <td></td> <td>0.200</td> <td>M</td> </tr> <tr> <td>VM2331A0</td> <td>FAN GUARD-TRAY S HOLDER PIN</td> <td>4</td> <td>PZ</td> </tr> </tbody> </table>	Code	Description	Qty	UOM	VM1224A0		0.200	M	VM2331A0	FAN GUARD-TRAY S HOLDER PIN	4	PZ
Code	Description	Qty	UOM														
VM1224A0		0.200	M														
VM2331A0	FAN GUARD-TRAY S HOLDER PIN	4	PZ														
GN1085A	141X24 HEATING ELEMENT GASKET		KGN1086A	141X22 HEATING ELEMENT GASKET 5 PCS KIT	<table border="1"> <thead> <tr> <th>Code</th> <th>Description</th> <th>Qty</th> <th>UOM</th> </tr> </thead> <tbody> <tr> <td>GN1086A0</td> <td>ELEMENT SEALING</td> <td>5</td> <td>PZ</td> </tr> <tr> <td>VM1224A0</td> <td></td> <td>0.200</td> <td>M</td> </tr> </tbody> </table>	Code	Description	Qty	UOM	GN1086A0	ELEMENT SEALING	5	PZ	VM1224A0		0.200	M
Code	Description	Qty	UOM														
GN1086A0	ELEMENT SEALING	5	PZ														
VM1224A0		0.200	M														

COMPONENT			SPARE PART																																														
Code	Description	Image	Code	Description	Components list																																												
RS1225A	4700W 230V D230 6 TURNS HEATING ELEMENT		KRS1225A	4.7KW HEATING ELEMENT KIT	<table border="1"> <thead> <tr> <th>Code</th> <th>Description</th> <th>Qty</th> <th>UOM</th> </tr> </thead> <tbody> <tr> <td>GN1085A2</td> <td>141X24 HEATING ELEMENT GASKET</td> <td>1</td> <td>PZ</td> </tr> <tr> <td>GN1086A0</td> <td>ELEMENT SEALING</td> <td>1</td> <td>PZ</td> </tr> <tr> <td>RS1225A1</td> <td>4700W 230V D230 6 TURNS HEATING ELEMENT</td> <td>1</td> <td>PZ</td> </tr> <tr> <td>SL1045A0</td> <td>S57 BLACK SILICONE - 80ML CARTRIDGE</td> <td>1</td> <td>PZ</td> </tr> <tr> <td>VI1032A0</td> <td>SCREW M4X16 TCB+ INOX</td> <td>1</td> <td>PZ</td> </tr> <tr> <td>VI1075A0</td> <td>NUT M4 H=4 UNI5587 INOX</td> <td>1</td> <td>PZ</td> </tr> <tr> <td>VI1220A1</td> <td>4,2X12 TCB SELF-TAPPIN G SCREW</td> <td>6</td> <td>PZ</td> </tr> <tr> <td>VI1511A0</td> <td>STAINLESS STEEL WASHER 4.2X12X1</td> <td>1</td> <td>PZ</td> </tr> <tr> <td>VM1794A0</td> <td>250X4.8 PA66 BLACK CLAMP</td> <td>2</td> <td>PZ</td> </tr> <tr> <td>VM2103A0</td> <td>CLAMP LOCK</td> <td>2</td> <td>PZ</td> </tr> </tbody> </table>	Code	Description	Qty	UOM	GN1085A2	141X24 HEATING ELEMENT GASKET	1	PZ	GN1086A0	ELEMENT SEALING	1	PZ	RS1225A1	4700W 230V D230 6 TURNS HEATING ELEMENT	1	PZ	SL1045A0	S57 BLACK SILICONE - 80ML CARTRIDGE	1	PZ	VI1032A0	SCREW M4X16 TCB+ INOX	1	PZ	VI1075A0	NUT M4 H=4 UNI5587 INOX	1	PZ	VI1220A1	4,2X12 TCB SELF-TAPPIN G SCREW	6	PZ	VI1511A0	STAINLESS STEEL WASHER 4.2X12X1	1	PZ	VM1794A0	250X4.8 PA66 BLACK CLAMP	2	PZ	VM2103A0	CLAMP LOCK	2	PZ
					Code	Description	Qty	UOM																																									
					GN1085A2	141X24 HEATING ELEMENT GASKET	1	PZ																																									
					GN1086A0	ELEMENT SEALING	1	PZ																																									
					RS1225A1	4700W 230V D230 6 TURNS HEATING ELEMENT	1	PZ																																									
					SL1045A0	S57 BLACK SILICONE - 80ML CARTRIDGE	1	PZ																																									
					VI1032A0	SCREW M4X16 TCB+ INOX	1	PZ																																									
					VI1075A0	NUT M4 H=4 UNI5587 INOX	1	PZ																																									
					VI1220A1	4,2X12 TCB SELF-TAPPIN G SCREW	6	PZ																																									
					VI1511A0	STAINLESS STEEL WASHER 4.2X12X1	1	PZ																																									
VM1794A0	250X4.8 PA66 BLACK CLAMP	2	PZ																																														
VM2103A0	CLAMP LOCK	2	PZ																																														
TB2902A	GAS OVENS CHAMBER CHIMNEY PIPE D50		TB2902A0	GAS OVENS CHAMBER CHIMNEY PIPE D50																																													
0H2730A	ZINC PLATED MUFFLE SUPPORT BRACKET		0H2730A1	ZINC PLATED MUFFLE SUPPORT BRACKET																																													

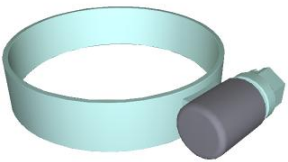

COMPONENT			SPARE PART																						
Code	Description	Image	Code	Description	Components list																				
VE1550A	5X3 MM NEODYMIUM MAGNET		KPE1710B	MOTOR REVOLUTIONS SENSOR KIT	<table border="1"> <thead> <tr> <th>Code</th> <th>Description</th> <th>Qty</th> <th>UOM</th> </tr> </thead> <tbody> <tr> <td>PE1710B0</td> <td>MOTOR REVOLUTION AND DIRECTION SENSOR</td> <td>1</td> <td>PZ</td> </tr> <tr> <td>VE1550A0</td> <td>5X3 MM NEODYMIUM MAGNET</td> <td>1</td> <td>PZ</td> </tr> <tr> <td>VI1966A0</td> <td>M4X14 FLATHEAD SCREW</td> <td>1</td> <td>PZ</td> </tr> <tr> <td>VM1635A0</td> <td>MAGNET HOLDING DIS</td> <td>1</td> <td>PZ</td> </tr> </tbody> </table>	Code	Description	Qty	UOM	PE1710B0	MOTOR REVOLUTION AND DIRECTION SENSOR	1	PZ	VE1550A0	5X3 MM NEODYMIUM MAGNET	1	PZ	VI1966A0	M4X14 FLATHEAD SCREW	1	PZ	VM1635A0	MAGNET HOLDING DIS	1	PZ
Code	Description	Qty	UOM																						
PE1710B0	MOTOR REVOLUTION AND DIRECTION SENSOR	1	PZ																						
VE1550A0	5X3 MM NEODYMIUM MAGNET	1	PZ																						
VI1966A0	M4X14 FLATHEAD SCREW	1	PZ																						
VM1635A0	MAGNET HOLDING DIS	1	PZ																						
PE1710B			KPE1710B	MOTOR REVOLUTIONS SENSOR KIT	<table border="1"> <thead> <tr> <th>Code</th> <th>Description</th> <th>Qty</th> <th>UOM</th> </tr> </thead> <tbody> <tr> <td>PE1710B0</td> <td>MOTOR REVOLUTION AND DIRECTION SENSOR</td> <td>1</td> <td>PZ</td> </tr> <tr> <td>VE1550A0</td> <td>5X3 MM NEODYMIUM MAGNET</td> <td>1</td> <td>PZ</td> </tr> <tr> <td>VI1966A0</td> <td>M4X14 FLATHEAD SCREW</td> <td>1</td> <td>PZ</td> </tr> <tr> <td>VM1635A0</td> <td>MAGNET HOLDING DIS</td> <td>1</td> <td>PZ</td> </tr> </tbody> </table>	Code	Description	Qty	UOM	PE1710B0	MOTOR REVOLUTION AND DIRECTION SENSOR	1	PZ	VE1550A0	5X3 MM NEODYMIUM MAGNET	1	PZ	VI1966A0	M4X14 FLATHEAD SCREW	1	PZ	VM1635A0	MAGNET HOLDING DIS	1	PZ
Code	Description	Qty	UOM																						
PE1710B0	MOTOR REVOLUTION AND DIRECTION SENSOR	1	PZ																						
VE1550A0	5X3 MM NEODYMIUM MAGNET	1	PZ																						
VI1966A0	M4X14 FLATHEAD SCREW	1	PZ																						
VM1635A0	MAGNET HOLDING DIS	1	PZ																						
CE1119A			CE1119A0																						
PE1040A			PE1040A0																						

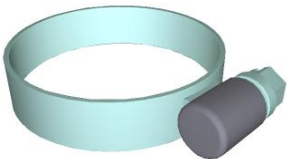
COMPONENT			SPARE PART																														
Code	Description	Image	Code	Description	Components list																												
GRL1405A	6X600X400 LEFT LATERAL SUPPORT		KGRL1405A	MIND.MAPS 6 600X400 LATERAL SUPPORTS KIT	<table border="1"> <thead> <tr> <th>Code</th> <th>Description</th> <th>Qty</th> <th>UOM</th> </tr> </thead> <tbody> <tr> <td>0H4215A0</td> <td>TRAYS GUIDE PROFILE L372.5 BT</td> <td>12</td> <td>PZ</td> </tr> <tr> <td>0H4420A0</td> <td>STAINLESS STEEL CORE TEMPERATUR</td> <td>1</td> <td>PZ</td> </tr> <tr> <td>0H7302A0</td> <td>0H7312+0H731 3 FLAT SUPPORTING PROFILE</td> <td>2</td> <td>PZ</td> </tr> <tr> <td>0H7303A0</td> <td>0H7314+0H731 5 FLAT SUPPORTING PROFILE</td> <td>2</td> <td>PZ</td> </tr> <tr> <td>IP1508A1</td> <td>POLYSTYREN E U SHAPED PROFILE 2000X60X60</td> <td>1.200</td> <td>M</td> </tr> <tr> <td>VM1059A1</td> <td>HEAT SHRINK FILM H800</td> <td>1.500</td> <td>M</td> </tr> </tbody> </table>	Code	Description	Qty	UOM	0H4215A0	TRAYS GUIDE PROFILE L372.5 BT	12	PZ	0H4420A0	STAINLESS STEEL CORE TEMPERATUR	1	PZ	0H7302A0	0H7312+0H731 3 FLAT SUPPORTING PROFILE	2	PZ	0H7303A0	0H7314+0H731 5 FLAT SUPPORTING PROFILE	2	PZ	IP1508A1	POLYSTYREN E U SHAPED PROFILE 2000X60X60	1.200	M	VM1059A1	HEAT SHRINK FILM H800	1.500	M
Code	Description	Qty	UOM																														
0H4215A0	TRAYS GUIDE PROFILE L372.5 BT	12	PZ																														
0H4420A0	STAINLESS STEEL CORE TEMPERATUR	1	PZ																														
0H7302A0	0H7312+0H731 3 FLAT SUPPORTING PROFILE	2	PZ																														
0H7303A0	0H7314+0H731 5 FLAT SUPPORTING PROFILE	2	PZ																														
IP1508A1	POLYSTYREN E U SHAPED PROFILE 2000X60X60	1.200	M																														
VM1059A1	HEAT SHRINK FILM H800	1.500	M																														
GRL1406A	6X600X400 RIGHT LATERAL SUPPORT		KGRL1405A	MIND.MAPS 6 600X400 LATERAL SUPPORTS KIT	<table border="1"> <thead> <tr> <th>Code</th> <th>Description</th> <th>Qty</th> <th>UOM</th> </tr> </thead> <tbody> <tr> <td>0H4215A0</td> <td>TRAYS GUIDE PROFILE L372.5 BT</td> <td>12</td> <td>PZ</td> </tr> <tr> <td>0H4420A0</td> <td>STAINLESS STEEL CORE TEMPERATUR</td> <td>1</td> <td>PZ</td> </tr> <tr> <td>0H7302A0</td> <td>0H7312+0H731 3 FLAT SUPPORTING PROFILE</td> <td>2</td> <td>PZ</td> </tr> <tr> <td>0H7303A0</td> <td>0H7314+0H731 5 FLAT SUPPORTING PROFILE</td> <td>2</td> <td>PZ</td> </tr> <tr> <td>IP1508A1</td> <td>POLYSTYREN E U SHAPED PROFILE 2000X60X60</td> <td>1.200</td> <td>M</td> </tr> <tr> <td>VM1059A1</td> <td>HEAT SHRINK FILM H800</td> <td>1.500</td> <td>M</td> </tr> </tbody> </table>	Code	Description	Qty	UOM	0H4215A0	TRAYS GUIDE PROFILE L372.5 BT	12	PZ	0H4420A0	STAINLESS STEEL CORE TEMPERATUR	1	PZ	0H7302A0	0H7312+0H731 3 FLAT SUPPORTING PROFILE	2	PZ	0H7303A0	0H7314+0H731 5 FLAT SUPPORTING PROFILE	2	PZ	IP1508A1	POLYSTYREN E U SHAPED PROFILE 2000X60X60	1.200	M	VM1059A1	HEAT SHRINK FILM H800	1.500	M
Code	Description	Qty	UOM																														
0H4215A0	TRAYS GUIDE PROFILE L372.5 BT	12	PZ																														
0H4420A0	STAINLESS STEEL CORE TEMPERATUR	1	PZ																														
0H7302A0	0H7312+0H731 3 FLAT SUPPORTING PROFILE	2	PZ																														
0H7303A0	0H7314+0H731 5 FLAT SUPPORTING PROFILE	2	PZ																														
IP1508A1	POLYSTYREN E U SHAPED PROFILE 2000X60X60	1.200	M																														
VM1059A1	HEAT SHRINK FILM H800	1.500	M																														
RC1378A	HOSE CLAMP		KVE1135A	SERIES 5/5E VENTURI KIT	<table border="1"> <thead> <tr> <th>Code</th> <th>Description</th> <th>Qty</th> <th>UOM</th> </tr> </thead> <tbody> <tr> <td>GN1556A0</td> <td>MM VENTURI SEAL</td> <td>1</td> <td>PZ</td> </tr> <tr> <td>RC1378A0</td> <td>HOSE CLAMP</td> <td>2</td> <td>PZ</td> </tr> <tr> <td>TB1520A0</td> <td>INT. Ø=38 TH=4 DRAIN BLACK RUBBER PIPE</td> <td>0.050</td> <td>M</td> </tr> <tr> <td>VE1135A0</td> <td>220 V 50/60 HZ VENTURI ACTUATOR</td> <td>1</td> <td>PZ</td> </tr> </tbody> </table>	Code	Description	Qty	UOM	GN1556A0	MM VENTURI SEAL	1	PZ	RC1378A0	HOSE CLAMP	2	PZ	TB1520A0	INT. Ø=38 TH=4 DRAIN BLACK RUBBER PIPE	0.050	M	VE1135A0	220 V 50/60 HZ VENTURI ACTUATOR	1	PZ								
Code	Description	Qty	UOM																														
GN1556A0	MM VENTURI SEAL	1	PZ																														
RC1378A0	HOSE CLAMP	2	PZ																														
TB1520A0	INT. Ø=38 TH=4 DRAIN BLACK RUBBER PIPE	0.050	M																														
VE1135A0	220 V 50/60 HZ VENTURI ACTUATOR	1	PZ																														

COMPONENT			SPARE PART																																														
Code	Description	Image	Code	Description	Components list																																												
RC1378A	HOSE CLAMP		KVE1135A	SERIES 5/5E VENTURI KIT	<table border="1"> <thead> <tr> <th>Code</th> <th>Description</th> <th>Qty</th> <th>UOM</th> </tr> </thead> <tbody> <tr> <td>VI1032A0</td> <td>SCREW M4X16 TCB+ INOX</td> <td>1</td> <td>PZ</td> </tr> <tr> <td>VI1511A0</td> <td>STAINLESS STEEL WASHER 4.2X12X1</td> <td>2</td> <td>PZ</td> </tr> <tr> <td>VI1850A0</td> <td>M4X6 NICKEL PLATED FIXING SCRE</td> <td>2</td> <td>PZ</td> </tr> <tr> <td>VI1865A0</td> <td>5X10 TCB+ SELF-THREADI NG SCREW</td> <td>3</td> <td>PZ</td> </tr> <tr> <td>VI1965A0</td> <td></td> <td>2</td> <td>PZ</td> </tr> <tr> <td>VM1224A0</td> <td></td> <td>0.250</td> <td>M</td> </tr> <tr> <td>VM1565B0</td> <td>VENTURI LOWER COIL SUPPORT</td> <td>1</td> <td>PZ</td> </tr> <tr> <td>VM1566A0</td> <td>VENTURI UPPER COIL SUPPORT</td> <td>1</td> <td>PZ</td> </tr> <tr> <td>VM1567A0</td> <td>VENTURI LOWER BUSHING</td> <td>1</td> <td>PZ</td> </tr> <tr> <td>VM1568A0</td> <td>VENTURI PLATE SPACE</td> <td>1</td> <td>PZ</td> </tr> </tbody> </table>	Code	Description	Qty	UOM	VI1032A0	SCREW M4X16 TCB+ INOX	1	PZ	VI1511A0	STAINLESS STEEL WASHER 4.2X12X1	2	PZ	VI1850A0	M4X6 NICKEL PLATED FIXING SCRE	2	PZ	VI1865A0	5X10 TCB+ SELF-THREADI NG SCREW	3	PZ	VI1965A0		2	PZ	VM1224A0		0.250	M	VM1565B0	VENTURI LOWER COIL SUPPORT	1	PZ	VM1566A0	VENTURI UPPER COIL SUPPORT	1	PZ	VM1567A0	VENTURI LOWER BUSHING	1	PZ	VM1568A0	VENTURI PLATE SPACE	1	PZ
Code	Description	Qty	UOM																																														
VI1032A0	SCREW M4X16 TCB+ INOX	1	PZ																																														
VI1511A0	STAINLESS STEEL WASHER 4.2X12X1	2	PZ																																														
VI1850A0	M4X6 NICKEL PLATED FIXING SCRE	2	PZ																																														
VI1865A0	5X10 TCB+ SELF-THREADI NG SCREW	3	PZ																																														
VI1965A0		2	PZ																																														
VM1224A0		0.250	M																																														
VM1565B0	VENTURI LOWER COIL SUPPORT	1	PZ																																														
VM1566A0	VENTURI UPPER COIL SUPPORT	1	PZ																																														
VM1567A0	VENTURI LOWER BUSHING	1	PZ																																														
VM1568A0	VENTURI PLATE SPACE	1	PZ																																														
GN1544A	AIR INLET GASKET		KTB3128A	XECC-1013-E VENTURI COLLECTOR PIPE KI	<table border="1"> <thead> <tr> <th>Code</th> <th>Description</th> <th>Qty</th> <th>UOM</th> </tr> </thead> <tbody> <tr> <td>GN1544A0</td> <td>AIR INLET GASKET</td> <td>1</td> <td>PZ</td> </tr> <tr> <td>GN1584A0</td> <td>CORNER FITTING D30-D16</td> <td>1</td> <td>PZ</td> </tr> <tr> <td>TB3128A0</td> <td>XECC-10 VENTURI AIR EXIT PIPE</td> <td>1</td> <td>PZ</td> </tr> </tbody> </table>	Code	Description	Qty	UOM	GN1544A0	AIR INLET GASKET	1	PZ	GN1584A0	CORNER FITTING D30-D16	1	PZ	TB3128A0	XECC-10 VENTURI AIR EXIT PIPE	1	PZ																												
Code	Description	Qty	UOM																																														
GN1544A0	AIR INLET GASKET	1	PZ																																														
GN1584A0	CORNER FITTING D30-D16	1	PZ																																														
TB3128A0	XECC-10 VENTURI AIR EXIT PIPE	1	PZ																																														
			KTB3074B	XEVC-0711-G VENTURI COLLECTOR PIPE KI	<table border="1"> <thead> <tr> <th>Code</th> <th>Description</th> <th>Qty</th> <th>UOM</th> </tr> </thead> <tbody> <tr> <td>GN1544A0</td> <td>AIR INLET GASKET</td> <td>1</td> <td>PZ</td> </tr> <tr> <td>GN1584A0</td> <td>CORNER FITTING D30-D16</td> <td>1</td> <td>PZ</td> </tr> <tr> <td>RC1042A0</td> <td>DOUBLE WIRE SPRING CLAMP D21.5-22.6</td> <td>1</td> <td>PZ</td> </tr> <tr> <td>TB3074B0</td> <td>XEVC-07EU-G VENTURI COLLECTOR PIPE D30</td> <td>1</td> <td>PZ</td> </tr> <tr> <td>VM1794A0</td> <td>250X4.8 PA66 BLACK CLAMP</td> <td>1</td> <td>PZ</td> </tr> </tbody> </table>	Code	Description	Qty	UOM	GN1544A0	AIR INLET GASKET	1	PZ	GN1584A0	CORNER FITTING D30-D16	1	PZ	RC1042A0	DOUBLE WIRE SPRING CLAMP D21.5-22.6	1	PZ	TB3074B0	XEVC-07EU-G VENTURI COLLECTOR PIPE D30	1	PZ	VM1794A0	250X4.8 PA66 BLACK CLAMP	1	PZ																				
Code	Description	Qty	UOM																																														
GN1544A0	AIR INLET GASKET	1	PZ																																														
GN1584A0	CORNER FITTING D30-D16	1	PZ																																														
RC1042A0	DOUBLE WIRE SPRING CLAMP D21.5-22.6	1	PZ																																														
TB3074B0	XEVC-07EU-G VENTURI COLLECTOR PIPE D30	1	PZ																																														
VM1794A0	250X4.8 PA66 BLACK CLAMP	1	PZ																																														

COMPONENT			SPARE PART																										
Code	Description	Image	Code	Description	Components list																								
GN1544A	AIR INLET GASKET		KTB3068B	10FS/EU/2-G VENTURI COLLECTOR PIPE KI	<table border="1"> <thead> <tr> <th>Code</th> <th>Description</th> <th>Qty</th> <th>UOM</th> </tr> </thead> <tbody> <tr> <td>GN1544A0</td> <td>AIR INLET GASKET</td> <td>2</td> <td>PZ</td> </tr> <tr> <td>GN1584A0</td> <td>CORNER FITTING D30-D16</td> <td>1</td> <td>PZ</td> </tr> <tr> <td>RC1042A0</td> <td>DOUBLE WIRE SPRING CLAMP D21.5-22.6</td> <td>1</td> <td>PZ</td> </tr> <tr> <td>TB3068B0</td> <td>XEBC-10 VENTURI AIR COLLECTOR PIPE D30</td> <td>1</td> <td>PZ</td> </tr> <tr> <td>VM1794A0</td> <td>250X4.8 PA66 BLACK CLAMP</td> <td>1</td> <td>PZ</td> </tr> </tbody> </table>	Code	Description	Qty	UOM	GN1544A0	AIR INLET GASKET	2	PZ	GN1584A0	CORNER FITTING D30-D16	1	PZ	RC1042A0	DOUBLE WIRE SPRING CLAMP D21.5-22.6	1	PZ	TB3068B0	XEBC-10 VENTURI AIR COLLECTOR PIPE D30	1	PZ	VM1794A0	250X4.8 PA66 BLACK CLAMP	1	PZ
					Code	Description	Qty	UOM																					
					GN1544A0	AIR INLET GASKET	2	PZ																					
					GN1584A0	CORNER FITTING D30-D16	1	PZ																					
			RC1042A0	DOUBLE WIRE SPRING CLAMP D21.5-22.6	1	PZ																							
			TB3068B0	XEBC-10 VENTURI AIR COLLECTOR PIPE D30	1	PZ																							
			VM1794A0	250X4.8 PA66 BLACK CLAMP	1	PZ																							
			KTB3019A	20XX/16XX UPPER VENTURI COLLECT PIPE KIT	<table border="1"> <thead> <tr> <th>Code</th> <th>Description</th> <th>Qty</th> <th>UOM</th> </tr> </thead> <tbody> <tr> <td>GN1544A0</td> <td>AIR INLET GASKET</td> <td>1</td> <td>PZ</td> </tr> <tr> <td>GN1584A0</td> <td>CORNER FITTING D30-D16</td> <td>1</td> <td>PZ</td> </tr> <tr> <td>RC1042A0</td> <td>DOUBLE WIRE SPRING CLAMP D21.5-22.6</td> <td>1</td> <td>PZ</td> </tr> <tr> <td>TB3019A1</td> <td>XEVC-2011 UPPER AIR INLET PIPE D3</td> <td>1</td> <td>PZ</td> </tr> <tr> <td>VM1794A0</td> <td>250X4.8 PA66 BLACK CLAMP</td> <td>1</td> <td>PZ</td> </tr> </tbody> </table>	Code	Description	Qty	UOM	GN1544A0	AIR INLET GASKET	1	PZ	GN1584A0	CORNER FITTING D30-D16	1	PZ	RC1042A0	DOUBLE WIRE SPRING CLAMP D21.5-22.6	1	PZ	TB3019A1	XEVC-2011 UPPER AIR INLET PIPE D3	1	PZ	VM1794A0	250X4.8 PA66 BLACK CLAMP	1	PZ
					Code	Description	Qty	UOM																					
					GN1544A0	AIR INLET GASKET	1	PZ																					
					GN1584A0	CORNER FITTING D30-D16	1	PZ																					
			RC1042A0	DOUBLE WIRE SPRING CLAMP D21.5-22.6	1	PZ																							
TB3019A1	XEVC-2011 UPPER AIR INLET PIPE D3	1	PZ																										
VM1794A0	250X4.8 PA66 BLACK CLAMP	1	PZ																										
KTB2979C	XEBC-10XX-E VENTURI COLLECTOR PIPE KI	<table border="1"> <thead> <tr> <th>Code</th> <th>Description</th> <th>Qty</th> <th>UOM</th> </tr> </thead> <tbody> <tr> <td>GN1544A0</td> <td>AIR INLET GASKET</td> <td>2</td> <td>PZ</td> </tr> <tr> <td>GN1584A0</td> <td>CORNER FITTING D30-D16</td> <td>1</td> <td>PZ</td> </tr> <tr> <td>RC1042A0</td> <td>DOUBLE WIRE SPRING CLAMP D21.5-22.6</td> <td>1</td> <td>PZ</td> </tr> <tr> <td>TB2979C0</td> <td>XEBC-10 VENTURI AIR COLLECTOR PIPE D30</td> <td>1</td> <td>PZ</td> </tr> <tr> <td>VM1794A0</td> <td>250X4.8 PA66 BLACK CLAMP</td> <td>1</td> <td>PZ</td> </tr> </tbody> </table>	Code	Description	Qty	UOM	GN1544A0	AIR INLET GASKET	2	PZ	GN1584A0	CORNER FITTING D30-D16	1	PZ	RC1042A0	DOUBLE WIRE SPRING CLAMP D21.5-22.6	1	PZ	TB2979C0	XEBC-10 VENTURI AIR COLLECTOR PIPE D30	1	PZ	VM1794A0	250X4.8 PA66 BLACK CLAMP	1	PZ			
		Code	Description	Qty	UOM																								
		GN1544A0	AIR INLET GASKET	2	PZ																								
		GN1584A0	CORNER FITTING D30-D16	1	PZ																								
RC1042A0	DOUBLE WIRE SPRING CLAMP D21.5-22.6	1	PZ																										
TB2979C0	XEBC-10 VENTURI AIR COLLECTOR PIPE D30	1	PZ																										
VM1794A0	250X4.8 PA66 BLACK CLAMP	1	PZ																										
KTB2978B	XEBC-06 VENTURI COLLECTOR PIPE KI	<table border="1"> <thead> <tr> <th>Code</th> <th>Description</th> <th>Qty</th> <th>UOM</th> </tr> </thead> <tbody> <tr> <td>GN1544A0</td> <td>AIR INLET GASKET</td> <td>1</td> <td>PZ</td> </tr> </tbody> </table>	Code	Description	Qty	UOM	GN1544A0	AIR INLET GASKET	1	PZ																			
Code	Description	Qty	UOM																										
GN1544A0	AIR INLET GASKET	1	PZ																										







COMPONENT			SPARE PART																							
Code	Description	Image	Code	Description	Components list																					
GN1544A	AIR INLET GASKET		KTB2978B	XEBC-06 VENTURI COLLECTOR PIPE KI	<table border="1"> <thead> <tr> <th>Code</th> <th>Description</th> <th>Qty</th> <th>UOM</th> </tr> </thead> <tbody> <tr> <td>GN1584A0</td> <td>CORNER FITTING D30-D16</td> <td>1</td> <td>PZ</td> </tr> <tr> <td>RC1042A0</td> <td>DOUBLE WIRE SPRING CLAMP D21.5-22.6</td> <td>1</td> <td>PZ</td> </tr> <tr> <td>TB2978B0</td> <td>XEBC-06 VENTURI AIR COLLECTOR PIPE D30</td> <td>1</td> <td>PZ</td> </tr> <tr> <td>VM1794A0</td> <td>250X4.8 PA66 BLACK CLAMP</td> <td>1</td> <td>PZ</td> </tr> </tbody> </table>	Code	Description	Qty	UOM	GN1584A0	CORNER FITTING D30-D16	1	PZ	RC1042A0	DOUBLE WIRE SPRING CLAMP D21.5-22.6	1	PZ	TB2978B0	XEBC-06 VENTURI AIR COLLECTOR PIPE D30	1	PZ	VM1794A0	250X4.8 PA66 BLACK CLAMP	1	PZ	
			Code	Description	Qty	UOM																				
			GN1584A0	CORNER FITTING D30-D16	1	PZ																				
			RC1042A0	DOUBLE WIRE SPRING CLAMP D21.5-22.6	1	PZ																				
TB2978B0	XEBC-06 VENTURI AIR COLLECTOR PIPE D30	1	PZ																							
VM1794A0	250X4.8 PA66 BLACK CLAMP	1	PZ																							
KTB2959B	XEVC-1011-E VENTURI COLLECTOR PIPE KI	<table border="1"> <thead> <tr> <th>Code</th> <th>Description</th> <th>Qty</th> <th>UOM</th> </tr> </thead> <tbody> <tr> <td>GN1544A0</td> <td>AIR INLET GASKET</td> <td>2</td> <td>PZ</td> </tr> <tr> <td>GN1584A0</td> <td>CORNER FITTING D30-D16</td> <td>1</td> <td>PZ</td> </tr> <tr> <td>RC1042A0</td> <td>DOUBLE WIRE SPRING CLAMP D21.5-22.6</td> <td>1</td> <td>PZ</td> </tr> <tr> <td>TB2959B0</td> <td>XEVC-1011-E VENTURI PIPE</td> <td>1</td> <td>PZ</td> </tr> <tr> <td>VM1794A0</td> <td>250X4.8 PA66 BLACK CLAMP</td> <td>1</td> <td>PZ</td> </tr> </tbody> </table>	Code	Description	Qty	UOM	GN1544A0	AIR INLET GASKET	2	PZ	GN1584A0	CORNER FITTING D30-D16	1	PZ	RC1042A0	DOUBLE WIRE SPRING CLAMP D21.5-22.6	1	PZ	TB2959B0	XEVC-1011-E VENTURI PIPE	1	PZ	VM1794A0	250X4.8 PA66 BLACK CLAMP	1	PZ
Code	Description	Qty	UOM																							
GN1544A0	AIR INLET GASKET	2	PZ																							
GN1584A0	CORNER FITTING D30-D16	1	PZ																							
RC1042A0	DOUBLE WIRE SPRING CLAMP D21.5-22.6	1	PZ																							
TB2959B0	XEVC-1011-E VENTURI PIPE	1	PZ																							
VM1794A0	250X4.8 PA66 BLACK CLAMP	1	PZ																							
KTB2958B	XEVC-0711-E VENTURI COLLECTOR PIPE KI	<table border="1"> <thead> <tr> <th>Code</th> <th>Description</th> <th>Qty</th> <th>UOM</th> </tr> </thead> <tbody> <tr> <td>GN1544A0</td> <td>AIR INLET GASKET</td> <td>1</td> <td>PZ</td> </tr> <tr> <td>GN1584A0</td> <td>CORNER FITTING D30-D16</td> <td>1</td> <td>PZ</td> </tr> <tr> <td>RC1042A0</td> <td>DOUBLE WIRE SPRING CLAMP D21.5-22.6</td> <td>1</td> <td>PZ</td> </tr> <tr> <td>TB2958B0</td> <td>XEVC-0711-E VENTURI PIPE</td> <td>1</td> <td>PZ</td> </tr> <tr> <td>VM1794A0</td> <td>250X4.8 PA66 BLACK CLAMP</td> <td>1</td> <td>PZ</td> </tr> </tbody> </table>	Code	Description	Qty	UOM	GN1544A0	AIR INLET GASKET	1	PZ	GN1584A0	CORNER FITTING D30-D16	1	PZ	RC1042A0	DOUBLE WIRE SPRING CLAMP D21.5-22.6	1	PZ	TB2958B0	XEVC-0711-E VENTURI PIPE	1	PZ	VM1794A0	250X4.8 PA66 BLACK CLAMP	1	PZ
Code	Description	Qty	UOM																							
GN1544A0	AIR INLET GASKET	1	PZ																							
GN1584A0	CORNER FITTING D30-D16	1	PZ																							
RC1042A0	DOUBLE WIRE SPRING CLAMP D21.5-22.6	1	PZ																							
TB2958B0	XEVC-0711-E VENTURI PIPE	1	PZ																							
VM1794A0	250X4.8 PA66 BLACK CLAMP	1	PZ																							
KTB2957B	0511/04EU-E VENTURI COLLECTOR PIPE KI	<table border="1"> <thead> <tr> <th>Code</th> <th>Description</th> <th>Qty</th> <th>UOM</th> </tr> </thead> <tbody> <tr> <td>GN1544A0</td> <td>AIR INLET GASKET</td> <td>1</td> <td>PZ</td> </tr> <tr> <td>GN1584A0</td> <td>CORNER FITTING D30-D16</td> <td>1</td> <td>PZ</td> </tr> <tr> <td>RC1042A0</td> <td>DOUBLE WIRE SPRING CLAMP D21.5-22.6</td> <td>1</td> <td>PZ</td> </tr> </tbody> </table>	Code	Description	Qty	UOM	GN1544A0	AIR INLET GASKET	1	PZ	GN1584A0	CORNER FITTING D30-D16	1	PZ	RC1042A0	DOUBLE WIRE SPRING CLAMP D21.5-22.6	1	PZ								
Code	Description	Qty	UOM																							
GN1544A0	AIR INLET GASKET	1	PZ																							
GN1584A0	CORNER FITTING D30-D16	1	PZ																							
RC1042A0	DOUBLE WIRE SPRING CLAMP D21.5-22.6	1	PZ																							

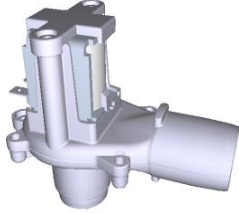
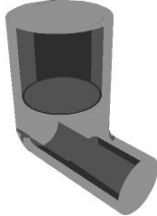

COMPONENT			SPARE PART																										
Code	Description	Image	Code	Description	Components list																								
GN1544A	AIR INLET GASKET		KTB2957B	0511/04EU-E VENTURI COLLECTOR PIPE KI	<table border="1"> <thead> <tr> <th>Code</th> <th>Description</th> <th>Qty</th> <th>UOM</th> </tr> </thead> <tbody> <tr> <td>TB2957B0</td> <td>XEVC-0511-E VENTURI PIPE</td> <td>1</td> <td>PZ</td> </tr> <tr> <td>VM1794A0</td> <td>250X4.8 PA66 BLACK CLAMP</td> <td>1</td> <td>PZ</td> </tr> </tbody> </table>	Code	Description	Qty	UOM	TB2957B0	XEVC-0511-E VENTURI PIPE	1	PZ	VM1794A0	250X4.8 PA66 BLACK CLAMP	1	PZ												
			Code	Description	Qty	UOM																							
			TB2957B0	XEVC-0511-E VENTURI PIPE	1	PZ																							
			VM1794A0	250X4.8 PA66 BLACK CLAMP	1	PZ																							
			KTB2956A	XEVC-0311-E VENTURI COLLECTOR PIPE KI	<table border="1"> <thead> <tr> <th>Code</th> <th>Description</th> <th>Qty</th> <th>UOM</th> </tr> </thead> <tbody> <tr> <td>GN1544A0</td> <td>AIR INLET GASKET</td> <td>1</td> <td>PZ</td> </tr> <tr> <td>RC1042A0</td> <td>DOUBLE WIRE SPRING CLAMP D21.5-22.6</td> <td>1</td> <td>PZ</td> </tr> <tr> <td>TB2956A0</td> <td>XEVC-0311-E VENTURI PIPE</td> <td>1</td> <td>PZ</td> </tr> </tbody> </table>	Code	Description	Qty	UOM	GN1544A0	AIR INLET GASKET	1	PZ	RC1042A0	DOUBLE WIRE SPRING CLAMP D21.5-22.6	1	PZ	TB2956A0	XEVC-0311-E VENTURI PIPE	1	PZ								
			Code	Description	Qty	UOM																							
			GN1544A0	AIR INLET GASKET	1	PZ																							
			RC1042A0	DOUBLE WIRE SPRING CLAMP D21.5-22.6	1	PZ																							
			TB2956A0	XEVC-0311-E VENTURI PIPE	1	PZ																							
			KTB2944A	20XX/16XX LOWER VENTURI COLLECT PIPE KIT	<table border="1"> <thead> <tr> <th>Code</th> <th>Description</th> <th>Qty</th> <th>UOM</th> </tr> </thead> <tbody> <tr> <td>GN1544A0</td> <td>AIR INLET GASKET</td> <td>2</td> <td>PZ</td> </tr> <tr> <td>GN1584A0</td> <td>CORNER FITTING D30-D16</td> <td>1</td> <td>PZ</td> </tr> <tr> <td>RC1042A0</td> <td>DOUBLE WIRE SPRING CLAMP D21.5-22.6</td> <td>1</td> <td>PZ</td> </tr> <tr> <td>TB2944A1</td> <td>XEVC-2011 AIR INLET PIPE D3</td> <td>1</td> <td>PZ</td> </tr> <tr> <td>VM1794A0</td> <td>250X4.8 PA66 BLACK CLAMP</td> <td>1</td> <td>PZ</td> </tr> </tbody> </table>	Code	Description	Qty	UOM	GN1544A0	AIR INLET GASKET	2	PZ	GN1584A0	CORNER FITTING D30-D16	1	PZ	RC1042A0	DOUBLE WIRE SPRING CLAMP D21.5-22.6	1	PZ	TB2944A1	XEVC-2011 AIR INLET PIPE D3	1	PZ	VM1794A0	250X4.8 PA66 BLACK CLAMP	1	PZ
			Code	Description	Qty	UOM																							
			GN1544A0	AIR INLET GASKET	2	PZ																							
GN1584A0	CORNER FITTING D30-D16	1	PZ																										
RC1042A0	DOUBLE WIRE SPRING CLAMP D21.5-22.6	1	PZ																										
TB2944A1	XEVC-2011 AIR INLET PIPE D3	1	PZ																										
VM1794A0	250X4.8 PA66 BLACK CLAMP	1	PZ																										
KTB1323A	XECC-05XX-E VENTURI COLLECTOR PIPE KI	<table border="1"> <thead> <tr> <th>Code</th> <th>Description</th> <th>Qty</th> <th>UOM</th> </tr> </thead> <tbody> <tr> <td>GN1544A0</td> <td>AIR INLET GASKET</td> <td>1</td> <td>PZ</td> </tr> <tr> <td>GN1584A0</td> <td>CORNER FITTING D30-D16</td> <td>1</td> <td>PZ</td> </tr> <tr> <td>RC1042A0</td> <td>DOUBLE WIRE SPRING CLAMP D21.5-22.6</td> <td>1</td> <td>PZ</td> </tr> <tr> <td>TB1323A1</td> <td>XECC-05XX VENTURI AIR EXIT PIPE</td> <td>1</td> <td>PZ</td> </tr> </tbody> </table>	Code	Description	Qty	UOM	GN1544A0	AIR INLET GASKET	1	PZ	GN1584A0	CORNER FITTING D30-D16	1	PZ	RC1042A0	DOUBLE WIRE SPRING CLAMP D21.5-22.6	1	PZ	TB1323A1	XECC-05XX VENTURI AIR EXIT PIPE	1	PZ							
Code	Description	Qty	UOM																										
GN1544A0	AIR INLET GASKET	1	PZ																										
GN1584A0	CORNER FITTING D30-D16	1	PZ																										
RC1042A0	DOUBLE WIRE SPRING CLAMP D21.5-22.6	1	PZ																										
TB1323A1	XECC-05XX VENTURI AIR EXIT PIPE	1	PZ																										
KG1544A	5 PCS AIR INLET GASKET KIT	<table border="1"> <thead> <tr> <th>Code</th> <th>Description</th> <th>Qty</th> <th>UOM</th> </tr> </thead> <tbody> <tr> <td>GN1544A0</td> <td>AIR INLET GASKET</td> <td>5</td> <td>PZ</td> </tr> <tr> <td>VM1224A0</td> <td></td> <td>0.200</td> <td>M</td> </tr> </tbody> </table>	Code	Description	Qty	UOM	GN1544A0	AIR INLET GASKET	5	PZ	VM1224A0		0.200	M															
Code	Description	Qty	UOM																										
GN1544A0	AIR INLET GASKET	5	PZ																										
VM1224A0		0.200	M																										

COMPONENT			SPARE PART																																																																										
Code	Description	Image	Code	Description	Components list																																																																								
VM2377A	220 V 50/60 HZ VENTURI KIT		KVM2377A	MM 220 V VENTURI ACTUATOR SYSTEM KIT	<table border="1"> <thead> <tr> <th>Code</th> <th>Description</th> <th>Qty</th> <th>UOM</th> </tr> </thead> <tbody> <tr> <td>GN1556A0</td> <td>MM VENTURI SEAL</td> <td>1</td> <td>PZ</td> </tr> <tr> <td>RC1378A0</td> <td>HOSE CLAMP</td> <td>3</td> <td>PZ</td> </tr> <tr> <td>TB1520A0</td> <td>INT. Ø=38 TH=4 DRAIN BLACK RUBBER PIPE</td> <td>0.170</td> <td>M</td> </tr> <tr> <td>VE1135A0</td> <td>220 V 50/60 HZ VENTURI ACTUATOR</td> <td>1</td> <td>PZ</td> </tr> <tr> <td>VI1032A0</td> <td>SCREW M4X16 TCB+ INOX</td> <td>1</td> <td>PZ</td> </tr> <tr> <td>VI1220A1</td> <td>4,2X12 TCB SELF-TAPPIN G SCREW</td> <td>6</td> <td>PZ</td> </tr> <tr> <td>VM2345A0</td> <td>MM VENTURI UPPER BODY</td> <td>1</td> <td>PZ</td> </tr> <tr> <td>VM2345A0</td> <td>MM VENTURI UPPER BODY</td> <td>1</td> <td>PZ</td> </tr> <tr> <td>VM2346A0</td> <td>MM VENTURI LOWER BODY</td> <td>1</td> <td>PZ</td> </tr> <tr> <td>VM2346A0</td> <td>MM VENTURI LOWER BODY</td> <td>1</td> <td>PZ</td> </tr> <tr> <td>VM2346A1</td> <td>S6 VENTURI LOWER HALF</td> <td>1</td> <td>PZ</td> </tr> <tr> <td>VM2347A0</td> <td>VENTURI MIND.MAPS COVER</td> <td>1</td> <td>PZ</td> </tr> <tr> <td>VM2347A0</td> <td>VENTURI MIND.MAPS COVER</td> <td>1</td> <td>PZ</td> </tr> <tr> <td>VM2348A0</td> <td>VENTURI PLATE SPACE</td> <td>1</td> <td>PZ</td> </tr> <tr> <td>VM2348A0</td> <td>VENTURI PLATE SPACE</td> <td>1</td> <td>PZ</td> </tr> <tr> <td>VM2349A0</td> <td>VENTURI LOWER BUSHING</td> <td>1</td> <td>PZ</td> </tr> <tr> <td>VM2349A0</td> <td>VENTURI LOWER BUSHING</td> <td>1</td> <td>PZ</td> </tr> </tbody> </table>	Code	Description	Qty	UOM	GN1556A0	MM VENTURI SEAL	1	PZ	RC1378A0	HOSE CLAMP	3	PZ	TB1520A0	INT. Ø=38 TH=4 DRAIN BLACK RUBBER PIPE	0.170	M	VE1135A0	220 V 50/60 HZ VENTURI ACTUATOR	1	PZ	VI1032A0	SCREW M4X16 TCB+ INOX	1	PZ	VI1220A1	4,2X12 TCB SELF-TAPPIN G SCREW	6	PZ	VM2345A0	MM VENTURI UPPER BODY	1	PZ	VM2345A0	MM VENTURI UPPER BODY	1	PZ	VM2346A0	MM VENTURI LOWER BODY	1	PZ	VM2346A0	MM VENTURI LOWER BODY	1	PZ	VM2346A1	S6 VENTURI LOWER HALF	1	PZ	VM2347A0	VENTURI MIND.MAPS COVER	1	PZ	VM2347A0	VENTURI MIND.MAPS COVER	1	PZ	VM2348A0	VENTURI PLATE SPACE	1	PZ	VM2348A0	VENTURI PLATE SPACE	1	PZ	VM2349A0	VENTURI LOWER BUSHING	1	PZ	VM2349A0	VENTURI LOWER BUSHING	1	PZ
					Code	Description	Qty	UOM																																																																					
					GN1556A0	MM VENTURI SEAL	1	PZ																																																																					
					RC1378A0	HOSE CLAMP	3	PZ																																																																					
					TB1520A0	INT. Ø=38 TH=4 DRAIN BLACK RUBBER PIPE	0.170	M																																																																					
					VE1135A0	220 V 50/60 HZ VENTURI ACTUATOR	1	PZ																																																																					
					VI1032A0	SCREW M4X16 TCB+ INOX	1	PZ																																																																					
					VI1220A1	4,2X12 TCB SELF-TAPPIN G SCREW	6	PZ																																																																					
					VM2345A0	MM VENTURI UPPER BODY	1	PZ																																																																					
					VM2345A0	MM VENTURI UPPER BODY	1	PZ																																																																					
					VM2346A0	MM VENTURI LOWER BODY	1	PZ																																																																					
					VM2346A0	MM VENTURI LOWER BODY	1	PZ																																																																					
					VM2346A1	S6 VENTURI LOWER HALF	1	PZ																																																																					
					VM2347A0	VENTURI MIND.MAPS COVER	1	PZ																																																																					
					VM2347A0	VENTURI MIND.MAPS COVER	1	PZ																																																																					
					VM2348A0	VENTURI PLATE SPACE	1	PZ																																																																					
					VM2348A0	VENTURI PLATE SPACE	1	PZ																																																																					
					VM2349A0	VENTURI LOWER BUSHING	1	PZ																																																																					
					VM2349A0	VENTURI LOWER BUSHING	1	PZ																																																																					
					GN1584A	CORNER FITTING D30-D16		KGN1584A	D30-D16 CORNER FITTING KIT	<table border="1"> <thead> <tr> <th>Code</th> <th>Description</th> <th>Qty</th> <th>UOM</th> </tr> </thead> <tbody> <tr> <td>GN1584A0</td> <td>CORNER FITTING D30-D16</td> <td>1</td> <td>PZ</td> </tr> <tr> <td>VM1224A0</td> <td></td> <td>0.150</td> <td>M</td> </tr> </tbody> </table>	Code	Description	Qty	UOM	GN1584A0	CORNER FITTING D30-D16	1	PZ	VM1224A0		0.150	M																																																							
Code	Description	Qty	UOM																																																																										
GN1584A0	CORNER FITTING D30-D16	1	PZ																																																																										
VM1224A0		0.150	M																																																																										



COMPONENT			SPARE PART																																		
Code	Description	Image	Code	Description	Components list																																
TB2603A	TB1520A0- VENTURI FAN 0,12M		KTB2603A	VENTURI-COOLING FAN CONNECT. KIT TB1520A	<table border="1"> <thead> <tr> <th>Code</th> <th>Description</th> <th>Qty</th> <th>UOM</th> </tr> </thead> <tbody> <tr> <td>TB1520A0</td> <td>INT. Ø=38 TH=4 DRAIN BLACK RUBBER PIPE</td> <td>0.120</td> <td>M</td> </tr> </tbody> </table>	Code	Description	Qty	UOM	TB1520A0	INT. Ø=38 TH=4 DRAIN BLACK RUBBER PIPE	0.120	M																								
Code	Description	Qty	UOM																																		
TB1520A0	INT. Ø=38 TH=4 DRAIN BLACK RUBBER PIPE	0.120	M																																		
TB1956A	TB1520A-GREY SILICONE PIPE L=0,04M		<p>KTB1002A</p> <p>KTB1001A</p> <p>KTB1000A</p>	<p>BLACK TUBE KIT EPDM 60MT TB1520</p> <p>BLACK TUBE KIT EPDM 10MT TB1520</p> <p>BLACK TUBE KIT EPDM 2MT TB1520A</p>	<table border="1"> <thead> <tr> <th>Code</th> <th>Description</th> <th>Qty</th> <th>UOM</th> </tr> </thead> <tbody> <tr> <td>IL1206C0</td> <td>968X1053 H126 XBC WOOD PALLE</td> <td>1</td> <td>PZ</td> </tr> <tr> <td>TB1520A0</td> <td>INT. Ø=38 TH=4 DRAIN BLACK RUBBER PIPE</td> <td>60</td> <td>M</td> </tr> <tr> <td>TB1520A0</td> <td>INT. Ø=38 TH=4 DRAIN BLACK RUBBER PIPE</td> <td>10</td> <td>M</td> </tr> <tr> <td>VM1794A0</td> <td>250X4.8 PA66 BLACK CLAMP</td> <td>3</td> <td>PZ</td> </tr> <tr> <td>RC1055A0</td> <td>Ø25-40 H12 STAINLESS STEEL PIPE CLIP</td> <td>2</td> <td>PZ</td> </tr> <tr> <td>TB1520A0</td> <td>INT. Ø=38 TH=4 DRAIN BLACK RUBBER PIPE</td> <td>2</td> <td>M</td> </tr> <tr> <td>VM1059A1</td> <td>HEAT SHRINK FILM H800</td> <td>1.500</td> <td>M</td> </tr> </tbody> </table>	Code	Description	Qty	UOM	IL1206C0	968X1053 H126 XBC WOOD PALLE	1	PZ	TB1520A0	INT. Ø=38 TH=4 DRAIN BLACK RUBBER PIPE	60	M	TB1520A0	INT. Ø=38 TH=4 DRAIN BLACK RUBBER PIPE	10	M	VM1794A0	250X4.8 PA66 BLACK CLAMP	3	PZ	RC1055A0	Ø25-40 H12 STAINLESS STEEL PIPE CLIP	2	PZ	TB1520A0	INT. Ø=38 TH=4 DRAIN BLACK RUBBER PIPE	2	M	VM1059A1	HEAT SHRINK FILM H800	1.500	M
Code	Description	Qty	UOM																																		
IL1206C0	968X1053 H126 XBC WOOD PALLE	1	PZ																																		
TB1520A0	INT. Ø=38 TH=4 DRAIN BLACK RUBBER PIPE	60	M																																		
TB1520A0	INT. Ø=38 TH=4 DRAIN BLACK RUBBER PIPE	10	M																																		
VM1794A0	250X4.8 PA66 BLACK CLAMP	3	PZ																																		
RC1055A0	Ø25-40 H12 STAINLESS STEEL PIPE CLIP	2	PZ																																		
TB1520A0	INT. Ø=38 TH=4 DRAIN BLACK RUBBER PIPE	2	M																																		
VM1059A1	HEAT SHRINK FILM H800	1.500	M																																		
RC1042A	DOUBLE WIRE SPRING CLAMP D21.5-22.6		RC1042A0	DOUBLE WIRE SPRING CLAMP D21.5-22.6																																	



COMPONENT			SPARE PART																																		
Code	Description	Image	Code	Description	Components list																																
TB2978B	XEBC-06 VENTURI AIR COLLECTOR PIPE D30		KTB2978B	XEBC-06 VENTURI COLLECTOR PIPE KI	<table border="1"> <thead> <tr> <th>Code</th> <th>Description</th> <th>Qty</th> <th>UOM</th> </tr> </thead> <tbody> <tr> <td>GN1544A0</td> <td>AIR INLET GASKET</td> <td>1</td> <td>PZ</td> </tr> <tr> <td>GN1584A0</td> <td>CORNER FITTING D30-D16</td> <td>1</td> <td>PZ</td> </tr> <tr> <td>RC1042A0</td> <td>DOUBLE WIRE SPRING CLAMP D21.5-22.6</td> <td>1</td> <td>PZ</td> </tr> <tr> <td>TB2978B0</td> <td>XEBC-06 VENTURI AIR COLLECTOR PIPE D30</td> <td>1</td> <td>PZ</td> </tr> <tr> <td>VM1794A0</td> <td>250X4.8 PA66 BLACK CLAMP</td> <td>1</td> <td>PZ</td> </tr> </tbody> </table>	Code	Description	Qty	UOM	GN1544A0	AIR INLET GASKET	1	PZ	GN1584A0	CORNER FITTING D30-D16	1	PZ	RC1042A0	DOUBLE WIRE SPRING CLAMP D21.5-22.6	1	PZ	TB2978B0	XEBC-06 VENTURI AIR COLLECTOR PIPE D30	1	PZ	VM1794A0	250X4.8 PA66 BLACK CLAMP	1	PZ								
Code	Description	Qty	UOM																																		
GN1544A0	AIR INLET GASKET	1	PZ																																		
GN1584A0	CORNER FITTING D30-D16	1	PZ																																		
RC1042A0	DOUBLE WIRE SPRING CLAMP D21.5-22.6	1	PZ																																		
TB2978B0	XEBC-06 VENTURI AIR COLLECTOR PIPE D30	1	PZ																																		
VM1794A0	250X4.8 PA66 BLACK CLAMP	1	PZ																																		
GN1285A	NTC TEMPERATURE PROBE SEALING		KTR1106B	MIND.MAPS L2000 CHAMBER TEMP. PROBE KIT	<table border="1"> <thead> <tr> <th>Code</th> <th>Description</th> <th>Qty</th> <th>UOM</th> </tr> </thead> <tbody> <tr> <td>GN1285A0</td> <td>NTC TEMPERATUR E PROBE SEALING</td> <td>1</td> <td>PZ</td> </tr> <tr> <td>SL1045A0</td> <td>S57 BLACK SILICONE - 80ML CARTRIDGE</td> <td>1</td> <td>PZ</td> </tr> <tr> <td>TR1106B0</td> <td></td> <td>1</td> <td>PZ</td> </tr> <tr> <td>VI1220A1</td> <td>4,2X12 TCB SELF-TAPPIN G SCREW</td> <td>2</td> <td>PZ</td> </tr> <tr> <td>VM1464A1</td> <td>CT BT TEMPERATUR E PROBE COVER</td> <td>1</td> <td>PZ</td> </tr> <tr> <td>VM1465A0</td> <td>CHEFTOP TEMPERATUR E PROBE COVER</td> <td>1</td> <td>PZ</td> </tr> <tr> <td>VM1465A1</td> <td>CT BT TEMPERATUR E PROBE COVER</td> <td>1</td> <td>PZ</td> </tr> </tbody> </table>	Code	Description	Qty	UOM	GN1285A0	NTC TEMPERATUR E PROBE SEALING	1	PZ	SL1045A0	S57 BLACK SILICONE - 80ML CARTRIDGE	1	PZ	TR1106B0		1	PZ	VI1220A1	4,2X12 TCB SELF-TAPPIN G SCREW	2	PZ	VM1464A1	CT BT TEMPERATUR E PROBE COVER	1	PZ	VM1465A0	CHEFTOP TEMPERATUR E PROBE COVER	1	PZ	VM1465A1	CT BT TEMPERATUR E PROBE COVER	1	PZ
Code	Description	Qty	UOM																																		
GN1285A0	NTC TEMPERATUR E PROBE SEALING	1	PZ																																		
SL1045A0	S57 BLACK SILICONE - 80ML CARTRIDGE	1	PZ																																		
TR1106B0		1	PZ																																		
VI1220A1	4,2X12 TCB SELF-TAPPIN G SCREW	2	PZ																																		
VM1464A1	CT BT TEMPERATUR E PROBE COVER	1	PZ																																		
VM1465A0	CHEFTOP TEMPERATUR E PROBE COVER	1	PZ																																		
VM1465A1	CT BT TEMPERATUR E PROBE COVER	1	PZ																																		
			KTR1106A	5-5E S. L2000 CHAMBER TEMP. PROBE KIT	<table border="1"> <thead> <tr> <th>Code</th> <th>Description</th> <th>Qty</th> <th>UOM</th> </tr> </thead> <tbody> <tr> <td>GN1285A0</td> <td>NTC TEMPERATUR E PROBE SEALING</td> <td>1</td> <td>PZ</td> </tr> <tr> <td>SL1045A0</td> <td>S57 BLACK SILICONE - 80ML CARTRIDGE</td> <td>1</td> <td>PZ</td> </tr> <tr> <td>TR1106A3</td> <td>PT100 L-2000 TEMPERATUR E PROBE</td> <td>1</td> <td>PZ</td> </tr> </tbody> </table>	Code	Description	Qty	UOM	GN1285A0	NTC TEMPERATUR E PROBE SEALING	1	PZ	SL1045A0	S57 BLACK SILICONE - 80ML CARTRIDGE	1	PZ	TR1106A3	PT100 L-2000 TEMPERATUR E PROBE	1	PZ																
Code	Description	Qty	UOM																																		
GN1285A0	NTC TEMPERATUR E PROBE SEALING	1	PZ																																		
SL1045A0	S57 BLACK SILICONE - 80ML CARTRIDGE	1	PZ																																		
TR1106A3	PT100 L-2000 TEMPERATUR E PROBE	1	PZ																																		





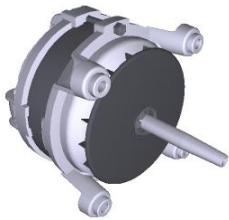

COMPONENT			SPARE PART																																							
Code	Description	Image	Code	Description	Components list																																					
GN1285A	NTC TEMPERATURE PROBE SEALING		KTR1106A	5-5E S. L2000 CHAMBER TEMP. PROBE KIT	<table border="1"> <thead> <tr> <th>Code</th> <th>Description</th> <th>Qty</th> <th>UOM</th> </tr> </thead> <tbody> <tr> <td>VI1220A1</td> <td>4,2X12 TCB SELF-TAPPIN G SCREW</td> <td>2</td> <td>PZ</td> </tr> <tr> <td>VM1465A0</td> <td>CHEFTOP TEMPERATUR E PROBE COVER</td> <td>1</td> <td>PZ</td> </tr> <tr> <td>VM1465A1</td> <td>CT BT TEMPERATUR E PROBE COVER</td> <td>1</td> <td>PZ</td> </tr> </tbody> </table>	Code	Description	Qty	UOM	VI1220A1	4,2X12 TCB SELF-TAPPIN G SCREW	2	PZ	VM1465A0	CHEFTOP TEMPERATUR E PROBE COVER	1	PZ	VM1465A1	CT BT TEMPERATUR E PROBE COVER	1	PZ																					
			Code	Description	Qty	UOM																																				
			VI1220A1	4,2X12 TCB SELF-TAPPIN G SCREW	2	PZ																																				
VM1465A0	CHEFTOP TEMPERATUR E PROBE COVER	1	PZ																																							
VM1465A1	CT BT TEMPERATUR E PROBE COVER	1	PZ																																							
KTR1105A	PT100 L1000 TEMPERATURE PROBE KIT	<table border="1"> <thead> <tr> <th>Code</th> <th>Description</th> <th>Qty</th> <th>UOM</th> </tr> </thead> <tbody> <tr> <td>GN1120A0</td> <td>TEMPERATUR E PROBE NTC SEAL</td> <td>1</td> <td>PZ</td> </tr> <tr> <td>GN1120A1</td> <td></td> <td>1</td> <td>PZ</td> </tr> <tr> <td>GN1285A0</td> <td>NTC TEMPERATUR E PROBE SEALING</td> <td>1</td> <td>PZ</td> </tr> <tr> <td>SL1045A0</td> <td>S57 BLACK SILICONE - 80ML CARTRIDGE</td> <td>1</td> <td>PZ</td> </tr> <tr> <td>TR1105A4</td> <td></td> <td>1</td> <td>PZ</td> </tr> <tr> <td>VI1220A1</td> <td>4,2X12 TCB SELF-TAPPIN G SCREW</td> <td>2</td> <td>PZ</td> </tr> <tr> <td>VM1464A1</td> <td>CT BT TEMPERATUR E PROBE COVER</td> <td>1</td> <td>PZ</td> </tr> <tr> <td>VM1465A1</td> <td>CT BT TEMPERATUR E PROBE COVER</td> <td>1</td> <td>PZ</td> </tr> <tr> <td>VM2052A0</td> <td>LM CORE PROBE COVE</td> <td>1</td> <td>PZ</td> </tr> </tbody> </table>	Code	Description	Qty	UOM	GN1120A0	TEMPERATUR E PROBE NTC SEAL	1	PZ	GN1120A1		1	PZ	GN1285A0	NTC TEMPERATUR E PROBE SEALING	1	PZ	SL1045A0	S57 BLACK SILICONE - 80ML CARTRIDGE	1	PZ	TR1105A4		1	PZ	VI1220A1	4,2X12 TCB SELF-TAPPIN G SCREW	2	PZ	VM1464A1	CT BT TEMPERATUR E PROBE COVER	1	PZ	VM1465A1	CT BT TEMPERATUR E PROBE COVER	1	PZ	VM2052A0	LM CORE PROBE COVE	1	PZ
Code	Description	Qty	UOM																																							
GN1120A0	TEMPERATUR E PROBE NTC SEAL	1	PZ																																							
GN1120A1		1	PZ																																							
GN1285A0	NTC TEMPERATUR E PROBE SEALING	1	PZ																																							
SL1045A0	S57 BLACK SILICONE - 80ML CARTRIDGE	1	PZ																																							
TR1105A4		1	PZ																																							
VI1220A1	4,2X12 TCB SELF-TAPPIN G SCREW	2	PZ																																							
VM1464A1	CT BT TEMPERATUR E PROBE COVER	1	PZ																																							
VM1465A1	CT BT TEMPERATUR E PROBE COVER	1	PZ																																							
VM2052A0	LM CORE PROBE COVE	1	PZ																																							
KTR1096A	NTC 150 L=1500 TEMPERATURE PROBE KIT	<table border="1"> <thead> <tr> <th>Code</th> <th>Description</th> <th>Qty</th> <th>UOM</th> </tr> </thead> <tbody> <tr> <td>GN1120A0</td> <td>TEMPERATUR E PROBE NTC SEAL</td> <td>1</td> <td>PZ</td> </tr> <tr> <td>GN1120A1</td> <td></td> <td>1</td> <td>PZ</td> </tr> <tr> <td>GN1285A0</td> <td>NTC TEMPERATUR E PROBE SEALING</td> <td>2</td> <td>PZ</td> </tr> <tr> <td>SL1045A0</td> <td>S57 BLACK SILICONE - 80ML CARTRIDGE</td> <td>1</td> <td>PZ</td> </tr> </tbody> </table>	Code	Description	Qty	UOM	GN1120A0	TEMPERATUR E PROBE NTC SEAL	1	PZ	GN1120A1		1	PZ	GN1285A0	NTC TEMPERATUR E PROBE SEALING	2	PZ	SL1045A0	S57 BLACK SILICONE - 80ML CARTRIDGE	1	PZ																				
Code	Description	Qty	UOM																																							
GN1120A0	TEMPERATUR E PROBE NTC SEAL	1	PZ																																							
GN1120A1		1	PZ																																							
GN1285A0	NTC TEMPERATUR E PROBE SEALING	2	PZ																																							
SL1045A0	S57 BLACK SILICONE - 80ML CARTRIDGE	1	PZ																																							





COMPONENT			SPARE PART																																			
Code	Description	Image	Code	Description	Components list																																	
GN1285A	NTC TEMPERATURE PROBE SEALING		KTR1096A	NTC 150 L=1500 TEMPERATURE PROBE KIT	<table border="1"> <thead> <tr> <th>Code</th> <th>Description</th> <th>Qty</th> <th>UOM</th> </tr> </thead> <tbody> <tr> <td>TR1096A0</td> <td>TEMPERATUR E PROBE NTC 150 L=1500</td> <td>1</td> <td>PZ</td> </tr> <tr> <td>VI1220A1</td> <td>4,2X12 TCB SELF-TAPPIN G SCREW</td> <td>2</td> <td>PZ</td> </tr> <tr> <td>VM1465A0</td> <td>CHEFTOP TEMPERATUR E PROBE COVER</td> <td>1</td> <td>PZ</td> </tr> <tr> <td>VM1465A1</td> <td>CT BT TEMPERATUR E PROBE COVER</td> <td>1</td> <td>PZ</td> </tr> </tbody> </table>	Code	Description	Qty	UOM	TR1096A0	TEMPERATUR E PROBE NTC 150 L=1500	1	PZ	VI1220A1	4,2X12 TCB SELF-TAPPIN G SCREW	2	PZ	VM1465A0	CHEFTOP TEMPERATUR E PROBE COVER	1	PZ	VM1465A1	CT BT TEMPERATUR E PROBE COVER	1	PZ													
			Code	Description	Qty	UOM																																
			TR1096A0	TEMPERATUR E PROBE NTC 150 L=1500	1	PZ																																
VI1220A1	4,2X12 TCB SELF-TAPPIN G SCREW	2	PZ																																			
VM1465A0	CHEFTOP TEMPERATUR E PROBE COVER	1	PZ																																			
VM1465A1	CT BT TEMPERATUR E PROBE COVER	1	PZ																																			
KTR1095A	NTC 150 L=1050 TEMPERATURE PROBE KIT	<table border="1"> <thead> <tr> <th>Code</th> <th>Description</th> <th>Qty</th> <th>UOM</th> </tr> </thead> <tbody> <tr> <td>GN1120A0</td> <td>TEMPERATUR E PROBE NTC SEAL</td> <td>1</td> <td>PZ</td> </tr> <tr> <td>GN1120A1</td> <td></td> <td>1</td> <td>PZ</td> </tr> <tr> <td>GN1285A0</td> <td>NTC TEMPERATUR E PROBE SEALING</td> <td>1</td> <td>PZ</td> </tr> <tr> <td>SL1045A0</td> <td>S57 BLACK SILICONE - 80ML CARTRIDGE</td> <td>1</td> <td>PZ</td> </tr> <tr> <td>TR1095A0</td> <td>TEMPERATUR E PROBE NTC 150 L=1050</td> <td>1</td> <td>PZ</td> </tr> <tr> <td>VI1220A1</td> <td>4,2X12 TCB SELF-TAPPIN G SCREW</td> <td>2</td> <td>PZ</td> </tr> <tr> <td>VM1465A0</td> <td>CHEFTOP TEMPERATUR E PROBE COVER</td> <td>1</td> <td>PZ</td> </tr> <tr> <td>VM1465A1</td> <td>CT BT TEMPERATUR E PROBE COVER</td> <td>1</td> <td>PZ</td> </tr> </tbody> </table>	Code	Description	Qty	UOM	GN1120A0	TEMPERATUR E PROBE NTC SEAL	1	PZ	GN1120A1		1	PZ	GN1285A0	NTC TEMPERATUR E PROBE SEALING	1	PZ	SL1045A0	S57 BLACK SILICONE - 80ML CARTRIDGE	1	PZ	TR1095A0	TEMPERATUR E PROBE NTC 150 L=1050	1	PZ	VI1220A1	4,2X12 TCB SELF-TAPPIN G SCREW	2	PZ	VM1465A0	CHEFTOP TEMPERATUR E PROBE COVER	1	PZ	VM1465A1	CT BT TEMPERATUR E PROBE COVER	1	PZ
Code	Description	Qty	UOM																																			
GN1120A0	TEMPERATUR E PROBE NTC SEAL	1	PZ																																			
GN1120A1		1	PZ																																			
GN1285A0	NTC TEMPERATUR E PROBE SEALING	1	PZ																																			
SL1045A0	S57 BLACK SILICONE - 80ML CARTRIDGE	1	PZ																																			
TR1095A0	TEMPERATUR E PROBE NTC 150 L=1050	1	PZ																																			
VI1220A1	4,2X12 TCB SELF-TAPPIN G SCREW	2	PZ																																			
VM1465A0	CHEFTOP TEMPERATUR E PROBE COVER	1	PZ																																			
VM1465A1	CT BT TEMPERATUR E PROBE COVER	1	PZ																																			
KTR1002A	PT100 L1000 UL TEMPERATURE PROBE KIT	<table border="1"> <thead> <tr> <th>Code</th> <th>Description</th> <th>Qty</th> <th>UOM</th> </tr> </thead> <tbody> <tr> <td>GN1285A0</td> <td>NTC TEMPERATUR E PROBE SEALING</td> <td>2</td> <td>PZ</td> </tr> <tr> <td>SL1045A0</td> <td>S57 BLACK SILICONE - 80ML CARTRIDGE</td> <td>1</td> <td>PZ</td> </tr> <tr> <td>TR1002A1</td> <td></td> <td>1</td> <td>PZ</td> </tr> </tbody> </table>	Code	Description	Qty	UOM	GN1285A0	NTC TEMPERATUR E PROBE SEALING	2	PZ	SL1045A0	S57 BLACK SILICONE - 80ML CARTRIDGE	1	PZ	TR1002A1		1	PZ																				
Code	Description	Qty	UOM																																			
GN1285A0	NTC TEMPERATUR E PROBE SEALING	2	PZ																																			
SL1045A0	S57 BLACK SILICONE - 80ML CARTRIDGE	1	PZ																																			
TR1002A1		1	PZ																																			

COMPONENT			SPARE PART																																		
Code	Description	Image	Code	Description	Components list																																
GN1285A	NTC TEMPERATURE PROBE SEALING		KTR1002A	PT100 L1000 UL TEMPERATURE PROBE KIT	<table border="1"> <thead> <tr> <th>Code</th> <th>Description</th> <th>Qty</th> <th>UOM</th> </tr> </thead> <tbody> <tr> <td>VI1220A1</td> <td>4,2X12 TCB SELF-TAPPIN G SCREW</td> <td>2</td> <td>PZ</td> </tr> <tr> <td>VM1465A0</td> <td>CHEFTOP TEMPERATUR E PROBE COVER</td> <td>1</td> <td>PZ</td> </tr> <tr> <td>VM1465A1</td> <td>CT BT TEMPERATUR E PROBE COVER</td> <td>1</td> <td>PZ</td> </tr> </tbody> </table>	Code	Description	Qty	UOM	VI1220A1	4,2X12 TCB SELF-TAPPIN G SCREW	2	PZ	VM1465A0	CHEFTOP TEMPERATUR E PROBE COVER	1	PZ	VM1465A1	CT BT TEMPERATUR E PROBE COVER	1	PZ																
Code	Description	Qty	UOM																																		
VI1220A1	4,2X12 TCB SELF-TAPPIN G SCREW	2	PZ																																		
VM1465A0	CHEFTOP TEMPERATUR E PROBE COVER	1	PZ																																		
VM1465A1	CT BT TEMPERATUR E PROBE COVER	1	PZ																																		
VM1464A	CT BT TEMPERATURE PROBE COVER		KVM1464A	CT BT TEMPERATURE PROBE COVER KIT	<table border="1"> <thead> <tr> <th>Code</th> <th>Description</th> <th>Qty</th> <th>UOM</th> </tr> </thead> <tbody> <tr> <td>VM1224A0</td> <td></td> <td>0.150</td> <td>M</td> </tr> <tr> <td>VM1464A1</td> <td>CT BT TEMPERATUR E PROBE COVER</td> <td>1</td> <td>PZ</td> </tr> </tbody> </table>	Code	Description	Qty	UOM	VM1224A0		0.150	M	VM1464A1	CT BT TEMPERATUR E PROBE COVER	1	PZ																				
Code	Description	Qty	UOM																																		
VM1224A0		0.150	M																																		
VM1464A1	CT BT TEMPERATUR E PROBE COVER	1	PZ																																		
TR1106B			KTR1106B	MIND.MAPS L2000 CHAMBER TEMP. PROBE KIT	<table border="1"> <thead> <tr> <th>Code</th> <th>Description</th> <th>Qty</th> <th>UOM</th> </tr> </thead> <tbody> <tr> <td>GN1285A0</td> <td>NTC TEMPERATUR E PROBE SEALING</td> <td>1</td> <td>PZ</td> </tr> <tr> <td>SL1045A0</td> <td>S57 BLACK SILICONE - 80ML CARTRIDGE</td> <td>1</td> <td>PZ</td> </tr> <tr> <td>TR1106B0</td> <td></td> <td>1</td> <td>PZ</td> </tr> <tr> <td>VI1220A1</td> <td>4,2X12 TCB SELF-TAPPIN G SCREW</td> <td>2</td> <td>PZ</td> </tr> <tr> <td>VM1464A1</td> <td>CT BT TEMPERATUR E PROBE COVER</td> <td>1</td> <td>PZ</td> </tr> <tr> <td>VM1465A0</td> <td>CHEFTOP TEMPERATUR E PROBE COVER</td> <td>1</td> <td>PZ</td> </tr> <tr> <td>VM1465A1</td> <td>CT BT TEMPERATUR E PROBE COVER</td> <td>1</td> <td>PZ</td> </tr> </tbody> </table>	Code	Description	Qty	UOM	GN1285A0	NTC TEMPERATUR E PROBE SEALING	1	PZ	SL1045A0	S57 BLACK SILICONE - 80ML CARTRIDGE	1	PZ	TR1106B0		1	PZ	VI1220A1	4,2X12 TCB SELF-TAPPIN G SCREW	2	PZ	VM1464A1	CT BT TEMPERATUR E PROBE COVER	1	PZ	VM1465A0	CHEFTOP TEMPERATUR E PROBE COVER	1	PZ	VM1465A1	CT BT TEMPERATUR E PROBE COVER	1	PZ
Code	Description	Qty	UOM																																		
GN1285A0	NTC TEMPERATUR E PROBE SEALING	1	PZ																																		
SL1045A0	S57 BLACK SILICONE - 80ML CARTRIDGE	1	PZ																																		
TR1106B0		1	PZ																																		
VI1220A1	4,2X12 TCB SELF-TAPPIN G SCREW	2	PZ																																		
VM1464A1	CT BT TEMPERATUR E PROBE COVER	1	PZ																																		
VM1465A0	CHEFTOP TEMPERATUR E PROBE COVER	1	PZ																																		
VM1465A1	CT BT TEMPERATUR E PROBE COVER	1	PZ																																		



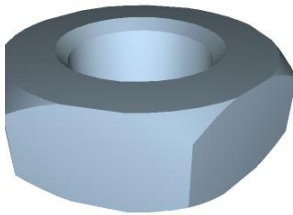

COMPONENT			SPARE PART																																																		
Code	Description	Image	Code	Description	Components list																																																
MT1012A	330W 230V MOTOR		KMT1012A	MIND.MAPS 330W 230V MOTOR KIT	<table border="1"> <thead> <tr> <th>Code</th> <th>Description</th> <th>Qty</th> <th>UOM</th> </tr> </thead> <tbody> <tr> <td>0H4305A1</td> <td>ST. STEEL MOTOR SHAFT SEALING DISC</td> <td>1</td> <td>PZ</td> </tr> <tr> <td>GN1140A2</td> <td>MOTOR HOLDER GASKET</td> <td>1</td> <td>PZ</td> </tr> <tr> <td>GN1140A3</td> <td>MOLDED MOTOR HOLDER GASKET</td> <td>1</td> <td>PZ</td> </tr> <tr> <td>MT1012A0</td> <td>330W 230V MOTOR</td> <td>1</td> <td>PZ</td> </tr> <tr> <td>VE1550A0</td> <td>5X3 MM NEODYMIUM MAGNET</td> <td>1</td> <td>PZ</td> </tr> <tr> <td>VI1077A1</td> <td>SCREW M6X12 TE INOX</td> <td>1</td> <td>PZ</td> </tr> <tr> <td>VI1521A0</td> <td>STAINLESS STEEL WASHER D=6 6592</td> <td>1</td> <td>PZ</td> </tr> <tr> <td>VI1966A0</td> <td>M4X14 FLATHEAD SCREW</td> <td>1</td> <td>PZ</td> </tr> <tr> <td>VM1635A0</td> <td>MAGNET HOLDING DIS</td> <td>1</td> <td>PZ</td> </tr> <tr> <td>VM1794A0</td> <td>250X4.8 PA66 BLACK CLAMP</td> <td>4</td> <td>PZ</td> </tr> <tr> <td>VM2103A0</td> <td>CLAMP LOCK</td> <td>4</td> <td>PZ</td> </tr> </tbody> </table>	Code	Description	Qty	UOM	0H4305A1	ST. STEEL MOTOR SHAFT SEALING DISC	1	PZ	GN1140A2	MOTOR HOLDER GASKET	1	PZ	GN1140A3	MOLDED MOTOR HOLDER GASKET	1	PZ	MT1012A0	330W 230V MOTOR	1	PZ	VE1550A0	5X3 MM NEODYMIUM MAGNET	1	PZ	VI1077A1	SCREW M6X12 TE INOX	1	PZ	VI1521A0	STAINLESS STEEL WASHER D=6 6592	1	PZ	VI1966A0	M4X14 FLATHEAD SCREW	1	PZ	VM1635A0	MAGNET HOLDING DIS	1	PZ	VM1794A0	250X4.8 PA66 BLACK CLAMP	4	PZ	VM2103A0	CLAMP LOCK	4	PZ
					Code	Description	Qty	UOM																																													
					0H4305A1	ST. STEEL MOTOR SHAFT SEALING DISC	1	PZ																																													
					GN1140A2	MOTOR HOLDER GASKET	1	PZ																																													
					GN1140A3	MOLDED MOTOR HOLDER GASKET	1	PZ																																													
					MT1012A0	330W 230V MOTOR	1	PZ																																													
					VE1550A0	5X3 MM NEODYMIUM MAGNET	1	PZ																																													
					VI1077A1	SCREW M6X12 TE INOX	1	PZ																																													
					VI1521A0	STAINLESS STEEL WASHER D=6 6592	1	PZ																																													
					VI1966A0	M4X14 FLATHEAD SCREW	1	PZ																																													
					VM1635A0	MAGNET HOLDING DIS	1	PZ																																													
					VM1794A0	250X4.8 PA66 BLACK CLAMP	4	PZ																																													
					VM2103A0	CLAMP LOCK	4	PZ																																													
0H4305A	ST. STEEL MOTOR SHAFT SEALING DIS		K0H4305A	SEALING DISC FOR MOTOR SHAFT KIT	<table border="1"> <thead> <tr> <th>Code</th> <th>Description</th> <th>Qty</th> <th>UOM</th> </tr> </thead> <tbody> <tr> <td>0H4305A1</td> <td>ST. STEEL MOTOR SHAFT SEALING DISC</td> <td>1</td> <td>PZ</td> </tr> <tr> <td>GN1140A2</td> <td>MOTOR HOLDER GASKET</td> <td>1</td> <td>PZ</td> </tr> <tr> <td>GN1140A3</td> <td>MOLDED MOTOR HOLDER GASKET</td> <td>1</td> <td>PZ</td> </tr> <tr> <td>SL1045A0</td> <td>S57 BLACK SILICONE - 80ML CARTRIDGE</td> <td>1</td> <td>PZ</td> </tr> <tr> <td>VI1220A1</td> <td>4,2X12 TCB SELF-TAPPIN G SCREW</td> <td>3</td> <td>PZ</td> </tr> </tbody> </table>	Code	Description	Qty	UOM	0H4305A1	ST. STEEL MOTOR SHAFT SEALING DISC	1	PZ	GN1140A2	MOTOR HOLDER GASKET	1	PZ	GN1140A3	MOLDED MOTOR HOLDER GASKET	1	PZ	SL1045A0	S57 BLACK SILICONE - 80ML CARTRIDGE	1	PZ	VI1220A1	4,2X12 TCB SELF-TAPPIN G SCREW	3	PZ																								
					Code	Description	Qty	UOM																																													
					0H4305A1	ST. STEEL MOTOR SHAFT SEALING DISC	1	PZ																																													
					GN1140A2	MOTOR HOLDER GASKET	1	PZ																																													
					GN1140A3	MOLDED MOTOR HOLDER GASKET	1	PZ																																													
					SL1045A0	S57 BLACK SILICONE - 80ML CARTRIDGE	1	PZ																																													
					VI1220A1	4,2X12 TCB SELF-TAPPIN G SCREW	3	PZ																																													





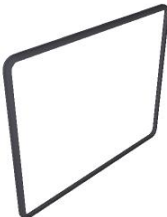

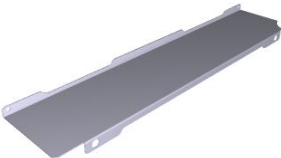
COMPONENT			SPARE PART																						
Code	Description	Image	Code	Description	Components list																				
VN1170B	D195 H80 8 BLADES FAN+RING		KVN1170B	D195 H80 8 BLADES FAN + RING KIT	<table border="1"> <thead> <tr> <th>Code</th> <th>Description</th> <th>Qty</th> <th>UOM</th> </tr> </thead> <tbody> <tr> <td>VI1077A1</td> <td>SCREW M6X12 TE INOX</td> <td>1</td> <td>PZ</td> </tr> <tr> <td>VI1521A0</td> <td>STAINLESS STEEL WASHER D=6 6592</td> <td>1</td> <td>PZ</td> </tr> <tr> <td>VN1170B0</td> <td>D195 H80 8 BLADES FAN+RING</td> <td>1</td> <td>PZ</td> </tr> <tr> <td>VN1170B0</td> <td>D195 H80 8 BLADES FAN+RING</td> <td>1</td> <td>PZ</td> </tr> </tbody> </table>	Code	Description	Qty	UOM	VI1077A1	SCREW M6X12 TE INOX	1	PZ	VI1521A0	STAINLESS STEEL WASHER D=6 6592	1	PZ	VN1170B0	D195 H80 8 BLADES FAN+RING	1	PZ	VN1170B0	D195 H80 8 BLADES FAN+RING	1	PZ
					Code	Description	Qty	UOM																	
					VI1077A1	SCREW M6X12 TE INOX	1	PZ																	
					VI1521A0	STAINLESS STEEL WASHER D=6 6592	1	PZ																	
VN1170B0	D195 H80 8 BLADES FAN+RING	1	PZ																						
VN1170B0	D195 H80 8 BLADES FAN+RING	1	PZ																						
0H7170A	MM MOTOR GLASS WOOL PLATE		0H7170A0	MM MOTOR GLASS WOOL PLATE																					
GN1140A	MOLDED MOTOR HOLDER GASKET		GN1140A3	MOLDED MOTOR HOLDER GASKET																					
0H7320A	6 S. VENTURI PIPE SUPPORT		0H7320A0	6 S. VENTURI PIPE SUPPORT																					
0H7030A	THERMOSTAT BULB INLET COVER		K0H7030A	THERMOSTAT BULB INLET COVER KIT	<table border="1"> <thead> <tr> <th>Code</th> <th>Description</th> <th>Qty</th> <th>UOM</th> </tr> </thead> <tbody> <tr> <td>0H7030A0</td> <td>THERMOSTAT BULB INLET COVER</td> <td>1</td> <td>PZ</td> </tr> <tr> <td>VM1224A0</td> <td></td> <td>0.200</td> <td>M</td> </tr> </tbody> </table>	Code	Description	Qty	UOM	0H7030A0	THERMOSTAT BULB INLET COVER	1	PZ	VM1224A0		0.200	M								
					Code	Description	Qty	UOM																	
0H7030A0	THERMOSTAT BULB INLET COVER	1	PZ																						
VM1224A0		0.200	M																						

COMPONENT			SPARE PART																										
Code	Description	Image	Code	Description	Components list																								
GN1632A	CORE PROBE INLET HOLDING GASKET		GN1632A0	CORE PROBE INLET HOLDING GASKET																									
SN1031A			KSN1031A	SINGLE POINT CORE PROBE KIT L2000	<table border="1"> <thead> <tr> <th>Code</th> <th>Description</th> <th>Qty</th> <th>UOM</th> </tr> </thead> <tbody> <tr> <td>0H7030A0</td> <td>THERMOSTAT BULB INLET COVER</td> <td>1</td> <td>PZ</td> </tr> <tr> <td>GN1632A0</td> <td>CORE PROBE INLET HOLDING GASKET</td> <td>1</td> <td>PZ</td> </tr> <tr> <td>SL1045A0</td> <td>S57 BLACK SILICONE - 80ML CARTRIDGE</td> <td>1</td> <td>PZ</td> </tr> <tr> <td>SN1031A0</td> <td></td> <td>1</td> <td>PZ</td> </tr> <tr> <td>VI1220A1</td> <td>4,2X12 TCB SELF-TAPPING SCREW</td> <td>3</td> <td>PZ</td> </tr> </tbody> </table>	Code	Description	Qty	UOM	0H7030A0	THERMOSTAT BULB INLET COVER	1	PZ	GN1632A0	CORE PROBE INLET HOLDING GASKET	1	PZ	SL1045A0	S57 BLACK SILICONE - 80ML CARTRIDGE	1	PZ	SN1031A0		1	PZ	VI1220A1	4,2X12 TCB SELF-TAPPING SCREW	3	PZ
Code	Description	Qty	UOM																										
0H7030A0	THERMOSTAT BULB INLET COVER	1	PZ																										
GN1632A0	CORE PROBE INLET HOLDING GASKET	1	PZ																										
SL1045A0	S57 BLACK SILICONE - 80ML CARTRIDGE	1	PZ																										
SN1031A0		1	PZ																										
VI1220A1	4,2X12 TCB SELF-TAPPING SCREW	3	PZ																										
RC1170A	STAINLESS STEEL NUT M14 H=8 CH=22		KRC1170A	M14 H8 CH22 NUT - 10 PCS. KIT	<table border="1"> <thead> <tr> <th>Code</th> <th>Description</th> <th>Qty</th> <th>UOM</th> </tr> </thead> <tbody> <tr> <td>RC1170A1</td> <td>STAINLESS STEEL NUT M14 H=8 CH=22</td> <td>10</td> <td>PZ</td> </tr> <tr> <td>VM1224A0</td> <td></td> <td>0.200</td> <td>M</td> </tr> </tbody> </table>	Code	Description	Qty	UOM	RC1170A1	STAINLESS STEEL NUT M14 H=8 CH=22	10	PZ	VM1224A0		0.200	M												
Code	Description	Qty	UOM																										
RC1170A1	STAINLESS STEEL NUT M14 H=8 CH=22	10	PZ																										
VM1224A0		0.200	M																										
TB2937B	XEBC EXTERNAL WATER PIPE D10+CONNECTION		TB2937B0	XEBC EXTERNAL WATER PIPE D10+CONNECTION																									



COMPONENT			SPARE PART																						
Code	Description	Image	Code	Description	Components list																				
GN1567A	XEBC-06XX DOOR GASKET - GN1006A		KGN1659A	06EU-FS/0621 DOOR GASKET KIT	<table border="1"> <thead> <tr> <th>Code</th> <th>Description</th> <th>Qty</th> <th>UOM</th> </tr> </thead> <tbody> <tr> <td>GN1626A0</td> <td>DOUBLE LIP-TYPE FRONT GASKE</td> <td>2.420</td> <td>M</td> </tr> <tr> <td>SL1025A0</td> <td>CLEAR SILICON DOW CORNING 734</td> <td>0.012</td> <td>PZ</td> </tr> <tr> <td>VM1224A0</td> <td></td> <td>0.450</td> <td>M</td> </tr> <tr> <td>VM2277A0</td> <td>DOOR SEAL KIT INTERNAL CONNECTION</td> <td>1</td> <td>PZ</td> </tr> </tbody> </table>	Code	Description	Qty	UOM	GN1626A0	DOUBLE LIP-TYPE FRONT GASKE	2.420	M	SL1025A0	CLEAR SILICON DOW CORNING 734	0.012	PZ	VM1224A0		0.450	M	VM2277A0	DOOR SEAL KIT INTERNAL CONNECTION	1	PZ
Code	Description	Qty	UOM																						
GN1626A0	DOUBLE LIP-TYPE FRONT GASKE	2.420	M																						
SL1025A0	CLEAR SILICON DOW CORNING 734	0.012	PZ																						
VM1224A0		0.450	M																						
VM2277A0	DOOR SEAL KIT INTERNAL CONNECTION	1	PZ																						
0H7664A			OUTOFPRODUCTIO																						
0G1593A			OUTOFPRODUCTIO																						
VM2251A	STEAM WATER INLET UPPER DISTRIBUTOR		KVM2251A	STEAM WATER INLET UP+LO DISTRIBUTORS KIT	<table border="1"> <thead> <tr> <th>Code</th> <th>Description</th> <th>Qty</th> <th>UOM</th> </tr> </thead> <tbody> <tr> <td>VM1224A0</td> <td></td> <td>0.150</td> <td>M</td> </tr> <tr> <td>VM2251A0</td> <td>STEAM WATER INLET UPPER DISTRIBUTOR</td> <td>1</td> <td>PZ</td> </tr> <tr> <td>VM2252A0</td> <td>STEAM WATER INLET LOWER DISTRIBUTOR</td> <td>1</td> <td>PZ</td> </tr> </tbody> </table>	Code	Description	Qty	UOM	VM1224A0		0.150	M	VM2251A0	STEAM WATER INLET UPPER DISTRIBUTOR	1	PZ	VM2252A0	STEAM WATER INLET LOWER DISTRIBUTOR	1	PZ				
Code	Description	Qty	UOM																						
VM1224A0		0.150	M																						
VM2251A0	STEAM WATER INLET UPPER DISTRIBUTOR	1	PZ																						
VM2252A0	STEAM WATER INLET LOWER DISTRIBUTOR	1	PZ																						
VM2252A	STEAM WATER INLET LOWER DISTRIBUTOR		KVM2251A	STEAM WATER INLET UP+LO DISTRIBUTORS KIT	<table border="1"> <thead> <tr> <th>Code</th> <th>Description</th> <th>Qty</th> <th>UOM</th> </tr> </thead> <tbody> <tr> <td>VM1224A0</td> <td></td> <td>0.150</td> <td>M</td> </tr> <tr> <td>VM2251A0</td> <td>STEAM WATER INLET UPPER DISTRIBUTOR</td> <td>1</td> <td>PZ</td> </tr> <tr> <td>VM2252A0</td> <td>STEAM WATER INLET LOWER DISTRIBUTOR</td> <td>1</td> <td>PZ</td> </tr> </tbody> </table>	Code	Description	Qty	UOM	VM1224A0		0.150	M	VM2251A0	STEAM WATER INLET UPPER DISTRIBUTOR	1	PZ	VM2252A0	STEAM WATER INLET LOWER DISTRIBUTOR	1	PZ				
Code	Description	Qty	UOM																						
VM1224A0		0.150	M																						
VM2251A0	STEAM WATER INLET UPPER DISTRIBUTOR	1	PZ																						
VM2252A0	STEAM WATER INLET LOWER DISTRIBUTOR	1	PZ																						



COMPONENT			SPARE PART																						
Code	Description	Image	Code	Description	Components list																				
TB2980A	XEBC-06EU-E 2 WAYS WATER PIPE		TB2980A0	XEBC-06EU-E 2 WAYS WATER PIPE																					
VM2332A			KVM2332A	WATER PIPE BUSHING KIT VM2332A0	<table border="1"> <thead> <tr> <th>Code</th> <th>Description</th> <th>Qty</th> <th>UOM</th> </tr> </thead> <tbody> <tr> <td>VM1224A0</td> <td></td> <td>0.200</td> <td>M</td> </tr> <tr> <td>VM2332A0</td> <td>WATER PIPE BUSHING</td> <td>1</td> <td>PZ</td> </tr> <tr> <td>VM2332A0</td> <td>WATER PIPE BUSHING</td> <td>1</td> <td>PZ</td> </tr> <tr> <td>VM2332A1</td> <td></td> <td>1</td> <td>PZ</td> </tr> </tbody> </table>	Code	Description	Qty	UOM	VM1224A0		0.200	M	VM2332A0	WATER PIPE BUSHING	1	PZ	VM2332A0	WATER PIPE BUSHING	1	PZ	VM2332A1		1	PZ
Code	Description	Qty	UOM																						
VM1224A0		0.200	M																						
VM2332A0	WATER PIPE BUSHING	1	PZ																						
VM2332A0	WATER PIPE BUSHING	1	PZ																						
VM2332A1		1	PZ																						
OG1586A	XEBC-06EU-E COMPLETE FAN GUARD		OG1586A0	XEBC-06EU-E COMPLETE FAN GUARD																					
TB2982A	XEBC-06EU-E LOWER HUMIDITY PIPE		TB2982A0	XEBC-06EU-E LOWER HUMIDITY PIPE																					

ASM1771B/0.D01 - External cover

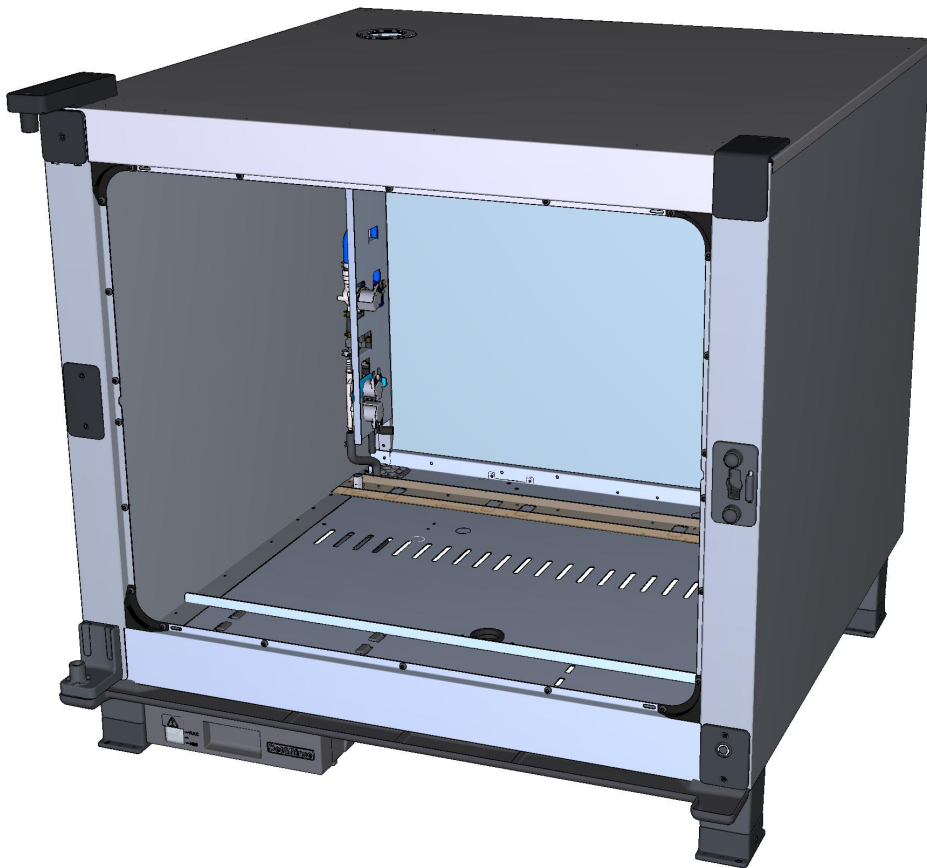

FRONT



ASM1771B/0.D01 - External cover



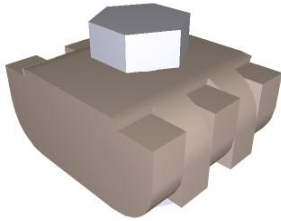

REAR



COMPONENT			SPARE PART																										
Code	Description	Image	Code	Description	Components list																								
TR1136A	330°C 1 POLE SAFETY THERMOSTAT		KTR1136A	330°C SAFETY THERMOSTAT KIT	<table border="1"> <thead> <tr> <th>Code</th> <th>Description</th> <th>Qty</th> <th>UOM</th> </tr> </thead> <tbody> <tr> <td>0H7030A0</td> <td>THERMOSTAT BULB INLET COVER</td> <td>1</td> <td>PZ</td> </tr> <tr> <td>GN1531A0</td> <td>THERMOSTAT BULB INLET SEALING</td> <td>1</td> <td>PZ</td> </tr> <tr> <td>SL1045A0</td> <td>S57 BLACK SILICONE - 80ML CARTRIDGE</td> <td>1</td> <td>PZ</td> </tr> <tr> <td>TR1136A0</td> <td>330°C 1 POLE SAFETY THERMOSTAT</td> <td>1</td> <td>PZ</td> </tr> <tr> <td>VI1220A1</td> <td>4,2X12 TCB SELF-TAPPIN G SCREW</td> <td>3</td> <td>PZ</td> </tr> </tbody> </table>	Code	Description	Qty	UOM	0H7030A0	THERMOSTAT BULB INLET COVER	1	PZ	GN1531A0	THERMOSTAT BULB INLET SEALING	1	PZ	SL1045A0	S57 BLACK SILICONE - 80ML CARTRIDGE	1	PZ	TR1136A0	330°C 1 POLE SAFETY THERMOSTAT	1	PZ	VI1220A1	4,2X12 TCB SELF-TAPPIN G SCREW	3	PZ
Code	Description	Qty	UOM																										
0H7030A0	THERMOSTAT BULB INLET COVER	1	PZ																										
GN1531A0	THERMOSTAT BULB INLET SEALING	1	PZ																										
SL1045A0	S57 BLACK SILICONE - 80ML CARTRIDGE	1	PZ																										
TR1136A0	330°C 1 POLE SAFETY THERMOSTAT	1	PZ																										
VI1220A1	4,2X12 TCB SELF-TAPPIN G SCREW	3	PZ																										
VM1750A	BRASS COMB CLAM		KVM1750A	COMB TERMINAL BLOCK KIT	<table border="1"> <thead> <tr> <th>Code</th> <th>Description</th> <th>Qty</th> <th>UOM</th> </tr> </thead> <tbody> <tr> <td>VM1224A0</td> <td></td> <td>0.150</td> <td>M</td> </tr> <tr> <td>VM1750A0</td> <td>BRASS COMB CLAMP</td> <td>1</td> <td>PZ</td> </tr> </tbody> </table>	Code	Description	Qty	UOM	VM1224A0		0.150	M	VM1750A0	BRASS COMB CLAMP	1	PZ												
Code	Description	Qty	UOM																										
VM1224A0		0.150	M																										
VM1750A0	BRASS COMB CLAMP	1	PZ																										
VM2074A	DRIP TRAY FIXING CLIP WITH SCREW		KVM1220A	CT/BT DRIP TRAY FIXING CLIPS 4PCS KIT	<table border="1"> <thead> <tr> <th>Code</th> <th>Description</th> <th>Qty</th> <th>UOM</th> </tr> </thead> <tbody> <tr> <td>VI1220A1</td> <td>4,2X12 TCB SELF-TAPPIN G SCREW</td> <td>4</td> <td>PZ</td> </tr> <tr> <td>VM1220A0</td> <td>CLIP TO FIX DRIP TRAY C.T</td> <td>4</td> <td>PZ</td> </tr> <tr> <td>VM1224A0</td> <td></td> <td>0.250</td> <td>M</td> </tr> <tr> <td>VM2074A0</td> <td>DRIP TRAY FIXING CLIP WITH SCREW</td> <td>4</td> <td>PZ</td> </tr> </tbody> </table>	Code	Description	Qty	UOM	VI1220A1	4,2X12 TCB SELF-TAPPIN G SCREW	4	PZ	VM1220A0	CLIP TO FIX DRIP TRAY C.T	4	PZ	VM1224A0		0.250	M	VM2074A0	DRIP TRAY FIXING CLIP WITH SCREW	4	PZ				
Code	Description	Qty	UOM																										
VI1220A1	4,2X12 TCB SELF-TAPPIN G SCREW	4	PZ																										
VM1220A0	CLIP TO FIX DRIP TRAY C.T	4	PZ																										
VM1224A0		0.250	M																										
VM2074A0	DRIP TRAY FIXING CLIP WITH SCREW	4	PZ																										
VN1165A	230VAC 50/60HZ COOLING DOWN FA		KVN1165A	S.5E ADVANCE/MM 230V COOLING FAN KIT	<table border="1"> <thead> <tr> <th>Code</th> <th>Description</th> <th>Qty</th> <th>UOM</th> </tr> </thead> <tbody> <tr> <td>VI1099A0</td> <td>SELF-DRILLIN G SCREW 4.8X13 TCB+ Z</td> <td>4</td> <td>PZ</td> </tr> <tr> <td>VM1555A2</td> <td>CT BT COOLING FAN SUPPORT</td> <td>1</td> <td>PZ</td> </tr> <tr> <td>VN1165A0</td> <td>230VAC 50/60HZ COOLING DOWN FAN</td> <td>1</td> <td>PZ</td> </tr> <tr> <td>VN1165A0</td> <td>230VAC 50/60HZ COOLING DOWN FAN</td> <td>1</td> <td>PZ</td> </tr> </tbody> </table>	Code	Description	Qty	UOM	VI1099A0	SELF-DRILLIN G SCREW 4.8X13 TCB+ Z	4	PZ	VM1555A2	CT BT COOLING FAN SUPPORT	1	PZ	VN1165A0	230VAC 50/60HZ COOLING DOWN FAN	1	PZ	VN1165A0	230VAC 50/60HZ COOLING DOWN FAN	1	PZ				
Code	Description	Qty	UOM																										
VI1099A0	SELF-DRILLIN G SCREW 4.8X13 TCB+ Z	4	PZ																										
VM1555A2	CT BT COOLING FAN SUPPORT	1	PZ																										
VN1165A0	230VAC 50/60HZ COOLING DOWN FAN	1	PZ																										
VN1165A0	230VAC 50/60HZ COOLING DOWN FAN	1	PZ																										





COMPONENT			SPARE PART																						
Code	Description	Image	Code	Description	Components list																				
VM1555A	CT BT COOLING FAN SUPPORT		KVN1165A	S.5E ADVANCE/MM 230V COOLING FAN KIT	<table border="1"> <thead> <tr> <th>Code</th> <th>Description</th> <th>Qty</th> <th>UOM</th> </tr> </thead> <tbody> <tr> <td>VI1099A0</td> <td>SELF-DRILLIN G SCREW 4.8X13 TCB+ Z</td> <td>4</td> <td>PZ</td> </tr> <tr> <td>VM1555A2</td> <td>CT BT COOLING FAN SUPPORT</td> <td>1</td> <td>PZ</td> </tr> <tr> <td>VN1165A0</td> <td>230VAC 50/60HZ COOLING DOWN FAN</td> <td>1</td> <td>PZ</td> </tr> <tr> <td>VN1165A0</td> <td>230VAC 50/60HZ COOLING DOWN FAN</td> <td>1</td> <td>PZ</td> </tr> </tbody> </table>	Code	Description	Qty	UOM	VI1099A0	SELF-DRILLIN G SCREW 4.8X13 TCB+ Z	4	PZ	VM1555A2	CT BT COOLING FAN SUPPORT	1	PZ	VN1165A0	230VAC 50/60HZ COOLING DOWN FAN	1	PZ	VN1165A0	230VAC 50/60HZ COOLING DOWN FAN	1	PZ
					Code	Description	Qty	UOM																	
VI1099A0	SELF-DRILLIN G SCREW 4.8X13 TCB+ Z	4	PZ																						
VM1555A2	CT BT COOLING FAN SUPPORT	1	PZ																						
VN1165A0	230VAC 50/60HZ COOLING DOWN FAN	1	PZ																						
VN1165A0	230VAC 50/60HZ COOLING DOWN FAN	1	PZ																						
<table border="1"> <thead> <tr> <th>Code</th> <th>Description</th> <th>Qty</th> <th>UOM</th> </tr> </thead> <tbody> <tr> <td>VI1099A0</td> <td>SELF-DRILLIN G SCREW 4.8X13 TCB+ Z</td> <td>4</td> <td>PZ</td> </tr> <tr> <td>VM1555A2</td> <td>CT BT COOLING FAN SUPPORT</td> <td>1</td> <td>PZ</td> </tr> <tr> <td>VN1164A0</td> <td>12VDC COOLING DONW FAN</td> <td>1</td> <td>PZ</td> </tr> <tr> <td>VN1164A0</td> <td>12VDC COOLING DONW FAN</td> <td>1</td> <td>PZ</td> </tr> </tbody> </table>	Code	Description	Qty	UOM	VI1099A0	SELF-DRILLIN G SCREW 4.8X13 TCB+ Z	4	PZ	VM1555A2	CT BT COOLING FAN SUPPORT	1	PZ	VN1164A0	12VDC COOLING DONW FAN	1	PZ	VN1164A0	12VDC COOLING DONW FAN	1	PZ					
Code	Description	Qty	UOM																						
VI1099A0	SELF-DRILLIN G SCREW 4.8X13 TCB+ Z	4	PZ																						
VM1555A2	CT BT COOLING FAN SUPPORT	1	PZ																						
VN1164A0	12VDC COOLING DONW FAN	1	PZ																						
VN1164A0	12VDC COOLING DONW FAN	1	PZ																						
VM1556A	XBC-XVC COOLING FAN GUARD		KVM1556A	XBC-XVC COOLING FAN GUARD KIT	<table border="1"> <thead> <tr> <th>Code</th> <th>Description</th> <th>Qty</th> <th>UOM</th> </tr> </thead> <tbody> <tr> <td>VM1556A0</td> <td>XBC-XVC COOLING FAN GUARD</td> <td>1</td> <td>PZ</td> </tr> </tbody> </table>	Code	Description	Qty	UOM	VM1556A0	XBC-XVC COOLING FAN GUARD	1	PZ												
					Code	Description	Qty	UOM																	
VM1556A0	XBC-XVC COOLING FAN GUARD	1	PZ																						
<table border="1"> <thead> <tr> <th>Code</th> <th>Description</th> <th>Qty</th> <th>UOM</th> </tr> </thead> <tbody> <tr> <td>GN1400A0</td> <td>U-TRAP SEAL</td> <td>1</td> <td>PZ</td> </tr> <tr> <td>VL1026A0</td> <td>BEND FOR DRAIN PIPE</td> <td>1</td> <td>PZ</td> </tr> <tr> <td>VM1224A0</td> <td></td> <td>0.300</td> <td>M</td> </tr> <tr> <td>VM2039A0</td> <td>DRAIN BEND FIXING RING</td> <td>1</td> <td>PZ</td> </tr> </tbody> </table>	Code	Description	Qty	UOM	GN1400A0	U-TRAP SEAL	1	PZ	VL1026A0	BEND FOR DRAIN PIPE	1	PZ	VM1224A0		0.300	M	VM2039A0	DRAIN BEND FIXING RING	1	PZ					
Code	Description	Qty	UOM																						
GN1400A0	U-TRAP SEAL	1	PZ																						
VL1026A0	BEND FOR DRAIN PIPE	1	PZ																						
VM1224A0		0.300	M																						
VM2039A0	DRAIN BEND FIXING RING	1	PZ																						
VL1026A	BEND FOR DRAIN PIPE		KVL1026A	DRAIN PIPE BEND KI																					

COMPONENT			SPARE PART																						
Code	Description	Image	Code	Description	Components list																				
VM2039A	DRAIN BEND FIXING RING		KVL1026A	DRAIN PIPE BEND KI	<table border="1"> <thead> <tr> <th>Code</th> <th>Description</th> <th>Qty</th> <th>UOM</th> </tr> </thead> <tbody> <tr> <td>GN1400A0</td> <td>U-TRAP SEAL</td> <td>1</td> <td>PZ</td> </tr> <tr> <td>VL1026A0</td> <td>BEND FOR DRAIN PIPE</td> <td>1</td> <td>PZ</td> </tr> <tr> <td>VM1224A0</td> <td></td> <td>0.300</td> <td>M</td> </tr> <tr> <td>VM2039A0</td> <td>DRAIN BEND FIXING RING</td> <td>1</td> <td>PZ</td> </tr> </tbody> </table>	Code	Description	Qty	UOM	GN1400A0	U-TRAP SEAL	1	PZ	VL1026A0	BEND FOR DRAIN PIPE	1	PZ	VM1224A0		0.300	M	VM2039A0	DRAIN BEND FIXING RING	1	PZ
Code	Description	Qty	UOM																						
GN1400A0	U-TRAP SEAL	1	PZ																						
VL1026A0	BEND FOR DRAIN PIPE	1	PZ																						
VM1224A0		0.300	M																						
VM2039A0	DRAIN BEND FIXING RING	1	PZ																						
VM2249A	COOKING CHAMBER FRONT CORNER		KVM2249A	CHAMBER FRONT PROFILE CORNER KIT	<table border="1"> <thead> <tr> <th>Code</th> <th>Description</th> <th>Qty</th> <th>UOM</th> </tr> </thead> <tbody> <tr> <td>VM1224A0</td> <td></td> <td>0.150</td> <td>M</td> </tr> <tr> <td>VM2249A0</td> <td>COOKING CHAMBER FRONT CORNER</td> <td>1</td> <td>PZ</td> </tr> </tbody> </table>	Code	Description	Qty	UOM	VM1224A0		0.150	M	VM2249A0	COOKING CHAMBER FRONT CORNER	1	PZ								
Code	Description	Qty	UOM																						
VM1224A0		0.150	M																						
VM2249A0	COOKING CHAMBER FRONT CORNER	1	PZ																						
VM2035A	DRAIN PIPE SUPPORT		KVM2035A	DRAIN PIPE SUPPORT 2 PCS. KI	<table border="1"> <thead> <tr> <th>Code</th> <th>Description</th> <th>Qty</th> <th>UOM</th> </tr> </thead> <tbody> <tr> <td>VM1224A0</td> <td></td> <td>0.250</td> <td>M</td> </tr> <tr> <td>VM2035A0</td> <td>DRAIN PIPE SUPPORT</td> <td>2</td> <td>PZ</td> </tr> </tbody> </table>	Code	Description	Qty	UOM	VM1224A0		0.250	M	VM2035A0	DRAIN PIPE SUPPORT	2	PZ								
Code	Description	Qty	UOM																						
VM1224A0		0.250	M																						
VM2035A0	DRAIN PIPE SUPPORT	2	PZ																						
VM1810A	RIGHT WATERTIGHT CAP		VM1810A0	RIGHT WATERTIGHT CAP																					
VM1811A	LEFT WATERTIGHT CAP		VM1811A0	LEFT WATERTIGHT CAP																					







COMPONENT			SPARE PART																		
Code	Description	Image	Code	Description	Components list																
VM2311A	SCREWS COVER		KVM2311A	SCREWS COVER PLATE KIT	<table border="1"> <thead> <tr> <th>Code</th> <th>Description</th> <th>Qty</th> <th>UOM</th> </tr> </thead> <tbody> <tr> <td>VM1224A0</td> <td></td> <td>0.200</td> <td>M</td> </tr> <tr> <td>VM2311A0</td> <td>SCREWS COVER</td> <td>1</td> <td>PZ</td> </tr> </tbody> </table>	Code	Description	Qty	UOM	VM1224A0		0.200	M	VM2311A0	SCREWS COVER	1	PZ				
Code	Description	Qty	UOM																		
VM1224A0		0.200	M																		
VM2311A0	SCREWS COVER	1	PZ																		
GN1558A	EXHAUST SEAL		K0H7291A	GASKET AND SEALING DISC CHIMNEY KIT	<table border="1"> <thead> <tr> <th>Code</th> <th>Description</th> <th>Qty</th> <th>UOM</th> </tr> </thead> <tbody> <tr> <td>0H7291A0</td> <td>CHIMNEY HOLDING DIS</td> <td>1</td> <td>PZ</td> </tr> <tr> <td>GN1558A0</td> <td>EXHAUST SEA</td> <td>1</td> <td>PZ</td> </tr> <tr> <td>VM1224A0</td> <td></td> <td>0.200</td> <td>M</td> </tr> </tbody> </table>	Code	Description	Qty	UOM	0H7291A0	CHIMNEY HOLDING DIS	1	PZ	GN1558A0	EXHAUST SEA	1	PZ	VM1224A0		0.200	M
Code	Description	Qty	UOM																		
0H7291A0	CHIMNEY HOLDING DIS	1	PZ																		
GN1558A0	EXHAUST SEA	1	PZ																		
VM1224A0		0.200	M																		
0H7291A	CHIMNEY HOLDING DISC		K0H7291A	GASKET AND SEALING DISC CHIMNEY KIT	<table border="1"> <thead> <tr> <th>Code</th> <th>Description</th> <th>Qty</th> <th>UOM</th> </tr> </thead> <tbody> <tr> <td>0H7291A0</td> <td>CHIMNEY HOLDING DIS</td> <td>1</td> <td>PZ</td> </tr> <tr> <td>GN1558A0</td> <td>EXHAUST SEA</td> <td>1</td> <td>PZ</td> </tr> <tr> <td>VM1224A0</td> <td></td> <td>0.200</td> <td>M</td> </tr> </tbody> </table>	Code	Description	Qty	UOM	0H7291A0	CHIMNEY HOLDING DIS	1	PZ	GN1558A0	EXHAUST SEA	1	PZ	VM1224A0		0.200	M
Code	Description	Qty	UOM																		
0H7291A0	CHIMNEY HOLDING DIS	1	PZ																		
GN1558A0	EXHAUST SEA	1	PZ																		
VM1224A0		0.200	M																		
VM1118A	DET&RINSE PLUS TANK LEFT GUIDE		KVM1118A	DET&RINSE TANK LEFT GUIDE KIT FOR MM	<table border="1"> <thead> <tr> <th>Code</th> <th>Description</th> <th>Qty</th> <th>UOM</th> </tr> </thead> <tbody> <tr> <td>VI1220A1</td> <td>4,2X12 TCB SELF-TAPPIN G SCREW</td> <td>2</td> <td>PZ</td> </tr> <tr> <td>VM1118A0</td> <td>DET&RINSE PLUS TANK LEFT GUIDE</td> <td>1</td> <td>PZ</td> </tr> </tbody> </table>	Code	Description	Qty	UOM	VI1220A1	4,2X12 TCB SELF-TAPPIN G SCREW	2	PZ	VM1118A0	DET&RINSE PLUS TANK LEFT GUIDE	1	PZ				
Code	Description	Qty	UOM																		
VI1220A1	4,2X12 TCB SELF-TAPPIN G SCREW	2	PZ																		
VM1118A0	DET&RINSE PLUS TANK LEFT GUIDE	1	PZ																		
VM1119A	DET&RINSE PLUS TANK RIGHT GUIDE		KVM1119A	DET&RINSE TANK RIGHT GUIDE KIT FOR MM	<table border="1"> <thead> <tr> <th>Code</th> <th>Description</th> <th>Qty</th> <th>UOM</th> </tr> </thead> <tbody> <tr> <td>VI1220A1</td> <td>4,2X12 TCB SELF-TAPPIN G SCREW</td> <td>2</td> <td>PZ</td> </tr> <tr> <td>VM1119A0</td> <td>DET&RINSE PLUS TANK RIGHT GUIDE</td> <td>1</td> <td>PZ</td> </tr> </tbody> </table>	Code	Description	Qty	UOM	VI1220A1	4,2X12 TCB SELF-TAPPIN G SCREW	2	PZ	VM1119A0	DET&RINSE PLUS TANK RIGHT GUIDE	1	PZ				
Code	Description	Qty	UOM																		
VI1220A1	4,2X12 TCB SELF-TAPPIN G SCREW	2	PZ																		
VM1119A0	DET&RINSE PLUS TANK RIGHT GUIDE	1	PZ																		

COMPONENT			SPARE PART																														
Code	Description	Image	Code	Description	Components list																												
SB1015A	4L DETERGENT TAN		KSB1015A	4L DETERGENT TANK KIT	<table border="1"> <thead> <tr> <th>Code</th> <th>Description</th> <th>Qty</th> <th>UOM</th> </tr> </thead> <tbody> <tr> <td>IP1385A1</td> <td>CORNER POLYSTYREN E PACKING 110X80X2000</td> <td>1.200</td> <td>M</td> </tr> <tr> <td>IP1410A0</td> <td>POLYSTYREN E PACKING TO PROTECT</td> <td>2</td> <td>PZ</td> </tr> <tr> <td>SB1015A2</td> <td>4L DETERGENT TANK</td> <td>1</td> <td>PZ</td> </tr> <tr> <td>VM1059A1</td> <td>HEAT SHRINK FILM H800</td> <td>1.200</td> <td>M</td> </tr> </tbody> </table>	Code	Description	Qty	UOM	IP1385A1	CORNER POLYSTYREN E PACKING 110X80X2000	1.200	M	IP1410A0	POLYSTYREN E PACKING TO PROTECT	2	PZ	SB1015A2	4L DETERGENT TANK	1	PZ	VM1059A1	HEAT SHRINK FILM H800	1.200	M								
Code	Description	Qty	UOM																														
IP1385A1	CORNER POLYSTYREN E PACKING 110X80X2000	1.200	M																														
IP1410A0	POLYSTYREN E PACKING TO PROTECT	2	PZ																														
SB1015A2	4L DETERGENT TANK	1	PZ																														
VM1059A1	HEAT SHRINK FILM H800	1.200	M																														
RC1055A	Ø25-40 H12 STAINLESS STEEL PIPE CLIP		KRC1055A	Ø25-40 PIPE CLAMP 10PCS KIT	<table border="1"> <thead> <tr> <th>Code</th> <th>Description</th> <th>Qty</th> <th>UOM</th> </tr> </thead> <tbody> <tr> <td>RC1055A0</td> <td>Ø25-40 H12 STAINLESS STEEL PIPE CLIP</td> <td>10</td> <td>PZ</td> </tr> <tr> <td>VM1224A0</td> <td></td> <td>0.250</td> <td>M</td> </tr> </tbody> </table>	Code	Description	Qty	UOM	RC1055A0	Ø25-40 H12 STAINLESS STEEL PIPE CLIP	10	PZ	VM1224A0		0.250	M																
Code	Description	Qty	UOM																														
RC1055A0	Ø25-40 H12 STAINLESS STEEL PIPE CLIP	10	PZ																														
VM1224A0		0.250	M																														
VM1992A	E SERIES BAKERTOP DRIP TRAY		KVM1992A	E SERIES BAKERTOP DRIP TRAY	<table border="1"> <thead> <tr> <th>Code</th> <th>Description</th> <th>Qty</th> <th>UOM</th> </tr> </thead> <tbody> <tr> <td>VM1220A0</td> <td>CLIP TO FIX DRIP TRAY C.T</td> <td>4</td> <td>PZ</td> </tr> <tr> <td>VM1794A0</td> <td>250X4.8 PA66 BLACK CLAMP</td> <td>2</td> <td>PZ</td> </tr> <tr> <td>VM1992A0</td> <td>E SERIES BAKERTOP DRIP TRAY</td> <td>1</td> <td>PZ</td> </tr> <tr> <td>VM2074A0</td> <td>DRIP TRAY FIXING CLIP WITH SCREW</td> <td>4</td> <td>PZ</td> </tr> <tr> <td>VM2103A0</td> <td>CLAMP LOCK</td> <td>2</td> <td>PZ</td> </tr> </tbody> </table>	Code	Description	Qty	UOM	VM1220A0	CLIP TO FIX DRIP TRAY C.T	4	PZ	VM1794A0	250X4.8 PA66 BLACK CLAMP	2	PZ	VM1992A0	E SERIES BAKERTOP DRIP TRAY	1	PZ	VM2074A0	DRIP TRAY FIXING CLIP WITH SCREW	4	PZ	VM2103A0	CLAMP LOCK	2	PZ				
Code	Description	Qty	UOM																														
VM1220A0	CLIP TO FIX DRIP TRAY C.T	4	PZ																														
VM1794A0	250X4.8 PA66 BLACK CLAMP	2	PZ																														
VM1992A0	E SERIES BAKERTOP DRIP TRAY	1	PZ																														
VM2074A0	DRIP TRAY FIXING CLIP WITH SCREW	4	PZ																														
VM2103A0	CLAMP LOCK	2	PZ																														
VM1190A	CT BT RIGHT DOOR SPRING LATCH		KVM1190A	CHEFTOP/BAKERTO P DOOR RIGHT LATCH KIT	<table border="1"> <thead> <tr> <th>Code</th> <th>Description</th> <th>Qty</th> <th>UOM</th> </tr> </thead> <tbody> <tr> <td>VI0239A1</td> <td>SELF-TAPPIN G SCREW 4.2X25 TCB+ INOX</td> <td>2</td> <td>PZ</td> </tr> <tr> <td>VI1220A1</td> <td>4,2X12 TCB SELF-TAPPIN G SCREW</td> <td>2</td> <td>PZ</td> </tr> <tr> <td>VM1190A2</td> <td>CT BT RIGHT DOOR SPRING LATCH</td> <td>1</td> <td>PZ</td> </tr> <tr> <td>VM1192A1</td> <td>CT BT DOOR SPRING LATCH BACK COVER</td> <td>1</td> <td>PZ</td> </tr> <tr> <td>VM1224A0</td> <td></td> <td>0.200</td> <td>M</td> </tr> <tr> <td>VM1460A0</td> <td>XBC/XVC RIGHT DOOR LATCH CAP</td> <td>1</td> <td>PZ</td> </tr> </tbody> </table>	Code	Description	Qty	UOM	VI0239A1	SELF-TAPPIN G SCREW 4.2X25 TCB+ INOX	2	PZ	VI1220A1	4,2X12 TCB SELF-TAPPIN G SCREW	2	PZ	VM1190A2	CT BT RIGHT DOOR SPRING LATCH	1	PZ	VM1192A1	CT BT DOOR SPRING LATCH BACK COVER	1	PZ	VM1224A0		0.200	M	VM1460A0	XBC/XVC RIGHT DOOR LATCH CAP	1	PZ
Code	Description	Qty	UOM																														
VI0239A1	SELF-TAPPIN G SCREW 4.2X25 TCB+ INOX	2	PZ																														
VI1220A1	4,2X12 TCB SELF-TAPPIN G SCREW	2	PZ																														
VM1190A2	CT BT RIGHT DOOR SPRING LATCH	1	PZ																														
VM1192A1	CT BT DOOR SPRING LATCH BACK COVER	1	PZ																														
VM1224A0		0.200	M																														
VM1460A0	XBC/XVC RIGHT DOOR LATCH CAP	1	PZ																														





COMPONENT			SPARE PART																														
Code	Description	Image	Code	Description	Components list																												
VM1192A	CT BT DOOR SPRING LATCH BACK COVER		KVM1191A	CHEFTOP/BAKERTO P DOOR LEFT LATCH KIT	<table border="1"> <thead> <tr> <th>Code</th> <th>Description</th> <th>Qty</th> <th>UOM</th> </tr> </thead> <tbody> <tr> <td>VI0239A1</td> <td>SELF-TAPPIN G SCREW 4.2X25 TCB+ INOX</td> <td>2</td> <td>PZ</td> </tr> <tr> <td>VI1220A1</td> <td>4,2X12 TCB SELF-TAPPIN G SCREW</td> <td>2</td> <td>PZ</td> </tr> <tr> <td>VM1191A2</td> <td>CT BT LEFT DOOR SPRING LATCH</td> <td>1</td> <td>PZ</td> </tr> <tr> <td>VM1192A1</td> <td>CT BT DOOR SPRING LATCH BACK COVER</td> <td>1</td> <td>PZ</td> </tr> <tr> <td>VM1224A0</td> <td></td> <td>0.200</td> <td>M</td> </tr> <tr> <td>VM1460A0</td> <td>XBC/XVC RIGHT DOOR LATCH CAP</td> <td>1</td> <td>PZ</td> </tr> </tbody> </table>	Code	Description	Qty	UOM	VI0239A1	SELF-TAPPIN G SCREW 4.2X25 TCB+ INOX	2	PZ	VI1220A1	4,2X12 TCB SELF-TAPPIN G SCREW	2	PZ	VM1191A2	CT BT LEFT DOOR SPRING LATCH	1	PZ	VM1192A1	CT BT DOOR SPRING LATCH BACK COVER	1	PZ	VM1224A0		0.200	M	VM1460A0	XBC/XVC RIGHT DOOR LATCH CAP	1	PZ
			Code	Description	Qty	UOM																											
VI0239A1	SELF-TAPPIN G SCREW 4.2X25 TCB+ INOX	2	PZ																														
VI1220A1	4,2X12 TCB SELF-TAPPIN G SCREW	2	PZ																														
VM1191A2	CT BT LEFT DOOR SPRING LATCH	1	PZ																														
VM1192A1	CT BT DOOR SPRING LATCH BACK COVER	1	PZ																														
VM1224A0		0.200	M																														
VM1460A0	XBC/XVC RIGHT DOOR LATCH CAP	1	PZ																														
KVM1190A	CHEFTOP/BAKERTO P DOOR RIGHT LATCH KIT	<table border="1"> <thead> <tr> <th>Code</th> <th>Description</th> <th>Qty</th> <th>UOM</th> </tr> </thead> <tbody> <tr> <td>VI0239A1</td> <td>SELF-TAPPIN G SCREW 4.2X25 TCB+ INOX</td> <td>2</td> <td>PZ</td> </tr> <tr> <td>VI1220A1</td> <td>4,2X12 TCB SELF-TAPPIN G SCREW</td> <td>2</td> <td>PZ</td> </tr> <tr> <td>VM1190A2</td> <td>CT BT RIGHT DOOR SPRING LATCH</td> <td>1</td> <td>PZ</td> </tr> <tr> <td>VM1192A1</td> <td>CT BT DOOR SPRING LATCH BACK COVER</td> <td>1</td> <td>PZ</td> </tr> <tr> <td>VM1224A0</td> <td></td> <td>0.200</td> <td>M</td> </tr> <tr> <td>VM1460A0</td> <td>XBC/XVC RIGHT DOOR LATCH CAP</td> <td>1</td> <td>PZ</td> </tr> </tbody> </table>	Code	Description	Qty	UOM	VI0239A1	SELF-TAPPIN G SCREW 4.2X25 TCB+ INOX	2	PZ	VI1220A1	4,2X12 TCB SELF-TAPPIN G SCREW	2	PZ	VM1190A2	CT BT RIGHT DOOR SPRING LATCH	1	PZ	VM1192A1	CT BT DOOR SPRING LATCH BACK COVER	1	PZ	VM1224A0		0.200	M	VM1460A0	XBC/XVC RIGHT DOOR LATCH CAP	1	PZ			
Code	Description	Qty	UOM																														
VI0239A1	SELF-TAPPIN G SCREW 4.2X25 TCB+ INOX	2	PZ																														
VI1220A1	4,2X12 TCB SELF-TAPPIN G SCREW	2	PZ																														
VM1190A2	CT BT RIGHT DOOR SPRING LATCH	1	PZ																														
VM1192A1	CT BT DOOR SPRING LATCH BACK COVER	1	PZ																														
VM1224A0		0.200	M																														
VM1460A0	XBC/XVC RIGHT DOOR LATCH CAP	1	PZ																														
VM2280A	LATCH COVER PLAT		KVM2280A	VM2280A HANDLE LATCH PLATE COVER KIT	<table border="1"> <thead> <tr> <th>Code</th> <th>Description</th> <th>Qty</th> <th>UOM</th> </tr> </thead> <tbody> <tr> <td>VI1074A0</td> <td></td> <td>2</td> <td>PZ</td> </tr> <tr> <td>VM1224A0</td> <td></td> <td>0.200</td> <td>M</td> </tr> <tr> <td>VM1630A0</td> <td>INTERNAL GLASS PUSHING CAP</td> <td>1</td> <td>PZ</td> </tr> <tr> <td>VM1630A1</td> <td>XB/XV/XVC/XG TERMINAL COVERING BO</td> <td>2</td> <td>PZ</td> </tr> <tr> <td>VM2280A0</td> <td>DOOR LATCH COVER</td> <td>1</td> <td>PZ</td> </tr> <tr> <td>VM2280A1</td> <td>LATCH COVER PLATE</td> <td>1</td> <td>PZ</td> </tr> </tbody> </table>	Code	Description	Qty	UOM	VI1074A0		2	PZ	VM1224A0		0.200	M	VM1630A0	INTERNAL GLASS PUSHING CAP	1	PZ	VM1630A1	XB/XV/XVC/XG TERMINAL COVERING BO	2	PZ	VM2280A0	DOOR LATCH COVER	1	PZ	VM2280A1	LATCH COVER PLATE	1	PZ
Code	Description	Qty	UOM																														
VI1074A0		2	PZ																														
VM1224A0		0.200	M																														
VM1630A0	INTERNAL GLASS PUSHING CAP	1	PZ																														
VM1630A1	XB/XV/XVC/XG TERMINAL COVERING BO	2	PZ																														
VM2280A0	DOOR LATCH COVER	1	PZ																														
VM2280A1	LATCH COVER PLATE	1	PZ																														



COMPONENT			SPARE PART																														
Code	Description	Image	Code	Description	Components list																												
VM1630A	XB/XV/XVC/XG TERMINAL COVERING BOX		KVM1630A	CAP FOR INTERNAL GLASS 10 PCS KIT	<table border="1"> <thead> <tr> <th>Code</th> <th>Description</th> <th>Qty</th> <th>UOM</th> </tr> </thead> <tbody> <tr> <td>VM1224A0</td> <td></td> <td>0.200</td> <td>M</td> </tr> <tr> <td>VM1630A0</td> <td>INTERNAL GLASS PUSHING CAP</td> <td>10</td> <td>PZ</td> </tr> </tbody> </table>	Code	Description	Qty	UOM	VM1224A0		0.200	M	VM1630A0	INTERNAL GLASS PUSHING CAP	10	PZ																
Code	Description	Qty	UOM																														
VM1224A0		0.200	M																														
VM1630A0	INTERNAL GLASS PUSHING CAP	10	PZ																														
VM1190A	CT BT RIGHT DOOR SPRING LATCH		KVM1190A	CHEFTOP/BAKERTO P DOOR RIGHT LATCH KIT	<table border="1"> <thead> <tr> <th>Code</th> <th>Description</th> <th>Qty</th> <th>UOM</th> </tr> </thead> <tbody> <tr> <td>VI0239A1</td> <td>SELF-TAPPIN G SCREW 4.2X25 TCB+ INOX</td> <td>2</td> <td>PZ</td> </tr> <tr> <td>VI1220A1</td> <td>4,2X12 TCB SELF-TAPPIN G SCREW</td> <td>2</td> <td>PZ</td> </tr> <tr> <td>VM1190A2</td> <td>CT BT RIGHT DOOR SPRING LATCH</td> <td>1</td> <td>PZ</td> </tr> <tr> <td>VM1192A1</td> <td>CT BT DOOR SPRING LATCH BACK COVER</td> <td>1</td> <td>PZ</td> </tr> <tr> <td>VM1224A0</td> <td></td> <td>0.200</td> <td>M</td> </tr> <tr> <td>VM1460A0</td> <td>XBC/XVC RIGHT DOOR LATCH CAP</td> <td>1</td> <td>PZ</td> </tr> </tbody> </table>	Code	Description	Qty	UOM	VI0239A1	SELF-TAPPIN G SCREW 4.2X25 TCB+ INOX	2	PZ	VI1220A1	4,2X12 TCB SELF-TAPPIN G SCREW	2	PZ	VM1190A2	CT BT RIGHT DOOR SPRING LATCH	1	PZ	VM1192A1	CT BT DOOR SPRING LATCH BACK COVER	1	PZ	VM1224A0		0.200	M	VM1460A0	XBC/XVC RIGHT DOOR LATCH CAP	1	PZ
Code	Description	Qty	UOM																														
VI0239A1	SELF-TAPPIN G SCREW 4.2X25 TCB+ INOX	2	PZ																														
VI1220A1	4,2X12 TCB SELF-TAPPIN G SCREW	2	PZ																														
VM1190A2	CT BT RIGHT DOOR SPRING LATCH	1	PZ																														
VM1192A1	CT BT DOOR SPRING LATCH BACK COVER	1	PZ																														
VM1224A0		0.200	M																														
VM1460A0	XBC/XVC RIGHT DOOR LATCH CAP	1	PZ																														
VM2281A	DOOR LATCH HOLES COVER		KVM2281A	HOLE PLATE COVER KIT	<table border="1"> <thead> <tr> <th>Code</th> <th>Description</th> <th>Qty</th> <th>UOM</th> </tr> </thead> <tbody> <tr> <td>VM1224A0</td> <td></td> <td>0.200</td> <td>M</td> </tr> <tr> <td>VM2281A0</td> <td>DOOR LATCH HOLES COVER</td> <td>1</td> <td>PZ</td> </tr> </tbody> </table>	Code	Description	Qty	UOM	VM1224A0		0.200	M	VM2281A0	DOOR LATCH HOLES COVER	1	PZ																
Code	Description	Qty	UOM																														
VM1224A0		0.200	M																														
VM2281A0	DOOR LATCH HOLES COVER	1	PZ																														
VM1192A	CT BT DOOR SPRING LATCH BACK COVER		KVM1191A	CHEFTOP/BAKERTO P DOOR LEFT LATCH KIT	<table border="1"> <thead> <tr> <th>Code</th> <th>Description</th> <th>Qty</th> <th>UOM</th> </tr> </thead> <tbody> <tr> <td>VI0239A1</td> <td>SELF-TAPPIN G SCREW 4.2X25 TCB+ INOX</td> <td>2</td> <td>PZ</td> </tr> <tr> <td>VI1220A1</td> <td>4,2X12 TCB SELF-TAPPIN G SCREW</td> <td>2</td> <td>PZ</td> </tr> <tr> <td>VM1191A2</td> <td>CT BT LEFT DOOR SPRING LATCH</td> <td>1</td> <td>PZ</td> </tr> <tr> <td>VM1192A1</td> <td>CT BT DOOR SPRING LATCH BACK COVER</td> <td>1</td> <td>PZ</td> </tr> <tr> <td>VM1224A0</td> <td></td> <td>0.200</td> <td>M</td> </tr> <tr> <td>VM1460A0</td> <td>XBC/XVC RIGHT DOOR LATCH CAP</td> <td>1</td> <td>PZ</td> </tr> </tbody> </table>	Code	Description	Qty	UOM	VI0239A1	SELF-TAPPIN G SCREW 4.2X25 TCB+ INOX	2	PZ	VI1220A1	4,2X12 TCB SELF-TAPPIN G SCREW	2	PZ	VM1191A2	CT BT LEFT DOOR SPRING LATCH	1	PZ	VM1192A1	CT BT DOOR SPRING LATCH BACK COVER	1	PZ	VM1224A0		0.200	M	VM1460A0	XBC/XVC RIGHT DOOR LATCH CAP	1	PZ
Code	Description	Qty	UOM																														
VI0239A1	SELF-TAPPIN G SCREW 4.2X25 TCB+ INOX	2	PZ																														
VI1220A1	4,2X12 TCB SELF-TAPPIN G SCREW	2	PZ																														
VM1191A2	CT BT LEFT DOOR SPRING LATCH	1	PZ																														
VM1192A1	CT BT DOOR SPRING LATCH BACK COVER	1	PZ																														
VM1224A0		0.200	M																														
VM1460A0	XBC/XVC RIGHT DOOR LATCH CAP	1	PZ																														

COMPONENT			SPARE PART																														
Code	Description	Image	Code	Description	Components list																												
VM1192A	CT BT DOOR SPRING LATCH BACK COVER		KVM1190A	CHEFTOP/BAKERTO P DOOR RIGHT LATCH KIT	<table border="1"> <thead> <tr> <th>Code</th> <th>Description</th> <th>Qty</th> <th>UOM</th> </tr> </thead> <tbody> <tr> <td>VI0239A1</td> <td>SELF-TAPPIN G SCREW 4.2X25 TCB+ INOX</td> <td>2</td> <td>PZ</td> </tr> <tr> <td>VI1220A1</td> <td>4,2X12 TCB SELF-TAPPIN G SCREW</td> <td>2</td> <td>PZ</td> </tr> <tr> <td>VM1190A2</td> <td>CT BT RIGHT DOOR SPRING LATCH</td> <td>1</td> <td>PZ</td> </tr> <tr> <td>VM1192A1</td> <td>CT BT DOOR SPRING LATCH BACK COVER</td> <td>1</td> <td>PZ</td> </tr> <tr> <td>VM1224A0</td> <td></td> <td>0.200</td> <td>M</td> </tr> <tr> <td>VM1460A0</td> <td>XBC/XVC RIGHT DOOR LATCH CAP</td> <td>1</td> <td>PZ</td> </tr> </tbody> </table>	Code	Description	Qty	UOM	VI0239A1	SELF-TAPPIN G SCREW 4.2X25 TCB+ INOX	2	PZ	VI1220A1	4,2X12 TCB SELF-TAPPIN G SCREW	2	PZ	VM1190A2	CT BT RIGHT DOOR SPRING LATCH	1	PZ	VM1192A1	CT BT DOOR SPRING LATCH BACK COVER	1	PZ	VM1224A0		0.200	M	VM1460A0	XBC/XVC RIGHT DOOR LATCH CAP	1	PZ
Code	Description	Qty	UOM																														
VI0239A1	SELF-TAPPIN G SCREW 4.2X25 TCB+ INOX	2	PZ																														
VI1220A1	4,2X12 TCB SELF-TAPPIN G SCREW	2	PZ																														
VM1190A2	CT BT RIGHT DOOR SPRING LATCH	1	PZ																														
VM1192A1	CT BT DOOR SPRING LATCH BACK COVER	1	PZ																														
VM1224A0		0.200	M																														
VM1460A0	XBC/XVC RIGHT DOOR LATCH CAP	1	PZ																														
0H2561A	6 S. DOOR COUNTERBRACKET		0H2561A0	6 S. DOOR COUNTERBRACKET																													
VI1995A	M5X25 ST.STEEL SCREW		VI1995A0	M5X25 ST.STEEL SCREW																													
VM2352A	MM LOWER DOOR BRACKET LEFT SCREW COVERI		VM2352A0	MM LOWER DOOR BRACKET LEFT SCREW COVERI																													







COMPONENT			SPARE PART																																						
Code	Description	Image	Code	Description	Components list																																				
VM2353A	MM LOWER DOOR BRACKET RIGHT SCREW COVERI		VM2353A0	MM LOWER DOOR BRACKET RIGHT SCREW COVERI																																					
VM1240A	NYLON SUPPORT CAP		KVM1240A	4 PCS COUNTER BRACKET SUPPORT CAP KIT	<table border="1"> <thead> <tr> <th>Code</th> <th>Description</th> <th>Qty</th> <th>UOM</th> </tr> </thead> <tbody> <tr> <td>VM1224A0</td> <td></td> <td>0.200</td> <td>M</td> </tr> <tr> <td>VM1240A0</td> <td>NYLON SUPPORT CAP</td> <td>4</td> <td>PZ</td> </tr> </tbody> </table>	Code	Description	Qty	UOM	VM1224A0		0.200	M	VM1240A0	NYLON SUPPORT CAP	4	PZ																								
Code	Description	Qty	UOM																																						
VM1224A0		0.200	M																																						
VM1240A0	NYLON SUPPORT CAP	4	PZ																																						
VM2273A	MM DOOR LEFT LOWER BRACKET		KVM2273A	MIND.MAPS DOOR LOWER LEFT BRACKET KIT	<table border="1"> <thead> <tr> <th>Code</th> <th>Description</th> <th>Qty</th> <th>UOM</th> </tr> </thead> <tbody> <tr> <td>0H7330A0</td> <td>DOOR LOWER BRACKET WASHER</td> <td>2</td> <td>PZ</td> </tr> <tr> <td>VI1995A0</td> <td>M5X25 ST.STEEL SCREW</td> <td>4</td> <td>PZ</td> </tr> <tr> <td>VM1224A0</td> <td></td> <td>0.300</td> <td>M</td> </tr> <tr> <td>VM2273A1</td> <td>MM DOOR LEFT LOWER BRACKET</td> <td>1</td> <td>PZ</td> </tr> <tr> <td>VM2352A0</td> <td>MM LOWER DOOR BRACKET LEFT SCREW COVERI</td> <td>1</td> <td>PZ</td> </tr> <tr> <td>VM2352A0</td> <td>MM LOWER DOOR BRACKET LEFT SCREW COVERI</td> <td>1</td> <td>PZ</td> </tr> <tr> <td>VM2353A0</td> <td>MM LOWER DOOR BRACKET RIGHT SCREW COVERI</td> <td>1</td> <td>PZ</td> </tr> <tr> <td>VM2353A0</td> <td>MM LOWER DOOR BRACKET RIGHT SCREW COVERI</td> <td>1</td> <td>PZ</td> </tr> </tbody> </table>	Code	Description	Qty	UOM	0H7330A0	DOOR LOWER BRACKET WASHER	2	PZ	VI1995A0	M5X25 ST.STEEL SCREW	4	PZ	VM1224A0		0.300	M	VM2273A1	MM DOOR LEFT LOWER BRACKET	1	PZ	VM2352A0	MM LOWER DOOR BRACKET LEFT SCREW COVERI	1	PZ	VM2352A0	MM LOWER DOOR BRACKET LEFT SCREW COVERI	1	PZ	VM2353A0	MM LOWER DOOR BRACKET RIGHT SCREW COVERI	1	PZ	VM2353A0	MM LOWER DOOR BRACKET RIGHT SCREW COVERI	1	PZ
Code	Description	Qty	UOM																																						
0H7330A0	DOOR LOWER BRACKET WASHER	2	PZ																																						
VI1995A0	M5X25 ST.STEEL SCREW	4	PZ																																						
VM1224A0		0.300	M																																						
VM2273A1	MM DOOR LEFT LOWER BRACKET	1	PZ																																						
VM2352A0	MM LOWER DOOR BRACKET LEFT SCREW COVERI	1	PZ																																						
VM2352A0	MM LOWER DOOR BRACKET LEFT SCREW COVERI	1	PZ																																						
VM2353A0	MM LOWER DOOR BRACKET RIGHT SCREW COVERI	1	PZ																																						
VM2353A0	MM LOWER DOOR BRACKET RIGHT SCREW COVERI	1	PZ																																						



COMPONENT			SPARE PART																														
Code	Description	Image	Code	Description	Components list																												
0H2561A	6 S. DOOR COUNTERBRACKET		0H2561A0	6 S. DOOR COUNTERBRACKET																													
VI1995A	M5X25 ST.STEEL SCREW		VI1995A0	M5X25 ST.STEEL SCREW																													
VM1240A	NYLON SUPPORT CAP		KVM1240A	4 PCS COUNTER BRACKET SUPPORT CAP KIT	<table border="1"> <thead> <tr> <th>Code</th> <th>Description</th> <th>Qty</th> <th>UOM</th> </tr> </thead> <tbody> <tr> <td>VM1224A0</td> <td></td> <td>0.200</td> <td>M</td> </tr> <tr> <td>VM1240A0</td> <td>NYLON SUPPORT CAP</td> <td>4</td> <td>PZ</td> </tr> </tbody> </table>	Code	Description	Qty	UOM	VM1224A0		0.200	M	VM1240A0	NYLON SUPPORT CAP	4	PZ																
Code	Description	Qty	UOM																														
VM1224A0		0.200	M																														
VM1240A0	NYLON SUPPORT CAP	4	PZ																														
VM2298A	DOOR BRACKET UPPER COVER		KVM2298A	MIND.MAPS DOOR UPPER BRACKET COVER KIT	<table border="1"> <thead> <tr> <th>Code</th> <th>Description</th> <th>Qty</th> <th>UOM</th> </tr> </thead> <tbody> <tr> <td>VI1220A0</td> <td>SELF-TAPPIN G SCREW 4.2X12 TCB</td> <td>2</td> <td>PZ</td> </tr> <tr> <td>VM1224A0</td> <td></td> <td>0.200</td> <td>M</td> </tr> <tr> <td>VM2298A0</td> <td>DOOR BRACKET UPPER COVER</td> <td>1</td> <td>PZ</td> </tr> </tbody> </table>	Code	Description	Qty	UOM	VI1220A0	SELF-TAPPIN G SCREW 4.2X12 TCB	2	PZ	VM1224A0		0.200	M	VM2298A0	DOOR BRACKET UPPER COVER	1	PZ												
Code	Description	Qty	UOM																														
VI1220A0	SELF-TAPPIN G SCREW 4.2X12 TCB	2	PZ																														
VM1224A0		0.200	M																														
VM2298A0	DOOR BRACKET UPPER COVER	1	PZ																														
VM2271A	MM DOOR LEFT UPPER BRACKET		KVM2271A	MIND.MAPS UPPER LEFT DOOR BRACKET KIT	<table border="1"> <thead> <tr> <th>Code</th> <th>Description</th> <th>Qty</th> <th>UOM</th> </tr> </thead> <tbody> <tr> <td>VI1220A1</td> <td>4.2X12 TCB SELF-TAPPIN G SCREW</td> <td>2</td> <td>PZ</td> </tr> <tr> <td>VI1995A0</td> <td>M5X25 ST.STEEL SCREW</td> <td>4</td> <td>PZ</td> </tr> <tr> <td>VI1997A0</td> <td>5X10X1 FLAT WASHER</td> <td>4</td> <td>PZ</td> </tr> <tr> <td>VM1224A0</td> <td></td> <td>0.300</td> <td>M</td> </tr> <tr> <td>VM2271A0</td> <td>MM DOOR LEFT UPPER BRACKET</td> <td>1</td> <td>PZ</td> </tr> <tr> <td>VM2298A0</td> <td>DOOR BRACKET UPPER COVER</td> <td>1</td> <td>PZ</td> </tr> </tbody> </table>	Code	Description	Qty	UOM	VI1220A1	4.2X12 TCB SELF-TAPPIN G SCREW	2	PZ	VI1995A0	M5X25 ST.STEEL SCREW	4	PZ	VI1997A0	5X10X1 FLAT WASHER	4	PZ	VM1224A0		0.300	M	VM2271A0	MM DOOR LEFT UPPER BRACKET	1	PZ	VM2298A0	DOOR BRACKET UPPER COVER	1	PZ
Code	Description	Qty	UOM																														
VI1220A1	4.2X12 TCB SELF-TAPPIN G SCREW	2	PZ																														
VI1995A0	M5X25 ST.STEEL SCREW	4	PZ																														
VI1997A0	5X10X1 FLAT WASHER	4	PZ																														
VM1224A0		0.300	M																														
VM2271A0	MM DOOR LEFT UPPER BRACKET	1	PZ																														
VM2298A0	DOOR BRACKET UPPER COVER	1	PZ																														



COMPONENT			SPARE PART																										
Code	Description	Image	Code	Description	Components list																								
PD1074A	H=100 SQUARE FOO		KPD1074A	MIND.MAPS H100 FOOT KIT	<table border="1"> <thead> <tr> <th>Code</th> <th>Description</th> <th>Qty</th> <th>UOM</th> </tr> </thead> <tbody> <tr> <td>PD1074A0</td> <td>H=100 SQUARE FOO</td> <td>1</td> <td>PZ</td> </tr> <tr> <td>PD1075A0</td> <td>FOOT LOCKING BRACKET</td> <td>1</td> <td>PZ</td> </tr> <tr> <td>PD1075A1</td> <td>PD1074 FOOT LOCKING BRACKET</td> <td>1</td> <td>PZ</td> </tr> <tr> <td>VI1220A1</td> <td>4,2X12 TCB SELF-TAPPIN G SCREW</td> <td>5</td> <td>PZ</td> </tr> <tr> <td>VM1224A0</td> <td></td> <td>0.300</td> <td>M</td> </tr> </tbody> </table>	Code	Description	Qty	UOM	PD1074A0	H=100 SQUARE FOO	1	PZ	PD1075A0	FOOT LOCKING BRACKET	1	PZ	PD1075A1	PD1074 FOOT LOCKING BRACKET	1	PZ	VI1220A1	4,2X12 TCB SELF-TAPPIN G SCREW	5	PZ	VM1224A0		0.300	M
Code	Description	Qty	UOM																										
PD1074A0	H=100 SQUARE FOO	1	PZ																										
PD1075A0	FOOT LOCKING BRACKET	1	PZ																										
PD1075A1	PD1074 FOOT LOCKING BRACKET	1	PZ																										
VI1220A1	4,2X12 TCB SELF-TAPPIN G SCREW	5	PZ																										
VM1224A0		0.300	M																										
PD1075A	PD1074 FOOT LOCKING BRACKET		KPD1075A	OVEN FOOT STOPPING BRACKET KIT	<table border="1"> <thead> <tr> <th>Code</th> <th>Description</th> <th>Qty</th> <th>UOM</th> </tr> </thead> <tbody> <tr> <td>PD1075A0</td> <td>FOOT LOCKING BRACKET</td> <td>4</td> <td>PZ</td> </tr> <tr> <td>PD1075A1</td> <td>PD1074 FOOT LOCKING BRACKET</td> <td>4</td> <td>PZ</td> </tr> <tr> <td>VI1950A0</td> <td>ST. STEEL 4,2X13 TCB SELF-DRILLIN G SCREW</td> <td>8</td> <td>PZ</td> </tr> </tbody> </table>	Code	Description	Qty	UOM	PD1075A0	FOOT LOCKING BRACKET	4	PZ	PD1075A1	PD1074 FOOT LOCKING BRACKET	4	PZ	VI1950A0	ST. STEEL 4,2X13 TCB SELF-DRILLIN G SCREW	8	PZ								
Code	Description	Qty	UOM																										
PD1075A0	FOOT LOCKING BRACKET	4	PZ																										
PD1075A1	PD1074 FOOT LOCKING BRACKET	4	PZ																										
VI1950A0	ST. STEEL 4,2X13 TCB SELF-DRILLIN G SCREW	8	PZ																										
VM2061A	ACCESSORIES CABLES WALL PASSING		KVM1505A	THROUGH-WALL CONNECTION+DIAPHRAGM KIT	<table border="1"> <thead> <tr> <th>Code</th> <th>Description</th> <th>Qty</th> <th>UOM</th> </tr> </thead> <tbody> <tr> <td>VI1220A1</td> <td>4,2X12 TCB SELF-TAPPIN G SCREW</td> <td>1</td> <td>PZ</td> </tr> <tr> <td>VM1224A0</td> <td></td> <td>0.200</td> <td>M</td> </tr> <tr> <td>VM1505A0</td> <td>WALL PASSING WITH DIAPHRAGM</td> <td>3</td> <td>PZ</td> </tr> <tr> <td>VM2055A0</td> <td>UPPER WALL PASSING ACCESSORY CABLES</td> <td>1</td> <td>PZ</td> </tr> <tr> <td>VM2056A0</td> <td>LOWER WALL PASSING ACCESSORY CABLES</td> <td>1</td> <td>PZ</td> </tr> </tbody> </table>	Code	Description	Qty	UOM	VI1220A1	4,2X12 TCB SELF-TAPPIN G SCREW	1	PZ	VM1224A0		0.200	M	VM1505A0	WALL PASSING WITH DIAPHRAGM	3	PZ	VM2055A0	UPPER WALL PASSING ACCESSORY CABLES	1	PZ	VM2056A0	LOWER WALL PASSING ACCESSORY CABLES	1	PZ
Code	Description	Qty	UOM																										
VI1220A1	4,2X12 TCB SELF-TAPPIN G SCREW	1	PZ																										
VM1224A0		0.200	M																										
VM1505A0	WALL PASSING WITH DIAPHRAGM	3	PZ																										
VM2055A0	UPPER WALL PASSING ACCESSORY CABLES	1	PZ																										
VM2056A0	LOWER WALL PASSING ACCESSORY CABLES	1	PZ																										
VM2450A	THROUGH-WALL CONNECTION 3 PIPES		KVM2450A	3 PIPES THROUGH-WALL CONNECTION KIT	<table border="1"> <thead> <tr> <th>Code</th> <th>Description</th> <th>Qty</th> <th>UOM</th> </tr> </thead> <tbody> <tr> <td>VM1224A0</td> <td></td> <td>0.200</td> <td>M</td> </tr> <tr> <td>VM2450A0</td> <td>THROUGH-WALL CONNECTION 3 PIPES</td> <td>1</td> <td>PZ</td> </tr> <tr> <td>VM2450A0</td> <td>THROUGH-WALL CONNECTION 3 PIPES</td> <td>1</td> <td>PZ</td> </tr> </tbody> </table>	Code	Description	Qty	UOM	VM1224A0		0.200	M	VM2450A0	THROUGH-WALL CONNECTION 3 PIPES	1	PZ	VM2450A0	THROUGH-WALL CONNECTION 3 PIPES	1	PZ								
Code	Description	Qty	UOM																										
VM1224A0		0.200	M																										
VM2450A0	THROUGH-WALL CONNECTION 3 PIPES	1	PZ																										
VM2450A0	THROUGH-WALL CONNECTION 3 PIPES	1	PZ																										



COMPONENT			SPARE PART																																						
Code	Description	Image	Code	Description	Components list																																				
0H2561A	6 S. DOOR COUNTERBRACKET		0H2561A0	6 S. DOOR COUNTERBRACKET																																					
VM1240A	NYLON SUPPORT CAP		KVM1240A	4 PCS COUNTER BRACKET SUPPORT CAP KIT	<table border="1"> <thead> <tr> <th>Code</th> <th>Description</th> <th>Qty</th> <th>UOM</th> </tr> </thead> <tbody> <tr> <td>VM1224A0</td> <td></td> <td>0.200</td> <td>M</td> </tr> <tr> <td>VM1240A0</td> <td>NYLON SUPPORT CAP</td> <td>4</td> <td>PZ</td> </tr> </tbody> </table>	Code	Description	Qty	UOM	VM1224A0		0.200	M	VM1240A0	NYLON SUPPORT CAP	4	PZ																								
Code	Description	Qty	UOM																																						
VM1224A0		0.200	M																																						
VM1240A0	NYLON SUPPORT CAP	4	PZ																																						
VM2282A	MICROSWITCH SUPPORT COVER		KVM2282A	MICROSWITCH SUPPORT PLATE KI	<table border="1"> <thead> <tr> <th>Code</th> <th>Description</th> <th>Qty</th> <th>UOM</th> </tr> </thead> <tbody> <tr> <td>VM1224A0</td> <td></td> <td>0.200</td> <td>M</td> </tr> <tr> <td>VM2282A0</td> <td>MICROSWITC H SUPPORT COVER</td> <td>1</td> <td>PZ</td> </tr> </tbody> </table>	Code	Description	Qty	UOM	VM1224A0		0.200	M	VM2282A0	MICROSWITC H SUPPORT COVER	1	PZ																								
Code	Description	Qty	UOM																																						
VM1224A0		0.200	M																																						
VM2282A0	MICROSWITC H SUPPORT COVER	1	PZ																																						
VE1020B	MAGNET DOOR MICROSWITCH		KVE1020B	MICROSWITCH KIT	<table border="1"> <thead> <tr> <th>Code</th> <th>Description</th> <th>Qty</th> <th>UOM</th> </tr> </thead> <tbody> <tr> <td>CE1030A0</td> <td>FEMALE FASTON COVER 6.3X0.8 0.5-1MMQ</td> <td>2</td> <td>PZ</td> </tr> <tr> <td>CE1660A0</td> <td>6,3X0,8 FEMALE FASTON COVE</td> <td>2</td> <td>PZ</td> </tr> <tr> <td>CE1730A0</td> <td>PVC CABLE NP 2 X AWG22 STYLE 2095</td> <td>0.150</td> <td>M</td> </tr> <tr> <td>CE1740A0</td> <td>MINIFIT MALE END FITTING</td> <td>2</td> <td>PZ</td> </tr> <tr> <td>CE1745A0</td> <td>2 WAYS FEMALE MINIFIT CONNECTOR</td> <td>1</td> <td>PZ</td> </tr> <tr> <td>VE1020B0</td> <td>MAGNET DOOR MICROSWITC</td> <td>1</td> <td>PZ</td> </tr> <tr> <td>VE1030A1</td> <td>MAGNET FOR DOOR MICROSWITC H D=22.9MM</td> <td>1</td> <td>PZ</td> </tr> <tr> <td>VM1224A0</td> <td></td> <td>0.250</td> <td>M</td> </tr> </tbody> </table>	Code	Description	Qty	UOM	CE1030A0	FEMALE FASTON COVER 6.3X0.8 0.5-1MMQ	2	PZ	CE1660A0	6,3X0,8 FEMALE FASTON COVE	2	PZ	CE1730A0	PVC CABLE NP 2 X AWG22 STYLE 2095	0.150	M	CE1740A0	MINIFIT MALE END FITTING	2	PZ	CE1745A0	2 WAYS FEMALE MINIFIT CONNECTOR	1	PZ	VE1020B0	MAGNET DOOR MICROSWITC	1	PZ	VE1030A1	MAGNET FOR DOOR MICROSWITC H D=22.9MM	1	PZ	VM1224A0		0.250	M
Code	Description	Qty	UOM																																						
CE1030A0	FEMALE FASTON COVER 6.3X0.8 0.5-1MMQ	2	PZ																																						
CE1660A0	6,3X0,8 FEMALE FASTON COVE	2	PZ																																						
CE1730A0	PVC CABLE NP 2 X AWG22 STYLE 2095	0.150	M																																						
CE1740A0	MINIFIT MALE END FITTING	2	PZ																																						
CE1745A0	2 WAYS FEMALE MINIFIT CONNECTOR	1	PZ																																						
VE1020B0	MAGNET DOOR MICROSWITC	1	PZ																																						
VE1030A1	MAGNET FOR DOOR MICROSWITC H D=22.9MM	1	PZ																																						
VM1224A0		0.250	M																																						





COMPONENT			SPARE PART																						
Code	Description	Image	Code	Description	Components list																				
0H2561A	6 S. DOOR COUNTERBRACKET		0H2561A0	6 S. DOOR COUNTERBRACKET																					
VM1240A	NYLON SUPPORT CAP		KVM1240A	4 PCS COUNTER BRACKET SUPPORT CAP KIT	<table border="1"> <thead> <tr> <th>Code</th> <th>Description</th> <th>Qty</th> <th>UOM</th> </tr> </thead> <tbody> <tr> <td>VM1224A0</td> <td></td> <td>0.200</td> <td>M</td> </tr> <tr> <td>VM1240A0</td> <td>NYLON SUPPORT CAP</td> <td>4</td> <td>PZ</td> </tr> </tbody> </table>	Code	Description	Qty	UOM	VM1224A0		0.200	M	VM1240A0	NYLON SUPPORT CAP	4	PZ								
Code	Description	Qty	UOM																						
VM1224A0		0.200	M																						
VM1240A0	NYLON SUPPORT CAP	4	PZ																						
VM2310A	UPPER DOOR BRACKET HOLES COVER		KVM2310A	UPPER BRACKET HOLE COVER KIT	<table border="1"> <thead> <tr> <th>Code</th> <th>Description</th> <th>Qty</th> <th>UOM</th> </tr> </thead> <tbody> <tr> <td>VM1224A0</td> <td></td> <td>0.300</td> <td>M</td> </tr> <tr> <td>VM2310A0</td> <td>UPPER DOOR BRACKET HOLES COVER</td> <td>1</td> <td>PZ</td> </tr> </tbody> </table>	Code	Description	Qty	UOM	VM1224A0		0.300	M	VM2310A0	UPPER DOOR BRACKET HOLES COVER	1	PZ								
Code	Description	Qty	UOM																						
VM1224A0		0.300	M																						
VM2310A0	UPPER DOOR BRACKET HOLES COVER	1	PZ																						
VL1086A	LIMESCALE REMOVER NEODYMIUM MAGNET		KVL1086A	NEODYMIUM MAGNET ANTI-LIMESCALE KI	<table border="1"> <thead> <tr> <th>Code</th> <th>Description</th> <th>Qty</th> <th>UOM</th> </tr> </thead> <tbody> <tr> <td>VL1086A0</td> <td>LIMESCALE REMOVER NEODYMIUM MAGNET</td> <td>2</td> <td>PZ</td> </tr> <tr> <td>VM1224A0</td> <td></td> <td>0.200</td> <td>M</td> </tr> </tbody> </table>	Code	Description	Qty	UOM	VL1086A0	LIMESCALE REMOVER NEODYMIUM MAGNET	2	PZ	VM1224A0		0.200	M								
Code	Description	Qty	UOM																						
VL1086A0	LIMESCALE REMOVER NEODYMIUM MAGNET	2	PZ																						
VM1224A0		0.200	M																						
VL1096A	2PCS T-SHAPED FIT-D6-D10 HOLD-MAGNET		KVL1096A	T - SHAPED FIT-D6-D10 HOLD-2 MAGNETS KIT	<table border="1"> <thead> <tr> <th>Code</th> <th>Description</th> <th>Qty</th> <th>UOM</th> </tr> </thead> <tbody> <tr> <td>RC1018A0</td> <td>ZINC PLATED D12 ELASTIC CLAMP</td> <td>2</td> <td>PZ</td> </tr> <tr> <td>VL1086A0</td> <td>LIMESCALE REMOVER NEODYMIUM MAGNET</td> <td>2</td> <td>PZ</td> </tr> <tr> <td>VL1096A1</td> <td>2PCS T-SHAPED FIT-D6-D10 HOLD-MAGNE</td> <td>1</td> <td>PZ</td> </tr> <tr> <td>VM1224A0</td> <td></td> <td>0.200</td> <td>M</td> </tr> </tbody> </table>	Code	Description	Qty	UOM	RC1018A0	ZINC PLATED D12 ELASTIC CLAMP	2	PZ	VL1086A0	LIMESCALE REMOVER NEODYMIUM MAGNET	2	PZ	VL1096A1	2PCS T-SHAPED FIT-D6-D10 HOLD-MAGNE	1	PZ	VM1224A0		0.200	M
Code	Description	Qty	UOM																						
RC1018A0	ZINC PLATED D12 ELASTIC CLAMP	2	PZ																						
VL1086A0	LIMESCALE REMOVER NEODYMIUM MAGNET	2	PZ																						
VL1096A1	2PCS T-SHAPED FIT-D6-D10 HOLD-MAGNE	1	PZ																						
VM1224A0		0.200	M																						



COMPONENT			SPARE PART																																														
Code	Description	Image	Code	Description	Components list																																												
0H8038A	MM REDUCER SUPPORT PLATE		0H8038A0	MM REDUCER SUPPORT PLATE																																													
VM1054A	H7.8 PRESSURE REDUCER RING NUT		KVM1054A	H7.8 PRESSURE REDUCER DIAL KIT	<table border="1"> <thead> <tr> <th>Code</th> <th>Description</th> <th>Qty</th> <th>UOM</th> </tr> </thead> <tbody> <tr> <td>VM1054A0</td> <td>H7.8 PRESSURE REDUCER RING NUT</td> <td>1</td> <td>PZ</td> </tr> <tr> <td>VM1224A0</td> <td></td> <td>0.200</td> <td>M</td> </tr> </tbody> </table>	Code	Description	Qty	UOM	VM1054A0	H7.8 PRESSURE REDUCER RING NUT	1	PZ	VM1224A0		0.200	M																																
Code	Description	Qty	UOM																																														
VM1054A0	H7.8 PRESSURE REDUCER RING NUT	1	PZ																																														
VM1224A0		0.200	M																																														
			KVL1117A	EUR MM 2016+LMT FILTER+PRESS. RED. KIT	<table border="1"> <thead> <tr> <th>Code</th> <th>Description</th> <th>Qty</th> <th>UOM</th> </tr> </thead> <tbody> <tr> <td>0H7472A1</td> <td>DISTRIBUTOR SUPPORT PLATE</td> <td>1</td> <td>PZ</td> </tr> <tr> <td>RC1004A0</td> <td>Ø10-Ø8-8 Y CONNECTION</td> <td>1</td> <td>PZ</td> </tr> <tr> <td>RC1243A0</td> <td>Ø10F-Ø10M ELBOW CONNECTION + JG END KIT</td> <td>1</td> <td>PZ</td> </tr> <tr> <td>RC1372A0</td> <td>Ø10M-1/4 M CIL. STRAIGHT FITTING</td> <td>2</td> <td>PZ</td> </tr> <tr> <td>VI1220A1</td> <td>4,2X12 TCB SELF-TAPPIN G SCREW</td> <td>4</td> <td>PZ</td> </tr> <tr> <td>VL1014B1</td> <td>PRESSURE REDUCER WITH DISTRIBUTOR</td> <td>1</td> <td>PZ</td> </tr> <tr> <td>VL1014B2</td> <td></td> <td>1</td> <td>PZ</td> </tr> <tr> <td>VL1034C0</td> <td>MESH WATER FILTER D10</td> <td>1</td> <td>PZ</td> </tr> <tr> <td>VL1062C0</td> <td>PRESSURE REDUCER-FIL TER LOCKING FORK</td> <td>1</td> <td>PZ</td> </tr> <tr> <td>VM1054A0</td> <td>H7.8 PRESSURE REDUCER RING NUT</td> <td>1</td> <td>PZ</td> </tr> </tbody> </table>	Code	Description	Qty	UOM	0H7472A1	DISTRIBUTOR SUPPORT PLATE	1	PZ	RC1004A0	Ø10-Ø8-8 Y CONNECTION	1	PZ	RC1243A0	Ø10F-Ø10M ELBOW CONNECTION + JG END KIT	1	PZ	RC1372A0	Ø10M-1/4 M CIL. STRAIGHT FITTING	2	PZ	VI1220A1	4,2X12 TCB SELF-TAPPIN G SCREW	4	PZ	VL1014B1	PRESSURE REDUCER WITH DISTRIBUTOR	1	PZ	VL1014B2		1	PZ	VL1034C0	MESH WATER FILTER D10	1	PZ	VL1062C0	PRESSURE REDUCER-FIL TER LOCKING FORK	1	PZ	VM1054A0	H7.8 PRESSURE REDUCER RING NUT	1	PZ
Code	Description	Qty	UOM																																														
0H7472A1	DISTRIBUTOR SUPPORT PLATE	1	PZ																																														
RC1004A0	Ø10-Ø8-8 Y CONNECTION	1	PZ																																														
RC1243A0	Ø10F-Ø10M ELBOW CONNECTION + JG END KIT	1	PZ																																														
RC1372A0	Ø10M-1/4 M CIL. STRAIGHT FITTING	2	PZ																																														
VI1220A1	4,2X12 TCB SELF-TAPPIN G SCREW	4	PZ																																														
VL1014B1	PRESSURE REDUCER WITH DISTRIBUTOR	1	PZ																																														
VL1014B2		1	PZ																																														
VL1034C0	MESH WATER FILTER D10	1	PZ																																														
VL1062C0	PRESSURE REDUCER-FIL TER LOCKING FORK	1	PZ																																														
VM1054A0	H7.8 PRESSURE REDUCER RING NUT	1	PZ																																														



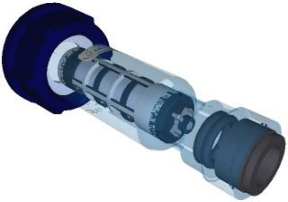

COMPONENT			SPARE PART																																														
Code	Description	Image	Code	Description	Components list																																												
RC1396A	JG D10-1/4 STRAIGHT END FITTING		KVL0014B	EUR 2017 MIND.MAPS PRESSURE REDUCER KIT	<table border="1"> <thead> <tr> <th>Code</th> <th>Description</th> <th>Qty</th> <th>UOM</th> </tr> </thead> <tbody> <tr> <td>RC1372A0</td> <td>Ø10M-1/4 M CIL. STRAIGHT FITTING</td> <td>1</td> <td>PZ</td> </tr> <tr> <td>RC1396A0</td> <td>JG D10-1/4 STRAIGHT END FITTING</td> <td>1</td> <td>PZ</td> </tr> <tr> <td>VL1014B1</td> <td>PRESSURE REDUCER WITH DISTRIBUTOR</td> <td>1</td> <td>PZ</td> </tr> <tr> <td>VL1014B2</td> <td></td> <td>1</td> <td>PZ</td> </tr> <tr> <td>VM1054A0</td> <td>H7.8 PRESSURE REDUCER RING NUT</td> <td>1</td> <td>PZ</td> </tr> </tbody> </table>	Code	Description	Qty	UOM	RC1372A0	Ø10M-1/4 M CIL. STRAIGHT FITTING	1	PZ	RC1396A0	JG D10-1/4 STRAIGHT END FITTING	1	PZ	VL1014B1	PRESSURE REDUCER WITH DISTRIBUTOR	1	PZ	VL1014B2		1	PZ	VM1054A0	H7.8 PRESSURE REDUCER RING NUT	1	PZ																				
Code	Description	Qty	UOM																																														
RC1372A0	Ø10M-1/4 M CIL. STRAIGHT FITTING	1	PZ																																														
RC1396A0	JG D10-1/4 STRAIGHT END FITTING	1	PZ																																														
VL1014B1	PRESSURE REDUCER WITH DISTRIBUTOR	1	PZ																																														
VL1014B2		1	PZ																																														
VM1054A0	H7.8 PRESSURE REDUCER RING NUT	1	PZ																																														
VL1014B			KVL1117A	EUR MM 2016+LMT FILTER+PRESS. RED. KIT	<table border="1"> <thead> <tr> <th>Code</th> <th>Description</th> <th>Qty</th> <th>UOM</th> </tr> </thead> <tbody> <tr> <td>0H7472A1</td> <td>DISTRIBUTOR SUPPORT PLATE</td> <td>1</td> <td>PZ</td> </tr> <tr> <td>RC1004A0</td> <td>Ø10-Ø8-8 Y CONNECTION</td> <td>1</td> <td>PZ</td> </tr> <tr> <td>RC1243A0</td> <td>Ø10F-Ø10M ELBOW CONNECTION + JG END KIT</td> <td>1</td> <td>PZ</td> </tr> <tr> <td>RC1372A0</td> <td>Ø10M-1/4 M CIL. STRAIGHT FITTING</td> <td>2</td> <td>PZ</td> </tr> <tr> <td>VI1220A1</td> <td>4,2X12 TCB SELF-TAPPIN G SCREW</td> <td>4</td> <td>PZ</td> </tr> <tr> <td>VL1014B1</td> <td>PRESSURE REDUCER WITH DISTRIBUTOR</td> <td>1</td> <td>PZ</td> </tr> <tr> <td>VL1014B2</td> <td></td> <td>1</td> <td>PZ</td> </tr> <tr> <td>VL1034C0</td> <td>MESH WATER FILTER D10</td> <td>1</td> <td>PZ</td> </tr> <tr> <td>VL1062C0</td> <td>PRESSURE REDUCER-FIL TER LOCKING FORK</td> <td>1</td> <td>PZ</td> </tr> <tr> <td>VM1054A0</td> <td>H7.8 PRESSURE REDUCER RING NUT</td> <td>1</td> <td>PZ</td> </tr> </tbody> </table>	Code	Description	Qty	UOM	0H7472A1	DISTRIBUTOR SUPPORT PLATE	1	PZ	RC1004A0	Ø10-Ø8-8 Y CONNECTION	1	PZ	RC1243A0	Ø10F-Ø10M ELBOW CONNECTION + JG END KIT	1	PZ	RC1372A0	Ø10M-1/4 M CIL. STRAIGHT FITTING	2	PZ	VI1220A1	4,2X12 TCB SELF-TAPPIN G SCREW	4	PZ	VL1014B1	PRESSURE REDUCER WITH DISTRIBUTOR	1	PZ	VL1014B2		1	PZ	VL1034C0	MESH WATER FILTER D10	1	PZ	VL1062C0	PRESSURE REDUCER-FIL TER LOCKING FORK	1	PZ	VM1054A0	H7.8 PRESSURE REDUCER RING NUT	1	PZ
Code	Description	Qty	UOM																																														
0H7472A1	DISTRIBUTOR SUPPORT PLATE	1	PZ																																														
RC1004A0	Ø10-Ø8-8 Y CONNECTION	1	PZ																																														
RC1243A0	Ø10F-Ø10M ELBOW CONNECTION + JG END KIT	1	PZ																																														
RC1372A0	Ø10M-1/4 M CIL. STRAIGHT FITTING	2	PZ																																														
VI1220A1	4,2X12 TCB SELF-TAPPIN G SCREW	4	PZ																																														
VL1014B1	PRESSURE REDUCER WITH DISTRIBUTOR	1	PZ																																														
VL1014B2		1	PZ																																														
VL1034C0	MESH WATER FILTER D10	1	PZ																																														
VL1062C0	PRESSURE REDUCER-FIL TER LOCKING FORK	1	PZ																																														
VM1054A0	H7.8 PRESSURE REDUCER RING NUT	1	PZ																																														
			KVL0020A	PRESSURE REDUCER 0311-05XX FROM	<table border="1"> <thead> <tr> <th>Code</th> <th>Description</th> <th>Qty</th> <th>UOM</th> </tr> </thead> <tbody> <tr> <td>RC1396A0</td> <td>JG D10-1/4 STRAIGHT END FITTING</td> <td>2</td> <td>PZ</td> </tr> </tbody> </table>	Code	Description	Qty	UOM	RC1396A0	JG D10-1/4 STRAIGHT END FITTING	2	PZ																																				
Code	Description	Qty	UOM																																														
RC1396A0	JG D10-1/4 STRAIGHT END FITTING	2	PZ																																														





10/2018

COMPONENT			SPARE PART																										
Code	Description	Image	Code	Description	Components list																								
VL1014B			KVL0020A	PRESSURE REDUCER 0311-05XX FROM 10/2018	<table border="1"> <thead> <tr> <th>Code</th> <th>Description</th> <th>Qty</th> <th>UOM</th> </tr> </thead> <tbody> <tr> <td>VL1014B1</td> <td>PRESSURE REDUCER WITH DISTRIBUTOR</td> <td>1</td> <td>PZ</td> </tr> <tr> <td>VL1014B2</td> <td></td> <td>1</td> <td>PZ</td> </tr> <tr> <td>VM1054A0</td> <td>H7.8 PRESSURE REDUCER RING NUT</td> <td>1</td> <td>PZ</td> </tr> </tbody> </table>	Code	Description	Qty	UOM	VL1014B1	PRESSURE REDUCER WITH DISTRIBUTOR	1	PZ	VL1014B2		1	PZ	VM1054A0	H7.8 PRESSURE REDUCER RING NUT	1	PZ								
			Code	Description	Qty	UOM																							
			VL1014B1	PRESSURE REDUCER WITH DISTRIBUTOR	1	PZ																							
			VL1014B2		1	PZ																							
			VM1054A0	H7.8 PRESSURE REDUCER RING NUT	1	PZ																							
			KVL0014B	EUR 2017 MIND.MAPS PRESSURE REDUCER KIT	<table border="1"> <thead> <tr> <th>Code</th> <th>Description</th> <th>Qty</th> <th>UOM</th> </tr> </thead> <tbody> <tr> <td>RC1372A0</td> <td>Ø10M-1/4 M CIL. STRAIGHT FITTING</td> <td>1</td> <td>PZ</td> </tr> <tr> <td>RC1396A0</td> <td>JG D10-1/4 STRAIGHT END FITTING</td> <td>1</td> <td>PZ</td> </tr> <tr> <td>VL1014B1</td> <td>PRESSURE REDUCER WITH DISTRIBUTOR</td> <td>1</td> <td>PZ</td> </tr> <tr> <td>VL1014B2</td> <td></td> <td>1</td> <td>PZ</td> </tr> <tr> <td>VM1054A0</td> <td>H7.8 PRESSURE REDUCER RING NUT</td> <td>1</td> <td>PZ</td> </tr> </tbody> </table>	Code	Description	Qty	UOM	RC1372A0	Ø10M-1/4 M CIL. STRAIGHT FITTING	1	PZ	RC1396A0	JG D10-1/4 STRAIGHT END FITTING	1	PZ	VL1014B1	PRESSURE REDUCER WITH DISTRIBUTOR	1	PZ	VL1014B2		1	PZ	VM1054A0	H7.8 PRESSURE REDUCER RING NUT	1	PZ
			Code	Description	Qty	UOM																							
			RC1372A0	Ø10M-1/4 M CIL. STRAIGHT FITTING	1	PZ																							
			RC1396A0	JG D10-1/4 STRAIGHT END FITTING	1	PZ																							
			VL1014B1	PRESSURE REDUCER WITH DISTRIBUTOR	1	PZ																							
			VL1014B2		1	PZ																							
			VM1054A0	H7.8 PRESSURE REDUCER RING NUT	1	PZ																							
KVL0014A	EUR MIND.MAPS PRESSURE REDUCER KIT 2016	<table border="1"> <thead> <tr> <th>Code</th> <th>Description</th> <th>Qty</th> <th>UOM</th> </tr> </thead> <tbody> <tr> <td>RC1372A0</td> <td>Ø10M-1/4 M CIL. STRAIGHT FITTING</td> <td>2</td> <td>PZ</td> </tr> <tr> <td>VL1014B1</td> <td>PRESSURE REDUCER WITH DISTRIBUTOR</td> <td>1</td> <td>PZ</td> </tr> <tr> <td>VL1014B2</td> <td></td> <td>1</td> <td>PZ</td> </tr> <tr> <td>VM1054A0</td> <td>H7.8 PRESSURE REDUCER RING NUT</td> <td>1</td> <td>PZ</td> </tr> </tbody> </table>	Code	Description	Qty	UOM	RC1372A0	Ø10M-1/4 M CIL. STRAIGHT FITTING	2	PZ	VL1014B1	PRESSURE REDUCER WITH DISTRIBUTOR	1	PZ	VL1014B2		1	PZ	VM1054A0	H7.8 PRESSURE REDUCER RING NUT	1	PZ							
Code	Description	Qty	UOM																										
RC1372A0	Ø10M-1/4 M CIL. STRAIGHT FITTING	2	PZ																										
VL1014B1	PRESSURE REDUCER WITH DISTRIBUTOR	1	PZ																										
VL1014B2		1	PZ																										
VM1054A0	H7.8 PRESSURE REDUCER RING NUT	1	PZ																										
KVL0010A	S.4 - 5 WATER PRESSURE REDUCER KIT	<table border="1"> <thead> <tr> <th>Code</th> <th>Description</th> <th>Qty</th> <th>UOM</th> </tr> </thead> <tbody> <tr> <td>EL1210A0</td> <td>D8-BSP1/4 JG STRAIGHT END CONNECTION</td> <td>2</td> <td>PZ</td> </tr> <tr> <td>VL1014B1</td> <td>PRESSURE REDUCER WITH DISTRIBUTOR</td> <td>1</td> <td>PZ</td> </tr> <tr> <td>VL1014B2</td> <td></td> <td>1</td> <td>PZ</td> </tr> </tbody> </table>	Code	Description	Qty	UOM	EL1210A0	D8-BSP1/4 JG STRAIGHT END CONNECTION	2	PZ	VL1014B1	PRESSURE REDUCER WITH DISTRIBUTOR	1	PZ	VL1014B2		1	PZ											
Code	Description	Qty	UOM																										
EL1210A0	D8-BSP1/4 JG STRAIGHT END CONNECTION	2	PZ																										
VL1014B1	PRESSURE REDUCER WITH DISTRIBUTOR	1	PZ																										
VL1014B2		1	PZ																										

COMPONENT			SPARE PART																																														
Code	Description	Image	Code	Description	Components list																																												
RC1243A	Ø10F-Ø10M ELBOW CONNECTION + JG END KIT		KVL1117A	EUR MM 2016+LMT FILTER+PRESS. RED. KIT	<table border="1"> <thead> <tr> <th>Code</th> <th>Description</th> <th>Qty</th> <th>UOM</th> </tr> </thead> <tbody> <tr> <td>0H7472A1</td> <td>DISTRIBUTOR SUPPORT PLATE</td> <td>1</td> <td>PZ</td> </tr> <tr> <td>RC1004A0</td> <td>Ø10-Ø8-8 Y CONNECTION</td> <td>1</td> <td>PZ</td> </tr> <tr> <td>RC1243A0</td> <td>Ø10F-Ø10M ELBOW CONNECTION + JG END KIT</td> <td>1</td> <td>PZ</td> </tr> <tr> <td>RC1372A0</td> <td>Ø10M-1/4 M CIL. STRAIGHT FITTING</td> <td>2</td> <td>PZ</td> </tr> <tr> <td>VI1220A1</td> <td>4,2X12 TCB SELF-TAPPIN G SCREW</td> <td>4</td> <td>PZ</td> </tr> <tr> <td>VL1014B1</td> <td>PRESSURE REDUCER WITH DISTRIBUTOR</td> <td>1</td> <td>PZ</td> </tr> <tr> <td>VL1014B2</td> <td></td> <td>1</td> <td>PZ</td> </tr> <tr> <td>VL1034C0</td> <td>MESH WATER FILTER D10</td> <td>1</td> <td>PZ</td> </tr> <tr> <td>VL1062C0</td> <td>PRESSURE REDUCER-FILTER LOCKING FORK</td> <td>1</td> <td>PZ</td> </tr> <tr> <td>VM1054A0</td> <td>H7.8 PRESSURE REDUCER RING NUT</td> <td>1</td> <td>PZ</td> </tr> </tbody> </table>	Code	Description	Qty	UOM	0H7472A1	DISTRIBUTOR SUPPORT PLATE	1	PZ	RC1004A0	Ø10-Ø8-8 Y CONNECTION	1	PZ	RC1243A0	Ø10F-Ø10M ELBOW CONNECTION + JG END KIT	1	PZ	RC1372A0	Ø10M-1/4 M CIL. STRAIGHT FITTING	2	PZ	VI1220A1	4,2X12 TCB SELF-TAPPIN G SCREW	4	PZ	VL1014B1	PRESSURE REDUCER WITH DISTRIBUTOR	1	PZ	VL1014B2		1	PZ	VL1034C0	MESH WATER FILTER D10	1	PZ	VL1062C0	PRESSURE REDUCER-FILTER LOCKING FORK	1	PZ	VM1054A0	H7.8 PRESSURE REDUCER RING NUT	1	PZ
			Code	Description	Qty	UOM																																											
0H7472A1	DISTRIBUTOR SUPPORT PLATE	1	PZ																																														
RC1004A0	Ø10-Ø8-8 Y CONNECTION	1	PZ																																														
RC1243A0	Ø10F-Ø10M ELBOW CONNECTION + JG END KIT	1	PZ																																														
RC1372A0	Ø10M-1/4 M CIL. STRAIGHT FITTING	2	PZ																																														
VI1220A1	4,2X12 TCB SELF-TAPPIN G SCREW	4	PZ																																														
VL1014B1	PRESSURE REDUCER WITH DISTRIBUTOR	1	PZ																																														
VL1014B2		1	PZ																																														
VL1034C0	MESH WATER FILTER D10	1	PZ																																														
VL1062C0	PRESSURE REDUCER-FILTER LOCKING FORK	1	PZ																																														
VM1054A0	H7.8 PRESSURE REDUCER RING NUT	1	PZ																																														
KRC1243A	Ø10F-Ø10M ELBOW CONN + JG END 10 PCS KIT	<table border="1"> <thead> <tr> <th>Code</th> <th>Description</th> <th>Qty</th> <th>UOM</th> </tr> </thead> <tbody> <tr> <td>RC1243A0</td> <td>Ø10F-Ø10M ELBOW CONNECTION + JG END KIT</td> <td>10</td> <td>PZ</td> </tr> <tr> <td>VM1224A0</td> <td></td> <td>0.200</td> <td>M</td> </tr> </tbody> </table>	Code	Description	Qty	UOM	RC1243A0	Ø10F-Ø10M ELBOW CONNECTION + JG END KIT	10	PZ	VM1224A0		0.200	M																																			
Code	Description	Qty	UOM																																														
RC1243A0	Ø10F-Ø10M ELBOW CONNECTION + JG END KIT	10	PZ																																														
VM1224A0		0.200	M																																														
VL1135A			KVL1135A	3/4-JG10 FITTING WITH FILTER AND VNR KIT	<table border="1"> <thead> <tr> <th>Code</th> <th>Description</th> <th>Qty</th> <th>UOM</th> </tr> </thead> <tbody> <tr> <td>VL1135A0</td> <td></td> <td>1</td> <td>PZ</td> </tr> <tr> <td>VM1224A0</td> <td></td> <td>0.150</td> <td>M</td> </tr> </tbody> </table>	Code	Description	Qty	UOM	VL1135A0		1	PZ	VM1224A0		0.150	M																																
Code	Description	Qty	UOM																																														
VL1135A0		1	PZ																																														
VM1224A0		0.150	M																																														

COMPONENT			SPARE PART																																																																		
Code	Description	Image	Code	Description	Components list																																																																
EL1438A	BARBED STEAM SOLENOID VALVE 5+9		KEL1438A	5+9 BARBED 6 STEAM SOLENOID VALVE KIT	<table border="1"> <thead> <tr> <th>Code</th> <th>Description</th> <th>Qty</th> <th>UOM</th> </tr> </thead> <tbody> <tr> <td>EL1438A0</td> <td>BARBED STEAM SOLENOID VALVE 5+9</td> <td>1</td> <td>PZ</td> </tr> <tr> <td>RC1018A0</td> <td>ZINC PLATED D12 ELASTIC CLAMP</td> <td>2</td> <td>PZ</td> </tr> <tr> <td>VM1224A0</td> <td></td> <td>0.250</td> <td>M</td> </tr> </tbody> </table>	Code	Description	Qty	UOM	EL1438A0	BARBED STEAM SOLENOID VALVE 5+9	1	PZ	RC1018A0	ZINC PLATED D12 ELASTIC CLAMP	2	PZ	VM1224A0		0.250	M																																																
					Code	Description	Qty	UOM																																																													
					EL1438A0	BARBED STEAM SOLENOID VALVE 5+9	1	PZ																																																													
RC1018A0	ZINC PLATED D12 ELASTIC CLAMP	2	PZ																																																																		
VM1224A0		0.250	M																																																																		
VL1106C			KVL1106A	EUR 1 ROTOR ARM ONE CLEANING SYSTEM KIT	<table border="1"> <thead> <tr> <th>Code</th> <th>Description</th> <th>Qty</th> <th>UOM</th> </tr> </thead> <tbody> <tr> <td>0H2143A0</td> <td></td> <td>1</td> <td>PZ</td> </tr> <tr> <td>0H7819A0</td> <td>ONE WASHING SYS SUPPORT WITH STEAM VALVE</td> <td>1</td> <td>PZ</td> </tr> <tr> <td>EL1436A0</td> <td>H2O SOLENOID JG D8 CHECK VALVE</td> <td>1</td> <td>PZ</td> </tr> <tr> <td>EL1436B0</td> <td></td> <td>1</td> <td>PZ</td> </tr> <tr> <td>GN1526A0</td> <td>INT. D.=6.9 TH=1.8 O-RING</td> <td>1</td> <td>PZ</td> </tr> <tr> <td>RC1242A0</td> <td>D=10 CLOSED CAP</td> <td>2</td> <td>PZ</td> </tr> <tr> <td>TB2820A0</td> <td>PIPE EPDM FOR WASHING SYSTEM</td> <td>1.420</td> <td>M</td> </tr> <tr> <td>VI1220A1</td> <td>4,2X12 TCB SELF-TAPPIN G SCREW</td> <td>1</td> <td>PZ</td> </tr> <tr> <td>VL1019A0</td> <td>VIBRATION PUMP</td> <td>1</td> <td>PZ</td> </tr> <tr> <td>VL1053B0</td> <td>ONE WASHING SYS EXT DISTRIBUTOR</td> <td>1</td> <td>PZ</td> </tr> <tr> <td>VL1054B0</td> <td>ONE WASHING SYS INLET DISTRIBUTOR</td> <td>1</td> <td>PZ</td> </tr> <tr> <td>VL1102A1</td> <td>DETERGENT LINE FILTER + BARBED VNR 6 MM</td> <td>1</td> <td>PZ</td> </tr> <tr> <td>VL1128A0</td> <td>BARBED CHECK VALVE D6</td> <td>1</td> <td>PZ</td> </tr> <tr> <td>VL1128A1</td> <td></td> <td>1</td> <td>PZ</td> </tr> <tr> <td>VM2172A0</td> <td>PUMP-WITH-CI RCUIT LOCKING PIN</td> <td>1</td> <td>PZ</td> </tr> </tbody> </table>	Code	Description	Qty	UOM	0H2143A0		1	PZ	0H7819A0	ONE WASHING SYS SUPPORT WITH STEAM VALVE	1	PZ	EL1436A0	H2O SOLENOID JG D8 CHECK VALVE	1	PZ	EL1436B0		1	PZ	GN1526A0	INT. D.=6.9 TH=1.8 O-RING	1	PZ	RC1242A0	D=10 CLOSED CAP	2	PZ	TB2820A0	PIPE EPDM FOR WASHING SYSTEM	1.420	M	VI1220A1	4,2X12 TCB SELF-TAPPIN G SCREW	1	PZ	VL1019A0	VIBRATION PUMP	1	PZ	VL1053B0	ONE WASHING SYS EXT DISTRIBUTOR	1	PZ	VL1054B0	ONE WASHING SYS INLET DISTRIBUTOR	1	PZ	VL1102A1	DETERGENT LINE FILTER + BARBED VNR 6 MM	1	PZ	VL1128A0	BARBED CHECK VALVE D6	1	PZ	VL1128A1		1	PZ	VM2172A0	PUMP-WITH-CI RCUIT LOCKING PIN	1	PZ
					Code	Description	Qty	UOM																																																													
					0H2143A0		1	PZ																																																													
					0H7819A0	ONE WASHING SYS SUPPORT WITH STEAM VALVE	1	PZ																																																													
					EL1436A0	H2O SOLENOID JG D8 CHECK VALVE	1	PZ																																																													
					EL1436B0		1	PZ																																																													
					GN1526A0	INT. D.=6.9 TH=1.8 O-RING	1	PZ																																																													
					RC1242A0	D=10 CLOSED CAP	2	PZ																																																													
					TB2820A0	PIPE EPDM FOR WASHING SYSTEM	1.420	M																																																													
					VI1220A1	4,2X12 TCB SELF-TAPPIN G SCREW	1	PZ																																																													
					VL1019A0	VIBRATION PUMP	1	PZ																																																													
					VL1053B0	ONE WASHING SYS EXT DISTRIBUTOR	1	PZ																																																													
					VL1054B0	ONE WASHING SYS INLET DISTRIBUTOR	1	PZ																																																													
					VL1102A1	DETERGENT LINE FILTER + BARBED VNR 6 MM	1	PZ																																																													
					VL1128A0	BARBED CHECK VALVE D6	1	PZ																																																													
					VL1128A1		1	PZ																																																													
					VM2172A0	PUMP-WITH-CI RCUIT LOCKING PIN	1	PZ																																																													

COMPONENT			SPARE PART																														
Code	Description	Image	Code	Description	Components list																												
RC1019A	D=10 ELASTIC CLAM		KRC1019A	Ø10 ZINC PLATED ELASTIC CLAMP 15 PCS KIT	<table border="1"> <thead> <tr> <th>Code</th> <th>Description</th> <th>Qty</th> <th>UOM</th> </tr> </thead> <tbody> <tr> <td>RC1019A0</td> <td>D=10 ELASTIC CLAMP</td> <td>17</td> <td>PZ</td> </tr> <tr> <td>VM1224A0</td> <td></td> <td>0.200</td> <td>M</td> </tr> </tbody> </table>	Code	Description	Qty	UOM	RC1019A0	D=10 ELASTIC CLAMP	17	PZ	VM1224A0		0.200	M																
Code	Description	Qty	UOM																														
RC1019A0	D=10 ELASTIC CLAMP	17	PZ																														
VM1224A0		0.200	M																														
VL1047A	D6 PIPE HOLDER - D8 J.G. TERMINAL		KVL1047A KVL0016A	Ø6 PIPE HOLDER+Ø8 JG TERMINAL 10 PCS KIT BRITA ADAPTOR KIT FOR MM CLEANING SYSTEM	<table border="1"> <thead> <tr> <th>Code</th> <th>Description</th> <th>Qty</th> <th>UOM</th> </tr> </thead> <tbody> <tr> <td>VL1047A1</td> <td>D6 PIPE HOLDER - D8 J.G. TERMINAL</td> <td>10</td> <td>PZ</td> </tr> <tr> <td>VM1224A0</td> <td></td> <td>0.200</td> <td>M</td> </tr> </tbody> </table> <table border="1"> <thead> <tr> <th>Code</th> <th>Description</th> <th>Qty</th> <th>UOM</th> </tr> </thead> <tbody> <tr> <td>EL1185A0</td> <td>Ø8F - Ø8F ELBOW CONNECTION</td> <td>260</td> <td>PZ</td> </tr> <tr> <td>RC1018A0</td> <td>ZINC PLATED D12 ELASTIC CLAMP</td> <td>520</td> <td>PZ</td> </tr> <tr> <td>VL1047A1</td> <td>D6 PIPE HOLDER - D8 J.G. TERMINAL</td> <td>520</td> <td>PZ</td> </tr> </tbody> </table>	Code	Description	Qty	UOM	VL1047A1	D6 PIPE HOLDER - D8 J.G. TERMINAL	10	PZ	VM1224A0		0.200	M	Code	Description	Qty	UOM	EL1185A0	Ø8F - Ø8F ELBOW CONNECTION	260	PZ	RC1018A0	ZINC PLATED D12 ELASTIC CLAMP	520	PZ	VL1047A1	D6 PIPE HOLDER - D8 J.G. TERMINAL	520	PZ
Code	Description	Qty	UOM																														
VL1047A1	D6 PIPE HOLDER - D8 J.G. TERMINAL	10	PZ																														
VM1224A0		0.200	M																														
Code	Description	Qty	UOM																														
EL1185A0	Ø8F - Ø8F ELBOW CONNECTION	260	PZ																														
RC1018A0	ZINC PLATED D12 ELASTIC CLAMP	520	PZ																														
VL1047A1	D6 PIPE HOLDER - D8 J.G. TERMINAL	520	PZ																														
TB3007A	TB2820A-DETERGENT ONE COIL		KTB3007A	MIND.MAPS ONE DETERGENT PIPE COIL KIT	<table border="1"> <thead> <tr> <th>Code</th> <th>Description</th> <th>Qty</th> <th>UOM</th> </tr> </thead> <tbody> <tr> <td>TB2820A0</td> <td>PIPE EPDM FOR WASHING SYSTEM</td> <td>0.550</td> <td>M</td> </tr> </tbody> </table>	Code	Description	Qty	UOM	TB2820A0	PIPE EPDM FOR WASHING SYSTEM	0.550	M																				
Code	Description	Qty	UOM																														
TB2820A0	PIPE EPDM FOR WASHING SYSTEM	0.550	M																														
TB3225B	TB2820A-TANK-WASHING SYS CONNECTION		TB3225B0	TB2820A-TANK-WASHING SYS CONNECTION																													

COMPONENT			SPARE PART																										
Code	Description	Image	Code	Description	Components list																								
TB3009B	TB3132A-ONE OVEN WASHING INLET		KTB3009B	0,68M 6X12 BLUE-WHITE EPDM PIPE KIT	<table border="1"> <thead> <tr> <th>Code</th> <th>Description</th> <th>Qty</th> <th>UOM</th> </tr> </thead> <tbody> <tr> <td>TB3132A0</td> <td>WHITE-BLUE EPDM TEXTILE BRAID HOSE 6X12</td> <td>0.680</td> <td>M</td> </tr> </tbody> </table>	Code	Description	Qty	UOM	TB3132A0	WHITE-BLUE EPDM TEXTILE BRAID HOSE 6X12	0.680	M																
Code	Description	Qty	UOM																										
TB3132A0	WHITE-BLUE EPDM TEXTILE BRAID HOSE 6X12	0.680	M																										
0H7819A	ONE WASHING SYS SUPPORT WITH STEAM VALVE		0H7819A0	ONE WASHING SYS SUPPORT WITH STEAM VALVE																									
VL1102A	DETERGENT LINE FILTER + BARBED VNR 6 MM		KVL1102A	DETERGENT FILTER + NRV KIT	<table border="1"> <thead> <tr> <th>Code</th> <th>Description</th> <th>Qty</th> <th>UOM</th> </tr> </thead> <tbody> <tr> <td>RC1019A0</td> <td>D=10 ELASTIC CLAMP</td> <td>5</td> <td>PZ</td> </tr> <tr> <td>TB2820A0</td> <td>PIPE EPDM FOR WASHING SYSTEM</td> <td>0.710</td> <td>M</td> </tr> <tr> <td>VL1102A1</td> <td>DETERGENT LINE FILTER + BARBED VNR 6 MM</td> <td>1</td> <td>PZ</td> </tr> <tr> <td>VM1224A0</td> <td></td> <td>0.300</td> <td>M</td> </tr> </tbody> </table>	Code	Description	Qty	UOM	RC1019A0	D=10 ELASTIC CLAMP	5	PZ	TB2820A0	PIPE EPDM FOR WASHING SYSTEM	0.710	M	VL1102A1	DETERGENT LINE FILTER + BARBED VNR 6 MM	1	PZ	VM1224A0		0.300	M				
Code	Description	Qty	UOM																										
RC1019A0	D=10 ELASTIC CLAMP	5	PZ																										
TB2820A0	PIPE EPDM FOR WASHING SYSTEM	0.710	M																										
VL1102A1	DETERGENT LINE FILTER + BARBED VNR 6 MM	1	PZ																										
VM1224A0		0.300	M																										
TB3256A			TB3256A0																										
VL1019A	VIBRATION PUMP		KVL1187A	2021 BIG-L CLEANING SYSTEM KIT	<table border="1"> <thead> <tr> <th>Code</th> <th>Description</th> <th>Qty</th> <th>UOM</th> </tr> </thead> <tbody> <tr> <td>0H2143A0</td> <td></td> <td>3</td> <td>PZ</td> </tr> <tr> <td>0H2168A0</td> <td></td> <td>1</td> <td>PZ</td> </tr> <tr> <td>0H2354A0</td> <td></td> <td>1</td> <td>PZ</td> </tr> <tr> <td>EL1120A0</td> <td>D8-D6 FEMALE STRAIGHT INTERM. CONNECTION</td> <td>1</td> <td>PZ</td> </tr> <tr> <td>EL1220A0</td> <td>JG STRAIGHT CONNECTION Ø8F-Ø8F</td> <td>2</td> <td>PZ</td> </tr> </tbody> </table>	Code	Description	Qty	UOM	0H2143A0		3	PZ	0H2168A0		1	PZ	0H2354A0		1	PZ	EL1120A0	D8-D6 FEMALE STRAIGHT INTERM. CONNECTION	1	PZ	EL1220A0	JG STRAIGHT CONNECTION Ø8F-Ø8F	2	PZ
Code	Description	Qty	UOM																										
0H2143A0		3	PZ																										
0H2168A0		1	PZ																										
0H2354A0		1	PZ																										
EL1120A0	D8-D6 FEMALE STRAIGHT INTERM. CONNECTION	1	PZ																										
EL1220A0	JG STRAIGHT CONNECTION Ø8F-Ø8F	2	PZ																										





COMPONENT			SPARE PART																																																																																			
Code	Description	Image	Code	Description	Components list																																																																																	
VL1019A	VIBRATION PUMP		KVL1187A	2021 BIG-L CLEANING SYSTEM KIT	<table border="1"> <thead> <tr> <th>Code</th> <th>Description</th> <th>Qty</th> <th>UOM</th> </tr> </thead> <tbody> <tr> <td>EL1440A0</td> <td>WATER SELF CLEANING VALVE</td> <td>4</td> <td>PZ</td> </tr> <tr> <td>GN1526A0</td> <td>INT. D.=6.9 TH=1.8 O-RIN</td> <td>9</td> <td>PZ</td> </tr> <tr> <td>RC1018A0</td> <td>ZINC PLATED D12 ELASTIC CLAMP</td> <td>10</td> <td>PZ</td> </tr> <tr> <td>RC1019A0</td> <td>D=10 ELASTIC CLAMP</td> <td>22</td> <td>PZ</td> </tr> <tr> <td>RC1130A0</td> <td>130X2,6 CLAM</td> <td>4</td> <td>PZ</td> </tr> <tr> <td>RC1131A0</td> <td></td> <td>3</td> <td>PZ</td> </tr> <tr> <td>RC1242A0</td> <td>D=10 CLOSED CAP</td> <td>2</td> <td>PZ</td> </tr> <tr> <td>RC1310A0</td> <td>140X4 CLAMP WITH CLIP</td> <td>1</td> <td>PZ</td> </tr> <tr> <td>RC1356A0</td> <td>STRAIGHT THREADED FEMALE END 8X1/4" BSP</td> <td>1</td> <td>PZ</td> </tr> <tr> <td>TB2820A0</td> <td>PIPE EPDM FOR WASHING SYSTEM</td> <td>1.510</td> <td>M</td> </tr> <tr> <td>TB3132A0</td> <td>WHITE-BLUE EPDM TEXTILE BRAID HOSE 6X12</td> <td>1.210</td> <td>M</td> </tr> <tr> <td>VI1220A1</td> <td>4,2X12 TCB SELF-TAPPIN G SCREW</td> <td>3</td> <td>PZ</td> </tr> <tr> <td>VL1019A0</td> <td>VIBRATION PUMP</td> <td>1</td> <td>PZ</td> </tr> <tr> <td>VL1046A1</td> <td>D6 PIPE HOLDER - D6 J.G. TERMINAL</td> <td>3</td> <td>PZ</td> </tr> <tr> <td>VL1047A1</td> <td>D6 PIPE HOLDER - D6 J.G. TERMINAL</td> <td>1</td> <td>PZ</td> </tr> <tr> <td>VL1064A0</td> <td>WASHING SYSTEM OUTLETS DISTRIBUTOR</td> <td>1</td> <td>PZ</td> </tr> <tr> <td>VL1065A1</td> <td>1/4 MALE N.O. PRESSURE SWITCH</td> <td>1</td> <td>PZ</td> </tr> <tr> <td>VL1067A0</td> <td>WASHING SYSTEM INLETS DISTRIBUTOR</td> <td>1</td> <td>PZ</td> </tr> <tr> <td>VL1092A0</td> <td>WASHING SYSTEM OUTLET DOUBLE DISTRIBUTOR</td> <td>1</td> <td>PZ</td> </tr> </tbody> </table>	Code	Description	Qty	UOM	EL1440A0	WATER SELF CLEANING VALVE	4	PZ	GN1526A0	INT. D.=6.9 TH=1.8 O-RIN	9	PZ	RC1018A0	ZINC PLATED D12 ELASTIC CLAMP	10	PZ	RC1019A0	D=10 ELASTIC CLAMP	22	PZ	RC1130A0	130X2,6 CLAM	4	PZ	RC1131A0		3	PZ	RC1242A0	D=10 CLOSED CAP	2	PZ	RC1310A0	140X4 CLAMP WITH CLIP	1	PZ	RC1356A0	STRAIGHT THREADED FEMALE END 8X1/4" BSP	1	PZ	TB2820A0	PIPE EPDM FOR WASHING SYSTEM	1.510	M	TB3132A0	WHITE-BLUE EPDM TEXTILE BRAID HOSE 6X12	1.210	M	VI1220A1	4,2X12 TCB SELF-TAPPIN G SCREW	3	PZ	VL1019A0	VIBRATION PUMP	1	PZ	VL1046A1	D6 PIPE HOLDER - D6 J.G. TERMINAL	3	PZ	VL1047A1	D6 PIPE HOLDER - D6 J.G. TERMINAL	1	PZ	VL1064A0	WASHING SYSTEM OUTLETS DISTRIBUTOR	1	PZ	VL1065A1	1/4 MALE N.O. PRESSURE SWITCH	1	PZ	VL1067A0	WASHING SYSTEM INLETS DISTRIBUTOR	1	PZ	VL1092A0	WASHING SYSTEM OUTLET DOUBLE DISTRIBUTOR	1	PZ	
Code	Description	Qty	UOM																																																																																			
EL1440A0	WATER SELF CLEANING VALVE	4	PZ																																																																																			
GN1526A0	INT. D.=6.9 TH=1.8 O-RIN	9	PZ																																																																																			
RC1018A0	ZINC PLATED D12 ELASTIC CLAMP	10	PZ																																																																																			
RC1019A0	D=10 ELASTIC CLAMP	22	PZ																																																																																			
RC1130A0	130X2,6 CLAM	4	PZ																																																																																			
RC1131A0		3	PZ																																																																																			
RC1242A0	D=10 CLOSED CAP	2	PZ																																																																																			
RC1310A0	140X4 CLAMP WITH CLIP	1	PZ																																																																																			
RC1356A0	STRAIGHT THREADED FEMALE END 8X1/4" BSP	1	PZ																																																																																			
TB2820A0	PIPE EPDM FOR WASHING SYSTEM	1.510	M																																																																																			
TB3132A0	WHITE-BLUE EPDM TEXTILE BRAID HOSE 6X12	1.210	M																																																																																			
VI1220A1	4,2X12 TCB SELF-TAPPIN G SCREW	3	PZ																																																																																			
VL1019A0	VIBRATION PUMP	1	PZ																																																																																			
VL1046A1	D6 PIPE HOLDER - D6 J.G. TERMINAL	3	PZ																																																																																			
VL1047A1	D6 PIPE HOLDER - D6 J.G. TERMINAL	1	PZ																																																																																			
VL1064A0	WASHING SYSTEM OUTLETS DISTRIBUTOR	1	PZ																																																																																			
VL1065A1	1/4 MALE N.O. PRESSURE SWITCH	1	PZ																																																																																			
VL1067A0	WASHING SYSTEM INLETS DISTRIBUTOR	1	PZ																																																																																			
VL1092A0	WASHING SYSTEM OUTLET DOUBLE DISTRIBUTOR	1	PZ																																																																																			

COMPONENT			SPARE PART																																																										
Code	Description	Image	Code	Description	Components list																																																								
VL1019A	VIBRATION PUMP		KVL1187A	2021 BIG-L CLEANING SYSTEM KIT	<table border="1"> <thead> <tr> <th>Code</th> <th>Description</th> <th>Qty</th> <th>UOM</th> </tr> </thead> <tbody> <tr> <td>VL1102A1</td> <td>DETERGENT LINE FILTER + BARBED VNR 6 MM</td> <td>1</td> <td>PZ</td> </tr> <tr> <td>VL1127A1</td> <td>6MM BARBED T-SHAPED FITTING</td> <td>2</td> <td>PZ</td> </tr> <tr> <td>VL1128A0</td> <td>BARBED CHECK VALVE D6</td> <td>3</td> <td>PZ</td> </tr> <tr> <td>VL1128A1</td> <td></td> <td>3</td> <td>PZ</td> </tr> <tr> <td>VL1165A0</td> <td>BB6-AR6 STRAIGHT FITTING</td> <td>4</td> <td>PZ</td> </tr> <tr> <td>VL1166A0</td> <td>BB6-AR6 L FITTING</td> <td>4</td> <td>PZ</td> </tr> <tr> <td>VL1167A0</td> <td></td> <td>1</td> <td>PZ</td> </tr> <tr> <td>VL1174C0</td> <td></td> <td>1</td> <td>PZ</td> </tr> <tr> <td>VL1185A0</td> <td>2 WAYS PLUS WASHING DISTRIBUTOR</td> <td>1</td> <td>PZ</td> </tr> <tr> <td>VL1186A0</td> <td></td> <td>1</td> <td>PZ</td> </tr> <tr> <td>VL1190A0</td> <td></td> <td>1</td> <td>PZ</td> </tr> <tr> <td>VM1605A0</td> <td>CLIP TWIST LOCK DIAM. 10,2-12,7 MM</td> <td>3</td> <td>PZ</td> </tr> <tr> <td>VM2172A0</td> <td>PUMP-WITH-CI RCUIT LOCKING PIN</td> <td>9</td> <td>PZ</td> </tr> </tbody> </table>	Code	Description	Qty	UOM	VL1102A1	DETERGENT LINE FILTER + BARBED VNR 6 MM	1	PZ	VL1127A1	6MM BARBED T-SHAPED FITTING	2	PZ	VL1128A0	BARBED CHECK VALVE D6	3	PZ	VL1128A1		3	PZ	VL1165A0	BB6-AR6 STRAIGHT FITTING	4	PZ	VL1166A0	BB6-AR6 L FITTING	4	PZ	VL1167A0		1	PZ	VL1174C0		1	PZ	VL1185A0	2 WAYS PLUS WASHING DISTRIBUTOR	1	PZ	VL1186A0		1	PZ	VL1190A0		1	PZ	VM1605A0	CLIP TWIST LOCK DIAM. 10,2-12,7 MM	3	PZ	VM2172A0	PUMP-WITH-CI RCUIT LOCKING PIN	9	PZ
Code	Description	Qty	UOM																																																										
VL1102A1	DETERGENT LINE FILTER + BARBED VNR 6 MM	1	PZ																																																										
VL1127A1	6MM BARBED T-SHAPED FITTING	2	PZ																																																										
VL1128A0	BARBED CHECK VALVE D6	3	PZ																																																										
VL1128A1		3	PZ																																																										
VL1165A0	BB6-AR6 STRAIGHT FITTING	4	PZ																																																										
VL1166A0	BB6-AR6 L FITTING	4	PZ																																																										
VL1167A0		1	PZ																																																										
VL1174C0		1	PZ																																																										
VL1185A0	2 WAYS PLUS WASHING DISTRIBUTOR	1	PZ																																																										
VL1186A0		1	PZ																																																										
VL1190A0		1	PZ																																																										
VM1605A0	CLIP TWIST LOCK DIAM. 10,2-12,7 MM	3	PZ																																																										
VM2172A0	PUMP-WITH-CI RCUIT LOCKING PIN	9	PZ																																																										
			KVL1184A	2011/16EU BIG-L CLEANING SYSTEM KIT	<table border="1"> <thead> <tr> <th>Code</th> <th>Description</th> <th>Qty</th> <th>UOM</th> </tr> </thead> <tbody> <tr> <td>0H2143A0</td> <td></td> <td>2</td> <td>PZ</td> </tr> <tr> <td>0H2168A0</td> <td></td> <td>1</td> <td>PZ</td> </tr> <tr> <td>0H2354A0</td> <td></td> <td>1</td> <td>PZ</td> </tr> <tr> <td>EL1220A0</td> <td>JG STRAIGHT CONNECTION Ø8F-Ø8F</td> <td>3</td> <td>PZ</td> </tr> <tr> <td>EL1440A0</td> <td>WATER SELF CLEANING VALVE</td> <td>4</td> <td>PZ</td> </tr> <tr> <td>GN1526A0</td> <td>INT. D.=6.9 TH=1.8 O-RIN</td> <td>9</td> <td>PZ</td> </tr> <tr> <td>RC1018A0</td> <td>ZINC PLATED D12 ELASTIC CLAMP</td> <td>2</td> <td>PZ</td> </tr> <tr> <td>RC1019A0</td> <td>D=10 ELASTIC CLAMP</td> <td>21</td> <td>PZ</td> </tr> <tr> <td>RC1130A0</td> <td>130X2,6 CLAM</td> <td>7</td> <td>PZ</td> </tr> <tr> <td>RC1131A0</td> <td></td> <td>3</td> <td>PZ</td> </tr> <tr> <td>RC1242A0</td> <td>D=10 CLOSED CAP</td> <td>2</td> <td>PZ</td> </tr> <tr> <td>RC1356A0</td> <td>STRAIGHT THREADED FEMALE END 8X1/4" BSP</td> <td>1</td> <td>PZ</td> </tr> </tbody> </table>	Code	Description	Qty	UOM	0H2143A0		2	PZ	0H2168A0		1	PZ	0H2354A0		1	PZ	EL1220A0	JG STRAIGHT CONNECTION Ø8F-Ø8F	3	PZ	EL1440A0	WATER SELF CLEANING VALVE	4	PZ	GN1526A0	INT. D.=6.9 TH=1.8 O-RIN	9	PZ	RC1018A0	ZINC PLATED D12 ELASTIC CLAMP	2	PZ	RC1019A0	D=10 ELASTIC CLAMP	21	PZ	RC1130A0	130X2,6 CLAM	7	PZ	RC1131A0		3	PZ	RC1242A0	D=10 CLOSED CAP	2	PZ	RC1356A0	STRAIGHT THREADED FEMALE END 8X1/4" BSP	1	PZ				
Code	Description	Qty	UOM																																																										
0H2143A0		2	PZ																																																										
0H2168A0		1	PZ																																																										
0H2354A0		1	PZ																																																										
EL1220A0	JG STRAIGHT CONNECTION Ø8F-Ø8F	3	PZ																																																										
EL1440A0	WATER SELF CLEANING VALVE	4	PZ																																																										
GN1526A0	INT. D.=6.9 TH=1.8 O-RIN	9	PZ																																																										
RC1018A0	ZINC PLATED D12 ELASTIC CLAMP	2	PZ																																																										
RC1019A0	D=10 ELASTIC CLAMP	21	PZ																																																										
RC1130A0	130X2,6 CLAM	7	PZ																																																										
RC1131A0		3	PZ																																																										
RC1242A0	D=10 CLOSED CAP	2	PZ																																																										
RC1356A0	STRAIGHT THREADED FEMALE END 8X1/4" BSP	1	PZ																																																										

COMPONENT			SPARE PART																																																																																		
Code	Description	Image	Code	Description	Components list																																																																																
VL1019A	VIBRATION PUMP		KVL1184A	2011/16EU BIG-L CLEANING SYSTEM KIT	<table border="1"> <thead> <tr> <th>Code</th> <th>Description</th> <th>Qty</th> <th>UOM</th> </tr> </thead> <tbody> <tr> <td>TB2820A0</td> <td>PIPE EPDM FOR WASHING SYSTEM</td> <td>2.400</td> <td>M</td> </tr> <tr> <td>TB3132A0</td> <td>WHITE-BLUE EPDM TEXTILE BRAID HOSE 6X12</td> <td>1.220</td> <td>M</td> </tr> <tr> <td>VL1019A0</td> <td>VIBRATION PUMP</td> <td>1</td> <td>PZ</td> </tr> <tr> <td>VL1046A1</td> <td>D6 PIPE HOLDER - D6 J.G. TERMINAL</td> <td>3</td> <td>PZ</td> </tr> <tr> <td>VL1047A1</td> <td>D6 PIPE HOLDER - D8 J.G. TERMINAL</td> <td>1</td> <td>PZ</td> </tr> <tr> <td>VL1065A1</td> <td>1/4 MALE N.O. PRESSURE SWITCH</td> <td>1</td> <td>PZ</td> </tr> <tr> <td>VL1067A0</td> <td>WASHING SYSTEM INLETS DISTRIBUTOR</td> <td>1</td> <td>PZ</td> </tr> <tr> <td>VL1092A0</td> <td>WASHING SYSTEM OUTLET DOUBLE DISTRIBUTOR</td> <td>1</td> <td>PZ</td> </tr> <tr> <td>VL1102A1</td> <td>DETERGENT LINE FILTER + BARBED VNR 6 MM</td> <td>1</td> <td>PZ</td> </tr> <tr> <td>VL1128A0</td> <td>BARBED CHECK VALVE D6</td> <td>2</td> <td>PZ</td> </tr> <tr> <td>VL1128A1</td> <td></td> <td>2</td> <td>PZ</td> </tr> <tr> <td>VL1141A1</td> <td></td> <td>1</td> <td>PZ</td> </tr> <tr> <td>VL1165A0</td> <td>BB6-AR6 STRAIGHT FITTING</td> <td>4</td> <td>PZ</td> </tr> <tr> <td>VL1166A0</td> <td>BB6-AR6 L FITTING</td> <td>4</td> <td>PZ</td> </tr> <tr> <td>VL1174C0</td> <td></td> <td>1</td> <td>PZ</td> </tr> <tr> <td>VL1186A0</td> <td></td> <td>1</td> <td>PZ</td> </tr> <tr> <td>VL1190A0</td> <td></td> <td>1</td> <td>PZ</td> </tr> <tr> <td>VM1605A0</td> <td>CLIP TWIST LOCK DIAM. 10,2-12,7 MM</td> <td>4</td> <td>PZ</td> </tr> <tr> <td>VM2172A0</td> <td>PUMP-WITH-CI RCUIT LOCKING PIN</td> <td>9</td> <td>PZ</td> </tr> </tbody> </table>	Code	Description	Qty	UOM	TB2820A0	PIPE EPDM FOR WASHING SYSTEM	2.400	M	TB3132A0	WHITE-BLUE EPDM TEXTILE BRAID HOSE 6X12	1.220	M	VL1019A0	VIBRATION PUMP	1	PZ	VL1046A1	D6 PIPE HOLDER - D6 J.G. TERMINAL	3	PZ	VL1047A1	D6 PIPE HOLDER - D8 J.G. TERMINAL	1	PZ	VL1065A1	1/4 MALE N.O. PRESSURE SWITCH	1	PZ	VL1067A0	WASHING SYSTEM INLETS DISTRIBUTOR	1	PZ	VL1092A0	WASHING SYSTEM OUTLET DOUBLE DISTRIBUTOR	1	PZ	VL1102A1	DETERGENT LINE FILTER + BARBED VNR 6 MM	1	PZ	VL1128A0	BARBED CHECK VALVE D6	2	PZ	VL1128A1		2	PZ	VL1141A1		1	PZ	VL1165A0	BB6-AR6 STRAIGHT FITTING	4	PZ	VL1166A0	BB6-AR6 L FITTING	4	PZ	VL1174C0		1	PZ	VL1186A0		1	PZ	VL1190A0		1	PZ	VM1605A0	CLIP TWIST LOCK DIAM. 10,2-12,7 MM	4	PZ	VM2172A0	PUMP-WITH-CI RCUIT LOCKING PIN	9	PZ
Code	Description	Qty	UOM																																																																																		
TB2820A0	PIPE EPDM FOR WASHING SYSTEM	2.400	M																																																																																		
TB3132A0	WHITE-BLUE EPDM TEXTILE BRAID HOSE 6X12	1.220	M																																																																																		
VL1019A0	VIBRATION PUMP	1	PZ																																																																																		
VL1046A1	D6 PIPE HOLDER - D6 J.G. TERMINAL	3	PZ																																																																																		
VL1047A1	D6 PIPE HOLDER - D8 J.G. TERMINAL	1	PZ																																																																																		
VL1065A1	1/4 MALE N.O. PRESSURE SWITCH	1	PZ																																																																																		
VL1067A0	WASHING SYSTEM INLETS DISTRIBUTOR	1	PZ																																																																																		
VL1092A0	WASHING SYSTEM OUTLET DOUBLE DISTRIBUTOR	1	PZ																																																																																		
VL1102A1	DETERGENT LINE FILTER + BARBED VNR 6 MM	1	PZ																																																																																		
VL1128A0	BARBED CHECK VALVE D6	2	PZ																																																																																		
VL1128A1		2	PZ																																																																																		
VL1141A1		1	PZ																																																																																		
VL1165A0	BB6-AR6 STRAIGHT FITTING	4	PZ																																																																																		
VL1166A0	BB6-AR6 L FITTING	4	PZ																																																																																		
VL1174C0		1	PZ																																																																																		
VL1186A0		1	PZ																																																																																		
VL1190A0		1	PZ																																																																																		
VM1605A0	CLIP TWIST LOCK DIAM. 10,2-12,7 MM	4	PZ																																																																																		
VM2172A0	PUMP-WITH-CI RCUIT LOCKING PIN	9	PZ																																																																																		

COMPONENT			SPARE PART																																																																																																		
Code	Description	Image	Code	Description	Components list																																																																																																
VL1019A	VIBRATION PUMP		KVL1183A	1 ROTOR ARM PLUS CLEANING SYSTEM KIT	<table border="1"> <thead> <tr> <th>Code</th> <th>Description</th> <th>Qty</th> <th>UOM</th> </tr> </thead> <tbody> <tr> <td>0H2143A0</td> <td></td> <td>2</td> <td>PZ</td> </tr> <tr> <td>0H2168A1</td> <td></td> <td>1</td> <td>PZ</td> </tr> <tr> <td>0H2354A0</td> <td></td> <td>1</td> <td>PZ</td> </tr> <tr> <td>EL1440A0</td> <td>WATER SELF CLEANING VALVE</td> <td>3</td> <td>PZ</td> </tr> <tr> <td>GN1526A0</td> <td>INT. D.=6.9 TH=1.8 O-RIN</td> <td>7</td> <td>PZ</td> </tr> <tr> <td>RC1018A0</td> <td>ZINC PLATED D12 ELASTIC CLAMP</td> <td>2</td> <td>PZ</td> </tr> <tr> <td>RC1019A0</td> <td>D=10 ELASTIC CLAMP</td> <td>14</td> <td>PZ</td> </tr> <tr> <td>RC1130A0</td> <td>130X2,6 CLAM</td> <td>5</td> <td>PZ</td> </tr> <tr> <td>RC1131A0</td> <td></td> <td>2</td> <td>PZ</td> </tr> <tr> <td>RC1242A0</td> <td>D=10 CLOSED CAP</td> <td>2</td> <td>PZ</td> </tr> <tr> <td>RC1356A0</td> <td>STRAIGHT THREADED FEMALE END 8X1/4" BSP</td> <td>1</td> <td>PZ</td> </tr> <tr> <td>TB2820A0</td> <td>PIPE EPDM FOR WASHING SYSTEM</td> <td>1.410</td> <td>M</td> </tr> <tr> <td>TB3132A0</td> <td>WHITE-BLUE EPDM TEXTILE BRAID HOSE 6X12</td> <td>0.770</td> <td>M</td> </tr> <tr> <td>VH1220A1</td> <td>4,2X12 TCB SELF-TAPPIN G SCREW</td> <td>3</td> <td>PZ</td> </tr> <tr> <td>VL1019A0</td> <td>VIBRATION PUMP</td> <td>1</td> <td>PZ</td> </tr> <tr> <td>VL1047A1</td> <td>D6 PIPE HOLDER - D8 J.G. TERMINAL</td> <td>1</td> <td>PZ</td> </tr> <tr> <td>VL1065A1</td> <td>1/4 MALE N.O. PRESSURE SWITCH</td> <td>1</td> <td>PZ</td> </tr> <tr> <td>VL1102A1</td> <td>DETERGENT LINE FILTER + BARBED VNR 6 MM</td> <td>1</td> <td>PZ</td> </tr> <tr> <td>VL1128A0</td> <td>BARBED CHECK VALVE D6</td> <td>2</td> <td>PZ</td> </tr> <tr> <td>VL1128A1</td> <td></td> <td>2</td> <td>PZ</td> </tr> <tr> <td>VL1165A0</td> <td>BB6-AR6 STRAIGHT FITTING</td> <td>1</td> <td>PZ</td> </tr> <tr> <td>VL1166A0</td> <td>BB6-AR6 L FITTING</td> <td>3</td> <td>PZ</td> </tr> <tr> <td>VL1174C0</td> <td></td> <td>1</td> <td>PZ</td> </tr> </tbody> </table>	Code	Description	Qty	UOM	0H2143A0		2	PZ	0H2168A1		1	PZ	0H2354A0		1	PZ	EL1440A0	WATER SELF CLEANING VALVE	3	PZ	GN1526A0	INT. D.=6.9 TH=1.8 O-RIN	7	PZ	RC1018A0	ZINC PLATED D12 ELASTIC CLAMP	2	PZ	RC1019A0	D=10 ELASTIC CLAMP	14	PZ	RC1130A0	130X2,6 CLAM	5	PZ	RC1131A0		2	PZ	RC1242A0	D=10 CLOSED CAP	2	PZ	RC1356A0	STRAIGHT THREADED FEMALE END 8X1/4" BSP	1	PZ	TB2820A0	PIPE EPDM FOR WASHING SYSTEM	1.410	M	TB3132A0	WHITE-BLUE EPDM TEXTILE BRAID HOSE 6X12	0.770	M	VH1220A1	4,2X12 TCB SELF-TAPPIN G SCREW	3	PZ	VL1019A0	VIBRATION PUMP	1	PZ	VL1047A1	D6 PIPE HOLDER - D8 J.G. TERMINAL	1	PZ	VL1065A1	1/4 MALE N.O. PRESSURE SWITCH	1	PZ	VL1102A1	DETERGENT LINE FILTER + BARBED VNR 6 MM	1	PZ	VL1128A0	BARBED CHECK VALVE D6	2	PZ	VL1128A1		2	PZ	VL1165A0	BB6-AR6 STRAIGHT FITTING	1	PZ	VL1166A0	BB6-AR6 L FITTING	3	PZ	VL1174C0		1	PZ
Code	Description	Qty	UOM																																																																																																		
0H2143A0		2	PZ																																																																																																		
0H2168A1		1	PZ																																																																																																		
0H2354A0		1	PZ																																																																																																		
EL1440A0	WATER SELF CLEANING VALVE	3	PZ																																																																																																		
GN1526A0	INT. D.=6.9 TH=1.8 O-RIN	7	PZ																																																																																																		
RC1018A0	ZINC PLATED D12 ELASTIC CLAMP	2	PZ																																																																																																		
RC1019A0	D=10 ELASTIC CLAMP	14	PZ																																																																																																		
RC1130A0	130X2,6 CLAM	5	PZ																																																																																																		
RC1131A0		2	PZ																																																																																																		
RC1242A0	D=10 CLOSED CAP	2	PZ																																																																																																		
RC1356A0	STRAIGHT THREADED FEMALE END 8X1/4" BSP	1	PZ																																																																																																		
TB2820A0	PIPE EPDM FOR WASHING SYSTEM	1.410	M																																																																																																		
TB3132A0	WHITE-BLUE EPDM TEXTILE BRAID HOSE 6X12	0.770	M																																																																																																		
VH1220A1	4,2X12 TCB SELF-TAPPIN G SCREW	3	PZ																																																																																																		
VL1019A0	VIBRATION PUMP	1	PZ																																																																																																		
VL1047A1	D6 PIPE HOLDER - D8 J.G. TERMINAL	1	PZ																																																																																																		
VL1065A1	1/4 MALE N.O. PRESSURE SWITCH	1	PZ																																																																																																		
VL1102A1	DETERGENT LINE FILTER + BARBED VNR 6 MM	1	PZ																																																																																																		
VL1128A0	BARBED CHECK VALVE D6	2	PZ																																																																																																		
VL1128A1		2	PZ																																																																																																		
VL1165A0	BB6-AR6 STRAIGHT FITTING	1	PZ																																																																																																		
VL1166A0	BB6-AR6 L FITTING	3	PZ																																																																																																		
VL1174C0		1	PZ																																																																																																		

COMPONENT			SPARE PART																																																																							
Code	Description	Image	Code	Description	Components list																																																																					
VL1019A	VIBRATION PUMP		KVL1183A	1 ROTOR ARM PLUS CLEANING SYSTEM KIT	<table border="1"> <thead> <tr> <th>Code</th> <th>Description</th> <th>Qty</th> <th>UOM</th> </tr> </thead> <tbody> <tr> <td>VL1185A0</td> <td>2 WAYS PLUS WASHING DISTRIBUTOR</td> <td>1</td> <td>PZ</td> </tr> <tr> <td>VL1190A0</td> <td></td> <td>1</td> <td>PZ</td> </tr> <tr> <td>VM1605A0</td> <td>CLIP TWIST LOCK DIAM. 10,2-12,7 MM</td> <td>3</td> <td>PZ</td> </tr> <tr> <td>VM2172A0</td> <td>PUMP-WITH-CI RCUIT LOCKING PIN</td> <td>7</td> <td>PZ</td> </tr> </tbody> </table>	Code	Description	Qty	UOM	VL1185A0	2 WAYS PLUS WASHING DISTRIBUTOR	1	PZ	VL1190A0		1	PZ	VM1605A0	CLIP TWIST LOCK DIAM. 10,2-12,7 MM	3	PZ	VM2172A0	PUMP-WITH-CI RCUIT LOCKING PIN	7	PZ																																																	
			Code	Description	Qty	UOM																																																																				
VL1185A0	2 WAYS PLUS WASHING DISTRIBUTOR	1	PZ																																																																							
VL1190A0		1	PZ																																																																							
VM1605A0	CLIP TWIST LOCK DIAM. 10,2-12,7 MM	3	PZ																																																																							
VM2172A0	PUMP-WITH-CI RCUIT LOCKING PIN	7	PZ																																																																							
KVL1182A	ONE CLEANING SYSTEM KIT	<table border="1"> <thead> <tr> <th>Code</th> <th>Description</th> <th>Qty</th> <th>UOM</th> </tr> </thead> <tbody> <tr> <td>0H2143A0</td> <td></td> <td>2</td> <td>PZ</td> </tr> <tr> <td>0H2202A1</td> <td></td> <td>1</td> <td>PZ</td> </tr> <tr> <td>EL1440A0</td> <td>WATER SELF CLEANING VALVE</td> <td>1</td> <td>PZ</td> </tr> <tr> <td>GN1526A0</td> <td>INT. D.=6.9 TH=1.8 O-RIN</td> <td>3</td> <td>PZ</td> </tr> <tr> <td>RC1018A0</td> <td>ZINC PLATED D12 ELASTIC CLAMP</td> <td>1</td> <td>PZ</td> </tr> <tr> <td>RC1019A0</td> <td>D=10 ELASTIC CLAMP</td> <td>14</td> <td>PZ</td> </tr> <tr> <td>RC1130A0</td> <td>130X2,6 CLAM</td> <td>2</td> <td>PZ</td> </tr> <tr> <td>RC1242A0</td> <td>D=10 CLOSED CAP</td> <td>2</td> <td>PZ</td> </tr> <tr> <td>TB2820A0</td> <td>PIPE EPDM FOR WASHING SYSTEM</td> <td>1.410</td> <td>M</td> </tr> <tr> <td>TB3132A0</td> <td>WHITE-BLUE EPDM TEXTILE BRAID HOSE 6X12</td> <td>0.670</td> <td>M</td> </tr> <tr> <td>VI1220A1</td> <td>4,2X12 TCB SELF-TAPPIN G SCREW</td> <td>1</td> <td>PZ</td> </tr> <tr> <td>VL1019A0</td> <td>VIBRATION PUMP</td> <td>1</td> <td>PZ</td> </tr> <tr> <td>VL1047A1</td> <td>D6 PIPE HOLDER - D8 J.G. TERMINAL</td> <td>1</td> <td>PZ</td> </tr> <tr> <td>VL1054B0</td> <td>ONE WASHING SYS INLET DISTRIBUTOR</td> <td>1</td> <td>PZ</td> </tr> <tr> <td>VL1102A1</td> <td>DETERGENT LINE FILTER + BARBED VNR 6 MM</td> <td>1</td> <td>PZ</td> </tr> <tr> <td>VL1128A0</td> <td>BARBED CHECK VALVE D6</td> <td>2</td> <td>PZ</td> </tr> <tr> <td>VL1128A1</td> <td></td> <td>2</td> <td>PZ</td> </tr> </tbody> </table>	Code	Description	Qty	UOM	0H2143A0		2	PZ	0H2202A1		1	PZ	EL1440A0	WATER SELF CLEANING VALVE	1	PZ	GN1526A0	INT. D.=6.9 TH=1.8 O-RIN	3	PZ	RC1018A0	ZINC PLATED D12 ELASTIC CLAMP	1	PZ	RC1019A0	D=10 ELASTIC CLAMP	14	PZ	RC1130A0	130X2,6 CLAM	2	PZ	RC1242A0	D=10 CLOSED CAP	2	PZ	TB2820A0	PIPE EPDM FOR WASHING SYSTEM	1.410	M	TB3132A0	WHITE-BLUE EPDM TEXTILE BRAID HOSE 6X12	0.670	M	VI1220A1	4,2X12 TCB SELF-TAPPIN G SCREW	1	PZ	VL1019A0	VIBRATION PUMP	1	PZ	VL1047A1	D6 PIPE HOLDER - D8 J.G. TERMINAL	1	PZ	VL1054B0	ONE WASHING SYS INLET DISTRIBUTOR	1	PZ	VL1102A1	DETERGENT LINE FILTER + BARBED VNR 6 MM	1	PZ	VL1128A0	BARBED CHECK VALVE D6	2	PZ	VL1128A1		2	PZ
Code	Description	Qty	UOM																																																																							
0H2143A0		2	PZ																																																																							
0H2202A1		1	PZ																																																																							
EL1440A0	WATER SELF CLEANING VALVE	1	PZ																																																																							
GN1526A0	INT. D.=6.9 TH=1.8 O-RIN	3	PZ																																																																							
RC1018A0	ZINC PLATED D12 ELASTIC CLAMP	1	PZ																																																																							
RC1019A0	D=10 ELASTIC CLAMP	14	PZ																																																																							
RC1130A0	130X2,6 CLAM	2	PZ																																																																							
RC1242A0	D=10 CLOSED CAP	2	PZ																																																																							
TB2820A0	PIPE EPDM FOR WASHING SYSTEM	1.410	M																																																																							
TB3132A0	WHITE-BLUE EPDM TEXTILE BRAID HOSE 6X12	0.670	M																																																																							
VI1220A1	4,2X12 TCB SELF-TAPPIN G SCREW	1	PZ																																																																							
VL1019A0	VIBRATION PUMP	1	PZ																																																																							
VL1047A1	D6 PIPE HOLDER - D8 J.G. TERMINAL	1	PZ																																																																							
VL1054B0	ONE WASHING SYS INLET DISTRIBUTOR	1	PZ																																																																							
VL1102A1	DETERGENT LINE FILTER + BARBED VNR 6 MM	1	PZ																																																																							
VL1128A0	BARBED CHECK VALVE D6	2	PZ																																																																							
VL1128A1		2	PZ																																																																							

COMPONENT			SPARE PART																																																										
Code	Description	Image	Code	Description	Components list																																																								
VL1019A	VIBRATION PUMP		KVL1182A	ONE CLEANING SYSTEM KIT	<table border="1"> <thead> <tr> <th>Code</th> <th>Description</th> <th>Qty</th> <th>UOM</th> </tr> </thead> <tbody> <tr> <td>VL1165A0</td> <td>BB6-AR6 STRAIGHT FITTING</td> <td>1</td> <td>PZ</td> </tr> <tr> <td>VL1166A0</td> <td>BB6-AR6 L FITTING</td> <td>1</td> <td>PZ</td> </tr> <tr> <td>VL1174C0</td> <td></td> <td>1</td> <td>PZ</td> </tr> <tr> <td>VL1191A0</td> <td>ONE WASHING DISTRIBUTOR OUTLETS KIT</td> <td>1</td> <td>PZ</td> </tr> <tr> <td>VM1605A0</td> <td>CLIP TWIST LOCK DIAM. 10,2-12,7 MM</td> <td>3</td> <td>PZ</td> </tr> <tr> <td>VM2172A0</td> <td>PUMP-WITH-CI RCUIT LOCKING PIN</td> <td>2</td> <td>PZ</td> </tr> </tbody> </table>	Code	Description	Qty	UOM	VL1165A0	BB6-AR6 STRAIGHT FITTING	1	PZ	VL1166A0	BB6-AR6 L FITTING	1	PZ	VL1174C0		1	PZ	VL1191A0	ONE WASHING DISTRIBUTOR OUTLETS KIT	1	PZ	VM1605A0	CLIP TWIST LOCK DIAM. 10,2-12,7 MM	3	PZ	VM2172A0	PUMP-WITH-CI RCUIT LOCKING PIN	2	PZ																												
Code	Description	Qty	UOM																																																										
VL1165A0	BB6-AR6 STRAIGHT FITTING	1	PZ																																																										
VL1166A0	BB6-AR6 L FITTING	1	PZ																																																										
VL1174C0		1	PZ																																																										
VL1191A0	ONE WASHING DISTRIBUTOR OUTLETS KIT	1	PZ																																																										
VM1605A0	CLIP TWIST LOCK DIAM. 10,2-12,7 MM	3	PZ																																																										
VM2172A0	PUMP-WITH-CI RCUIT LOCKING PIN	2	PZ																																																										
			KVL1122A	USA HOOD CLEANING SYSTEM KIT	<table border="1"> <thead> <tr> <th>Code</th> <th>Description</th> <th>Qty</th> <th>UOM</th> </tr> </thead> <tbody> <tr> <td>0H7368A0</td> <td>S6 HOOD WATER SYSTEM PLAT</td> <td>1</td> <td>PZ</td> </tr> <tr> <td>EL1426B0</td> <td>UL JG D8 WATER SLENOID VALVE-PIPE HOLDER</td> <td>1</td> <td>PZ</td> </tr> <tr> <td>EL1437B0</td> <td>JG D8 WATER SOLENOID VALVE -BARBED D6 V</td> <td>1</td> <td>PZ</td> </tr> <tr> <td>GN1526A0</td> <td>INT. D.=6.9 TH=1.8 O-RIN</td> <td>1</td> <td>PZ</td> </tr> <tr> <td>RC1018A0</td> <td>ZINC PLATED D12 ELASTIC CLAMP</td> <td>2</td> <td>PZ</td> </tr> <tr> <td>RC1019A0</td> <td>D=10 ELASTIC CLAMP</td> <td>12</td> <td>PZ</td> </tr> <tr> <td>RC1242A0</td> <td>D=10 CLOSED CAP</td> <td>2</td> <td>PZ</td> </tr> <tr> <td>RC1408A0</td> <td>DOUBLE WIRE SPRING CLAMP D10.8 ZN</td> <td>2</td> <td>PZ</td> </tr> <tr> <td>RC1414A0</td> <td></td> <td>2</td> <td>PZ</td> </tr> <tr> <td>TB2820A0</td> <td>PIPE EPDM FOR WASHING SYSTEM</td> <td>2.200</td> <td>M</td> </tr> <tr> <td>TB3132A0</td> <td>WHITE-BLUE EPDM TEXTILE BRAID HOSE 6X12</td> <td>0.540</td> <td>M</td> </tr> <tr> <td>VI1220A1</td> <td>4,2X12 TCB SELF-TAPPIN G SCREW</td> <td>5</td> <td>PZ</td> </tr> <tr> <td>VL1019A0</td> <td>VIBRATION PUMP</td> <td>1</td> <td>PZ</td> </tr> </tbody> </table>	Code	Description	Qty	UOM	0H7368A0	S6 HOOD WATER SYSTEM PLAT	1	PZ	EL1426B0	UL JG D8 WATER SLENOID VALVE-PIPE HOLDER	1	PZ	EL1437B0	JG D8 WATER SOLENOID VALVE -BARBED D6 V	1	PZ	GN1526A0	INT. D.=6.9 TH=1.8 O-RIN	1	PZ	RC1018A0	ZINC PLATED D12 ELASTIC CLAMP	2	PZ	RC1019A0	D=10 ELASTIC CLAMP	12	PZ	RC1242A0	D=10 CLOSED CAP	2	PZ	RC1408A0	DOUBLE WIRE SPRING CLAMP D10.8 ZN	2	PZ	RC1414A0		2	PZ	TB2820A0	PIPE EPDM FOR WASHING SYSTEM	2.200	M	TB3132A0	WHITE-BLUE EPDM TEXTILE BRAID HOSE 6X12	0.540	M	VI1220A1	4,2X12 TCB SELF-TAPPIN G SCREW	5	PZ	VL1019A0	VIBRATION PUMP	1	PZ
Code	Description	Qty	UOM																																																										
0H7368A0	S6 HOOD WATER SYSTEM PLAT	1	PZ																																																										
EL1426B0	UL JG D8 WATER SLENOID VALVE-PIPE HOLDER	1	PZ																																																										
EL1437B0	JG D8 WATER SOLENOID VALVE -BARBED D6 V	1	PZ																																																										
GN1526A0	INT. D.=6.9 TH=1.8 O-RIN	1	PZ																																																										
RC1018A0	ZINC PLATED D12 ELASTIC CLAMP	2	PZ																																																										
RC1019A0	D=10 ELASTIC CLAMP	12	PZ																																																										
RC1242A0	D=10 CLOSED CAP	2	PZ																																																										
RC1408A0	DOUBLE WIRE SPRING CLAMP D10.8 ZN	2	PZ																																																										
RC1414A0		2	PZ																																																										
TB2820A0	PIPE EPDM FOR WASHING SYSTEM	2.200	M																																																										
TB3132A0	WHITE-BLUE EPDM TEXTILE BRAID HOSE 6X12	0.540	M																																																										
VI1220A1	4,2X12 TCB SELF-TAPPIN G SCREW	5	PZ																																																										
VL1019A0	VIBRATION PUMP	1	PZ																																																										

COMPONENT			SPARE PART																																														
Code	Description	Image	Code	Description	Components list																																												
VL1019A	VIBRATION PUMP		KVL1122A	USA HOOD CLEANING SYSTEM KIT	<table border="1"> <thead> <tr> <th>Code</th> <th>Description</th> <th>Qty</th> <th>UOM</th> </tr> </thead> <tbody> <tr> <td>VL1047A1</td> <td>D6 PIPE HOLDER - D8 J.G. TERMINAL</td> <td>2</td> <td>PZ</td> </tr> <tr> <td>VL1053B0</td> <td>ONE WASHING SYS EXT DISTRIBUTOR</td> <td>1</td> <td>PZ</td> </tr> <tr> <td>VL1054B0</td> <td>ONE WASHING SYS INLET DISTRIBUTOR</td> <td>1</td> <td>PZ</td> </tr> <tr> <td>VL1081A0</td> <td>D6 BARBED NO RETURN VALVE</td> <td>1</td> <td>PZ</td> </tr> <tr> <td>VL1102A1</td> <td>DETERGENT LINE FILTER + BARBED VNR 6 MM</td> <td>1</td> <td>PZ</td> </tr> <tr> <td>VL1127A1</td> <td>6MM BARBED T-SHAPED FITTING</td> <td>1</td> <td>PZ</td> </tr> <tr> <td>VL1128A0</td> <td>BARBED CHECK VALVE D6</td> <td>1</td> <td>PZ</td> </tr> <tr> <td>VL1128A1</td> <td></td> <td>1</td> <td>PZ</td> </tr> <tr> <td>VM1605A0</td> <td>CLIP TWIST LOCK DIAM. 10,2-12,7 MM</td> <td>2</td> <td>PZ</td> </tr> <tr> <td>VM2172A0</td> <td>PUMP-WITH-CI RCUIT LOCKING PIN</td> <td>1</td> <td>PZ</td> </tr> </tbody> </table>	Code	Description	Qty	UOM	VL1047A1	D6 PIPE HOLDER - D8 J.G. TERMINAL	2	PZ	VL1053B0	ONE WASHING SYS EXT DISTRIBUTOR	1	PZ	VL1054B0	ONE WASHING SYS INLET DISTRIBUTOR	1	PZ	VL1081A0	D6 BARBED NO RETURN VALVE	1	PZ	VL1102A1	DETERGENT LINE FILTER + BARBED VNR 6 MM	1	PZ	VL1127A1	6MM BARBED T-SHAPED FITTING	1	PZ	VL1128A0	BARBED CHECK VALVE D6	1	PZ	VL1128A1		1	PZ	VM1605A0	CLIP TWIST LOCK DIAM. 10,2-12,7 MM	2	PZ	VM2172A0	PUMP-WITH-CI RCUIT LOCKING PIN	1	PZ
Code	Description	Qty	UOM																																														
VL1047A1	D6 PIPE HOLDER - D8 J.G. TERMINAL	2	PZ																																														
VL1053B0	ONE WASHING SYS EXT DISTRIBUTOR	1	PZ																																														
VL1054B0	ONE WASHING SYS INLET DISTRIBUTOR	1	PZ																																														
VL1081A0	D6 BARBED NO RETURN VALVE	1	PZ																																														
VL1102A1	DETERGENT LINE FILTER + BARBED VNR 6 MM	1	PZ																																														
VL1127A1	6MM BARBED T-SHAPED FITTING	1	PZ																																														
VL1128A0	BARBED CHECK VALVE D6	1	PZ																																														
VL1128A1		1	PZ																																														
VM1605A0	CLIP TWIST LOCK DIAM. 10,2-12,7 MM	2	PZ																																														
VM2172A0	PUMP-WITH-CI RCUIT LOCKING PIN	1	PZ																																														
			KVL1121A	EUR MIND.MAPS HOOD CLEANING SYSTEM KIT	<table border="1"> <thead> <tr> <th>Code</th> <th>Description</th> <th>Qty</th> <th>UOM</th> </tr> </thead> <tbody> <tr> <td>0H2143A0</td> <td></td> <td>1</td> <td>PZ</td> </tr> <tr> <td>0H7368A0</td> <td>S6 HOOD WATER SYSTEM PLAT</td> <td>1</td> <td>PZ</td> </tr> <tr> <td>EL1424A0</td> <td>D8 CONNECTION WATER SOLENOID VALVE</td> <td>1</td> <td>PZ</td> </tr> <tr> <td>EL1424B0</td> <td></td> <td>1</td> <td>PZ</td> </tr> <tr> <td>EL1436A0</td> <td>H2O SOLENOID JG D8 CHECK VALVE</td> <td>1</td> <td>PZ</td> </tr> <tr> <td>EL1436B0</td> <td></td> <td>1</td> <td>PZ</td> </tr> <tr> <td>GN1526A0</td> <td>INT. D.=6.9 TH=1.8 O-RIN</td> <td>1</td> <td>PZ</td> </tr> <tr> <td>RC1019A0</td> <td>D=10 ELASTIC CLAMP</td> <td>12</td> <td>PZ</td> </tr> <tr> <td>RC1242A0</td> <td>D=10 CLOSED CAP</td> <td>2</td> <td>PZ</td> </tr> </tbody> </table>	Code	Description	Qty	UOM	0H2143A0		1	PZ	0H7368A0	S6 HOOD WATER SYSTEM PLAT	1	PZ	EL1424A0	D8 CONNECTION WATER SOLENOID VALVE	1	PZ	EL1424B0		1	PZ	EL1436A0	H2O SOLENOID JG D8 CHECK VALVE	1	PZ	EL1436B0		1	PZ	GN1526A0	INT. D.=6.9 TH=1.8 O-RIN	1	PZ	RC1019A0	D=10 ELASTIC CLAMP	12	PZ	RC1242A0	D=10 CLOSED CAP	2	PZ				
Code	Description	Qty	UOM																																														
0H2143A0		1	PZ																																														
0H7368A0	S6 HOOD WATER SYSTEM PLAT	1	PZ																																														
EL1424A0	D8 CONNECTION WATER SOLENOID VALVE	1	PZ																																														
EL1424B0		1	PZ																																														
EL1436A0	H2O SOLENOID JG D8 CHECK VALVE	1	PZ																																														
EL1436B0		1	PZ																																														
GN1526A0	INT. D.=6.9 TH=1.8 O-RIN	1	PZ																																														
RC1019A0	D=10 ELASTIC CLAMP	12	PZ																																														
RC1242A0	D=10 CLOSED CAP	2	PZ																																														

COMPONENT			SPARE PART																																														
Code	Description	Image	Code	Description	Components list																																												
VL1019A	VIBRATION PUMP		KVL1121A	EUR MIND.MAPS HOOD CLEANING SYSTEM KIT	<table border="1"> <thead> <tr> <th>Code</th> <th>Description</th> <th>Qty</th> <th>UOM</th> </tr> </thead> <tbody> <tr> <td>RC1408A0</td> <td>DOUBLE WIRE SPRING CLAMP D10.8 ZN</td> <td>2</td> <td>PZ</td> </tr> <tr> <td>TB2820A0</td> <td>PIPE EPDM FOR WASHING SYSTEM</td> <td>2.200</td> <td>M</td> </tr> <tr> <td>V11220A1</td> <td>4,2X12 TCB SELF-TAPPING SCREW</td> <td>5</td> <td>PZ</td> </tr> <tr> <td>VL1019A0</td> <td>VIBRATION PUMP</td> <td>1</td> <td>PZ</td> </tr> <tr> <td>VL1053B0</td> <td>ONE WASHING SYSTEM DISTRIBUTOR</td> <td>1</td> <td>PZ</td> </tr> <tr> <td>VL1054B0</td> <td>ONE WASHING SYSTEM INLET DISTRIBUTOR</td> <td>1</td> <td>PZ</td> </tr> <tr> <td>VL1102A1</td> <td>DETERGENT LINE FILTER + BARBED VNR 6 MM</td> <td>1</td> <td>PZ</td> </tr> <tr> <td>VL1128A0</td> <td>BARBED CHECK VALVE D6</td> <td>1</td> <td>PZ</td> </tr> <tr> <td>VL1128A1</td> <td></td> <td>1</td> <td>PZ</td> </tr> <tr> <td>VM2172A0</td> <td>PUMP-WITH-CIRCUIT LOCKING PIN</td> <td>1</td> <td>PZ</td> </tr> </tbody> </table>	Code	Description	Qty	UOM	RC1408A0	DOUBLE WIRE SPRING CLAMP D10.8 ZN	2	PZ	TB2820A0	PIPE EPDM FOR WASHING SYSTEM	2.200	M	V11220A1	4,2X12 TCB SELF-TAPPING SCREW	5	PZ	VL1019A0	VIBRATION PUMP	1	PZ	VL1053B0	ONE WASHING SYSTEM DISTRIBUTOR	1	PZ	VL1054B0	ONE WASHING SYSTEM INLET DISTRIBUTOR	1	PZ	VL1102A1	DETERGENT LINE FILTER + BARBED VNR 6 MM	1	PZ	VL1128A0	BARBED CHECK VALVE D6	1	PZ	VL1128A1		1	PZ	VM2172A0	PUMP-WITH-CIRCUIT LOCKING PIN	1	PZ
Code	Description	Qty	UOM																																														
RC1408A0	DOUBLE WIRE SPRING CLAMP D10.8 ZN	2	PZ																																														
TB2820A0	PIPE EPDM FOR WASHING SYSTEM	2.200	M																																														
V11220A1	4,2X12 TCB SELF-TAPPING SCREW	5	PZ																																														
VL1019A0	VIBRATION PUMP	1	PZ																																														
VL1053B0	ONE WASHING SYSTEM DISTRIBUTOR	1	PZ																																														
VL1054B0	ONE WASHING SYSTEM INLET DISTRIBUTOR	1	PZ																																														
VL1102A1	DETERGENT LINE FILTER + BARBED VNR 6 MM	1	PZ																																														
VL1128A0	BARBED CHECK VALVE D6	1	PZ																																														
VL1128A1		1	PZ																																														
VM2172A0	PUMP-WITH-CIRCUIT LOCKING PIN	1	PZ																																														
			KVL1120A	USA COMPACT PLUS CLEANING SYSTEM KIT	<table border="1"> <thead> <tr> <th>Code</th> <th>Description</th> <th>Qty</th> <th>UOM</th> </tr> </thead> <tbody> <tr> <td>0H2143A0</td> <td></td> <td>1</td> <td>PZ</td> </tr> <tr> <td>0H7553D0</td> <td>XECC PLUS WASHING SYSTEM PLAT</td> <td>1</td> <td>PZ</td> </tr> <tr> <td>EL1422A1</td> <td>1 WAY SOLENOID VALVE + D8-D10 REDUCTION</td> <td>1</td> <td>PZ</td> </tr> <tr> <td>EL1426A0</td> <td>H2O UL SOLENOID JG D8-PIPE HOLDER</td> <td>1</td> <td>PZ</td> </tr> <tr> <td>EL1426B0</td> <td>UL JG D8 WATER SLENOID VALVE-PIPE HOLDER</td> <td>1</td> <td>PZ</td> </tr> <tr> <td>EL1437A0</td> <td>H2O SOLENOID JG D6 UL CHECK VALVE</td> <td>1</td> <td>PZ</td> </tr> </tbody> </table>	Code	Description	Qty	UOM	0H2143A0		1	PZ	0H7553D0	XECC PLUS WASHING SYSTEM PLAT	1	PZ	EL1422A1	1 WAY SOLENOID VALVE + D8-D10 REDUCTION	1	PZ	EL1426A0	H2O UL SOLENOID JG D8-PIPE HOLDER	1	PZ	EL1426B0	UL JG D8 WATER SLENOID VALVE-PIPE HOLDER	1	PZ	EL1437A0	H2O SOLENOID JG D6 UL CHECK VALVE	1	PZ																
Code	Description	Qty	UOM																																														
0H2143A0		1	PZ																																														
0H7553D0	XECC PLUS WASHING SYSTEM PLAT	1	PZ																																														
EL1422A1	1 WAY SOLENOID VALVE + D8-D10 REDUCTION	1	PZ																																														
EL1426A0	H2O UL SOLENOID JG D8-PIPE HOLDER	1	PZ																																														
EL1426B0	UL JG D8 WATER SLENOID VALVE-PIPE HOLDER	1	PZ																																														
EL1437A0	H2O SOLENOID JG D6 UL CHECK VALVE	1	PZ																																														

COMPONENT			SPARE PART																																																																						
Code	Description	Image	Code	Description	Components list																																																																				
VL1019A	VIBRATION PUMP		KVL1120A	USA COMPACT PLUS CLEANING SYSTEM KIT	<table border="1"> <thead> <tr> <th>Code</th> <th>Description</th> <th>Qty</th> <th>UOM</th> </tr> </thead> <tbody> <tr> <td>EL1437B0</td> <td>JG D8 WATER SOLENOID VALVE -BARBED D6 V</td> <td>1</td> <td>PZ</td> </tr> <tr> <td>GN1312A0</td> <td>RUBBER CABLE-PASSI NG DE=26 DI=15 SP=10</td> <td>1</td> <td>PZ</td> </tr> <tr> <td>GN1526A0</td> <td>INT. D.=6.9 TH=1.8 O-RIN</td> <td>1</td> <td>PZ</td> </tr> <tr> <td>RC1019A0</td> <td>D=10 ELASTIC CLAMP</td> <td>10</td> <td>PZ</td> </tr> <tr> <td>RC1242A0</td> <td>D=10 CLOSED CAP</td> <td>2</td> <td>PZ</td> </tr> <tr> <td>RC1356A0</td> <td>STRAIGHT THREADED FEMALE END 8X1/4" BSP</td> <td>1</td> <td>PZ</td> </tr> <tr> <td>TB2820A0</td> <td>PIPE EPDM FOR WASHING SYSTEM</td> <td>1.200</td> <td>M</td> </tr> <tr> <td>VI1220A1</td> <td>4,2X12 TCB SELF-TAPPIN G SCREW</td> <td>9</td> <td>PZ</td> </tr> <tr> <td>VL1019A0</td> <td>VIBRATION PUMP</td> <td>1</td> <td>PZ</td> </tr> <tr> <td>VL1054B0</td> <td>ONE WASHING SYS INLET DISTRIBUTOR</td> <td>1</td> <td>PZ</td> </tr> <tr> <td>VL1064A0</td> <td>WASHING SYSTEM OUTLETS DISTRIBUTOR</td> <td>1</td> <td>PZ</td> </tr> <tr> <td>VL1065A1</td> <td>1/4 MALE N.O. PRESSURE SWITCH</td> <td>1</td> <td>PZ</td> </tr> <tr> <td>VL1102A1</td> <td>DETERGENT LINE FILTER + BARBED VNR 6 MM</td> <td>1</td> <td>PZ</td> </tr> <tr> <td>VL1128A0</td> <td>BARBED CHECK VALVE D6</td> <td>1</td> <td>PZ</td> </tr> <tr> <td>VL1128A1</td> <td></td> <td>1</td> <td>PZ</td> </tr> <tr> <td>VM2172A0</td> <td>PUMP-WITH-CI RCUIT LOCKING PIN</td> <td>1</td> <td>PZ</td> </tr> </tbody> </table>	Code	Description	Qty	UOM	EL1437B0	JG D8 WATER SOLENOID VALVE -BARBED D6 V	1	PZ	GN1312A0	RUBBER CABLE-PASSI NG DE=26 DI=15 SP=10	1	PZ	GN1526A0	INT. D.=6.9 TH=1.8 O-RIN	1	PZ	RC1019A0	D=10 ELASTIC CLAMP	10	PZ	RC1242A0	D=10 CLOSED CAP	2	PZ	RC1356A0	STRAIGHT THREADED FEMALE END 8X1/4" BSP	1	PZ	TB2820A0	PIPE EPDM FOR WASHING SYSTEM	1.200	M	VI1220A1	4,2X12 TCB SELF-TAPPIN G SCREW	9	PZ	VL1019A0	VIBRATION PUMP	1	PZ	VL1054B0	ONE WASHING SYS INLET DISTRIBUTOR	1	PZ	VL1064A0	WASHING SYSTEM OUTLETS DISTRIBUTOR	1	PZ	VL1065A1	1/4 MALE N.O. PRESSURE SWITCH	1	PZ	VL1102A1	DETERGENT LINE FILTER + BARBED VNR 6 MM	1	PZ	VL1128A0	BARBED CHECK VALVE D6	1	PZ	VL1128A1		1	PZ	VM2172A0	PUMP-WITH-CI RCUIT LOCKING PIN	1	PZ
Code	Description	Qty	UOM																																																																						
EL1437B0	JG D8 WATER SOLENOID VALVE -BARBED D6 V	1	PZ																																																																						
GN1312A0	RUBBER CABLE-PASSI NG DE=26 DI=15 SP=10	1	PZ																																																																						
GN1526A0	INT. D.=6.9 TH=1.8 O-RIN	1	PZ																																																																						
RC1019A0	D=10 ELASTIC CLAMP	10	PZ																																																																						
RC1242A0	D=10 CLOSED CAP	2	PZ																																																																						
RC1356A0	STRAIGHT THREADED FEMALE END 8X1/4" BSP	1	PZ																																																																						
TB2820A0	PIPE EPDM FOR WASHING SYSTEM	1.200	M																																																																						
VI1220A1	4,2X12 TCB SELF-TAPPIN G SCREW	9	PZ																																																																						
VL1019A0	VIBRATION PUMP	1	PZ																																																																						
VL1054B0	ONE WASHING SYS INLET DISTRIBUTOR	1	PZ																																																																						
VL1064A0	WASHING SYSTEM OUTLETS DISTRIBUTOR	1	PZ																																																																						
VL1065A1	1/4 MALE N.O. PRESSURE SWITCH	1	PZ																																																																						
VL1102A1	DETERGENT LINE FILTER + BARBED VNR 6 MM	1	PZ																																																																						
VL1128A0	BARBED CHECK VALVE D6	1	PZ																																																																						
VL1128A1		1	PZ																																																																						
VM2172A0	PUMP-WITH-CI RCUIT LOCKING PIN	1	PZ																																																																						
			KVL1119A	EUR COMPACT PLUS CLEANING SYSTEM KIT	<table border="1"> <thead> <tr> <th>Code</th> <th>Description</th> <th>Qty</th> <th>UOM</th> </tr> </thead> <tbody> <tr> <td>0H2143A0</td> <td></td> <td>1</td> <td>PZ</td> </tr> <tr> <td>0H7553D0</td> <td>XECC PLUS WASHING SYSTEM PLAT</td> <td>1</td> <td>PZ</td> </tr> </tbody> </table>	Code	Description	Qty	UOM	0H2143A0		1	PZ	0H7553D0	XECC PLUS WASHING SYSTEM PLAT	1	PZ																																																								
Code	Description	Qty	UOM																																																																						
0H2143A0		1	PZ																																																																						
0H7553D0	XECC PLUS WASHING SYSTEM PLAT	1	PZ																																																																						

COMPONENT			SPARE PART																																																																																						
Code	Description	Image	Code	Description	Components list																																																																																				
VL1019A	VIBRATION PUMP		KVL1119A	EUR COMPACT PLUS CLEANING SYSTEM KIT	<table border="1"> <thead> <tr> <th>Code</th> <th>Description</th> <th>Qty</th> <th>UOM</th> </tr> </thead> <tbody> <tr> <td>EL1252A1</td> <td>1 WAY WATER VALVE + J.G. CONNECTION</td> <td>1</td> <td>PZ</td> </tr> <tr> <td>EL1424A0</td> <td>D8 CONNECTION WATER SOLENOID VALVE</td> <td>1</td> <td>PZ</td> </tr> <tr> <td>EL1424B0</td> <td></td> <td>1</td> <td>PZ</td> </tr> <tr> <td>EL1436A0</td> <td>H2O SOLENOID JG D8 CHECK VALVE</td> <td>1</td> <td>PZ</td> </tr> <tr> <td>EL1436B0</td> <td></td> <td>1</td> <td>PZ</td> </tr> <tr> <td>GN1312A0</td> <td>RUBBER CABLE-PASSI NG DE=26 DI=15 SP=10</td> <td>1</td> <td>PZ</td> </tr> <tr> <td>GN1526A0</td> <td>INT. D.=6.9 TH=1.8 O-RIN</td> <td>1</td> <td>PZ</td> </tr> <tr> <td>RC1019A0</td> <td>D=10 ELASTIC CLAMP</td> <td>11</td> <td>PZ</td> </tr> <tr> <td>RC1242A0</td> <td>D=10 CLOSED CAP</td> <td>2</td> <td>PZ</td> </tr> <tr> <td>RC1356A0</td> <td>STRAIGHT THREADED FEMALE END 8X1/4" BSP</td> <td>1</td> <td>PZ</td> </tr> <tr> <td>TB2820A0</td> <td>PIPE EPDM FOR WASHING SYSTEM</td> <td>1.200</td> <td>M</td> </tr> <tr> <td>VH1220A1</td> <td>4,2X12 TCB SELF-TAPPIN G SCREW</td> <td>16</td> <td>PZ</td> </tr> <tr> <td>VL1019A0</td> <td>VIBRATION PUMP</td> <td>1</td> <td>PZ</td> </tr> <tr> <td>VL1054B0</td> <td>ONE WASHING SYS INLET DISTRIBUTOR</td> <td>1</td> <td>PZ</td> </tr> <tr> <td>VL1064A0</td> <td>WASHING SYSTEM OUTLETS DISTRIBUTOR</td> <td>1</td> <td>PZ</td> </tr> <tr> <td>VL1065A1</td> <td>1/4 MALE N.O. PRESSURE SWITCH</td> <td>1</td> <td>PZ</td> </tr> <tr> <td>VL1102A1</td> <td>DETERGENT LINE FILTER + BARBED VNR 6 MM</td> <td>1</td> <td>PZ</td> </tr> <tr> <td>VL1128A0</td> <td>BARBED CHECK VALVE D6</td> <td>1</td> <td>PZ</td> </tr> <tr> <td>VL1128A1</td> <td></td> <td>1</td> <td>PZ</td> </tr> <tr> <td>VM2172A0</td> <td>PUMP-WITH-CI RCUIT LOCKING PIN</td> <td>1</td> <td>PZ</td> </tr> </tbody> </table>	Code	Description	Qty	UOM	EL1252A1	1 WAY WATER VALVE + J.G. CONNECTION	1	PZ	EL1424A0	D8 CONNECTION WATER SOLENOID VALVE	1	PZ	EL1424B0		1	PZ	EL1436A0	H2O SOLENOID JG D8 CHECK VALVE	1	PZ	EL1436B0		1	PZ	GN1312A0	RUBBER CABLE-PASSI NG DE=26 DI=15 SP=10	1	PZ	GN1526A0	INT. D.=6.9 TH=1.8 O-RIN	1	PZ	RC1019A0	D=10 ELASTIC CLAMP	11	PZ	RC1242A0	D=10 CLOSED CAP	2	PZ	RC1356A0	STRAIGHT THREADED FEMALE END 8X1/4" BSP	1	PZ	TB2820A0	PIPE EPDM FOR WASHING SYSTEM	1.200	M	VH1220A1	4,2X12 TCB SELF-TAPPIN G SCREW	16	PZ	VL1019A0	VIBRATION PUMP	1	PZ	VL1054B0	ONE WASHING SYS INLET DISTRIBUTOR	1	PZ	VL1064A0	WASHING SYSTEM OUTLETS DISTRIBUTOR	1	PZ	VL1065A1	1/4 MALE N.O. PRESSURE SWITCH	1	PZ	VL1102A1	DETERGENT LINE FILTER + BARBED VNR 6 MM	1	PZ	VL1128A0	BARBED CHECK VALVE D6	1	PZ	VL1128A1		1	PZ	VM2172A0	PUMP-WITH-CI RCUIT LOCKING PIN	1	PZ
Code	Description	Qty	UOM																																																																																						
EL1252A1	1 WAY WATER VALVE + J.G. CONNECTION	1	PZ																																																																																						
EL1424A0	D8 CONNECTION WATER SOLENOID VALVE	1	PZ																																																																																						
EL1424B0		1	PZ																																																																																						
EL1436A0	H2O SOLENOID JG D8 CHECK VALVE	1	PZ																																																																																						
EL1436B0		1	PZ																																																																																						
GN1312A0	RUBBER CABLE-PASSI NG DE=26 DI=15 SP=10	1	PZ																																																																																						
GN1526A0	INT. D.=6.9 TH=1.8 O-RIN	1	PZ																																																																																						
RC1019A0	D=10 ELASTIC CLAMP	11	PZ																																																																																						
RC1242A0	D=10 CLOSED CAP	2	PZ																																																																																						
RC1356A0	STRAIGHT THREADED FEMALE END 8X1/4" BSP	1	PZ																																																																																						
TB2820A0	PIPE EPDM FOR WASHING SYSTEM	1.200	M																																																																																						
VH1220A1	4,2X12 TCB SELF-TAPPIN G SCREW	16	PZ																																																																																						
VL1019A0	VIBRATION PUMP	1	PZ																																																																																						
VL1054B0	ONE WASHING SYS INLET DISTRIBUTOR	1	PZ																																																																																						
VL1064A0	WASHING SYSTEM OUTLETS DISTRIBUTOR	1	PZ																																																																																						
VL1065A1	1/4 MALE N.O. PRESSURE SWITCH	1	PZ																																																																																						
VL1102A1	DETERGENT LINE FILTER + BARBED VNR 6 MM	1	PZ																																																																																						
VL1128A0	BARBED CHECK VALVE D6	1	PZ																																																																																						
VL1128A1		1	PZ																																																																																						
VM2172A0	PUMP-WITH-CI RCUIT LOCKING PIN	1	PZ																																																																																						

COMPONENT			SPARE PART																																																																																									
Code	Description	Image	Code	Description	Components list																																																																																							
VL1019A	VIBRATION PUMP		KVL1118A	EUR COMPACT ONE CLEANING SYSTEM KIT	<table border="1"> <thead> <tr> <th>Code</th> <th>Description</th> <th>Qty</th> <th>UOM</th> </tr> </thead> <tbody> <tr> <td>0H2143A0</td> <td></td> <td>1</td> <td>PZ</td> </tr> <tr> <td>0H7173C0</td> <td>XECC ONE WASHING SYSTEM PLAT</td> <td>1</td> <td>PZ</td> </tr> <tr> <td>EL1436A0</td> <td>H2O SOLENOID JG D8 CHECK VALVE</td> <td>1</td> <td>PZ</td> </tr> <tr> <td>EL1436B0</td> <td></td> <td>1</td> <td>PZ</td> </tr> <tr> <td>GN1526A0</td> <td>INT. D.=6.9 TH=1.8 O-RIN</td> <td>1</td> <td>PZ</td> </tr> <tr> <td>RC1019A0</td> <td>D=10 ELASTIC CLAMP</td> <td>12</td> <td>PZ</td> </tr> <tr> <td>RC1242A0</td> <td>D=10 CLOSED CAP</td> <td>2</td> <td>PZ</td> </tr> <tr> <td>TB2820A0</td> <td>PIPE EPDM FOR WASHING SYSTEM</td> <td>1.200</td> <td>M</td> </tr> <tr> <td>VI1220A1</td> <td>4,2X12 TCB SELF-TAPPIN G.SCREW</td> <td>6</td> <td>PZ</td> </tr> <tr> <td>VL1019A0</td> <td>VIBRATION PUMP</td> <td>1</td> <td>PZ</td> </tr> <tr> <td>VL1053B0</td> <td>ONE WASHING SYS EXT DISTRIBUTOR</td> <td>1</td> <td>PZ</td> </tr> <tr> <td>VL1054B0</td> <td>ONE WASHING SYS INLET DISTRIBUTOR</td> <td>1</td> <td>PZ</td> </tr> <tr> <td>VL1102A1</td> <td>DETERGENT LINE FILTER + BARBED VNR 6 MM</td> <td>1</td> <td>PZ</td> </tr> <tr> <td>VL1128A0</td> <td>BARBED CHECK VALVE D6</td> <td>1</td> <td>PZ</td> </tr> <tr> <td>VL1128A1</td> <td></td> <td>1</td> <td>PZ</td> </tr> <tr> <td>VM2172A0</td> <td>PUMP-WITH-CI RCUIT LOCKING PIN</td> <td>1</td> <td>PZ</td> </tr> </tbody> </table>	Code	Description	Qty	UOM	0H2143A0		1	PZ	0H7173C0	XECC ONE WASHING SYSTEM PLAT	1	PZ	EL1436A0	H2O SOLENOID JG D8 CHECK VALVE	1	PZ	EL1436B0		1	PZ	GN1526A0	INT. D.=6.9 TH=1.8 O-RIN	1	PZ	RC1019A0	D=10 ELASTIC CLAMP	12	PZ	RC1242A0	D=10 CLOSED CAP	2	PZ	TB2820A0	PIPE EPDM FOR WASHING SYSTEM	1.200	M	VI1220A1	4,2X12 TCB SELF-TAPPIN G.SCREW	6	PZ	VL1019A0	VIBRATION PUMP	1	PZ	VL1053B0	ONE WASHING SYS EXT DISTRIBUTOR	1	PZ	VL1054B0	ONE WASHING SYS INLET DISTRIBUTOR	1	PZ	VL1102A1	DETERGENT LINE FILTER + BARBED VNR 6 MM	1	PZ	VL1128A0	BARBED CHECK VALVE D6	1	PZ	VL1128A1		1	PZ	VM2172A0	PUMP-WITH-CI RCUIT LOCKING PIN	1	PZ	KVL1109A	EUR 2 ROTOR ARMS ONE CLEANING SYSTEM KIT	<table border="1"> <thead> <tr> <th>Code</th> <th>Description</th> <th>Qty</th> <th>UOM</th> </tr> </thead> <tbody> <tr> <td>0H2143A0</td> <td></td> <td>2</td> <td>PZ</td> </tr> <tr> <td>0H7324A0</td> <td>ONE OVENS WASHING SYST HOLDING PLATE</td> <td>2</td> <td>PZ</td> </tr> <tr> <td>0H7515A0</td> <td>XEVC-2011-E1 R DOUBLE WASHING SYS PLATE</td> <td>1</td> <td>PZ</td> </tr> </tbody> </table>	Code	Description	Qty	UOM	0H2143A0		2	PZ	0H7324A0	ONE OVENS WASHING SYST HOLDING PLATE	2	PZ	0H7515A0	XEVC-2011-E1 R DOUBLE WASHING SYS PLATE	1	PZ
			Code	Description	Qty	UOM																																																																																						
0H2143A0		1	PZ																																																																																									
0H7173C0	XECC ONE WASHING SYSTEM PLAT	1	PZ																																																																																									
EL1436A0	H2O SOLENOID JG D8 CHECK VALVE	1	PZ																																																																																									
EL1436B0		1	PZ																																																																																									
GN1526A0	INT. D.=6.9 TH=1.8 O-RIN	1	PZ																																																																																									
RC1019A0	D=10 ELASTIC CLAMP	12	PZ																																																																																									
RC1242A0	D=10 CLOSED CAP	2	PZ																																																																																									
TB2820A0	PIPE EPDM FOR WASHING SYSTEM	1.200	M																																																																																									
VI1220A1	4,2X12 TCB SELF-TAPPIN G.SCREW	6	PZ																																																																																									
VL1019A0	VIBRATION PUMP	1	PZ																																																																																									
VL1053B0	ONE WASHING SYS EXT DISTRIBUTOR	1	PZ																																																																																									
VL1054B0	ONE WASHING SYS INLET DISTRIBUTOR	1	PZ																																																																																									
VL1102A1	DETERGENT LINE FILTER + BARBED VNR 6 MM	1	PZ																																																																																									
VL1128A0	BARBED CHECK VALVE D6	1	PZ																																																																																									
VL1128A1		1	PZ																																																																																									
VM2172A0	PUMP-WITH-CI RCUIT LOCKING PIN	1	PZ																																																																																									
Code	Description	Qty	UOM																																																																																									
0H2143A0		2	PZ																																																																																									
0H7324A0	ONE OVENS WASHING SYST HOLDING PLATE	2	PZ																																																																																									
0H7515A0	XEVC-2011-E1 R DOUBLE WASHING SYS PLATE	1	PZ																																																																																									

COMPONENT			SPARE PART																																																																																									
Code	Description	Image	Code	Description	Components list																																																																																							
VL1019A	VIBRATION PUMP		KVL1109A	EUR 2 ROTOR ARMS ONE CLEANING SYSTEM KIT	<table border="1"> <thead> <tr> <th>Code</th> <th>Description</th> <th>Qty</th> <th>UOM</th> </tr> </thead> <tbody> <tr> <td>CH1000A0</td> <td>SNIP PIPE CUTTER</td> <td>1</td> <td>PZ</td> </tr> <tr> <td>EL1115A0</td> <td>Ø8 Y CONNECTION</td> <td>1</td> <td>PZ</td> </tr> <tr> <td>EL1436A0</td> <td>H2O SOLENOID JG D8 CHECK VALVE</td> <td>2</td> <td>PZ</td> </tr> <tr> <td>EL1436B0</td> <td></td> <td>2</td> <td>PZ</td> </tr> <tr> <td>GN1526A0</td> <td>INT. D.=6.9 TH=1.8 O-RIN</td> <td>2</td> <td>PZ</td> </tr> <tr> <td>RC1006A0</td> <td>D8 PET PIPE GUIDE BEND</td> <td>4</td> <td>PZ</td> </tr> <tr> <td>RC1019A0</td> <td>D=10 ELASTIC CLAMP</td> <td>26</td> <td>PZ</td> </tr> <tr> <td>RC1242A0</td> <td>D=10 CLOSED CAP</td> <td>4</td> <td>PZ</td> </tr> <tr> <td>TB1818A0</td> <td>JG Ø8 BLUE PE PIPE</td> <td>1.640</td> <td>M</td> </tr> <tr> <td>TB2820A0</td> <td>PIPE EPDM FOR WASHING SYSTEM</td> <td>3.940</td> <td>M</td> </tr> <tr> <td>VI1220A1</td> <td>4,2X12 TCB SELF-TAPPIN G SCREW</td> <td>8</td> <td>PZ</td> </tr> <tr> <td>VL1019A0</td> <td>VIBRATION PUMP</td> <td>2</td> <td>PZ</td> </tr> <tr> <td>VL1053B0</td> <td>ONE WASHING SYS EXT DISTRIBUTOR</td> <td>2</td> <td>PZ</td> </tr> <tr> <td>VL1054B0</td> <td>ONE WASHING SYS INLET DISTRIBUTOR</td> <td>2</td> <td>PZ</td> </tr> <tr> <td>VL1102A1</td> <td>DETERGENT LINE FILTER + BARBED VNR 6 MM</td> <td>2</td> <td>PZ</td> </tr> <tr> <td>VL1128A0</td> <td>BARBED CHECK VALVE D6</td> <td>2</td> <td>PZ</td> </tr> <tr> <td>VM2172A0</td> <td>PUMP-WITH-CI RCUIT LOCKING PIN</td> <td>2</td> <td>PZ</td> </tr> </tbody> </table>	Code	Description	Qty	UOM	CH1000A0	SNIP PIPE CUTTER	1	PZ	EL1115A0	Ø8 Y CONNECTION	1	PZ	EL1436A0	H2O SOLENOID JG D8 CHECK VALVE	2	PZ	EL1436B0		2	PZ	GN1526A0	INT. D.=6.9 TH=1.8 O-RIN	2	PZ	RC1006A0	D8 PET PIPE GUIDE BEND	4	PZ	RC1019A0	D=10 ELASTIC CLAMP	26	PZ	RC1242A0	D=10 CLOSED CAP	4	PZ	TB1818A0	JG Ø8 BLUE PE PIPE	1.640	M	TB2820A0	PIPE EPDM FOR WASHING SYSTEM	3.940	M	VI1220A1	4,2X12 TCB SELF-TAPPIN G SCREW	8	PZ	VL1019A0	VIBRATION PUMP	2	PZ	VL1053B0	ONE WASHING SYS EXT DISTRIBUTOR	2	PZ	VL1054B0	ONE WASHING SYS INLET DISTRIBUTOR	2	PZ	VL1102A1	DETERGENT LINE FILTER + BARBED VNR 6 MM	2	PZ	VL1128A0	BARBED CHECK VALVE D6	2	PZ	VM2172A0	PUMP-WITH-CI RCUIT LOCKING PIN	2	PZ	KVL1108A	04EU ONE EUR 1 ROTOR CLEANING SYSTEM KIT	<table border="1"> <thead> <tr> <th>Code</th> <th>Description</th> <th>Qty</th> <th>UOM</th> </tr> </thead> <tbody> <tr> <td>0H2143A0</td> <td></td> <td>1</td> <td>PZ</td> </tr> <tr> <td>0H7511A0</td> <td>ONE OVENS WASHING SYST HOLDING PLATE</td> <td>1</td> <td>PZ</td> </tr> </tbody> </table>	Code	Description	Qty	UOM	0H2143A0		1	PZ	0H7511A0	ONE OVENS WASHING SYST HOLDING PLATE	1	PZ
			Code	Description	Qty	UOM																																																																																						
CH1000A0	SNIP PIPE CUTTER	1	PZ																																																																																									
EL1115A0	Ø8 Y CONNECTION	1	PZ																																																																																									
EL1436A0	H2O SOLENOID JG D8 CHECK VALVE	2	PZ																																																																																									
EL1436B0		2	PZ																																																																																									
GN1526A0	INT. D.=6.9 TH=1.8 O-RIN	2	PZ																																																																																									
RC1006A0	D8 PET PIPE GUIDE BEND	4	PZ																																																																																									
RC1019A0	D=10 ELASTIC CLAMP	26	PZ																																																																																									
RC1242A0	D=10 CLOSED CAP	4	PZ																																																																																									
TB1818A0	JG Ø8 BLUE PE PIPE	1.640	M																																																																																									
TB2820A0	PIPE EPDM FOR WASHING SYSTEM	3.940	M																																																																																									
VI1220A1	4,2X12 TCB SELF-TAPPIN G SCREW	8	PZ																																																																																									
VL1019A0	VIBRATION PUMP	2	PZ																																																																																									
VL1053B0	ONE WASHING SYS EXT DISTRIBUTOR	2	PZ																																																																																									
VL1054B0	ONE WASHING SYS INLET DISTRIBUTOR	2	PZ																																																																																									
VL1102A1	DETERGENT LINE FILTER + BARBED VNR 6 MM	2	PZ																																																																																									
VL1128A0	BARBED CHECK VALVE D6	2	PZ																																																																																									
VM2172A0	PUMP-WITH-CI RCUIT LOCKING PIN	2	PZ																																																																																									
Code	Description	Qty	UOM																																																																																									
0H2143A0		1	PZ																																																																																									
0H7511A0	ONE OVENS WASHING SYST HOLDING PLATE	1	PZ																																																																																									





COMPONENT			SPARE PART																																																																																													
Code	Description	Image	Code	Description	Components list																																																																																											
VL1019A	VIBRATION PUMP		KVL1108A	04EU ONE EUR 1 ROTOR CLEANING SYSTEM KIT	<table border="1"> <thead> <tr> <th>Code</th> <th>Description</th> <th>Qty</th> <th>UOM</th> </tr> </thead> <tbody> <tr> <td>EL1436A0</td> <td>H2O SOLENOID JG D8 CHECK VALVE</td> <td>1</td> <td>PZ</td> </tr> <tr> <td>EL1436B0</td> <td></td> <td>1</td> <td>PZ</td> </tr> <tr> <td>GN1526A0</td> <td>INT. D.=6.9 TH=1.8 O-RIN</td> <td>1</td> <td>PZ</td> </tr> <tr> <td>RC1006A0</td> <td>D8 PET PIPE GUIDE BEND</td> <td>2</td> <td>PZ</td> </tr> <tr> <td>RC1019A0</td> <td>D=10 ELASTIC CLAMP</td> <td>17</td> <td>PZ</td> </tr> <tr> <td>RC1242A0</td> <td>D=10 CLOSED CAP</td> <td>2</td> <td>PZ</td> </tr> <tr> <td>TB1818A0</td> <td>JG Ø8 BLUE PE PIPE</td> <td>0.320</td> <td>M</td> </tr> <tr> <td>TB2820A0</td> <td>PIPE EPDM FOR WASHING SYSTEM</td> <td>1.380</td> <td>M</td> </tr> <tr> <td>VI1220A1</td> <td>4,2X12 TCB SELF-TAPPIN G.SCREW</td> <td>1</td> <td>PZ</td> </tr> <tr> <td>VL1019A0</td> <td>VIBRATION PUMP</td> <td>2</td> <td>PZ</td> </tr> <tr> <td>VL1053B0</td> <td>ONE WASHING SYS EXT DISTRIBUTOR</td> <td>1</td> <td>PZ</td> </tr> <tr> <td>VL1054B0</td> <td>ONE WASHING SYS INLET DISTRIBUTOR</td> <td>1</td> <td>PZ</td> </tr> <tr> <td>VL1128A0</td> <td>BARBED CHECK VALVE D6</td> <td>1</td> <td>PZ</td> </tr> <tr> <td>VM2172A0</td> <td>PUMP-WITH-CI RCUIT LOCKING PIN</td> <td>1</td> <td>PZ</td> </tr> </tbody> </table>	Code	Description	Qty	UOM	EL1436A0	H2O SOLENOID JG D8 CHECK VALVE	1	PZ	EL1436B0		1	PZ	GN1526A0	INT. D.=6.9 TH=1.8 O-RIN	1	PZ	RC1006A0	D8 PET PIPE GUIDE BEND	2	PZ	RC1019A0	D=10 ELASTIC CLAMP	17	PZ	RC1242A0	D=10 CLOSED CAP	2	PZ	TB1818A0	JG Ø8 BLUE PE PIPE	0.320	M	TB2820A0	PIPE EPDM FOR WASHING SYSTEM	1.380	M	VI1220A1	4,2X12 TCB SELF-TAPPIN G.SCREW	1	PZ	VL1019A0	VIBRATION PUMP	2	PZ	VL1053B0	ONE WASHING SYS EXT DISTRIBUTOR	1	PZ	VL1054B0	ONE WASHING SYS INLET DISTRIBUTOR	1	PZ	VL1128A0	BARBED CHECK VALVE D6	1	PZ	VM2172A0	PUMP-WITH-CI RCUIT LOCKING PIN	1	PZ	KVL1106A	EUR 1 ROTOR ARM ONE CLEANING SYSTEM KIT	<table border="1"> <thead> <tr> <th>Code</th> <th>Description</th> <th>Qty</th> <th>UOM</th> </tr> </thead> <tbody> <tr> <td>0H2143A0</td> <td></td> <td>1</td> <td>PZ</td> </tr> <tr> <td>0H7819A0</td> <td>ONE WASHING SYS SUPPORT WITH STEAM VALVE</td> <td>1</td> <td>PZ</td> </tr> <tr> <td>EL1436A0</td> <td>H2O SOLENOID JG D8 CHECK VALVE</td> <td>1</td> <td>PZ</td> </tr> <tr> <td>EL1436B0</td> <td></td> <td>1</td> <td>PZ</td> </tr> <tr> <td>GN1526A0</td> <td>INT. D.=6.9 TH=1.8 O-RIN</td> <td>1</td> <td>PZ</td> </tr> <tr> <td>RC1242A0</td> <td>D=10 CLOSED CAP</td> <td>2</td> <td>PZ</td> </tr> </tbody> </table>	Code	Description	Qty	UOM	0H2143A0		1	PZ	0H7819A0	ONE WASHING SYS SUPPORT WITH STEAM VALVE	1	PZ	EL1436A0	H2O SOLENOID JG D8 CHECK VALVE	1	PZ	EL1436B0		1	PZ	GN1526A0	INT. D.=6.9 TH=1.8 O-RIN	1	PZ	RC1242A0	D=10 CLOSED CAP	2	PZ
			Code	Description	Qty	UOM																																																																																										
EL1436A0	H2O SOLENOID JG D8 CHECK VALVE	1	PZ																																																																																													
EL1436B0		1	PZ																																																																																													
GN1526A0	INT. D.=6.9 TH=1.8 O-RIN	1	PZ																																																																																													
RC1006A0	D8 PET PIPE GUIDE BEND	2	PZ																																																																																													
RC1019A0	D=10 ELASTIC CLAMP	17	PZ																																																																																													
RC1242A0	D=10 CLOSED CAP	2	PZ																																																																																													
TB1818A0	JG Ø8 BLUE PE PIPE	0.320	M																																																																																													
TB2820A0	PIPE EPDM FOR WASHING SYSTEM	1.380	M																																																																																													
VI1220A1	4,2X12 TCB SELF-TAPPIN G.SCREW	1	PZ																																																																																													
VL1019A0	VIBRATION PUMP	2	PZ																																																																																													
VL1053B0	ONE WASHING SYS EXT DISTRIBUTOR	1	PZ																																																																																													
VL1054B0	ONE WASHING SYS INLET DISTRIBUTOR	1	PZ																																																																																													
VL1128A0	BARBED CHECK VALVE D6	1	PZ																																																																																													
VM2172A0	PUMP-WITH-CI RCUIT LOCKING PIN	1	PZ																																																																																													
Code	Description	Qty	UOM																																																																																													
0H2143A0		1	PZ																																																																																													
0H7819A0	ONE WASHING SYS SUPPORT WITH STEAM VALVE	1	PZ																																																																																													
EL1436A0	H2O SOLENOID JG D8 CHECK VALVE	1	PZ																																																																																													
EL1436B0		1	PZ																																																																																													
GN1526A0	INT. D.=6.9 TH=1.8 O-RIN	1	PZ																																																																																													
RC1242A0	D=10 CLOSED CAP	2	PZ																																																																																													





COMPONENT			SPARE PART																																										
Code	Description	Image	Code	Description	Components list																																								
VL1019A	VIBRATION PUMP		KVL1106A	EUR 1 ROTOR ARM ONE CLEANING SYSTEM KIT	<table border="1"> <thead> <tr> <th>Code</th> <th>Description</th> <th>Qty</th> <th>UOM</th> </tr> </thead> <tbody> <tr> <td>TB2820A0</td> <td>PIPE EPDM FOR WASHING SYSTEM</td> <td>1.420</td> <td>M</td> </tr> <tr> <td>VI1220A1</td> <td>4,2X12 TCB SELF-TAPPIN G SCREW</td> <td>1</td> <td>PZ</td> </tr> <tr> <td>VL1019A0</td> <td>VIBRATION PUMP</td> <td>1</td> <td>PZ</td> </tr> <tr> <td>VL1053B0</td> <td>ONE WASHING SYS EXT DISTRIBUTOR</td> <td>1</td> <td>PZ</td> </tr> <tr> <td>VL1054B0</td> <td>ONE WASHING SYS INLET DISTRIBUTOR</td> <td>1</td> <td>PZ</td> </tr> <tr> <td>VL1102A1</td> <td>DETERGENT + LINE FILTER + BARBED VNR 6 MM</td> <td>1</td> <td>PZ</td> </tr> <tr> <td>VL1128A0</td> <td>BARBED CHECK VALVE D6</td> <td>1</td> <td>PZ</td> </tr> <tr> <td>VL1128A1</td> <td></td> <td>1</td> <td>PZ</td> </tr> <tr> <td>VM2172A0</td> <td>PUMP-WITH-CI RCUIT LOCKING PIN</td> <td>1</td> <td>PZ</td> </tr> </tbody> </table>	Code	Description	Qty	UOM	TB2820A0	PIPE EPDM FOR WASHING SYSTEM	1.420	M	VI1220A1	4,2X12 TCB SELF-TAPPIN G SCREW	1	PZ	VL1019A0	VIBRATION PUMP	1	PZ	VL1053B0	ONE WASHING SYS EXT DISTRIBUTOR	1	PZ	VL1054B0	ONE WASHING SYS INLET DISTRIBUTOR	1	PZ	VL1102A1	DETERGENT + LINE FILTER + BARBED VNR 6 MM	1	PZ	VL1128A0	BARBED CHECK VALVE D6	1	PZ	VL1128A1		1	PZ	VM2172A0	PUMP-WITH-CI RCUIT LOCKING PIN	1	PZ
			Code	Description	Qty	UOM																																							
TB2820A0	PIPE EPDM FOR WASHING SYSTEM	1.420	M																																										
VI1220A1	4,2X12 TCB SELF-TAPPIN G SCREW	1	PZ																																										
VL1019A0	VIBRATION PUMP	1	PZ																																										
VL1053B0	ONE WASHING SYS EXT DISTRIBUTOR	1	PZ																																										
VL1054B0	ONE WASHING SYS INLET DISTRIBUTOR	1	PZ																																										
VL1102A1	DETERGENT + LINE FILTER + BARBED VNR 6 MM	1	PZ																																										
VL1128A0	BARBED CHECK VALVE D6	1	PZ																																										
VL1128A1		1	PZ																																										
VM2172A0	PUMP-WITH-CI RCUIT LOCKING PIN	1	PZ																																										
KVL1105A	USA 2ROTOR ARMS PLUS CLEANING SYSTEM KIT	<table border="1"> <thead> <tr> <th>Code</th> <th>Description</th> <th>Qty</th> <th>UOM</th> </tr> </thead> <tbody> <tr> <td>0H2143A0</td> <td></td> <td>1</td> <td>PZ</td> </tr> <tr> <td>0H7820A0</td> <td>PLUS WASHING SY SUPPORT WITH STEAM VALVE</td> <td>1</td> <td>PZ</td> </tr> <tr> <td>EL1422A1</td> <td>1 WAY SOLENOID VALVE + D8-D10 REDUCTION</td> <td>1</td> <td>PZ</td> </tr> <tr> <td>EL1426A0</td> <td>H2O UL SOLENOID JG D8-PIPE HOLDER</td> <td>2</td> <td>PZ</td> </tr> <tr> <td>EL1426B0</td> <td>UL JG D8 WATER SOLENOID VALVE-PIPE HOLDER</td> <td>2</td> <td>PZ</td> </tr> <tr> <td>EL1437A0</td> <td>H2O SOLENOID JG D6 UL CHECK VALVE</td> <td>1</td> <td>PZ</td> </tr> </tbody> </table>	Code	Description	Qty	UOM	0H2143A0		1	PZ	0H7820A0	PLUS WASHING SY SUPPORT WITH STEAM VALVE	1	PZ	EL1422A1	1 WAY SOLENOID VALVE + D8-D10 REDUCTION	1	PZ	EL1426A0	H2O UL SOLENOID JG D8-PIPE HOLDER	2	PZ	EL1426B0	UL JG D8 WATER SOLENOID VALVE-PIPE HOLDER	2	PZ	EL1437A0	H2O SOLENOID JG D6 UL CHECK VALVE	1	PZ															
Code	Description	Qty	UOM																																										
0H2143A0		1	PZ																																										
0H7820A0	PLUS WASHING SY SUPPORT WITH STEAM VALVE	1	PZ																																										
EL1422A1	1 WAY SOLENOID VALVE + D8-D10 REDUCTION	1	PZ																																										
EL1426A0	H2O UL SOLENOID JG D8-PIPE HOLDER	2	PZ																																										
EL1426B0	UL JG D8 WATER SOLENOID VALVE-PIPE HOLDER	2	PZ																																										
EL1437A0	H2O SOLENOID JG D6 UL CHECK VALVE	1	PZ																																										



COMPONENT			SPARE PART																																																																																					
Code	Description	Image	Code	Description	Components list																																																																																			
VL1019A	VIBRATION PUMP		KVL1105A	USA 2 ROTOR ARMS PLUS CLEANING SYSTEM KIT	<table border="1"> <thead> <tr> <th>Code</th> <th>Description</th> <th>Qty</th> <th>UOM</th> </tr> </thead> <tbody> <tr> <td>EL1437B0</td> <td>JG D8 WATER SOLENOID VALVE -BARBED D6 V</td> <td>1</td> <td>PZ</td> </tr> <tr> <td>GN1526A0</td> <td>INT. D.=6.9 TH=1.8 O-RIN</td> <td>1</td> <td>PZ</td> </tr> <tr> <td>RC1019A0</td> <td>D=10 ELASTIC CLAMP</td> <td>12</td> <td>PZ</td> </tr> <tr> <td>RC1130A0</td> <td>130X2,6 CLAM</td> <td>1</td> <td>PZ</td> </tr> <tr> <td>RC1242A0</td> <td>D=10 CLOSED CAP</td> <td>2</td> <td>PZ</td> </tr> <tr> <td>RC1356A0</td> <td>STRAIGHT THREADED FEMALE END 8X1/4" BSP</td> <td>1</td> <td>PZ</td> </tr> <tr> <td>TB2820A0</td> <td>PIPE EPDM FOR WASHING SYSTEM</td> <td>1.410</td> <td>M</td> </tr> <tr> <td>VI1220A1</td> <td>4,2X12 TCB SELF-TAPPIN G.SCREW</td> <td>3</td> <td>PZ</td> </tr> <tr> <td>VL1019A0</td> <td>VIBRATION PUMP</td> <td>1</td> <td>PZ</td> </tr> <tr> <td>VL1065A1</td> <td>1/4 MALE N.O. PRESSURE SWITCH</td> <td>1</td> <td>PZ</td> </tr> <tr> <td>VL1067A0</td> <td>WASHING SYSTEM INLETS DISTRIBUTOR</td> <td>1</td> <td>PZ</td> </tr> <tr> <td>VL1092A0</td> <td>WASHING SYSTEM OUTLET DOUBLE DISTRIBUTOR</td> <td>1</td> <td>PZ</td> </tr> <tr> <td>VL1102A1</td> <td>DETERGENT LINE FILTER + BARBED VNR 6 MM</td> <td>1</td> <td>PZ</td> </tr> <tr> <td>VL1128A0</td> <td>BARBED CHECK VALVE D6</td> <td>1</td> <td>PZ</td> </tr> <tr> <td>VL1128A1</td> <td></td> <td>1</td> <td>PZ</td> </tr> <tr> <td>VM2172A0</td> <td>PUMP-WITH-CI RCUIT LOCKING PIN</td> <td>1</td> <td>PZ</td> </tr> </tbody> </table>	Code	Description	Qty	UOM	EL1437B0	JG D8 WATER SOLENOID VALVE -BARBED D6 V	1	PZ	GN1526A0	INT. D.=6.9 TH=1.8 O-RIN	1	PZ	RC1019A0	D=10 ELASTIC CLAMP	12	PZ	RC1130A0	130X2,6 CLAM	1	PZ	RC1242A0	D=10 CLOSED CAP	2	PZ	RC1356A0	STRAIGHT THREADED FEMALE END 8X1/4" BSP	1	PZ	TB2820A0	PIPE EPDM FOR WASHING SYSTEM	1.410	M	VI1220A1	4,2X12 TCB SELF-TAPPIN G.SCREW	3	PZ	VL1019A0	VIBRATION PUMP	1	PZ	VL1065A1	1/4 MALE N.O. PRESSURE SWITCH	1	PZ	VL1067A0	WASHING SYSTEM INLETS DISTRIBUTOR	1	PZ	VL1092A0	WASHING SYSTEM OUTLET DOUBLE DISTRIBUTOR	1	PZ	VL1102A1	DETERGENT LINE FILTER + BARBED VNR 6 MM	1	PZ	VL1128A0	BARBED CHECK VALVE D6	1	PZ	VL1128A1		1	PZ	VM2172A0	PUMP-WITH-CI RCUIT LOCKING PIN	1	PZ	KVL1104A	USA 1 ROTOR ARM PLUS CLEANING SYSTEM KIT	<table border="1"> <thead> <tr> <th>Code</th> <th>Description</th> <th>Qty</th> <th>UOM</th> </tr> </thead> <tbody> <tr> <td>0H2143A0</td> <td></td> <td>1</td> <td>PZ</td> </tr> <tr> <td>0H7820A0</td> <td>PLUS WASHING SY SUPPORT WITH STEAM VALVE</td> <td>1</td> <td>PZ</td> </tr> </tbody> </table>	Code	Description	Qty	UOM	0H2143A0		1	PZ	0H7820A0	PLUS WASHING SY SUPPORT WITH STEAM VALVE	1	PZ
			Code	Description	Qty	UOM																																																																																		
EL1437B0	JG D8 WATER SOLENOID VALVE -BARBED D6 V	1	PZ																																																																																					
GN1526A0	INT. D.=6.9 TH=1.8 O-RIN	1	PZ																																																																																					
RC1019A0	D=10 ELASTIC CLAMP	12	PZ																																																																																					
RC1130A0	130X2,6 CLAM	1	PZ																																																																																					
RC1242A0	D=10 CLOSED CAP	2	PZ																																																																																					
RC1356A0	STRAIGHT THREADED FEMALE END 8X1/4" BSP	1	PZ																																																																																					
TB2820A0	PIPE EPDM FOR WASHING SYSTEM	1.410	M																																																																																					
VI1220A1	4,2X12 TCB SELF-TAPPIN G.SCREW	3	PZ																																																																																					
VL1019A0	VIBRATION PUMP	1	PZ																																																																																					
VL1065A1	1/4 MALE N.O. PRESSURE SWITCH	1	PZ																																																																																					
VL1067A0	WASHING SYSTEM INLETS DISTRIBUTOR	1	PZ																																																																																					
VL1092A0	WASHING SYSTEM OUTLET DOUBLE DISTRIBUTOR	1	PZ																																																																																					
VL1102A1	DETERGENT LINE FILTER + BARBED VNR 6 MM	1	PZ																																																																																					
VL1128A0	BARBED CHECK VALVE D6	1	PZ																																																																																					
VL1128A1		1	PZ																																																																																					
VM2172A0	PUMP-WITH-CI RCUIT LOCKING PIN	1	PZ																																																																																					
Code	Description	Qty	UOM																																																																																					
0H2143A0		1	PZ																																																																																					
0H7820A0	PLUS WASHING SY SUPPORT WITH STEAM VALVE	1	PZ																																																																																					

COMPONENT			SPARE PART																																																																						
Code	Description	Image	Code	Description	Components list																																																																				
VL1019A	VIBRATION PUMP		KVL1104A	USA 1 ROTOR ARM PLUS CLEANING SYSTEM KIT	<table border="1"> <thead> <tr> <th>Code</th> <th>Description</th> <th>Qty</th> <th>UOM</th> </tr> </thead> <tbody> <tr> <td>EL1422A1</td> <td>1 WAY SOLENOID VALVE + D8-D10 REDUCTION</td> <td>1</td> <td>PZ</td> </tr> <tr> <td>EL1426A0</td> <td>H2O UL SOLENOID JG D8-PIPE HOLDER</td> <td>1</td> <td>PZ</td> </tr> <tr> <td>EL1426B0</td> <td>UL JG D8 WATER SLENOID VALVE-PIPE HOLDER</td> <td>1</td> <td>PZ</td> </tr> <tr> <td>EL1437A0</td> <td>H2O SOLENOID JG D6 UL CHECK VALVE</td> <td>1</td> <td>PZ</td> </tr> <tr> <td>EL1437B0</td> <td>JG D8 WATER SOLENOID VALVE -BARBED D6 V</td> <td>1</td> <td>PZ</td> </tr> <tr> <td>GN1526A0</td> <td>INT. D.=6.9 TH=1.8 O-RIN</td> <td>1</td> <td>PZ</td> </tr> <tr> <td>RC1019A0</td> <td>D=10 ELASTIC CLAMP</td> <td>12</td> <td>PZ</td> </tr> <tr> <td>RC1130A0</td> <td>130X2,6 CLAM</td> <td>1</td> <td>PZ</td> </tr> <tr> <td>RC1242A0</td> <td>D=10 CLOSED CAP</td> <td>2</td> <td>PZ</td> </tr> <tr> <td>RC1356A0</td> <td>STRAIGHT THREADED FEMALE END 8X1/4" BSP</td> <td>1</td> <td>PZ</td> </tr> <tr> <td>TB2820A0</td> <td>PIPE EPDM FOR WASHING SYSTEM</td> <td>1.410</td> <td>M</td> </tr> <tr> <td>VI1220A1</td> <td>4,2X12 TCB SELF-TAPPIN G SCREW</td> <td>3</td> <td>PZ</td> </tr> <tr> <td>VL1019A0</td> <td>VIBRATION PUMP</td> <td>1</td> <td>PZ</td> </tr> <tr> <td>VL1064A0</td> <td>WASHING SYSTEM OUTLETS DISTRIBUTOR</td> <td>1</td> <td>PZ</td> </tr> <tr> <td>VL1065A1</td> <td>1/4 MALE N.O. PRESSURE SWITCH</td> <td>1</td> <td>PZ</td> </tr> <tr> <td>VL1067A0</td> <td>WASHING SYSTEM INLETS DISTRIBUTOR</td> <td>1</td> <td>PZ</td> </tr> </tbody> </table>	Code	Description	Qty	UOM	EL1422A1	1 WAY SOLENOID VALVE + D8-D10 REDUCTION	1	PZ	EL1426A0	H2O UL SOLENOID JG D8-PIPE HOLDER	1	PZ	EL1426B0	UL JG D8 WATER SLENOID VALVE-PIPE HOLDER	1	PZ	EL1437A0	H2O SOLENOID JG D6 UL CHECK VALVE	1	PZ	EL1437B0	JG D8 WATER SOLENOID VALVE -BARBED D6 V	1	PZ	GN1526A0	INT. D.=6.9 TH=1.8 O-RIN	1	PZ	RC1019A0	D=10 ELASTIC CLAMP	12	PZ	RC1130A0	130X2,6 CLAM	1	PZ	RC1242A0	D=10 CLOSED CAP	2	PZ	RC1356A0	STRAIGHT THREADED FEMALE END 8X1/4" BSP	1	PZ	TB2820A0	PIPE EPDM FOR WASHING SYSTEM	1.410	M	VI1220A1	4,2X12 TCB SELF-TAPPIN G SCREW	3	PZ	VL1019A0	VIBRATION PUMP	1	PZ	VL1064A0	WASHING SYSTEM OUTLETS DISTRIBUTOR	1	PZ	VL1065A1	1/4 MALE N.O. PRESSURE SWITCH	1	PZ	VL1067A0	WASHING SYSTEM INLETS DISTRIBUTOR	1	PZ
Code	Description	Qty	UOM																																																																						
EL1422A1	1 WAY SOLENOID VALVE + D8-D10 REDUCTION	1	PZ																																																																						
EL1426A0	H2O UL SOLENOID JG D8-PIPE HOLDER	1	PZ																																																																						
EL1426B0	UL JG D8 WATER SLENOID VALVE-PIPE HOLDER	1	PZ																																																																						
EL1437A0	H2O SOLENOID JG D6 UL CHECK VALVE	1	PZ																																																																						
EL1437B0	JG D8 WATER SOLENOID VALVE -BARBED D6 V	1	PZ																																																																						
GN1526A0	INT. D.=6.9 TH=1.8 O-RIN	1	PZ																																																																						
RC1019A0	D=10 ELASTIC CLAMP	12	PZ																																																																						
RC1130A0	130X2,6 CLAM	1	PZ																																																																						
RC1242A0	D=10 CLOSED CAP	2	PZ																																																																						
RC1356A0	STRAIGHT THREADED FEMALE END 8X1/4" BSP	1	PZ																																																																						
TB2820A0	PIPE EPDM FOR WASHING SYSTEM	1.410	M																																																																						
VI1220A1	4,2X12 TCB SELF-TAPPIN G SCREW	3	PZ																																																																						
VL1019A0	VIBRATION PUMP	1	PZ																																																																						
VL1064A0	WASHING SYSTEM OUTLETS DISTRIBUTOR	1	PZ																																																																						
VL1065A1	1/4 MALE N.O. PRESSURE SWITCH	1	PZ																																																																						
VL1067A0	WASHING SYSTEM INLETS DISTRIBUTOR	1	PZ																																																																						

COMPONENT			SPARE PART																																																																			
Code	Description	Image	Code	Description	Components list																																																																	
VL1019A	VIBRATION PUMP		KVL1104A	USA 1 ROTOR ARM PLUS CLEANING SYSTEM KIT	<table border="1"> <thead> <tr> <th>Code</th> <th>Description</th> <th>Qty</th> <th>UOM</th> </tr> </thead> <tbody> <tr> <td>VL1102A1</td> <td>DETERGENT LINE FILTER + BARBED VNR 6 MM</td> <td>1</td> <td>PZ</td> </tr> <tr> <td>VL1128A0</td> <td>BARBED CHECK VALVE D6</td> <td>1</td> <td>PZ</td> </tr> <tr> <td>VL1128A1</td> <td></td> <td>1</td> <td>PZ</td> </tr> <tr> <td>VM2172A0</td> <td>PUMP-WITH-CI RCUIT LOCKING PIN</td> <td>1</td> <td>PZ</td> </tr> </tbody> </table>	Code	Description	Qty	UOM	VL1102A1	DETERGENT LINE FILTER + BARBED VNR 6 MM	1	PZ	VL1128A0	BARBED CHECK VALVE D6	1	PZ	VL1128A1		1	PZ	VM2172A0	PUMP-WITH-CI RCUIT LOCKING PIN	1	PZ																																													
			Code	Description	Qty	UOM																																																																
VL1102A1	DETERGENT LINE FILTER + BARBED VNR 6 MM	1	PZ																																																																			
VL1128A0	BARBED CHECK VALVE D6	1	PZ																																																																			
VL1128A1		1	PZ																																																																			
VM2172A0	PUMP-WITH-CI RCUIT LOCKING PIN	1	PZ																																																																			
KVL1103A	EUR 2 ROTOR ARMS PLUS CLEANING SYSTEM KIT	<table border="1"> <thead> <tr> <th>Code</th> <th>Description</th> <th>Qty</th> <th>UOM</th> </tr> </thead> <tbody> <tr> <td>0H2143A0</td> <td></td> <td>1</td> <td>PZ</td> </tr> <tr> <td>0H7820A0</td> <td>PLUS WASHING SY SUPPORT WITH STEAM VALVE</td> <td>1</td> <td>PZ</td> </tr> <tr> <td>EL1252A1</td> <td>1 WAY WATER VALVE + J.G. CONNECTION</td> <td>1</td> <td>PZ</td> </tr> <tr> <td>EL1424A0</td> <td>D8 CONNECTION WATER SOLENOID VALVE</td> <td>2</td> <td>PZ</td> </tr> <tr> <td>EL1424B0</td> <td></td> <td>2</td> <td>PZ</td> </tr> <tr> <td>EL1436A0</td> <td>H2O SOLENOID JG D8 CHECK VALVE</td> <td>1</td> <td>PZ</td> </tr> <tr> <td>EL1436B0</td> <td></td> <td>1</td> <td>PZ</td> </tr> <tr> <td>GN1526A0</td> <td>INT. D.=6.9 TH=1.8 O-RIN</td> <td>1</td> <td>PZ</td> </tr> <tr> <td>RC1019A0</td> <td>D=10 ELASTIC CLAMP</td> <td>12</td> <td>PZ</td> </tr> <tr> <td>RC1130A0</td> <td>130X2,6 CLAM</td> <td>1</td> <td>PZ</td> </tr> <tr> <td>RC1242A0</td> <td>D=10 CLOSED CAP</td> <td>2</td> <td>PZ</td> </tr> <tr> <td>RC1356A0</td> <td>STRAIGHT THREADED FEMALE END 8X1/4" BSP</td> <td>1</td> <td>PZ</td> </tr> <tr> <td>TB2820A0</td> <td>PIPE EPDM FOR WASHING SYSTEM</td> <td>1.410</td> <td>M</td> </tr> <tr> <td>VI1220A1</td> <td>4,2X12 TCB SELF-TAPPIN G SCREW</td> <td>3</td> <td>PZ</td> </tr> <tr> <td>VL1019A0</td> <td>VIBRATION PUMP</td> <td>1</td> <td>PZ</td> </tr> <tr> <td>VL1065A1</td> <td>1/4 MALE N.O. PRESSURE SWITCH</td> <td>1</td> <td>PZ</td> </tr> </tbody> </table>	Code	Description	Qty	UOM	0H2143A0		1	PZ	0H7820A0	PLUS WASHING SY SUPPORT WITH STEAM VALVE	1	PZ	EL1252A1	1 WAY WATER VALVE + J.G. CONNECTION	1	PZ	EL1424A0	D8 CONNECTION WATER SOLENOID VALVE	2	PZ	EL1424B0		2	PZ	EL1436A0	H2O SOLENOID JG D8 CHECK VALVE	1	PZ	EL1436B0		1	PZ	GN1526A0	INT. D.=6.9 TH=1.8 O-RIN	1	PZ	RC1019A0	D=10 ELASTIC CLAMP	12	PZ	RC1130A0	130X2,6 CLAM	1	PZ	RC1242A0	D=10 CLOSED CAP	2	PZ	RC1356A0	STRAIGHT THREADED FEMALE END 8X1/4" BSP	1	PZ	TB2820A0	PIPE EPDM FOR WASHING SYSTEM	1.410	M	VI1220A1	4,2X12 TCB SELF-TAPPIN G SCREW	3	PZ	VL1019A0	VIBRATION PUMP	1	PZ	VL1065A1	1/4 MALE N.O. PRESSURE SWITCH	1	PZ
Code	Description	Qty	UOM																																																																			
0H2143A0		1	PZ																																																																			
0H7820A0	PLUS WASHING SY SUPPORT WITH STEAM VALVE	1	PZ																																																																			
EL1252A1	1 WAY WATER VALVE + J.G. CONNECTION	1	PZ																																																																			
EL1424A0	D8 CONNECTION WATER SOLENOID VALVE	2	PZ																																																																			
EL1424B0		2	PZ																																																																			
EL1436A0	H2O SOLENOID JG D8 CHECK VALVE	1	PZ																																																																			
EL1436B0		1	PZ																																																																			
GN1526A0	INT. D.=6.9 TH=1.8 O-RIN	1	PZ																																																																			
RC1019A0	D=10 ELASTIC CLAMP	12	PZ																																																																			
RC1130A0	130X2,6 CLAM	1	PZ																																																																			
RC1242A0	D=10 CLOSED CAP	2	PZ																																																																			
RC1356A0	STRAIGHT THREADED FEMALE END 8X1/4" BSP	1	PZ																																																																			
TB2820A0	PIPE EPDM FOR WASHING SYSTEM	1.410	M																																																																			
VI1220A1	4,2X12 TCB SELF-TAPPIN G SCREW	3	PZ																																																																			
VL1019A0	VIBRATION PUMP	1	PZ																																																																			
VL1065A1	1/4 MALE N.O. PRESSURE SWITCH	1	PZ																																																																			

COMPONENT			SPARE PART																																																							
Code	Description	Image	Code	Description	Components list																																																					
VL1019A	VIBRATION PUMP		KVL1103A	EUR 2 ROTOR ARMS PLUS CLEANING SYSTEM KIT	<table border="1"> <thead> <tr> <th>Code</th> <th>Description</th> <th>Qty</th> <th>UOM</th> </tr> </thead> <tbody> <tr> <td>VL1067A0</td> <td>WASHING SYSTEM INLETS DISTRIBUTOR</td> <td>1</td> <td>PZ</td> </tr> <tr> <td>VL1092A0</td> <td>WASHING SYSTEM OUTLET DOUBLE DISTRIBUTOR</td> <td>1</td> <td>PZ</td> </tr> <tr> <td>VL1102A1</td> <td>DETERGENT LINE FILTER + BARBED VNR 6 MM</td> <td>1</td> <td>PZ</td> </tr> <tr> <td>VL1128A0</td> <td>BARBED CHECK VALVE D6</td> <td>1</td> <td>PZ</td> </tr> <tr> <td>VL1128A1</td> <td></td> <td>1</td> <td>PZ</td> </tr> <tr> <td>VM2172A0</td> <td>PUMP-WITH-CI RCUIT LOCKING PIN</td> <td>1</td> <td>PZ</td> </tr> </tbody> </table>	Code	Description	Qty	UOM	VL1067A0	WASHING SYSTEM INLETS DISTRIBUTOR	1	PZ	VL1092A0	WASHING SYSTEM OUTLET DOUBLE DISTRIBUTOR	1	PZ	VL1102A1	DETERGENT LINE FILTER + BARBED VNR 6 MM	1	PZ	VL1128A0	BARBED CHECK VALVE D6	1	PZ	VL1128A1		1	PZ	VM2172A0	PUMP-WITH-CI RCUIT LOCKING PIN	1	PZ																									
			Code	Description	Qty	UOM																																																				
VL1067A0	WASHING SYSTEM INLETS DISTRIBUTOR	1	PZ																																																							
VL1092A0	WASHING SYSTEM OUTLET DOUBLE DISTRIBUTOR	1	PZ																																																							
VL1102A1	DETERGENT LINE FILTER + BARBED VNR 6 MM	1	PZ																																																							
VL1128A0	BARBED CHECK VALVE D6	1	PZ																																																							
VL1128A1		1	PZ																																																							
VM2172A0	PUMP-WITH-CI RCUIT LOCKING PIN	1	PZ																																																							
KVL1101A	EUR 1 ROTOR ARM PLUS CLEANING SYSTEM KIT	<table border="1"> <thead> <tr> <th>Code</th> <th>Description</th> <th>Qty</th> <th>UOM</th> </tr> </thead> <tbody> <tr> <td>0H2143A0</td> <td></td> <td>1</td> <td>PZ</td> </tr> <tr> <td>0H7820A0</td> <td>PLUS WASHING SY SUPPORT WITH STEAM VALVE</td> <td>1</td> <td>PZ</td> </tr> <tr> <td>EL1252A1</td> <td>1 WAY WATER VALVE + J.G. CONNECTION</td> <td>1</td> <td>PZ</td> </tr> <tr> <td>EL1424A0</td> <td>D8 CONNECTION WATER SOLENOID VALVE</td> <td>1</td> <td>PZ</td> </tr> <tr> <td>EL1424B0</td> <td></td> <td>1</td> <td>PZ</td> </tr> <tr> <td>EL1436A0</td> <td>H2O SOLENOID JG D8 CHECK VALVE</td> <td>1</td> <td>PZ</td> </tr> <tr> <td>EL1436B0</td> <td></td> <td>1</td> <td>PZ</td> </tr> <tr> <td>GN1526A0</td> <td>INT. D.=6.9 TH=1.8 O-RIN</td> <td>1</td> <td>PZ</td> </tr> <tr> <td>RC1019A0</td> <td>D=10 ELASTIC CLAMP</td> <td>12</td> <td>PZ</td> </tr> <tr> <td>RC1130A0</td> <td>130X2,6 CLAM</td> <td>1</td> <td>PZ</td> </tr> <tr> <td>RC1242A0</td> <td>D=10 CLOSED CAP</td> <td>2</td> <td>PZ</td> </tr> <tr> <td>RC1356A0</td> <td>STRAIGHT THREADED FEMALE END 8X1/4" BSP</td> <td>1</td> <td>PZ</td> </tr> <tr> <td>TB2820A0</td> <td>PIPE EPDM FOR WASHING SYSTEM</td> <td>1.410</td> <td>M</td> </tr> </tbody> </table>	Code	Description	Qty	UOM	0H2143A0		1	PZ	0H7820A0	PLUS WASHING SY SUPPORT WITH STEAM VALVE	1	PZ	EL1252A1	1 WAY WATER VALVE + J.G. CONNECTION	1	PZ	EL1424A0	D8 CONNECTION WATER SOLENOID VALVE	1	PZ	EL1424B0		1	PZ	EL1436A0	H2O SOLENOID JG D8 CHECK VALVE	1	PZ	EL1436B0		1	PZ	GN1526A0	INT. D.=6.9 TH=1.8 O-RIN	1	PZ	RC1019A0	D=10 ELASTIC CLAMP	12	PZ	RC1130A0	130X2,6 CLAM	1	PZ	RC1242A0	D=10 CLOSED CAP	2	PZ	RC1356A0	STRAIGHT THREADED FEMALE END 8X1/4" BSP	1	PZ	TB2820A0	PIPE EPDM FOR WASHING SYSTEM	1.410	M
Code	Description	Qty	UOM																																																							
0H2143A0		1	PZ																																																							
0H7820A0	PLUS WASHING SY SUPPORT WITH STEAM VALVE	1	PZ																																																							
EL1252A1	1 WAY WATER VALVE + J.G. CONNECTION	1	PZ																																																							
EL1424A0	D8 CONNECTION WATER SOLENOID VALVE	1	PZ																																																							
EL1424B0		1	PZ																																																							
EL1436A0	H2O SOLENOID JG D8 CHECK VALVE	1	PZ																																																							
EL1436B0		1	PZ																																																							
GN1526A0	INT. D.=6.9 TH=1.8 O-RIN	1	PZ																																																							
RC1019A0	D=10 ELASTIC CLAMP	12	PZ																																																							
RC1130A0	130X2,6 CLAM	1	PZ																																																							
RC1242A0	D=10 CLOSED CAP	2	PZ																																																							
RC1356A0	STRAIGHT THREADED FEMALE END 8X1/4" BSP	1	PZ																																																							
TB2820A0	PIPE EPDM FOR WASHING SYSTEM	1.410	M																																																							







COMPONENT			SPARE PART																																										
Code	Description	Image	Code	Description	Components list																																								
VL1019A	VIBRATION PUMP		KVL1101A	EUR 1 ROTOR ARM PLUS CLEANING SYSTEM KIT	<table border="1"> <thead> <tr> <th>Code</th> <th>Description</th> <th>Qty</th> <th>UOM</th> </tr> </thead> <tbody> <tr> <td>VI1220A1</td> <td>4,2X12 TCB SELF-TAPPIN G SCREW</td> <td>3</td> <td>PZ</td> </tr> <tr> <td>VL1019A0</td> <td>VIBRATION PUMP</td> <td>1</td> <td>PZ</td> </tr> <tr> <td>VL1064A0</td> <td>WASHING SYSTEM OUTLETS DISTRIBUTOR</td> <td>1</td> <td>PZ</td> </tr> <tr> <td>VL1065A1</td> <td>1/4 MALE N.O. PRESSURE SWITCH</td> <td>1</td> <td>PZ</td> </tr> <tr> <td>VL1067A0</td> <td>WASHING SYSTEM INLETS DISTRIBUTOR</td> <td>1</td> <td>PZ</td> </tr> <tr> <td>VL1102A1</td> <td>DETERGENT LINE FILTER + BARBED VNR 6 MM</td> <td>1</td> <td>PZ</td> </tr> <tr> <td>VL1128A0</td> <td>BARBED CHECK VALVE D6</td> <td>1</td> <td>PZ</td> </tr> <tr> <td>VL1128A1</td> <td></td> <td>1</td> <td>PZ</td> </tr> <tr> <td>VM2172A0</td> <td>PUMP-WITH-RCUIT LOCKING PIN</td> <td>1</td> <td>PZ</td> </tr> </tbody> </table>	Code	Description	Qty	UOM	VI1220A1	4,2X12 TCB SELF-TAPPIN G SCREW	3	PZ	VL1019A0	VIBRATION PUMP	1	PZ	VL1064A0	WASHING SYSTEM OUTLETS DISTRIBUTOR	1	PZ	VL1065A1	1/4 MALE N.O. PRESSURE SWITCH	1	PZ	VL1067A0	WASHING SYSTEM INLETS DISTRIBUTOR	1	PZ	VL1102A1	DETERGENT LINE FILTER + BARBED VNR 6 MM	1	PZ	VL1128A0	BARBED CHECK VALVE D6	1	PZ	VL1128A1		1	PZ	VM2172A0	PUMP-WITH-RCUIT LOCKING PIN	1	PZ
			Code	Description	Qty	UOM																																							
VI1220A1	4,2X12 TCB SELF-TAPPIN G SCREW	3	PZ																																										
VL1019A0	VIBRATION PUMP	1	PZ																																										
VL1064A0	WASHING SYSTEM OUTLETS DISTRIBUTOR	1	PZ																																										
VL1065A1	1/4 MALE N.O. PRESSURE SWITCH	1	PZ																																										
VL1067A0	WASHING SYSTEM INLETS DISTRIBUTOR	1	PZ																																										
VL1102A1	DETERGENT LINE FILTER + BARBED VNR 6 MM	1	PZ																																										
VL1128A0	BARBED CHECK VALVE D6	1	PZ																																										
VL1128A1		1	PZ																																										
VM2172A0	PUMP-WITH-RCUIT LOCKING PIN	1	PZ																																										
KVL1094A	0311 EUR CLEANING SYSTEM KIT	<table border="1"> <thead> <tr> <th>Code</th> <th>Description</th> <th>Qty</th> <th>UOM</th> </tr> </thead> <tbody> <tr> <td>0H2143A0</td> <td></td> <td>1</td> <td>PZ</td> </tr> <tr> <td>0H7494B0</td> <td>ONE-03 WASHING SYST HOLDING PLATE</td> <td>1</td> <td>PZ</td> </tr> <tr> <td>EL1436A0</td> <td>H2O SOLENOID JG D8 CHECK VALVE</td> <td>1</td> <td>PZ</td> </tr> <tr> <td>EL1436B0</td> <td></td> <td>1</td> <td>PZ</td> </tr> <tr> <td>GN1526A0</td> <td>INT. D.=6.9 TH=1.8 O-RIN</td> <td>1</td> <td>PZ</td> </tr> <tr> <td>RC1242A0</td> <td>D=10 CLOSED CAP</td> <td>2</td> <td>PZ</td> </tr> <tr> <td>TB2820A0</td> <td>PIPE EPDM FOR WASHING SYSTEM</td> <td>1.420</td> <td>M</td> </tr> <tr> <td>VI1220A1</td> <td>4,2X12 TCB SELF-TAPPIN G SCREW</td> <td>1</td> <td>PZ</td> </tr> <tr> <td>VL1019A0</td> <td>VIBRATION PUMP</td> <td>1</td> <td>PZ</td> </tr> </tbody> </table>	Code	Description	Qty	UOM	0H2143A0		1	PZ	0H7494B0	ONE-03 WASHING SYST HOLDING PLATE	1	PZ	EL1436A0	H2O SOLENOID JG D8 CHECK VALVE	1	PZ	EL1436B0		1	PZ	GN1526A0	INT. D.=6.9 TH=1.8 O-RIN	1	PZ	RC1242A0	D=10 CLOSED CAP	2	PZ	TB2820A0	PIPE EPDM FOR WASHING SYSTEM	1.420	M	VI1220A1	4,2X12 TCB SELF-TAPPIN G SCREW	1	PZ	VL1019A0	VIBRATION PUMP	1	PZ			
Code	Description	Qty	UOM																																										
0H2143A0		1	PZ																																										
0H7494B0	ONE-03 WASHING SYST HOLDING PLATE	1	PZ																																										
EL1436A0	H2O SOLENOID JG D8 CHECK VALVE	1	PZ																																										
EL1436B0		1	PZ																																										
GN1526A0	INT. D.=6.9 TH=1.8 O-RIN	1	PZ																																										
RC1242A0	D=10 CLOSED CAP	2	PZ																																										
TB2820A0	PIPE EPDM FOR WASHING SYSTEM	1.420	M																																										
VI1220A1	4,2X12 TCB SELF-TAPPIN G SCREW	1	PZ																																										
VL1019A0	VIBRATION PUMP	1	PZ																																										





COMPONENT			SPARE PART																																																			
Code	Description	Image	Code	Description	Components list																																																	
VL1019A	VIBRATION PUMP		KVL1094A	0311 EUR CLEANING SYSTEM KIT	<table border="1"> <thead> <tr> <th>Code</th> <th>Description</th> <th>Qty</th> <th>UOM</th> </tr> </thead> <tbody> <tr> <td>VL1053B0</td> <td>ONE WASHING SYS EXT DISTRIBUTOR</td> <td>1</td> <td>PZ</td> </tr> <tr> <td>VL1054B0</td> <td>ONE WASHING SYS INLET DISTRIBUTOR</td> <td>1</td> <td>PZ</td> </tr> <tr> <td>VL1102A1</td> <td>DETERGENT LINE FILTER + BARBED VNR 6 MM</td> <td>1</td> <td>PZ</td> </tr> <tr> <td>VL1128A0</td> <td>BARBED CHECK VALVE D6</td> <td>1</td> <td>PZ</td> </tr> <tr> <td>VL1128A1</td> <td></td> <td>1</td> <td>PZ</td> </tr> <tr> <td>VM2172A0</td> <td>PUMP-WITH-CI RCUIT LOCKING PIN</td> <td>1</td> <td>PZ</td> </tr> </tbody> </table>	Code	Description	Qty	UOM	VL1053B0	ONE WASHING SYS EXT DISTRIBUTOR	1	PZ	VL1054B0	ONE WASHING SYS INLET DISTRIBUTOR	1	PZ	VL1102A1	DETERGENT LINE FILTER + BARBED VNR 6 MM	1	PZ	VL1128A0	BARBED CHECK VALVE D6	1	PZ	VL1128A1		1	PZ	VM2172A0	PUMP-WITH-CI RCUIT LOCKING PIN	1	PZ																					
			Code	Description	Qty	UOM																																																
VL1053B0	ONE WASHING SYS EXT DISTRIBUTOR	1	PZ																																																			
VL1054B0	ONE WASHING SYS INLET DISTRIBUTOR	1	PZ																																																			
VL1102A1	DETERGENT LINE FILTER + BARBED VNR 6 MM	1	PZ																																																			
VL1128A0	BARBED CHECK VALVE D6	1	PZ																																																			
VL1128A1		1	PZ																																																			
VM2172A0	PUMP-WITH-CI RCUIT LOCKING PIN	1	PZ																																																			
KVL1092A	EUR 2 ROTOR ARMS PLUS CHEMICAL PUMP KIT	<table border="1"> <thead> <tr> <th>Code</th> <th>Description</th> <th>Qty</th> <th>UOM</th> </tr> </thead> <tbody> <tr> <td>0H2143A0</td> <td></td> <td>1</td> <td>PZ</td> </tr> <tr> <td>GN1526A0</td> <td>INT. D.=6.9 TH=1.8 O-RIN</td> <td>1</td> <td>PZ</td> </tr> <tr> <td>RC1019A0</td> <td>D=10 ELASTIC CLAMP</td> <td>6</td> <td>PZ</td> </tr> <tr> <td>RC1130A0</td> <td>130X2,6 CLAM</td> <td>1</td> <td>PZ</td> </tr> <tr> <td>RC1242A0</td> <td>D=10 CLOSED CAP</td> <td>2</td> <td>PZ</td> </tr> <tr> <td>TB2820A0</td> <td>PIPE EPDM FOR WASHING SYSTEM</td> <td>0.120</td> <td>M</td> </tr> <tr> <td>VL1019A0</td> <td>VIBRATION PUMP</td> <td>1</td> <td>PZ</td> </tr> <tr> <td>VL1067A0</td> <td>WASHING SYSTEM INLETS DISTRIBUTOR</td> <td>1</td> <td>PZ</td> </tr> <tr> <td>VL1092A0</td> <td>WASHING SYSTEM OUTLET DOUBLE DISTRIBUTOR</td> <td>1</td> <td>PZ</td> </tr> <tr> <td>VL1128A0</td> <td>BARBED CHECK VALVE D6</td> <td>1</td> <td>PZ</td> </tr> <tr> <td>VL1128A1</td> <td></td> <td>1</td> <td>PZ</td> </tr> <tr> <td>VM2172A0</td> <td>PUMP-WITH-CI RCUIT LOCKING PIN</td> <td>1</td> <td>PZ</td> </tr> </tbody> </table>	Code	Description	Qty	UOM	0H2143A0		1	PZ	GN1526A0	INT. D.=6.9 TH=1.8 O-RIN	1	PZ	RC1019A0	D=10 ELASTIC CLAMP	6	PZ	RC1130A0	130X2,6 CLAM	1	PZ	RC1242A0	D=10 CLOSED CAP	2	PZ	TB2820A0	PIPE EPDM FOR WASHING SYSTEM	0.120	M	VL1019A0	VIBRATION PUMP	1	PZ	VL1067A0	WASHING SYSTEM INLETS DISTRIBUTOR	1	PZ	VL1092A0	WASHING SYSTEM OUTLET DOUBLE DISTRIBUTOR	1	PZ	VL1128A0	BARBED CHECK VALVE D6	1	PZ	VL1128A1		1	PZ	VM2172A0	PUMP-WITH-CI RCUIT LOCKING PIN	1	PZ
Code	Description	Qty	UOM																																																			
0H2143A0		1	PZ																																																			
GN1526A0	INT. D.=6.9 TH=1.8 O-RIN	1	PZ																																																			
RC1019A0	D=10 ELASTIC CLAMP	6	PZ																																																			
RC1130A0	130X2,6 CLAM	1	PZ																																																			
RC1242A0	D=10 CLOSED CAP	2	PZ																																																			
TB2820A0	PIPE EPDM FOR WASHING SYSTEM	0.120	M																																																			
VL1019A0	VIBRATION PUMP	1	PZ																																																			
VL1067A0	WASHING SYSTEM INLETS DISTRIBUTOR	1	PZ																																																			
VL1092A0	WASHING SYSTEM OUTLET DOUBLE DISTRIBUTOR	1	PZ																																																			
VL1128A0	BARBED CHECK VALVE D6	1	PZ																																																			
VL1128A1		1	PZ																																																			
VM2172A0	PUMP-WITH-CI RCUIT LOCKING PIN	1	PZ																																																			

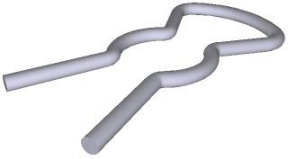
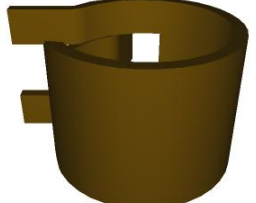
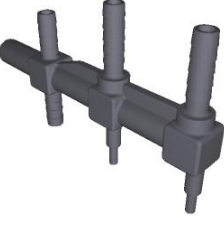





COMPONENT			SPARE PART																																																						
Code	Description	Image	Code	Description	Components list																																																				
VL1019A	VIBRATION PUMP		KVL1073A	EUR 1 ROTOR ARM PLUS CHEMICAL PUMP KIT	<table border="1"> <thead> <tr> <th>Code</th> <th>Description</th> <th>Qty</th> <th>UOM</th> </tr> </thead> <tbody> <tr> <td>0H2143A0</td> <td></td> <td>1</td> <td>PZ</td> </tr> <tr> <td>GN1526A0</td> <td>INT. D.=6.9 TH=1.8 O-RIN</td> <td>1</td> <td>PZ</td> </tr> <tr> <td>RC1019A0</td> <td>D=10 ELASTIC CLAMP</td> <td>6</td> <td>PZ</td> </tr> <tr> <td>RC1130A0</td> <td>130X2,6 CLAM</td> <td>1</td> <td>PZ</td> </tr> <tr> <td>RC1242A0</td> <td>D=10 CLOSED CAP</td> <td>2</td> <td>PZ</td> </tr> <tr> <td>TB2820A0</td> <td>PIPE EPDM FOR WASHING SYSTEM</td> <td>0.120</td> <td>M</td> </tr> <tr> <td>VL1019A0</td> <td>VIBRATION PUMP</td> <td>1</td> <td>PZ</td> </tr> <tr> <td>VL1064A0</td> <td>WASHING SYSTEM OUTLETS DISTRIBUTOR</td> <td>1</td> <td>PZ</td> </tr> <tr> <td>VL1067A0</td> <td>WASHING SYSTEM INLETS DISTRIBUTOR</td> <td>1</td> <td>PZ</td> </tr> <tr> <td>VL1128A0</td> <td>BARBED CHECK VALVE D6</td> <td>1</td> <td>PZ</td> </tr> <tr> <td>VL1128A1</td> <td></td> <td>1</td> <td>PZ</td> </tr> <tr> <td>VM2172A0</td> <td>PUMP-WITH-CI RCUIT LOCKING PIN</td> <td>1</td> <td>PZ</td> </tr> </tbody> </table>	Code	Description	Qty	UOM	0H2143A0		1	PZ	GN1526A0	INT. D.=6.9 TH=1.8 O-RIN	1	PZ	RC1019A0	D=10 ELASTIC CLAMP	6	PZ	RC1130A0	130X2,6 CLAM	1	PZ	RC1242A0	D=10 CLOSED CAP	2	PZ	TB2820A0	PIPE EPDM FOR WASHING SYSTEM	0.120	M	VL1019A0	VIBRATION PUMP	1	PZ	VL1064A0	WASHING SYSTEM OUTLETS DISTRIBUTOR	1	PZ	VL1067A0	WASHING SYSTEM INLETS DISTRIBUTOR	1	PZ	VL1128A0	BARBED CHECK VALVE D6	1	PZ	VL1128A1		1	PZ	VM2172A0	PUMP-WITH-CI RCUIT LOCKING PIN	1	PZ
			Code	Description	Qty	UOM																																																			
0H2143A0		1	PZ																																																						
GN1526A0	INT. D.=6.9 TH=1.8 O-RIN	1	PZ																																																						
RC1019A0	D=10 ELASTIC CLAMP	6	PZ																																																						
RC1130A0	130X2,6 CLAM	1	PZ																																																						
RC1242A0	D=10 CLOSED CAP	2	PZ																																																						
TB2820A0	PIPE EPDM FOR WASHING SYSTEM	0.120	M																																																						
VL1019A0	VIBRATION PUMP	1	PZ																																																						
VL1064A0	WASHING SYSTEM OUTLETS DISTRIBUTOR	1	PZ																																																						
VL1067A0	WASHING SYSTEM INLETS DISTRIBUTOR	1	PZ																																																						
VL1128A0	BARBED CHECK VALVE D6	1	PZ																																																						
VL1128A1		1	PZ																																																						
VM2172A0	PUMP-WITH-CI RCUIT LOCKING PIN	1	PZ																																																						
KVL1072A	ONE SERIES AND HOODS CHEMICAL PUMP KIT	<table border="1"> <thead> <tr> <th>Code</th> <th>Description</th> <th>Qty</th> <th>UOM</th> </tr> </thead> <tbody> <tr> <td>0H2143A0</td> <td></td> <td>1</td> <td>PZ</td> </tr> <tr> <td>GN1526A0</td> <td>INT. D.=6.9 TH=1.8 O-RIN</td> <td>1</td> <td>PZ</td> </tr> <tr> <td>RC1019A0</td> <td>D=10 ELASTIC CLAMP</td> <td>6</td> <td>PZ</td> </tr> <tr> <td>RC1242A0</td> <td>D=10 CLOSED CAP</td> <td>2</td> <td>PZ</td> </tr> <tr> <td>TB2820A0</td> <td>PIPE EPDM FOR WASHING SYSTEM</td> <td>0.120</td> <td>M</td> </tr> <tr> <td>VH1220A1</td> <td>4,2X12 TCB SELF-TAPPIN G SCREW</td> <td>1</td> <td>PZ</td> </tr> <tr> <td>VL1019A0</td> <td>VIBRATION PUMP</td> <td>1</td> <td>PZ</td> </tr> <tr> <td>VL1053B0</td> <td>ONE WASHING SYS EXT DISTRIBUTOR</td> <td>1</td> <td>PZ</td> </tr> <tr> <td>VL1054B0</td> <td>ONE WASHING SYS INLET DISTRIBUTOR</td> <td>1</td> <td>PZ</td> </tr> <tr> <td>VL1128A0</td> <td>BARBED CHECK VALVE D6</td> <td>1</td> <td>PZ</td> </tr> </tbody> </table>	Code	Description	Qty	UOM	0H2143A0		1	PZ	GN1526A0	INT. D.=6.9 TH=1.8 O-RIN	1	PZ	RC1019A0	D=10 ELASTIC CLAMP	6	PZ	RC1242A0	D=10 CLOSED CAP	2	PZ	TB2820A0	PIPE EPDM FOR WASHING SYSTEM	0.120	M	VH1220A1	4,2X12 TCB SELF-TAPPIN G SCREW	1	PZ	VL1019A0	VIBRATION PUMP	1	PZ	VL1053B0	ONE WASHING SYS EXT DISTRIBUTOR	1	PZ	VL1054B0	ONE WASHING SYS INLET DISTRIBUTOR	1	PZ	VL1128A0	BARBED CHECK VALVE D6	1	PZ											
Code	Description	Qty	UOM																																																						
0H2143A0		1	PZ																																																						
GN1526A0	INT. D.=6.9 TH=1.8 O-RIN	1	PZ																																																						
RC1019A0	D=10 ELASTIC CLAMP	6	PZ																																																						
RC1242A0	D=10 CLOSED CAP	2	PZ																																																						
TB2820A0	PIPE EPDM FOR WASHING SYSTEM	0.120	M																																																						
VH1220A1	4,2X12 TCB SELF-TAPPIN G SCREW	1	PZ																																																						
VL1019A0	VIBRATION PUMP	1	PZ																																																						
VL1053B0	ONE WASHING SYS EXT DISTRIBUTOR	1	PZ																																																						
VL1054B0	ONE WASHING SYS INLET DISTRIBUTOR	1	PZ																																																						
VL1128A0	BARBED CHECK VALVE D6	1	PZ																																																						

COMPONENT			SPARE PART																																																																											
Code	Description	Image	Code	Description	Components list																																																																									
VL1019A	VIBRATION PUMP		KVL1072A	ONE SERIES AND HOODS CHEMICAL PUMP KIT	<table border="1"> <thead> <tr> <th>Code</th> <th>Description</th> <th>Qty</th> <th>UOM</th> </tr> </thead> <tbody> <tr> <td>VL1128A1</td> <td></td> <td>1</td> <td>PZ</td> </tr> <tr> <td>VM2172A0</td> <td>PUMP-WITH-CI RCUIT LOCKING PIN</td> <td>1</td> <td>PZ</td> </tr> </tbody> </table>	Code	Description	Qty	UOM	VL1128A1		1	PZ	VM2172A0	PUMP-WITH-CI RCUIT LOCKING PIN	1	PZ																																																													
			Code	Description	Qty	UOM																																																																								
VL1128A1		1	PZ																																																																											
VM2172A0	PUMP-WITH-CI RCUIT LOCKING PIN	1	PZ																																																																											
KVL0001A	LM TOP CLEANING SYSTEM KIT	<table border="1"> <thead> <tr> <th>Code</th> <th>Description</th> <th>Qty</th> <th>UOM</th> </tr> </thead> <tbody> <tr> <td>0H1226B0</td> <td>LINEMISSTOP WASHING SYTEM CIRCUIT COVE</td> <td>1</td> <td>PZ</td> </tr> <tr> <td>0H2143A0</td> <td></td> <td>2</td> <td>PZ</td> </tr> <tr> <td>GN1312A0</td> <td>RUBBER CABLE-PASSI NG DE=26 DI=15 SP=10</td> <td>1</td> <td>PZ</td> </tr> <tr> <td>GN1526A0</td> <td>INT. D.=6.9 TH=1.8 O-RIN</td> <td>1</td> <td>PZ</td> </tr> <tr> <td>RC1019A0</td> <td>D=10 ELASTIC CLAMP</td> <td>5</td> <td>PZ</td> </tr> <tr> <td>RC1242A0</td> <td>D=10 CLOSED CAP</td> <td>2</td> <td>PZ</td> </tr> <tr> <td>RC1381A0</td> <td>BIFILAR PIPE CLIP D10.7</td> <td>3</td> <td>PZ</td> </tr> <tr> <td>TB2343A0</td> <td>9X6 PVC TRANSPAREN T PIPE</td> <td>1.650</td> <td>M</td> </tr> <tr> <td>TB2820A0</td> <td>PIPE EPDM FOR WASHING SYSTEM</td> <td>0.990</td> <td>M</td> </tr> <tr> <td>VI1220A1</td> <td>4,2X12 TCB SELF-TAPPIN G SCREW</td> <td>1</td> <td>PZ</td> </tr> <tr> <td>VL1019A0</td> <td>VIBRATION PUMP</td> <td>1</td> <td>PZ</td> </tr> <tr> <td>VL1041C0</td> <td>DETERGENT CAP WITH Ø12 HOLE</td> <td>1</td> <td>PZ</td> </tr> <tr> <td>VL1047A1</td> <td>D6 PIPE HOLDER - D8 J.G. TERMINAL</td> <td>1</td> <td>PZ</td> </tr> <tr> <td>VL1053B0</td> <td>ONE WASHING SYS EXT DISTRIBUTOR</td> <td>1</td> <td>PZ</td> </tr> <tr> <td>VL1054B0</td> <td>ONE WASHING SYS INLET DISTRIBUTOR</td> <td>1</td> <td>PZ</td> </tr> <tr> <td>VL1061A0</td> <td>HOLD DOWN WEIGHT+NET FILTER+NON-RET. V.</td> <td>1</td> <td>PZ</td> </tr> <tr> <td>VL1128A0</td> <td>BARBED CHECK VALVE D6</td> <td>2</td> <td>PZ</td> </tr> <tr> <td>VL1128A1</td> <td></td> <td>2</td> <td>PZ</td> </tr> </tbody> </table>	Code	Description	Qty	UOM	0H1226B0	LINEMISSTOP WASHING SYTEM CIRCUIT COVE	1	PZ	0H2143A0		2	PZ	GN1312A0	RUBBER CABLE-PASSI NG DE=26 DI=15 SP=10	1	PZ	GN1526A0	INT. D.=6.9 TH=1.8 O-RIN	1	PZ	RC1019A0	D=10 ELASTIC CLAMP	5	PZ	RC1242A0	D=10 CLOSED CAP	2	PZ	RC1381A0	BIFILAR PIPE CLIP D10.7	3	PZ	TB2343A0	9X6 PVC TRANSPAREN T PIPE	1.650	M	TB2820A0	PIPE EPDM FOR WASHING SYSTEM	0.990	M	VI1220A1	4,2X12 TCB SELF-TAPPIN G SCREW	1	PZ	VL1019A0	VIBRATION PUMP	1	PZ	VL1041C0	DETERGENT CAP WITH Ø12 HOLE	1	PZ	VL1047A1	D6 PIPE HOLDER - D8 J.G. TERMINAL	1	PZ	VL1053B0	ONE WASHING SYS EXT DISTRIBUTOR	1	PZ	VL1054B0	ONE WASHING SYS INLET DISTRIBUTOR	1	PZ	VL1061A0	HOLD DOWN WEIGHT+NET FILTER+NON-RET. V.	1	PZ	VL1128A0	BARBED CHECK VALVE D6	2	PZ	VL1128A1		2	PZ
Code	Description	Qty	UOM																																																																											
0H1226B0	LINEMISSTOP WASHING SYTEM CIRCUIT COVE	1	PZ																																																																											
0H2143A0		2	PZ																																																																											
GN1312A0	RUBBER CABLE-PASSI NG DE=26 DI=15 SP=10	1	PZ																																																																											
GN1526A0	INT. D.=6.9 TH=1.8 O-RIN	1	PZ																																																																											
RC1019A0	D=10 ELASTIC CLAMP	5	PZ																																																																											
RC1242A0	D=10 CLOSED CAP	2	PZ																																																																											
RC1381A0	BIFILAR PIPE CLIP D10.7	3	PZ																																																																											
TB2343A0	9X6 PVC TRANSPAREN T PIPE	1.650	M																																																																											
TB2820A0	PIPE EPDM FOR WASHING SYSTEM	0.990	M																																																																											
VI1220A1	4,2X12 TCB SELF-TAPPIN G SCREW	1	PZ																																																																											
VL1019A0	VIBRATION PUMP	1	PZ																																																																											
VL1041C0	DETERGENT CAP WITH Ø12 HOLE	1	PZ																																																																											
VL1047A1	D6 PIPE HOLDER - D8 J.G. TERMINAL	1	PZ																																																																											
VL1053B0	ONE WASHING SYS EXT DISTRIBUTOR	1	PZ																																																																											
VL1054B0	ONE WASHING SYS INLET DISTRIBUTOR	1	PZ																																																																											
VL1061A0	HOLD DOWN WEIGHT+NET FILTER+NON-RET. V.	1	PZ																																																																											
VL1128A0	BARBED CHECK VALVE D6	2	PZ																																																																											
VL1128A1		2	PZ																																																																											

COMPONENT			SPARE PART																										
Code	Description	Image	Code	Description	Components list																								
VL1019A	VIBRATION PUMP		KVL0001A	LM TOP CLEANING SYSTEM KIT	<table border="1"> <thead> <tr> <th>Code</th> <th>Description</th> <th>Qty</th> <th>UOM</th> </tr> </thead> <tbody> <tr> <td>VM1066A0</td> <td>SADDLE CLIP FOR CABLES PASSING</td> <td>3</td> <td>PZ</td> </tr> <tr> <td>VM1088A0</td> <td>NYLON CLICK CLAMP D7.9-D9.2</td> <td>1</td> <td>PZ</td> </tr> <tr> <td>VM1605A0</td> <td>CLIP TWIST LOCK DIAM. 10.2-12.7 MM</td> <td>1</td> <td>PZ</td> </tr> <tr> <td>VM2172A0</td> <td>PUMP-WITH-CIRCUIT LOCKING PIN</td> <td>1</td> <td>PZ</td> </tr> </tbody> </table>	Code	Description	Qty	UOM	VM1066A0	SADDLE CLIP FOR CABLES PASSING	3	PZ	VM1088A0	NYLON CLICK CLAMP D7.9-D9.2	1	PZ	VM1605A0	CLIP TWIST LOCK DIAM. 10.2-12.7 MM	1	PZ	VM2172A0	PUMP-WITH-CIRCUIT LOCKING PIN	1	PZ				
Code	Description	Qty	UOM																										
VM1066A0	SADDLE CLIP FOR CABLES PASSING	3	PZ																										
VM1088A0	NYLON CLICK CLAMP D7.9-D9.2	1	PZ																										
VM1605A0	CLIP TWIST LOCK DIAM. 10.2-12.7 MM	1	PZ																										
VM2172A0	PUMP-WITH-CIRCUIT LOCKING PIN	1	PZ																										
VM2172A	PUMP-WITH-CIRCUIT LOCKING PIN		VM2172A0	PUMP-WITH-CIRCUIT LOCKING PIN																									
RC1019A	D=10 ELASTIC CLAMP		KRC1019A	Ø10 ZINC PLATED ELASTIC CLAMP 15 PCS KIT	<table border="1"> <thead> <tr> <th>Code</th> <th>Description</th> <th>Qty</th> <th>UOM</th> </tr> </thead> <tbody> <tr> <td>RC1019A0</td> <td>D=10 ELASTIC CLAMP</td> <td>17</td> <td>PZ</td> </tr> <tr> <td>VM1224A0</td> <td></td> <td>0.200</td> <td>M</td> </tr> </tbody> </table>	Code	Description	Qty	UOM	RC1019A0	D=10 ELASTIC CLAMP	17	PZ	VM1224A0		0.200	M												
Code	Description	Qty	UOM																										
RC1019A0	D=10 ELASTIC CLAMP	17	PZ																										
VM1224A0		0.200	M																										
VL1054B	ONE WASHING SYS INLET DISTRIBUTOR		KVL1054B	ONE WASHING SYST INLETS DISTRIBUTOR KIT	<table border="1"> <thead> <tr> <th>Code</th> <th>Description</th> <th>Qty</th> <th>UOM</th> </tr> </thead> <tbody> <tr> <td>VL1054B0</td> <td>ONE WASHING SYS INLET DISTRIBUTOR</td> <td>1</td> <td>PZ</td> </tr> <tr> <td>VM1224A0</td> <td></td> <td>0.250</td> <td>M</td> </tr> </tbody> </table>	Code	Description	Qty	UOM	VL1054B0	ONE WASHING SYS INLET DISTRIBUTOR	1	PZ	VM1224A0		0.250	M												
Code	Description	Qty	UOM																										
VL1054B0	ONE WASHING SYS INLET DISTRIBUTOR	1	PZ																										
VM1224A0		0.250	M																										
VL1053B	ONE WASHING SYS EXT DISTRIBUTOR		KVL1072A	ONE SERIES AND HOODS CHEMICAL PUMP KIT	<table border="1"> <thead> <tr> <th>Code</th> <th>Description</th> <th>Qty</th> <th>UOM</th> </tr> </thead> <tbody> <tr> <td>0H2143A0</td> <td></td> <td>1</td> <td>PZ</td> </tr> <tr> <td>GN1526A0</td> <td>INT. D.=6.9 TH=1.8 O-RING</td> <td>1</td> <td>PZ</td> </tr> <tr> <td>RC1019A0</td> <td>D=10 ELASTIC CLAMP</td> <td>6</td> <td>PZ</td> </tr> <tr> <td>RC1242A0</td> <td>D=10 CLOSED CAP</td> <td>2</td> <td>PZ</td> </tr> <tr> <td>TB2820A0</td> <td>PIPE EPDM FOR WASHING SYSTEM</td> <td>0.120</td> <td>M</td> </tr> </tbody> </table>	Code	Description	Qty	UOM	0H2143A0		1	PZ	GN1526A0	INT. D.=6.9 TH=1.8 O-RING	1	PZ	RC1019A0	D=10 ELASTIC CLAMP	6	PZ	RC1242A0	D=10 CLOSED CAP	2	PZ	TB2820A0	PIPE EPDM FOR WASHING SYSTEM	0.120	M
Code	Description	Qty	UOM																										
0H2143A0		1	PZ																										
GN1526A0	INT. D.=6.9 TH=1.8 O-RING	1	PZ																										
RC1019A0	D=10 ELASTIC CLAMP	6	PZ																										
RC1242A0	D=10 CLOSED CAP	2	PZ																										
TB2820A0	PIPE EPDM FOR WASHING SYSTEM	0.120	M																										

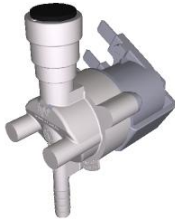
COMPONENT			SPARE PART																																		
Code	Description	Image	Code	Description	Components list																																
VL1053B	ONE WASHING SYS EXT DISTRIBUTOR		KVL1072A	ONE SERIES AND HOODS CHEMICAL PUMP KIT	<table border="1"> <thead> <tr> <th>Code</th> <th>Description</th> <th>Qty</th> <th>UOM</th> </tr> </thead> <tbody> <tr> <td>VI1220A1</td> <td>4,2X12 TCB SELF-TAPPIN G SCREW</td> <td>1</td> <td>PZ</td> </tr> <tr> <td>VL1019A0</td> <td>VIBRATION PUMP</td> <td>1</td> <td>PZ</td> </tr> <tr> <td>VL1053B0</td> <td>ONE WASHING SYS EXT DISTRIBUTOR</td> <td>1</td> <td>PZ</td> </tr> <tr> <td>VL1054B0</td> <td>ONE WASHING SYS INLET DISTRIBUTOR</td> <td>1</td> <td>PZ</td> </tr> <tr> <td>VL1128A0</td> <td>BARBED CHECK VALVE D6</td> <td>1</td> <td>PZ</td> </tr> <tr> <td>VL1128A1</td> <td></td> <td>1</td> <td>PZ</td> </tr> <tr> <td>VM2172A0</td> <td>PUMP-WITH-CI RCUIT LOCKING PIN</td> <td>1</td> <td>PZ</td> </tr> </tbody> </table>	Code	Description	Qty	UOM	VI1220A1	4,2X12 TCB SELF-TAPPIN G SCREW	1	PZ	VL1019A0	VIBRATION PUMP	1	PZ	VL1053B0	ONE WASHING SYS EXT DISTRIBUTOR	1	PZ	VL1054B0	ONE WASHING SYS INLET DISTRIBUTOR	1	PZ	VL1128A0	BARBED CHECK VALVE D6	1	PZ	VL1128A1		1	PZ	VM2172A0	PUMP-WITH-CI RCUIT LOCKING PIN	1	PZ
Code	Description	Qty	UOM																																		
VI1220A1	4,2X12 TCB SELF-TAPPIN G SCREW	1	PZ																																		
VL1019A0	VIBRATION PUMP	1	PZ																																		
VL1053B0	ONE WASHING SYS EXT DISTRIBUTOR	1	PZ																																		
VL1054B0	ONE WASHING SYS INLET DISTRIBUTOR	1	PZ																																		
VL1128A0	BARBED CHECK VALVE D6	1	PZ																																		
VL1128A1		1	PZ																																		
VM2172A0	PUMP-WITH-CI RCUIT LOCKING PIN	1	PZ																																		
VL1128A	BARBED CHECK VALVE D6		KVL1128A	D6 VNR BARBED VALVE KIT	<table border="1"> <thead> <tr> <th>Code</th> <th>Description</th> <th>Qty</th> <th>UOM</th> </tr> </thead> <tbody> <tr> <td>0H2143A0</td> <td></td> <td>1</td> <td>PZ</td> </tr> <tr> <td>RC1019A0</td> <td>D=10 ELASTIC CLAMP</td> <td>4</td> <td>PZ</td> </tr> <tr> <td>RC1130A0</td> <td>130X2,6 CLAM</td> <td>1</td> <td>PZ</td> </tr> <tr> <td>TB2820A0</td> <td>PIPE EPDM FOR WASHING SYSTEM</td> <td>0.080</td> <td>M</td> </tr> <tr> <td>VL1128A0</td> <td>BARBED CHECK VALVE D6</td> <td>1</td> <td>PZ</td> </tr> <tr> <td>VL1128A1</td> <td></td> <td>1</td> <td>PZ</td> </tr> <tr> <td>VM1224A0</td> <td></td> <td>0.200</td> <td>M</td> </tr> </tbody> </table>	Code	Description	Qty	UOM	0H2143A0		1	PZ	RC1019A0	D=10 ELASTIC CLAMP	4	PZ	RC1130A0	130X2,6 CLAM	1	PZ	TB2820A0	PIPE EPDM FOR WASHING SYSTEM	0.080	M	VL1128A0	BARBED CHECK VALVE D6	1	PZ	VL1128A1		1	PZ	VM1224A0		0.200	M
Code	Description	Qty	UOM																																		
0H2143A0		1	PZ																																		
RC1019A0	D=10 ELASTIC CLAMP	4	PZ																																		
RC1130A0	130X2,6 CLAM	1	PZ																																		
TB2820A0	PIPE EPDM FOR WASHING SYSTEM	0.080	M																																		
VL1128A0	BARBED CHECK VALVE D6	1	PZ																																		
VL1128A1		1	PZ																																		
VM1224A0		0.200	M																																		
0H2143A			0H2143A0																																		
RC1242A	D=10 CLOSED CAP		KRC1242A	Ø10 CLOSED CONNECTION 20PCS KIT	<table border="1"> <thead> <tr> <th>Code</th> <th>Description</th> <th>Qty</th> <th>UOM</th> </tr> </thead> <tbody> <tr> <td>RC1242A0</td> <td>D=10 CLOSED CAP</td> <td>20</td> <td>PZ</td> </tr> <tr> <td>VM1224A0</td> <td></td> <td>0.200</td> <td>M</td> </tr> </tbody> </table>	Code	Description	Qty	UOM	RC1242A0	D=10 CLOSED CAP	20	PZ	VM1224A0		0.200	M																				
Code	Description	Qty	UOM																																		
RC1242A0	D=10 CLOSED CAP	20	PZ																																		
VM1224A0		0.200	M																																		

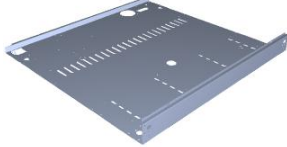

COMPONENT			SPARE PART														
Code	Description	Image	Code	Description	Components list												
EL1436B			KEL1436B	D8 CONNECTION D6 SOLEN. VALVE KIT	<table border="1"> <thead> <tr> <th>Code</th> <th>Description</th> <th>Qty</th> <th>UOM</th> </tr> </thead> <tbody> <tr> <td>EL1436B0</td> <td></td> <td>1</td> <td>PZ</td> </tr> <tr> <td>VM1224A0</td> <td></td> <td>0.250</td> <td>M</td> </tr> </tbody> </table>	Code	Description	Qty	UOM	EL1436B0		1	PZ	VM1224A0		0.250	M
Code	Description	Qty	UOM														
EL1436B0		1	PZ														
VM1224A0		0.250	M														
0D2305B	XEBC-04EU-E EXTERNAL TOP COVER		0D2305B1	XEBC-04EU-E EXTERNAL TOP COVER													
0E1351C	XEBC EXTERNAL BOTTOM PANEL		0E1351C0	XEBC EXTERNAL BOTTOM PANEL													
0D2308A	XEBC-06EU-E LEFT SIDE PANEL		0D2308A3	XEBC-06EU-E LEFT SIDE PANEL													
0D2309A	XEBC-06EU-E EXTERNAL RIGHT SIDE		0D2309A3	XEBC-06EU-E EXTERNAL RIGHT SIDE													



COMPONENT			SPARE PART		
<i>Code</i>	<i>Description</i>	<i>Image</i>	<i>Code</i>	<i>Description</i>	<i>Components list</i>
0F1504A	XEBC-06EU-E BACK PANEL		0F1504A0	XEBC-06EU-E BACK PANEL	