







XEBC-16EU-GPR/0.D11 16 600X400 GAS COMBI OVEN (TROLLEY)

Assembly code	Assembly revision	Assembly image
ASM1810A/1.D01	Electrical system	
ASM1817A/0.D06	Door	
ASM1806C/0.D00	Cooking chamber	
ASM1802B/0.D01	External cover	



ASM1810A/1.D01 - Electrical system

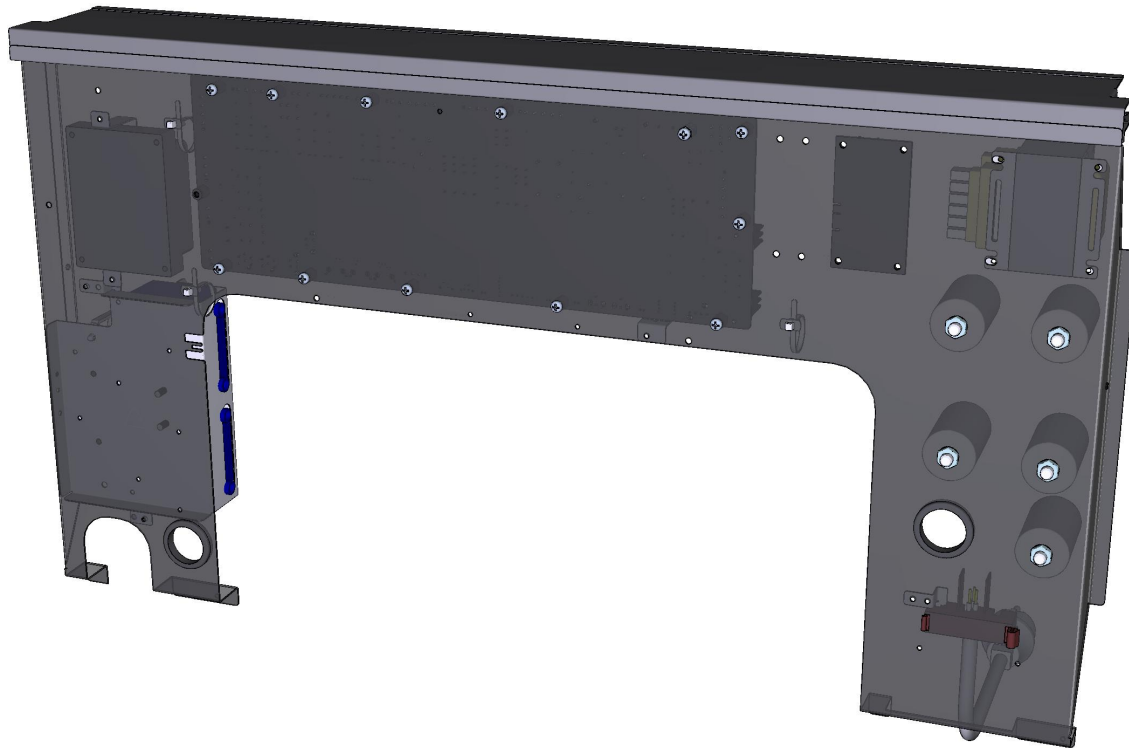

FRONT

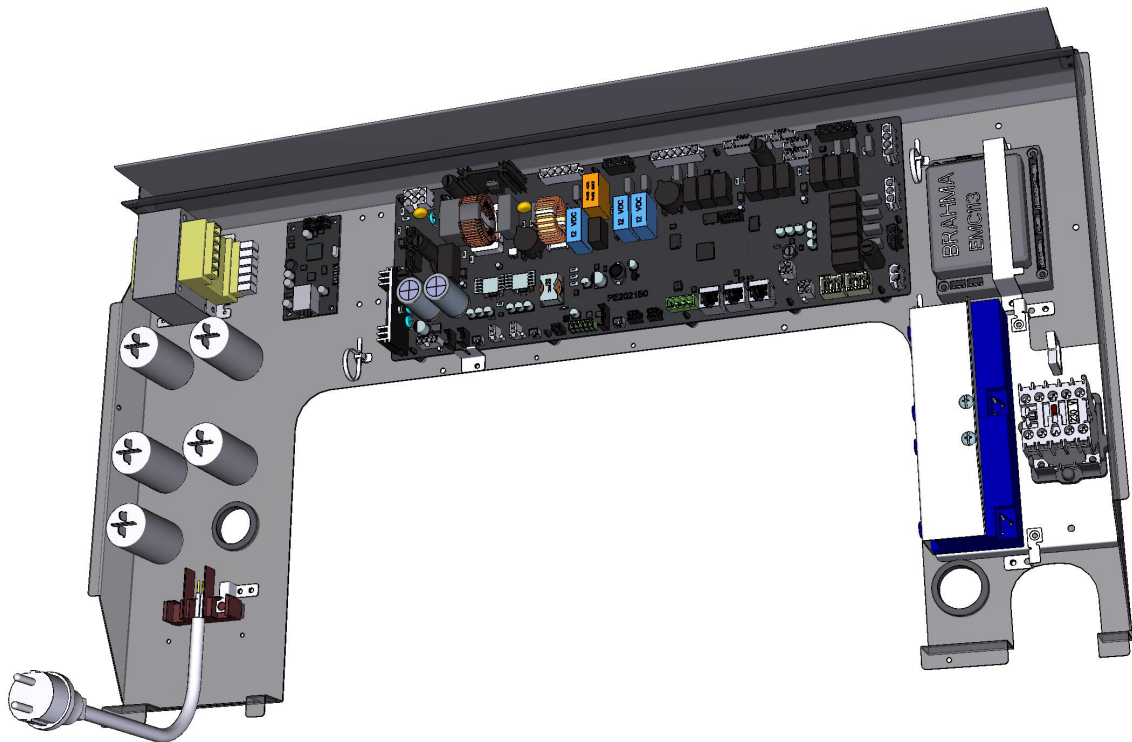

ASM1810A/1.D01 - Electrical system

REAR

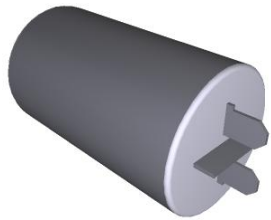
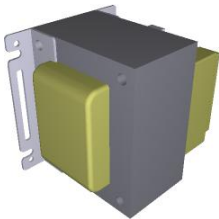

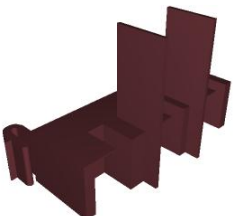



COMPONENT			SPARE PART																														
Code	Description	Image	Code	Description	Components list																												
CN1003A	6,3 UF MOTOR CAPACITOR		KCN1003A	6,3 UF MOTOR CAPACITOR KIT	<table border="1"> <thead> <tr> <th>Code</th> <th>Description</th> <th>Qty</th> <th>UOM</th> </tr> </thead> <tbody> <tr> <td>CN1003A0</td> <td>6,3 UF MOTOR CAPACITOR</td> <td>1</td> <td>PZ</td> </tr> <tr> <td>VI1931A0</td> <td>M8 NUT+INDENTE D WASHER D=8 X COND.</td> <td>1</td> <td>PZ</td> </tr> <tr> <td>VI1932A0</td> <td>M8 NUT+INDENTE D WASHER D=8 X COND.</td> <td>1</td> <td>PZ</td> </tr> <tr> <td>VM1224A0</td> <td></td> <td>0.200</td> <td>M</td> </tr> </tbody> </table>	Code	Description	Qty	UOM	CN1003A0	6,3 UF MOTOR CAPACITOR	1	PZ	VI1931A0	M8 NUT+INDENTE D WASHER D=8 X COND.	1	PZ	VI1932A0	M8 NUT+INDENTE D WASHER D=8 X COND.	1	PZ	VM1224A0		0.200	M								
Code	Description	Qty	UOM																														
CN1003A0	6,3 UF MOTOR CAPACITOR	1	PZ																														
VI1931A0	M8 NUT+INDENTE D WASHER D=8 X COND.	1	PZ																														
VI1932A0	M8 NUT+INDENTE D WASHER D=8 X COND.	1	PZ																														
VM1224A0		0.200	M																														
VE1026A	230-21-12VAC 80VA TRANSFORMER		KVE1026A	230-21-12VAC 90VA TRANSFORMER KIT	<table border="1"> <thead> <tr> <th>Code</th> <th>Description</th> <th>Qty</th> <th>UOM</th> </tr> </thead> <tbody> <tr> <td>VE1026A0</td> <td>230-21-12VAC 80VA TRANSFORMER</td> <td>1</td> <td>PZ</td> </tr> <tr> <td>VI1950A0</td> <td>ST. STEEL 4,2X13 TCB SELF-DRILLING SCREW</td> <td>4</td> <td>PZ</td> </tr> </tbody> </table>	Code	Description	Qty	UOM	VE1026A0	230-21-12VAC 80VA TRANSFORMER	1	PZ	VI1950A0	ST. STEEL 4,2X13 TCB SELF-DRILLING SCREW	4	PZ																
Code	Description	Qty	UOM																														
VE1026A0	230-21-12VAC 80VA TRANSFORMER	1	PZ																														
VI1950A0	ST. STEEL 4,2X13 TCB SELF-DRILLING SCREW	4	PZ																														
PE2052A	MM LAN CONNECTION BRIDGE		XEC001	UNOX.LINK ETHERNET CONNECTION ONE/PLUS	<table border="1"> <thead> <tr> <th>Code</th> <th>Description</th> <th>Qty</th> <th>UOM</th> </tr> </thead> <tbody> <tr> <td>OH7386B0</td> <td>SOUS VIDE PROBE BOARD SUPPORT</td> <td>1</td> <td>PZ</td> </tr> <tr> <td>CE1065A0</td> <td>4X0,5 MICROFIT WIRE 4P-500MM-MICROFIT4P</td> <td>1</td> <td>PZ</td> </tr> <tr> <td>PE2052A0</td> <td>MM LAN CONNECTION BRIDGE</td> <td>1</td> <td>PZ</td> </tr> <tr> <td>VI1850A0</td> <td>M4X6 NICKEL PLATED FIXING SCREW</td> <td>6</td> <td>PZ</td> </tr> <tr> <td>VM1745A0</td> <td>CARD SUPPORT</td> <td>4</td> <td>PZ</td> </tr> <tr> <td>VM2147A0</td> <td>410X343X15 MM PINK SMOOTH ESD SPONGE</td> <td>1</td> <td>PZ</td> </tr> </tbody> </table>	Code	Description	Qty	UOM	OH7386B0	SOUS VIDE PROBE BOARD SUPPORT	1	PZ	CE1065A0	4X0,5 MICROFIT WIRE 4P-500MM-MICROFIT4P	1	PZ	PE2052A0	MM LAN CONNECTION BRIDGE	1	PZ	VI1850A0	M4X6 NICKEL PLATED FIXING SCREW	6	PZ	VM1745A0	CARD SUPPORT	4	PZ	VM2147A0	410X343X15 MM PINK SMOOTH ESD SPONGE	1	PZ
Code	Description	Qty	UOM																														
OH7386B0	SOUS VIDE PROBE BOARD SUPPORT	1	PZ																														
CE1065A0	4X0,5 MICROFIT WIRE 4P-500MM-MICROFIT4P	1	PZ																														
PE2052A0	MM LAN CONNECTION BRIDGE	1	PZ																														
VI1850A0	M4X6 NICKEL PLATED FIXING SCREW	6	PZ																														
VM1745A0	CARD SUPPORT	4	PZ																														
VM2147A0	410X343X15 MM PINK SMOOTH ESD SPONGE	1	PZ																														
CE1575A	MONOPHASIC CLIP TERMINAL BLOCK 41A		KMR1025A	3 POLES TERMINAL BLOCK KIT	<table border="1"> <thead> <tr> <th>Code</th> <th>Description</th> <th>Qty</th> <th>UOM</th> </tr> </thead> <tbody> <tr> <td>MR1025A1</td> <td></td> <td>1</td> <td>PZ</td> </tr> <tr> <td>VM1224A0</td> <td></td> <td>0.150</td> <td>M</td> </tr> </tbody> </table>	Code	Description	Qty	UOM	MR1025A1		1	PZ	VM1224A0		0.150	M																
Code	Description	Qty	UOM																														
MR1025A1		1	PZ																														
VM1224A0		0.150	M																														

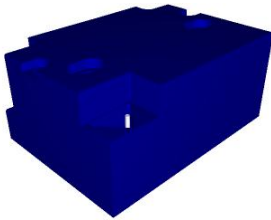
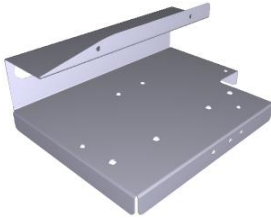
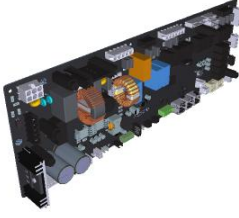

COMPONENT			SPARE PART																										
Code	Description	Image	Code	Description	Components list																								
ASM3121A	General overview		ASM3121A0	General overview																									
VE1115A	20 A 230V 4 POLES MINICONTACTOR		KVE1115A	20A 230V 4 POLES MINICONTACTOR KI	<table border="1"> <thead> <tr> <th>Code</th> <th>Description</th> <th>Qty</th> <th>UOM</th> </tr> </thead> <tbody> <tr> <td>VE1115A0</td> <td>20 A 230V 4 POLES MINICONTACT OR</td> <td>1</td> <td>PZ</td> </tr> <tr> <td>VM1075A1</td> <td>PLASTIC CLIP TO FIX CONTACTORS</td> <td>4</td> <td>PZ</td> </tr> <tr> <td>VM1224A0</td> <td></td> <td>0.250</td> <td>M</td> </tr> </tbody> </table>	Code	Description	Qty	UOM	VE1115A0	20 A 230V 4 POLES MINICONTACT OR	1	PZ	VM1075A1	PLASTIC CLIP TO FIX CONTACTORS	4	PZ	VM1224A0		0.250	M								
Code	Description	Qty	UOM																										
VE1115A0	20 A 230V 4 POLES MINICONTACT OR	1	PZ																										
VM1075A1	PLASTIC CLIP TO FIX CONTACTORS	4	PZ																										
VM1224A0		0.250	M																										
VM1056A	SMALL CONTACTOR BRACKET VE1115A		VM1056A0	SMALL CONTACTOR BRACKET VE1115A																									
VM1066A	SADDLE CLIP FOR CABLES PASSING		VM1066A0	SADDLE CLIP FOR CABLES PASSING																									
VE1625A	5E- MM SERIES FIDA GAS LIGHTER		KVE0009B	EUROPE VERSION GAS IGNITER KIT	<table border="1"> <thead> <tr> <th>Code</th> <th>Description</th> <th>Qty</th> <th>UOM</th> </tr> </thead> <tbody> <tr> <td>0H5126A0</td> <td>IGNITER FIXING OMEG</td> <td>1</td> <td>PZ</td> </tr> <tr> <td>0H6825A0</td> <td>METAL CLAMP</td> <td>1</td> <td>PZ</td> </tr> <tr> <td>CE1390A0</td> <td>YELLOW CABLE UNIP RUBB.SIL. Ø 0,75 MMQ</td> <td>0.260</td> <td>M</td> </tr> <tr> <td>CE1395A0</td> <td>6,3 X 0,8 MALE FASTO</td> <td>4</td> <td>PZ</td> </tr> <tr> <td>CE1661A0</td> <td>MALE FASTON COVER 6,3X0,</td> <td>4</td> <td>PZ</td> </tr> </tbody> </table>	Code	Description	Qty	UOM	0H5126A0	IGNITER FIXING OMEG	1	PZ	0H6825A0	METAL CLAMP	1	PZ	CE1390A0	YELLOW CABLE UNIP RUBB.SIL. Ø 0,75 MMQ	0.260	M	CE1395A0	6,3 X 0,8 MALE FASTO	4	PZ	CE1661A0	MALE FASTON COVER 6,3X0,	4	PZ
Code	Description	Qty	UOM																										
0H5126A0	IGNITER FIXING OMEG	1	PZ																										
0H6825A0	METAL CLAMP	1	PZ																										
CE1390A0	YELLOW CABLE UNIP RUBB.SIL. Ø 0,75 MMQ	0.260	M																										
CE1395A0	6,3 X 0,8 MALE FASTO	4	PZ																										
CE1661A0	MALE FASTON COVER 6,3X0,	4	PZ																										

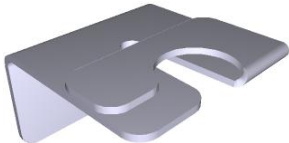
COMPONENT			SPARE PART																																										
Code	Description	Image	Code	Description	Components list																																								
VE1625A	5E- MM SERIES FIDA GAS LIGHTER		KVE0009B	EUROPE VERSION GAS IGNITER KIT	<table border="1"> <thead> <tr> <th>Code</th> <th>Description</th> <th>Qty</th> <th>UOM</th> </tr> </thead> <tbody> <tr> <td>CE1777A1</td> <td>HV START UP CABLE L=700 WITH SILICON CAP</td> <td>2</td> <td>PZ</td> </tr> <tr> <td>CE1782A0</td> <td>HV L=300 BRIDGE FIDA CABLE</td> <td>1</td> <td>PZ</td> </tr> <tr> <td>CE1792A0</td> <td>FLAME DETECTOR CANDLE CABL</td> <td>1</td> <td>PZ</td> </tr> <tr> <td>CE1811A1</td> <td>LIGHTER CONNECTING CABLE PLUG 90°</td> <td>1</td> <td>PZ</td> </tr> <tr> <td>GN1328A1</td> <td>BACK BLACK ADESIVE GASKET 8X3</td> <td>0.500</td> <td>M</td> </tr> <tr> <td>VE1625A0</td> <td>5E- MM SERIES FIDA GAS LIGHTER</td> <td>1</td> <td>PZ</td> </tr> <tr> <td>VI1220A1</td> <td>4,2X12 TCB SELF-TAPPIN G SCREW</td> <td>2</td> <td>PZ</td> </tr> <tr> <td>VI1950A0</td> <td>ST. STEEL 4,2X13 TCB SELF-DRILLIN G SCREW</td> <td>1</td> <td>PZ</td> </tr> <tr> <td>VM1255A1</td> <td>THREAD-COV ERING CAP MARUTEX</td> <td>1</td> <td>PZ</td> </tr> </tbody> </table>	Code	Description	Qty	UOM	CE1777A1	HV START UP CABLE L=700 WITH SILICON CAP	2	PZ	CE1782A0	HV L=300 BRIDGE FIDA CABLE	1	PZ	CE1792A0	FLAME DETECTOR CANDLE CABL	1	PZ	CE1811A1	LIGHTER CONNECTING CABLE PLUG 90°	1	PZ	GN1328A1	BACK BLACK ADESIVE GASKET 8X3	0.500	M	VE1625A0	5E- MM SERIES FIDA GAS LIGHTER	1	PZ	VI1220A1	4,2X12 TCB SELF-TAPPIN G SCREW	2	PZ	VI1950A0	ST. STEEL 4,2X13 TCB SELF-DRILLIN G SCREW	1	PZ	VM1255A1	THREAD-COV ERING CAP MARUTEX	1	PZ
					Code	Description	Qty	UOM																																					
					CE1777A1	HV START UP CABLE L=700 WITH SILICON CAP	2	PZ																																					
					CE1782A0	HV L=300 BRIDGE FIDA CABLE	1	PZ																																					
					CE1792A0	FLAME DETECTOR CANDLE CABL	1	PZ																																					
					CE1811A1	LIGHTER CONNECTING CABLE PLUG 90°	1	PZ																																					
					GN1328A1	BACK BLACK ADESIVE GASKET 8X3	0.500	M																																					
					VE1625A0	5E- MM SERIES FIDA GAS LIGHTER	1	PZ																																					
					VI1220A1	4,2X12 TCB SELF-TAPPIN G SCREW	2	PZ																																					
					VI1950A0	ST. STEEL 4,2X13 TCB SELF-DRILLIN G SCREW	1	PZ																																					
VM1255A1	THREAD-COV ERING CAP MARUTEX	1	PZ																																										
0H7810A	SUPPORT PLATE DOUBLE LIGHTER		K0H7493B	DOUBLE IGNITER HOLDING PLATE KIT	<table border="1"> <thead> <tr> <th>Code</th> <th>Description</th> <th>Qty</th> <th>UOM</th> </tr> </thead> <tbody> <tr> <td>0H7493B0</td> <td>VE1625A DOUBLE IGNITER STOPPING PLATE</td> <td>1</td> <td>PZ</td> </tr> <tr> <td>VM1224A0</td> <td></td> <td>0.250</td> <td>M</td> </tr> </tbody> </table>	Code	Description	Qty	UOM	0H7493B0	VE1625A DOUBLE IGNITER STOPPING PLATE	1	PZ	VM1224A0		0.250	M																												
					Code	Description	Qty	UOM																																					
0H7493B0	VE1625A DOUBLE IGNITER STOPPING PLATE	1	PZ																																										
VM1224A0		0.250	M																																										
PE2021B	MIND.MAPS GAS POWER CARD		KPE2021C	MM GAS EU POWER BOARD KIT	<table border="1"> <thead> <tr> <th>Code</th> <th>Description</th> <th>Qty</th> <th>UOM</th> </tr> </thead> <tbody> <tr> <td>PE2021C0</td> <td>MM EU GAS POWER BOAR</td> <td>1</td> <td>PZ</td> </tr> <tr> <td>VI1850A0</td> <td>M4X6 NICKEL PLATED FIXING SCRE</td> <td>12</td> <td>PZ</td> </tr> <tr> <td>VM1745A0</td> <td>CARD SUPPORT</td> <td>12</td> <td>PZ</td> </tr> <tr> <td>VM2147A0</td> <td>410X343X15 MM PINK SMOOTH ESD SPONGE</td> <td>1</td> <td>PZ</td> </tr> </tbody> </table>	Code	Description	Qty	UOM	PE2021C0	MM EU GAS POWER BOAR	1	PZ	VI1850A0	M4X6 NICKEL PLATED FIXING SCRE	12	PZ	VM1745A0	CARD SUPPORT	12	PZ	VM2147A0	410X343X15 MM PINK SMOOTH ESD SPONGE	1	PZ																				
					Code	Description	Qty	UOM																																					
					PE2021C0	MM EU GAS POWER BOAR	1	PZ																																					
					VI1850A0	M4X6 NICKEL PLATED FIXING SCRE	12	PZ																																					
VM1745A0	CARD SUPPORT	12	PZ																																										
VM2147A0	410X343X15 MM PINK SMOOTH ESD SPONGE	1	PZ																																										







COMPONENT			SPARE PART														
Code	Description	Image	Code	Description	Components list												
0H7374A	CORE PROBE CABLE PLATE		0H7374A0	CORE PROBE CABLE PLATE													
VE1636A			KVE1636B	240V 50/60HZ MULTIFLAME IGNITION BOX KIT	<table border="1"> <thead> <tr> <th>Code</th> <th>Description</th> <th>Qty</th> <th>UOM</th> </tr> </thead> <tbody> <tr> <td>CE1047A1</td> <td>FLAME DETECTOR CANDLE CABL</td> <td>1</td> <td>PZ</td> </tr> <tr> <td>VE1636B0</td> <td></td> <td>1</td> <td>PZ</td> </tr> </tbody> </table>	Code	Description	Qty	UOM	CE1047A1	FLAME DETECTOR CANDLE CABL	1	PZ	VE1636B0		1	PZ
Code	Description	Qty	UOM														
CE1047A1	FLAME DETECTOR CANDLE CABL	1	PZ														
VE1636B0		1	PZ														
0H7293A	GROUND CONNECTOR FIXING PLATE		OUTOFPRODUCTIO														
0H7462A	VE1636A GEARCASE STOPPING PLATE		0H7462A0	VE1636A GEARCASE STOPPING PLATE													

ASM1817A/0.D06 - Door

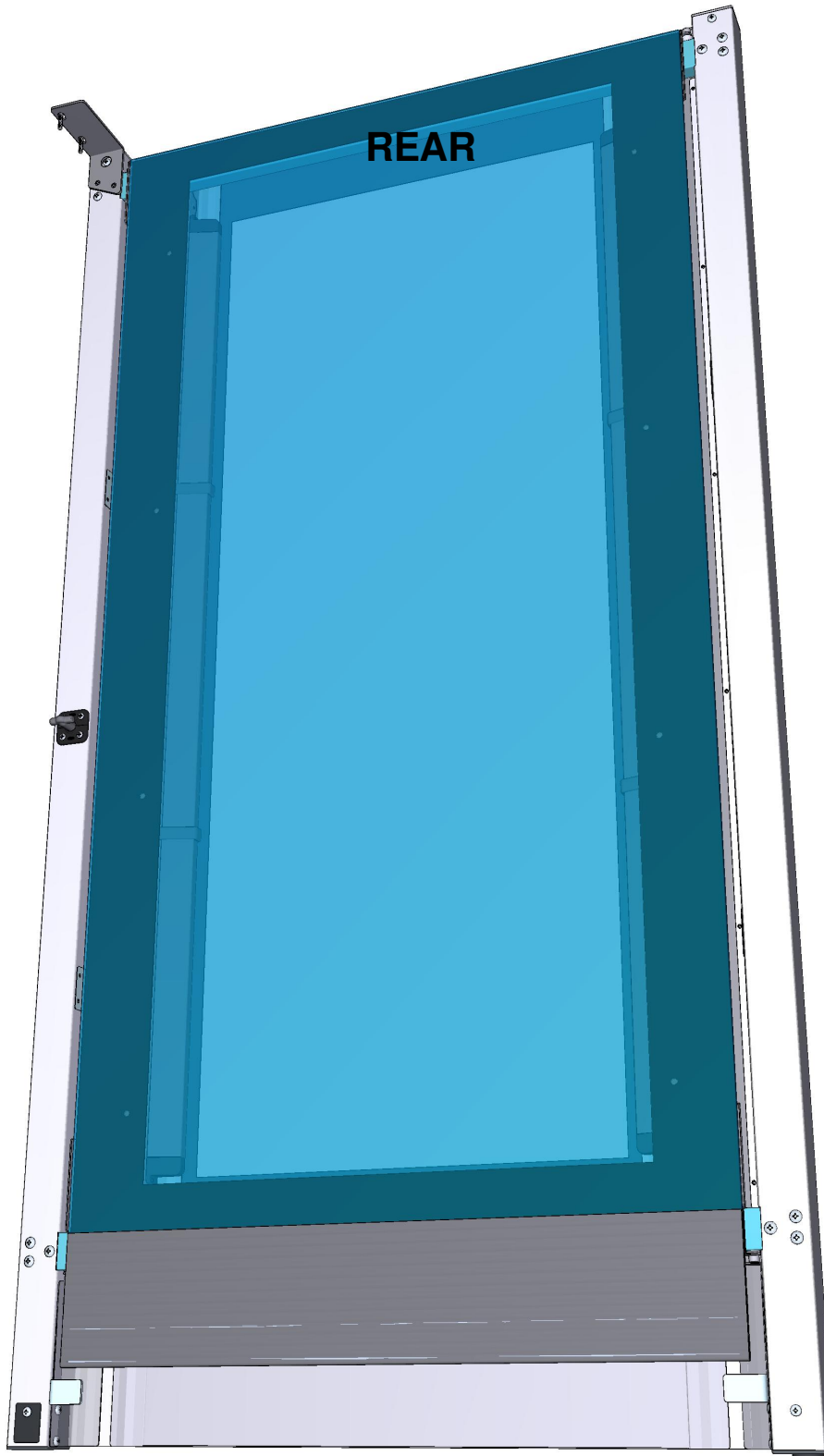

ASM1817A/0.D06 - Door

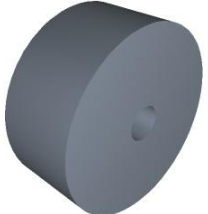

COMPONENT			SPARE PART																																						
Code	Description	Image	Code	Description	Components list																																				
VI1995A	M5X25 ST.STEEL SCREW		VI1995A0	M5X25 ST.STEEL SCREW																																					
VE1030A	MAGNET FOR DOOR MICROSWITCH D=22,9MM		KVE1030A	2 PCS MAGNET KIT FOR DOOR SWITCH	<table border="1"> <thead> <tr> <th>Code</th> <th>Description</th> <th>Qty</th> <th>UOM</th> </tr> </thead> <tbody> <tr> <td>VE1030A1</td> <td>MAGNET FOR DOOR MICROSWITCH H D=22,9MM</td> <td>2</td> <td>PZ</td> </tr> <tr> <td>VM1224A0</td> <td></td> <td>0.150</td> <td>M</td> </tr> </tbody> </table>	Code	Description	Qty	UOM	VE1030A1	MAGNET FOR DOOR MICROSWITCH H D=22,9MM	2	PZ	VM1224A0		0.150	M																								
Code	Description	Qty	UOM																																						
VE1030A1	MAGNET FOR DOOR MICROSWITCH H D=22,9MM	2	PZ																																						
VM1224A0		0.150	M																																						
			KVE1020A	MICROSWITCH KIT	<table border="1"> <thead> <tr> <th>Code</th> <th>Description</th> <th>Qty</th> <th>UOM</th> </tr> </thead> <tbody> <tr> <td>VE1020A2</td> <td>MAGNETIC DOOR MICROSWITCH</td> <td>1</td> <td>PZ</td> </tr> <tr> <td>VE1030A1</td> <td>MAGNET FOR DOOR MICROSWITCH H D=22,9MM</td> <td>4</td> <td>PZ</td> </tr> <tr> <td>VM1224A0</td> <td></td> <td>0.250</td> <td>M</td> </tr> </tbody> </table>	Code	Description	Qty	UOM	VE1020A2	MAGNETIC DOOR MICROSWITCH	1	PZ	VE1030A1	MAGNET FOR DOOR MICROSWITCH H D=22,9MM	4	PZ	VM1224A0		0.250	M																				
Code	Description	Qty	UOM																																						
VE1020A2	MAGNETIC DOOR MICROSWITCH	1	PZ																																						
VE1030A1	MAGNET FOR DOOR MICROSWITCH H D=22,9MM	4	PZ																																						
VM1224A0		0.250	M																																						
VT1300A	EXTER. GLASS XEVC-2011-E		KVT1300A	2011-2021-16EU EXTERNAL GLASS KIT	<table border="1"> <thead> <tr> <th>Code</th> <th>Description</th> <th>Qty</th> <th>UOM</th> </tr> </thead> <tbody> <tr> <td>0H7242A0</td> <td>XEVC-2011 DOOR GLASS SUPPORT PLATE</td> <td>2</td> <td>PZ</td> </tr> <tr> <td>IL1050B0</td> <td>WOODEN PALLET 965X875X123</td> <td>2</td> <td>PZ</td> </tr> <tr> <td>IP1385A1</td> <td>CORNER POLYSTYREN E PACKING 110X80X2000</td> <td>3</td> <td>M</td> </tr> <tr> <td>IP1508A1</td> <td>POLYSTYREN E U SHAPED PROFILE 2000X60X60</td> <td>2</td> <td>M</td> </tr> <tr> <td>SL1155A1</td> <td>LOCTITE BICOMPONENT SILICON</td> <td>104</td> <td>ML</td> </tr> <tr> <td>SL1156A0</td> <td>NOZZLE FOR SILICON GUN</td> <td>1</td> <td>PZ</td> </tr> <tr> <td>VT1300A0</td> <td>EXTER. GLASS XEVC-2011-E</td> <td>1</td> <td>PZ</td> </tr> <tr> <td>VT1300A0</td> <td>EXTER. GLASS XEVC-2011-E</td> <td>1</td> <td>PZ</td> </tr> </tbody> </table>	Code	Description	Qty	UOM	0H7242A0	XEVC-2011 DOOR GLASS SUPPORT PLATE	2	PZ	IL1050B0	WOODEN PALLET 965X875X123	2	PZ	IP1385A1	CORNER POLYSTYREN E PACKING 110X80X2000	3	M	IP1508A1	POLYSTYREN E U SHAPED PROFILE 2000X60X60	2	M	SL1155A1	LOCTITE BICOMPONENT SILICON	104	ML	SL1156A0	NOZZLE FOR SILICON GUN	1	PZ	VT1300A0	EXTER. GLASS XEVC-2011-E	1	PZ	VT1300A0	EXTER. GLASS XEVC-2011-E	1	PZ
Code	Description	Qty	UOM																																						
0H7242A0	XEVC-2011 DOOR GLASS SUPPORT PLATE	2	PZ																																						
IL1050B0	WOODEN PALLET 965X875X123	2	PZ																																						
IP1385A1	CORNER POLYSTYREN E PACKING 110X80X2000	3	M																																						
IP1508A1	POLYSTYREN E U SHAPED PROFILE 2000X60X60	2	M																																						
SL1155A1	LOCTITE BICOMPONENT SILICON	104	ML																																						
SL1156A0	NOZZLE FOR SILICON GUN	1	PZ																																						
VT1300A0	EXTER. GLASS XEVC-2011-E	1	PZ																																						
VT1300A0	EXTER. GLASS XEVC-2011-E	1	PZ																																						



COMPONENT			SPARE PART																																																														
Code	Description	Image	Code	Description	Components list																																																												
VT1300A	EXTER. GLASS XEVC-2011-E		KDR7783A	BAKERTOP 16EU LEFT EXTERNAL DOOR	<table border="1"> <thead> <tr> <th>Code</th> <th>Description</th> <th>Qty</th> <th>UOM</th> </tr> </thead> <tbody> <tr> <td>0H1604A0</td> <td>BIG OVENS GLASS HOLDING PLATE HOLE COVER</td> <td>2</td> <td>PZ</td> </tr> <tr> <td>0H7242A0</td> <td>XEVC-2011 DOOR GLASS SUPPORT PLATE</td> <td>2</td> <td>PZ</td> </tr> <tr> <td>0H7243A0</td> <td>XEVC-2011 LOWER DOOR PROFILE</td> <td>1</td> <td>PZ</td> </tr> <tr> <td>0H7247A0</td> <td>XEVC-2011 UPPER DOOR PROFILE</td> <td>1</td> <td>PZ</td> </tr> <tr> <td>0H7248B0</td> <td>TROLLEY PUSHING CAM L SHAPED BRACKET</td> <td>2</td> <td>PZ</td> </tr> <tr> <td>0H7321A0</td> <td>MM STAINLESS STEEL HANDLE COVE</td> <td>1</td> <td>PZ</td> </tr> <tr> <td>0H7498A2</td> <td>XEVC-2011 LEFT - RIGHT INT DOOR COLUMN</td> <td>1</td> <td>PZ</td> </tr> <tr> <td>0H7499A1</td> <td>XEVC-2011 LEFT - LEFT INT DOOR COLUMN</td> <td>1</td> <td>PZ</td> </tr> <tr> <td>0H7500A0</td> <td>LEFT DOOR SUPPORT BRACKET</td> <td>1</td> <td>PZ</td> </tr> <tr> <td>0H7781A0</td> <td>XEVC-2011 LEFT - RIGHT EXT DOOR COLUMN</td> <td>1</td> <td>PZ</td> </tr> <tr> <td>0H7783A0</td> <td>XEVC-2011 BT LEFT EXT DOOR COLUM</td> <td>1</td> <td>PZ</td> </tr> <tr> <td>CE1052A1</td> <td>CABLE CONNECTION CONTROL - USB MM 750M</td> <td>1</td> <td>PZ</td> </tr> <tr> <td>CE1053B0</td> <td>MM MICROFIT LED BAR POWER SUPPLY CABL</td> <td>1</td> <td>PZ</td> </tr> <tr> <td>PE2046A2</td> <td>MM POWER SWITCH AND USB BOARD</td> <td>1</td> <td>PZ</td> </tr> </tbody> </table>	Code	Description	Qty	UOM	0H1604A0	BIG OVENS GLASS HOLDING PLATE HOLE COVER	2	PZ	0H7242A0	XEVC-2011 DOOR GLASS SUPPORT PLATE	2	PZ	0H7243A0	XEVC-2011 LOWER DOOR PROFILE	1	PZ	0H7247A0	XEVC-2011 UPPER DOOR PROFILE	1	PZ	0H7248B0	TROLLEY PUSHING CAM L SHAPED BRACKET	2	PZ	0H7321A0	MM STAINLESS STEEL HANDLE COVE	1	PZ	0H7498A2	XEVC-2011 LEFT - RIGHT INT DOOR COLUMN	1	PZ	0H7499A1	XEVC-2011 LEFT - LEFT INT DOOR COLUMN	1	PZ	0H7500A0	LEFT DOOR SUPPORT BRACKET	1	PZ	0H7781A0	XEVC-2011 LEFT - RIGHT EXT DOOR COLUMN	1	PZ	0H7783A0	XEVC-2011 BT LEFT EXT DOOR COLUM	1	PZ	CE1052A1	CABLE CONNECTION CONTROL - USB MM 750M	1	PZ	CE1053B0	MM MICROFIT LED BAR POWER SUPPLY CABL	1	PZ	PE2046A2	MM POWER SWITCH AND USB BOARD	1	PZ
Code	Description	Qty	UOM																																																														
0H1604A0	BIG OVENS GLASS HOLDING PLATE HOLE COVER	2	PZ																																																														
0H7242A0	XEVC-2011 DOOR GLASS SUPPORT PLATE	2	PZ																																																														
0H7243A0	XEVC-2011 LOWER DOOR PROFILE	1	PZ																																																														
0H7247A0	XEVC-2011 UPPER DOOR PROFILE	1	PZ																																																														
0H7248B0	TROLLEY PUSHING CAM L SHAPED BRACKET	2	PZ																																																														
0H7321A0	MM STAINLESS STEEL HANDLE COVE	1	PZ																																																														
0H7498A2	XEVC-2011 LEFT - RIGHT INT DOOR COLUMN	1	PZ																																																														
0H7499A1	XEVC-2011 LEFT - LEFT INT DOOR COLUMN	1	PZ																																																														
0H7500A0	LEFT DOOR SUPPORT BRACKET	1	PZ																																																														
0H7781A0	XEVC-2011 LEFT - RIGHT EXT DOOR COLUMN	1	PZ																																																														
0H7783A0	XEVC-2011 BT LEFT EXT DOOR COLUM	1	PZ																																																														
CE1052A1	CABLE CONNECTION CONTROL - USB MM 750M	1	PZ																																																														
CE1053B0	MM MICROFIT LED BAR POWER SUPPLY CABL	1	PZ																																																														
PE2046A2	MM POWER SWITCH AND USB BOARD	1	PZ																																																														





COMPONENT			SPARE PART																																																																						
Code	Description	Image	Code	Description	Components list																																																																				
VT1300A	EXTER. GLASS XEVC-2011-E		KDR7783A	BAKERTOP 16EU LEFT EXTERNAL DOOR	<table border="1"> <thead> <tr> <th>Code</th> <th>Description</th> <th>Qty</th> <th>UOM</th> </tr> </thead> <tbody> <tr> <td>RC1200A0</td> <td>ED=4 WIRE D.=0.5 COMPRESSIO N SPRING</td> <td>4</td> <td>PZ</td> </tr> <tr> <td>TB2911A1</td> <td>XEVC-2011-E DOOR BEAM</td> <td>1</td> <td>PZ</td> </tr> <tr> <td>TB3204A0</td> <td>XEVC-2011-E UPPER DOOR BEAM</td> <td>1</td> <td>PZ</td> </tr> <tr> <td>VE1030A1</td> <td>MAGNET FOR DOOR MICROSWITC H D=22.9MM</td> <td>1</td> <td>PZ</td> </tr> <tr> <td>VI0239A1</td> <td>SELF-TAPPIN G SCREW 4.2X25 TCB+ INOX</td> <td>4</td> <td>PZ</td> </tr> <tr> <td>VI1220A1</td> <td>4.2X12 TCB SELF-TAPPIN G SCREW</td> <td>57</td> <td>PZ</td> </tr> <tr> <td>VI1300A0</td> <td>SCREW M6X12 T1/2T+INOX</td> <td>12</td> <td>PZ</td> </tr> <tr> <td>VI1310A0</td> <td>ZINC THREAD INSERT M6 FTR/E</td> <td>12</td> <td>PZ</td> </tr> <tr> <td>VI1910A0</td> <td>ST STEEL TCEI SCREW M6X35 PARTIAL THREAD</td> <td>2</td> <td>PZ</td> </tr> <tr> <td>VI1930A0</td> <td>5X25 ST. STEEL SCREW CHIP</td> <td>14</td> <td>PZ</td> </tr> <tr> <td>VI1982A0</td> <td>M6 ST. STEEL BLIND THREADED INSERT</td> <td>2</td> <td>PZ</td> </tr> <tr> <td>VI1995A0</td> <td>M5X25 ST.STEEL SCREW</td> <td>13</td> <td>PZ</td> </tr> <tr> <td>VM1182B1</td> <td>E.S. CT BT HANDLE JUNCTION + PIN GUIDE</td> <td>1</td> <td>PZ</td> </tr> <tr> <td>VM1183B0</td> <td>CHEFTOP/BAK ERTOP HANDLE PIN</td> <td>1</td> <td>PZ</td> </tr> <tr> <td>VM1183B1</td> <td>CT BT HANDLE PIN</td> <td>1</td> <td>PZ</td> </tr> <tr> <td>VM1183C0</td> <td>CT BT HANDLE T-SHAPED PIN KIT</td> <td>1</td> <td>PZ</td> </tr> </tbody> </table>	Code	Description	Qty	UOM	RC1200A0	ED=4 WIRE D.=0.5 COMPRESSIO N SPRING	4	PZ	TB2911A1	XEVC-2011-E DOOR BEAM	1	PZ	TB3204A0	XEVC-2011-E UPPER DOOR BEAM	1	PZ	VE1030A1	MAGNET FOR DOOR MICROSWITC H D=22.9MM	1	PZ	VI0239A1	SELF-TAPPIN G SCREW 4.2X25 TCB+ INOX	4	PZ	VI1220A1	4.2X12 TCB SELF-TAPPIN G SCREW	57	PZ	VI1300A0	SCREW M6X12 T1/2T+INOX	12	PZ	VI1310A0	ZINC THREAD INSERT M6 FTR/E	12	PZ	VI1910A0	ST STEEL TCEI SCREW M6X35 PARTIAL THREAD	2	PZ	VI1930A0	5X25 ST. STEEL SCREW CHIP	14	PZ	VI1982A0	M6 ST. STEEL BLIND THREADED INSERT	2	PZ	VI1995A0	M5X25 ST.STEEL SCREW	13	PZ	VM1182B1	E.S. CT BT HANDLE JUNCTION + PIN GUIDE	1	PZ	VM1183B0	CHEFTOP/BAK ERTOP HANDLE PIN	1	PZ	VM1183B1	CT BT HANDLE PIN	1	PZ	VM1183C0	CT BT HANDLE T-SHAPED PIN KIT	1	PZ
Code	Description	Qty	UOM																																																																						
RC1200A0	ED=4 WIRE D.=0.5 COMPRESSIO N SPRING	4	PZ																																																																						
TB2911A1	XEVC-2011-E DOOR BEAM	1	PZ																																																																						
TB3204A0	XEVC-2011-E UPPER DOOR BEAM	1	PZ																																																																						
VE1030A1	MAGNET FOR DOOR MICROSWITC H D=22.9MM	1	PZ																																																																						
VI0239A1	SELF-TAPPIN G SCREW 4.2X25 TCB+ INOX	4	PZ																																																																						
VI1220A1	4.2X12 TCB SELF-TAPPIN G SCREW	57	PZ																																																																						
VI1300A0	SCREW M6X12 T1/2T+INOX	12	PZ																																																																						
VI1310A0	ZINC THREAD INSERT M6 FTR/E	12	PZ																																																																						
VI1910A0	ST STEEL TCEI SCREW M6X35 PARTIAL THREAD	2	PZ																																																																						
VI1930A0	5X25 ST. STEEL SCREW CHIP	14	PZ																																																																						
VI1982A0	M6 ST. STEEL BLIND THREADED INSERT	2	PZ																																																																						
VI1995A0	M5X25 ST.STEEL SCREW	13	PZ																																																																						
VM1182B1	E.S. CT BT HANDLE JUNCTION + PIN GUIDE	1	PZ																																																																						
VM1183B0	CHEFTOP/BAK ERTOP HANDLE PIN	1	PZ																																																																						
VM1183B1	CT BT HANDLE PIN	1	PZ																																																																						
VM1183C0	CT BT HANDLE T-SHAPED PIN KIT	1	PZ																																																																						



COMPONENT			SPARE PART																																																																																			
Code	Description	Image	Code	Description	Components list																																																																																	
VT1300A	EXTER. GLASS XEVC-2011-E		KDR7783A	BAKERTOP 16EU LEFT EXTERNAL DOOR	<table border="1"> <thead> <tr> <th>Code</th> <th>Description</th> <th>Qty</th> <th>UOM</th> </tr> </thead> <tbody> <tr> <td>VM1490A0</td> <td>CHEFTOP/BAK ERTOP HANDLE SCREWS COVER</td> <td>2</td> <td>PZ</td> </tr> <tr> <td>VM1630A0</td> <td>INTERNAL GLASS PUSHING CAP</td> <td>1</td> <td>PZ</td> </tr> <tr> <td>VM1630A1</td> <td>XB/XV/XVC/XG TERMINAL COVERING BO</td> <td>1</td> <td>PZ</td> </tr> <tr> <td>VM1631A0</td> <td></td> <td>1</td> <td>PZ</td> </tr> <tr> <td>VM1695A0</td> <td>HANDLE POSITION PIN</td> <td>4</td> <td>PZ</td> </tr> <tr> <td>VM2245A0</td> <td>HANDLE SHAFT WITH LATCH</td> <td>1</td> <td>PZ</td> </tr> <tr> <td>VM2247A0</td> <td>HANDLE SHAFT COVER VM2245-2246</td> <td>1</td> <td>PZ</td> </tr> <tr> <td>VM2247B0</td> <td>HANDLE SHAFT COVER VM2245-2246</td> <td>1</td> <td>PZ</td> </tr> <tr> <td>VM2248B0</td> <td>HANDLE WITH LATCH CLOSING KEY</td> <td>1</td> <td>PZ</td> </tr> <tr> <td>VM2263A0</td> <td>MM BIG DOOR LOWER LEFT CAP</td> <td>1</td> <td>PZ</td> </tr> <tr> <td>VM2264A0</td> <td>MM BIG DOOR UPPER CAP</td> <td>1</td> <td>PZ</td> </tr> <tr> <td>VM2265A0</td> <td>MM BIG DOOR LOWER RIGHT CAP</td> <td>1</td> <td>PZ</td> </tr> <tr> <td>VM2266A0</td> <td>MM BIG DOOR RIGHT UPPER CAP</td> <td>1</td> <td>PZ</td> </tr> <tr> <td>VM2268A0</td> <td>DOOR MAGNET COVER</td> <td>1</td> <td>PZ</td> </tr> <tr> <td>VM2274A0</td> <td>GROOVED BUSHING</td> <td>1</td> <td>PZ</td> </tr> <tr> <td>VM2275A0</td> <td>SMOOTH BUSHING</td> <td>1</td> <td>PZ</td> </tr> <tr> <td>VM2295A0</td> <td>STYLUS PEN FOR MM</td> <td>1</td> <td>PZ</td> </tr> <tr> <td>VM2305A0</td> <td>6 SERIES DOOR CAP FIXING PAWL</td> <td>10</td> <td>PZ</td> </tr> <tr> <td>VM2315A0</td> <td>MIND.MAPS INTERNAL GLASS CAP SUPPORT</td> <td>1</td> <td>PZ</td> </tr> </tbody> </table>	Code	Description	Qty	UOM	VM1490A0	CHEFTOP/BAK ERTOP HANDLE SCREWS COVER	2	PZ	VM1630A0	INTERNAL GLASS PUSHING CAP	1	PZ	VM1630A1	XB/XV/XVC/XG TERMINAL COVERING BO	1	PZ	VM1631A0		1	PZ	VM1695A0	HANDLE POSITION PIN	4	PZ	VM2245A0	HANDLE SHAFT WITH LATCH	1	PZ	VM2247A0	HANDLE SHAFT COVER VM2245-2246	1	PZ	VM2247B0	HANDLE SHAFT COVER VM2245-2246	1	PZ	VM2248B0	HANDLE WITH LATCH CLOSING KEY	1	PZ	VM2263A0	MM BIG DOOR LOWER LEFT CAP	1	PZ	VM2264A0	MM BIG DOOR UPPER CAP	1	PZ	VM2265A0	MM BIG DOOR LOWER RIGHT CAP	1	PZ	VM2266A0	MM BIG DOOR RIGHT UPPER CAP	1	PZ	VM2268A0	DOOR MAGNET COVER	1	PZ	VM2274A0	GROOVED BUSHING	1	PZ	VM2275A0	SMOOTH BUSHING	1	PZ	VM2295A0	STYLUS PEN FOR MM	1	PZ	VM2305A0	6 SERIES DOOR CAP FIXING PAWL	10	PZ	VM2315A0	MIND.MAPS INTERNAL GLASS CAP SUPPORT	1	PZ	
Code	Description	Qty	UOM																																																																																			
VM1490A0	CHEFTOP/BAK ERTOP HANDLE SCREWS COVER	2	PZ																																																																																			
VM1630A0	INTERNAL GLASS PUSHING CAP	1	PZ																																																																																			
VM1630A1	XB/XV/XVC/XG TERMINAL COVERING BO	1	PZ																																																																																			
VM1631A0		1	PZ																																																																																			
VM1695A0	HANDLE POSITION PIN	4	PZ																																																																																			
VM2245A0	HANDLE SHAFT WITH LATCH	1	PZ																																																																																			
VM2247A0	HANDLE SHAFT COVER VM2245-2246	1	PZ																																																																																			
VM2247B0	HANDLE SHAFT COVER VM2245-2246	1	PZ																																																																																			
VM2248B0	HANDLE WITH LATCH CLOSING KEY	1	PZ																																																																																			
VM2263A0	MM BIG DOOR LOWER LEFT CAP	1	PZ																																																																																			
VM2264A0	MM BIG DOOR UPPER CAP	1	PZ																																																																																			
VM2265A0	MM BIG DOOR LOWER RIGHT CAP	1	PZ																																																																																			
VM2266A0	MM BIG DOOR RIGHT UPPER CAP	1	PZ																																																																																			
VM2268A0	DOOR MAGNET COVER	1	PZ																																																																																			
VM2274A0	GROOVED BUSHING	1	PZ																																																																																			
VM2275A0	SMOOTH BUSHING	1	PZ																																																																																			
VM2295A0	STYLUS PEN FOR MM	1	PZ																																																																																			
VM2305A0	6 SERIES DOOR CAP FIXING PAWL	10	PZ																																																																																			
VM2315A0	MIND.MAPS INTERNAL GLASS CAP SUPPORT	1	PZ																																																																																			



COMPONENT			SPARE PART					
Code	Description	Image	Code	Description	Components list			
VT1300A	EXTER. GLASS XEVC-2011-E		KDR7783A	BAKERTOP 16EU LEFT EXTERNAL DOOR	Code	Description	Qty	UOM
					VM2355A0	XEVC-2011 INTERNAL GLASS LOCKING KIT	2	PZ
					VM2355A0	XEVC-2011 INTERNAL GLASS LOCKING KIT	2	PZ
					VM2371A0	DOUBLE GLASS DOOR PUSHING BRACKET	1	PZ
					VM2371A0	DOUBLE GLASS DOOR PUSHING BRACKET	1	PZ
					VM2410A0	PLATE TO STOP EXTRUDED LED BAR	4	PZ
					VM2410A0	PLATE TO STOP EXTRUDED LED BAR	4	PZ
					VM2505A0	MM PLUS INTERNAL GLASS SUPPORT	1	PZ
					VM2518A0	BOARD COOLING FAN SUPPORT	1	PZ
					VM2518A0	BOARD COOLING FAN SUPPORT	1	PZ
					VN1179A0	CONTROL BOARD 40X40X20MM 12V COOLING FAN	1	PZ
					VN1179A0	CONTROL BOARD 40X40X20MM 12V COOLING FAN	1	PZ
					VN1179A1	CONTROL BOARD 40X40X20MM 12V COOLING FAN	1	PZ
					VT1300A0	EXTER. GLASS XEVC-2011-E	1	PZ
					VT1300A0	EXTER. GLASS XEVC-2011-E	1	PZ

COMPONENT			SPARE PART																																																																						
Code	Description	Image	Code	Description	Components list																																																																				
VT1300A	EXTER. GLASS XEVC-2011-E		KDR7780A	BAKERTOP 16EU RIGHT EXTERNAL DOOR KIT	<table border="1"> <thead> <tr> <th>Code</th> <th>Description</th> <th>Qty</th> <th>UOM</th> </tr> </thead> <tbody> <tr> <td>0H1604A0</td> <td>BIG OVENS GLASS HOLDING PLATE HOLE COVER</td> <td>2</td> <td>PZ</td> </tr> <tr> <td>0H7240A2</td> <td>XEVC-2011 RIGHT INT DOOR COLUM</td> <td>1</td> <td>PZ</td> </tr> <tr> <td>0H7241A1</td> <td>XEVC-2011 LEFT INT DOOR COLUM</td> <td>1</td> <td>PZ</td> </tr> <tr> <td>0H7242A0</td> <td>XEVC-2011 DOOR GLASS SUPPORT PLATE</td> <td>2</td> <td>PZ</td> </tr> <tr> <td>0H7243A0</td> <td>XEVC-2011 LOWER DOOR PROFILE</td> <td>1</td> <td>PZ</td> </tr> <tr> <td>0H7247A0</td> <td>XEVC-2011 UPPER DOOR PROFILE</td> <td>1</td> <td>PZ</td> </tr> <tr> <td>0H7248B0</td> <td>TROLLEY PUSHING CAM L SHAPED BRACKET</td> <td>2</td> <td>PZ</td> </tr> <tr> <td>0H7297A0</td> <td>DOOR SUPPORT BRACKET</td> <td>1</td> <td>PZ</td> </tr> <tr> <td>0H7321A0</td> <td>MM STAINLESS STEEL HANDLE COVE</td> <td>1</td> <td>PZ</td> </tr> <tr> <td>0H7778A0</td> <td>XEVC-2011 RIGHT EXT DOOR COLUM</td> <td>1</td> <td>PZ</td> </tr> <tr> <td>0H7780A0</td> <td>16EU BAKER DOOR LEFT EXT COLUMN</td> <td>1</td> <td>PZ</td> </tr> <tr> <td>CE1052A1</td> <td>CABLE CONNECTION CONTROL - USB MM 750M</td> <td>1</td> <td>PZ</td> </tr> <tr> <td>CE1053B0</td> <td>MM MICROFIT LED BAR POWER SUPPLY CABL</td> <td>1</td> <td>PZ</td> </tr> <tr> <td>CE1455A0</td> <td>TIP END FITTING</td> <td>4</td> <td>PZ</td> </tr> <tr> <td>CE1725A0</td> <td>ROBOTICS SILICON PIPE 4X0,5 MMQ</td> <td>4</td> <td>M</td> </tr> <tr> <td>CE1735A0</td> <td>MINIFIT FEMALE END FITTING</td> <td>4</td> <td>PZ</td> </tr> </tbody> </table>	Code	Description	Qty	UOM	0H1604A0	BIG OVENS GLASS HOLDING PLATE HOLE COVER	2	PZ	0H7240A2	XEVC-2011 RIGHT INT DOOR COLUM	1	PZ	0H7241A1	XEVC-2011 LEFT INT DOOR COLUM	1	PZ	0H7242A0	XEVC-2011 DOOR GLASS SUPPORT PLATE	2	PZ	0H7243A0	XEVC-2011 LOWER DOOR PROFILE	1	PZ	0H7247A0	XEVC-2011 UPPER DOOR PROFILE	1	PZ	0H7248B0	TROLLEY PUSHING CAM L SHAPED BRACKET	2	PZ	0H7297A0	DOOR SUPPORT BRACKET	1	PZ	0H7321A0	MM STAINLESS STEEL HANDLE COVE	1	PZ	0H7778A0	XEVC-2011 RIGHT EXT DOOR COLUM	1	PZ	0H7780A0	16EU BAKER DOOR LEFT EXT COLUMN	1	PZ	CE1052A1	CABLE CONNECTION CONTROL - USB MM 750M	1	PZ	CE1053B0	MM MICROFIT LED BAR POWER SUPPLY CABL	1	PZ	CE1455A0	TIP END FITTING	4	PZ	CE1725A0	ROBOTICS SILICON PIPE 4X0,5 MMQ	4	M	CE1735A0	MINIFIT FEMALE END FITTING	4	PZ
Code	Description	Qty	UOM																																																																						
0H1604A0	BIG OVENS GLASS HOLDING PLATE HOLE COVER	2	PZ																																																																						
0H7240A2	XEVC-2011 RIGHT INT DOOR COLUM	1	PZ																																																																						
0H7241A1	XEVC-2011 LEFT INT DOOR COLUM	1	PZ																																																																						
0H7242A0	XEVC-2011 DOOR GLASS SUPPORT PLATE	2	PZ																																																																						
0H7243A0	XEVC-2011 LOWER DOOR PROFILE	1	PZ																																																																						
0H7247A0	XEVC-2011 UPPER DOOR PROFILE	1	PZ																																																																						
0H7248B0	TROLLEY PUSHING CAM L SHAPED BRACKET	2	PZ																																																																						
0H7297A0	DOOR SUPPORT BRACKET	1	PZ																																																																						
0H7321A0	MM STAINLESS STEEL HANDLE COVE	1	PZ																																																																						
0H7778A0	XEVC-2011 RIGHT EXT DOOR COLUM	1	PZ																																																																						
0H7780A0	16EU BAKER DOOR LEFT EXT COLUMN	1	PZ																																																																						
CE1052A1	CABLE CONNECTION CONTROL - USB MM 750M	1	PZ																																																																						
CE1053B0	MM MICROFIT LED BAR POWER SUPPLY CABL	1	PZ																																																																						
CE1455A0	TIP END FITTING	4	PZ																																																																						
CE1725A0	ROBOTICS SILICON PIPE 4X0,5 MMQ	4	M																																																																						
CE1735A0	MINIFIT FEMALE END FITTING	4	PZ																																																																						



COMPONENT			SPARE PART																																																																						
Code	Description	Image	Code	Description	Components list																																																																				
VT1300A	EXTER. GLASS XEVC-2011-E		KDR7780A	BAKERTOP 16EU RIGHT EXTERNAL DOOR KIT	<table border="1"> <thead> <tr> <th>Code</th> <th>Description</th> <th>Qty</th> <th>UOM</th> </tr> </thead> <tbody> <tr> <td>CE1755A0</td> <td>4 WAYS MALE MINIFIT CONNECTOR</td> <td>1</td> <td>PZ</td> </tr> <tr> <td>IP1508A1</td> <td>POLYSTYREN E U SHAPED PROFILE 2000X60X60</td> <td>2</td> <td>M</td> </tr> <tr> <td>PE2046A2</td> <td>MM POWER SWITCH AND USB BOARD</td> <td>1</td> <td>PZ</td> </tr> <tr> <td>RC1200A0</td> <td>ED=4 WIRE D.=0.5 COMPRESSIO N SPRING</td> <td>4</td> <td>PZ</td> </tr> <tr> <td>TB2911A1</td> <td>XEVC-2011-E DOOR BEAM</td> <td>1</td> <td>PZ</td> </tr> <tr> <td>TB3204A0</td> <td>XEVC-2011-E UPPER DOOR BEAM</td> <td>1</td> <td>PZ</td> </tr> <tr> <td>VE1030A1</td> <td>MAGNET FOR DOOR MICROSWITC H D=22.9MM</td> <td>1</td> <td>PZ</td> </tr> <tr> <td>VI0239A1</td> <td>SELF-TAPPIN G SCREW 4.2X25 TCB+ INOX</td> <td>4</td> <td>PZ</td> </tr> <tr> <td>VI1220A1</td> <td>4,2X12 TCB SELF-TAPPIN G SCREW</td> <td>57</td> <td>PZ</td> </tr> <tr> <td>VI1300A0</td> <td>SCREW M6X12 T1/2T+INOX</td> <td>12</td> <td>PZ</td> </tr> <tr> <td>VI1310A0</td> <td>ZINC THREAD INSERT M6 FTR/E</td> <td>12</td> <td>PZ</td> </tr> <tr> <td>VI1910A0</td> <td>ST STEEL TCEI SCREW M6X35 PARTIAL THREAD</td> <td>2</td> <td>PZ</td> </tr> <tr> <td>VI1930A0</td> <td>5X25 ST. STEEL SCREW CHIP</td> <td>14</td> <td>PZ</td> </tr> <tr> <td>VI1982A0</td> <td>M6 ST. STEEL BLIND THREADED INSERT</td> <td>2</td> <td>PZ</td> </tr> <tr> <td>VI1995A0</td> <td>M5X25 ST.STEEL SCREW</td> <td>13</td> <td>PZ</td> </tr> <tr> <td>VM1059A1</td> <td>HEAT SHRINK FILM H800</td> <td>2</td> <td>M</td> </tr> </tbody> </table>	Code	Description	Qty	UOM	CE1755A0	4 WAYS MALE MINIFIT CONNECTOR	1	PZ	IP1508A1	POLYSTYREN E U SHAPED PROFILE 2000X60X60	2	M	PE2046A2	MM POWER SWITCH AND USB BOARD	1	PZ	RC1200A0	ED=4 WIRE D.=0.5 COMPRESSIO N SPRING	4	PZ	TB2911A1	XEVC-2011-E DOOR BEAM	1	PZ	TB3204A0	XEVC-2011-E UPPER DOOR BEAM	1	PZ	VE1030A1	MAGNET FOR DOOR MICROSWITC H D=22.9MM	1	PZ	VI0239A1	SELF-TAPPIN G SCREW 4.2X25 TCB+ INOX	4	PZ	VI1220A1	4,2X12 TCB SELF-TAPPIN G SCREW	57	PZ	VI1300A0	SCREW M6X12 T1/2T+INOX	12	PZ	VI1310A0	ZINC THREAD INSERT M6 FTR/E	12	PZ	VI1910A0	ST STEEL TCEI SCREW M6X35 PARTIAL THREAD	2	PZ	VI1930A0	5X25 ST. STEEL SCREW CHIP	14	PZ	VI1982A0	M6 ST. STEEL BLIND THREADED INSERT	2	PZ	VI1995A0	M5X25 ST.STEEL SCREW	13	PZ	VM1059A1	HEAT SHRINK FILM H800	2	M
Code	Description	Qty	UOM																																																																						
CE1755A0	4 WAYS MALE MINIFIT CONNECTOR	1	PZ																																																																						
IP1508A1	POLYSTYREN E U SHAPED PROFILE 2000X60X60	2	M																																																																						
PE2046A2	MM POWER SWITCH AND USB BOARD	1	PZ																																																																						
RC1200A0	ED=4 WIRE D.=0.5 COMPRESSIO N SPRING	4	PZ																																																																						
TB2911A1	XEVC-2011-E DOOR BEAM	1	PZ																																																																						
TB3204A0	XEVC-2011-E UPPER DOOR BEAM	1	PZ																																																																						
VE1030A1	MAGNET FOR DOOR MICROSWITC H D=22.9MM	1	PZ																																																																						
VI0239A1	SELF-TAPPIN G SCREW 4.2X25 TCB+ INOX	4	PZ																																																																						
VI1220A1	4,2X12 TCB SELF-TAPPIN G SCREW	57	PZ																																																																						
VI1300A0	SCREW M6X12 T1/2T+INOX	12	PZ																																																																						
VI1310A0	ZINC THREAD INSERT M6 FTR/E	12	PZ																																																																						
VI1910A0	ST STEEL TCEI SCREW M6X35 PARTIAL THREAD	2	PZ																																																																						
VI1930A0	5X25 ST. STEEL SCREW CHIP	14	PZ																																																																						
VI1982A0	M6 ST. STEEL BLIND THREADED INSERT	2	PZ																																																																						
VI1995A0	M5X25 ST.STEEL SCREW	13	PZ																																																																						
VM1059A1	HEAT SHRINK FILM H800	2	M																																																																						









COMPONENT			SPARE PART																																																																																		
Code	Description	Image	Code	Description	Components list																																																																																
VT1300A	EXTER. GLASS XEVC-2011-E		KDR7780A	BAKERTOP 16EU RIGHT EXTERNAL DOOR KIT	<table border="1"> <thead> <tr> <th>Code</th> <th>Description</th> <th>Qty</th> <th>UOM</th> </tr> </thead> <tbody> <tr> <td>VM1182B1</td> <td>E S. CT BT HANDLE JUNCTION + PIN GUIDE</td> <td>1</td> <td>PZ</td> </tr> <tr> <td>VM1183B0</td> <td>CHEFTOP/BAK ERTOP HANDLE PIN</td> <td>1</td> <td>PZ</td> </tr> <tr> <td>VM1183B1</td> <td>CT BT HANDLE PIN</td> <td>1</td> <td>PZ</td> </tr> <tr> <td>VM1183C0</td> <td>CT BT HANDLE T-SHAPED PIN KIT</td> <td>1</td> <td>PZ</td> </tr> <tr> <td>VM1490A0</td> <td>CHEFTOP/BAK ERTOP HANDLE SCREWS COVER</td> <td>2</td> <td>PZ</td> </tr> <tr> <td>VM1630A0</td> <td>INTERNAL GLASS PUSHING CAP</td> <td>1</td> <td>PZ</td> </tr> <tr> <td>VM1630A1</td> <td>XB/XV/XVC/XG TERMINAL COVERING BO</td> <td>1</td> <td>PZ</td> </tr> <tr> <td>VM1631A0</td> <td></td> <td>1</td> <td>PZ</td> </tr> <tr> <td>VM1695A0</td> <td>HANDLE POSITION PIN</td> <td>4</td> <td>PZ</td> </tr> <tr> <td>VM2245A0</td> <td>HANDLE SHAFT WITH LATCH</td> <td>1</td> <td>PZ</td> </tr> <tr> <td>VM2247A0</td> <td>HANDLE SHAFT COVER VM2245-2246</td> <td>1</td> <td>PZ</td> </tr> <tr> <td>VM2247B0</td> <td>HANDLE SHAFT COVER VM2245-2246</td> <td>1</td> <td>PZ</td> </tr> <tr> <td>VM2248B0</td> <td>HANDLE WITH LATCH CLOSING KEY</td> <td>1</td> <td>PZ</td> </tr> <tr> <td>VM2263A0</td> <td>MM BIG DOOR LOWER LEFT CAP</td> <td>1</td> <td>PZ</td> </tr> <tr> <td>VM2264A0</td> <td>MM BIG DOOR UPPER CAP</td> <td>1</td> <td>PZ</td> </tr> <tr> <td>VM2265A0</td> <td>MM BIG DOOR LOWER RIGHT CAP</td> <td>1</td> <td>PZ</td> </tr> <tr> <td>VM2266A0</td> <td>MM BIG DOOR RIGHT UPPER CAP</td> <td>1</td> <td>PZ</td> </tr> <tr> <td>VM2268A0</td> <td>DOOR MAGNET COVER</td> <td>1</td> <td>PZ</td> </tr> <tr> <td>VM2274A0</td> <td>GROOVED BUSHING</td> <td>1</td> <td>PZ</td> </tr> </tbody> </table>	Code	Description	Qty	UOM	VM1182B1	E S. CT BT HANDLE JUNCTION + PIN GUIDE	1	PZ	VM1183B0	CHEFTOP/BAK ERTOP HANDLE PIN	1	PZ	VM1183B1	CT BT HANDLE PIN	1	PZ	VM1183C0	CT BT HANDLE T-SHAPED PIN KIT	1	PZ	VM1490A0	CHEFTOP/BAK ERTOP HANDLE SCREWS COVER	2	PZ	VM1630A0	INTERNAL GLASS PUSHING CAP	1	PZ	VM1630A1	XB/XV/XVC/XG TERMINAL COVERING BO	1	PZ	VM1631A0		1	PZ	VM1695A0	HANDLE POSITION PIN	4	PZ	VM2245A0	HANDLE SHAFT WITH LATCH	1	PZ	VM2247A0	HANDLE SHAFT COVER VM2245-2246	1	PZ	VM2247B0	HANDLE SHAFT COVER VM2245-2246	1	PZ	VM2248B0	HANDLE WITH LATCH CLOSING KEY	1	PZ	VM2263A0	MM BIG DOOR LOWER LEFT CAP	1	PZ	VM2264A0	MM BIG DOOR UPPER CAP	1	PZ	VM2265A0	MM BIG DOOR LOWER RIGHT CAP	1	PZ	VM2266A0	MM BIG DOOR RIGHT UPPER CAP	1	PZ	VM2268A0	DOOR MAGNET COVER	1	PZ	VM2274A0	GROOVED BUSHING	1	PZ
Code	Description	Qty	UOM																																																																																		
VM1182B1	E S. CT BT HANDLE JUNCTION + PIN GUIDE	1	PZ																																																																																		
VM1183B0	CHEFTOP/BAK ERTOP HANDLE PIN	1	PZ																																																																																		
VM1183B1	CT BT HANDLE PIN	1	PZ																																																																																		
VM1183C0	CT BT HANDLE T-SHAPED PIN KIT	1	PZ																																																																																		
VM1490A0	CHEFTOP/BAK ERTOP HANDLE SCREWS COVER	2	PZ																																																																																		
VM1630A0	INTERNAL GLASS PUSHING CAP	1	PZ																																																																																		
VM1630A1	XB/XV/XVC/XG TERMINAL COVERING BO	1	PZ																																																																																		
VM1631A0		1	PZ																																																																																		
VM1695A0	HANDLE POSITION PIN	4	PZ																																																																																		
VM2245A0	HANDLE SHAFT WITH LATCH	1	PZ																																																																																		
VM2247A0	HANDLE SHAFT COVER VM2245-2246	1	PZ																																																																																		
VM2247B0	HANDLE SHAFT COVER VM2245-2246	1	PZ																																																																																		
VM2248B0	HANDLE WITH LATCH CLOSING KEY	1	PZ																																																																																		
VM2263A0	MM BIG DOOR LOWER LEFT CAP	1	PZ																																																																																		
VM2264A0	MM BIG DOOR UPPER CAP	1	PZ																																																																																		
VM2265A0	MM BIG DOOR LOWER RIGHT CAP	1	PZ																																																																																		
VM2266A0	MM BIG DOOR RIGHT UPPER CAP	1	PZ																																																																																		
VM2268A0	DOOR MAGNET COVER	1	PZ																																																																																		
VM2274A0	GROOVED BUSHING	1	PZ																																																																																		

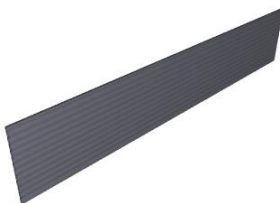

COMPONENT			SPARE PART					
Code	Description	Image	Code	Description	Components list			
VT1300A	EXTER. GLASS XEVC-2011-E		KDR7780A	BAKERTOP 16EU RIGHT EXTERNAL DOOR KIT	Code	Description	Qty	UOM
					VM2275A0	SMOOTH BUSHING	1	PZ
					VM2295A0	STYLUS PEN FOR MM	1	PZ
					VM2305A0	6 SERIES DOOR CAP FIXING PAWL	10	PZ
					VM2315A0	MIND.MAPS INTERNAL GLASS CAP SUPPORT	1	PZ
					VM2355A0	XEVC-2011 INTERNAL GLASS LOCKING KIT	2	PZ
					VM2355A0	XEVC-2011 INTERNAL GLASS LOCKING KIT	2	PZ
					VM2371A0	DOUBLE GLASS DOOR PUSHING BRACKET	1	PZ
					VM2371A0	DOUBLE GLASS DOOR PUSHING BRACKET	1	PZ
					VM2410A0	PLATE TO STOP EXTRUDED LED BAR	4	PZ
					VM2410A0	PLATE TO STOP EXTRUDED LED BAR	4	PZ
					VM2505A0	MM PLUS INTERNAL GLASS SUPPORT	1	PZ
					VM2518A0	BOARD COOLING FAN SUPPORT	1	PZ
					VM2518A0	BOARD COOLING FAN SUPPORT	1	PZ
					VN1179A0	CONTROL BOARD 40X40X20MM 12V COOLING FAN	1	PZ
					VN1179A0	CONTROL BOARD 40X40X20MM 12V COOLING FAN	1	PZ

COMPONENT			SPARE PART																																																														
Code	Description	Image	Code	Description	Components list																																																												
VT1300A	EXTER. GLASS XEVC-2011-E		KDR7780A	BAKERTOP 16EU RIGHT EXTERNAL DOOR KIT	<table border="1"> <thead> <tr> <th>Code</th> <th>Description</th> <th>Qty</th> <th>UOM</th> </tr> </thead> <tbody> <tr> <td>VN1179A1</td> <td>CONTROL BOARD 40X40X20MM 12V COOLING FAN</td> <td>1</td> <td>PZ</td> </tr> <tr> <td>VT1300A0</td> <td>EXTER. GLASS XEVC-2011-E</td> <td>1</td> <td>PZ</td> </tr> <tr> <td>VT1300A0</td> <td>EXTER. GLASS XEVC-2011-E</td> <td>1</td> <td>PZ</td> </tr> </tbody> </table>	Code	Description	Qty	UOM	VN1179A1	CONTROL BOARD 40X40X20MM 12V COOLING FAN	1	PZ	VT1300A0	EXTER. GLASS XEVC-2011-E	1	PZ	VT1300A0	EXTER. GLASS XEVC-2011-E	1	PZ																																												
Code	Description	Qty	UOM																																																														
VN1179A1	CONTROL BOARD 40X40X20MM 12V COOLING FAN	1	PZ																																																														
VT1300A0	EXTER. GLASS XEVC-2011-E	1	PZ																																																														
VT1300A0	EXTER. GLASS XEVC-2011-E	1	PZ																																																														
VT1299A	XEVC-2011-E INTERNAL GLASS		KVT1299A	2011-2021-16EU INTERNAL GLASS KI	<table border="1"> <thead> <tr> <th>Code</th> <th>Description</th> <th>Qty</th> <th>UOM</th> </tr> </thead> <tbody> <tr> <td>0H1946A0</td> <td>BIG DOOR INTERNAL GLASS PLATE THICKNESS</td> <td>1</td> <td>PZ</td> </tr> <tr> <td>0H7244A0</td> <td>XEVC-2011 INT.DOOR GLASS LOWER FRAM</td> <td>1</td> <td>PZ</td> </tr> <tr> <td>0H7245A0</td> <td>XEVC-2011 INT.DOOR GLASS UPPER FRAME</td> <td>1</td> <td>PZ</td> </tr> <tr> <td>0H7246A0</td> <td>XEVC-2011 GASKET HOLDER PLAT</td> <td>1</td> <td>PZ</td> </tr> <tr> <td>GN1341B0</td> <td>DOOR-TROLL EY SEALING</td> <td>0.750</td> <td>M</td> </tr> <tr> <td>IL1050B0</td> <td>WOODEN PALLET 965X875X123</td> <td>2</td> <td>PZ</td> </tr> <tr> <td>IP1385A1</td> <td>CORNER POLYSTYREN E PACKING 110X80X2000</td> <td>3</td> <td>M</td> </tr> <tr> <td>SL1170A1</td> <td>S57 BLACK SILICON - 310ML CARTRIDGE</td> <td>1</td> <td>ML</td> </tr> <tr> <td>TB2912A0</td> <td>DOOR GASKET PIN XEVC-2011-E</td> <td>2</td> <td>PZ</td> </tr> <tr> <td>VI1075A0</td> <td>NUT M4 H=4 UNI5587 INOX</td> <td>3</td> <td>PZ</td> </tr> <tr> <td>VI1511A0</td> <td>STAINLESS STEEL WASHER 4.2X12X1</td> <td>3</td> <td>PZ</td> </tr> <tr> <td>VI1925A0</td> <td>ST STEEL STUD BOLT M4X8</td> <td>3</td> <td>PZ</td> </tr> <tr> <td>VT1299A0</td> <td>XEVC-2011-E INTERNAL GLASS</td> <td>1</td> <td>PZ</td> </tr> <tr> <td>VT1299A0</td> <td>XEVC-2011-E INTERNAL GLASS</td> <td>1</td> <td>PZ</td> </tr> </tbody> </table>	Code	Description	Qty	UOM	0H1946A0	BIG DOOR INTERNAL GLASS PLATE THICKNESS	1	PZ	0H7244A0	XEVC-2011 INT.DOOR GLASS LOWER FRAM	1	PZ	0H7245A0	XEVC-2011 INT.DOOR GLASS UPPER FRAME	1	PZ	0H7246A0	XEVC-2011 GASKET HOLDER PLAT	1	PZ	GN1341B0	DOOR-TROLL EY SEALING	0.750	M	IL1050B0	WOODEN PALLET 965X875X123	2	PZ	IP1385A1	CORNER POLYSTYREN E PACKING 110X80X2000	3	M	SL1170A1	S57 BLACK SILICON - 310ML CARTRIDGE	1	ML	TB2912A0	DOOR GASKET PIN XEVC-2011-E	2	PZ	VI1075A0	NUT M4 H=4 UNI5587 INOX	3	PZ	VI1511A0	STAINLESS STEEL WASHER 4.2X12X1	3	PZ	VI1925A0	ST STEEL STUD BOLT M4X8	3	PZ	VT1299A0	XEVC-2011-E INTERNAL GLASS	1	PZ	VT1299A0	XEVC-2011-E INTERNAL GLASS	1	PZ
Code	Description	Qty	UOM																																																														
0H1946A0	BIG DOOR INTERNAL GLASS PLATE THICKNESS	1	PZ																																																														
0H7244A0	XEVC-2011 INT.DOOR GLASS LOWER FRAM	1	PZ																																																														
0H7245A0	XEVC-2011 INT.DOOR GLASS UPPER FRAME	1	PZ																																																														
0H7246A0	XEVC-2011 GASKET HOLDER PLAT	1	PZ																																																														
GN1341B0	DOOR-TROLL EY SEALING	0.750	M																																																														
IL1050B0	WOODEN PALLET 965X875X123	2	PZ																																																														
IP1385A1	CORNER POLYSTYREN E PACKING 110X80X2000	3	M																																																														
SL1170A1	S57 BLACK SILICON - 310ML CARTRIDGE	1	ML																																																														
TB2912A0	DOOR GASKET PIN XEVC-2011-E	2	PZ																																																														
VI1075A0	NUT M4 H=4 UNI5587 INOX	3	PZ																																																														
VI1511A0	STAINLESS STEEL WASHER 4.2X12X1	3	PZ																																																														
VI1925A0	ST STEEL STUD BOLT M4X8	3	PZ																																																														
VT1299A0	XEVC-2011-E INTERNAL GLASS	1	PZ																																																														
VT1299A0	XEVC-2011-E INTERNAL GLASS	1	PZ																																																														

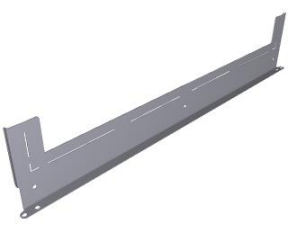
COMPONENT			SPARE PART																																		
Code	Description	Image	Code	Description	Components list																																
GN1553A	XEVC-2011-E DOOR-TROLLEY SEALING		KG1553A	MIND.MAPS DOOR-TROLLEY GASKET KIT	<table border="1"> <thead> <tr> <th>Code</th> <th>Description</th> <th>Qty</th> <th>UOM</th> </tr> </thead> <tbody> <tr> <td>0H7246A0</td> <td>XEVC-2011 GASKET HOLDER PLAT</td> <td>1</td> <td>PZ</td> </tr> <tr> <td>GN1341B0</td> <td>DOOR-TROLL EY SEALING</td> <td>0.750</td> <td>M</td> </tr> <tr> <td>SL1170A1</td> <td>S57 BLACK SILICON - 310ML CARTRIDGE</td> <td>280</td> <td>ML</td> </tr> <tr> <td>TB2912A0</td> <td>DOOR GASKET PIN XEVC-2011-E</td> <td>2</td> <td>PZ</td> </tr> <tr> <td>VI1075A0</td> <td>NUT M4 H=4 UNI5587 INOX</td> <td>3</td> <td>PZ</td> </tr> <tr> <td>VI1511A0</td> <td>STAINLESS STEEL WASHER 4.2X12X1</td> <td>3</td> <td>PZ</td> </tr> <tr> <td>VI1925A0</td> <td>ST STEEL STUD BOLT M4X8</td> <td>3</td> <td>PZ</td> </tr> </tbody> </table>	Code	Description	Qty	UOM	0H7246A0	XEVC-2011 GASKET HOLDER PLAT	1	PZ	GN1341B0	DOOR-TROLL EY SEALING	0.750	M	SL1170A1	S57 BLACK SILICON - 310ML CARTRIDGE	280	ML	TB2912A0	DOOR GASKET PIN XEVC-2011-E	2	PZ	VI1075A0	NUT M4 H=4 UNI5587 INOX	3	PZ	VI1511A0	STAINLESS STEEL WASHER 4.2X12X1	3	PZ	VI1925A0	ST STEEL STUD BOLT M4X8	3	PZ
Code	Description	Qty	UOM																																		
0H7246A0	XEVC-2011 GASKET HOLDER PLAT	1	PZ																																		
GN1341B0	DOOR-TROLL EY SEALING	0.750	M																																		
SL1170A1	S57 BLACK SILICON - 310ML CARTRIDGE	280	ML																																		
TB2912A0	DOOR GASKET PIN XEVC-2011-E	2	PZ																																		
VI1075A0	NUT M4 H=4 UNI5587 INOX	3	PZ																																		
VI1511A0	STAINLESS STEEL WASHER 4.2X12X1	3	PZ																																		
VI1925A0	ST STEEL STUD BOLT M4X8	3	PZ																																		
TB2912A	DOOR GASKET PIN XEVC-2011-E		TB2912A0	DOOR GASKET PIN XEVC-2011-E																																	
0H7246A	XEVC-2011 GASKET HOLDER PLATE		KG1553A	MIND.MAPS DOOR-TROLLEY GASKET KIT	<table border="1"> <thead> <tr> <th>Code</th> <th>Description</th> <th>Qty</th> <th>UOM</th> </tr> </thead> <tbody> <tr> <td>0H7246A0</td> <td>XEVC-2011 GASKET HOLDER PLAT</td> <td>1</td> <td>PZ</td> </tr> <tr> <td>GN1341B0</td> <td>DOOR-TROLL EY SEALING</td> <td>0.750</td> <td>M</td> </tr> <tr> <td>SL1170A1</td> <td>S57 BLACK SILICON - 310ML CARTRIDGE</td> <td>280</td> <td>ML</td> </tr> <tr> <td>TB2912A0</td> <td>DOOR GASKET PIN XEVC-2011-E</td> <td>2</td> <td>PZ</td> </tr> <tr> <td>VI1075A0</td> <td>NUT M4 H=4 UNI5587 INOX</td> <td>3</td> <td>PZ</td> </tr> <tr> <td>VI1511A0</td> <td>STAINLESS STEEL WASHER 4.2X12X1</td> <td>3</td> <td>PZ</td> </tr> <tr> <td>VI1925A0</td> <td>ST STEEL STUD BOLT M4X8</td> <td>3</td> <td>PZ</td> </tr> </tbody> </table>	Code	Description	Qty	UOM	0H7246A0	XEVC-2011 GASKET HOLDER PLAT	1	PZ	GN1341B0	DOOR-TROLL EY SEALING	0.750	M	SL1170A1	S57 BLACK SILICON - 310ML CARTRIDGE	280	ML	TB2912A0	DOOR GASKET PIN XEVC-2011-E	2	PZ	VI1075A0	NUT M4 H=4 UNI5587 INOX	3	PZ	VI1511A0	STAINLESS STEEL WASHER 4.2X12X1	3	PZ	VI1925A0	ST STEEL STUD BOLT M4X8	3	PZ
Code	Description	Qty	UOM																																		
0H7246A0	XEVC-2011 GASKET HOLDER PLAT	1	PZ																																		
GN1341B0	DOOR-TROLL EY SEALING	0.750	M																																		
SL1170A1	S57 BLACK SILICON - 310ML CARTRIDGE	280	ML																																		
TB2912A0	DOOR GASKET PIN XEVC-2011-E	2	PZ																																		
VI1075A0	NUT M4 H=4 UNI5587 INOX	3	PZ																																		
VI1511A0	STAINLESS STEEL WASHER 4.2X12X1	3	PZ																																		
VI1925A0	ST STEEL STUD BOLT M4X8	3	PZ																																		

COMPONENT			SPARE PART																																						
Code	Description	Image	Code	Description	Components list																																				
0H7246A	XEVC-2011 GASKET HOLDER PLATE		KGN1341B	1005E-4005E TROLLEY DOOR GASKET KIT	<table border="1"> <thead> <tr> <th>Code</th> <th>Description</th> <th>Qty</th> <th>UOM</th> </tr> </thead> <tbody> <tr> <td>0H3178A0</td> <td>SERIE1000-40 00 GASKET HOLDER PLAT</td> <td>1</td> <td>PZ</td> </tr> <tr> <td>0H4936A0</td> <td>DRILL GUIDE</td> <td>1</td> <td>PZ</td> </tr> <tr> <td>GN1341B0</td> <td>DOOR-TROLL EY SEALING</td> <td>0.730</td> <td>M</td> </tr> <tr> <td>SL1170A1</td> <td>S57 BLACK SILICON - 310ML CARTRIDGE</td> <td>280</td> <td>ML</td> </tr> <tr> <td>TB2305A0</td> <td>5E BIG SERIES DOOR PIN</td> <td>2</td> <td>PZ</td> </tr> <tr> <td>VI1075A0</td> <td>NUT M4 H=4 UNI5587 INOX</td> <td>3</td> <td>PZ</td> </tr> <tr> <td>VI1511A0</td> <td>STAINLESS STEEL WASHER 4.2X12X1</td> <td>3</td> <td>PZ</td> </tr> <tr> <td>VI1925A0</td> <td>ST STEEL STUD BOLT M4X8</td> <td>3</td> <td>PZ</td> </tr> </tbody> </table>	Code	Description	Qty	UOM	0H3178A0	SERIE1000-40 00 GASKET HOLDER PLAT	1	PZ	0H4936A0	DRILL GUIDE	1	PZ	GN1341B0	DOOR-TROLL EY SEALING	0.730	M	SL1170A1	S57 BLACK SILICON - 310ML CARTRIDGE	280	ML	TB2305A0	5E BIG SERIES DOOR PIN	2	PZ	VI1075A0	NUT M4 H=4 UNI5587 INOX	3	PZ	VI1511A0	STAINLESS STEEL WASHER 4.2X12X1	3	PZ	VI1925A0	ST STEEL STUD BOLT M4X8	3	PZ
Code	Description	Qty	UOM																																						
0H3178A0	SERIE1000-40 00 GASKET HOLDER PLAT	1	PZ																																						
0H4936A0	DRILL GUIDE	1	PZ																																						
GN1341B0	DOOR-TROLL EY SEALING	0.730	M																																						
SL1170A1	S57 BLACK SILICON - 310ML CARTRIDGE	280	ML																																						
TB2305A0	5E BIG SERIES DOOR PIN	2	PZ																																						
VI1075A0	NUT M4 H=4 UNI5587 INOX	3	PZ																																						
VI1511A0	STAINLESS STEEL WASHER 4.2X12X1	3	PZ																																						
VI1925A0	ST STEEL STUD BOLT M4X8	3	PZ																																						
0H7244A	XEVC-2011 INT.DOOR GLASS LOWER FRAME		0H7244A0	XEVC-2011 INT.DOOR GLASS LOWER FRAME																																					
0H7245A	XEVC-2011 INT.DOOR GLASS UPPER FRAME		0H7245A0	XEVC-2011 INT.DOOR GLASS UPPER FRAME																																					
VI1995A	M5X25 ST.STEEL SCREW		VI1995A0	M5X25 ST.STEEL SCREW																																					



COMPONENT			SPARE PART														
Code	Description	Image	Code	Description	Components list												
VM2305A	6 SERIES DOOR CAP FIXING PAWL		KVM2305A	MM FIXING DOOR THUB SCREWS 10 PCS KIT	<table border="1"> <thead> <tr> <th>Code</th> <th>Description</th> <th>Qty</th> <th>UOM</th> </tr> </thead> <tbody> <tr> <td>VM1224A0</td> <td></td> <td>0.200</td> <td>M</td> </tr> <tr> <td>VM2305A0</td> <td>6 SERIES DOOR CAP FIXING PAWL</td> <td>10</td> <td>PZ</td> </tr> </tbody> </table>	Code	Description	Qty	UOM	VM1224A0		0.200	M	VM2305A0	6 SERIES DOOR CAP FIXING PAWL	10	PZ
Code	Description	Qty	UOM														
VM1224A0		0.200	M														
VM2305A0	6 SERIES DOOR CAP FIXING PAWL	10	PZ														
VM2275A	SMOOTH BUSHING		KVM2275A	SMOOTH PIN BUSHING KIT	<table border="1"> <thead> <tr> <th>Code</th> <th>Description</th> <th>Qty</th> <th>UOM</th> </tr> </thead> <tbody> <tr> <td>VM1224A0</td> <td></td> <td>0.150</td> <td>M</td> </tr> <tr> <td>VM2275A0</td> <td>SMOOTH BUSHING</td> <td>1</td> <td>PZ</td> </tr> </tbody> </table>	Code	Description	Qty	UOM	VM1224A0		0.150	M	VM2275A0	SMOOTH BUSHING	1	PZ
Code	Description	Qty	UOM														
VM1224A0		0.150	M														
VM2275A0	SMOOTH BUSHING	1	PZ														
VM2264A	MM BIG DOOR UPPER CAP		KVM2264A	MM TROLLEY OVEN DOOR LEFT UPPER CAP KIT	<table border="1"> <thead> <tr> <th>Code</th> <th>Description</th> <th>Qty</th> <th>UOM</th> </tr> </thead> <tbody> <tr> <td>VM1224A0</td> <td></td> <td>0.250</td> <td>M</td> </tr> <tr> <td>VM2264A0</td> <td>MM BIG DOOR UPPER CAP</td> <td>1</td> <td>PZ</td> </tr> </tbody> </table>	Code	Description	Qty	UOM	VM1224A0		0.250	M	VM2264A0	MM BIG DOOR UPPER CAP	1	PZ
Code	Description	Qty	UOM														
VM1224A0		0.250	M														
VM2264A0	MM BIG DOOR UPPER CAP	1	PZ														
VM2266A	MM BIG DOOR RIGHT UPPER CAP		VM2266A0	MM BIG DOOR RIGHT UPPER CAP													
0H7247A	XEVC-2011 UPPER DOOR PROFILE		0H7247A0	XEVC-2011 UPPER DOOR PROFILE													





COMPONENT			SPARE PART																																																							
Code	Description	Image	Code	Description	Components list																																																					
VM2274A	GROOVED BUSHING		KVM2274A	GROOVED PIN BUSHING KIT	<table border="1"> <thead> <tr> <th>Code</th> <th>Description</th> <th>Qty</th> <th>UOM</th> </tr> </thead> <tbody> <tr> <td>VM1224A0</td> <td></td> <td>0.150</td> <td>M</td> </tr> <tr> <td>VM2274A0</td> <td>GROOVED BUSHING</td> <td>1</td> <td>PZ</td> </tr> </tbody> </table>	Code	Description	Qty	UOM	VM1224A0		0.150	M	VM2274A0	GROOVED BUSHING	1	PZ																																									
			Code	Description	Qty	UOM																																																				
VM1224A0		0.150	M																																																							
VM2274A0	GROOVED BUSHING	1	PZ																																																							
K0B1126AR	BAKERTOP MM RIGHT DOOR LOWER BEAM KIT	<table border="1"> <thead> <tr> <th>Code</th> <th>Description</th> <th>Qty</th> <th>UOM</th> </tr> </thead> <tbody> <tr> <td>0B1126A0</td> <td>DOOR LOWER FRAME SHAPE 860 MM</td> <td>1</td> <td>PZ</td> </tr> <tr> <td>0B1126A1</td> <td></td> <td>1</td> <td>PZ</td> </tr> <tr> <td>RC1200A0</td> <td>ED=4 WIRE D.=0.5 COMPRESSIO N SPRING</td> <td>2</td> <td>PZ</td> </tr> <tr> <td>VI1220A1</td> <td>4,2X12 TCB SELF-TAPPIN G SCREW</td> <td>1</td> <td>PZ</td> </tr> <tr> <td>VI1996A0</td> <td>M5X35 SCREW</td> <td>7</td> <td>PZ</td> </tr> <tr> <td>VM1794A0</td> <td>250X4.8 PA66 BLACK CLAMP</td> <td>2</td> <td>PZ</td> </tr> <tr> <td>VM2103A0</td> <td>CLAMP LOCK</td> <td>2</td> <td>PZ</td> </tr> <tr> <td>VM2259A1</td> <td>6 SERIES DOOR LOWER LEFT CAP</td> <td>1</td> <td>PZ</td> </tr> <tr> <td>VM2261A1</td> <td>6 SERIES DOOR LOWER RIGHT CAP</td> <td>1</td> <td>PZ</td> </tr> <tr> <td>VM2267A0</td> <td>INTERNAL GLASS LOCKING SYSTEM SLIDER</td> <td>1</td> <td>PZ</td> </tr> <tr> <td>VM2269A0</td> <td>INTERNAL GLASS LOCKING SYSTEM CAP</td> <td>1</td> <td>PZ</td> </tr> <tr> <td>VM2274A0</td> <td>GROOVED BUSHING</td> <td>1</td> <td>PZ</td> </tr> <tr> <td>VM2305A0</td> <td>6 SERIES DOOR CAP FIXING PAWL</td> <td>7</td> <td>PZ</td> </tr> </tbody> </table>	Code	Description	Qty	UOM	0B1126A0	DOOR LOWER FRAME SHAPE 860 MM	1	PZ	0B1126A1		1	PZ	RC1200A0	ED=4 WIRE D.=0.5 COMPRESSIO N SPRING	2	PZ	VI1220A1	4,2X12 TCB SELF-TAPPIN G SCREW	1	PZ	VI1996A0	M5X35 SCREW	7	PZ	VM1794A0	250X4.8 PA66 BLACK CLAMP	2	PZ	VM2103A0	CLAMP LOCK	2	PZ	VM2259A1	6 SERIES DOOR LOWER LEFT CAP	1	PZ	VM2261A1	6 SERIES DOOR LOWER RIGHT CAP	1	PZ	VM2267A0	INTERNAL GLASS LOCKING SYSTEM SLIDER	1	PZ	VM2269A0	INTERNAL GLASS LOCKING SYSTEM CAP	1	PZ	VM2274A0	GROOVED BUSHING	1	PZ	VM2305A0	6 SERIES DOOR CAP FIXING PAWL	7	PZ
Code	Description	Qty	UOM																																																							
0B1126A0	DOOR LOWER FRAME SHAPE 860 MM	1	PZ																																																							
0B1126A1		1	PZ																																																							
RC1200A0	ED=4 WIRE D.=0.5 COMPRESSIO N SPRING	2	PZ																																																							
VI1220A1	4,2X12 TCB SELF-TAPPIN G SCREW	1	PZ																																																							
VI1996A0	M5X35 SCREW	7	PZ																																																							
VM1794A0	250X4.8 PA66 BLACK CLAMP	2	PZ																																																							
VM2103A0	CLAMP LOCK	2	PZ																																																							
VM2259A1	6 SERIES DOOR LOWER LEFT CAP	1	PZ																																																							
VM2261A1	6 SERIES DOOR LOWER RIGHT CAP	1	PZ																																																							
VM2267A0	INTERNAL GLASS LOCKING SYSTEM SLIDER	1	PZ																																																							
VM2269A0	INTERNAL GLASS LOCKING SYSTEM CAP	1	PZ																																																							
VM2274A0	GROOVED BUSHING	1	PZ																																																							
VM2305A0	6 SERIES DOOR CAP FIXING PAWL	7	PZ																																																							
K0B1126AL	EU AND 2/1 MM LEFT DOOR LOWER BEAM KIT	<table border="1"> <thead> <tr> <th>Code</th> <th>Description</th> <th>Qty</th> <th>UOM</th> </tr> </thead> <tbody> <tr> <td>0B1126A0</td> <td>DOOR LOWER FRAME SHAPE 860 MM</td> <td>1</td> <td>PZ</td> </tr> <tr> <td>0B1126A1</td> <td></td> <td>1</td> <td>PZ</td> </tr> <tr> <td>RC1200A0</td> <td>ED=4 WIRE D.=0.5 COMPRESSIO N SPRING</td> <td>2</td> <td>PZ</td> </tr> <tr> <td>VI1220A1</td> <td>4,2X12 TCB SELF-TAPPIN G SCREW</td> <td>1</td> <td>PZ</td> </tr> <tr> <td>VI1996A0</td> <td>M5X35 SCREW</td> <td>7</td> <td>PZ</td> </tr> <tr> <td>VM1794A0</td> <td>250X4.8 PA66 BLACK CLAMP</td> <td>2</td> <td>PZ</td> </tr> </tbody> </table>	Code	Description	Qty	UOM	0B1126A0	DOOR LOWER FRAME SHAPE 860 MM	1	PZ	0B1126A1		1	PZ	RC1200A0	ED=4 WIRE D.=0.5 COMPRESSIO N SPRING	2	PZ	VI1220A1	4,2X12 TCB SELF-TAPPIN G SCREW	1	PZ	VI1996A0	M5X35 SCREW	7	PZ	VM1794A0	250X4.8 PA66 BLACK CLAMP	2	PZ																												
Code	Description	Qty	UOM																																																							
0B1126A0	DOOR LOWER FRAME SHAPE 860 MM	1	PZ																																																							
0B1126A1		1	PZ																																																							
RC1200A0	ED=4 WIRE D.=0.5 COMPRESSIO N SPRING	2	PZ																																																							
VI1220A1	4,2X12 TCB SELF-TAPPIN G SCREW	1	PZ																																																							
VI1996A0	M5X35 SCREW	7	PZ																																																							
VM1794A0	250X4.8 PA66 BLACK CLAMP	2	PZ																																																							





COMPONENT			SPARE PART																																										
Code	Description	Image	Code	Description	Components list																																								
VM2274A	GROOVED BUSHING		K0B1126AL	EU AND 2/1 MM LEFT DOOR LOWER BEAM KIT	<table border="1"> <thead> <tr> <th>Code</th> <th>Description</th> <th>Qty</th> <th>UOM</th> </tr> </thead> <tbody> <tr> <td>VM2103A0</td> <td>CLAMP LOCK</td> <td>2</td> <td>PZ</td> </tr> <tr> <td>VM2267A0</td> <td>INTERNAL GLASS LOCKING SYSTEM SLIDER</td> <td>1</td> <td>PZ</td> </tr> <tr> <td>VM2269A0</td> <td>INTERNAL GLASS LOCKING SYSTEM CAP</td> <td>1</td> <td>PZ</td> </tr> <tr> <td>VM2274A0</td> <td>GROOVED BUSHING</td> <td>1</td> <td>PZ</td> </tr> <tr> <td>VM2305A0</td> <td>6 SERIES DOOR CAP FIXING PAWL</td> <td>7</td> <td>PZ</td> </tr> <tr> <td>VM2384A0</td> <td>MM LEFT DOOR RIGHT LOWER CAP</td> <td>1</td> <td>PZ</td> </tr> <tr> <td>VM2384A0</td> <td>MM LEFT DOOR RIGHT LOWER CAP</td> <td>1</td> <td>PZ</td> </tr> <tr> <td>VM2386A1</td> <td>LEFT MM DOOR LOWER LEFT CAP</td> <td>1</td> <td>PZ</td> </tr> <tr> <td>VM2386A1</td> <td>LEFT MM DOOR LOWER LEFT CAP</td> <td>1</td> <td>PZ</td> </tr> </tbody> </table>	Code	Description	Qty	UOM	VM2103A0	CLAMP LOCK	2	PZ	VM2267A0	INTERNAL GLASS LOCKING SYSTEM SLIDER	1	PZ	VM2269A0	INTERNAL GLASS LOCKING SYSTEM CAP	1	PZ	VM2274A0	GROOVED BUSHING	1	PZ	VM2305A0	6 SERIES DOOR CAP FIXING PAWL	7	PZ	VM2384A0	MM LEFT DOOR RIGHT LOWER CAP	1	PZ	VM2384A0	MM LEFT DOOR RIGHT LOWER CAP	1	PZ	VM2386A1	LEFT MM DOOR LOWER LEFT CAP	1	PZ	VM2386A1	LEFT MM DOOR LOWER LEFT CAP	1	PZ
			Code	Description	Qty	UOM																																							
VM2103A0	CLAMP LOCK	2	PZ																																										
VM2267A0	INTERNAL GLASS LOCKING SYSTEM SLIDER	1	PZ																																										
VM2269A0	INTERNAL GLASS LOCKING SYSTEM CAP	1	PZ																																										
VM2274A0	GROOVED BUSHING	1	PZ																																										
VM2305A0	6 SERIES DOOR CAP FIXING PAWL	7	PZ																																										
VM2384A0	MM LEFT DOOR RIGHT LOWER CAP	1	PZ																																										
VM2384A0	MM LEFT DOOR RIGHT LOWER CAP	1	PZ																																										
VM2386A1	LEFT MM DOOR LOWER LEFT CAP	1	PZ																																										
VM2386A1	LEFT MM DOOR LOWER LEFT CAP	1	PZ																																										
K0B1122AR	CHEFTOP MM RIGHT DOOR LOWER BEAM KIT	<table border="1"> <thead> <tr> <th>Code</th> <th>Description</th> <th>Qty</th> <th>UOM</th> </tr> </thead> <tbody> <tr> <td>0B1122A0</td> <td>750MM DOOR LOWER FRAME SHAPE</td> <td>1</td> <td>PZ</td> </tr> <tr> <td>0B1122A1</td> <td>750MM DOOR LOWER FRAME SHAPE</td> <td>1</td> <td>PZ</td> </tr> <tr> <td>RC1200A0</td> <td>ED=4 WIRE D.=0.5 COMPRESSIO N SPRING</td> <td>2</td> <td>PZ</td> </tr> <tr> <td>VI1220A1</td> <td>4,2X12 TCB SELF-TAPPIN G SCREW</td> <td>1</td> <td>PZ</td> </tr> <tr> <td>VI1996A0</td> <td>M5X35 SCREW</td> <td>7</td> <td>PZ</td> </tr> <tr> <td>VM1794A0</td> <td>250X4.8 PA66 BLACK CLAMP</td> <td>2</td> <td>PZ</td> </tr> <tr> <td>VM2103A0</td> <td>CLAMP LOCK</td> <td>2</td> <td>PZ</td> </tr> <tr> <td>VM2259A1</td> <td>6 SERIES DOOR LOWER LEFT CAP</td> <td>1</td> <td>PZ</td> </tr> <tr> <td>VM2261A1</td> <td>6 SERIES DOOR LOWER RIGHT CAP</td> <td>1</td> <td>PZ</td> </tr> </tbody> </table>	Code	Description	Qty	UOM	0B1122A0	750MM DOOR LOWER FRAME SHAPE	1	PZ	0B1122A1	750MM DOOR LOWER FRAME SHAPE	1	PZ	RC1200A0	ED=4 WIRE D.=0.5 COMPRESSIO N SPRING	2	PZ	VI1220A1	4,2X12 TCB SELF-TAPPIN G SCREW	1	PZ	VI1996A0	M5X35 SCREW	7	PZ	VM1794A0	250X4.8 PA66 BLACK CLAMP	2	PZ	VM2103A0	CLAMP LOCK	2	PZ	VM2259A1	6 SERIES DOOR LOWER LEFT CAP	1	PZ	VM2261A1	6 SERIES DOOR LOWER RIGHT CAP	1	PZ			
Code	Description	Qty	UOM																																										
0B1122A0	750MM DOOR LOWER FRAME SHAPE	1	PZ																																										
0B1122A1	750MM DOOR LOWER FRAME SHAPE	1	PZ																																										
RC1200A0	ED=4 WIRE D.=0.5 COMPRESSIO N SPRING	2	PZ																																										
VI1220A1	4,2X12 TCB SELF-TAPPIN G SCREW	1	PZ																																										
VI1996A0	M5X35 SCREW	7	PZ																																										
VM1794A0	250X4.8 PA66 BLACK CLAMP	2	PZ																																										
VM2103A0	CLAMP LOCK	2	PZ																																										
VM2259A1	6 SERIES DOOR LOWER LEFT CAP	1	PZ																																										
VM2261A1	6 SERIES DOOR LOWER RIGHT CAP	1	PZ																																										







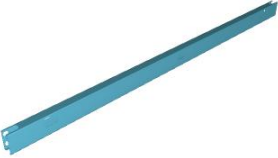

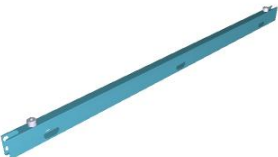
COMPONENT			SPARE PART																																																															
Code	Description	Image	Code	Description	Components list																																																													
VM2274A	GROOVED BUSHING		K0B1122AR	CHEFTOP MM RIGHT DOOR LOWER BEAM KIT	<table border="1"> <thead> <tr> <th>Code</th> <th>Description</th> <th>Qty</th> <th>UOM</th> </tr> </thead> <tbody> <tr> <td>VM2267A0</td> <td>INTERNAL GLASS LOCKING SYSTEM SLIDER</td> <td>1</td> <td>PZ</td> </tr> <tr> <td>VM2269A0</td> <td>INTERNAL GLASS LOCKING SYSTEM CAP</td> <td>1</td> <td>PZ</td> </tr> <tr> <td>VM2274A0</td> <td>GROOVED BUSHING</td> <td>1</td> <td>PZ</td> </tr> <tr> <td>VM2305A0</td> <td>6 SERIES DOOR CAP FIXING PAWL</td> <td>7</td> <td>PZ</td> </tr> </tbody> </table>	Code	Description	Qty	UOM	VM2267A0	INTERNAL GLASS LOCKING SYSTEM SLIDER	1	PZ	VM2269A0	INTERNAL GLASS LOCKING SYSTEM CAP	1	PZ	VM2274A0	GROOVED BUSHING	1	PZ	VM2305A0	6 SERIES DOOR CAP FIXING PAWL	7	PZ																																									
			Code	Description	Qty	UOM																																																												
VM2267A0	INTERNAL GLASS LOCKING SYSTEM SLIDER	1	PZ																																																															
VM2269A0	INTERNAL GLASS LOCKING SYSTEM CAP	1	PZ																																																															
VM2274A0	GROOVED BUSHING	1	PZ																																																															
VM2305A0	6 SERIES DOOR CAP FIXING PAWL	7	PZ																																																															
K0B1122AL	CHEFTOP MM LEFT DOOR LOWER BEAM KIT	<table border="1"> <thead> <tr> <th>Code</th> <th>Description</th> <th>Qty</th> <th>UOM</th> </tr> </thead> <tbody> <tr> <td>0B1122A0</td> <td>750MM DOOR LOWER FRAME SHAPE</td> <td>1</td> <td>PZ</td> </tr> <tr> <td>0B1122A1</td> <td>750MM DOOR LOWER FRAME SHAPE</td> <td>1</td> <td>PZ</td> </tr> <tr> <td>RC1200A0</td> <td>ED=4 WIRE D.=0.5 COMPRESSION N SPRING</td> <td>2</td> <td>PZ</td> </tr> <tr> <td>VI1220A1</td> <td>4,2X12 TCB SELF-TAPPING G SCREW</td> <td>1</td> <td>PZ</td> </tr> <tr> <td>VI1996A0</td> <td>M5X35 SCREW</td> <td>7</td> <td>PZ</td> </tr> <tr> <td>VM1794A0</td> <td>250X4.8 PA66 BLACK CLAMP</td> <td>2</td> <td>PZ</td> </tr> <tr> <td>VM2103A0</td> <td>CLAMP LOCK</td> <td>2</td> <td>PZ</td> </tr> <tr> <td>VM2267A0</td> <td>INTERNAL GLASS LOCKING SYSTEM SLIDER</td> <td>1</td> <td>PZ</td> </tr> <tr> <td>VM2269A0</td> <td>INTERNAL GLASS LOCKING SYSTEM CAP</td> <td>1</td> <td>PZ</td> </tr> <tr> <td>VM2274A0</td> <td>GROOVED BUSHING</td> <td>1</td> <td>PZ</td> </tr> <tr> <td>VM2305A0</td> <td>6 SERIES DOOR CAP FIXING PAWL</td> <td>7</td> <td>PZ</td> </tr> <tr> <td>VM2384A0</td> <td>MM LEFT DOOR RIGHT LOWER CAP</td> <td>1</td> <td>PZ</td> </tr> <tr> <td>VM2384A0</td> <td>MM LEFT DOOR RIGHT LOWER CAP</td> <td>1</td> <td>PZ</td> </tr> <tr> <td>VM2386A1</td> <td>LEFT MM DOOR LOWER LEFT CAP</td> <td>1</td> <td>PZ</td> </tr> <tr> <td>VM2386A1</td> <td>LEFT MM DOOR LOWER LEFT CAP</td> <td>1</td> <td>PZ</td> </tr> </tbody> </table>	Code	Description	Qty	UOM	0B1122A0	750MM DOOR LOWER FRAME SHAPE	1	PZ	0B1122A1	750MM DOOR LOWER FRAME SHAPE	1	PZ	RC1200A0	ED=4 WIRE D.=0.5 COMPRESSION N SPRING	2	PZ	VI1220A1	4,2X12 TCB SELF-TAPPING G SCREW	1	PZ	VI1996A0	M5X35 SCREW	7	PZ	VM1794A0	250X4.8 PA66 BLACK CLAMP	2	PZ	VM2103A0	CLAMP LOCK	2	PZ	VM2267A0	INTERNAL GLASS LOCKING SYSTEM SLIDER	1	PZ	VM2269A0	INTERNAL GLASS LOCKING SYSTEM CAP	1	PZ	VM2274A0	GROOVED BUSHING	1	PZ	VM2305A0	6 SERIES DOOR CAP FIXING PAWL	7	PZ	VM2384A0	MM LEFT DOOR RIGHT LOWER CAP	1	PZ	VM2384A0	MM LEFT DOOR RIGHT LOWER CAP	1	PZ	VM2386A1	LEFT MM DOOR LOWER LEFT CAP	1	PZ	VM2386A1	LEFT MM DOOR LOWER LEFT CAP	1	PZ
Code	Description	Qty	UOM																																																															
0B1122A0	750MM DOOR LOWER FRAME SHAPE	1	PZ																																																															
0B1122A1	750MM DOOR LOWER FRAME SHAPE	1	PZ																																																															
RC1200A0	ED=4 WIRE D.=0.5 COMPRESSION N SPRING	2	PZ																																																															
VI1220A1	4,2X12 TCB SELF-TAPPING G SCREW	1	PZ																																																															
VI1996A0	M5X35 SCREW	7	PZ																																																															
VM1794A0	250X4.8 PA66 BLACK CLAMP	2	PZ																																																															
VM2103A0	CLAMP LOCK	2	PZ																																																															
VM2267A0	INTERNAL GLASS LOCKING SYSTEM SLIDER	1	PZ																																																															
VM2269A0	INTERNAL GLASS LOCKING SYSTEM CAP	1	PZ																																																															
VM2274A0	GROOVED BUSHING	1	PZ																																																															
VM2305A0	6 SERIES DOOR CAP FIXING PAWL	7	PZ																																																															
VM2384A0	MM LEFT DOOR RIGHT LOWER CAP	1	PZ																																																															
VM2384A0	MM LEFT DOOR RIGHT LOWER CAP	1	PZ																																																															
VM2386A1	LEFT MM DOOR LOWER LEFT CAP	1	PZ																																																															
VM2386A1	LEFT MM DOOR LOWER LEFT CAP	1	PZ																																																															

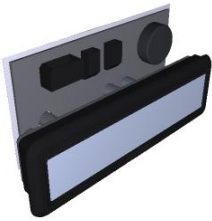
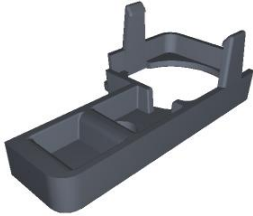



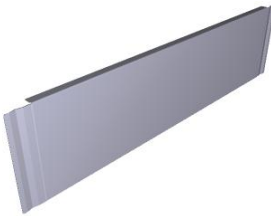

COMPONENT			SPARE PART																		
Code	Description	Image	Code	Description	Components list																
VM2263A	MM BIG DOOR LOWER LEFT CAP		KVM2263A	MM BIG DOOR LEFT LOWER CAP KIT	<table border="1"> <thead> <tr> <th>Code</th> <th>Description</th> <th>Qty</th> <th>UOM</th> </tr> </thead> <tbody> <tr> <td>VM1224A0</td> <td></td> <td>0.200</td> <td>M</td> </tr> <tr> <td>VM2263A0</td> <td>MM BIG DOOR LOWER LEFT CAP</td> <td>1</td> <td>PZ</td> </tr> </tbody> </table>	Code	Description	Qty	UOM	VM1224A0		0.200	M	VM2263A0	MM BIG DOOR LOWER LEFT CAP	1	PZ				
Code	Description	Qty	UOM																		
VM1224A0		0.200	M																		
VM2263A0	MM BIG DOOR LOWER LEFT CAP	1	PZ																		
VM2268A	DOOR MAGNET COVER		KVM2268A	DOOR MAGNET COVER KIT	<table border="1"> <thead> <tr> <th>Code</th> <th>Description</th> <th>Qty</th> <th>UOM</th> </tr> </thead> <tbody> <tr> <td>VM1224A0</td> <td></td> <td>0.200</td> <td>M</td> </tr> <tr> <td>VM2268A0</td> <td>DOOR MAGNET COVER</td> <td>1</td> <td>PZ</td> </tr> </tbody> </table>	Code	Description	Qty	UOM	VM1224A0		0.200	M	VM2268A0	DOOR MAGNET COVER	1	PZ				
Code	Description	Qty	UOM																		
VM1224A0		0.200	M																		
VM2268A0	DOOR MAGNET COVER	1	PZ																		
VM2265A	MM BIG DOOR LOWER RIGHT CAP		KVM2265A	MM TROLLEY OVEN DOOR RIGHT LOWER CAP KIT	<table border="1"> <thead> <tr> <th>Code</th> <th>Description</th> <th>Qty</th> <th>UOM</th> </tr> </thead> <tbody> <tr> <td>VM1224A0</td> <td></td> <td>0.250</td> <td>M</td> </tr> <tr> <td>VM2265A0</td> <td>MM BIG DOOR LOWER RIGHT CAP</td> <td>1</td> <td>PZ</td> </tr> </tbody> </table>	Code	Description	Qty	UOM	VM1224A0		0.250	M	VM2265A0	MM BIG DOOR LOWER RIGHT CAP	1	PZ				
Code	Description	Qty	UOM																		
VM1224A0		0.250	M																		
VM2265A0	MM BIG DOOR LOWER RIGHT CAP	1	PZ																		
LP1029A	L=1199 S6 NO LED LIGHT BAR COVER		KLP1029A	L119 MM NO LED LIGHT HOLDER KIT	<table border="1"> <thead> <tr> <th>Code</th> <th>Description</th> <th>Qty</th> <th>UOM</th> </tr> </thead> <tbody> <tr> <td>IP1385A1</td> <td>CORNER POLYSTYREN E PACKING 110X80X2000</td> <td>2.540</td> <td>M</td> </tr> <tr> <td>LP1029A0</td> <td>L=1199 S6 NO LED LIGHT BAR COVER</td> <td>1</td> <td>PZ</td> </tr> <tr> <td>VM1059A1</td> <td>HEAT SHRINK FILM H800</td> <td>2.540</td> <td>M</td> </tr> </tbody> </table>	Code	Description	Qty	UOM	IP1385A1	CORNER POLYSTYREN E PACKING 110X80X2000	2.540	M	LP1029A0	L=1199 S6 NO LED LIGHT BAR COVER	1	PZ	VM1059A1	HEAT SHRINK FILM H800	2.540	M
Code	Description	Qty	UOM																		
IP1385A1	CORNER POLYSTYREN E PACKING 110X80X2000	2.540	M																		
LP1029A0	L=1199 S6 NO LED LIGHT BAR COVER	1	PZ																		
VM1059A1	HEAT SHRINK FILM H800	2.540	M																		
LP1023A	6 SERIES L800 LED LIGHT BAR - E1199		KLP1023A	L800 E1199 LED LIGHT BAR KIT	<table border="1"> <thead> <tr> <th>Code</th> <th>Description</th> <th>Qty</th> <th>UOM</th> </tr> </thead> <tbody> <tr> <td>IP1385A1</td> <td>CORNER POLYSTYREN E PACKING 110X80X2000</td> <td>2.540</td> <td>M</td> </tr> <tr> <td>LP1023A0</td> <td>6 SERIES L800 LED LIGHT BAR - E1199</td> <td>1</td> <td>PZ</td> </tr> <tr> <td>VM1059A1</td> <td>HEAT SHRINK FILM H800</td> <td>2.540</td> <td>M</td> </tr> </tbody> </table>	Code	Description	Qty	UOM	IP1385A1	CORNER POLYSTYREN E PACKING 110X80X2000	2.540	M	LP1023A0	6 SERIES L800 LED LIGHT BAR - E1199	1	PZ	VM1059A1	HEAT SHRINK FILM H800	2.540	M
Code	Description	Qty	UOM																		
IP1385A1	CORNER POLYSTYREN E PACKING 110X80X2000	2.540	M																		
LP1023A0	6 SERIES L800 LED LIGHT BAR - E1199	1	PZ																		
VM1059A1	HEAT SHRINK FILM H800	2.540	M																		

COMPONENT			SPARE PART																						
Code	Description	Image	Code	Description	Components list																				
CE1053B	MM MICROFIT LED BAR POWER SUPPLY CABLE		KCE1053B	LED BAR EXTENSION CABLE KIT	<table border="1"> <thead> <tr> <th>Code</th> <th>Description</th> <th>Qty</th> <th>UOM</th> </tr> </thead> <tbody> <tr> <td>CE1053B0</td> <td>MM MICROFIT LED BAR POWER SUPPLY CABL</td> <td>1</td> <td>PZ</td> </tr> </tbody> </table>	Code	Description	Qty	UOM	CE1053B0	MM MICROFIT LED BAR POWER SUPPLY CABL	1	PZ												
Code	Description	Qty	UOM																						
CE1053B0	MM MICROFIT LED BAR POWER SUPPLY CABL	1	PZ																						
CE1052A	CABLE CONNECTION CONTROL - USB MM 750MM		KCE1052A	CONTROL BOARD-USB 650 CONN. CABLE KIT	<table border="1"> <thead> <tr> <th>Code</th> <th>Description</th> <th>Qty</th> <th>UOM</th> </tr> </thead> <tbody> <tr> <td>CE1052A1</td> <td>CABLE CONNECTION CONTROL - USB MM 750M</td> <td>1</td> <td>PZ</td> </tr> <tr> <td>VM1224A0</td> <td></td> <td>0.350</td> <td>M</td> </tr> </tbody> </table>	Code	Description	Qty	UOM	CE1052A1	CABLE CONNECTION CONTROL - USB MM 750M	1	PZ	VM1224A0		0.350	M								
Code	Description	Qty	UOM																						
CE1052A1	CABLE CONNECTION CONTROL - USB MM 750M	1	PZ																						
VM1224A0		0.350	M																						
TB2911A	XEVC-2011-E DOOR BEAM		OUTOFPRODUCTIO																						
VM2410A	PLATE TO STOP EXTRUDED LED BAR		KVM2410A	PLATE TO STOP EXTRUDED LED BAR 2P KIT	<table border="1"> <thead> <tr> <th>Code</th> <th>Description</th> <th>Qty</th> <th>UOM</th> </tr> </thead> <tbody> <tr> <td>0B1190A0</td> <td>PLATE TO STOP EXTRUDED LED BAR</td> <td>2</td> <td>PZ</td> </tr> <tr> <td>VM1224A0</td> <td></td> <td>0.200</td> <td>M</td> </tr> <tr> <td>VM2410A0</td> <td>PLATE TO STOP EXTRUDED LED BAR</td> <td>2</td> <td>PZ</td> </tr> <tr> <td>VM2410A0</td> <td>PLATE TO STOP EXTRUDED LED BAR</td> <td>2</td> <td>PZ</td> </tr> </tbody> </table>	Code	Description	Qty	UOM	0B1190A0	PLATE TO STOP EXTRUDED LED BAR	2	PZ	VM1224A0		0.200	M	VM2410A0	PLATE TO STOP EXTRUDED LED BAR	2	PZ	VM2410A0	PLATE TO STOP EXTRUDED LED BAR	2	PZ
Code	Description	Qty	UOM																						
0B1190A0	PLATE TO STOP EXTRUDED LED BAR	2	PZ																						
VM1224A0		0.200	M																						
VM2410A0	PLATE TO STOP EXTRUDED LED BAR	2	PZ																						
VM2410A0	PLATE TO STOP EXTRUDED LED BAR	2	PZ																						
TB3204A	XEVC-2011-E UPPER DOOR BEAM		TB3204A0	XEVC-2011-E UPPER DOOR BEAM																					

COMPONENT			SPARE PART																						
Code	Description	Image	Code	Description	Components list																				
PE2046A	MM POWER SWITCH AND USB BOARD		KPE2046A	MIND.MAPS USB-RESET SUPPORT KIT	<table border="1"> <thead> <tr> <th>Code</th> <th>Description</th> <th>Qty</th> <th>UOM</th> </tr> </thead> <tbody> <tr> <td>PE2046A2</td> <td>MM POWER SWITCH AND USB BOARD</td> <td>1</td> <td>PZ</td> </tr> <tr> <td>V11220A1</td> <td>4,2X12 TCB SELF-TAPPING SCREW</td> <td>2</td> <td>PZ</td> </tr> <tr> <td>VM2147A0</td> <td>410X343X15 MM PINK SMOOTH ESD SPONGE</td> <td>0.250</td> <td>PZ</td> </tr> </tbody> </table>	Code	Description	Qty	UOM	PE2046A2	MM POWER SWITCH AND USB BOARD	1	PZ	V11220A1	4,2X12 TCB SELF-TAPPING SCREW	2	PZ	VM2147A0	410X343X15 MM PINK SMOOTH ESD SPONGE	0.250	PZ				
Code	Description	Qty	UOM																						
PE2046A2	MM POWER SWITCH AND USB BOARD	1	PZ																						
V11220A1	4,2X12 TCB SELF-TAPPING SCREW	2	PZ																						
VM2147A0	410X343X15 MM PINK SMOOTH ESD SPONGE	0.250	PZ																						
VM2518A	BOARD COOLING FAN SUPPORT		KVM2518A	PANEL COOLING FAN SUPPORT KIT	<table border="1"> <thead> <tr> <th>Code</th> <th>Description</th> <th>Qty</th> <th>UOM</th> </tr> </thead> <tbody> <tr> <td>VM1224A0</td> <td></td> <td>0.150</td> <td>M</td> </tr> <tr> <td>VM2518A0</td> <td>BOARD COOLING FAN SUPPORT</td> <td>1</td> <td>PZ</td> </tr> <tr> <td>VM2518A0</td> <td>BOARD COOLING FAN SUPPORT</td> <td>1</td> <td>PZ</td> </tr> </tbody> </table>	Code	Description	Qty	UOM	VM1224A0		0.150	M	VM2518A0	BOARD COOLING FAN SUPPORT	1	PZ	VM2518A0	BOARD COOLING FAN SUPPORT	1	PZ				
Code	Description	Qty	UOM																						
VM1224A0		0.150	M																						
VM2518A0	BOARD COOLING FAN SUPPORT	1	PZ																						
VM2518A0	BOARD COOLING FAN SUPPORT	1	PZ																						
VN1179A	CONTROL BOARD 40X40X20MM 12V COOLING FAN		KVN1179A	CONTROL BOARD COOLING FAN KIT	<table border="1"> <thead> <tr> <th>Code</th> <th>Description</th> <th>Qty</th> <th>UOM</th> </tr> </thead> <tbody> <tr> <td>VM1224A0</td> <td></td> <td>0.150</td> <td>M</td> </tr> <tr> <td>VN1179A0</td> <td>CONTROL BOARD 40X40X20MM 12V COOLING FAN</td> <td>1</td> <td>PZ</td> </tr> <tr> <td>VN1179A0</td> <td>CONTROL BOARD 40X40X20MM 12V COOLING FAN</td> <td>1</td> <td>PZ</td> </tr> <tr> <td>VN1179A1</td> <td>CONTROL BOARD 40X40X20MM 12V COOLING FAN</td> <td>1</td> <td>PZ</td> </tr> </tbody> </table>	Code	Description	Qty	UOM	VM1224A0		0.150	M	VN1179A0	CONTROL BOARD 40X40X20MM 12V COOLING FAN	1	PZ	VN1179A0	CONTROL BOARD 40X40X20MM 12V COOLING FAN	1	PZ	VN1179A1	CONTROL BOARD 40X40X20MM 12V COOLING FAN	1	PZ
Code	Description	Qty	UOM																						
VM1224A0		0.150	M																						
VN1179A0	CONTROL BOARD 40X40X20MM 12V COOLING FAN	1	PZ																						
VN1179A0	CONTROL BOARD 40X40X20MM 12V COOLING FAN	1	PZ																						
VN1179A1	CONTROL BOARD 40X40X20MM 12V COOLING FAN	1	PZ																						
0H7248B	TROLLEY PUSHING CAM L SHAPED BRACKET		0H7248B0	TROLLEY PUSHING CAM L SHAPED BRACKET																					

COMPONENT			SPARE PART																										
Code	Description	Image	Code	Description	Components list																								
PE2044A	MM PLUS VERSION CONTROL BOARD		KPE2044A	MIND.MAPS PLUS CONTROL BOARD KIT	<table border="1"> <thead> <tr> <th>Code</th> <th>Description</th> <th>Qty</th> <th>UOM</th> </tr> </thead> <tbody> <tr> <td>PE2044A3</td> <td>MM PLUS VERSION CONTROL BOARD</td> <td>1</td> <td>PZ</td> </tr> <tr> <td>PE2044A4</td> <td>MM PLUS VERSION CONTROL BOARD</td> <td>1</td> <td>PZ</td> </tr> <tr> <td>VI1074A0</td> <td></td> <td>2</td> <td>PZ</td> </tr> <tr> <td>VI2000A0</td> <td>SCREW M4X22 TCB+ INOX</td> <td>4</td> <td>PZ</td> </tr> <tr> <td>VM2147A0</td> <td>410X343X15 MM PINK SMOOTH ESD SPONGE</td> <td>1</td> <td>PZ</td> </tr> </tbody> </table>	Code	Description	Qty	UOM	PE2044A3	MM PLUS VERSION CONTROL BOARD	1	PZ	PE2044A4	MM PLUS VERSION CONTROL BOARD	1	PZ	VI1074A0		2	PZ	VI2000A0	SCREW M4X22 TCB+ INOX	4	PZ	VM2147A0	410X343X15 MM PINK SMOOTH ESD SPONGE	1	PZ
Code	Description	Qty	UOM																										
PE2044A3	MM PLUS VERSION CONTROL BOARD	1	PZ																										
PE2044A4	MM PLUS VERSION CONTROL BOARD	1	PZ																										
VI1074A0		2	PZ																										
VI2000A0	SCREW M4X22 TCB+ INOX	4	PZ																										
VM2147A0	410X343X15 MM PINK SMOOTH ESD SPONGE	1	PZ																										
VM1630A	XB/XV/XVC/XG TERMINAL COVERING BOX		KVM1630A	CAP FOR INTERNAL GLASS 10 PCS KIT	<table border="1"> <thead> <tr> <th>Code</th> <th>Description</th> <th>Qty</th> <th>UOM</th> </tr> </thead> <tbody> <tr> <td>VM1224A0</td> <td></td> <td>0.200</td> <td>M</td> </tr> <tr> <td>VM1630A0</td> <td>INTERNAL GLASS PUSHING CAP</td> <td>10</td> <td>PZ</td> </tr> <tr> <td>VM1630A1</td> <td>XB/XV/XVC/XG TERMINAL COVERING BO</td> <td>10</td> <td>PZ</td> </tr> </tbody> </table>	Code	Description	Qty	UOM	VM1224A0		0.200	M	VM1630A0	INTERNAL GLASS PUSHING CAP	10	PZ	VM1630A1	XB/XV/XVC/XG TERMINAL COVERING BO	10	PZ								
Code	Description	Qty	UOM																										
VM1224A0		0.200	M																										
VM1630A0	INTERNAL GLASS PUSHING CAP	10	PZ																										
VM1630A1	XB/XV/XVC/XG TERMINAL COVERING BO	10	PZ																										
VM2315A			KVM2315A	3 PCS MM INTERNAL GLASS SUPPORT KIT	<table border="1"> <thead> <tr> <th>Code</th> <th>Description</th> <th>Qty</th> <th>UOM</th> </tr> </thead> <tbody> <tr> <td>VI1220A1</td> <td>4,2X12 TCB SELF-TAPPIN G SCREW</td> <td>3</td> <td>PZ</td> </tr> <tr> <td>VM1224A0</td> <td></td> <td>0.200</td> <td>M</td> </tr> <tr> <td>VM1630A0</td> <td>INTERNAL GLASS PUSHING CAP</td> <td>3</td> <td>PZ</td> </tr> <tr> <td>VM1630A1</td> <td>XB/XV/XVC/XG TERMINAL COVERING BO</td> <td>3</td> <td>PZ</td> </tr> <tr> <td>VM2315A0</td> <td>MIND.MAPS INTERNAL GLASS CAP SUPPORT</td> <td>3</td> <td>PZ</td> </tr> </tbody> </table>	Code	Description	Qty	UOM	VI1220A1	4,2X12 TCB SELF-TAPPIN G SCREW	3	PZ	VM1224A0		0.200	M	VM1630A0	INTERNAL GLASS PUSHING CAP	3	PZ	VM1630A1	XB/XV/XVC/XG TERMINAL COVERING BO	3	PZ	VM2315A0	MIND.MAPS INTERNAL GLASS CAP SUPPORT	3	PZ
Code	Description	Qty	UOM																										
VI1220A1	4,2X12 TCB SELF-TAPPIN G SCREW	3	PZ																										
VM1224A0		0.200	M																										
VM1630A0	INTERNAL GLASS PUSHING CAP	3	PZ																										
VM1630A1	XB/XV/XVC/XG TERMINAL COVERING BO	3	PZ																										
VM2315A0	MIND.MAPS INTERNAL GLASS CAP SUPPORT	3	PZ																										
0H7243A	XEVC-2011 LOWER DOOR PROFILE		0H7243A0	XEVC-2011 LOWER DOOR PROFILE																									



COMPONENT			SPARE PART																						
Code	Description	Image	Code	Description	Components list																				
0H7240A	XEVC-2011 RIGHT INT DOOR COLUMN		OUTOFPRODUCTIO																						
0H7241A	XEVC-2011 LEFT INT DOOR COLUMN		OUTOFPRODUCTIO																						
0H7778A	XEVC-2011 RIGHT EXT DOOR COLUMN		0H7778A0	XEVC-2011 RIGHT EXT DOOR COLUMN																					
0H7242A	XEVC-2011 DOOR GLASS SUPPORT PLATE		0H7242A0	XEVC-2011 DOOR GLASS SUPPORT PLATE																					
MG1083A	MIND.MAPS DOOR COMPLETE HANDLE		KMG1083A	MIND.MAPS SERIES HANDLE KIT	<table border="1"> <thead> <tr> <th>Code</th> <th>Description</th> <th>Qty</th> <th>UOM</th> </tr> </thead> <tbody> <tr> <td>0H7321A0</td> <td>MM STAINLESS STEEL HANDLE COVE</td> <td>1</td> <td>PZ</td> </tr> <tr> <td>RC1200A0</td> <td>ED=4 WIRE D.=0.5 COMPRESSIO N SPRING</td> <td>4</td> <td>PZ</td> </tr> <tr> <td>VI0239A1</td> <td>SELF-TAPPIN G SCREW 4.2X25 TCB+ INOX</td> <td>8</td> <td>PZ</td> </tr> <tr> <td>VI1220A1</td> <td>4.2X12 TCB SELF-TAPPIN G SCREW</td> <td>2</td> <td>PZ</td> </tr> </tbody> </table>	Code	Description	Qty	UOM	0H7321A0	MM STAINLESS STEEL HANDLE COVE	1	PZ	RC1200A0	ED=4 WIRE D.=0.5 COMPRESSIO N SPRING	4	PZ	VI0239A1	SELF-TAPPIN G SCREW 4.2X25 TCB+ INOX	8	PZ	VI1220A1	4.2X12 TCB SELF-TAPPIN G SCREW	2	PZ
Code	Description	Qty	UOM																						
0H7321A0	MM STAINLESS STEEL HANDLE COVE	1	PZ																						
RC1200A0	ED=4 WIRE D.=0.5 COMPRESSIO N SPRING	4	PZ																						
VI0239A1	SELF-TAPPIN G SCREW 4.2X25 TCB+ INOX	8	PZ																						
VI1220A1	4.2X12 TCB SELF-TAPPIN G SCREW	2	PZ																						



COMPONENT			SPARE PART																																																		
Code	Description	Image	Code	Description	Components list																																																
MG1083A	MIND.MAPS DOOR COMPLETE HANDLE		KMG1083A	MIND.MAPS SERIES HANDLE KIT	<table border="1"> <thead> <tr> <th>Code</th> <th>Description</th> <th>Qty</th> <th>UOM</th> </tr> </thead> <tbody> <tr> <td>VM1182B1</td> <td>E S. CT BT HANDLE JUNCTION + PIN GUIDE</td> <td>1</td> <td>PZ</td> </tr> <tr> <td>VM1183B0</td> <td>CHEFTOP/BAK ERTOP HANDLE PIN</td> <td>1</td> <td>PZ</td> </tr> <tr> <td>VM1183B1</td> <td>CT BT HANDLE PIN</td> <td>1</td> <td>PZ</td> </tr> <tr> <td>VM1183C0</td> <td>CT BT HANDLE T-SHAPED PIN KIT</td> <td>1</td> <td>PZ</td> </tr> <tr> <td>VM1490A0</td> <td>CHEFTOP/BAK ERTOP HANDLE SCREWS COVER</td> <td>2</td> <td>PZ</td> </tr> <tr> <td>VM1695A0</td> <td>HANDLE POSITION PIN</td> <td>4</td> <td>PZ</td> </tr> <tr> <td>VM2245A0</td> <td>HANDLE SHAFT WITH LATCH</td> <td>1</td> <td>PZ</td> </tr> <tr> <td>VM2247A0</td> <td>HANDLE SHAFT COVER VM2245-2246</td> <td>1</td> <td>PZ</td> </tr> <tr> <td>VM2247B0</td> <td>HANDLE SHAFT COVER VM2245-2246</td> <td>1</td> <td>PZ</td> </tr> <tr> <td>VM2248B0</td> <td>HANDLE WITH LATCH CLOSING KEY</td> <td>1</td> <td>PZ</td> </tr> <tr> <td>VM2295A0</td> <td>STYLUS PEN FOR MM</td> <td>1</td> <td>PZ</td> </tr> </tbody> </table>	Code	Description	Qty	UOM	VM1182B1	E S. CT BT HANDLE JUNCTION + PIN GUIDE	1	PZ	VM1183B0	CHEFTOP/BAK ERTOP HANDLE PIN	1	PZ	VM1183B1	CT BT HANDLE PIN	1	PZ	VM1183C0	CT BT HANDLE T-SHAPED PIN KIT	1	PZ	VM1490A0	CHEFTOP/BAK ERTOP HANDLE SCREWS COVER	2	PZ	VM1695A0	HANDLE POSITION PIN	4	PZ	VM2245A0	HANDLE SHAFT WITH LATCH	1	PZ	VM2247A0	HANDLE SHAFT COVER VM2245-2246	1	PZ	VM2247B0	HANDLE SHAFT COVER VM2245-2246	1	PZ	VM2248B0	HANDLE WITH LATCH CLOSING KEY	1	PZ	VM2295A0	STYLUS PEN FOR MM	1	PZ
					Code	Description	Qty	UOM																																													
					VM1182B1	E S. CT BT HANDLE JUNCTION + PIN GUIDE	1	PZ																																													
					VM1183B0	CHEFTOP/BAK ERTOP HANDLE PIN	1	PZ																																													
					VM1183B1	CT BT HANDLE PIN	1	PZ																																													
					VM1183C0	CT BT HANDLE T-SHAPED PIN KIT	1	PZ																																													
					VM1490A0	CHEFTOP/BAK ERTOP HANDLE SCREWS COVER	2	PZ																																													
					VM1695A0	HANDLE POSITION PIN	4	PZ																																													
					VM2245A0	HANDLE SHAFT WITH LATCH	1	PZ																																													
					VM2247A0	HANDLE SHAFT COVER VM2245-2246	1	PZ																																													
					VM2247B0	HANDLE SHAFT COVER VM2245-2246	1	PZ																																													
					VM2248B0	HANDLE WITH LATCH CLOSING KEY	1	PZ																																													
					VM2295A0	STYLUS PEN FOR MM	1	PZ																																													

ASM1806C/0.D00 - Cooking chamber

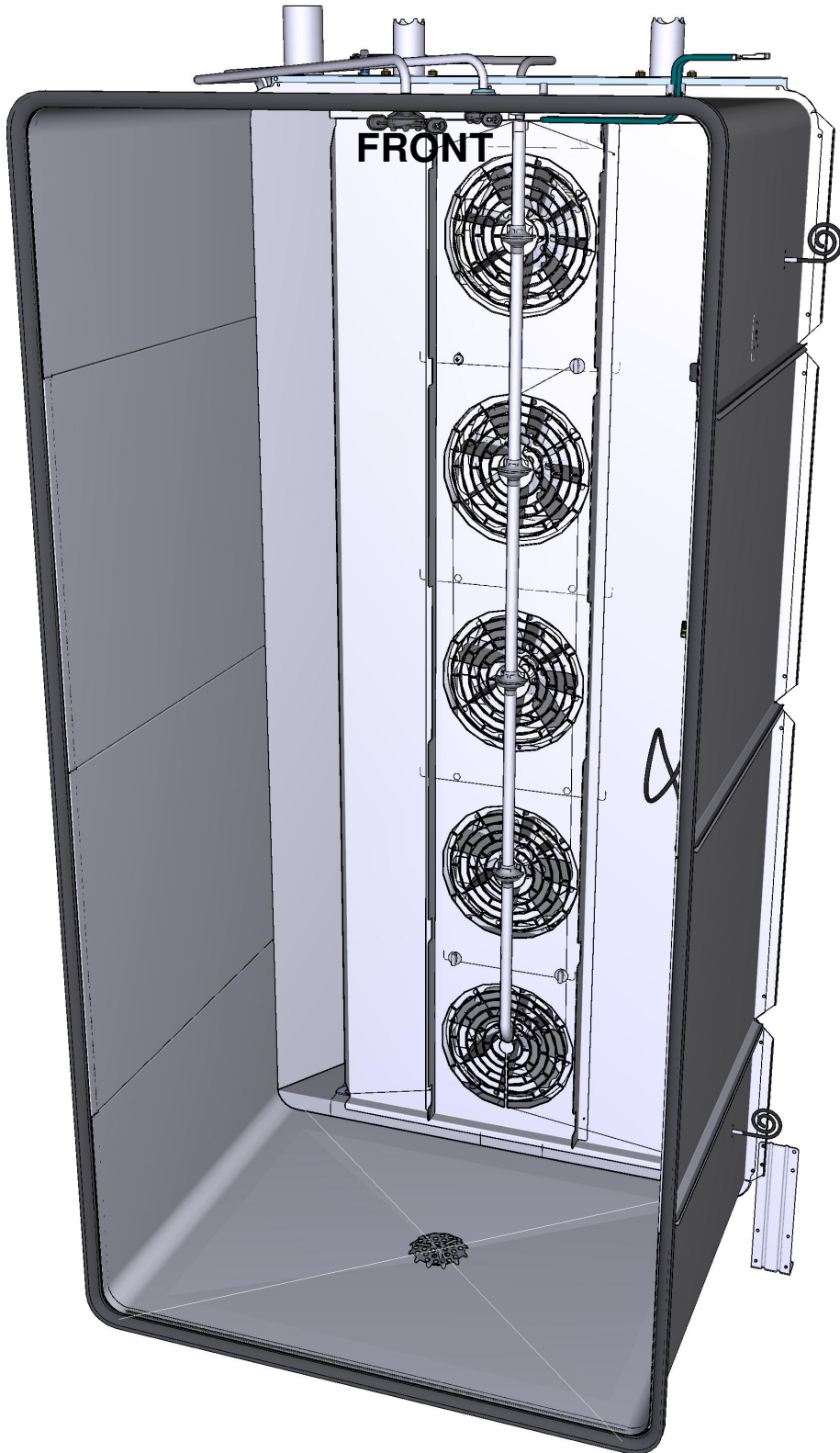

ASM1806C/0.D00 - Cooking chamber

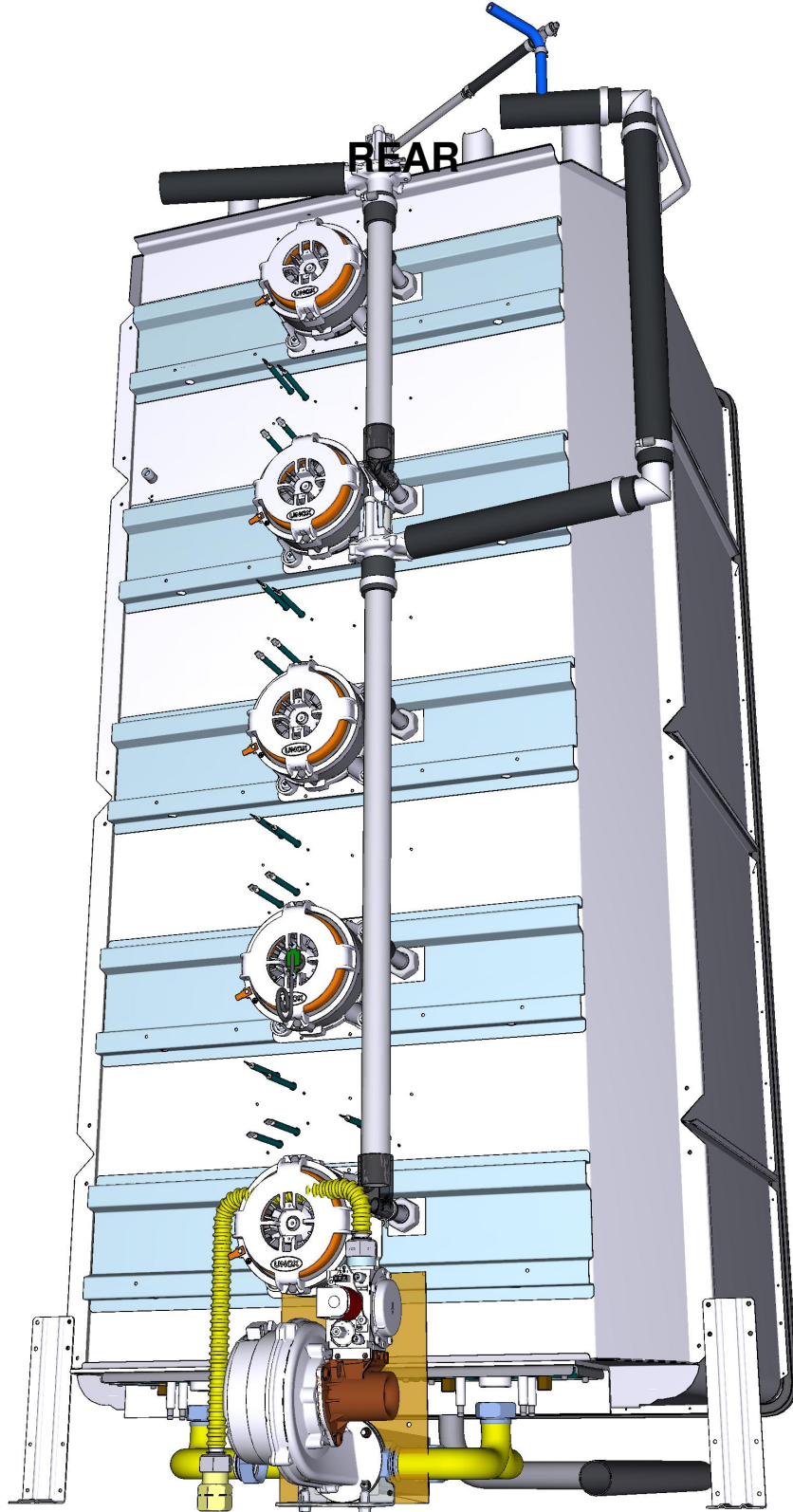

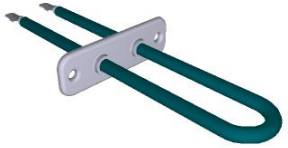
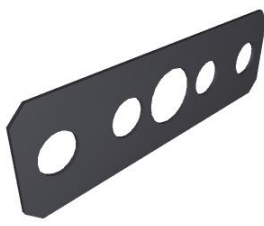
COMPONENT			SPARE PART																						
Code	Description	Image	Code	Description	Components list																				
RS1215A	147W 105V BRAKING ELEMENT		KRS1215A	147W MOTOR BRAKING ELEMENT KIT	<table border="1"> <thead> <tr> <th>Code</th> <th>Description</th> <th>Qty</th> <th>UOM</th> </tr> </thead> <tbody> <tr> <td>GN1326A1</td> <td>ELEMENT SEALING</td> <td>1</td> <td>PZ</td> </tr> <tr> <td>RS1215A1</td> <td>147W 105V BRAKING ELEMENT</td> <td>1</td> <td>PZ</td> </tr> <tr> <td>SL1045A0</td> <td>S57 BLACK SILICONE - 80ML CARTRIDGE</td> <td>1</td> <td>PZ</td> </tr> <tr> <td>VI1220A1</td> <td>4,2X12 TCB SELF-TAPPIN G SCREW</td> <td>2</td> <td>PZ</td> </tr> </tbody> </table>	Code	Description	Qty	UOM	GN1326A1	ELEMENT SEALING	1	PZ	RS1215A1	147W 105V BRAKING ELEMENT	1	PZ	SL1045A0	S57 BLACK SILICONE - 80ML CARTRIDGE	1	PZ	VI1220A1	4,2X12 TCB SELF-TAPPIN G SCREW	2	PZ
			Code	Description	Qty	UOM																			
GN1326A1	ELEMENT SEALING	1	PZ																						
RS1215A1	147W 105V BRAKING ELEMENT	1	PZ																						
SL1045A0	S57 BLACK SILICONE - 80ML CARTRIDGE	1	PZ																						
VI1220A1	4,2X12 TCB SELF-TAPPIN G SCREW	2	PZ																						
KRS0026A	BIG-L 147W MOTOR BRAKING ELEMENT KIT	<table border="1"> <thead> <tr> <th>Code</th> <th>Description</th> <th>Qty</th> <th>UOM</th> </tr> </thead> <tbody> <tr> <td>GN1672A0</td> <td></td> <td>1</td> <td>PZ</td> </tr> <tr> <td>RS1215A1</td> <td>147W 105V BRAKING ELEMENT</td> <td>1</td> <td>PZ</td> </tr> <tr> <td>SL1045A0</td> <td>S57 BLACK SILICONE - 80ML CARTRIDGE</td> <td>1</td> <td>PZ</td> </tr> <tr> <td>VI1220A1</td> <td>4,2X12 TCB SELF-TAPPIN G SCREW</td> <td>2</td> <td>PZ</td> </tr> </tbody> </table>	Code	Description	Qty	UOM	GN1672A0		1	PZ	RS1215A1	147W 105V BRAKING ELEMENT	1	PZ	SL1045A0	S57 BLACK SILICONE - 80ML CARTRIDGE	1	PZ	VI1220A1	4,2X12 TCB SELF-TAPPIN G SCREW	2	PZ			
Code	Description	Qty	UOM																						
GN1672A0		1	PZ																						
RS1215A1	147W 105V BRAKING ELEMENT	1	PZ																						
SL1045A0	S57 BLACK SILICONE - 80ML CARTRIDGE	1	PZ																						
VI1220A1	4,2X12 TCB SELF-TAPPIN G SCREW	2	PZ																						
GN1326A	ELEMENT SEALING		KRS1274A	100W MOTOR BRAKING ELEMENT KIT	<table border="1"> <thead> <tr> <th>Code</th> <th>Description</th> <th>Qty</th> <th>UOM</th> </tr> </thead> <tbody> <tr> <td>GN1326A1</td> <td>ELEMENT SEALING</td> <td>1</td> <td>PZ</td> </tr> <tr> <td>RS1274A0</td> <td>100W 60V 1 TURN FLAT ELEMENT</td> <td>1</td> <td>PZ</td> </tr> <tr> <td>SL1045A0</td> <td>S57 BLACK SILICONE - 80ML CARTRIDGE</td> <td>1</td> <td>PZ</td> </tr> <tr> <td>VI1220A1</td> <td>4,2X12 TCB SELF-TAPPIN G SCREW</td> <td>2</td> <td>PZ</td> </tr> </tbody> </table>	Code	Description	Qty	UOM	GN1326A1	ELEMENT SEALING	1	PZ	RS1274A0	100W 60V 1 TURN FLAT ELEMENT	1	PZ	SL1045A0	S57 BLACK SILICONE - 80ML CARTRIDGE	1	PZ	VI1220A1	4,2X12 TCB SELF-TAPPIN G SCREW	2	PZ
			Code	Description	Qty	UOM																			
GN1326A1	ELEMENT SEALING	1	PZ																						
RS1274A0	100W 60V 1 TURN FLAT ELEMENT	1	PZ																						
SL1045A0	S57 BLACK SILICONE - 80ML CARTRIDGE	1	PZ																						
VI1220A1	4,2X12 TCB SELF-TAPPIN G SCREW	2	PZ																						
KRS1261A	122W MOTOR BREAKING ELEMENT KIT	<table border="1"> <thead> <tr> <th>Code</th> <th>Description</th> <th>Qty</th> <th>UOM</th> </tr> </thead> <tbody> <tr> <td>GN1326A1</td> <td>ELEMENT SEALING</td> <td>1</td> <td>PZ</td> </tr> <tr> <td>RS1261A0</td> <td>BAKERLUX\CH EFLUX MOTOR BREAKING ELEMENT</td> <td>1</td> <td>PZ</td> </tr> <tr> <td>SL1045A0</td> <td>S57 BLACK SILICONE - 80ML CARTRIDGE</td> <td>1</td> <td>PZ</td> </tr> </tbody> </table>	Code	Description	Qty	UOM	GN1326A1	ELEMENT SEALING	1	PZ	RS1261A0	BAKERLUX\CH EFLUX MOTOR BREAKING ELEMENT	1	PZ	SL1045A0	S57 BLACK SILICONE - 80ML CARTRIDGE	1	PZ							
Code	Description	Qty	UOM																						
GN1326A1	ELEMENT SEALING	1	PZ																						
RS1261A0	BAKERLUX\CH EFLUX MOTOR BREAKING ELEMENT	1	PZ																						
SL1045A0	S57 BLACK SILICONE - 80ML CARTRIDGE	1	PZ																						

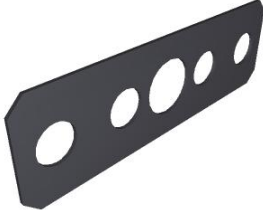

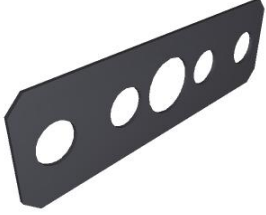
COMPONENT			SPARE PART																														
Code	Description	Image	Code	Description	Components list																												
GN1326A	ELEMENT SEALING		KRS1261A	122W MOTOR BRAKING ELEMENT KIT	<table border="1"> <thead> <tr> <th>Code</th> <th>Description</th> <th>Qty</th> <th>UOM</th> </tr> </thead> <tbody> <tr> <td>VI1220A1</td> <td>4,2X12 TCB SELF-TAPPIN G SCREW</td> <td>2</td> <td>PZ</td> </tr> <tr> <td>VM2147A0</td> <td>410X343X15 MM PINK SMOOTH ESD SPONGE</td> <td>1</td> <td>PZ</td> </tr> </tbody> </table>	Code	Description	Qty	UOM	VI1220A1	4,2X12 TCB SELF-TAPPIN G SCREW	2	PZ	VM2147A0	410X343X15 MM PINK SMOOTH ESD SPONGE	1	PZ																
			Code	Description	Qty	UOM																											
			VI1220A1	4,2X12 TCB SELF-TAPPIN G SCREW	2	PZ																											
			VM2147A0	410X343X15 MM PINK SMOOTH ESD SPONGE	1	PZ																											
			KRS1215A	147W MOTOR BRAKING ELEMENT KIT	<table border="1"> <thead> <tr> <th>Code</th> <th>Description</th> <th>Qty</th> <th>UOM</th> </tr> </thead> <tbody> <tr> <td>GN1326A1</td> <td>ELEMENT SEALING</td> <td>1</td> <td>PZ</td> </tr> <tr> <td>RS1215A1</td> <td>147W 105V BRAKING ELEMENT</td> <td>1</td> <td>PZ</td> </tr> <tr> <td>SL1045A0</td> <td>S57 BLACK SILICONE - 80ML CARTRIDGE</td> <td>1</td> <td>PZ</td> </tr> <tr> <td>VI1220A1</td> <td>4,2X12 TCB SELF-TAPPIN G SCREW</td> <td>2</td> <td>PZ</td> </tr> </tbody> </table>	Code	Description	Qty	UOM	GN1326A1	ELEMENT SEALING	1	PZ	RS1215A1	147W 105V BRAKING ELEMENT	1	PZ	SL1045A0	S57 BLACK SILICONE - 80ML CARTRIDGE	1	PZ	VI1220A1	4,2X12 TCB SELF-TAPPIN G SCREW	2	PZ								
			Code	Description	Qty	UOM																											
			GN1326A1	ELEMENT SEALING	1	PZ																											
			RS1215A1	147W 105V BRAKING ELEMENT	1	PZ																											
			SL1045A0	S57 BLACK SILICONE - 80ML CARTRIDGE	1	PZ																											
			VI1220A1	4,2X12 TCB SELF-TAPPIN G SCREW	2	PZ																											
			KRS1095A	1.2KW HEATING ELEMENT KIT	<table border="1"> <thead> <tr> <th>Code</th> <th>Description</th> <th>Qty</th> <th>UOM</th> </tr> </thead> <tbody> <tr> <td>GN1326A1</td> <td>ELEMENT SEALING</td> <td>1</td> <td>PZ</td> </tr> <tr> <td>IP1385A1</td> <td>CORNER POLYSTYREN E PACKING 110X80X2000</td> <td>0.500</td> <td>M</td> </tr> <tr> <td>RS1095A1</td> <td>HEATING ELEMENT 1200W 230V</td> <td>1</td> <td>PZ</td> </tr> <tr> <td>SL1045A0</td> <td>S57 BLACK SILICONE - 80ML CARTRIDGE</td> <td>1</td> <td>PZ</td> </tr> <tr> <td>VI1220A1</td> <td>4,2X12 TCB SELF-TAPPIN G SCREW</td> <td>2</td> <td>PZ</td> </tr> <tr> <td>VM1059A1</td> <td>HEAT SHRINK FILM H800</td> <td>1.200</td> <td>M</td> </tr> </tbody> </table>	Code	Description	Qty	UOM	GN1326A1	ELEMENT SEALING	1	PZ	IP1385A1	CORNER POLYSTYREN E PACKING 110X80X2000	0.500	M	RS1095A1	HEATING ELEMENT 1200W 230V	1	PZ	SL1045A0	S57 BLACK SILICONE - 80ML CARTRIDGE	1	PZ	VI1220A1	4,2X12 TCB SELF-TAPPIN G SCREW	2	PZ	VM1059A1	HEAT SHRINK FILM H800	1.200	M
			Code	Description	Qty	UOM																											
GN1326A1	ELEMENT SEALING	1	PZ																														
IP1385A1	CORNER POLYSTYREN E PACKING 110X80X2000	0.500	M																														
RS1095A1	HEATING ELEMENT 1200W 230V	1	PZ																														
SL1045A0	S57 BLACK SILICONE - 80ML CARTRIDGE	1	PZ																														
VI1220A1	4,2X12 TCB SELF-TAPPIN G SCREW	2	PZ																														
VM1059A1	HEAT SHRINK FILM H800	1.200	M																														
KRS1012A	1365W 120V HEATING ELEMENT KIT	<table border="1"> <thead> <tr> <th>Code</th> <th>Description</th> <th>Qty</th> <th>UOM</th> </tr> </thead> <tbody> <tr> <td>GN1326A1</td> <td>ELEMENT SEALING</td> <td>1</td> <td>PZ</td> </tr> <tr> <td>RS1012A0</td> <td>CIRCULAR ELEMENT 1365W 120V</td> <td>1</td> <td>PZ</td> </tr> <tr> <td>VI1220A1</td> <td>4,2X12 TCB SELF-TAPPIN G SCREW</td> <td>5</td> <td>PZ</td> </tr> <tr> <td>VM1794A0</td> <td>250X4.8 PA66 BLACK CLAMP</td> <td>2</td> <td>PZ</td> </tr> <tr> <td>VM2103A0</td> <td>CLAMP LOCK</td> <td>2</td> <td>PZ</td> </tr> </tbody> </table>	Code	Description	Qty	UOM	GN1326A1	ELEMENT SEALING	1	PZ	RS1012A0	CIRCULAR ELEMENT 1365W 120V	1	PZ	VI1220A1	4,2X12 TCB SELF-TAPPIN G SCREW	5	PZ	VM1794A0	250X4.8 PA66 BLACK CLAMP	2	PZ	VM2103A0	CLAMP LOCK	2	PZ							
Code	Description	Qty	UOM																														
GN1326A1	ELEMENT SEALING	1	PZ																														
RS1012A0	CIRCULAR ELEMENT 1365W 120V	1	PZ																														
VI1220A1	4,2X12 TCB SELF-TAPPIN G SCREW	5	PZ																														
VM1794A0	250X4.8 PA66 BLACK CLAMP	2	PZ																														
VM2103A0	CLAMP LOCK	2	PZ																														

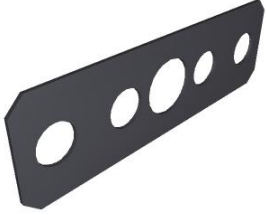
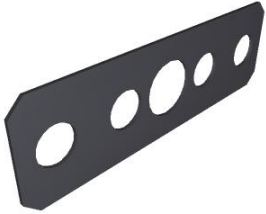

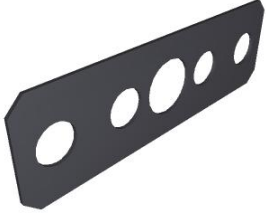

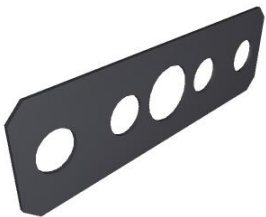
COMPONENT			SPARE PART																														
Code	Description	Image	Code	Description	Components list																												
GN1326A	ELEMENT SEALING		KRS1011A	ROBERTA/LISA HEATING ELEMENT KIT	<table border="1"> <thead> <tr> <th>Code</th> <th>Description</th> <th>Qty</th> <th>UOM</th> </tr> </thead> <tbody> <tr> <td>GN1326A1</td> <td>ELEMENT SEALING</td> <td>1</td> <td>PZ</td> </tr> <tr> <td>RS1011A0</td> <td>2560W 220-230V HEATING ELEMENT</td> <td>1</td> <td>PZ</td> </tr> <tr> <td>SL1045A0</td> <td>S57 BLACK SILICONE - 80ML CARTRIDGE</td> <td>1</td> <td>PZ</td> </tr> <tr> <td>VI1220A1</td> <td>4,2X12 TCB SELF-TAPPIN G SCREW</td> <td>5</td> <td>PZ</td> </tr> <tr> <td>VM1794A0</td> <td>250X4.8 PA66 BLACK CLAMP</td> <td>2</td> <td>PZ</td> </tr> <tr> <td>VM2103A0</td> <td>CLAMP LOCK</td> <td>2</td> <td>PZ</td> </tr> </tbody> </table>	Code	Description	Qty	UOM	GN1326A1	ELEMENT SEALING	1	PZ	RS1011A0	2560W 220-230V HEATING ELEMENT	1	PZ	SL1045A0	S57 BLACK SILICONE - 80ML CARTRIDGE	1	PZ	VI1220A1	4,2X12 TCB SELF-TAPPIN G SCREW	5	PZ	VM1794A0	250X4.8 PA66 BLACK CLAMP	2	PZ	VM2103A0	CLAMP LOCK	2	PZ
			Code	Description	Qty	UOM																											
			GN1326A1	ELEMENT SEALING	1	PZ																											
RS1011A0	2560W 220-230V HEATING ELEMENT	1	PZ																														
SL1045A0	S57 BLACK SILICONE - 80ML CARTRIDGE	1	PZ																														
VI1220A1	4,2X12 TCB SELF-TAPPIN G SCREW	5	PZ																														
VM1794A0	250X4.8 PA66 BLACK CLAMP	2	PZ																														
VM2103A0	CLAMP LOCK	2	PZ																														
KRS0090A	HEATING ELEMENT 1.26KW	<table border="1"> <thead> <tr> <th>Code</th> <th>Description</th> <th>Qty</th> <th>UOM</th> </tr> </thead> <tbody> <tr> <td>GN1326A1</td> <td>ELEMENT SEALING</td> <td>1</td> <td>PZ</td> </tr> <tr> <td>RS0090A0</td> <td>CIRC. HEAT. ELEMENT 1260W 220-230</td> <td>1</td> <td>PZ</td> </tr> <tr> <td>VI1220A1</td> <td>4,2X12 TCB SELF-TAPPIN G SCREW</td> <td>3</td> <td>PZ</td> </tr> <tr> <td>VM1794A0</td> <td>250X4.8 PA66 BLACK CLAMP</td> <td>2</td> <td>PZ</td> </tr> <tr> <td>VM2103A0</td> <td>CLAMP LOCK</td> <td>2</td> <td>PZ</td> </tr> </tbody> </table>	Code	Description	Qty	UOM	GN1326A1	ELEMENT SEALING	1	PZ	RS0090A0	CIRC. HEAT. ELEMENT 1260W 220-230	1	PZ	VI1220A1	4,2X12 TCB SELF-TAPPIN G SCREW	3	PZ	VM1794A0	250X4.8 PA66 BLACK CLAMP	2	PZ	VM2103A0	CLAMP LOCK	2	PZ							
Code	Description	Qty	UOM																														
GN1326A1	ELEMENT SEALING	1	PZ																														
RS0090A0	CIRC. HEAT. ELEMENT 1260W 220-230	1	PZ																														
VI1220A1	4,2X12 TCB SELF-TAPPIN G SCREW	3	PZ																														
VM1794A0	250X4.8 PA66 BLACK CLAMP	2	PZ																														
VM2103A0	CLAMP LOCK	2	PZ																														
KRS0050A	HEATING ELEMENT KIT 0.5KW	<table border="1"> <thead> <tr> <th>Code</th> <th>Description</th> <th>Qty</th> <th>UOM</th> </tr> </thead> <tbody> <tr> <td>GN1326A1</td> <td>ELEMENT SEALING</td> <td>1</td> <td>PZ</td> </tr> <tr> <td>IP1075A1</td> <td></td> <td>1</td> <td>PZ</td> </tr> <tr> <td>IP1080A1</td> <td></td> <td>1</td> <td>PZ</td> </tr> <tr> <td>RS0050A0</td> <td>HEAT. ELEMENT 500W 220-230V LIEV</td> <td>1</td> <td>PZ</td> </tr> <tr> <td>VI1220A1</td> <td>4,2X12 TCB SELF-TAPPIN G SCREW</td> <td>2</td> <td>PZ</td> </tr> </tbody> </table>	Code	Description	Qty	UOM	GN1326A1	ELEMENT SEALING	1	PZ	IP1075A1		1	PZ	IP1080A1		1	PZ	RS0050A0	HEAT. ELEMENT 500W 220-230V LIEV	1	PZ	VI1220A1	4,2X12 TCB SELF-TAPPIN G SCREW	2	PZ							
Code	Description	Qty	UOM																														
GN1326A1	ELEMENT SEALING	1	PZ																														
IP1075A1		1	PZ																														
IP1080A1		1	PZ																														
RS0050A0	HEAT. ELEMENT 500W 220-230V LIEV	1	PZ																														
VI1220A1	4,2X12 TCB SELF-TAPPIN G SCREW	2	PZ																														
KRS0011A	HEATING ELEMENT 1.465KW RS0011A	<table border="1"> <thead> <tr> <th>Code</th> <th>Description</th> <th>Qty</th> <th>UOM</th> </tr> </thead> <tbody> <tr> <td>GN1326A1</td> <td>ELEMENT SEALING</td> <td>1</td> <td>PZ</td> </tr> <tr> <td>RS0011A0</td> <td>CIRC.HEAT. ELEMENT 1465W 220-230</td> <td>1</td> <td>PZ</td> </tr> <tr> <td>VI1220A1</td> <td>4,2X12 TCB SELF-TAPPIN G SCREW</td> <td>3</td> <td>PZ</td> </tr> <tr> <td>VM1794A0</td> <td>250X4.8 PA66 BLACK CLAMP</td> <td>2</td> <td>PZ</td> </tr> <tr> <td>VM2103A0</td> <td>CLAMP LOCK</td> <td>2</td> <td>PZ</td> </tr> </tbody> </table>	Code	Description	Qty	UOM	GN1326A1	ELEMENT SEALING	1	PZ	RS0011A0	CIRC.HEAT. ELEMENT 1465W 220-230	1	PZ	VI1220A1	4,2X12 TCB SELF-TAPPIN G SCREW	3	PZ	VM1794A0	250X4.8 PA66 BLACK CLAMP	2	PZ	VM2103A0	CLAMP LOCK	2	PZ							
Code	Description	Qty	UOM																														
GN1326A1	ELEMENT SEALING	1	PZ																														
RS0011A0	CIRC.HEAT. ELEMENT 1465W 220-230	1	PZ																														
VI1220A1	4,2X12 TCB SELF-TAPPIN G SCREW	3	PZ																														
VM1794A0	250X4.8 PA66 BLACK CLAMP	2	PZ																														
VM2103A0	CLAMP LOCK	2	PZ																														

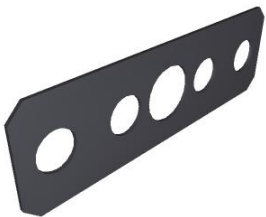
COMPONENT			SPARE PART																										
Code	Description	Image	Code	Description	Components list																								
GN1326A	ELEMENT SEALING		KRS0010A	KIT HEATING ELEMENT RS10010A	<table border="1"> <thead> <tr> <th>Code</th> <th>Description</th> <th>Qty</th> <th>UOM</th> </tr> </thead> <tbody> <tr> <td>GN1326A1</td> <td>ELEMENT SEALING</td> <td>1</td> <td>PZ</td> </tr> <tr> <td>IP1075A1</td> <td></td> <td>1</td> <td>PZ</td> </tr> <tr> <td>IP1080A1</td> <td></td> <td>5</td> <td>PZ</td> </tr> <tr> <td>RS0010A0</td> <td>CIRC.HEAT. ELEMENT 2560W - 220-230 V</td> <td>1</td> <td>PZ</td> </tr> <tr> <td>VI1220A1</td> <td>4,2X12 TCB SELF-TAPPIN G SCREW</td> <td>3</td> <td>PZ</td> </tr> </tbody> </table>	Code	Description	Qty	UOM	GN1326A1	ELEMENT SEALING	1	PZ	IP1075A1		1	PZ	IP1080A1		5	PZ	RS0010A0	CIRC.HEAT. ELEMENT 2560W - 220-230 V	1	PZ	VI1220A1	4,2X12 TCB SELF-TAPPIN G SCREW	3	PZ
			Code	Description	Qty	UOM																							
GN1326A1	ELEMENT SEALING	1	PZ																										
IP1075A1		1	PZ																										
IP1080A1		5	PZ																										
RS0010A0	CIRC.HEAT. ELEMENT 2560W - 220-230 V	1	PZ																										
VI1220A1	4,2X12 TCB SELF-TAPPIN G SCREW	3	PZ																										
KGN1326A	HEATING ELEMENT GASKET 5 PCS KIT	<table border="1"> <thead> <tr> <th>Code</th> <th>Description</th> <th>Qty</th> <th>UOM</th> </tr> </thead> <tbody> <tr> <td>GN1326A1</td> <td>ELEMENT SEALING</td> <td>5</td> <td>PZ</td> </tr> <tr> <td>VM1224A0</td> <td></td> <td>0.200</td> <td>M</td> </tr> </tbody> </table>	Code	Description	Qty	UOM	GN1326A1	ELEMENT SEALING	5	PZ	VM1224A0		0.200	M															
Code	Description	Qty	UOM																										
GN1326A1	ELEMENT SEALING	5	PZ																										
VM1224A0		0.200	M																										
GN1326A	ELEMENT SEALING		KRS1274A	100W MOTOR BRAKING ELEMENT KIT	<table border="1"> <thead> <tr> <th>Code</th> <th>Description</th> <th>Qty</th> <th>UOM</th> </tr> </thead> <tbody> <tr> <td>GN1326A1</td> <td>ELEMENT SEALING</td> <td>1</td> <td>PZ</td> </tr> <tr> <td>RS1274A0</td> <td>100W 60V 1 TURN FLAT ELEMENT</td> <td>1</td> <td>PZ</td> </tr> <tr> <td>SL1045A0</td> <td>S57 BLACK SILICONE - 80ML CARTRIDGE</td> <td>1</td> <td>PZ</td> </tr> <tr> <td>VI1220A1</td> <td>4,2X12 TCB SELF-TAPPIN G SCREW</td> <td>2</td> <td>PZ</td> </tr> </tbody> </table>	Code	Description	Qty	UOM	GN1326A1	ELEMENT SEALING	1	PZ	RS1274A0	100W 60V 1 TURN FLAT ELEMENT	1	PZ	SL1045A0	S57 BLACK SILICONE - 80ML CARTRIDGE	1	PZ	VI1220A1	4,2X12 TCB SELF-TAPPIN G SCREW	2	PZ				
			Code	Description	Qty	UOM																							
GN1326A1	ELEMENT SEALING	1	PZ																										
RS1274A0	100W 60V 1 TURN FLAT ELEMENT	1	PZ																										
SL1045A0	S57 BLACK SILICONE - 80ML CARTRIDGE	1	PZ																										
VI1220A1	4,2X12 TCB SELF-TAPPIN G SCREW	2	PZ																										
KRS1261A	122W MOTOR BREAKING ELEMENT KIT	<table border="1"> <thead> <tr> <th>Code</th> <th>Description</th> <th>Qty</th> <th>UOM</th> </tr> </thead> <tbody> <tr> <td>GN1326A1</td> <td>ELEMENT SEALING</td> <td>1</td> <td>PZ</td> </tr> <tr> <td>RS1261A0</td> <td>BAKERLUXICH EFLUX MOTOR BREAKING ELEMENT</td> <td>1</td> <td>PZ</td> </tr> <tr> <td>SL1045A0</td> <td>S57 BLACK SILICONE - 80ML CARTRIDGE</td> <td>1</td> <td>PZ</td> </tr> <tr> <td>VI1220A1</td> <td>4,2X12 TCB SELF-TAPPIN G SCREW</td> <td>2</td> <td>PZ</td> </tr> <tr> <td>VM2147A0</td> <td>410X343X15 MM PINK SMOOTH ESD SPONGE</td> <td>1</td> <td>PZ</td> </tr> </tbody> </table>	Code	Description	Qty	UOM	GN1326A1	ELEMENT SEALING	1	PZ	RS1261A0	BAKERLUXICH EFLUX MOTOR BREAKING ELEMENT	1	PZ	SL1045A0	S57 BLACK SILICONE - 80ML CARTRIDGE	1	PZ	VI1220A1	4,2X12 TCB SELF-TAPPIN G SCREW	2	PZ	VM2147A0	410X343X15 MM PINK SMOOTH ESD SPONGE	1	PZ			
Code	Description	Qty	UOM																										
GN1326A1	ELEMENT SEALING	1	PZ																										
RS1261A0	BAKERLUXICH EFLUX MOTOR BREAKING ELEMENT	1	PZ																										
SL1045A0	S57 BLACK SILICONE - 80ML CARTRIDGE	1	PZ																										
VI1220A1	4,2X12 TCB SELF-TAPPIN G SCREW	2	PZ																										
VM2147A0	410X343X15 MM PINK SMOOTH ESD SPONGE	1	PZ																										

COMPONENT			SPARE PART																														
Code	Description	Image	Code	Description	Components list																												
GN1326A	ELEMENT SEALING		KRS1215A	147W MOTOR BRAKING ELEMENT KIT	<table border="1"> <thead> <tr> <th>Code</th> <th>Description</th> <th>Qty</th> <th>UOM</th> </tr> </thead> <tbody> <tr> <td>GN1326A1</td> <td>ELEMENT SEALING</td> <td>1</td> <td>PZ</td> </tr> <tr> <td>RS1215A1</td> <td>147W 105V BRAKING ELEMENT</td> <td>1</td> <td>PZ</td> </tr> <tr> <td>SL1045A0</td> <td>S57 BLACK SILICONE - 80ML CARTRIDGE</td> <td>1</td> <td>PZ</td> </tr> <tr> <td>VI1220A1</td> <td>4,2X12 TCB SELF-TAPPIN G SCREW</td> <td>2</td> <td>PZ</td> </tr> </tbody> </table>	Code	Description	Qty	UOM	GN1326A1	ELEMENT SEALING	1	PZ	RS1215A1	147W 105V BRAKING ELEMENT	1	PZ	SL1045A0	S57 BLACK SILICONE - 80ML CARTRIDGE	1	PZ	VI1220A1	4,2X12 TCB SELF-TAPPIN G SCREW	2	PZ								
					Code	Description	Qty	UOM																									
					GN1326A1	ELEMENT SEALING	1	PZ																									
					RS1215A1	147W 105V BRAKING ELEMENT	1	PZ																									
			SL1045A0	S57 BLACK SILICONE - 80ML CARTRIDGE	1	PZ																											
			VI1220A1	4,2X12 TCB SELF-TAPPIN G SCREW	2	PZ																											
			KRS1095A	1.2KW HEATING ELEMENT KIT	<table border="1"> <thead> <tr> <th>Code</th> <th>Description</th> <th>Qty</th> <th>UOM</th> </tr> </thead> <tbody> <tr> <td>GN1326A1</td> <td>ELEMENT SEALING</td> <td>1</td> <td>PZ</td> </tr> <tr> <td>IP1385A1</td> <td>CORNER POLYSTYREN E PACKING 110X80X2000</td> <td>0.500</td> <td>M</td> </tr> <tr> <td>RS1095A1</td> <td>HEATING ELEMENT 1200W 230V</td> <td>1</td> <td>PZ</td> </tr> <tr> <td>SL1045A0</td> <td>S57 BLACK SILICONE - 80ML CARTRIDGE</td> <td>1</td> <td>PZ</td> </tr> <tr> <td>VI1220A1</td> <td>4,2X12 TCB SELF-TAPPIN G SCREW</td> <td>2</td> <td>PZ</td> </tr> <tr> <td>VM1059A1</td> <td>HEAT SHRINK FILM H800</td> <td>1.200</td> <td>M</td> </tr> </tbody> </table>	Code	Description	Qty	UOM	GN1326A1	ELEMENT SEALING	1	PZ	IP1385A1	CORNER POLYSTYREN E PACKING 110X80X2000	0.500	M	RS1095A1	HEATING ELEMENT 1200W 230V	1	PZ	SL1045A0	S57 BLACK SILICONE - 80ML CARTRIDGE	1	PZ	VI1220A1	4,2X12 TCB SELF-TAPPIN G SCREW	2	PZ	VM1059A1	HEAT SHRINK FILM H800	1.200	M
					Code	Description	Qty	UOM																									
					GN1326A1	ELEMENT SEALING	1	PZ																									
					IP1385A1	CORNER POLYSTYREN E PACKING 110X80X2000	0.500	M																									
			RS1095A1	HEATING ELEMENT 1200W 230V	1	PZ																											
			SL1045A0	S57 BLACK SILICONE - 80ML CARTRIDGE	1	PZ																											
VI1220A1	4,2X12 TCB SELF-TAPPIN G SCREW	2	PZ																														
VM1059A1	HEAT SHRINK FILM H800	1.200	M																														
KRS1012A	1365W 120V HEATING ELEMENT KIT	<table border="1"> <thead> <tr> <th>Code</th> <th>Description</th> <th>Qty</th> <th>UOM</th> </tr> </thead> <tbody> <tr> <td>GN1326A1</td> <td>ELEMENT SEALING</td> <td>1</td> <td>PZ</td> </tr> <tr> <td>RS1012A0</td> <td>CIRCULAR ELEMENT 1365W 120V</td> <td>1</td> <td>PZ</td> </tr> <tr> <td>VI1220A1</td> <td>4,2X12 TCB SELF-TAPPIN G SCREW</td> <td>5</td> <td>PZ</td> </tr> <tr> <td>VM1794A0</td> <td>250X4.8 PA66 BLACK CLAMP</td> <td>2</td> <td>PZ</td> </tr> <tr> <td>VM2103A0</td> <td>CLAMP LOCK</td> <td>2</td> <td>PZ</td> </tr> </tbody> </table>	Code	Description	Qty	UOM	GN1326A1	ELEMENT SEALING	1	PZ	RS1012A0	CIRCULAR ELEMENT 1365W 120V	1	PZ	VI1220A1	4,2X12 TCB SELF-TAPPIN G SCREW	5	PZ	VM1794A0	250X4.8 PA66 BLACK CLAMP	2	PZ	VM2103A0	CLAMP LOCK	2	PZ							
		Code	Description	Qty	UOM																												
		GN1326A1	ELEMENT SEALING	1	PZ																												
		RS1012A0	CIRCULAR ELEMENT 1365W 120V	1	PZ																												
		VI1220A1	4,2X12 TCB SELF-TAPPIN G SCREW	5	PZ																												
VM1794A0	250X4.8 PA66 BLACK CLAMP	2	PZ																														
VM2103A0	CLAMP LOCK	2	PZ																														
KRS1011A	ROBERTA/LISA HEATING ELEMENT KIT	<table border="1"> <thead> <tr> <th>Code</th> <th>Description</th> <th>Qty</th> <th>UOM</th> </tr> </thead> <tbody> <tr> <td>GN1326A1</td> <td>ELEMENT SEALING</td> <td>1</td> <td>PZ</td> </tr> <tr> <td>RS1011A0</td> <td>2560W 220-230V HEATING ELEMENT</td> <td>1</td> <td>PZ</td> </tr> </tbody> </table>	Code	Description	Qty	UOM	GN1326A1	ELEMENT SEALING	1	PZ	RS1011A0	2560W 220-230V HEATING ELEMENT	1	PZ																			
		Code	Description	Qty	UOM																												
GN1326A1	ELEMENT SEALING	1	PZ																														
RS1011A0	2560W 220-230V HEATING ELEMENT	1	PZ																														

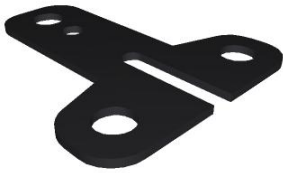
COMPONENT			SPARE PART																										
Code	Description	Image	Code	Description	Components list																								
GN1326A	ELEMENT SEALING		KRS1011A	ROBERTA/LISA HEATING ELEMENT KIT	<table border="1"> <thead> <tr> <th>Code</th> <th>Description</th> <th>Qty</th> <th>UOM</th> </tr> </thead> <tbody> <tr> <td>SL1045A0</td> <td>S57 BLACK SILICONE - 80ML CARTRIDGE</td> <td>1</td> <td>PZ</td> </tr> <tr> <td>V11220A1</td> <td>4,2X12 TCB SELF-TAPPIN G SCREW</td> <td>5</td> <td>PZ</td> </tr> <tr> <td>VM1794A0</td> <td>250X4.8 PA66 BLACK CLAMP</td> <td>2</td> <td>PZ</td> </tr> <tr> <td>VM2103A0</td> <td>CLAMP LOCK</td> <td>2</td> <td>PZ</td> </tr> </tbody> </table>	Code	Description	Qty	UOM	SL1045A0	S57 BLACK SILICONE - 80ML CARTRIDGE	1	PZ	V11220A1	4,2X12 TCB SELF-TAPPIN G SCREW	5	PZ	VM1794A0	250X4.8 PA66 BLACK CLAMP	2	PZ	VM2103A0	CLAMP LOCK	2	PZ				
			Code	Description	Qty	UOM																							
			SL1045A0	S57 BLACK SILICONE - 80ML CARTRIDGE	1	PZ																							
			V11220A1	4,2X12 TCB SELF-TAPPIN G SCREW	5	PZ																							
			VM1794A0	250X4.8 PA66 BLACK CLAMP	2	PZ																							
			VM2103A0	CLAMP LOCK	2	PZ																							
			KRS0090A	HEATING ELEMENT 1.26KW	<table border="1"> <thead> <tr> <th>Code</th> <th>Description</th> <th>Qty</th> <th>UOM</th> </tr> </thead> <tbody> <tr> <td>GN1326A1</td> <td>ELEMENT SEALING</td> <td>1</td> <td>PZ</td> </tr> <tr> <td>RS0090A0</td> <td>CIRC. HEAT. ELEMENT 1260W 220-230</td> <td>1</td> <td>PZ</td> </tr> <tr> <td>V11220A1</td> <td>4,2X12 TCB SELF-TAPPIN G SCREW</td> <td>3</td> <td>PZ</td> </tr> <tr> <td>VM1794A0</td> <td>250X4.8 PA66 BLACK CLAMP</td> <td>2</td> <td>PZ</td> </tr> <tr> <td>VM2103A0</td> <td>CLAMP LOCK</td> <td>2</td> <td>PZ</td> </tr> </tbody> </table>	Code	Description	Qty	UOM	GN1326A1	ELEMENT SEALING	1	PZ	RS0090A0	CIRC. HEAT. ELEMENT 1260W 220-230	1	PZ	V11220A1	4,2X12 TCB SELF-TAPPIN G SCREW	3	PZ	VM1794A0	250X4.8 PA66 BLACK CLAMP	2	PZ	VM2103A0	CLAMP LOCK	2	PZ
			Code	Description	Qty	UOM																							
			GN1326A1	ELEMENT SEALING	1	PZ																							
			RS0090A0	CIRC. HEAT. ELEMENT 1260W 220-230	1	PZ																							
			V11220A1	4,2X12 TCB SELF-TAPPIN G SCREW	3	PZ																							
			VM1794A0	250X4.8 PA66 BLACK CLAMP	2	PZ																							
VM2103A0	CLAMP LOCK	2	PZ																										
KRS0050A	HEATING ELEMENT KIT 0.5KW	<table border="1"> <thead> <tr> <th>Code</th> <th>Description</th> <th>Qty</th> <th>UOM</th> </tr> </thead> <tbody> <tr> <td>GN1326A1</td> <td>ELEMENT SEALING</td> <td>1</td> <td>PZ</td> </tr> <tr> <td>IP1075A1</td> <td></td> <td>1</td> <td>PZ</td> </tr> <tr> <td>IP1080A1</td> <td></td> <td>1</td> <td>PZ</td> </tr> <tr> <td>RS0050A0</td> <td>HEAT. ELEMENT 500W 220-230V LIEV</td> <td>1</td> <td>PZ</td> </tr> <tr> <td>V11220A1</td> <td>4,2X12 TCB SELF-TAPPIN G SCREW</td> <td>2</td> <td>PZ</td> </tr> </tbody> </table>	Code	Description	Qty	UOM	GN1326A1	ELEMENT SEALING	1	PZ	IP1075A1		1	PZ	IP1080A1		1	PZ	RS0050A0	HEAT. ELEMENT 500W 220-230V LIEV	1	PZ	V11220A1	4,2X12 TCB SELF-TAPPIN G SCREW	2	PZ			
Code	Description	Qty	UOM																										
GN1326A1	ELEMENT SEALING	1	PZ																										
IP1075A1		1	PZ																										
IP1080A1		1	PZ																										
RS0050A0	HEAT. ELEMENT 500W 220-230V LIEV	1	PZ																										
V11220A1	4,2X12 TCB SELF-TAPPIN G SCREW	2	PZ																										
KRS0011A	HEATING ELEMENT 1.465KW RS0011A	<table border="1"> <thead> <tr> <th>Code</th> <th>Description</th> <th>Qty</th> <th>UOM</th> </tr> </thead> <tbody> <tr> <td>GN1326A1</td> <td>ELEMENT SEALING</td> <td>1</td> <td>PZ</td> </tr> <tr> <td>RS0011A0</td> <td>CIRC.HEAT. ELEMENT 1465W 220-230</td> <td>1</td> <td>PZ</td> </tr> <tr> <td>V11220A1</td> <td>4,2X12 TCB SELF-TAPPIN G SCREW</td> <td>3</td> <td>PZ</td> </tr> <tr> <td>VM1794A0</td> <td>250X4.8 PA66 BLACK CLAMP</td> <td>2</td> <td>PZ</td> </tr> <tr> <td>VM2103A0</td> <td>CLAMP LOCK</td> <td>2</td> <td>PZ</td> </tr> </tbody> </table>	Code	Description	Qty	UOM	GN1326A1	ELEMENT SEALING	1	PZ	RS0011A0	CIRC.HEAT. ELEMENT 1465W 220-230	1	PZ	V11220A1	4,2X12 TCB SELF-TAPPIN G SCREW	3	PZ	VM1794A0	250X4.8 PA66 BLACK CLAMP	2	PZ	VM2103A0	CLAMP LOCK	2	PZ			
Code	Description	Qty	UOM																										
GN1326A1	ELEMENT SEALING	1	PZ																										
RS0011A0	CIRC.HEAT. ELEMENT 1465W 220-230	1	PZ																										
V11220A1	4,2X12 TCB SELF-TAPPIN G SCREW	3	PZ																										
VM1794A0	250X4.8 PA66 BLACK CLAMP	2	PZ																										
VM2103A0	CLAMP LOCK	2	PZ																										
KRS0010A	KIT HEATING ELEMENT RS10010A	<table border="1"> <thead> <tr> <th>Code</th> <th>Description</th> <th>Qty</th> <th>UOM</th> </tr> </thead> <tbody> <tr> <td>GN1326A1</td> <td>ELEMENT SEALING</td> <td>1</td> <td>PZ</td> </tr> <tr> <td>IP1075A1</td> <td></td> <td>1</td> <td>PZ</td> </tr> </tbody> </table>	Code	Description	Qty	UOM	GN1326A1	ELEMENT SEALING	1	PZ	IP1075A1		1	PZ															
Code	Description	Qty	UOM																										
GN1326A1	ELEMENT SEALING	1	PZ																										
IP1075A1		1	PZ																										

COMPONENT			SPARE PART																						
Code	Description	Image	Code	Description	Components list																				
GN1326A	ELEMENT SEALING		KRS0010A	KIT HEATING ELEMENT RS10010A	<table border="1"> <thead> <tr> <th>Code</th> <th>Description</th> <th>Qty</th> <th>UOM</th> </tr> </thead> <tbody> <tr> <td>IP1080A1</td> <td></td> <td>5</td> <td>PZ</td> </tr> <tr> <td>RS0010A0</td> <td>CIRC.HEAT. ELEMENT 2560W - 220-230 V</td> <td>1</td> <td>PZ</td> </tr> <tr> <td>VI1220A1</td> <td>4,2X12 TCB SELF-TAPPIN G SCREW</td> <td>3</td> <td>PZ</td> </tr> </tbody> </table>	Code	Description	Qty	UOM	IP1080A1		5	PZ	RS0010A0	CIRC.HEAT. ELEMENT 2560W - 220-230 V	1	PZ	VI1220A1	4,2X12 TCB SELF-TAPPIN G SCREW	3	PZ				
			Code	Description	Qty	UOM																			
IP1080A1		5	PZ																						
RS0010A0	CIRC.HEAT. ELEMENT 2560W - 220-230 V	1	PZ																						
VI1220A1	4,2X12 TCB SELF-TAPPIN G SCREW	3	PZ																						
KGN1326A	HEATING ELEMENT GASKET 5 PCS KIT	<table border="1"> <thead> <tr> <th>Code</th> <th>Description</th> <th>Qty</th> <th>UOM</th> </tr> </thead> <tbody> <tr> <td>GN1326A1</td> <td>ELEMENT SEALING</td> <td>5</td> <td>PZ</td> </tr> <tr> <td>VM1224A0</td> <td></td> <td>0.200</td> <td>M</td> </tr> </tbody> </table>	Code	Description	Qty	UOM	GN1326A1	ELEMENT SEALING	5	PZ	VM1224A0		0.200	M											
Code	Description	Qty	UOM																						
GN1326A1	ELEMENT SEALING	5	PZ																						
VM1224A0		0.200	M																						
RS1274A	100W 60V 1 TURN FLAT ELEMENT		KRS1274A	100W MOTOR BRAKING ELEMENT KIT	<table border="1"> <thead> <tr> <th>Code</th> <th>Description</th> <th>Qty</th> <th>UOM</th> </tr> </thead> <tbody> <tr> <td>GN1326A1</td> <td>ELEMENT SEALING</td> <td>1</td> <td>PZ</td> </tr> <tr> <td>RS1274A0</td> <td>100W 60V 1 TURN FLAT ELEMENT</td> <td>1</td> <td>PZ</td> </tr> <tr> <td>SL1045A0</td> <td>S57 BLACK SILICONE - 80ML CARTRIDGE</td> <td>1</td> <td>PZ</td> </tr> <tr> <td>VI1220A1</td> <td>4,2X12 TCB SELF-TAPPIN G SCREW</td> <td>2</td> <td>PZ</td> </tr> </tbody> </table>	Code	Description	Qty	UOM	GN1326A1	ELEMENT SEALING	1	PZ	RS1274A0	100W 60V 1 TURN FLAT ELEMENT	1	PZ	SL1045A0	S57 BLACK SILICONE - 80ML CARTRIDGE	1	PZ	VI1220A1	4,2X12 TCB SELF-TAPPIN G SCREW	2	PZ
			Code	Description	Qty	UOM																			
GN1326A1	ELEMENT SEALING	1	PZ																						
RS1274A0	100W 60V 1 TURN FLAT ELEMENT	1	PZ																						
SL1045A0	S57 BLACK SILICONE - 80ML CARTRIDGE	1	PZ																						
VI1220A1	4,2X12 TCB SELF-TAPPIN G SCREW	2	PZ																						
KRS0025A	BIG-L 100W MOTOR BRAKING ELEMENT KIT	<table border="1"> <thead> <tr> <th>Code</th> <th>Description</th> <th>Qty</th> <th>UOM</th> </tr> </thead> <tbody> <tr> <td>GN1672A0</td> <td></td> <td>1</td> <td>PZ</td> </tr> <tr> <td>RS1274A0</td> <td>100W 60V 1 TURN FLAT ELEMENT</td> <td>1</td> <td>PZ</td> </tr> <tr> <td>SL1045A0</td> <td>S57 BLACK SILICONE - 80ML CARTRIDGE</td> <td>1</td> <td>PZ</td> </tr> <tr> <td>VI1220A1</td> <td>4,2X12 TCB SELF-TAPPIN G SCREW</td> <td>2</td> <td>PZ</td> </tr> </tbody> </table>	Code	Description	Qty	UOM	GN1672A0		1	PZ	RS1274A0	100W 60V 1 TURN FLAT ELEMENT	1	PZ	SL1045A0	S57 BLACK SILICONE - 80ML CARTRIDGE	1	PZ	VI1220A1	4,2X12 TCB SELF-TAPPIN G SCREW	2	PZ			
Code	Description	Qty	UOM																						
GN1672A0		1	PZ																						
RS1274A0	100W 60V 1 TURN FLAT ELEMENT	1	PZ																						
SL1045A0	S57 BLACK SILICONE - 80ML CARTRIDGE	1	PZ																						
VI1220A1	4,2X12 TCB SELF-TAPPIN G SCREW	2	PZ																						
GN1531A	THERMOSTAT BULB INLET SEALING		KTR1136A	330 °C SAFETY THERMOSTAT KIT	<table border="1"> <thead> <tr> <th>Code</th> <th>Description</th> <th>Qty</th> <th>UOM</th> </tr> </thead> <tbody> <tr> <td>0H7030A0</td> <td>THERMOSTAT BULB INLET COVER</td> <td>1</td> <td>PZ</td> </tr> <tr> <td>GN1531A0</td> <td>THERMOSTAT BULB INLET SEALING</td> <td>1</td> <td>PZ</td> </tr> <tr> <td>SL1045A0</td> <td>S57 BLACK SILICONE - 80ML CARTRIDGE</td> <td>1</td> <td>PZ</td> </tr> </tbody> </table>	Code	Description	Qty	UOM	0H7030A0	THERMOSTAT BULB INLET COVER	1	PZ	GN1531A0	THERMOSTAT BULB INLET SEALING	1	PZ	SL1045A0	S57 BLACK SILICONE - 80ML CARTRIDGE	1	PZ				
Code	Description	Qty	UOM																						
0H7030A0	THERMOSTAT BULB INLET COVER	1	PZ																						
GN1531A0	THERMOSTAT BULB INLET SEALING	1	PZ																						
SL1045A0	S57 BLACK SILICONE - 80ML CARTRIDGE	1	PZ																						

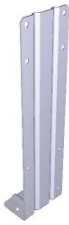
COMPONENT			SPARE PART														
Code	Description	Image	Code	Description	Components list												
GN1531A	THERMOSTAT BULB INLET SEALING		KTR1136A	330°C SAFETY THERMOSTAT KIT	<table border="1"> <thead> <tr> <th>Code</th> <th>Description</th> <th>Qty</th> <th>UOM</th> </tr> </thead> <tbody> <tr> <td>TR1136A0</td> <td>330°C 1 POLE SAFETY THERMOSTAT</td> <td>1</td> <td>PZ</td> </tr> <tr> <td>VI1220A1</td> <td>4,2X12 TCB SELF-TAPPING SCREW</td> <td>3</td> <td>PZ</td> </tr> </tbody> </table>	Code	Description	Qty	UOM	TR1136A0	330°C 1 POLE SAFETY THERMOSTAT	1	PZ	VI1220A1	4,2X12 TCB SELF-TAPPING SCREW	3	PZ
Code	Description	Qty	UOM														
TR1136A0	330°C 1 POLE SAFETY THERMOSTAT	1	PZ														
VI1220A1	4,2X12 TCB SELF-TAPPING SCREW	3	PZ														
0H7030A	THERMOSTAT BULB INLET COVER		K0H7030A	THERMOSTAT BULB INLET COVER KIT	<table border="1"> <thead> <tr> <th>Code</th> <th>Description</th> <th>Qty</th> <th>UOM</th> </tr> </thead> <tbody> <tr> <td>0H7030A0</td> <td>THERMOSTAT BULB INLET COVER</td> <td>1</td> <td>PZ</td> </tr> <tr> <td>VM1224A0</td> <td></td> <td>0.200</td> <td>M</td> </tr> </tbody> </table>	Code	Description	Qty	UOM	0H7030A0	THERMOSTAT BULB INLET COVER	1	PZ	VM1224A0		0.200	M
Code	Description	Qty	UOM														
0H7030A0	THERMOSTAT BULB INLET COVER	1	PZ														
VM1224A0		0.200	M														
0H2551A	XBC/XVC ST.STEEL DRAIN COVER		K0H2551A	DRAIN COVER KIT	<table border="1"> <thead> <tr> <th>Code</th> <th>Description</th> <th>Qty</th> <th>UOM</th> </tr> </thead> <tbody> <tr> <td>0H2551A0</td> <td>XBC/XVC ST.STEEL DRAIN COVER</td> <td>1</td> <td>PZ</td> </tr> <tr> <td>VM1224A0</td> <td></td> <td>0.200</td> <td>M</td> </tr> </tbody> </table>	Code	Description	Qty	UOM	0H2551A0	XBC/XVC ST.STEEL DRAIN COVER	1	PZ	VM1224A0		0.200	M
Code	Description	Qty	UOM														
0H2551A0	XBC/XVC ST.STEEL DRAIN COVER	1	PZ														
VM1224A0		0.200	M														
VM1820A	LATERAL SUPPORTS M6 FIXING BOLT		KVM1820A	THUMB SCREW 10PCS KIT	<table border="1"> <thead> <tr> <th>Code</th> <th>Description</th> <th>Qty</th> <th>UOM</th> </tr> </thead> <tbody> <tr> <td>VM1224A0</td> <td></td> <td>0.200</td> <td>M</td> </tr> <tr> <td>VM1820A0</td> <td>LATERAL SUPPORTS M6 FIXING BOLT</td> <td>10</td> <td>PZ</td> </tr> </tbody> </table>	Code	Description	Qty	UOM	VM1224A0		0.200	M	VM1820A0	LATERAL SUPPORTS M6 FIXING BOLT	10	PZ
Code	Description	Qty	UOM														
VM1224A0		0.200	M														
VM1820A0	LATERAL SUPPORTS M6 FIXING BOLT	10	PZ														
0H2730A	ZINC PLATED MUFFLE SUPPORT BRACKET		0H2730A1	ZINC PLATED MUFFLE SUPPORT BRACKET													







COMPONENT			SPARE PART																										
Code	Description	Image	Code	Description	Components list																								
GN1544A	AIR INLET GASKET		KTB3128A	XECC-1013-E VENTURI COLLECTOR PIPE KI	<table border="1"> <thead> <tr> <th>Code</th> <th>Description</th> <th>Qty</th> <th>UOM</th> </tr> </thead> <tbody> <tr> <td>GN1544A0</td> <td>AIR INLET GASKET</td> <td>1</td> <td>PZ</td> </tr> <tr> <td>GN1584A0</td> <td>CORNER FITTING D30-D16</td> <td>1</td> <td>PZ</td> </tr> <tr> <td>TB3128A0</td> <td>XECC-10 VENTURI AIR EXIT PIPE</td> <td>1</td> <td>PZ</td> </tr> </tbody> </table>	Code	Description	Qty	UOM	GN1544A0	AIR INLET GASKET	1	PZ	GN1584A0	CORNER FITTING D30-D16	1	PZ	TB3128A0	XECC-10 VENTURI AIR EXIT PIPE	1	PZ								
					Code	Description	Qty	UOM																					
					GN1544A0	AIR INLET GASKET	1	PZ																					
			GN1584A0	CORNER FITTING D30-D16	1	PZ																							
			TB3128A0	XECC-10 VENTURI AIR EXIT PIPE	1	PZ																							
			KTB3074B	XEVC-0711-G VENTURI COLLECTOR PIPE KI	<table border="1"> <thead> <tr> <th>Code</th> <th>Description</th> <th>Qty</th> <th>UOM</th> </tr> </thead> <tbody> <tr> <td>GN1544A0</td> <td>AIR INLET GASKET</td> <td>1</td> <td>PZ</td> </tr> <tr> <td>GN1584A0</td> <td>CORNER FITTING D30-D16</td> <td>1</td> <td>PZ</td> </tr> <tr> <td>RC1042A0</td> <td>DOUBLE WIRE SPRING CLAMP D21.5-22.6</td> <td>1</td> <td>PZ</td> </tr> <tr> <td>TB3074B0</td> <td>XEVC-07EU-G VENTURI COLLECTOR PIPE D30</td> <td>1</td> <td>PZ</td> </tr> <tr> <td>VM1794A0</td> <td>250X4.8 PA66 BLACK CLAMP</td> <td>1</td> <td>PZ</td> </tr> </tbody> </table>	Code	Description	Qty	UOM	GN1544A0	AIR INLET GASKET	1	PZ	GN1584A0	CORNER FITTING D30-D16	1	PZ	RC1042A0	DOUBLE WIRE SPRING CLAMP D21.5-22.6	1	PZ	TB3074B0	XEVC-07EU-G VENTURI COLLECTOR PIPE D30	1	PZ	VM1794A0	250X4.8 PA66 BLACK CLAMP	1	PZ
					Code	Description	Qty	UOM																					
					GN1544A0	AIR INLET GASKET	1	PZ																					
			GN1584A0	CORNER FITTING D30-D16	1	PZ																							
			RC1042A0	DOUBLE WIRE SPRING CLAMP D21.5-22.6	1	PZ																							
			TB3074B0	XEVC-07EU-G VENTURI COLLECTOR PIPE D30	1	PZ																							
			VM1794A0	250X4.8 PA66 BLACK CLAMP	1	PZ																							
KTB3068B	10FS/EU/2-G VENTURI COLLECTOR PIPE KI	<table border="1"> <thead> <tr> <th>Code</th> <th>Description</th> <th>Qty</th> <th>UOM</th> </tr> </thead> <tbody> <tr> <td>GN1544A0</td> <td>AIR INLET GASKET</td> <td>2</td> <td>PZ</td> </tr> <tr> <td>GN1584A0</td> <td>CORNER FITTING D30-D16</td> <td>1</td> <td>PZ</td> </tr> <tr> <td>RC1042A0</td> <td>DOUBLE WIRE SPRING CLAMP D21.5-22.6</td> <td>1</td> <td>PZ</td> </tr> <tr> <td>TB3068B0</td> <td>XEBC-10 VENTURI AIR COLLECTOR PIPE D30</td> <td>1</td> <td>PZ</td> </tr> <tr> <td>VM1794A0</td> <td>250X4.8 PA66 BLACK CLAMP</td> <td>1</td> <td>PZ</td> </tr> </tbody> </table>	Code	Description	Qty	UOM	GN1544A0	AIR INLET GASKET	2	PZ	GN1584A0	CORNER FITTING D30-D16	1	PZ	RC1042A0	DOUBLE WIRE SPRING CLAMP D21.5-22.6	1	PZ	TB3068B0	XEBC-10 VENTURI AIR COLLECTOR PIPE D30	1	PZ	VM1794A0	250X4.8 PA66 BLACK CLAMP	1	PZ			
		Code	Description	Qty	UOM																								
		GN1544A0	AIR INLET GASKET	2	PZ																								
		GN1584A0	CORNER FITTING D30-D16	1	PZ																								
		RC1042A0	DOUBLE WIRE SPRING CLAMP D21.5-22.6	1	PZ																								
		TB3068B0	XEBC-10 VENTURI AIR COLLECTOR PIPE D30	1	PZ																								
VM1794A0	250X4.8 PA66 BLACK CLAMP	1	PZ																										
KTB3019A	20XX/16XX UPPER VENTURI COLLECT PIPE KIT	<table border="1"> <thead> <tr> <th>Code</th> <th>Description</th> <th>Qty</th> <th>UOM</th> </tr> </thead> <tbody> <tr> <td>GN1544A0</td> <td>AIR INLET GASKET</td> <td>1</td> <td>PZ</td> </tr> <tr> <td>GN1584A0</td> <td>CORNER FITTING D30-D16</td> <td>1</td> <td>PZ</td> </tr> <tr> <td>RC1042A0</td> <td>DOUBLE WIRE SPRING CLAMP D21.5-22.6</td> <td>1</td> <td>PZ</td> </tr> </tbody> </table>	Code	Description	Qty	UOM	GN1544A0	AIR INLET GASKET	1	PZ	GN1584A0	CORNER FITTING D30-D16	1	PZ	RC1042A0	DOUBLE WIRE SPRING CLAMP D21.5-22.6	1	PZ											
		Code	Description	Qty	UOM																								
		GN1544A0	AIR INLET GASKET	1	PZ																								
GN1584A0	CORNER FITTING D30-D16	1	PZ																										
RC1042A0	DOUBLE WIRE SPRING CLAMP D21.5-22.6	1	PZ																										









COMPONENT			SPARE PART																										
Code	Description	Image	Code	Description	Components list																								
GN1544A	AIR INLET GASKET		KTB3019A	20XX/16XX UPPER VENTURI COLLECT PIPE KIT	<table border="1"> <thead> <tr> <th>Code</th> <th>Description</th> <th>Qty</th> <th>UOM</th> </tr> </thead> <tbody> <tr> <td>TB3019A1</td> <td>XEVC-2011 UPPER AIR INLET PIPE D3</td> <td>1</td> <td>PZ</td> </tr> <tr> <td>VM1794A0</td> <td>250X4.8 PA66 BLACK CLAMP</td> <td>1</td> <td>PZ</td> </tr> </tbody> </table>	Code	Description	Qty	UOM	TB3019A1	XEVC-2011 UPPER AIR INLET PIPE D3	1	PZ	VM1794A0	250X4.8 PA66 BLACK CLAMP	1	PZ												
			Code	Description	Qty	UOM																							
			TB3019A1	XEVC-2011 UPPER AIR INLET PIPE D3	1	PZ																							
			VM1794A0	250X4.8 PA66 BLACK CLAMP	1	PZ																							
			KTB2979C	XEBC-10XX-E VENTURI COLLECTOR PIPE KI	<table border="1"> <thead> <tr> <th>Code</th> <th>Description</th> <th>Qty</th> <th>UOM</th> </tr> </thead> <tbody> <tr> <td>GN1544A0</td> <td>AIR INLET GASKET</td> <td>2</td> <td>PZ</td> </tr> <tr> <td>GN1584A0</td> <td>CORNER FITTING D30-D16</td> <td>1</td> <td>PZ</td> </tr> <tr> <td>RC1042A0</td> <td>DOUBLE WIRE SPRING CLAMP D21.5-22.6</td> <td>1</td> <td>PZ</td> </tr> <tr> <td>TB2979C0</td> <td>XEBC-10 VENTURI AIR COLLECTOR PIPE D30</td> <td>1</td> <td>PZ</td> </tr> <tr> <td>VM1794A0</td> <td>250X4.8 PA66 BLACK CLAMP</td> <td>1</td> <td>PZ</td> </tr> </tbody> </table>	Code	Description	Qty	UOM	GN1544A0	AIR INLET GASKET	2	PZ	GN1584A0	CORNER FITTING D30-D16	1	PZ	RC1042A0	DOUBLE WIRE SPRING CLAMP D21.5-22.6	1	PZ	TB2979C0	XEBC-10 VENTURI AIR COLLECTOR PIPE D30	1	PZ	VM1794A0	250X4.8 PA66 BLACK CLAMP	1	PZ
			Code	Description	Qty	UOM																							
			GN1544A0	AIR INLET GASKET	2	PZ																							
			GN1584A0	CORNER FITTING D30-D16	1	PZ																							
			RC1042A0	DOUBLE WIRE SPRING CLAMP D21.5-22.6	1	PZ																							
			TB2979C0	XEBC-10 VENTURI AIR COLLECTOR PIPE D30	1	PZ																							
			VM1794A0	250X4.8 PA66 BLACK CLAMP	1	PZ																							
			KTB2978B	XEBC-06 VENTURI COLLECTOR PIPE KI	<table border="1"> <thead> <tr> <th>Code</th> <th>Description</th> <th>Qty</th> <th>UOM</th> </tr> </thead> <tbody> <tr> <td>GN1544A0</td> <td>AIR INLET GASKET</td> <td>1</td> <td>PZ</td> </tr> <tr> <td>GN1584A0</td> <td>CORNER FITTING D30-D16</td> <td>1</td> <td>PZ</td> </tr> <tr> <td>RC1042A0</td> <td>DOUBLE WIRE SPRING CLAMP D21.5-22.6</td> <td>1</td> <td>PZ</td> </tr> <tr> <td>TB2978B0</td> <td>XEBC-06 VENTURI AIR COLLECTOR PIPE D30</td> <td>1</td> <td>PZ</td> </tr> <tr> <td>VM1794A0</td> <td>250X4.8 PA66 BLACK CLAMP</td> <td>1</td> <td>PZ</td> </tr> </tbody> </table>	Code	Description	Qty	UOM	GN1544A0	AIR INLET GASKET	1	PZ	GN1584A0	CORNER FITTING D30-D16	1	PZ	RC1042A0	DOUBLE WIRE SPRING CLAMP D21.5-22.6	1	PZ	TB2978B0	XEBC-06 VENTURI AIR COLLECTOR PIPE D30	1	PZ	VM1794A0	250X4.8 PA66 BLACK CLAMP	1	PZ
Code	Description	Qty	UOM																										
GN1544A0	AIR INLET GASKET	1	PZ																										
GN1584A0	CORNER FITTING D30-D16	1	PZ																										
RC1042A0	DOUBLE WIRE SPRING CLAMP D21.5-22.6	1	PZ																										
TB2978B0	XEBC-06 VENTURI AIR COLLECTOR PIPE D30	1	PZ																										
VM1794A0	250X4.8 PA66 BLACK CLAMP	1	PZ																										
KTB2959B	XEVC-1011-E VENTURI COLLECTOR PIPE KI	<table border="1"> <thead> <tr> <th>Code</th> <th>Description</th> <th>Qty</th> <th>UOM</th> </tr> </thead> <tbody> <tr> <td>GN1544A0</td> <td>AIR INLET GASKET</td> <td>2</td> <td>PZ</td> </tr> <tr> <td>GN1584A0</td> <td>CORNER FITTING D30-D16</td> <td>1</td> <td>PZ</td> </tr> <tr> <td>RC1042A0</td> <td>DOUBLE WIRE SPRING CLAMP D21.5-22.6</td> <td>1</td> <td>PZ</td> </tr> <tr> <td>TB2959B0</td> <td>XEVC-1011-E VENTURI PIPE</td> <td>1</td> <td>PZ</td> </tr> <tr> <td>VM1794A0</td> <td>250X4.8 PA66 BLACK CLAMP</td> <td>1</td> <td>PZ</td> </tr> </tbody> </table>	Code	Description	Qty	UOM	GN1544A0	AIR INLET GASKET	2	PZ	GN1584A0	CORNER FITTING D30-D16	1	PZ	RC1042A0	DOUBLE WIRE SPRING CLAMP D21.5-22.6	1	PZ	TB2959B0	XEVC-1011-E VENTURI PIPE	1	PZ	VM1794A0	250X4.8 PA66 BLACK CLAMP	1	PZ			
Code	Description	Qty	UOM																										
GN1544A0	AIR INLET GASKET	2	PZ																										
GN1584A0	CORNER FITTING D30-D16	1	PZ																										
RC1042A0	DOUBLE WIRE SPRING CLAMP D21.5-22.6	1	PZ																										
TB2959B0	XEVC-1011-E VENTURI PIPE	1	PZ																										
VM1794A0	250X4.8 PA66 BLACK CLAMP	1	PZ																										



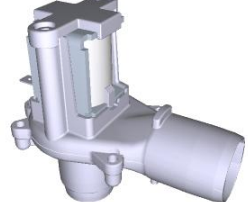

COMPONENT			SPARE PART																										
Code	Description	Image	Code	Description	Components list																								
GN1544A	AIR INLET GASKET		KTB2958B	XEVC-0711-E VENTURI COLLECTOR PIPE KI	<table border="1"> <thead> <tr> <th>Code</th> <th>Description</th> <th>Qty</th> <th>UOM</th> </tr> </thead> <tbody> <tr> <td>GN1544A0</td> <td>AIR INLET GASKET</td> <td>1</td> <td>PZ</td> </tr> <tr> <td>GN1584A0</td> <td>CORNER FITTING D30-D16</td> <td>1</td> <td>PZ</td> </tr> <tr> <td>RC1042A0</td> <td>DOUBLE WIRE SPRING CLAMP D21.5-22.6</td> <td>1</td> <td>PZ</td> </tr> <tr> <td>TB2958B0</td> <td>XEVC-0711-E VENTURI PIPE</td> <td>1</td> <td>PZ</td> </tr> <tr> <td>VM1794A0</td> <td>250X4.8 PA66 BLACK CLAMP</td> <td>1</td> <td>PZ</td> </tr> </tbody> </table>	Code	Description	Qty	UOM	GN1544A0	AIR INLET GASKET	1	PZ	GN1584A0	CORNER FITTING D30-D16	1	PZ	RC1042A0	DOUBLE WIRE SPRING CLAMP D21.5-22.6	1	PZ	TB2958B0	XEVC-0711-E VENTURI PIPE	1	PZ	VM1794A0	250X4.8 PA66 BLACK CLAMP	1	PZ
			Code	Description	Qty	UOM																							
			GN1544A0	AIR INLET GASKET	1	PZ																							
			GN1584A0	CORNER FITTING D30-D16	1	PZ																							
RC1042A0	DOUBLE WIRE SPRING CLAMP D21.5-22.6	1	PZ																										
TB2958B0	XEVC-0711-E VENTURI PIPE	1	PZ																										
VM1794A0	250X4.8 PA66 BLACK CLAMP	1	PZ																										
KTB2957B	0511/04EU-E VENTURI COLLECTOR PIPE KI	<table border="1"> <thead> <tr> <th>Code</th> <th>Description</th> <th>Qty</th> <th>UOM</th> </tr> </thead> <tbody> <tr> <td>GN1544A0</td> <td>AIR INLET GASKET</td> <td>1</td> <td>PZ</td> </tr> <tr> <td>GN1584A0</td> <td>CORNER FITTING D30-D16</td> <td>1</td> <td>PZ</td> </tr> <tr> <td>RC1042A0</td> <td>DOUBLE WIRE SPRING CLAMP D21.5-22.6</td> <td>1</td> <td>PZ</td> </tr> <tr> <td>TB2957B0</td> <td>XEVC-0511-E VENTURI PIPE</td> <td>1</td> <td>PZ</td> </tr> <tr> <td>VM1794A0</td> <td>250X4.8 PA66 BLACK CLAMP</td> <td>1</td> <td>PZ</td> </tr> </tbody> </table>	Code	Description	Qty	UOM	GN1544A0	AIR INLET GASKET	1	PZ	GN1584A0	CORNER FITTING D30-D16	1	PZ	RC1042A0	DOUBLE WIRE SPRING CLAMP D21.5-22.6	1	PZ	TB2957B0	XEVC-0511-E VENTURI PIPE	1	PZ	VM1794A0	250X4.8 PA66 BLACK CLAMP	1	PZ			
Code	Description	Qty	UOM																										
GN1544A0	AIR INLET GASKET	1	PZ																										
GN1584A0	CORNER FITTING D30-D16	1	PZ																										
RC1042A0	DOUBLE WIRE SPRING CLAMP D21.5-22.6	1	PZ																										
TB2957B0	XEVC-0511-E VENTURI PIPE	1	PZ																										
VM1794A0	250X4.8 PA66 BLACK CLAMP	1	PZ																										
KTB2956A	XEVC-0311-E VENTURI COLLECTOR PIPE KI	<table border="1"> <thead> <tr> <th>Code</th> <th>Description</th> <th>Qty</th> <th>UOM</th> </tr> </thead> <tbody> <tr> <td>GN1544A0</td> <td>AIR INLET GASKET</td> <td>1</td> <td>PZ</td> </tr> <tr> <td>RC1042A0</td> <td>DOUBLE WIRE SPRING CLAMP D21.5-22.6</td> <td>1</td> <td>PZ</td> </tr> <tr> <td>TB2956A0</td> <td>XEVC-0311-E VENTURI PIPE</td> <td>1</td> <td>PZ</td> </tr> </tbody> </table>	Code	Description	Qty	UOM	GN1544A0	AIR INLET GASKET	1	PZ	RC1042A0	DOUBLE WIRE SPRING CLAMP D21.5-22.6	1	PZ	TB2956A0	XEVC-0311-E VENTURI PIPE	1	PZ											
Code	Description	Qty	UOM																										
GN1544A0	AIR INLET GASKET	1	PZ																										
RC1042A0	DOUBLE WIRE SPRING CLAMP D21.5-22.6	1	PZ																										
TB2956A0	XEVC-0311-E VENTURI PIPE	1	PZ																										
KTB2944A	20XX/16XX LOWER VENTURI COLLECT PIPE KIT	<table border="1"> <thead> <tr> <th>Code</th> <th>Description</th> <th>Qty</th> <th>UOM</th> </tr> </thead> <tbody> <tr> <td>GN1544A0</td> <td>AIR INLET GASKET</td> <td>2</td> <td>PZ</td> </tr> <tr> <td>GN1584A0</td> <td>CORNER FITTING D30-D16</td> <td>1</td> <td>PZ</td> </tr> <tr> <td>RC1042A0</td> <td>DOUBLE WIRE SPRING CLAMP D21.5-22.6</td> <td>1</td> <td>PZ</td> </tr> <tr> <td>TB2944A1</td> <td>XEVC-2011 AIR INLET PIPE D3</td> <td>1</td> <td>PZ</td> </tr> <tr> <td>VM1794A0</td> <td>250X4.8 PA66 BLACK CLAMP</td> <td>1</td> <td>PZ</td> </tr> </tbody> </table>	Code	Description	Qty	UOM	GN1544A0	AIR INLET GASKET	2	PZ	GN1584A0	CORNER FITTING D30-D16	1	PZ	RC1042A0	DOUBLE WIRE SPRING CLAMP D21.5-22.6	1	PZ	TB2944A1	XEVC-2011 AIR INLET PIPE D3	1	PZ	VM1794A0	250X4.8 PA66 BLACK CLAMP	1	PZ			
Code	Description	Qty	UOM																										
GN1544A0	AIR INLET GASKET	2	PZ																										
GN1584A0	CORNER FITTING D30-D16	1	PZ																										
RC1042A0	DOUBLE WIRE SPRING CLAMP D21.5-22.6	1	PZ																										
TB2944A1	XEVC-2011 AIR INLET PIPE D3	1	PZ																										
VM1794A0	250X4.8 PA66 BLACK CLAMP	1	PZ																										

COMPONENT			SPARE PART																						
Code	Description	Image	Code	Description	Components list																				
GN1544A	AIR INLET GASKET		KTB1323A	XECC-05XX-E VENTURI COLLECTOR PIPE KI	<table border="1"> <thead> <tr> <th>Code</th> <th>Description</th> <th>Qty</th> <th>UOM</th> </tr> </thead> <tbody> <tr> <td>GN1544A0</td> <td>AIR INLET GASKET</td> <td>1</td> <td>PZ</td> </tr> <tr> <td>GN1584A0</td> <td>CORNER FITTING D30-D16</td> <td>1</td> <td>PZ</td> </tr> <tr> <td>RC1042A0</td> <td>DOUBLE WIRE SPRING CLAMP D21.5-22.6</td> <td>1</td> <td>PZ</td> </tr> <tr> <td>TB1323A1</td> <td>XECC-05XX VENTURI AIR EXIT PIPE</td> <td>1</td> <td>PZ</td> </tr> </tbody> </table>	Code	Description	Qty	UOM	GN1544A0	AIR INLET GASKET	1	PZ	GN1584A0	CORNER FITTING D30-D16	1	PZ	RC1042A0	DOUBLE WIRE SPRING CLAMP D21.5-22.6	1	PZ	TB1323A1	XECC-05XX VENTURI AIR EXIT PIPE	1	PZ
					Code	Description	Qty	UOM																	
GN1544A0	AIR INLET GASKET	1	PZ																						
GN1584A0	CORNER FITTING D30-D16	1	PZ																						
RC1042A0	DOUBLE WIRE SPRING CLAMP D21.5-22.6	1	PZ																						
TB1323A1	XECC-05XX VENTURI AIR EXIT PIPE	1	PZ																						
<table border="1"> <thead> <tr> <th>Code</th> <th>Description</th> <th>Qty</th> <th>UOM</th> </tr> </thead> <tbody> <tr> <td>GN1544A0</td> <td>AIR INLET GASKET</td> <td>5</td> <td>PZ</td> </tr> <tr> <td>VM1224A0</td> <td></td> <td>0.200</td> <td>M</td> </tr> </tbody> </table>	Code	Description	Qty	UOM	GN1544A0	AIR INLET GASKET	5	PZ	VM1224A0		0.200	M													
Code	Description	Qty	UOM																						
GN1544A0	AIR INLET GASKET	5	PZ																						
VM1224A0		0.200	M																						
RC1055A	Ø25-40 H12 STAINLESS STEEL PIPE CLIP		KRC1055A	Ø25-40 PIPE CLAMP 10PCS KIT	<table border="1"> <thead> <tr> <th>Code</th> <th>Description</th> <th>Qty</th> <th>UOM</th> </tr> </thead> <tbody> <tr> <td>RC1055A0</td> <td>Ø25-40 H12 STAINLESS STEEL PIPE CLIP</td> <td>10</td> <td>PZ</td> </tr> <tr> <td>VM1224A0</td> <td></td> <td>0.250</td> <td>M</td> </tr> </tbody> </table>	Code	Description	Qty	UOM	RC1055A0	Ø25-40 H12 STAINLESS STEEL PIPE CLIP	10	PZ	VM1224A0		0.250	M								
					Code	Description	Qty	UOM																	
RC1055A0	Ø25-40 H12 STAINLESS STEEL PIPE CLIP	10	PZ																						
VM1224A0		0.250	M																						
<table border="1"> <thead> <tr> <th>Code</th> <th>Description</th> <th>Qty</th> <th>UOM</th> </tr> </thead> <tbody> <tr> <td>VM1224A0</td> <td></td> <td>0.250</td> <td>M</td> </tr> </tbody> </table>	Code	Description	Qty	UOM	VM1224A0		0.250	M																	
Code	Description	Qty	UOM																						
VM1224A0		0.250	M																						
TB3020A	TB1520A-BLACK EPDM PIPE L=275M		TB3020A0	TB1520A-BLACK EPDM PIPE L=275M																					
TB3021A	TB1520A-BLACK EPDM PIPE L=448M		TB3021A0	TB1520A-BLACK EPDM PIPE L=448M																					

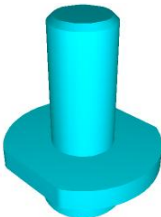
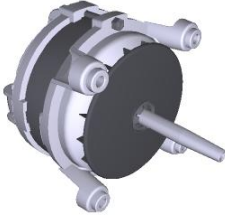

COMPONENT			SPARE PART																																																																		
Code	Description	Image	Code	Description	Components list																																																																
TB3022A	TB1520A-BLACK EPDM PIPE L=140M		TB3022A0	TB1520A-BLACK EPDM PIPE L=140M																																																																	
TB3023A	TB1520A-BLACK EPDM PIPE L=230M		TB3023A0	TB1520A-BLACK EPDM PIPE L=230M																																																																	
VM2377A	220 V 50/60 HZ VENTURI KIT		KVM2377A	MM 220 V VENTURI ACTUATOR SYSTEM KIT	<table border="1"> <thead> <tr> <th>Code</th> <th>Description</th> <th>Qty</th> <th>UOM</th> </tr> </thead> <tbody> <tr> <td>GN1556A0</td> <td>MM VENTURI SEAL</td> <td>1</td> <td>PZ</td> </tr> <tr> <td>RC1378A0</td> <td>HOSE CLAMP</td> <td>3</td> <td>PZ</td> </tr> <tr> <td>TB1520A0</td> <td>INT. Ø=38 TH=4 DRAIN BLACK RUBBER PIPE</td> <td>0.170</td> <td>M</td> </tr> <tr> <td>VE1135A0</td> <td>220 V 50/60 HZ VENTURI ACTUATOR</td> <td>1</td> <td>PZ</td> </tr> <tr> <td>VI1032A0</td> <td>SCREW M4X16 TCB+ INOX</td> <td>1</td> <td>PZ</td> </tr> <tr> <td>VI1220A1</td> <td>4,2X12 TCB SELF-TAPPIN G SCREW</td> <td>6</td> <td>PZ</td> </tr> <tr> <td>VM2345A0</td> <td>MM VENTURI UPPER BODY</td> <td>1</td> <td>PZ</td> </tr> <tr> <td>VM2345A0</td> <td>MM VENTURI UPPER BODY</td> <td>1</td> <td>PZ</td> </tr> <tr> <td>VM2346A0</td> <td>MM VENTURI LOWER BODY</td> <td>1</td> <td>PZ</td> </tr> <tr> <td>VM2346A0</td> <td>MM VENTURI LOWER BODY</td> <td>1</td> <td>PZ</td> </tr> <tr> <td>VM2346A1</td> <td>S6 VENTURI LOWER HALF</td> <td>1</td> <td>PZ</td> </tr> <tr> <td>VM2347A0</td> <td>VENTURI MIND.MAPS COVER</td> <td>1</td> <td>PZ</td> </tr> <tr> <td>VM2347A0</td> <td>VENTURI MIND.MAPS COVER</td> <td>1</td> <td>PZ</td> </tr> <tr> <td>VM2348A0</td> <td>VENTURI PLATE SPACE</td> <td>1</td> <td>PZ</td> </tr> <tr> <td>VM2348A0</td> <td>VENTURI PLATE SPACE</td> <td>1</td> <td>PZ</td> </tr> </tbody> </table>	Code	Description	Qty	UOM	GN1556A0	MM VENTURI SEAL	1	PZ	RC1378A0	HOSE CLAMP	3	PZ	TB1520A0	INT. Ø=38 TH=4 DRAIN BLACK RUBBER PIPE	0.170	M	VE1135A0	220 V 50/60 HZ VENTURI ACTUATOR	1	PZ	VI1032A0	SCREW M4X16 TCB+ INOX	1	PZ	VI1220A1	4,2X12 TCB SELF-TAPPIN G SCREW	6	PZ	VM2345A0	MM VENTURI UPPER BODY	1	PZ	VM2345A0	MM VENTURI UPPER BODY	1	PZ	VM2346A0	MM VENTURI LOWER BODY	1	PZ	VM2346A0	MM VENTURI LOWER BODY	1	PZ	VM2346A1	S6 VENTURI LOWER HALF	1	PZ	VM2347A0	VENTURI MIND.MAPS COVER	1	PZ	VM2347A0	VENTURI MIND.MAPS COVER	1	PZ	VM2348A0	VENTURI PLATE SPACE	1	PZ	VM2348A0	VENTURI PLATE SPACE	1	PZ
Code	Description	Qty	UOM																																																																		
GN1556A0	MM VENTURI SEAL	1	PZ																																																																		
RC1378A0	HOSE CLAMP	3	PZ																																																																		
TB1520A0	INT. Ø=38 TH=4 DRAIN BLACK RUBBER PIPE	0.170	M																																																																		
VE1135A0	220 V 50/60 HZ VENTURI ACTUATOR	1	PZ																																																																		
VI1032A0	SCREW M4X16 TCB+ INOX	1	PZ																																																																		
VI1220A1	4,2X12 TCB SELF-TAPPIN G SCREW	6	PZ																																																																		
VM2345A0	MM VENTURI UPPER BODY	1	PZ																																																																		
VM2345A0	MM VENTURI UPPER BODY	1	PZ																																																																		
VM2346A0	MM VENTURI LOWER BODY	1	PZ																																																																		
VM2346A0	MM VENTURI LOWER BODY	1	PZ																																																																		
VM2346A1	S6 VENTURI LOWER HALF	1	PZ																																																																		
VM2347A0	VENTURI MIND.MAPS COVER	1	PZ																																																																		
VM2347A0	VENTURI MIND.MAPS COVER	1	PZ																																																																		
VM2348A0	VENTURI PLATE SPACE	1	PZ																																																																		
VM2348A0	VENTURI PLATE SPACE	1	PZ																																																																		

COMPONENT			SPARE PART																						
Code	Description	Image	Code	Description	Components list																				
RC1042A	DOUBLE WIRE SPRING CLAMP D21.5-22.6		RC1042A0	DOUBLE WIRE SPRING CLAMP D21.5-22.6																					
VE1550A	5X3 MM NEODYMIUM MAGNET		KPE1710B	MOTOR REVOLUTIONS SENSOR KIT	<table border="1"> <thead> <tr> <th>Code</th> <th>Description</th> <th>Qty</th> <th>UOM</th> </tr> </thead> <tbody> <tr> <td>PE1710B0</td> <td>MOTOR REVOLUTION AND DIRECTION SENSOR</td> <td>1</td> <td>PZ</td> </tr> <tr> <td>VE1550A0</td> <td>5X3 MM NEODYMIUM MAGNET</td> <td>1</td> <td>PZ</td> </tr> <tr> <td>VI1966A0</td> <td>M4X14 FLATHEAD SCREW</td> <td>1</td> <td>PZ</td> </tr> <tr> <td>VM1635A0</td> <td>MAGNET HOLDING DIS</td> <td>1</td> <td>PZ</td> </tr> </tbody> </table>	Code	Description	Qty	UOM	PE1710B0	MOTOR REVOLUTION AND DIRECTION SENSOR	1	PZ	VE1550A0	5X3 MM NEODYMIUM MAGNET	1	PZ	VI1966A0	M4X14 FLATHEAD SCREW	1	PZ	VM1635A0	MAGNET HOLDING DIS	1	PZ
Code	Description	Qty	UOM																						
PE1710B0	MOTOR REVOLUTION AND DIRECTION SENSOR	1	PZ																						
VE1550A0	5X3 MM NEODYMIUM MAGNET	1	PZ																						
VI1966A0	M4X14 FLATHEAD SCREW	1	PZ																						
VM1635A0	MAGNET HOLDING DIS	1	PZ																						
PE1710B			KPE1710B	MOTOR REVOLUTIONS SENSOR KIT	<table border="1"> <thead> <tr> <th>Code</th> <th>Description</th> <th>Qty</th> <th>UOM</th> </tr> </thead> <tbody> <tr> <td>PE1710B0</td> <td>MOTOR REVOLUTION AND DIRECTION SENSOR</td> <td>1</td> <td>PZ</td> </tr> <tr> <td>VE1550A0</td> <td>5X3 MM NEODYMIUM MAGNET</td> <td>1</td> <td>PZ</td> </tr> <tr> <td>VI1966A0</td> <td>M4X14 FLATHEAD SCREW</td> <td>1</td> <td>PZ</td> </tr> <tr> <td>VM1635A0</td> <td>MAGNET HOLDING DIS</td> <td>1</td> <td>PZ</td> </tr> </tbody> </table>	Code	Description	Qty	UOM	PE1710B0	MOTOR REVOLUTION AND DIRECTION SENSOR	1	PZ	VE1550A0	5X3 MM NEODYMIUM MAGNET	1	PZ	VI1966A0	M4X14 FLATHEAD SCREW	1	PZ	VM1635A0	MAGNET HOLDING DIS	1	PZ
Code	Description	Qty	UOM																						
PE1710B0	MOTOR REVOLUTION AND DIRECTION SENSOR	1	PZ																						
VE1550A0	5X3 MM NEODYMIUM MAGNET	1	PZ																						
VI1966A0	M4X14 FLATHEAD SCREW	1	PZ																						
VM1635A0	MAGNET HOLDING DIS	1	PZ																						
GN1588A	78X28 G6.25 HEATING ELEMENT GASKET		GN1588A0	78X28 G6.25 HEATING ELEMENT GASKET																					

COMPONENT			SPARE PART																																																		
Code	Description	Image	Code	Description	Components list																																																
VM2416A	SMOKER LOCKING GUIDE PIN		VM2416A0	SMOKER LOCKING GUIDE PIN																																																	
MT1012A	330W 230V MOTOR		KMT1012A	MIND.MAPS 330W 230V MOTOR KIT	<table border="1"> <thead> <tr> <th>Code</th> <th>Description</th> <th>Qty</th> <th>UOM</th> </tr> </thead> <tbody> <tr> <td>0H4305A1</td> <td>ST. STEEL MOTOR SHAFT SEALING DISC</td> <td>1</td> <td>PZ</td> </tr> <tr> <td>GN1140A2</td> <td>MOTOR HOLDER GASKET</td> <td>1</td> <td>PZ</td> </tr> <tr> <td>GN1140A3</td> <td>MOLDED MOTOR HOLDER GASKET</td> <td>1</td> <td>PZ</td> </tr> <tr> <td>MT1012A0</td> <td>330W 230V MOTOR</td> <td>1</td> <td>PZ</td> </tr> <tr> <td>VE1550A0</td> <td>5X3 MM NEODYMIUM MAGNET</td> <td>1</td> <td>PZ</td> </tr> <tr> <td>VI1077A1</td> <td>SCREW M6X12 TE INOX</td> <td>1</td> <td>PZ</td> </tr> <tr> <td>VI1521A0</td> <td>STAINLESS STEEL WASHER D=6 6592</td> <td>1</td> <td>PZ</td> </tr> <tr> <td>VI1966A0</td> <td>M4X14 FLATHEAD SCREW</td> <td>1</td> <td>PZ</td> </tr> <tr> <td>VM1635A0</td> <td>MAGNET HOLDING DIS</td> <td>1</td> <td>PZ</td> </tr> <tr> <td>VM1794A0</td> <td>250X4.8 PA66 BLACK CLAMP</td> <td>4</td> <td>PZ</td> </tr> <tr> <td>VM2103A0</td> <td>CLAMP LOCK</td> <td>4</td> <td>PZ</td> </tr> </tbody> </table>	Code	Description	Qty	UOM	0H4305A1	ST. STEEL MOTOR SHAFT SEALING DISC	1	PZ	GN1140A2	MOTOR HOLDER GASKET	1	PZ	GN1140A3	MOLDED MOTOR HOLDER GASKET	1	PZ	MT1012A0	330W 230V MOTOR	1	PZ	VE1550A0	5X3 MM NEODYMIUM MAGNET	1	PZ	VI1077A1	SCREW M6X12 TE INOX	1	PZ	VI1521A0	STAINLESS STEEL WASHER D=6 6592	1	PZ	VI1966A0	M4X14 FLATHEAD SCREW	1	PZ	VM1635A0	MAGNET HOLDING DIS	1	PZ	VM1794A0	250X4.8 PA66 BLACK CLAMP	4	PZ	VM2103A0	CLAMP LOCK	4	PZ
Code	Description	Qty	UOM																																																		
0H4305A1	ST. STEEL MOTOR SHAFT SEALING DISC	1	PZ																																																		
GN1140A2	MOTOR HOLDER GASKET	1	PZ																																																		
GN1140A3	MOLDED MOTOR HOLDER GASKET	1	PZ																																																		
MT1012A0	330W 230V MOTOR	1	PZ																																																		
VE1550A0	5X3 MM NEODYMIUM MAGNET	1	PZ																																																		
VI1077A1	SCREW M6X12 TE INOX	1	PZ																																																		
VI1521A0	STAINLESS STEEL WASHER D=6 6592	1	PZ																																																		
VI1966A0	M4X14 FLATHEAD SCREW	1	PZ																																																		
VM1635A0	MAGNET HOLDING DIS	1	PZ																																																		
VM1794A0	250X4.8 PA66 BLACK CLAMP	4	PZ																																																		
VM2103A0	CLAMP LOCK	4	PZ																																																		
0H4305A	ST. STEEL MOTOR SHAFT SEALING DIS		K0H4305A	SEALING DISC FOR MOTOR SHAFT KIT	<table border="1"> <thead> <tr> <th>Code</th> <th>Description</th> <th>Qty</th> <th>UOM</th> </tr> </thead> <tbody> <tr> <td>0H4305A1</td> <td>ST. STEEL MOTOR SHAFT SEALING DISC</td> <td>1</td> <td>PZ</td> </tr> <tr> <td>GN1140A2</td> <td>MOTOR HOLDER GASKET</td> <td>1</td> <td>PZ</td> </tr> <tr> <td>GN1140A3</td> <td>MOLDED MOTOR HOLDER GASKET</td> <td>1</td> <td>PZ</td> </tr> </tbody> </table>	Code	Description	Qty	UOM	0H4305A1	ST. STEEL MOTOR SHAFT SEALING DISC	1	PZ	GN1140A2	MOTOR HOLDER GASKET	1	PZ	GN1140A3	MOLDED MOTOR HOLDER GASKET	1	PZ																																
Code	Description	Qty	UOM																																																		
0H4305A1	ST. STEEL MOTOR SHAFT SEALING DISC	1	PZ																																																		
GN1140A2	MOTOR HOLDER GASKET	1	PZ																																																		
GN1140A3	MOLDED MOTOR HOLDER GASKET	1	PZ																																																		

COMPONENT			SPARE PART																						
Code	Description	Image	Code	Description	Components list																				
0H4305A	ST. STEEL MOTOR SHAFT SEALING DIS		K0H4305A	SEALING DISC FOR MOTOR SHAFT KIT	<table border="1"> <thead> <tr> <th>Code</th> <th>Description</th> <th>Qty</th> <th>UOM</th> </tr> </thead> <tbody> <tr> <td>SL1045A0</td> <td>S57 BLACK SILICONE - 80ML CARTRIDGE</td> <td>1</td> <td>PZ</td> </tr> <tr> <td>V11220A1</td> <td>4,2X12 TCB SELF-TAPPING SCREW</td> <td>3</td> <td>PZ</td> </tr> </tbody> </table>	Code	Description	Qty	UOM	SL1045A0	S57 BLACK SILICONE - 80ML CARTRIDGE	1	PZ	V11220A1	4,2X12 TCB SELF-TAPPING SCREW	3	PZ								
					Code	Description	Qty	UOM																	
SL1045A0	S57 BLACK SILICONE - 80ML CARTRIDGE	1	PZ																						
V11220A1	4,2X12 TCB SELF-TAPPING SCREW	3	PZ																						
VN1170B	D195 H80 8 BLADES FAN+RING		KVN1170B	D195 H80 8 BLADES FAN + RING KIT	<table border="1"> <thead> <tr> <th>Code</th> <th>Description</th> <th>Qty</th> <th>UOM</th> </tr> </thead> <tbody> <tr> <td>V11077A1</td> <td>SCREW M6X12 TE INOX</td> <td>1</td> <td>PZ</td> </tr> <tr> <td>V11521A0</td> <td>STAINLESS STEEL WASHER D=6 6592</td> <td>1</td> <td>PZ</td> </tr> <tr> <td>VN1170B0</td> <td>D195 H80 8 BLADES FAN+RING</td> <td>1</td> <td>PZ</td> </tr> <tr> <td>VN1170B0</td> <td>D195 H80 8 BLADES FAN+RING</td> <td>1</td> <td>PZ</td> </tr> </tbody> </table>	Code	Description	Qty	UOM	V11077A1	SCREW M6X12 TE INOX	1	PZ	V11521A0	STAINLESS STEEL WASHER D=6 6592	1	PZ	VN1170B0	D195 H80 8 BLADES FAN+RING	1	PZ	VN1170B0	D195 H80 8 BLADES FAN+RING	1	PZ
					Code	Description	Qty	UOM																	
					V11077A1	SCREW M6X12 TE INOX	1	PZ																	
					V11521A0	STAINLESS STEEL WASHER D=6 6592	1	PZ																	
VN1170B0	D195 H80 8 BLADES FAN+RING	1	PZ																						
VN1170B0	D195 H80 8 BLADES FAN+RING	1	PZ																						
0H7170A	MM MOTOR GLASS WOOL PLATE		0H7170A0	MM MOTOR GLASS WOOL PLATE																					
GN1140A	MOLDED MOTOR HOLDER GASKET		GN1140A3	MOLDED MOTOR HOLDER GASKET																					
VL1037A	WASHING SYSTEM ROTOR		KVL1037A	WASHING SYSTEM ROTOR KIT	<table border="1"> <thead> <tr> <th>Code</th> <th>Description</th> <th>Qty</th> <th>UOM</th> </tr> </thead> <tbody> <tr> <td>GN1416B0</td> <td>WASHING SYSTEM ROTOR BEARING</td> <td>1</td> <td>PZ</td> </tr> <tr> <td>TF1065B0</td> <td>WASHING SYSTEM ROTOR PIVOT</td> <td>1</td> <td>PZ</td> </tr> <tr> <td>TF1066A1</td> <td>WASHING SYSTEM ROTOR BUSH</td> <td>1</td> <td>PZ</td> </tr> </tbody> </table>	Code	Description	Qty	UOM	GN1416B0	WASHING SYSTEM ROTOR BEARING	1	PZ	TF1065B0	WASHING SYSTEM ROTOR PIVOT	1	PZ	TF1066A1	WASHING SYSTEM ROTOR BUSH	1	PZ				
					Code	Description	Qty	UOM																	
					GN1416B0	WASHING SYSTEM ROTOR BEARING	1	PZ																	
TF1065B0	WASHING SYSTEM ROTOR PIVOT	1	PZ																						
TF1066A1	WASHING SYSTEM ROTOR BUSH	1	PZ																						





COMPONENT			SPARE PART																																														
Code	Description	Image	Code	Description	Components list																																												
VL1037A	WASHING SYSTEM ROTOR		KVL1037A	WASHING SYSTEM ROTOR KIT	<table border="1"> <thead> <tr> <th>Code</th> <th>Description</th> <th>Qty</th> <th>UOM</th> </tr> </thead> <tbody> <tr> <td>UG1005B1</td> <td>LONG RAY ROTOR WATER NOZZL</td> <td>1</td> <td>PZ</td> </tr> <tr> <td>UG1006B3</td> <td>LONG RAY ROTOR WATER NOZZL</td> <td>1</td> <td>PZ</td> </tr> <tr> <td>VI1220A1</td> <td>4,2X12 TCB SELF-TAPPIN G SCREW</td> <td>8</td> <td>PZ</td> </tr> <tr> <td>VM1224A0</td> <td></td> <td>0.250</td> <td>M</td> </tr> <tr> <td>VM1955C0</td> <td>WASHING SYSTEM ROTOR</td> <td>1</td> <td>PZ</td> </tr> <tr> <td>VM1985C1</td> <td>WASHING SYSTEM ROTOR COVE</td> <td>1</td> <td>PZ</td> </tr> <tr> <td>VM1986A0</td> <td>NOZZLE COVE</td> <td>2</td> <td>PZ</td> </tr> </tbody> </table>	Code	Description	Qty	UOM	UG1005B1	LONG RAY ROTOR WATER NOZZL	1	PZ	UG1006B3	LONG RAY ROTOR WATER NOZZL	1	PZ	VI1220A1	4,2X12 TCB SELF-TAPPIN G SCREW	8	PZ	VM1224A0		0.250	M	VM1955C0	WASHING SYSTEM ROTOR	1	PZ	VM1985C1	WASHING SYSTEM ROTOR COVE	1	PZ	VM1986A0	NOZZLE COVE	2	PZ												
Code	Description	Qty	UOM																																														
UG1005B1	LONG RAY ROTOR WATER NOZZL	1	PZ																																														
UG1006B3	LONG RAY ROTOR WATER NOZZL	1	PZ																																														
VI1220A1	4,2X12 TCB SELF-TAPPIN G SCREW	8	PZ																																														
VM1224A0		0.250	M																																														
VM1955C0	WASHING SYSTEM ROTOR	1	PZ																																														
VM1985C1	WASHING SYSTEM ROTOR COVE	1	PZ																																														
VM1986A0	NOZZLE COVE	2	PZ																																														
VL1037A	WASHING SYSTEM ROTOR		KVL1037A	WASHING SYSTEM ROTOR KIT	<table border="1"> <thead> <tr> <th>Code</th> <th>Description</th> <th>Qty</th> <th>UOM</th> </tr> </thead> <tbody> <tr> <td>GN1416B0</td> <td>WASHING SYSTEM ROTOR BEARING</td> <td>1</td> <td>PZ</td> </tr> <tr> <td>TF1065B0</td> <td>WASHING SYSTEM ROTOR PIVOT</td> <td>1</td> <td>PZ</td> </tr> <tr> <td>TF1066A1</td> <td>WASHING SYSTEM ROTOR BUSH</td> <td>1</td> <td>PZ</td> </tr> <tr> <td>UG1005B1</td> <td>LONG RAY ROTOR WATER NOZZL</td> <td>1</td> <td>PZ</td> </tr> <tr> <td>UG1006B3</td> <td>LONG RAY ROTOR WATER NOZZL</td> <td>1</td> <td>PZ</td> </tr> <tr> <td>VI1220A1</td> <td>4,2X12 TCB SELF-TAPPIN G SCREW</td> <td>8</td> <td>PZ</td> </tr> <tr> <td>VM1224A0</td> <td></td> <td>0.250</td> <td>M</td> </tr> <tr> <td>VM1955C0</td> <td>WASHING SYSTEM ROTOR</td> <td>1</td> <td>PZ</td> </tr> <tr> <td>VM1985C1</td> <td>WASHING SYSTEM ROTOR COVE</td> <td>1</td> <td>PZ</td> </tr> <tr> <td>VM1986A0</td> <td>NOZZLE COVE</td> <td>2</td> <td>PZ</td> </tr> </tbody> </table>	Code	Description	Qty	UOM	GN1416B0	WASHING SYSTEM ROTOR BEARING	1	PZ	TF1065B0	WASHING SYSTEM ROTOR PIVOT	1	PZ	TF1066A1	WASHING SYSTEM ROTOR BUSH	1	PZ	UG1005B1	LONG RAY ROTOR WATER NOZZL	1	PZ	UG1006B3	LONG RAY ROTOR WATER NOZZL	1	PZ	VI1220A1	4,2X12 TCB SELF-TAPPIN G SCREW	8	PZ	VM1224A0		0.250	M	VM1955C0	WASHING SYSTEM ROTOR	1	PZ	VM1985C1	WASHING SYSTEM ROTOR COVE	1	PZ	VM1986A0	NOZZLE COVE	2	PZ
Code	Description	Qty	UOM																																														
GN1416B0	WASHING SYSTEM ROTOR BEARING	1	PZ																																														
TF1065B0	WASHING SYSTEM ROTOR PIVOT	1	PZ																																														
TF1066A1	WASHING SYSTEM ROTOR BUSH	1	PZ																																														
UG1005B1	LONG RAY ROTOR WATER NOZZL	1	PZ																																														
UG1006B3	LONG RAY ROTOR WATER NOZZL	1	PZ																																														
VI1220A1	4,2X12 TCB SELF-TAPPIN G SCREW	8	PZ																																														
VM1224A0		0.250	M																																														
VM1955C0	WASHING SYSTEM ROTOR	1	PZ																																														
VM1985C1	WASHING SYSTEM ROTOR COVE	1	PZ																																														
VM1986A0	NOZZLE COVE	2	PZ																																														



COMPONENT			SPARE PART																																		
Code	Description	Image	Code	Description	Components list																																
GN1555B	XEVC-2011 DOOR GASKET		KGN1661A	TROLLEY OVENS DOOR GASKET KIT	<table border="1"> <thead> <tr> <th>Code</th> <th>Description</th> <th>Qty</th> <th>UOM</th> </tr> </thead> <tbody> <tr> <td>GN1626A0</td> <td>DOUBLE LIP-TYPE FRONT GASKE</td> <td>4.190</td> <td>M</td> </tr> <tr> <td>SL1025A0</td> <td>CLEAR SILICON DOW CORNING 734</td> <td>0.012</td> <td>PZ</td> </tr> <tr> <td>VM1224A0</td> <td></td> <td>0.450</td> <td>M</td> </tr> <tr> <td>VM2277A0</td> <td>DOOR SEAL KIT INTERNAL CONNECTION</td> <td>1</td> <td>PZ</td> </tr> </tbody> </table>	Code	Description	Qty	UOM	GN1626A0	DOUBLE LIP-TYPE FRONT GASKE	4.190	M	SL1025A0	CLEAR SILICON DOW CORNING 734	0.012	PZ	VM1224A0		0.450	M	VM2277A0	DOOR SEAL KIT INTERNAL CONNECTION	1	PZ												
Code	Description	Qty	UOM																																		
GN1626A0	DOUBLE LIP-TYPE FRONT GASKE	4.190	M																																		
SL1025A0	CLEAR SILICON DOW CORNING 734	0.012	PZ																																		
VM1224A0		0.450	M																																		
VM2277A0	DOOR SEAL KIT INTERNAL CONNECTION	1	PZ																																		
GN1285A	NTC TEMPERATURE PROBE SEALING		KTR1106B	MIND.MAPS L2000 CHAMBER TEMP. PROBE KIT	<table border="1"> <thead> <tr> <th>Code</th> <th>Description</th> <th>Qty</th> <th>UOM</th> </tr> </thead> <tbody> <tr> <td>GN1285A0</td> <td>NTC TEMPERATUR E PROBE SEALING</td> <td>1</td> <td>PZ</td> </tr> <tr> <td>SL1045A0</td> <td>S57 BLACK SILICONE - 80ML CARTRIDGE</td> <td>1</td> <td>PZ</td> </tr> <tr> <td>TR1106B0</td> <td></td> <td>1</td> <td>PZ</td> </tr> <tr> <td>VI1220A1</td> <td>4,2X12 TCB SELF-TAPPIN G SCREW</td> <td>2</td> <td>PZ</td> </tr> <tr> <td>VM1464A1</td> <td>CT BT TEMPERATUR E PROBE COVER</td> <td>1</td> <td>PZ</td> </tr> <tr> <td>VM1465A0</td> <td>CHEFTOP TEMPERATUR E PROBE COVER</td> <td>1</td> <td>PZ</td> </tr> <tr> <td>VM1465A1</td> <td>CT BT TEMPERATUR E PROBE COVER</td> <td>1</td> <td>PZ</td> </tr> </tbody> </table>	Code	Description	Qty	UOM	GN1285A0	NTC TEMPERATUR E PROBE SEALING	1	PZ	SL1045A0	S57 BLACK SILICONE - 80ML CARTRIDGE	1	PZ	TR1106B0		1	PZ	VI1220A1	4,2X12 TCB SELF-TAPPIN G SCREW	2	PZ	VM1464A1	CT BT TEMPERATUR E PROBE COVER	1	PZ	VM1465A0	CHEFTOP TEMPERATUR E PROBE COVER	1	PZ	VM1465A1	CT BT TEMPERATUR E PROBE COVER	1	PZ
Code	Description	Qty	UOM																																		
GN1285A0	NTC TEMPERATUR E PROBE SEALING	1	PZ																																		
SL1045A0	S57 BLACK SILICONE - 80ML CARTRIDGE	1	PZ																																		
TR1106B0		1	PZ																																		
VI1220A1	4,2X12 TCB SELF-TAPPIN G SCREW	2	PZ																																		
VM1464A1	CT BT TEMPERATUR E PROBE COVER	1	PZ																																		
VM1465A0	CHEFTOP TEMPERATUR E PROBE COVER	1	PZ																																		
VM1465A1	CT BT TEMPERATUR E PROBE COVER	1	PZ																																		
			KTR1106A	5-5E S. L2000 CHAMBER TEMP. PROBE KIT	<table border="1"> <thead> <tr> <th>Code</th> <th>Description</th> <th>Qty</th> <th>UOM</th> </tr> </thead> <tbody> <tr> <td>GN1285A0</td> <td>NTC TEMPERATUR E PROBE SEALING</td> <td>1</td> <td>PZ</td> </tr> <tr> <td>SL1045A0</td> <td>S57 BLACK SILICONE - 80ML CARTRIDGE</td> <td>1</td> <td>PZ</td> </tr> <tr> <td>TR1106A3</td> <td>PT100 L=2000 TEMPERATUR E PROBE</td> <td>1</td> <td>PZ</td> </tr> <tr> <td>VI1220A1</td> <td>4,2X12 TCB SELF-TAPPIN G SCREW</td> <td>2</td> <td>PZ</td> </tr> </tbody> </table>	Code	Description	Qty	UOM	GN1285A0	NTC TEMPERATUR E PROBE SEALING	1	PZ	SL1045A0	S57 BLACK SILICONE - 80ML CARTRIDGE	1	PZ	TR1106A3	PT100 L=2000 TEMPERATUR E PROBE	1	PZ	VI1220A1	4,2X12 TCB SELF-TAPPIN G SCREW	2	PZ												
Code	Description	Qty	UOM																																		
GN1285A0	NTC TEMPERATUR E PROBE SEALING	1	PZ																																		
SL1045A0	S57 BLACK SILICONE - 80ML CARTRIDGE	1	PZ																																		
TR1106A3	PT100 L=2000 TEMPERATUR E PROBE	1	PZ																																		
VI1220A1	4,2X12 TCB SELF-TAPPIN G SCREW	2	PZ																																		

COMPONENT			SPARE PART																																							
Code	Description	Image	Code	Description	Components list																																					
GN1285A	NTC TEMPERATURE PROBE SEALING		KTR1106A	5-5E S. L2000 CHAMBER TEMP. PROBE KIT	<table border="1"> <thead> <tr> <th>Code</th> <th>Description</th> <th>Qty</th> <th>UOM</th> </tr> </thead> <tbody> <tr> <td>VM1465A0</td> <td>CHEFTOP TEMPERATUR E PROBE COVER</td> <td>1</td> <td>PZ</td> </tr> <tr> <td>VM1465A1</td> <td>CT BT TEMPERATUR E PROBE COVER</td> <td>1</td> <td>PZ</td> </tr> </tbody> </table>	Code	Description	Qty	UOM	VM1465A0	CHEFTOP TEMPERATUR E PROBE COVER	1	PZ	VM1465A1	CT BT TEMPERATUR E PROBE COVER	1	PZ																									
			Code	Description	Qty	UOM																																				
			VM1465A0	CHEFTOP TEMPERATUR E PROBE COVER	1	PZ																																				
VM1465A1	CT BT TEMPERATUR E PROBE COVER	1	PZ																																							
KTR1105A	PT100 L1000 TEMPERATURE PROBE KIT	<table border="1"> <thead> <tr> <th>Code</th> <th>Description</th> <th>Qty</th> <th>UOM</th> </tr> </thead> <tbody> <tr> <td>GN1120A0</td> <td>TEMPERATUR E PROBE NTC SEAL</td> <td>1</td> <td>PZ</td> </tr> <tr> <td>GN1120A1</td> <td></td> <td>1</td> <td>PZ</td> </tr> <tr> <td>GN1285A0</td> <td>NTC TEMPERATUR E PROBE SEALING</td> <td>1</td> <td>PZ</td> </tr> <tr> <td>SL1045A0</td> <td>S57 BLACK SILICONE - 80ML CARTRIDGE</td> <td>1</td> <td>PZ</td> </tr> <tr> <td>TR1105A4</td> <td></td> <td>1</td> <td>PZ</td> </tr> <tr> <td>VI1220A1</td> <td>4,2X12 TCB SELF-TAPPIN G SCREW</td> <td>2</td> <td>PZ</td> </tr> <tr> <td>VM1464A1</td> <td>CT BT TEMPERATUR E PROBE COVER</td> <td>1</td> <td>PZ</td> </tr> <tr> <td>VM1465A1</td> <td>CT BT TEMPERATUR E PROBE COVER</td> <td>1</td> <td>PZ</td> </tr> <tr> <td>VM2052A0</td> <td>LM CORE PROBE COVE</td> <td>1</td> <td>PZ</td> </tr> </tbody> </table>	Code	Description	Qty	UOM	GN1120A0	TEMPERATUR E PROBE NTC SEAL	1	PZ	GN1120A1		1	PZ	GN1285A0	NTC TEMPERATUR E PROBE SEALING	1	PZ	SL1045A0	S57 BLACK SILICONE - 80ML CARTRIDGE	1	PZ	TR1105A4		1	PZ	VI1220A1	4,2X12 TCB SELF-TAPPIN G SCREW	2	PZ	VM1464A1	CT BT TEMPERATUR E PROBE COVER	1	PZ	VM1465A1	CT BT TEMPERATUR E PROBE COVER	1	PZ	VM2052A0	LM CORE PROBE COVE	1	PZ
Code	Description	Qty	UOM																																							
GN1120A0	TEMPERATUR E PROBE NTC SEAL	1	PZ																																							
GN1120A1		1	PZ																																							
GN1285A0	NTC TEMPERATUR E PROBE SEALING	1	PZ																																							
SL1045A0	S57 BLACK SILICONE - 80ML CARTRIDGE	1	PZ																																							
TR1105A4		1	PZ																																							
VI1220A1	4,2X12 TCB SELF-TAPPIN G SCREW	2	PZ																																							
VM1464A1	CT BT TEMPERATUR E PROBE COVER	1	PZ																																							
VM1465A1	CT BT TEMPERATUR E PROBE COVER	1	PZ																																							
VM2052A0	LM CORE PROBE COVE	1	PZ																																							
KTR1096A	NTC 150 L=1500 TEMPERATURE PROBE KIT	<table border="1"> <thead> <tr> <th>Code</th> <th>Description</th> <th>Qty</th> <th>UOM</th> </tr> </thead> <tbody> <tr> <td>GN1120A0</td> <td>TEMPERATUR E PROBE NTC SEAL</td> <td>1</td> <td>PZ</td> </tr> <tr> <td>GN1120A1</td> <td></td> <td>1</td> <td>PZ</td> </tr> <tr> <td>GN1285A0</td> <td>NTC TEMPERATUR E PROBE SEALING</td> <td>2</td> <td>PZ</td> </tr> <tr> <td>SL1045A0</td> <td>S57 BLACK SILICONE - 80ML CARTRIDGE</td> <td>1</td> <td>PZ</td> </tr> <tr> <td>TR1096A0</td> <td>TEMPERATUR E PROBE NTC 150 L=1500</td> <td>1</td> <td>PZ</td> </tr> </tbody> </table>	Code	Description	Qty	UOM	GN1120A0	TEMPERATUR E PROBE NTC SEAL	1	PZ	GN1120A1		1	PZ	GN1285A0	NTC TEMPERATUR E PROBE SEALING	2	PZ	SL1045A0	S57 BLACK SILICONE - 80ML CARTRIDGE	1	PZ	TR1096A0	TEMPERATUR E PROBE NTC 150 L=1500	1	PZ																
Code	Description	Qty	UOM																																							
GN1120A0	TEMPERATUR E PROBE NTC SEAL	1	PZ																																							
GN1120A1		1	PZ																																							
GN1285A0	NTC TEMPERATUR E PROBE SEALING	2	PZ																																							
SL1045A0	S57 BLACK SILICONE - 80ML CARTRIDGE	1	PZ																																							
TR1096A0	TEMPERATUR E PROBE NTC 150 L=1500	1	PZ																																							

COMPONENT			SPARE PART																																			
Code	Description	Image	Code	Description	Components list																																	
GN1285A	NTC TEMPERATURE PROBE SEALING		KTR1096A	NTC 150 L=1500 TEMPERATURE PROBE KIT	<table border="1"> <thead> <tr> <th>Code</th> <th>Description</th> <th>Qty</th> <th>UOM</th> </tr> </thead> <tbody> <tr> <td>VI1220A1</td> <td>4,2X12 TCB SELF-TAPPIN G SCREW</td> <td>2</td> <td>PZ</td> </tr> <tr> <td>VM1465A0</td> <td>CHEFTOP TEMPERATUR E PROBE COVER</td> <td>1</td> <td>PZ</td> </tr> <tr> <td>VM1465A1</td> <td>CT BT TEMPERATUR E PROBE COVER</td> <td>1</td> <td>PZ</td> </tr> </tbody> </table>	Code	Description	Qty	UOM	VI1220A1	4,2X12 TCB SELF-TAPPIN G SCREW	2	PZ	VM1465A0	CHEFTOP TEMPERATUR E PROBE COVER	1	PZ	VM1465A1	CT BT TEMPERATUR E PROBE COVER	1	PZ																	
			Code	Description	Qty	UOM																																
			VI1220A1	4,2X12 TCB SELF-TAPPIN G SCREW	2	PZ																																
VM1465A0	CHEFTOP TEMPERATUR E PROBE COVER	1	PZ																																			
VM1465A1	CT BT TEMPERATUR E PROBE COVER	1	PZ																																			
KTR1095A	NTC 150 L=1050 TEMPERATURE PROBE KIT	<table border="1"> <thead> <tr> <th>Code</th> <th>Description</th> <th>Qty</th> <th>UOM</th> </tr> </thead> <tbody> <tr> <td>GN1120A0</td> <td>TEMPERATUR E PROBE NTC SEAL</td> <td>1</td> <td>PZ</td> </tr> <tr> <td>GN1120A1</td> <td></td> <td>1</td> <td>PZ</td> </tr> <tr> <td>GN1285A0</td> <td>NTC TEMPERATUR E PROBE SEALING</td> <td>1</td> <td>PZ</td> </tr> <tr> <td>SL1045A0</td> <td>S57 BLACK SILICONE - 80ML CARTRIDGE</td> <td>1</td> <td>PZ</td> </tr> <tr> <td>TR1095A0</td> <td>TEMPERATUR E PROBE NTC 150 L=1050</td> <td>1</td> <td>PZ</td> </tr> <tr> <td>VI1220A1</td> <td>4,2X12 TCB SELF-TAPPIN G SCREW</td> <td>2</td> <td>PZ</td> </tr> <tr> <td>VM1465A0</td> <td>CHEFTOP TEMPERATUR E PROBE COVER</td> <td>1</td> <td>PZ</td> </tr> <tr> <td>VM1465A1</td> <td>CT BT TEMPERATUR E PROBE COVER</td> <td>1</td> <td>PZ</td> </tr> </tbody> </table>	Code	Description	Qty	UOM	GN1120A0	TEMPERATUR E PROBE NTC SEAL	1	PZ	GN1120A1		1	PZ	GN1285A0	NTC TEMPERATUR E PROBE SEALING	1	PZ	SL1045A0	S57 BLACK SILICONE - 80ML CARTRIDGE	1	PZ	TR1095A0	TEMPERATUR E PROBE NTC 150 L=1050	1	PZ	VI1220A1	4,2X12 TCB SELF-TAPPIN G SCREW	2	PZ	VM1465A0	CHEFTOP TEMPERATUR E PROBE COVER	1	PZ	VM1465A1	CT BT TEMPERATUR E PROBE COVER	1	PZ
Code	Description	Qty	UOM																																			
GN1120A0	TEMPERATUR E PROBE NTC SEAL	1	PZ																																			
GN1120A1		1	PZ																																			
GN1285A0	NTC TEMPERATUR E PROBE SEALING	1	PZ																																			
SL1045A0	S57 BLACK SILICONE - 80ML CARTRIDGE	1	PZ																																			
TR1095A0	TEMPERATUR E PROBE NTC 150 L=1050	1	PZ																																			
VI1220A1	4,2X12 TCB SELF-TAPPIN G SCREW	2	PZ																																			
VM1465A0	CHEFTOP TEMPERATUR E PROBE COVER	1	PZ																																			
VM1465A1	CT BT TEMPERATUR E PROBE COVER	1	PZ																																			
KTR1002A	PT100 L1000 UL TEMPERATURE PROBE KIT	<table border="1"> <thead> <tr> <th>Code</th> <th>Description</th> <th>Qty</th> <th>UOM</th> </tr> </thead> <tbody> <tr> <td>GN1285A0</td> <td>NTC TEMPERATUR E PROBE SEALING</td> <td>2</td> <td>PZ</td> </tr> <tr> <td>SL1045A0</td> <td>S57 BLACK SILICONE - 80ML CARTRIDGE</td> <td>1</td> <td>PZ</td> </tr> <tr> <td>TR1002A1</td> <td></td> <td>1</td> <td>PZ</td> </tr> <tr> <td>VI1220A1</td> <td>4,2X12 TCB SELF-TAPPIN G SCREW</td> <td>2</td> <td>PZ</td> </tr> </tbody> </table>	Code	Description	Qty	UOM	GN1285A0	NTC TEMPERATUR E PROBE SEALING	2	PZ	SL1045A0	S57 BLACK SILICONE - 80ML CARTRIDGE	1	PZ	TR1002A1		1	PZ	VI1220A1	4,2X12 TCB SELF-TAPPIN G SCREW	2	PZ																
Code	Description	Qty	UOM																																			
GN1285A0	NTC TEMPERATUR E PROBE SEALING	2	PZ																																			
SL1045A0	S57 BLACK SILICONE - 80ML CARTRIDGE	1	PZ																																			
TR1002A1		1	PZ																																			
VI1220A1	4,2X12 TCB SELF-TAPPIN G SCREW	2	PZ																																			



COMPONENT			SPARE PART																																		
Code	Description	Image	Code	Description	Components list																																
GN1285A	NTC TEMPERATURE PROBE SEALING		KTR1002A	PT100 L1000 UL TEMPERATURE PROBE KIT	<table border="1"> <thead> <tr> <th>Code</th> <th>Description</th> <th>Qty</th> <th>UOM</th> </tr> </thead> <tbody> <tr> <td>VM1465A0</td> <td>CHEFTOP TEMPERATUR E PROBE COVER</td> <td>1</td> <td>PZ</td> </tr> <tr> <td>VM1465A1</td> <td>CT BT TEMPERATUR E PROBE COVER</td> <td>1</td> <td>PZ</td> </tr> </tbody> </table>	Code	Description	Qty	UOM	VM1465A0	CHEFTOP TEMPERATUR E PROBE COVER	1	PZ	VM1465A1	CT BT TEMPERATUR E PROBE COVER	1	PZ																				
Code	Description	Qty	UOM																																		
VM1465A0	CHEFTOP TEMPERATUR E PROBE COVER	1	PZ																																		
VM1465A1	CT BT TEMPERATUR E PROBE COVER	1	PZ																																		
VM1464A	CT BT TEMPERATURE PROBE COVER		KVM1464A	CT BT TEMPERATURE PROBE COVER KIT	<table border="1"> <thead> <tr> <th>Code</th> <th>Description</th> <th>Qty</th> <th>UOM</th> </tr> </thead> <tbody> <tr> <td>VM1224A0</td> <td></td> <td>0.150</td> <td>M</td> </tr> <tr> <td>VM1464A1</td> <td>CT BT TEMPERATUR E PROBE COVER</td> <td>1</td> <td>PZ</td> </tr> </tbody> </table>	Code	Description	Qty	UOM	VM1224A0		0.150	M	VM1464A1	CT BT TEMPERATUR E PROBE COVER	1	PZ																				
Code	Description	Qty	UOM																																		
VM1224A0		0.150	M																																		
VM1464A1	CT BT TEMPERATUR E PROBE COVER	1	PZ																																		
TR1106B			KTR1106B	MIND.MAPS L2000 CHAMBER TEMP. PROBE KIT	<table border="1"> <thead> <tr> <th>Code</th> <th>Description</th> <th>Qty</th> <th>UOM</th> </tr> </thead> <tbody> <tr> <td>GN1285A0</td> <td>NTC TEMPERATUR E PROBE SEALING</td> <td>1</td> <td>PZ</td> </tr> <tr> <td>SL1045A0</td> <td>S57 BLACK SILICONE - 80ML CARTRIDGE</td> <td>1</td> <td>PZ</td> </tr> <tr> <td>TR1106B0</td> <td></td> <td>1</td> <td>PZ</td> </tr> <tr> <td>VI1220A1</td> <td>4,2X12 TCB SELF-TAPPIN G SCREW</td> <td>2</td> <td>PZ</td> </tr> <tr> <td>VM1464A1</td> <td>CT BT TEMPERATUR E PROBE COVER</td> <td>1</td> <td>PZ</td> </tr> <tr> <td>VM1465A0</td> <td>CHEFTOP TEMPERATUR E PROBE COVER</td> <td>1</td> <td>PZ</td> </tr> <tr> <td>VM1465A1</td> <td>CT BT TEMPERATUR E PROBE COVER</td> <td>1</td> <td>PZ</td> </tr> </tbody> </table>	Code	Description	Qty	UOM	GN1285A0	NTC TEMPERATUR E PROBE SEALING	1	PZ	SL1045A0	S57 BLACK SILICONE - 80ML CARTRIDGE	1	PZ	TR1106B0		1	PZ	VI1220A1	4,2X12 TCB SELF-TAPPIN G SCREW	2	PZ	VM1464A1	CT BT TEMPERATUR E PROBE COVER	1	PZ	VM1465A0	CHEFTOP TEMPERATUR E PROBE COVER	1	PZ	VM1465A1	CT BT TEMPERATUR E PROBE COVER	1	PZ
Code	Description	Qty	UOM																																		
GN1285A0	NTC TEMPERATUR E PROBE SEALING	1	PZ																																		
SL1045A0	S57 BLACK SILICONE - 80ML CARTRIDGE	1	PZ																																		
TR1106B0		1	PZ																																		
VI1220A1	4,2X12 TCB SELF-TAPPIN G SCREW	2	PZ																																		
VM1464A1	CT BT TEMPERATUR E PROBE COVER	1	PZ																																		
VM1465A0	CHEFTOP TEMPERATUR E PROBE COVER	1	PZ																																		
VM1465A1	CT BT TEMPERATUR E PROBE COVER	1	PZ																																		
0H7741B	HEAT EXCH TIE ROD ANTI ROTATION PLATE		0H7741B0	HEAT EXCH TIE ROD ANTI ROTATION PLATE																																	

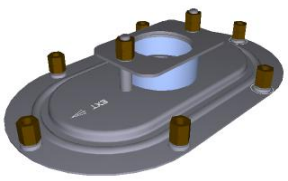

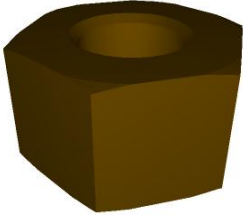
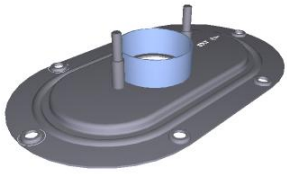

COMPONENT			SPARE PART																																																		
Code	Description	Image	Code	Description	Components list																																																
0N1503A			XRF013	MM HEAT EXCHANGERS SEALING RETROFIT KIT	<table border="1"> <thead> <tr> <th>Code</th> <th>Description</th> <th>Qty</th> <th>UOM</th> </tr> </thead> <tbody> <tr> <td>0N1503A1</td> <td></td> <td>4</td> <td>PZ</td> </tr> <tr> <td>LV1085A0</td> <td>Ø4 ROUND GLASS FIBRE STRING</td> <td>1</td> <td>M</td> </tr> <tr> <td>LV1086A0</td> <td>Ø5 ROUND GLASS FIBRE STRING</td> <td>1.320</td> <td>M</td> </tr> <tr> <td>SL1045A0</td> <td>S57 BLACK SILICONE - 80ML CARTRIDGE</td> <td>1</td> <td>PZ</td> </tr> <tr> <td>VM1224A0</td> <td></td> <td>0.300</td> <td>M</td> </tr> </tbody> </table>	Code	Description	Qty	UOM	0N1503A1		4	PZ	LV1085A0	Ø4 ROUND GLASS FIBRE STRING	1	M	LV1086A0	Ø5 ROUND GLASS FIBRE STRING	1.320	M	SL1045A0	S57 BLACK SILICONE - 80ML CARTRIDGE	1	PZ	VM1224A0		0.300	M																								
Code	Description	Qty	UOM																																																		
0N1503A1		4	PZ																																																		
LV1085A0	Ø4 ROUND GLASS FIBRE STRING	1	M																																																		
LV1086A0	Ø5 ROUND GLASS FIBRE STRING	1.320	M																																																		
SL1045A0	S57 BLACK SILICONE - 80ML CARTRIDGE	1	PZ																																																		
VM1224A0		0.300	M																																																		
0N1436D			K0N1436D	XEVC-2011-G HEAT EXCHANGER KIT	<table border="1"> <thead> <tr> <th>Code</th> <th>Description</th> <th>Qty</th> <th>UOM</th> </tr> </thead> <tbody> <tr> <td>0H7741B0</td> <td>HEAT EXCH TIE ROD ANTI ROTATION PLATE</td> <td>2</td> <td>PZ</td> </tr> <tr> <td>0N1436D0</td> <td></td> <td>1</td> <td>PZ</td> </tr> <tr> <td>0N1503A1</td> <td></td> <td>2</td> <td>PZ</td> </tr> <tr> <td>GN1580B0</td> <td>M8 TIE ROD GASKET</td> <td>2</td> <td>PZ</td> </tr> <tr> <td>IP1508A1</td> <td>POLYSTYREN E U SHAPED PROFILE 2000X60X60</td> <td>2</td> <td>M</td> </tr> <tr> <td>LV1085A0</td> <td>Ø4 ROUND GLASS FIBRE STRING</td> <td>1.050</td> <td>M</td> </tr> <tr> <td>LV1086A0</td> <td>Ø5 ROUND GLASS FIBRE STRING</td> <td>0.660</td> <td>M</td> </tr> <tr> <td>SL1045A0</td> <td>S57 BLACK SILICONE - 80ML CARTRIDGE</td> <td>1</td> <td>PZ</td> </tr> <tr> <td>VI1521A0</td> <td>STAINLESS STEEL WASHER D=6 6592</td> <td>3</td> <td>PZ</td> </tr> <tr> <td>VI2018A0</td> <td>NUT M6</td> <td>4</td> <td>PZ</td> </tr> <tr> <td>VM1059A1</td> <td>HEAT SHRINK FILM H800</td> <td>1</td> <td>M</td> </tr> </tbody> </table>	Code	Description	Qty	UOM	0H7741B0	HEAT EXCH TIE ROD ANTI ROTATION PLATE	2	PZ	0N1436D0		1	PZ	0N1503A1		2	PZ	GN1580B0	M8 TIE ROD GASKET	2	PZ	IP1508A1	POLYSTYREN E U SHAPED PROFILE 2000X60X60	2	M	LV1085A0	Ø4 ROUND GLASS FIBRE STRING	1.050	M	LV1086A0	Ø5 ROUND GLASS FIBRE STRING	0.660	M	SL1045A0	S57 BLACK SILICONE - 80ML CARTRIDGE	1	PZ	VI1521A0	STAINLESS STEEL WASHER D=6 6592	3	PZ	VI2018A0	NUT M6	4	PZ	VM1059A1	HEAT SHRINK FILM H800	1	M
Code	Description	Qty	UOM																																																		
0H7741B0	HEAT EXCH TIE ROD ANTI ROTATION PLATE	2	PZ																																																		
0N1436D0		1	PZ																																																		
0N1503A1		2	PZ																																																		
GN1580B0	M8 TIE ROD GASKET	2	PZ																																																		
IP1508A1	POLYSTYREN E U SHAPED PROFILE 2000X60X60	2	M																																																		
LV1085A0	Ø4 ROUND GLASS FIBRE STRING	1.050	M																																																		
LV1086A0	Ø5 ROUND GLASS FIBRE STRING	0.660	M																																																		
SL1045A0	S57 BLACK SILICONE - 80ML CARTRIDGE	1	PZ																																																		
VI1521A0	STAINLESS STEEL WASHER D=6 6592	3	PZ																																																		
VI2018A0	NUT M6	4	PZ																																																		
VM1059A1	HEAT SHRINK FILM H800	1	M																																																		
ASM4291A	Exchanger		ASM4291A0	Exchanger																																																	







COMPONENT			SPARE PART																																						
Code	Description	Image	Code	Description	Components list																																				
VI1555A	Ø6 ST. STEEL SCHNOOR KNURLED WASHER		VI1555A0	Ø6 ST. STEEL SCHNOOR KNURLED WASHER																																					
VI2018A	NUT M6		VI2018A0	NUT M6																																					
0N1462A	FLANGE SEALING CHIMNEY 40 HEAT EXCHANGER		K0N1462A	D40 CHIMNEY FLANGE KIT	<table border="1"> <thead> <tr> <th>Code</th> <th>Description</th> <th>Qty</th> <th>UOM</th> </tr> </thead> <tbody> <tr> <td>0N1462A0</td> <td>FLANGE SEALING CHIMNEY 40 HEAT EXCHANGER</td> <td>1</td> <td>PZ</td> </tr> <tr> <td>0N1462A1</td> <td>FLANGE SEALING CHIMNEY 40 HEAT EXCHANGER</td> <td>1</td> <td>PZ</td> </tr> <tr> <td>0N1478A0</td> <td>CHIMNEY HOLDING DISC SEALING 40 BIG</td> <td>2</td> <td>PZ</td> </tr> <tr> <td>0N1479A0</td> <td>PLATE SEALING CHIMNEY 40 BIG</td> <td>1</td> <td>PZ</td> </tr> <tr> <td>LV1085A0</td> <td>Ø4 ROUND GLASS FIBRE STRING</td> <td>1.050</td> <td>M</td> </tr> <tr> <td>SL1045A0</td> <td>S57 BLACK SILICONE - 80ML CARTRIDGE</td> <td>1</td> <td>PZ</td> </tr> <tr> <td>VI1555A0</td> <td>Ø6 ST. STEEL SCHNOOR KNURLED WASHER</td> <td>8</td> <td>PZ</td> </tr> <tr> <td>VI2018A0</td> <td>NUT M6</td> <td>16</td> <td>PZ</td> </tr> </tbody> </table>	Code	Description	Qty	UOM	0N1462A0	FLANGE SEALING CHIMNEY 40 HEAT EXCHANGER	1	PZ	0N1462A1	FLANGE SEALING CHIMNEY 40 HEAT EXCHANGER	1	PZ	0N1478A0	CHIMNEY HOLDING DISC SEALING 40 BIG	2	PZ	0N1479A0	PLATE SEALING CHIMNEY 40 BIG	1	PZ	LV1085A0	Ø4 ROUND GLASS FIBRE STRING	1.050	M	SL1045A0	S57 BLACK SILICONE - 80ML CARTRIDGE	1	PZ	VI1555A0	Ø6 ST. STEEL SCHNOOR KNURLED WASHER	8	PZ	VI2018A0	NUT M6	16	PZ
Code	Description	Qty	UOM																																						
0N1462A0	FLANGE SEALING CHIMNEY 40 HEAT EXCHANGER	1	PZ																																						
0N1462A1	FLANGE SEALING CHIMNEY 40 HEAT EXCHANGER	1	PZ																																						
0N1478A0	CHIMNEY HOLDING DISC SEALING 40 BIG	2	PZ																																						
0N1479A0	PLATE SEALING CHIMNEY 40 BIG	1	PZ																																						
LV1085A0	Ø4 ROUND GLASS FIBRE STRING	1.050	M																																						
SL1045A0	S57 BLACK SILICONE - 80ML CARTRIDGE	1	PZ																																						
VI1555A0	Ø6 ST. STEEL SCHNOOR KNURLED WASHER	8	PZ																																						
VI2018A0	NUT M6	16	PZ																																						









COMPONENT			SPARE PART																		
Code	Description	Image	Code	Description	Components list																
0N1478A	CHIMNEY HOLDING DISC SEALING 40 BI		0N1478A0	CHIMNEY HOLDING DISC SEALING 40 BI																	
0N1479A	PLATE SEALING CHIMNEY 40 BIG		0N1479A0	PLATE SEALING CHIMNEY 40 BIG																	
TB2917A	XEVC-2011-E 5 WAYS WATER PIPE ASSEMBLY		KTB2917A	XEVC-2011-E 5 WAY WATER PIPE KIT	<table border="1"> <thead> <tr> <th>Code</th> <th>Description</th> <th>Qty</th> <th>UOM</th> </tr> </thead> <tbody> <tr> <td>TB2917A0</td> <td>XEVC-2011-E 5 WAYS WATER PIPE ASSEMBLY</td> <td>1</td> <td>PZ</td> </tr> <tr> <td>VM1224A0</td> <td></td> <td>0.010</td> <td>M</td> </tr> </tbody> </table>	Code	Description	Qty	UOM	TB2917A0	XEVC-2011-E 5 WAYS WATER PIPE ASSEMBLY	1	PZ	VM1224A0		0.010	M				
Code	Description	Qty	UOM																		
TB2917A0	XEVC-2011-E 5 WAYS WATER PIPE ASSEMBLY	1	PZ																		
VM1224A0		0.010	M																		
VM2251A	STEAM WATER INLET UPPER DISTRIBUTOR		KVM2251A	STEAM WATER INLET UP+LO DISTRIBUTORS KIT	<table border="1"> <thead> <tr> <th>Code</th> <th>Description</th> <th>Qty</th> <th>UOM</th> </tr> </thead> <tbody> <tr> <td>VM1224A0</td> <td></td> <td>0.150</td> <td>M</td> </tr> <tr> <td>VM2251A0</td> <td>STEAM WATER INLET UPPER DISTRIBUTOR</td> <td>1</td> <td>PZ</td> </tr> <tr> <td>VM2252A0</td> <td>STEAM WATER INLET LOWER DISTRIBUTOR</td> <td>1</td> <td>PZ</td> </tr> </tbody> </table>	Code	Description	Qty	UOM	VM1224A0		0.150	M	VM2251A0	STEAM WATER INLET UPPER DISTRIBUTOR	1	PZ	VM2252A0	STEAM WATER INLET LOWER DISTRIBUTOR	1	PZ
Code	Description	Qty	UOM																		
VM1224A0		0.150	M																		
VM2251A0	STEAM WATER INLET UPPER DISTRIBUTOR	1	PZ																		
VM2252A0	STEAM WATER INLET LOWER DISTRIBUTOR	1	PZ																		
VM2252A	STEAM WATER INLET LOWER DISTRIBUTOR		KVM2251A	STEAM WATER INLET UP+LO DISTRIBUTORS KIT	<table border="1"> <thead> <tr> <th>Code</th> <th>Description</th> <th>Qty</th> <th>UOM</th> </tr> </thead> <tbody> <tr> <td>VM1224A0</td> <td></td> <td>0.150</td> <td>M</td> </tr> <tr> <td>VM2251A0</td> <td>STEAM WATER INLET UPPER DISTRIBUTOR</td> <td>1</td> <td>PZ</td> </tr> <tr> <td>VM2252A0</td> <td>STEAM WATER INLET LOWER DISTRIBUTOR</td> <td>1</td> <td>PZ</td> </tr> </tbody> </table>	Code	Description	Qty	UOM	VM1224A0		0.150	M	VM2251A0	STEAM WATER INLET UPPER DISTRIBUTOR	1	PZ	VM2252A0	STEAM WATER INLET LOWER DISTRIBUTOR	1	PZ
Code	Description	Qty	UOM																		
VM1224A0		0.150	M																		
VM2251A0	STEAM WATER INLET UPPER DISTRIBUTOR	1	PZ																		
VM2252A0	STEAM WATER INLET LOWER DISTRIBUTOR	1	PZ																		

COMPONENT			SPARE PART																		
Code	Description	Image	Code	Description	Components list																
VM2251A	STEAM WATER INLET UPPER DISTRIBUTOR		KVM2251A	STEAM WATER INLET UP+LO DISTRIBUTORS KIT	<table border="1"> <thead> <tr> <th>Code</th> <th>Description</th> <th>Qty</th> <th>UOM</th> </tr> </thead> <tbody> <tr> <td>VM1224A0</td> <td></td> <td>0.150</td> <td>M</td> </tr> <tr> <td>VM2251A0</td> <td>STEAM WATER INLET UPPER DISTRIBUTOR</td> <td>1</td> <td>PZ</td> </tr> <tr> <td>VM2252A0</td> <td>STEAM WATER INLET LOWER DISTRIBUTOR</td> <td>1</td> <td>PZ</td> </tr> </tbody> </table>	Code	Description	Qty	UOM	VM1224A0		0.150	M	VM2251A0	STEAM WATER INLET UPPER DISTRIBUTOR	1	PZ	VM2252A0	STEAM WATER INLET LOWER DISTRIBUTOR	1	PZ
					Code	Description	Qty	UOM													
VM1224A0		0.150	M																		
VM2251A0	STEAM WATER INLET UPPER DISTRIBUTOR	1	PZ																		
VM2252A0	STEAM WATER INLET LOWER DISTRIBUTOR	1	PZ																		
<table border="1"> <thead> <tr> <th>Code</th> <th>Description</th> <th>Qty</th> <th>UOM</th> </tr> </thead> <tbody> <tr> <td>VM1224A0</td> <td></td> <td>0.150</td> <td>M</td> </tr> <tr> <td>VM2251A0</td> <td>STEAM WATER INLET UPPER DISTRIBUTOR</td> <td>1</td> <td>PZ</td> </tr> <tr> <td>VM2252A0</td> <td>STEAM WATER INLET LOWER DISTRIBUTOR</td> <td>1</td> <td>PZ</td> </tr> </tbody> </table>	Code	Description	Qty	UOM	VM1224A0		0.150	M	VM2251A0	STEAM WATER INLET UPPER DISTRIBUTOR	1	PZ	VM2252A0	STEAM WATER INLET LOWER DISTRIBUTOR	1	PZ					
Code	Description	Qty	UOM																		
VM1224A0		0.150	M																		
VM2251A0	STEAM WATER INLET UPPER DISTRIBUTOR	1	PZ																		
VM2252A0	STEAM WATER INLET LOWER DISTRIBUTOR	1	PZ																		
VM2252A	STEAM WATER INLET LOWER DISTRIBUTOR		KVM2251A	STEAM WATER INLET UP+LO DISTRIBUTORS KIT	<table border="1"> <thead> <tr> <th>Code</th> <th>Description</th> <th>Qty</th> <th>UOM</th> </tr> </thead> <tbody> <tr> <td>VM1224A0</td> <td></td> <td>0.150</td> <td>M</td> </tr> <tr> <td>VM2251A0</td> <td>STEAM WATER INLET UPPER DISTRIBUTOR</td> <td>1</td> <td>PZ</td> </tr> <tr> <td>VM2252A0</td> <td>STEAM WATER INLET LOWER DISTRIBUTOR</td> <td>1</td> <td>PZ</td> </tr> </tbody> </table>	Code	Description	Qty	UOM	VM1224A0		0.150	M	VM2251A0	STEAM WATER INLET UPPER DISTRIBUTOR	1	PZ	VM2252A0	STEAM WATER INLET LOWER DISTRIBUTOR	1	PZ
					Code	Description	Qty	UOM													
VM1224A0		0.150	M																		
VM2251A0	STEAM WATER INLET UPPER DISTRIBUTOR	1	PZ																		
VM2252A0	STEAM WATER INLET LOWER DISTRIBUTOR	1	PZ																		
<table border="1"> <thead> <tr> <th>Code</th> <th>Description</th> <th>Qty</th> <th>UOM</th> </tr> </thead> <tbody> <tr> <td>VM1224A0</td> <td></td> <td>0.150</td> <td>M</td> </tr> <tr> <td>VM2251A0</td> <td>STEAM WATER INLET UPPER DISTRIBUTOR</td> <td>1</td> <td>PZ</td> </tr> <tr> <td>VM2252A0</td> <td>STEAM WATER INLET LOWER DISTRIBUTOR</td> <td>1</td> <td>PZ</td> </tr> </tbody> </table>	Code	Description	Qty	UOM	VM1224A0		0.150	M	VM2251A0	STEAM WATER INLET UPPER DISTRIBUTOR	1	PZ	VM2252A0	STEAM WATER INLET LOWER DISTRIBUTOR	1	PZ					
Code	Description	Qty	UOM																		
VM1224A0		0.150	M																		
VM2251A0	STEAM WATER INLET UPPER DISTRIBUTOR	1	PZ																		
VM2252A0	STEAM WATER INLET LOWER DISTRIBUTOR	1	PZ																		
TB2918A	XEVC-2011-E 4 WAYS WATER PIPE ASSEMBLY		TB2918A0	XEVC-2011-E 4 WAYS WATER PIPE ASSEMBLY																	
VM2251A	STEAM WATER INLET UPPER DISTRIBUTOR		KVM2251A	STEAM WATER INLET UP+LO DISTRIBUTORS KIT	<table border="1"> <thead> <tr> <th>Code</th> <th>Description</th> <th>Qty</th> <th>UOM</th> </tr> </thead> <tbody> <tr> <td>VM1224A0</td> <td></td> <td>0.150</td> <td>M</td> </tr> <tr> <td>VM2251A0</td> <td>STEAM WATER INLET UPPER DISTRIBUTOR</td> <td>1</td> <td>PZ</td> </tr> <tr> <td>VM2252A0</td> <td>STEAM WATER INLET LOWER DISTRIBUTOR</td> <td>1</td> <td>PZ</td> </tr> </tbody> </table>	Code	Description	Qty	UOM	VM1224A0		0.150	M	VM2251A0	STEAM WATER INLET UPPER DISTRIBUTOR	1	PZ	VM2252A0	STEAM WATER INLET LOWER DISTRIBUTOR	1	PZ
					Code	Description	Qty	UOM													
VM1224A0		0.150	M																		
VM2251A0	STEAM WATER INLET UPPER DISTRIBUTOR	1	PZ																		
VM2252A0	STEAM WATER INLET LOWER DISTRIBUTOR	1	PZ																		
<table border="1"> <thead> <tr> <th>Code</th> <th>Description</th> <th>Qty</th> <th>UOM</th> </tr> </thead> <tbody> <tr> <td>VM1224A0</td> <td></td> <td>0.150</td> <td>M</td> </tr> <tr> <td>VM2251A0</td> <td>STEAM WATER INLET UPPER DISTRIBUTOR</td> <td>1</td> <td>PZ</td> </tr> <tr> <td>VM2252A0</td> <td>STEAM WATER INLET LOWER DISTRIBUTOR</td> <td>1</td> <td>PZ</td> </tr> </tbody> </table>	Code	Description	Qty	UOM	VM1224A0		0.150	M	VM2251A0	STEAM WATER INLET UPPER DISTRIBUTOR	1	PZ	VM2252A0	STEAM WATER INLET LOWER DISTRIBUTOR	1	PZ					
Code	Description	Qty	UOM																		
VM1224A0		0.150	M																		
VM2251A0	STEAM WATER INLET UPPER DISTRIBUTOR	1	PZ																		
VM2252A0	STEAM WATER INLET LOWER DISTRIBUTOR	1	PZ																		
VM2252A	STEAM WATER INLET LOWER DISTRIBUTOR		KVM2251A	STEAM WATER INLET UP+LO DISTRIBUTORS KIT	<table border="1"> <thead> <tr> <th>Code</th> <th>Description</th> <th>Qty</th> <th>UOM</th> </tr> </thead> <tbody> <tr> <td>VM1224A0</td> <td></td> <td>0.150</td> <td>M</td> </tr> <tr> <td>VM2251A0</td> <td>STEAM WATER INLET UPPER DISTRIBUTOR</td> <td>1</td> <td>PZ</td> </tr> <tr> <td>VM2252A0</td> <td>STEAM WATER INLET LOWER DISTRIBUTOR</td> <td>1</td> <td>PZ</td> </tr> </tbody> </table>	Code	Description	Qty	UOM	VM1224A0		0.150	M	VM2251A0	STEAM WATER INLET UPPER DISTRIBUTOR	1	PZ	VM2252A0	STEAM WATER INLET LOWER DISTRIBUTOR	1	PZ
					Code	Description	Qty	UOM													
VM1224A0		0.150	M																		
VM2251A0	STEAM WATER INLET UPPER DISTRIBUTOR	1	PZ																		
VM2252A0	STEAM WATER INLET LOWER DISTRIBUTOR	1	PZ																		
<table border="1"> <thead> <tr> <th>Code</th> <th>Description</th> <th>Qty</th> <th>UOM</th> </tr> </thead> <tbody> <tr> <td>VM1224A0</td> <td></td> <td>0.150</td> <td>M</td> </tr> <tr> <td>VM2251A0</td> <td>STEAM WATER INLET UPPER DISTRIBUTOR</td> <td>1</td> <td>PZ</td> </tr> <tr> <td>VM2252A0</td> <td>STEAM WATER INLET LOWER DISTRIBUTOR</td> <td>1</td> <td>PZ</td> </tr> </tbody> </table>	Code	Description	Qty	UOM	VM1224A0		0.150	M	VM2251A0	STEAM WATER INLET UPPER DISTRIBUTOR	1	PZ	VM2252A0	STEAM WATER INLET LOWER DISTRIBUTOR	1	PZ					
Code	Description	Qty	UOM																		
VM1224A0		0.150	M																		
VM2251A0	STEAM WATER INLET UPPER DISTRIBUTOR	1	PZ																		
VM2252A0	STEAM WATER INLET LOWER DISTRIBUTOR	1	PZ																		

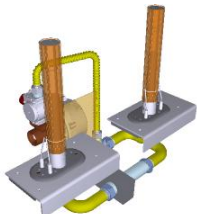



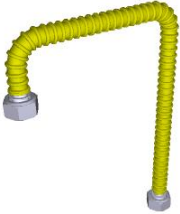

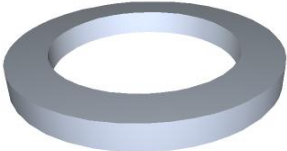

COMPONENT			SPARE PART																		
Code	Description	Image	Code	Description	Components list																
TB2919A	XEVC-2011-E 3 WAYS WATER PIPE ASSEMBLY		KTB2919A	XEVC-2011-E 3 WAY WATER PIPE KIT	<table border="1"> <thead> <tr> <th>Code</th> <th>Description</th> <th>Qty</th> <th>UOM</th> </tr> </thead> <tbody> <tr> <td>TB2919A0</td> <td>XEVC-2011-E 3 WAYS WATER PIPE ASSEMBLY</td> <td>1</td> <td>PZ</td> </tr> </tbody> </table>	Code	Description	Qty	UOM	TB2919A0	XEVC-2011-E 3 WAYS WATER PIPE ASSEMBLY	1	PZ								
Code	Description	Qty	UOM																		
TB2919A0	XEVC-2011-E 3 WAYS WATER PIPE ASSEMBLY	1	PZ																		
VM2251A	STEAM WATER INLET UPPER DISTRIBUTOR		KVM2251A	STEAM WATER INLET UP+LO DISTRIBUTORS KIT	<table border="1"> <thead> <tr> <th>Code</th> <th>Description</th> <th>Qty</th> <th>UOM</th> </tr> </thead> <tbody> <tr> <td>VM1224A0</td> <td></td> <td>0.150</td> <td>M</td> </tr> <tr> <td>VM2251A0</td> <td>STEAM WATER INLET UPPER DISTRIBUTOR</td> <td>1</td> <td>PZ</td> </tr> <tr> <td>VM2252A0</td> <td>STEAM WATER INLET LOWER DISTRIBUTOR</td> <td>1</td> <td>PZ</td> </tr> </tbody> </table>	Code	Description	Qty	UOM	VM1224A0		0.150	M	VM2251A0	STEAM WATER INLET UPPER DISTRIBUTOR	1	PZ	VM2252A0	STEAM WATER INLET LOWER DISTRIBUTOR	1	PZ
Code	Description	Qty	UOM																		
VM1224A0		0.150	M																		
VM2251A0	STEAM WATER INLET UPPER DISTRIBUTOR	1	PZ																		
VM2252A0	STEAM WATER INLET LOWER DISTRIBUTOR	1	PZ																		
VM2252A	STEAM WATER INLET LOWER DISTRIBUTOR		KVM2251A	STEAM WATER INLET UP+LO DISTRIBUTORS KIT	<table border="1"> <thead> <tr> <th>Code</th> <th>Description</th> <th>Qty</th> <th>UOM</th> </tr> </thead> <tbody> <tr> <td>VM1224A0</td> <td></td> <td>0.150</td> <td>M</td> </tr> <tr> <td>VM2251A0</td> <td>STEAM WATER INLET UPPER DISTRIBUTOR</td> <td>1</td> <td>PZ</td> </tr> <tr> <td>VM2252A0</td> <td>STEAM WATER INLET LOWER DISTRIBUTOR</td> <td>1</td> <td>PZ</td> </tr> </tbody> </table>	Code	Description	Qty	UOM	VM1224A0		0.150	M	VM2251A0	STEAM WATER INLET UPPER DISTRIBUTOR	1	PZ	VM2252A0	STEAM WATER INLET LOWER DISTRIBUTOR	1	PZ
Code	Description	Qty	UOM																		
VM1224A0		0.150	M																		
VM2251A0	STEAM WATER INLET UPPER DISTRIBUTOR	1	PZ																		
VM2252A0	STEAM WATER INLET LOWER DISTRIBUTOR	1	PZ																		
TB2920A	XEVC-2011-E 2 WAYS WATER PIPE ASSEMBLY		TB2920A0	XEVC-2011-E 2 WAYS WATER PIPE ASSEMBLY																	
0G1577B	XEVC-2011-E FAN GUARD		0G1577B0	XEVC-2011-E FAN GUARD																	

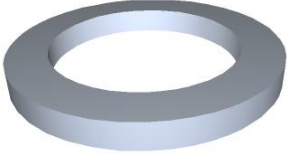

COMPONENT			SPARE PART																																		
Code	Description	Image	Code	Description	Components list																																
VM2332A			KVM2332A	WATER PIPE BUSHING KIT VM2332A0	<table border="1"> <thead> <tr> <th>Code</th> <th>Description</th> <th>Qty</th> <th>UOM</th> </tr> </thead> <tbody> <tr> <td>VM1224A0</td> <td></td> <td>0.200</td> <td>M</td> </tr> <tr> <td>VM2332A0</td> <td>WATER PIPE BUSHING</td> <td>1</td> <td>PZ</td> </tr> <tr> <td>VM2332A0</td> <td>WATER PIPE BUSHING</td> <td>1</td> <td>PZ</td> </tr> <tr> <td>VM2332A1</td> <td></td> <td>1</td> <td>PZ</td> </tr> </tbody> </table>	Code	Description	Qty	UOM	VM1224A0		0.200	M	VM2332A0	WATER PIPE BUSHING	1	PZ	VM2332A0	WATER PIPE BUSHING	1	PZ	VM2332A1		1	PZ												
Code	Description	Qty	UOM																																		
VM1224A0		0.200	M																																		
VM2332A0	WATER PIPE BUSHING	1	PZ																																		
VM2332A0	WATER PIPE BUSHING	1	PZ																																		
VM2332A1		1	PZ																																		
TB2921A	XEVC-2011-E LOWER WATER PIP		TB2921A0	XEVC-2011-E LOWER WATER PIP																																	
VG1024C			VG1024C0																																		
GN1541A	PREMIX BLOWER-SUPPORT GASKET		KG1569A	GAS TORCH SEALINGS KIT	<table border="1"> <thead> <tr> <th>Code</th> <th>Description</th> <th>Qty</th> <th>UOM</th> </tr> </thead> <tbody> <tr> <td>GN1541A0</td> <td>PREMIX BLOWER-SUP PORT GASKET</td> <td>2</td> <td>PZ</td> </tr> <tr> <td>GN1542A0</td> <td>GAS PIPE 1"GAS FITTING ALLUMINIUM WASHER</td> <td>4</td> <td>PZ</td> </tr> <tr> <td>GN1542B0</td> <td>GAS 1" ALUMINIUM WASHER</td> <td>4</td> <td>PZ</td> </tr> <tr> <td>GN1543A0</td> <td>PREMIX START-UP CANDLE GASKET</td> <td>6</td> <td>PZ</td> </tr> <tr> <td>GN1548A0</td> <td>3/4" GAS PIPE ALLUMINIUM WASHER</td> <td>4</td> <td>PZ</td> </tr> <tr> <td>GN1551A2</td> <td>TORCH-CHAM BER SEALING</td> <td>2</td> <td>PZ</td> </tr> <tr> <td>GN1559A0</td> <td>O-RING NBR 2087 21,95X1,7</td> <td>2</td> <td>PZ</td> </tr> </tbody> </table>	Code	Description	Qty	UOM	GN1541A0	PREMIX BLOWER-SUP PORT GASKET	2	PZ	GN1542A0	GAS PIPE 1"GAS FITTING ALLUMINIUM WASHER	4	PZ	GN1542B0	GAS 1" ALUMINIUM WASHER	4	PZ	GN1543A0	PREMIX START-UP CANDLE GASKET	6	PZ	GN1548A0	3/4" GAS PIPE ALLUMINIUM WASHER	4	PZ	GN1551A2	TORCH-CHAM BER SEALING	2	PZ	GN1559A0	O-RING NBR 2087 21,95X1,7	2	PZ
Code	Description	Qty	UOM																																		
GN1541A0	PREMIX BLOWER-SUP PORT GASKET	2	PZ																																		
GN1542A0	GAS PIPE 1"GAS FITTING ALLUMINIUM WASHER	4	PZ																																		
GN1542B0	GAS 1" ALUMINIUM WASHER	4	PZ																																		
GN1543A0	PREMIX START-UP CANDLE GASKET	6	PZ																																		
GN1548A0	3/4" GAS PIPE ALLUMINIUM WASHER	4	PZ																																		
GN1551A2	TORCH-CHAM BER SEALING	2	PZ																																		
GN1559A0	O-RING NBR 2087 21,95X1,7	2	PZ																																		

COMPONENT			SPARE PART																																		
Code	Description	Image	Code	Description	Components list																																
GN1541A	PREMIX BLOWER-SUPPORT GASKET		KG1569A	GAS TORCH SEALINGS KIT	<table border="1"> <thead> <tr> <th>Code</th> <th>Description</th> <th>Qty</th> <th>UOM</th> </tr> </thead> <tbody> <tr> <td>GN1586A2</td> <td>TORCH LOWER SEALING</td> <td>2</td> <td>PZ</td> </tr> <tr> <td>VI1521A0</td> <td>STAINLESS STEEL WASHER D=6 6592</td> <td>6</td> <td>PZ</td> </tr> </tbody> </table>	Code	Description	Qty	UOM	GN1586A2	TORCH LOWER SEALING	2	PZ	VI1521A0	STAINLESS STEEL WASHER D=6 6592	6	PZ																				
Code	Description	Qty	UOM																																		
GN1586A2	TORCH LOWER SEALING	2	PZ																																		
VI1521A0	STAINLESS STEEL WASHER D=6 6592	6	PZ																																		
RC1394A	FLEXIBLE REVOLVING 3/4 GAS F-F FITTING		KRC1394A	3/4 GAS FLEXIBLE CONNECTION KIT	<table border="1"> <thead> <tr> <th>Code</th> <th>Description</th> <th>Qty</th> <th>UOM</th> </tr> </thead> <tbody> <tr> <td>GN1548A0</td> <td>3/4" GAS PIPE ALLUMINIUM WASHER</td> <td>2</td> <td>PZ</td> </tr> <tr> <td>RC1394A0</td> <td>FLEXIBLE REVOLVING 3/4 GAS F-F FITTING</td> <td>1</td> <td>PZ</td> </tr> <tr> <td>VM1794A0</td> <td>250X4.8 PA66 BLACK CLAMP</td> <td>2</td> <td>PZ</td> </tr> <tr> <td>VM2103A0</td> <td>CLAMP LOCK</td> <td>2</td> <td>PZ</td> </tr> </tbody> </table>	Code	Description	Qty	UOM	GN1548A0	3/4" GAS PIPE ALLUMINIUM WASHER	2	PZ	RC1394A0	FLEXIBLE REVOLVING 3/4 GAS F-F FITTING	1	PZ	VM1794A0	250X4.8 PA66 BLACK CLAMP	2	PZ	VM2103A0	CLAMP LOCK	2	PZ												
Code	Description	Qty	UOM																																		
GN1548A0	3/4" GAS PIPE ALLUMINIUM WASHER	2	PZ																																		
RC1394A0	FLEXIBLE REVOLVING 3/4 GAS F-F FITTING	1	PZ																																		
VM1794A0	250X4.8 PA66 BLACK CLAMP	2	PZ																																		
VM2103A0	CLAMP LOCK	2	PZ																																		
ON1415A	BLOWER CONNECTION PLAT		ON1415A0	BLOWER CONNECTION PLAT																																	
GN1548A	3/4" GAS PIPE ALLUMINIUM WASHER		KG1569A	GAS TORCH SEALINGS KIT	<table border="1"> <thead> <tr> <th>Code</th> <th>Description</th> <th>Qty</th> <th>UOM</th> </tr> </thead> <tbody> <tr> <td>GN1541A0</td> <td>PREMIX BLOWER-SUP PORT GASKET</td> <td>2</td> <td>PZ</td> </tr> <tr> <td>GN1542A0</td> <td>GAS PIPE 1"GAS FITTING ALLUMINIUM WASHER</td> <td>4</td> <td>PZ</td> </tr> <tr> <td>GN1542B0</td> <td>GAS 1" ALUMINIUM WASHER</td> <td>4</td> <td>PZ</td> </tr> <tr> <td>GN1543A0</td> <td>PREMIX START-UP CANDLE GASKET</td> <td>6</td> <td>PZ</td> </tr> <tr> <td>GN1548A0</td> <td>3/4" GAS PIPE ALLUMINIUM WASHER</td> <td>4</td> <td>PZ</td> </tr> <tr> <td>GN1551A2</td> <td>TORCH-CHAM BER SEALING</td> <td>2</td> <td>PZ</td> </tr> <tr> <td>GN1559A0</td> <td>O-RING NBR 2087 21,95X1,7</td> <td>2</td> <td>PZ</td> </tr> </tbody> </table>	Code	Description	Qty	UOM	GN1541A0	PREMIX BLOWER-SUP PORT GASKET	2	PZ	GN1542A0	GAS PIPE 1"GAS FITTING ALLUMINIUM WASHER	4	PZ	GN1542B0	GAS 1" ALUMINIUM WASHER	4	PZ	GN1543A0	PREMIX START-UP CANDLE GASKET	6	PZ	GN1548A0	3/4" GAS PIPE ALLUMINIUM WASHER	4	PZ	GN1551A2	TORCH-CHAM BER SEALING	2	PZ	GN1559A0	O-RING NBR 2087 21,95X1,7	2	PZ
Code	Description	Qty	UOM																																		
GN1541A0	PREMIX BLOWER-SUP PORT GASKET	2	PZ																																		
GN1542A0	GAS PIPE 1"GAS FITTING ALLUMINIUM WASHER	4	PZ																																		
GN1542B0	GAS 1" ALUMINIUM WASHER	4	PZ																																		
GN1543A0	PREMIX START-UP CANDLE GASKET	6	PZ																																		
GN1548A0	3/4" GAS PIPE ALLUMINIUM WASHER	4	PZ																																		
GN1551A2	TORCH-CHAM BER SEALING	2	PZ																																		
GN1559A0	O-RING NBR 2087 21,95X1,7	2	PZ																																		

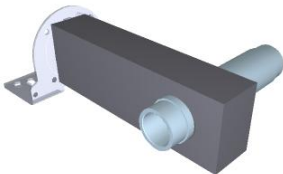





COMPONENT			SPARE PART																																		
Code	Description	Image	Code	Description	Components list																																
GN1548A	3/4" GAS PIPE ALLUMINIUM WASHER		KGN1569A	GAS TORCH SEALINGS KIT	<table border="1"> <thead> <tr> <th>Code</th> <th>Description</th> <th>Qty</th> <th>UOM</th> </tr> </thead> <tbody> <tr> <td>GN1586A2</td> <td>TORCH LOWER SEALING</td> <td>2</td> <td>PZ</td> </tr> <tr> <td>VI1521A0</td> <td>STAINLESS STEEL WASHER D=6 6592</td> <td>6</td> <td>PZ</td> </tr> </tbody> </table>	Code	Description	Qty	UOM	GN1586A2	TORCH LOWER SEALING	2	PZ	VI1521A0	STAINLESS STEEL WASHER D=6 6592	6	PZ																				
Code	Description	Qty	UOM																																		
GN1586A2	TORCH LOWER SEALING	2	PZ																																		
VI1521A0	STAINLESS STEEL WASHER D=6 6592	6	PZ																																		
VM2388A	PREMIX BLOWER PROTECTION		OUTOFPRODUCTIO																																		
VI2021A	M5X0.8 H5 CH 8 BRASS NUT		VI2021A0	M5X0.8 H5 CH 8 BRASS NUT																																	
GN1542A	GAS PIPE 1"GAS FITTING ALLUMINIUM WASHER		KGN1569A	GAS TORCH SEALINGS KIT	<table border="1"> <thead> <tr> <th>Code</th> <th>Description</th> <th>Qty</th> <th>UOM</th> </tr> </thead> <tbody> <tr> <td>GN1541A0</td> <td>PREMIX BLOWER-SUP PORT GASKET</td> <td>2</td> <td>PZ</td> </tr> <tr> <td>GN1542A0</td> <td>GAS PIPE 1"GAS FITTING ALLUMINIUM WASHER</td> <td>4</td> <td>PZ</td> </tr> <tr> <td>GN1542B0</td> <td>GAS 1" ALUMINIUM WASHER</td> <td>4</td> <td>PZ</td> </tr> <tr> <td>GN1543A0</td> <td>PREMIX START-UP CANDLE GASKET</td> <td>6</td> <td>PZ</td> </tr> <tr> <td>GN1548A0</td> <td>3/4" GAS PIPE ALLUMINIUM WASHER</td> <td>4</td> <td>PZ</td> </tr> <tr> <td>GN1551A2</td> <td>TORCH-CHAM BER SEALING</td> <td>2</td> <td>PZ</td> </tr> <tr> <td>GN1559A0</td> <td>O-RING NBR 2087 21,95X1,7</td> <td>2</td> <td>PZ</td> </tr> </tbody> </table>	Code	Description	Qty	UOM	GN1541A0	PREMIX BLOWER-SUP PORT GASKET	2	PZ	GN1542A0	GAS PIPE 1"GAS FITTING ALLUMINIUM WASHER	4	PZ	GN1542B0	GAS 1" ALUMINIUM WASHER	4	PZ	GN1543A0	PREMIX START-UP CANDLE GASKET	6	PZ	GN1548A0	3/4" GAS PIPE ALLUMINIUM WASHER	4	PZ	GN1551A2	TORCH-CHAM BER SEALING	2	PZ	GN1559A0	O-RING NBR 2087 21,95X1,7	2	PZ
Code	Description	Qty	UOM																																		
GN1541A0	PREMIX BLOWER-SUP PORT GASKET	2	PZ																																		
GN1542A0	GAS PIPE 1"GAS FITTING ALLUMINIUM WASHER	4	PZ																																		
GN1542B0	GAS 1" ALUMINIUM WASHER	4	PZ																																		
GN1543A0	PREMIX START-UP CANDLE GASKET	6	PZ																																		
GN1548A0	3/4" GAS PIPE ALLUMINIUM WASHER	4	PZ																																		
GN1551A2	TORCH-CHAM BER SEALING	2	PZ																																		
GN1559A0	O-RING NBR 2087 21,95X1,7	2	PZ																																		



COMPONENT			SPARE PART																														
Code	Description	Image	Code	Description	Components list																												
GN1542A	GAS PIPE 1"GAS FITTING ALLUMINIUM WASHER		KG1569A	GAS TORCH SEALINGS KIT	<table border="1"> <thead> <tr> <th>Code</th> <th>Description</th> <th>Qty</th> <th>UOM</th> </tr> </thead> <tbody> <tr> <td>GN1586A2</td> <td>TORCH LOWER SEALING</td> <td>2</td> <td>PZ</td> </tr> <tr> <td>VI1521A0</td> <td>STAINLESS STEEL WASHER D=6 6592</td> <td>6</td> <td>PZ</td> </tr> </tbody> </table>	Code	Description	Qty	UOM	GN1586A2	TORCH LOWER SEALING	2	PZ	VI1521A0	STAINLESS STEEL WASHER D=6 6592	6	PZ																
Code	Description	Qty	UOM																														
GN1586A2	TORCH LOWER SEALING	2	PZ																														
VI1521A0	STAINLESS STEEL WASHER D=6 6592	6	PZ																														
ON1438B	2011 COMPLETE BLOWER RAMP		KON1438B	2011 GAS BLOWING RAMP KIT	<table border="1"> <thead> <tr> <th>Code</th> <th>Description</th> <th>Qty</th> <th>UOM</th> </tr> </thead> <tbody> <tr> <td>ON1438B0</td> <td>2011 COMPLETE BLOWER RAM</td> <td>1</td> <td>PZ</td> </tr> <tr> <td>GN1541A0</td> <td>PREMIX BLOWER-SUP PORT GASKET</td> <td>1</td> <td>PZ</td> </tr> <tr> <td>GN1542A0</td> <td>GAS PIPE 1"GAS FITTING ALLUMINIUM WASHER</td> <td>2</td> <td>PZ</td> </tr> <tr> <td>GN1542B0</td> <td>GAS 1" ALUMINIUM WASHER</td> <td>2</td> <td>PZ</td> </tr> <tr> <td>VI1310A0</td> <td>ZINC THREAD INSERT M6 FTR/E</td> <td>2</td> <td>PZ</td> </tr> </tbody> </table>	Code	Description	Qty	UOM	ON1438B0	2011 COMPLETE BLOWER RAM	1	PZ	GN1541A0	PREMIX BLOWER-SUP PORT GASKET	1	PZ	GN1542A0	GAS PIPE 1"GAS FITTING ALLUMINIUM WASHER	2	PZ	GN1542B0	GAS 1" ALUMINIUM WASHER	2	PZ	VI1310A0	ZINC THREAD INSERT M6 FTR/E	2	PZ				
Code	Description	Qty	UOM																														
ON1438B0	2011 COMPLETE BLOWER RAM	1	PZ																														
GN1541A0	PREMIX BLOWER-SUP PORT GASKET	1	PZ																														
GN1542A0	GAS PIPE 1"GAS FITTING ALLUMINIUM WASHER	2	PZ																														
GN1542B0	GAS 1" ALUMINIUM WASHER	2	PZ																														
VI1310A0	ZINC THREAD INSERT M6 FTR/E	2	PZ																														
VG1014B	230V 35KW MAX VENTURI-BLOWING GROUP		KVG1014B	230V 35KW MAX VENTURI-PREMIX BLOWER KIT	<table border="1"> <thead> <tr> <th>Code</th> <th>Description</th> <th>Qty</th> <th>UOM</th> </tr> </thead> <tbody> <tr> <td>ON1415A0</td> <td>BLOWER CONNECTION PLATE</td> <td>1</td> <td>PZ</td> </tr> <tr> <td>GN1541A0</td> <td>PREMIX BLOWER-SUP PORT GASKET</td> <td>1</td> <td>PZ</td> </tr> <tr> <td>IP1385A1</td> <td>CORNER POLYSTYRENE PACKING 110X80X2000</td> <td>0.240</td> <td>M</td> </tr> <tr> <td>VG1014B0</td> <td>230V 35KW MAX VENTURI-BLOWING GROUP</td> <td>1</td> <td>PZ</td> </tr> <tr> <td>VI2008A1</td> <td>ST STEEL NOTCHED M5 WASHER</td> <td>4</td> <td>PZ</td> </tr> <tr> <td>VI2021A0</td> <td>M5X0.8 H5 CH 8 BRASS NUT</td> <td>4</td> <td>PZ</td> </tr> </tbody> </table>	Code	Description	Qty	UOM	ON1415A0	BLOWER CONNECTION PLATE	1	PZ	GN1541A0	PREMIX BLOWER-SUP PORT GASKET	1	PZ	IP1385A1	CORNER POLYSTYRENE PACKING 110X80X2000	0.240	M	VG1014B0	230V 35KW MAX VENTURI-BLOWING GROUP	1	PZ	VI2008A1	ST STEEL NOTCHED M5 WASHER	4	PZ	VI2021A0	M5X0.8 H5 CH 8 BRASS NUT	4	PZ
Code	Description	Qty	UOM																														
ON1415A0	BLOWER CONNECTION PLATE	1	PZ																														
GN1541A0	PREMIX BLOWER-SUP PORT GASKET	1	PZ																														
IP1385A1	CORNER POLYSTYRENE PACKING 110X80X2000	0.240	M																														
VG1014B0	230V 35KW MAX VENTURI-BLOWING GROUP	1	PZ																														
VI2008A1	ST STEEL NOTCHED M5 WASHER	4	PZ																														
VI2021A0	M5X0.8 H5 CH 8 BRASS NUT	4	PZ																														

COMPONENT			SPARE PART																																																														
Code	Description	Image	Code	Description	Components list																																																												
VG1034C			KVG1034C	35KW TORCH + IGNITION PLUGS KI	<table border="1"> <thead> <tr> <th>Code</th> <th>Description</th> <th>Qty</th> <th>UOM</th> </tr> </thead> <tbody> <tr> <td>BR1340A2</td> <td>PREMIX START-UP CANDLE</td> <td>3</td> <td>PZ</td> </tr> <tr> <td>BR1348C0</td> <td></td> <td>1</td> <td>PZ</td> </tr> <tr> <td>BR1362A0</td> <td>TORCH SILENCER GAP H 62+H52</td> <td>1</td> <td>PZ</td> </tr> <tr> <td>GN1542A0</td> <td>GAS PIPE 1"GAS FITTING ALLUMINIUM WASHER</td> <td>1</td> <td>PZ</td> </tr> <tr> <td>GN1542B0</td> <td>GAS 1" ALUMINIUM WASHER</td> <td>1</td> <td>PZ</td> </tr> <tr> <td>GN1543A0</td> <td>PREMIX START-UP CANDLE GASKET</td> <td>3</td> <td>PZ</td> </tr> <tr> <td>GN1551A2</td> <td>TORCH-CHAM BER SEALING</td> <td>1</td> <td>PZ</td> </tr> <tr> <td>GN1580B0</td> <td>M8 TIE ROD GASKET</td> <td>2</td> <td>PZ</td> </tr> <tr> <td>IP1385A1</td> <td>CORNER POLYSTYREN E PACKING 110X80X2000</td> <td>0.270</td> <td>M</td> </tr> <tr> <td>RC1385B0</td> <td>FLEXIBLE REVOLVING 1 GAS F-F FITTING</td> <td>1</td> <td>PZ</td> </tr> <tr> <td>VI0504A1</td> <td>M4 SERRATED WASHER</td> <td>6</td> <td>PZ</td> </tr> <tr> <td>VI2009A2</td> <td>GAS PIPE SCREW BRASS WASHER</td> <td>3</td> <td>PZ</td> </tr> <tr> <td>VI2018A0</td> <td>NUT M6</td> <td>8</td> <td>PZ</td> </tr> <tr> <td>VI2020A0</td> <td>M4X1 H4 CH 7 BRASS NUT</td> <td>6</td> <td>PZ</td> </tr> </tbody> </table>	Code	Description	Qty	UOM	BR1340A2	PREMIX START-UP CANDLE	3	PZ	BR1348C0		1	PZ	BR1362A0	TORCH SILENCER GAP H 62+H52	1	PZ	GN1542A0	GAS PIPE 1"GAS FITTING ALLUMINIUM WASHER	1	PZ	GN1542B0	GAS 1" ALUMINIUM WASHER	1	PZ	GN1543A0	PREMIX START-UP CANDLE GASKET	3	PZ	GN1551A2	TORCH-CHAM BER SEALING	1	PZ	GN1580B0	M8 TIE ROD GASKET	2	PZ	IP1385A1	CORNER POLYSTYREN E PACKING 110X80X2000	0.270	M	RC1385B0	FLEXIBLE REVOLVING 1 GAS F-F FITTING	1	PZ	VI0504A1	M4 SERRATED WASHER	6	PZ	VI2009A2	GAS PIPE SCREW BRASS WASHER	3	PZ	VI2018A0	NUT M6	8	PZ	VI2020A0	M4X1 H4 CH 7 BRASS NUT	6	PZ
Code	Description	Qty	UOM																																																														
BR1340A2	PREMIX START-UP CANDLE	3	PZ																																																														
BR1348C0		1	PZ																																																														
BR1362A0	TORCH SILENCER GAP H 62+H52	1	PZ																																																														
GN1542A0	GAS PIPE 1"GAS FITTING ALLUMINIUM WASHER	1	PZ																																																														
GN1542B0	GAS 1" ALUMINIUM WASHER	1	PZ																																																														
GN1543A0	PREMIX START-UP CANDLE GASKET	3	PZ																																																														
GN1551A2	TORCH-CHAM BER SEALING	1	PZ																																																														
GN1580B0	M8 TIE ROD GASKET	2	PZ																																																														
IP1385A1	CORNER POLYSTYREN E PACKING 110X80X2000	0.270	M																																																														
RC1385B0	FLEXIBLE REVOLVING 1 GAS F-F FITTING	1	PZ																																																														
VI0504A1	M4 SERRATED WASHER	6	PZ																																																														
VI2009A2	GAS PIPE SCREW BRASS WASHER	3	PZ																																																														
VI2018A0	NUT M6	8	PZ																																																														
VI2020A0	M4X1 H4 CH 7 BRASS NUT	6	PZ																																																														
GN1542A	GAS PIPE 1"GAS FITTING ALLUMINIUM WASHER		KG1569A	GAS TORCH SEALINGS KIT	<table border="1"> <thead> <tr> <th>Code</th> <th>Description</th> <th>Qty</th> <th>UOM</th> </tr> </thead> <tbody> <tr> <td>GN1541A0</td> <td>PREMIX BLOWER-SUP PORT GASKET</td> <td>2</td> <td>PZ</td> </tr> <tr> <td>GN1542A0</td> <td>GAS PIPE 1"GAS FITTING ALLUMINIUM WASHER</td> <td>4</td> <td>PZ</td> </tr> <tr> <td>GN1542B0</td> <td>GAS 1" ALUMINIUM WASHER</td> <td>4</td> <td>PZ</td> </tr> </tbody> </table>	Code	Description	Qty	UOM	GN1541A0	PREMIX BLOWER-SUP PORT GASKET	2	PZ	GN1542A0	GAS PIPE 1"GAS FITTING ALLUMINIUM WASHER	4	PZ	GN1542B0	GAS 1" ALUMINIUM WASHER	4	PZ																																												
Code	Description	Qty	UOM																																																														
GN1541A0	PREMIX BLOWER-SUP PORT GASKET	2	PZ																																																														
GN1542A0	GAS PIPE 1"GAS FITTING ALLUMINIUM WASHER	4	PZ																																																														
GN1542B0	GAS 1" ALUMINIUM WASHER	4	PZ																																																														

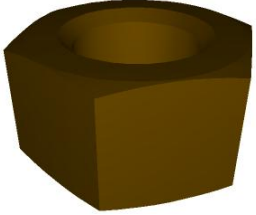

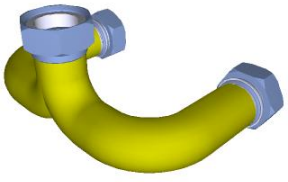

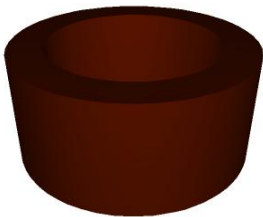
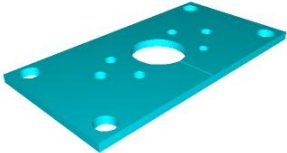

COMPONENT			SPARE PART																																										
Code	Description	Image	Code	Description	Components list																																								
GN1542A	GAS PIPE 1"GAS FITTING ALLUMINIUM WASHER		KGN1569A	GAS TORCH SEALINGS KIT	<table border="1"> <thead> <tr> <th>Code</th> <th>Description</th> <th>Qty</th> <th>UOM</th> </tr> </thead> <tbody> <tr> <td>GN1543A0</td> <td>PREMIX START-UP CANDLE GASKET</td> <td>6</td> <td>PZ</td> </tr> <tr> <td>GN1548A0</td> <td>3/4" GAS PIPE ALLUMINIUM WASHER</td> <td>4</td> <td>PZ</td> </tr> <tr> <td>GN1551A2</td> <td>TORCH-CHAM BER SEALING</td> <td>2</td> <td>PZ</td> </tr> <tr> <td>GN1559A0</td> <td>O-RING NBR 2087 21,95X1,7</td> <td>2</td> <td>PZ</td> </tr> <tr> <td>GN1586A2</td> <td>TORCH LOWER SEALING</td> <td>2</td> <td>PZ</td> </tr> <tr> <td>VI1521A0</td> <td>STAINLESS STEEL WASHER D=6 6592</td> <td>6</td> <td>PZ</td> </tr> </tbody> </table>	Code	Description	Qty	UOM	GN1543A0	PREMIX START-UP CANDLE GASKET	6	PZ	GN1548A0	3/4" GAS PIPE ALLUMINIUM WASHER	4	PZ	GN1551A2	TORCH-CHAM BER SEALING	2	PZ	GN1559A0	O-RING NBR 2087 21,95X1,7	2	PZ	GN1586A2	TORCH LOWER SEALING	2	PZ	VI1521A0	STAINLESS STEEL WASHER D=6 6592	6	PZ												
Code	Description	Qty	UOM																																										
GN1543A0	PREMIX START-UP CANDLE GASKET	6	PZ																																										
GN1548A0	3/4" GAS PIPE ALLUMINIUM WASHER	4	PZ																																										
GN1551A2	TORCH-CHAM BER SEALING	2	PZ																																										
GN1559A0	O-RING NBR 2087 21,95X1,7	2	PZ																																										
GN1586A2	TORCH LOWER SEALING	2	PZ																																										
VI1521A0	STAINLESS STEEL WASHER D=6 6592	6	PZ																																										
GN1543A	PREMIX START-UP CANDLE GASKET		KGN1569A	GAS TORCH SEALINGS KIT	<table border="1"> <thead> <tr> <th>Code</th> <th>Description</th> <th>Qty</th> <th>UOM</th> </tr> </thead> <tbody> <tr> <td>GN1541A0</td> <td>PREMIX BLOWER-SUP PORT GASKET</td> <td>2</td> <td>PZ</td> </tr> <tr> <td>GN1542A0</td> <td>GAS PIPE 1"GAS FITTING ALLUMINIUM WASHER</td> <td>4</td> <td>PZ</td> </tr> <tr> <td>GN1542B0</td> <td>GAS 1" ALUMINIUM WASHER</td> <td>4</td> <td>PZ</td> </tr> <tr> <td>GN1543A0</td> <td>PREMIX START-UP CANDLE GASKET</td> <td>6</td> <td>PZ</td> </tr> <tr> <td>GN1548A0</td> <td>3/4" GAS PIPE ALLUMINIUM WASHER</td> <td>4</td> <td>PZ</td> </tr> <tr> <td>GN1551A2</td> <td>TORCH-CHAM BER SEALING</td> <td>2</td> <td>PZ</td> </tr> <tr> <td>GN1559A0</td> <td>O-RING NBR 2087 21,95X1,7</td> <td>2</td> <td>PZ</td> </tr> <tr> <td>GN1586A2</td> <td>TORCH LOWER SEALING</td> <td>2</td> <td>PZ</td> </tr> <tr> <td>VI1521A0</td> <td>STAINLESS STEEL WASHER D=6 6592</td> <td>6</td> <td>PZ</td> </tr> </tbody> </table>	Code	Description	Qty	UOM	GN1541A0	PREMIX BLOWER-SUP PORT GASKET	2	PZ	GN1542A0	GAS PIPE 1"GAS FITTING ALLUMINIUM WASHER	4	PZ	GN1542B0	GAS 1" ALUMINIUM WASHER	4	PZ	GN1543A0	PREMIX START-UP CANDLE GASKET	6	PZ	GN1548A0	3/4" GAS PIPE ALLUMINIUM WASHER	4	PZ	GN1551A2	TORCH-CHAM BER SEALING	2	PZ	GN1559A0	O-RING NBR 2087 21,95X1,7	2	PZ	GN1586A2	TORCH LOWER SEALING	2	PZ	VI1521A0	STAINLESS STEEL WASHER D=6 6592	6	PZ
Code	Description	Qty	UOM																																										
GN1541A0	PREMIX BLOWER-SUP PORT GASKET	2	PZ																																										
GN1542A0	GAS PIPE 1"GAS FITTING ALLUMINIUM WASHER	4	PZ																																										
GN1542B0	GAS 1" ALUMINIUM WASHER	4	PZ																																										
GN1543A0	PREMIX START-UP CANDLE GASKET	6	PZ																																										
GN1548A0	3/4" GAS PIPE ALLUMINIUM WASHER	4	PZ																																										
GN1551A2	TORCH-CHAM BER SEALING	2	PZ																																										
GN1559A0	O-RING NBR 2087 21,95X1,7	2	PZ																																										
GN1586A2	TORCH LOWER SEALING	2	PZ																																										
VI1521A0	STAINLESS STEEL WASHER D=6 6592	6	PZ																																										

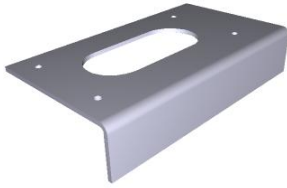
COMPONENT			SPARE PART																																														
Code	Description	Image	Code	Description	Components list																																												
VI2020A	M4X1 H4 CH 7 BRASS NUT		VI2020A0	M4X1 H4 CH 7 BRASS NUT																																													
BR1340A	PREMIX START-UP CANDLE		KBR1340A	PREMIX BURNER START UP PLUG 6 PCS KIT	<table border="1"> <thead> <tr> <th>Code</th> <th>Description</th> <th>Qty</th> <th>UOM</th> </tr> </thead> <tbody> <tr> <td>BR1340A2</td> <td>PREMIX START-UP CANDLE</td> <td>6</td> <td>PZ</td> </tr> <tr> <td>GN1542A0</td> <td>GAS PIPE 1"GAS FITTING ALLUMINIUM WASHER</td> <td>4</td> <td>PZ</td> </tr> <tr> <td>GN1542B0</td> <td>GAS 1" ALUMINIUM WASHER</td> <td>4</td> <td>PZ</td> </tr> <tr> <td>GN1543A0</td> <td>PREMIX START-UP CANDLE GASKET</td> <td>6</td> <td>PZ</td> </tr> <tr> <td>GN1551A2</td> <td>TORCH-CHAM BER SEALING</td> <td>2</td> <td>PZ</td> </tr> <tr> <td>GN1580A1</td> <td>GAS PIPE SCREW COPPER WASHER</td> <td>6</td> <td>PZ</td> </tr> <tr> <td>GN1580B0</td> <td>M8 TIE ROD GASKET</td> <td>4</td> <td>PZ</td> </tr> <tr> <td>GN1586A2</td> <td>TORCH LOWER SEALING</td> <td>2</td> <td>PZ</td> </tr> <tr> <td>VI0504A1</td> <td>M4 SERRATED WASHER</td> <td>12</td> <td>PZ</td> </tr> <tr> <td>VI2020A0</td> <td>M4X1 H4 CH 7 BRASS NUT</td> <td>12</td> <td>PZ</td> </tr> </tbody> </table>	Code	Description	Qty	UOM	BR1340A2	PREMIX START-UP CANDLE	6	PZ	GN1542A0	GAS PIPE 1"GAS FITTING ALLUMINIUM WASHER	4	PZ	GN1542B0	GAS 1" ALUMINIUM WASHER	4	PZ	GN1543A0	PREMIX START-UP CANDLE GASKET	6	PZ	GN1551A2	TORCH-CHAM BER SEALING	2	PZ	GN1580A1	GAS PIPE SCREW COPPER WASHER	6	PZ	GN1580B0	M8 TIE ROD GASKET	4	PZ	GN1586A2	TORCH LOWER SEALING	2	PZ	VI0504A1	M4 SERRATED WASHER	12	PZ	VI2020A0	M4X1 H4 CH 7 BRASS NUT	12	PZ
Code	Description	Qty	UOM																																														
BR1340A2	PREMIX START-UP CANDLE	6	PZ																																														
GN1542A0	GAS PIPE 1"GAS FITTING ALLUMINIUM WASHER	4	PZ																																														
GN1542B0	GAS 1" ALUMINIUM WASHER	4	PZ																																														
GN1543A0	PREMIX START-UP CANDLE GASKET	6	PZ																																														
GN1551A2	TORCH-CHAM BER SEALING	2	PZ																																														
GN1580A1	GAS PIPE SCREW COPPER WASHER	6	PZ																																														
GN1580B0	M8 TIE ROD GASKET	4	PZ																																														
GN1586A2	TORCH LOWER SEALING	2	PZ																																														
VI0504A1	M4 SERRATED WASHER	12	PZ																																														
VI2020A0	M4X1 H4 CH 7 BRASS NUT	12	PZ																																														
RC1385B	FLEXIBLE REVOLVING 1 GAS F-F FITTING		KRC1385B	FLEXIBLE REVOLVING GAS CONNECTION KIT	<table border="1"> <thead> <tr> <th>Code</th> <th>Description</th> <th>Qty</th> <th>UOM</th> </tr> </thead> <tbody> <tr> <td>GN1542A0</td> <td>GAS PIPE 1"GAS FITTING ALLUMINIUM WASHER</td> <td>1</td> <td>PZ</td> </tr> <tr> <td>GN1542B0</td> <td>GAS 1" ALUMINIUM WASHER</td> <td>1</td> <td>PZ</td> </tr> <tr> <td>RC1385B0</td> <td>FLEXIBLE REVOLVING 1 GAS F-F FITTING</td> <td>1</td> <td>PZ</td> </tr> <tr> <td>VM1224A0</td> <td></td> <td>0.250</td> <td>M</td> </tr> </tbody> </table>	Code	Description	Qty	UOM	GN1542A0	GAS PIPE 1"GAS FITTING ALLUMINIUM WASHER	1	PZ	GN1542B0	GAS 1" ALUMINIUM WASHER	1	PZ	RC1385B0	FLEXIBLE REVOLVING 1 GAS F-F FITTING	1	PZ	VM1224A0		0.250	M																								
Code	Description	Qty	UOM																																														
GN1542A0	GAS PIPE 1"GAS FITTING ALLUMINIUM WASHER	1	PZ																																														
GN1542B0	GAS 1" ALUMINIUM WASHER	1	PZ																																														
RC1385B0	FLEXIBLE REVOLVING 1 GAS F-F FITTING	1	PZ																																														
VM1224A0		0.250	M																																														



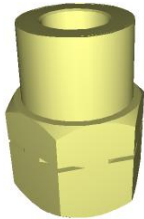

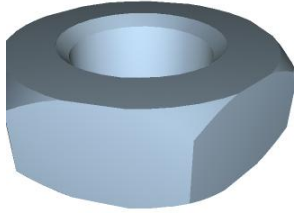
COMPONENT			SPARE PART																																										
Code	Description	Image	Code	Description	Components list																																								
GN1580B	M8 TIE ROD GASKE		GN1580B0	M8 TIE ROD GASKE																																									
GN1586B	BAFFLE CHIMNEY		KGN1569A	GAS TORCH SEALINGS KIT	<table border="1"> <thead> <tr> <th>Code</th> <th>Description</th> <th>Qty</th> <th>UOM</th> </tr> </thead> <tbody> <tr> <td>GN1541A0</td> <td>PREMIX BLOWER-SUP PORT GASKET</td> <td>2</td> <td>PZ</td> </tr> <tr> <td>GN1542A0</td> <td>GAS PIPE 1"GAS FITTING ALLUMINIUM WASHER</td> <td>4</td> <td>PZ</td> </tr> <tr> <td>GN1542B0</td> <td>GAS 1" ALUMINIUM WASHER</td> <td>4</td> <td>PZ</td> </tr> <tr> <td>GN1543A0</td> <td>PREMIX START-UP CANDLE GASKET</td> <td>6</td> <td>PZ</td> </tr> <tr> <td>GN1548A0</td> <td>3/4" GAS PIPE ALLUMINIUM WASHER</td> <td>4</td> <td>PZ</td> </tr> <tr> <td>GN1551A2</td> <td>TORCH-CHAM BER SEALING</td> <td>2</td> <td>PZ</td> </tr> <tr> <td>GN1559A0</td> <td>O-RING NBR 2087 21.95X1.7</td> <td>2</td> <td>PZ</td> </tr> <tr> <td>GN1586A2</td> <td>TORCH LOWER SEALING</td> <td>2</td> <td>PZ</td> </tr> <tr> <td>VI1521A0</td> <td>STAINLESS STEEL WASHER D=6 6592</td> <td>6</td> <td>PZ</td> </tr> </tbody> </table>	Code	Description	Qty	UOM	GN1541A0	PREMIX BLOWER-SUP PORT GASKET	2	PZ	GN1542A0	GAS PIPE 1"GAS FITTING ALLUMINIUM WASHER	4	PZ	GN1542B0	GAS 1" ALUMINIUM WASHER	4	PZ	GN1543A0	PREMIX START-UP CANDLE GASKET	6	PZ	GN1548A0	3/4" GAS PIPE ALLUMINIUM WASHER	4	PZ	GN1551A2	TORCH-CHAM BER SEALING	2	PZ	GN1559A0	O-RING NBR 2087 21.95X1.7	2	PZ	GN1586A2	TORCH LOWER SEALING	2	PZ	VI1521A0	STAINLESS STEEL WASHER D=6 6592	6	PZ
Code	Description	Qty	UOM																																										
GN1541A0	PREMIX BLOWER-SUP PORT GASKET	2	PZ																																										
GN1542A0	GAS PIPE 1"GAS FITTING ALLUMINIUM WASHER	4	PZ																																										
GN1542B0	GAS 1" ALUMINIUM WASHER	4	PZ																																										
GN1543A0	PREMIX START-UP CANDLE GASKET	6	PZ																																										
GN1548A0	3/4" GAS PIPE ALLUMINIUM WASHER	4	PZ																																										
GN1551A2	TORCH-CHAM BER SEALING	2	PZ																																										
GN1559A0	O-RING NBR 2087 21.95X1.7	2	PZ																																										
GN1586A2	TORCH LOWER SEALING	2	PZ																																										
VI1521A0	STAINLESS STEEL WASHER D=6 6592	6	PZ																																										
BR1348C			KVG1034C	35KW TORCH + IGNITION PLUGS KI	<table border="1"> <thead> <tr> <th>Code</th> <th>Description</th> <th>Qty</th> <th>UOM</th> </tr> </thead> <tbody> <tr> <td>BR1340A2</td> <td>PREMIX START-UP CANDLE</td> <td>3</td> <td>PZ</td> </tr> <tr> <td>BR1348C0</td> <td></td> <td>1</td> <td>PZ</td> </tr> <tr> <td>BR1362A0</td> <td>TORCH SILENCER GAP H 62+H52</td> <td>1</td> <td>PZ</td> </tr> <tr> <td>GN1542A0</td> <td>GAS PIPE 1"GAS FITTING ALLUMINIUM WASHER</td> <td>1</td> <td>PZ</td> </tr> </tbody> </table>	Code	Description	Qty	UOM	BR1340A2	PREMIX START-UP CANDLE	3	PZ	BR1348C0		1	PZ	BR1362A0	TORCH SILENCER GAP H 62+H52	1	PZ	GN1542A0	GAS PIPE 1"GAS FITTING ALLUMINIUM WASHER	1	PZ																				
Code	Description	Qty	UOM																																										
BR1340A2	PREMIX START-UP CANDLE	3	PZ																																										
BR1348C0		1	PZ																																										
BR1362A0	TORCH SILENCER GAP H 62+H52	1	PZ																																										
GN1542A0	GAS PIPE 1"GAS FITTING ALLUMINIUM WASHER	1	PZ																																										

COMPONENT			SPARE PART																																														
Code	Description	Image	Code	Description	Components list																																												
BR1348C			KVG1034C	35KW TORCH + IGNITION PLUGS KI	<table border="1"> <thead> <tr> <th>Code</th> <th>Description</th> <th>Qty</th> <th>UOM</th> </tr> </thead> <tbody> <tr> <td>GN1542B0</td> <td>GAS 1" ALUMINIUM WASHER</td> <td>1</td> <td>PZ</td> </tr> <tr> <td>GN1543A0</td> <td>PREMIX START-UP CANDLE GASKET</td> <td>3</td> <td>PZ</td> </tr> <tr> <td>GN1551A2</td> <td>TORCH-CHAM BER SEALING</td> <td>1</td> <td>PZ</td> </tr> <tr> <td>GN1580B0</td> <td>M8 TIE ROD GASKET</td> <td>2</td> <td>PZ</td> </tr> <tr> <td>IP1385A1</td> <td>CORNER POLYSTYREN E PACKING 110X80X2000</td> <td>0.270</td> <td>M</td> </tr> <tr> <td>RC1385B0</td> <td>FLEXIBLE REVOLVING 1 GAS F-F FITTING</td> <td>1</td> <td>PZ</td> </tr> <tr> <td>VI0504A1</td> <td>M4 SERRATED WASHER</td> <td>6</td> <td>PZ</td> </tr> <tr> <td>VI2009A2</td> <td>GAS PIPE SCREW BRASS WASHER</td> <td>3</td> <td>PZ</td> </tr> <tr> <td>VI2018A0</td> <td>NUT M6</td> <td>8</td> <td>PZ</td> </tr> <tr> <td>VI2020A0</td> <td>M4X1 H4 CH 7 BRASS NUT</td> <td>6</td> <td>PZ</td> </tr> </tbody> </table>	Code	Description	Qty	UOM	GN1542B0	GAS 1" ALUMINIUM WASHER	1	PZ	GN1543A0	PREMIX START-UP CANDLE GASKET	3	PZ	GN1551A2	TORCH-CHAM BER SEALING	1	PZ	GN1580B0	M8 TIE ROD GASKET	2	PZ	IP1385A1	CORNER POLYSTYREN E PACKING 110X80X2000	0.270	M	RC1385B0	FLEXIBLE REVOLVING 1 GAS F-F FITTING	1	PZ	VI0504A1	M4 SERRATED WASHER	6	PZ	VI2009A2	GAS PIPE SCREW BRASS WASHER	3	PZ	VI2018A0	NUT M6	8	PZ	VI2020A0	M4X1 H4 CH 7 BRASS NUT	6	PZ
Code	Description	Qty	UOM																																														
GN1542B0	GAS 1" ALUMINIUM WASHER	1	PZ																																														
GN1543A0	PREMIX START-UP CANDLE GASKET	3	PZ																																														
GN1551A2	TORCH-CHAM BER SEALING	1	PZ																																														
GN1580B0	M8 TIE ROD GASKET	2	PZ																																														
IP1385A1	CORNER POLYSTYREN E PACKING 110X80X2000	0.270	M																																														
RC1385B0	FLEXIBLE REVOLVING 1 GAS F-F FITTING	1	PZ																																														
VI0504A1	M4 SERRATED WASHER	6	PZ																																														
VI2009A2	GAS PIPE SCREW BRASS WASHER	3	PZ																																														
VI2018A0	NUT M6	8	PZ																																														
VI2020A0	M4X1 H4 CH 7 BRASS NUT	6	PZ																																														
GN1551A	TORCH-CHAMBER SEALING		KG1569A	GAS TORCH SEALINGS KIT	<table border="1"> <thead> <tr> <th>Code</th> <th>Description</th> <th>Qty</th> <th>UOM</th> </tr> </thead> <tbody> <tr> <td>GN1541A0</td> <td>PREMIX BLOWER-SUP PORT GASKET</td> <td>2</td> <td>PZ</td> </tr> <tr> <td>GN1542A0</td> <td>GAS PIPE 1"GAS FITTING ALLUMINIUM WASHER</td> <td>4</td> <td>PZ</td> </tr> <tr> <td>GN1542B0</td> <td>GAS 1" ALUMINIUM WASHER</td> <td>4</td> <td>PZ</td> </tr> <tr> <td>GN1543A0</td> <td>PREMIX START-UP CANDLE GASKET</td> <td>6</td> <td>PZ</td> </tr> <tr> <td>GN1548A0</td> <td>3/4" GAS PIPE ALLUMINIUM WASHER</td> <td>4</td> <td>PZ</td> </tr> <tr> <td>GN1551A2</td> <td>TORCH-CHAM BER SEALING</td> <td>2</td> <td>PZ</td> </tr> <tr> <td>GN1559A0</td> <td>O-RING NBR 2087 21.95X1.7</td> <td>2</td> <td>PZ</td> </tr> <tr> <td>GN1586A2</td> <td>TORCH LOWER SEALING</td> <td>2</td> <td>PZ</td> </tr> <tr> <td>VI1521A0</td> <td>STAINLESS STEEL WASHER D=6 6592</td> <td>6</td> <td>PZ</td> </tr> </tbody> </table>	Code	Description	Qty	UOM	GN1541A0	PREMIX BLOWER-SUP PORT GASKET	2	PZ	GN1542A0	GAS PIPE 1"GAS FITTING ALLUMINIUM WASHER	4	PZ	GN1542B0	GAS 1" ALUMINIUM WASHER	4	PZ	GN1543A0	PREMIX START-UP CANDLE GASKET	6	PZ	GN1548A0	3/4" GAS PIPE ALLUMINIUM WASHER	4	PZ	GN1551A2	TORCH-CHAM BER SEALING	2	PZ	GN1559A0	O-RING NBR 2087 21.95X1.7	2	PZ	GN1586A2	TORCH LOWER SEALING	2	PZ	VI1521A0	STAINLESS STEEL WASHER D=6 6592	6	PZ				
Code	Description	Qty	UOM																																														
GN1541A0	PREMIX BLOWER-SUP PORT GASKET	2	PZ																																														
GN1542A0	GAS PIPE 1"GAS FITTING ALLUMINIUM WASHER	4	PZ																																														
GN1542B0	GAS 1" ALUMINIUM WASHER	4	PZ																																														
GN1543A0	PREMIX START-UP CANDLE GASKET	6	PZ																																														
GN1548A0	3/4" GAS PIPE ALLUMINIUM WASHER	4	PZ																																														
GN1551A2	TORCH-CHAM BER SEALING	2	PZ																																														
GN1559A0	O-RING NBR 2087 21.95X1.7	2	PZ																																														
GN1586A2	TORCH LOWER SEALING	2	PZ																																														
VI1521A0	STAINLESS STEEL WASHER D=6 6592	6	PZ																																														





COMPONENT			SPARE PART														
Code	Description	Image	Code	Description	Components list												
RC1045A			RC1045A1	3/4 FEMALE-3/4 STRAIGHT GAS FITTING													
0H8035A	MM CORE PROBE ACCESS COVER		0H8035A0	MM CORE PROBE ACCESS COVER													
GN1632A	CORE PROBE INLET HOLDING GASKET		GN1632A0	CORE PROBE INLET HOLDING GASKET													
RC1170A	STAINLESS STEEL NUT M14 H=8 CH=22		KRC1170A	M14 H8 CH22 NUT - 10 PCS. KIT	<table border="1"> <thead> <tr> <th>Code</th> <th>Description</th> <th>Qty</th> <th>UOM</th> </tr> </thead> <tbody> <tr> <td>RC1170A1</td> <td>STAINLESS STEEL NUT M14 H=8 CH=22</td> <td>10</td> <td>PZ</td> </tr> <tr> <td>VM1224A0</td> <td></td> <td>0.200</td> <td>M</td> </tr> </tbody> </table>	Code	Description	Qty	UOM	RC1170A1	STAINLESS STEEL NUT M14 H=8 CH=22	10	PZ	VM1224A0		0.200	M
Code	Description	Qty	UOM														
RC1170A1	STAINLESS STEEL NUT M14 H=8 CH=22	10	PZ														
VM1224A0		0.200	M														
TB2909B	XEVC EXTERNAL WATER PIPE D10 +CONNECTION		KTB2909B	Ø10 EXT WATER PIPE KIT XEVC GAS PLUS	<table border="1"> <thead> <tr> <th>Code</th> <th>Description</th> <th>Qty</th> <th>UOM</th> </tr> </thead> <tbody> <tr> <td>TB2909B0</td> <td>XEVC EXTERNAL WATER PIPE D10 +CONNECTIO</td> <td>1</td> <td>PZ</td> </tr> </tbody> </table>	Code	Description	Qty	UOM	TB2909B0	XEVC EXTERNAL WATER PIPE D10 +CONNECTIO	1	PZ				
Code	Description	Qty	UOM														
TB2909B0	XEVC EXTERNAL WATER PIPE D10 +CONNECTIO	1	PZ														



COMPONENT			SPARE PART																										
Code	Description	Image	Code	Description	Components list																								
VL1127A	6MM BARBED T-SHAPED FITTING		KVL1127A	6MM BARBED T-SHAPED FITTING 10 PCS KIT	<table border="1"> <thead> <tr> <th>Code</th> <th>Description</th> <th>Qty</th> <th>UOM</th> </tr> </thead> <tbody> <tr> <td>VL1127A1</td> <td>6MM BARBED T-SHAPED FITTING</td> <td>10</td> <td>PZ</td> </tr> <tr> <td>VM1224A0</td> <td></td> <td>0.200</td> <td>M</td> </tr> </tbody> </table>	Code	Description	Qty	UOM	VL1127A1	6MM BARBED T-SHAPED FITTING	10	PZ	VM1224A0		0.200	M												
Code	Description	Qty	UOM																										
VL1127A1	6MM BARBED T-SHAPED FITTING	10	PZ																										
VM1224A0		0.200	M																										
TB3271A	TB3132A-WASHING BIG ONE INLET PIPE		TB3271A0	TB3132A-WASHING BIG ONE INLET PIPE																									
TB3253A	TB3131A-T SHAPED EXT HUM PIPE CONNECTION		TB3253A0	TB3131A-T SHAPED EXT HUM PIPE CONNECTION																									
OG1453A	SPACER PLATE CARTER AIR CT GA		OG1453A1	SPACER PLATE CARTER AIR CT GA																									
SN1012B			KSN1021B	US MULTI.POINT L2750 CORE PROBE KIT	<table border="1"> <thead> <tr> <th>Code</th> <th>Description</th> <th>Qty</th> <th>UOM</th> </tr> </thead> <tbody> <tr> <td>0H8035A0</td> <td>MM CORE PROBE ACCESS COVE</td> <td>1</td> <td>PZ</td> </tr> <tr> <td>CE1037A0</td> <td>UL SILICON GLASS FIBER SHEATH</td> <td>1.500</td> <td>M</td> </tr> <tr> <td>CE1685A0</td> <td>MRT8 P3,81 5 POLES FEMALE TERMINAL</td> <td>1</td> <td>PZ</td> </tr> <tr> <td>GN1632A0</td> <td>CORE PROBE INLET HOLDING GASKET</td> <td>1</td> <td>PZ</td> </tr> <tr> <td>RC1130A0</td> <td>130X2,6 CLAM</td> <td>2</td> <td>PZ</td> </tr> </tbody> </table>	Code	Description	Qty	UOM	0H8035A0	MM CORE PROBE ACCESS COVE	1	PZ	CE1037A0	UL SILICON GLASS FIBER SHEATH	1.500	M	CE1685A0	MRT8 P3,81 5 POLES FEMALE TERMINAL	1	PZ	GN1632A0	CORE PROBE INLET HOLDING GASKET	1	PZ	RC1130A0	130X2,6 CLAM	2	PZ
Code	Description	Qty	UOM																										
0H8035A0	MM CORE PROBE ACCESS COVE	1	PZ																										
CE1037A0	UL SILICON GLASS FIBER SHEATH	1.500	M																										
CE1685A0	MRT8 P3,81 5 POLES FEMALE TERMINAL	1	PZ																										
GN1632A0	CORE PROBE INLET HOLDING GASKET	1	PZ																										
RC1130A0	130X2,6 CLAM	2	PZ																										

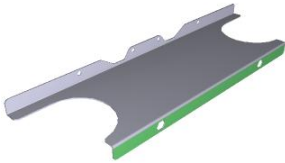

COMPONENT			SPARE PART																											
Code	Description	Image	Code	Description	Components list																									
SN1012B			KSN1021B	US MULTI.POINT L2750 CORE PROBE KIT	<table border="1"> <thead> <tr> <th>Code</th> <th>Description</th> <th>Qty</th> <th>UOM</th> </tr> </thead> <tbody> <tr> <td>SL1045A0</td> <td>S57 BLACK SILICONE - 80ML CARTRIDGE</td> <td>1</td> <td>PZ</td> </tr> <tr> <td>SN1012B0</td> <td></td> <td>1</td> <td>PZ</td> </tr> <tr> <td>VI1220A1</td> <td>4,2X12 TCB SELF-TAPPIN G SCREW</td> <td>3</td> <td>PZ</td> </tr> </tbody> </table>	Code	Description	Qty	UOM	SL1045A0	S57 BLACK SILICONE - 80ML CARTRIDGE	1	PZ	SN1012B0		1	PZ	VI1220A1	4,2X12 TCB SELF-TAPPIN G SCREW	3	PZ									
			Code	Description	Qty	UOM																								
SL1045A0	S57 BLACK SILICONE - 80ML CARTRIDGE	1	PZ																											
SN1012B0		1	PZ																											
VI1220A1	4,2X12 TCB SELF-TAPPIN G SCREW	3	PZ																											
KSN1012B	MULTIPOINT CORE PROBE KIT L2750	<table border="1"> <thead> <tr> <th>Code</th> <th>Description</th> <th>Qty</th> <th>UOM</th> </tr> </thead> <tbody> <tr> <td>0H8035A0</td> <td>MM CORE PROBE ACCESS COVE</td> <td>1</td> <td>PZ</td> </tr> <tr> <td>CE1685A0</td> <td>MRT8 P3,81 5 POLES FEMALE TERMINAL</td> <td>1</td> <td>PZ</td> </tr> <tr> <td>GN1632A0</td> <td>CORE PROBE INLET HOLDING GASKET</td> <td>1</td> <td>PZ</td> </tr> <tr> <td>SL1045A0</td> <td>S57 BLACK SILICONE - 80ML CARTRIDGE</td> <td>1</td> <td>PZ</td> </tr> <tr> <td>SN1012B0</td> <td></td> <td>1</td> <td>PZ</td> </tr> <tr> <td>VI1220A1</td> <td>4,2X12 TCB SELF-TAPPIN G SCREW</td> <td>3</td> <td>PZ</td> </tr> </tbody> </table>	Code	Description	Qty	UOM	0H8035A0	MM CORE PROBE ACCESS COVE	1	PZ	CE1685A0	MRT8 P3,81 5 POLES FEMALE TERMINAL	1	PZ	GN1632A0	CORE PROBE INLET HOLDING GASKET	1	PZ	SL1045A0	S57 BLACK SILICONE - 80ML CARTRIDGE	1	PZ	SN1012B0		1	PZ	VI1220A1	4,2X12 TCB SELF-TAPPIN G SCREW	3	PZ
Code	Description	Qty	UOM																											
0H8035A0	MM CORE PROBE ACCESS COVE	1	PZ																											
CE1685A0	MRT8 P3,81 5 POLES FEMALE TERMINAL	1	PZ																											
GN1632A0	CORE PROBE INLET HOLDING GASKET	1	PZ																											
SL1045A0	S57 BLACK SILICONE - 80ML CARTRIDGE	1	PZ																											
SN1012B0		1	PZ																											
VI1220A1	4,2X12 TCB SELF-TAPPIN G SCREW	3	PZ																											
0G1596A	SPACER PLATE CARTER AIR CT GA		0G1596A2	SPACER PLATE CARTER AIR CT GA																										
VM2350A	CORE PROBE SUPPORT		KVM2350A	CORE PROBE SUPPORT KIT	<table border="1"> <thead> <tr> <th>Code</th> <th>Description</th> <th>Qty</th> <th>UOM</th> </tr> </thead> <tbody> <tr> <td>VI1220A1</td> <td>4,2X12 TCB SELF-TAPPIN G SCREW</td> <td>2</td> <td>PZ</td> </tr> <tr> <td>VM1224A0</td> <td></td> <td>0.200</td> <td>M</td> </tr> <tr> <td>VM2350A0</td> <td>CORE PROBE SUPPORT</td> <td>1</td> <td>PZ</td> </tr> <tr> <td>VM2350A0</td> <td>CORE PROBE SUPPORT</td> <td>1</td> <td>PZ</td> </tr> </tbody> </table>	Code	Description	Qty	UOM	VI1220A1	4,2X12 TCB SELF-TAPPIN G SCREW	2	PZ	VM1224A0		0.200	M	VM2350A0	CORE PROBE SUPPORT	1	PZ	VM2350A0	CORE PROBE SUPPORT	1	PZ					
					Code	Description	Qty	UOM																						
					VI1220A1	4,2X12 TCB SELF-TAPPIN G SCREW	2	PZ																						
					VM1224A0		0.200	M																						
VM2350A0	CORE PROBE SUPPORT	1	PZ																											
VM2350A0	CORE PROBE SUPPORT	1	PZ																											



ASM1802B/0.D01 - External cover



ASM1802B/0.D01 - External cover



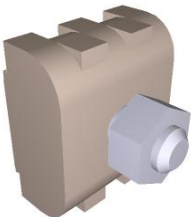



COMPONENT			SPARE PART																																						
Code	Description	Image	Code	Description	Components list																																				
VM1750A	BRASS COMB CLAM		KVM1750A	COMB TERMINAL BLOCK KIT	<table border="1"> <thead> <tr> <th>Code</th> <th>Description</th> <th>Qty</th> <th>UOM</th> </tr> </thead> <tbody> <tr> <td>VM1224A0</td> <td></td> <td>0.150</td> <td>M</td> </tr> <tr> <td>VM1750A0</td> <td>BRASS COMB CLAMP</td> <td>1</td> <td>PZ</td> </tr> </tbody> </table>	Code	Description	Qty	UOM	VM1224A0		0.150	M	VM1750A0	BRASS COMB CLAMP	1	PZ																								
Code	Description	Qty	UOM																																						
VM1224A0		0.150	M																																						
VM1750A0	BRASS COMB CLAMP	1	PZ																																						
VN1165A	230VAC 50/60HZ COOLING DOWN FA		KVN1165A	S.5E ADVANCE/MM 230V COOLING FAN KIT	<table border="1"> <thead> <tr> <th>Code</th> <th>Description</th> <th>Qty</th> <th>UOM</th> </tr> </thead> <tbody> <tr> <td>VI1099A0</td> <td>SELF-DRILLIN G SCREW 4.8X13 TCB+ Z</td> <td>4</td> <td>PZ</td> </tr> <tr> <td>VM1555A2</td> <td>CT BT COOLING FAN SUPPORT</td> <td>1</td> <td>PZ</td> </tr> <tr> <td>VN1165A0</td> <td>230VAC 50/60HZ COOLING DOWN FAN</td> <td>1</td> <td>PZ</td> </tr> <tr> <td>VN1165A0</td> <td>230VAC 50/60HZ COOLING DOWN FAN</td> <td>1</td> <td>PZ</td> </tr> </tbody> </table>	Code	Description	Qty	UOM	VI1099A0	SELF-DRILLIN G SCREW 4.8X13 TCB+ Z	4	PZ	VM1555A2	CT BT COOLING FAN SUPPORT	1	PZ	VN1165A0	230VAC 50/60HZ COOLING DOWN FAN	1	PZ	VN1165A0	230VAC 50/60HZ COOLING DOWN FAN	1	PZ																
Code	Description	Qty	UOM																																						
VI1099A0	SELF-DRILLIN G SCREW 4.8X13 TCB+ Z	4	PZ																																						
VM1555A2	CT BT COOLING FAN SUPPORT	1	PZ																																						
VN1165A0	230VAC 50/60HZ COOLING DOWN FAN	1	PZ																																						
VN1165A0	230VAC 50/60HZ COOLING DOWN FAN	1	PZ																																						
VM1555A	CT BT COOLING FAN SUPPORT		<p>KVN1165A</p> <p>KVN1164A</p>	<p>S.5E ADVANCE/MM 230V COOLING FAN KIT</p> <p>S.5/5E 12VDC COOLING DOWN FAN KIT</p>	<table border="1"> <thead> <tr> <th>Code</th> <th>Description</th> <th>Qty</th> <th>UOM</th> </tr> </thead> <tbody> <tr> <td>VI1099A0</td> <td>SELF-DRILLIN G SCREW 4.8X13 TCB+ Z</td> <td>4</td> <td>PZ</td> </tr> <tr> <td>VM1555A2</td> <td>CT BT COOLING FAN SUPPORT</td> <td>1</td> <td>PZ</td> </tr> <tr> <td>VN1165A0</td> <td>230VAC 50/60HZ COOLING DOWN FAN</td> <td>1</td> <td>PZ</td> </tr> <tr> <td>VN1165A0</td> <td>230VAC 50/60HZ COOLING DOWN FAN</td> <td>1</td> <td>PZ</td> </tr> <tr> <td>VI1099A0</td> <td>SELF-DRILLIN G SCREW 4.8X13 TCB+ Z</td> <td>4</td> <td>PZ</td> </tr> <tr> <td>VM1555A2</td> <td>CT BT COOLING FAN SUPPORT</td> <td>1</td> <td>PZ</td> </tr> <tr> <td>VN1164A0</td> <td>12VDC COOLING DOWN FAN</td> <td>1</td> <td>PZ</td> </tr> <tr> <td>VN1164A0</td> <td>12VDC COOLING DOWN FAN</td> <td>1</td> <td>PZ</td> </tr> </tbody> </table>	Code	Description	Qty	UOM	VI1099A0	SELF-DRILLIN G SCREW 4.8X13 TCB+ Z	4	PZ	VM1555A2	CT BT COOLING FAN SUPPORT	1	PZ	VN1165A0	230VAC 50/60HZ COOLING DOWN FAN	1	PZ	VN1165A0	230VAC 50/60HZ COOLING DOWN FAN	1	PZ	VI1099A0	SELF-DRILLIN G SCREW 4.8X13 TCB+ Z	4	PZ	VM1555A2	CT BT COOLING FAN SUPPORT	1	PZ	VN1164A0	12VDC COOLING DOWN FAN	1	PZ	VN1164A0	12VDC COOLING DOWN FAN	1	PZ
Code	Description	Qty	UOM																																						
VI1099A0	SELF-DRILLIN G SCREW 4.8X13 TCB+ Z	4	PZ																																						
VM1555A2	CT BT COOLING FAN SUPPORT	1	PZ																																						
VN1165A0	230VAC 50/60HZ COOLING DOWN FAN	1	PZ																																						
VN1165A0	230VAC 50/60HZ COOLING DOWN FAN	1	PZ																																						
VI1099A0	SELF-DRILLIN G SCREW 4.8X13 TCB+ Z	4	PZ																																						
VM1555A2	CT BT COOLING FAN SUPPORT	1	PZ																																						
VN1164A0	12VDC COOLING DOWN FAN	1	PZ																																						
VN1164A0	12VDC COOLING DOWN FAN	1	PZ																																						



COMPONENT			SPARE PART																		
Code	Description	Image	Code	Description	Components list																
VM1556A	XBC-XVC COOLING FAN GUARD		KVM1556A	XBC-XVC COOLING FAN GUARD KIT	<table border="1"> <thead> <tr> <th>Code</th> <th>Description</th> <th>Qty</th> <th>UOM</th> </tr> </thead> <tbody> <tr> <td>VM1556A0</td> <td>XBC-XVC COOLING FAN GUARD</td> <td>1</td> <td>PZ</td> </tr> </tbody> </table>	Code	Description	Qty	UOM	VM1556A0	XBC-XVC COOLING FAN GUARD	1	PZ								
Code	Description	Qty	UOM																		
VM1556A0	XBC-XVC COOLING FAN GUARD	1	PZ																		
GN1558A	EXHAUST SEAL		K0H7291A	GASKET AND SEALING DISC CHIMNEY KIT	<table border="1"> <thead> <tr> <th>Code</th> <th>Description</th> <th>Qty</th> <th>UOM</th> </tr> </thead> <tbody> <tr> <td>0H7291A0</td> <td>CHIMNEY HOLDING DISC</td> <td>1</td> <td>PZ</td> </tr> <tr> <td>GN1558A0</td> <td>EXHAUST SEAL</td> <td>1</td> <td>PZ</td> </tr> <tr> <td>VM1224A0</td> <td></td> <td>0.200</td> <td>M</td> </tr> </tbody> </table>	Code	Description	Qty	UOM	0H7291A0	CHIMNEY HOLDING DISC	1	PZ	GN1558A0	EXHAUST SEAL	1	PZ	VM1224A0		0.200	M
Code	Description	Qty	UOM																		
0H7291A0	CHIMNEY HOLDING DISC	1	PZ																		
GN1558A0	EXHAUST SEAL	1	PZ																		
VM1224A0		0.200	M																		
0H7291A	CHIMNEY HOLDING DISC		K0H7291A	GASKET AND SEALING DISC CHIMNEY KIT	<table border="1"> <thead> <tr> <th>Code</th> <th>Description</th> <th>Qty</th> <th>UOM</th> </tr> </thead> <tbody> <tr> <td>0H7291A0</td> <td>CHIMNEY HOLDING DISC</td> <td>1</td> <td>PZ</td> </tr> <tr> <td>GN1558A0</td> <td>EXHAUST SEA</td> <td>1</td> <td>PZ</td> </tr> <tr> <td>VM1224A0</td> <td></td> <td>0.200</td> <td>M</td> </tr> </tbody> </table>	Code	Description	Qty	UOM	0H7291A0	CHIMNEY HOLDING DISC	1	PZ	GN1558A0	EXHAUST SEA	1	PZ	VM1224A0		0.200	M
Code	Description	Qty	UOM																		
0H7291A0	CHIMNEY HOLDING DISC	1	PZ																		
GN1558A0	EXHAUST SEA	1	PZ																		
VM1224A0		0.200	M																		
RC1055A	Ø25-40 H12 STAINLESS STEEL PIPE CLIP		KRC1055A	Ø25-40 PIPE CLAMP 10PCS KIT	<table border="1"> <thead> <tr> <th>Code</th> <th>Description</th> <th>Qty</th> <th>UOM</th> </tr> </thead> <tbody> <tr> <td>RC1055A0</td> <td>Ø25-40 H12 STAINLESS STEEL PIPE CLIP</td> <td>10</td> <td>PZ</td> </tr> <tr> <td>VM1224A0</td> <td></td> <td>0.250</td> <td>M</td> </tr> </tbody> </table>	Code	Description	Qty	UOM	RC1055A0	Ø25-40 H12 STAINLESS STEEL PIPE CLIP	10	PZ	VM1224A0		0.250	M				
Code	Description	Qty	UOM																		
RC1055A0	Ø25-40 H12 STAINLESS STEEL PIPE CLIP	10	PZ																		
VM1224A0		0.250	M																		
PD1078A	2FT ADJUSTABLE FOOT H147-190 PLATE		KPD1078A	2" H147-190 ADJUSTABLE FOOT KIT	<table border="1"> <thead> <tr> <th>Code</th> <th>Description</th> <th>Qty</th> <th>UOM</th> </tr> </thead> <tbody> <tr> <td>PD1078A0</td> <td>2FT ADJUSTABLE FOOT H147-190 PLATE</td> <td>4</td> <td>PZ</td> </tr> </tbody> </table>	Code	Description	Qty	UOM	PD1078A0	2FT ADJUSTABLE FOOT H147-190 PLATE	4	PZ								
Code	Description	Qty	UOM																		
PD1078A0	2FT ADJUSTABLE FOOT H147-190 PLATE	4	PZ																		

COMPONENT			SPARE PART																														
Code	Description	Image	Code	Description	Components list																												
VM1190A	CT BT RIGHT DOOR SPRING LATCH		KVM1190A	CHEFTOP/BAKERTO P DOOR RIGHT LATCH KIT	<table border="1"> <thead> <tr> <th>Code</th> <th>Description</th> <th>Qty</th> <th>UOM</th> </tr> </thead> <tbody> <tr> <td>VI0239A1</td> <td>SELF-TAPPIN G SCREW 4.2X25 TCB+ INOX</td> <td>2</td> <td>PZ</td> </tr> <tr> <td>VI1220A1</td> <td>4,2X12 TCB SELF-TAPPIN G SCREW</td> <td>2</td> <td>PZ</td> </tr> <tr> <td>VM1190A2</td> <td>CT BT RIGHT DOOR SPRING LATCH</td> <td>1</td> <td>PZ</td> </tr> <tr> <td>VM1192A1</td> <td>CT BT DOOR SPRING LATCH BACK COVER</td> <td>1</td> <td>PZ</td> </tr> <tr> <td>VM1224A0</td> <td></td> <td>0.200</td> <td>M</td> </tr> <tr> <td>VM1460A0</td> <td>XBC/XVC RIGHT DOOR LATCH CAP</td> <td>1</td> <td>PZ</td> </tr> </tbody> </table>	Code	Description	Qty	UOM	VI0239A1	SELF-TAPPIN G SCREW 4.2X25 TCB+ INOX	2	PZ	VI1220A1	4,2X12 TCB SELF-TAPPIN G SCREW	2	PZ	VM1190A2	CT BT RIGHT DOOR SPRING LATCH	1	PZ	VM1192A1	CT BT DOOR SPRING LATCH BACK COVER	1	PZ	VM1224A0		0.200	M	VM1460A0	XBC/XVC RIGHT DOOR LATCH CAP	1	PZ
					Code	Description	Qty	UOM																									
VI0239A1	SELF-TAPPIN G SCREW 4.2X25 TCB+ INOX	2	PZ																														
VI1220A1	4,2X12 TCB SELF-TAPPIN G SCREW	2	PZ																														
VM1190A2	CT BT RIGHT DOOR SPRING LATCH	1	PZ																														
VM1192A1	CT BT DOOR SPRING LATCH BACK COVER	1	PZ																														
VM1224A0		0.200	M																														
VM1460A0	XBC/XVC RIGHT DOOR LATCH CAP	1	PZ																														
VM1192A	CT BT DOOR SPRING LATCH BACK COVER		KVM1191A	CHEFTOP/BAKERTO P DOOR LEFT LATCH KIT	<table border="1"> <thead> <tr> <th>Code</th> <th>Description</th> <th>Qty</th> <th>UOM</th> </tr> </thead> <tbody> <tr> <td>VI0239A1</td> <td>SELF-TAPPIN G SCREW 4.2X25 TCB+ INOX</td> <td>2</td> <td>PZ</td> </tr> <tr> <td>VI1220A1</td> <td>4,2X12 TCB SELF-TAPPIN G SCREW</td> <td>2</td> <td>PZ</td> </tr> <tr> <td>VM1191A2</td> <td>CT BT LEFT DOOR SPRING LATCH</td> <td>1</td> <td>PZ</td> </tr> <tr> <td>VM1192A1</td> <td>CT BT DOOR SPRING LATCH BACK COVER</td> <td>1</td> <td>PZ</td> </tr> <tr> <td>VM1224A0</td> <td></td> <td>0.200</td> <td>M</td> </tr> <tr> <td>VM1460A0</td> <td>XBC/XVC RIGHT DOOR LATCH CAP</td> <td>1</td> <td>PZ</td> </tr> </tbody> </table>	Code	Description	Qty	UOM	VI0239A1	SELF-TAPPIN G SCREW 4.2X25 TCB+ INOX	2	PZ	VI1220A1	4,2X12 TCB SELF-TAPPIN G SCREW	2	PZ	VM1191A2	CT BT LEFT DOOR SPRING LATCH	1	PZ	VM1192A1	CT BT DOOR SPRING LATCH BACK COVER	1	PZ	VM1224A0		0.200	M	VM1460A0	XBC/XVC RIGHT DOOR LATCH CAP	1	PZ
Code	Description	Qty	UOM																														
VI0239A1	SELF-TAPPIN G SCREW 4.2X25 TCB+ INOX	2	PZ																														
VI1220A1	4,2X12 TCB SELF-TAPPIN G SCREW	2	PZ																														
VM1191A2	CT BT LEFT DOOR SPRING LATCH	1	PZ																														
VM1192A1	CT BT DOOR SPRING LATCH BACK COVER	1	PZ																														
VM1224A0		0.200	M																														
VM1460A0	XBC/XVC RIGHT DOOR LATCH CAP	1	PZ																														
			KVM1190A	CHEFTOP/BAKERTO P DOOR RIGHT LATCH KIT	<table border="1"> <thead> <tr> <th>Code</th> <th>Description</th> <th>Qty</th> <th>UOM</th> </tr> </thead> <tbody> <tr> <td>VI0239A1</td> <td>SELF-TAPPIN G SCREW 4.2X25 TCB+ INOX</td> <td>2</td> <td>PZ</td> </tr> <tr> <td>VI1220A1</td> <td>4,2X12 TCB SELF-TAPPIN G SCREW</td> <td>2</td> <td>PZ</td> </tr> <tr> <td>VM1190A2</td> <td>CT BT RIGHT DOOR SPRING LATCH</td> <td>1</td> <td>PZ</td> </tr> <tr> <td>VM1192A1</td> <td>CT BT DOOR SPRING LATCH BACK COVER</td> <td>1</td> <td>PZ</td> </tr> <tr> <td>VM1224A0</td> <td></td> <td>0.200</td> <td>M</td> </tr> <tr> <td>VM1460A0</td> <td>XBC/XVC RIGHT DOOR LATCH CAP</td> <td>1</td> <td>PZ</td> </tr> </tbody> </table>	Code	Description	Qty	UOM	VI0239A1	SELF-TAPPIN G SCREW 4.2X25 TCB+ INOX	2	PZ	VI1220A1	4,2X12 TCB SELF-TAPPIN G SCREW	2	PZ	VM1190A2	CT BT RIGHT DOOR SPRING LATCH	1	PZ	VM1192A1	CT BT DOOR SPRING LATCH BACK COVER	1	PZ	VM1224A0		0.200	M	VM1460A0	XBC/XVC RIGHT DOOR LATCH CAP	1	PZ
Code	Description	Qty	UOM																														
VI0239A1	SELF-TAPPIN G SCREW 4.2X25 TCB+ INOX	2	PZ																														
VI1220A1	4,2X12 TCB SELF-TAPPIN G SCREW	2	PZ																														
VM1190A2	CT BT RIGHT DOOR SPRING LATCH	1	PZ																														
VM1192A1	CT BT DOOR SPRING LATCH BACK COVER	1	PZ																														
VM1224A0		0.200	M																														
VM1460A0	XBC/XVC RIGHT DOOR LATCH CAP	1	PZ																														

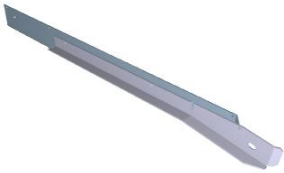

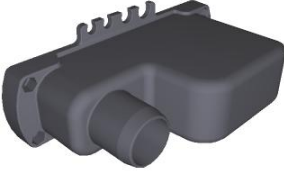
COMPONENT			SPARE PART																																																														
Code	Description	Image	Code	Description	Components list																																																												
0H7274A	XEVC-2011 RIGHT TROLLEY GUIDE KIT		0H7274A0	XEVC-2011 RIGHT TROLLEY GUIDE KIT																																																													
0H7275A	XEVC-2011 LEFT TROLLEY GUIDE KIT		0H7275A0	XEVC-2011 LEFT TROLLEY GUIDE KIT																																																													
VL1005A	U-TRAP TANK		XUC001	SINGLE UNIT INSTALLATION KIT	<table border="1"> <thead> <tr> <th>Code</th> <th>Description</th> <th>Qty</th> <th>UOM</th> </tr> </thead> <tbody> <tr> <td>0H6567A0</td> <td>P-TRAP HOLDING BRACKET</td> <td>1</td> <td>PZ</td> </tr> <tr> <td>GN1400A0</td> <td>U-TRAP SEAL</td> <td>1</td> <td>PZ</td> </tr> <tr> <td>GN1508A0</td> <td>O-RING GASKET COD 2400</td> <td>1</td> <td>PZ</td> </tr> <tr> <td>IL1115A0</td> <td>WOODEN PALET 80X120</td> <td>0.100</td> <td>PZ</td> </tr> <tr> <td>RC1055A0</td> <td>Ø25-40 H12 STAINLESS STEEL PIPE CLIP</td> <td>3</td> <td>PZ</td> </tr> <tr> <td>TB1520A0</td> <td>INT. Ø=38 TH=4 DRAIN BLACK RUBBER PIPE</td> <td>2.500</td> <td>M</td> </tr> <tr> <td>VI1220A1</td> <td>4,2X12 TCB SELF-TAPPIN G SCREW</td> <td>2</td> <td>PZ</td> </tr> <tr> <td>VI1895A0</td> <td>BLIND NUT M4 STAINLESS STEEL DIN 917</td> <td>4</td> <td>PZ</td> </tr> <tr> <td>VI1945A0</td> <td>ENG-VITE M4X20 TCB+ INOX</td> <td>4</td> <td>PZ</td> </tr> <tr> <td>VI1950A0</td> <td>ST. STEEL 4,2X13 TCB SELF-DRILLIN G SCREW</td> <td>2</td> <td>PZ</td> </tr> <tr> <td>VL1005A1</td> <td>U-TRAP TANK</td> <td>1</td> <td>PZ</td> </tr> <tr> <td>VL1006A0</td> <td>SYPHON COVER</td> <td>1</td> <td>PZ</td> </tr> <tr> <td>VL1026A0</td> <td>BEND FOR DRAIN PIPE</td> <td>1</td> <td>PZ</td> </tr> <tr> <td>VM1015A1</td> <td>STAINLESS STEEL Ø30X1.5 90° BEND</td> <td>1</td> <td>PZ</td> </tr> </tbody> </table>	Code	Description	Qty	UOM	0H6567A0	P-TRAP HOLDING BRACKET	1	PZ	GN1400A0	U-TRAP SEAL	1	PZ	GN1508A0	O-RING GASKET COD 2400	1	PZ	IL1115A0	WOODEN PALET 80X120	0.100	PZ	RC1055A0	Ø25-40 H12 STAINLESS STEEL PIPE CLIP	3	PZ	TB1520A0	INT. Ø=38 TH=4 DRAIN BLACK RUBBER PIPE	2.500	M	VI1220A1	4,2X12 TCB SELF-TAPPIN G SCREW	2	PZ	VI1895A0	BLIND NUT M4 STAINLESS STEEL DIN 917	4	PZ	VI1945A0	ENG-VITE M4X20 TCB+ INOX	4	PZ	VI1950A0	ST. STEEL 4,2X13 TCB SELF-DRILLIN G SCREW	2	PZ	VL1005A1	U-TRAP TANK	1	PZ	VL1006A0	SYPHON COVER	1	PZ	VL1026A0	BEND FOR DRAIN PIPE	1	PZ	VM1015A1	STAINLESS STEEL Ø30X1.5 90° BEND	1	PZ
Code	Description	Qty	UOM																																																														
0H6567A0	P-TRAP HOLDING BRACKET	1	PZ																																																														
GN1400A0	U-TRAP SEAL	1	PZ																																																														
GN1508A0	O-RING GASKET COD 2400	1	PZ																																																														
IL1115A0	WOODEN PALET 80X120	0.100	PZ																																																														
RC1055A0	Ø25-40 H12 STAINLESS STEEL PIPE CLIP	3	PZ																																																														
TB1520A0	INT. Ø=38 TH=4 DRAIN BLACK RUBBER PIPE	2.500	M																																																														
VI1220A1	4,2X12 TCB SELF-TAPPIN G SCREW	2	PZ																																																														
VI1895A0	BLIND NUT M4 STAINLESS STEEL DIN 917	4	PZ																																																														
VI1945A0	ENG-VITE M4X20 TCB+ INOX	4	PZ																																																														
VI1950A0	ST. STEEL 4,2X13 TCB SELF-DRILLIN G SCREW	2	PZ																																																														
VL1005A1	U-TRAP TANK	1	PZ																																																														
VL1006A0	SYPHON COVER	1	PZ																																																														
VL1026A0	BEND FOR DRAIN PIPE	1	PZ																																																														
VM1015A1	STAINLESS STEEL Ø30X1.5 90° BEND	1	PZ																																																														

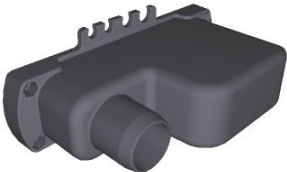

COMPONENT			SPARE PART																																																																														
Code	Description	Image	Code	Description	Components list																																																																												
VL1005A	U-TRAP TANK		XC761	3 OVENS LM TOP XFT200 STACKING KIT	<table border="1"> <thead> <tr> <th>Code</th> <th>Description</th> <th>Qty</th> <th>UOM</th> </tr> </thead> <tbody> <tr> <td>0H1237A0</td> <td>LM TOP SIPHON SUPPORT</td> <td>3</td> <td>PZ</td> </tr> <tr> <td>0H7082A0</td> <td>LM 800 XC STACKING KIT FRONT PROFILE</td> <td>2</td> <td>PZ</td> </tr> <tr> <td>0H7083A0</td> <td>LM 800 XC STACKING KIT BACK PROFIL</td> <td>4</td> <td>PZ</td> </tr> <tr> <td>ED1246A0</td> <td>HOT SURFACE LABEL</td> <td>1</td> <td>PZ</td> </tr> <tr> <td>ED1271A0</td> <td>LIQUID FALLS DANGER LABE</td> <td>1</td> <td>PZ</td> </tr> <tr> <td>EL1020A1</td> <td>D8 INTERMEDIAT E T-SHAPED FITTING</td> <td>4</td> <td>PZ</td> </tr> <tr> <td>EL1180A0</td> <td>Ø8-Ø8 FEMALE NON-RETURN CONNECTION</td> <td>3</td> <td>PZ</td> </tr> <tr> <td>GN1508A0</td> <td>O-RING GASKET COD 2400</td> <td>3</td> <td>PZ</td> </tr> <tr> <td>RC1008A0</td> <td>D9 ELASTIC CLIP</td> <td>12</td> <td>PZ</td> </tr> <tr> <td>RC1055A0</td> <td>Ø25-40 H12 STAINLESS STEEL PIPE CLIP</td> <td>15</td> <td>PZ</td> </tr> <tr> <td>RC1297A1</td> <td>D10 T-SHAPED FITTING</td> <td>2</td> <td>PZ</td> </tr> <tr> <td>RC1360A0</td> <td>10 - 10 JG ELBOW FITTIN</td> <td>1</td> <td>PZ</td> </tr> <tr> <td>RC1376A0</td> <td>Ø6 Y-FITTING</td> <td>2</td> <td>PZ</td> </tr> <tr> <td>TB1177A0</td> <td>FOOT PANEL 40X40 H58 OVERLAP LM</td> <td>8</td> <td>PZ</td> </tr> <tr> <td>TB1520A0</td> <td>INT. Ø=38 TH=4 DRAIN BLACK RUBBER PIPE</td> <td>5</td> <td>M</td> </tr> <tr> <td>TB1815A0</td> <td>7,93X4,75 PE TRANSP. PIPE (JG #PE08100N)</td> <td>12</td> <td>M</td> </tr> <tr> <td>TB1816A0</td> <td>CLEAR POLYPROPYL ENE PIPE 6X4MM</td> <td>3</td> <td>M</td> </tr> <tr> <td>TB2243A0</td> <td>D10 PE TRANSPAREN T PIPE</td> <td>4</td> <td>M</td> </tr> </tbody> </table>	Code	Description	Qty	UOM	0H1237A0	LM TOP SIPHON SUPPORT	3	PZ	0H7082A0	LM 800 XC STACKING KIT FRONT PROFILE	2	PZ	0H7083A0	LM 800 XC STACKING KIT BACK PROFIL	4	PZ	ED1246A0	HOT SURFACE LABEL	1	PZ	ED1271A0	LIQUID FALLS DANGER LABE	1	PZ	EL1020A1	D8 INTERMEDIAT E T-SHAPED FITTING	4	PZ	EL1180A0	Ø8-Ø8 FEMALE NON-RETURN CONNECTION	3	PZ	GN1508A0	O-RING GASKET COD 2400	3	PZ	RC1008A0	D9 ELASTIC CLIP	12	PZ	RC1055A0	Ø25-40 H12 STAINLESS STEEL PIPE CLIP	15	PZ	RC1297A1	D10 T-SHAPED FITTING	2	PZ	RC1360A0	10 - 10 JG ELBOW FITTIN	1	PZ	RC1376A0	Ø6 Y-FITTING	2	PZ	TB1177A0	FOOT PANEL 40X40 H58 OVERLAP LM	8	PZ	TB1520A0	INT. Ø=38 TH=4 DRAIN BLACK RUBBER PIPE	5	M	TB1815A0	7,93X4,75 PE TRANSP. PIPE (JG #PE08100N)	12	M	TB1816A0	CLEAR POLYPROPYL ENE PIPE 6X4MM	3	M	TB2243A0	D10 PE TRANSPAREN T PIPE	4	M
Code	Description	Qty	UOM																																																																														
0H1237A0	LM TOP SIPHON SUPPORT	3	PZ																																																																														
0H7082A0	LM 800 XC STACKING KIT FRONT PROFILE	2	PZ																																																																														
0H7083A0	LM 800 XC STACKING KIT BACK PROFIL	4	PZ																																																																														
ED1246A0	HOT SURFACE LABEL	1	PZ																																																																														
ED1271A0	LIQUID FALLS DANGER LABE	1	PZ																																																																														
EL1020A1	D8 INTERMEDIAT E T-SHAPED FITTING	4	PZ																																																																														
EL1180A0	Ø8-Ø8 FEMALE NON-RETURN CONNECTION	3	PZ																																																																														
GN1508A0	O-RING GASKET COD 2400	3	PZ																																																																														
RC1008A0	D9 ELASTIC CLIP	12	PZ																																																																														
RC1055A0	Ø25-40 H12 STAINLESS STEEL PIPE CLIP	15	PZ																																																																														
RC1297A1	D10 T-SHAPED FITTING	2	PZ																																																																														
RC1360A0	10 - 10 JG ELBOW FITTIN	1	PZ																																																																														
RC1376A0	Ø6 Y-FITTING	2	PZ																																																																														
TB1177A0	FOOT PANEL 40X40 H58 OVERLAP LM	8	PZ																																																																														
TB1520A0	INT. Ø=38 TH=4 DRAIN BLACK RUBBER PIPE	5	M																																																																														
TB1815A0	7,93X4,75 PE TRANSP. PIPE (JG #PE08100N)	12	M																																																																														
TB1816A0	CLEAR POLYPROPYL ENE PIPE 6X4MM	3	M																																																																														
TB2243A0	D10 PE TRANSPAREN T PIPE	4	M																																																																														



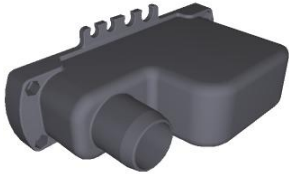

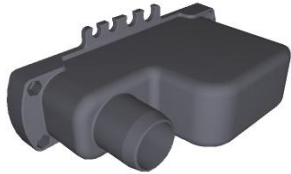
COMPONENT			SPARE PART																																															
Code	Description	Image	Code	Description	Components list																																													
VL1005A	U-TRAP TANK		XC761	3 OVENS LM TOP XFT200 STACKING KIT	<table border="1"> <thead> <tr> <th>Code</th> <th>Description</th> <th>Qty</th> <th>UOM</th> </tr> </thead> <tbody> <tr> <td>VI1220A1</td> <td>4,2X12 TCB SELF-TAPPIN G SCREW</td> <td>30</td> <td>PZ</td> </tr> <tr> <td>VI1895A0</td> <td>BLIND NUT M4 STAINLESS STEEL DIN 917</td> <td>12</td> <td>PZ</td> </tr> <tr> <td>VI1945A0</td> <td>ENG-VITE M4X20 TCB+ INOX</td> <td>12</td> <td>PZ</td> </tr> <tr> <td>VI1950A0</td> <td>ST. STEEL 4,2X13 TCB SELF-DRILLIN G SCREW</td> <td>20</td> <td>PZ</td> </tr> <tr> <td>VL1005A1</td> <td>U-TRAP TANK</td> <td>3</td> <td>PZ</td> </tr> <tr> <td>VL1006A0</td> <td>SYPHON COVER</td> <td>3</td> <td>PZ</td> </tr> <tr> <td>VL1046A1</td> <td>D6 PIPE HOLDER - D6 J.G. TERMINAL</td> <td>12</td> <td>PZ</td> </tr> <tr> <td>VM1015A1</td> <td>STAINLESS STEEL Ø30X1.5 90° BEND</td> <td>1</td> <td>PZ</td> </tr> <tr> <td>VM1794A0</td> <td>250X4.8 PA66 BLACK CLAMP</td> <td>3</td> <td>PZ</td> </tr> <tr> <td>VM2035A0</td> <td>DRAIN PIPE SUPPORT</td> <td>3</td> <td>PZ</td> </tr> </tbody> </table>	Code	Description	Qty	UOM	VI1220A1	4,2X12 TCB SELF-TAPPIN G SCREW	30	PZ	VI1895A0	BLIND NUT M4 STAINLESS STEEL DIN 917	12	PZ	VI1945A0	ENG-VITE M4X20 TCB+ INOX	12	PZ	VI1950A0	ST. STEEL 4,2X13 TCB SELF-DRILLIN G SCREW	20	PZ	VL1005A1	U-TRAP TANK	3	PZ	VL1006A0	SYPHON COVER	3	PZ	VL1046A1	D6 PIPE HOLDER - D6 J.G. TERMINAL	12	PZ	VM1015A1	STAINLESS STEEL Ø30X1.5 90° BEND	1	PZ	VM1794A0	250X4.8 PA66 BLACK CLAMP	3	PZ	VM2035A0	DRAIN PIPE SUPPORT	3	PZ	
			Code	Description	Qty	UOM																																												
VI1220A1	4,2X12 TCB SELF-TAPPIN G SCREW	30	PZ																																															
VI1895A0	BLIND NUT M4 STAINLESS STEEL DIN 917	12	PZ																																															
VI1945A0	ENG-VITE M4X20 TCB+ INOX	12	PZ																																															
VI1950A0	ST. STEEL 4,2X13 TCB SELF-DRILLIN G SCREW	20	PZ																																															
VL1005A1	U-TRAP TANK	3	PZ																																															
VL1006A0	SYPHON COVER	3	PZ																																															
VL1046A1	D6 PIPE HOLDER - D6 J.G. TERMINAL	12	PZ																																															
VM1015A1	STAINLESS STEEL Ø30X1.5 90° BEND	1	PZ																																															
VM1794A0	250X4.8 PA66 BLACK CLAMP	3	PZ																																															
VM2035A0	DRAIN PIPE SUPPORT	3	PZ																																															
XC757	S. E CHEFTOP GN1/1 STACKING KI	<table border="1"> <thead> <tr> <th>Code</th> <th>Description</th> <th>Qty</th> <th>UOM</th> </tr> </thead> <tbody> <tr> <td>0H6463A0</td> <td>XC757 FRONT PROFILE</td> <td>1</td> <td>PZ</td> </tr> <tr> <td>CE1305A0</td> <td>L=2MT RJ45 - RJ45 CABLE</td> <td>1</td> <td>PZ</td> </tr> <tr> <td>ED1246A0</td> <td>HOT SURFACE LABEL</td> <td>2</td> <td>PZ</td> </tr> <tr> <td>ED1271A0</td> <td>LIQUID FALLS DANGER LABE</td> <td>1</td> <td>PZ</td> </tr> <tr> <td>EL1020A1</td> <td>D8 INTERMEDIAT E T-SHAPED FITTING</td> <td>2</td> <td>PZ</td> </tr> <tr> <td>GN1508A0</td> <td>O-RING GASKET COD 2400</td> <td>2</td> <td>PZ</td> </tr> <tr> <td>PD1069A0</td> <td>FOOT OVERLAP S5 CT-BT-E</td> <td>1</td> <td>PZ</td> </tr> <tr> <td>RC1008A0</td> <td>D9 ELASTIC CLIP</td> <td>3</td> <td>PZ</td> </tr> <tr> <td>RC1055A0</td> <td>Ø25-40 H12 STAINLESS STEEL PIPE CLIP</td> <td>14</td> <td>PZ</td> </tr> <tr> <td>RC1130A0</td> <td>130X2,6 CLAM</td> <td>3</td> <td>PZ</td> </tr> <tr> <td>RC1297A1</td> <td>D10 T-SHAPED FITTING</td> <td>1</td> <td>PZ</td> </tr> </tbody> </table>	Code	Description	Qty	UOM	0H6463A0	XC757 FRONT PROFILE	1	PZ	CE1305A0	L=2MT RJ45 - RJ45 CABLE	1	PZ	ED1246A0	HOT SURFACE LABEL	2	PZ	ED1271A0	LIQUID FALLS DANGER LABE	1	PZ	EL1020A1	D8 INTERMEDIAT E T-SHAPED FITTING	2	PZ	GN1508A0	O-RING GASKET COD 2400	2	PZ	PD1069A0	FOOT OVERLAP S5 CT-BT-E	1	PZ	RC1008A0	D9 ELASTIC CLIP	3	PZ	RC1055A0	Ø25-40 H12 STAINLESS STEEL PIPE CLIP	14	PZ	RC1130A0	130X2,6 CLAM	3	PZ	RC1297A1	D10 T-SHAPED FITTING	1	PZ
Code	Description	Qty	UOM																																															
0H6463A0	XC757 FRONT PROFILE	1	PZ																																															
CE1305A0	L=2MT RJ45 - RJ45 CABLE	1	PZ																																															
ED1246A0	HOT SURFACE LABEL	2	PZ																																															
ED1271A0	LIQUID FALLS DANGER LABE	1	PZ																																															
EL1020A1	D8 INTERMEDIAT E T-SHAPED FITTING	2	PZ																																															
GN1508A0	O-RING GASKET COD 2400	2	PZ																																															
PD1069A0	FOOT OVERLAP S5 CT-BT-E	1	PZ																																															
RC1008A0	D9 ELASTIC CLIP	3	PZ																																															
RC1055A0	Ø25-40 H12 STAINLESS STEEL PIPE CLIP	14	PZ																																															
RC1130A0	130X2,6 CLAM	3	PZ																																															
RC1297A1	D10 T-SHAPED FITTING	1	PZ																																															

COMPONENT			SPARE PART																																																																																													
Code	Description	Image	Code	Description	Components list																																																																																											
VL1005A	U-TRAP TANK		XC757	S. E CHEFTOP GN1/1 STACKING KI	<table border="1"> <thead> <tr> <th>Code</th> <th>Description</th> <th>Qty</th> <th>UOM</th> </tr> </thead> <tbody> <tr> <td>RC1376A0</td> <td>Ø6 Y-FITTING</td> <td>1</td> <td>PZ</td> </tr> <tr> <td>TB1520A0</td> <td>INT. Ø=38 TH=4 DRAIN BLACK RUBBER PIPE</td> <td>5</td> <td>M</td> </tr> <tr> <td>TB1765A1</td> <td>STACKING KIT CHIMNEY CONNECTING PIPE</td> <td>2</td> <td>PZ</td> </tr> <tr> <td>TB2243A0</td> <td>D10 PE TRANSPAREN T PIPE</td> <td>1.500</td> <td>M</td> </tr> <tr> <td>VI1220A1</td> <td>4,2X12 TCB SELF-TAPPIN G SCREW</td> <td>4</td> <td>PZ</td> </tr> <tr> <td>VI1895A0</td> <td>BLIND NUT M4 STAINLESS STEEL DIN 917</td> <td>8</td> <td>PZ</td> </tr> <tr> <td>VI1945A0</td> <td>ENG-VITE M4X20 TCB+ INOX</td> <td>8</td> <td>PZ</td> </tr> <tr> <td>VI1950A0</td> <td>ST. STEEL 4,2X13 TCB SELF-DRILLIN G SCREW</td> <td>26</td> <td>PZ</td> </tr> <tr> <td>VL1005A1</td> <td>U-TRAP TANK</td> <td>2</td> <td>PZ</td> </tr> <tr> <td>VL1006A0</td> <td>SYPHON COVER</td> <td>2</td> <td>PZ</td> </tr> <tr> <td>VL1043A0</td> <td>D4 PIPE HOLDER - D6 J.G. TERMINAL</td> <td>3</td> <td>PZ</td> </tr> <tr> <td>VL1046A1</td> <td>D6 PIPE HOLDER - D6 J.G. TERMINAL</td> <td>3</td> <td>PZ</td> </tr> <tr> <td>VM1015A1</td> <td>STAINLESS STEEL Ø30X1.5 90° BEND</td> <td>1</td> <td>PZ</td> </tr> <tr> <td>VM1794A0</td> <td>250X4.8 PA66 BLACK CLAMP</td> <td>3</td> <td>PZ</td> </tr> <tr> <td>VM1987A0</td> <td>OVEN STACKING BRACKET</td> <td>1</td> <td>PZ</td> </tr> <tr> <td>VM2035A0</td> <td>DRAIN PIPE SUPPORT</td> <td>2</td> <td>PZ</td> </tr> </tbody> </table>	Code	Description	Qty	UOM	RC1376A0	Ø6 Y-FITTING	1	PZ	TB1520A0	INT. Ø=38 TH=4 DRAIN BLACK RUBBER PIPE	5	M	TB1765A1	STACKING KIT CHIMNEY CONNECTING PIPE	2	PZ	TB2243A0	D10 PE TRANSPAREN T PIPE	1.500	M	VI1220A1	4,2X12 TCB SELF-TAPPIN G SCREW	4	PZ	VI1895A0	BLIND NUT M4 STAINLESS STEEL DIN 917	8	PZ	VI1945A0	ENG-VITE M4X20 TCB+ INOX	8	PZ	VI1950A0	ST. STEEL 4,2X13 TCB SELF-DRILLIN G SCREW	26	PZ	VL1005A1	U-TRAP TANK	2	PZ	VL1006A0	SYPHON COVER	2	PZ	VL1043A0	D4 PIPE HOLDER - D6 J.G. TERMINAL	3	PZ	VL1046A1	D6 PIPE HOLDER - D6 J.G. TERMINAL	3	PZ	VM1015A1	STAINLESS STEEL Ø30X1.5 90° BEND	1	PZ	VM1794A0	250X4.8 PA66 BLACK CLAMP	3	PZ	VM1987A0	OVEN STACKING BRACKET	1	PZ	VM2035A0	DRAIN PIPE SUPPORT	2	PZ	XC756	E SERIES GN 2/3 STACKING KIT	<table border="1"> <thead> <tr> <th>Code</th> <th>Description</th> <th>Qty</th> <th>UOM</th> </tr> </thead> <tbody> <tr> <td>0H6462A0</td> <td>XC756 FRONT PROFILE</td> <td>1</td> <td>PZ</td> </tr> <tr> <td>CE1305A0</td> <td>L=2MT RJ45 - RJ45 CABLE</td> <td>1</td> <td>PZ</td> </tr> <tr> <td>ED1246A0</td> <td>HOT SURFACE LABEL</td> <td>1</td> <td>PZ</td> </tr> <tr> <td>ED1271A0</td> <td>LIQUID FALLS DANGER LABE</td> <td>1</td> <td>PZ</td> </tr> </tbody> </table>	Code	Description	Qty	UOM	0H6462A0	XC756 FRONT PROFILE	1	PZ	CE1305A0	L=2MT RJ45 - RJ45 CABLE	1	PZ	ED1246A0	HOT SURFACE LABEL	1	PZ	ED1271A0	LIQUID FALLS DANGER LABE	1	PZ
			Code	Description	Qty	UOM																																																																																										
RC1376A0	Ø6 Y-FITTING	1	PZ																																																																																													
TB1520A0	INT. Ø=38 TH=4 DRAIN BLACK RUBBER PIPE	5	M																																																																																													
TB1765A1	STACKING KIT CHIMNEY CONNECTING PIPE	2	PZ																																																																																													
TB2243A0	D10 PE TRANSPAREN T PIPE	1.500	M																																																																																													
VI1220A1	4,2X12 TCB SELF-TAPPIN G SCREW	4	PZ																																																																																													
VI1895A0	BLIND NUT M4 STAINLESS STEEL DIN 917	8	PZ																																																																																													
VI1945A0	ENG-VITE M4X20 TCB+ INOX	8	PZ																																																																																													
VI1950A0	ST. STEEL 4,2X13 TCB SELF-DRILLIN G SCREW	26	PZ																																																																																													
VL1005A1	U-TRAP TANK	2	PZ																																																																																													
VL1006A0	SYPHON COVER	2	PZ																																																																																													
VL1043A0	D4 PIPE HOLDER - D6 J.G. TERMINAL	3	PZ																																																																																													
VL1046A1	D6 PIPE HOLDER - D6 J.G. TERMINAL	3	PZ																																																																																													
VM1015A1	STAINLESS STEEL Ø30X1.5 90° BEND	1	PZ																																																																																													
VM1794A0	250X4.8 PA66 BLACK CLAMP	3	PZ																																																																																													
VM1987A0	OVEN STACKING BRACKET	1	PZ																																																																																													
VM2035A0	DRAIN PIPE SUPPORT	2	PZ																																																																																													
Code	Description	Qty	UOM																																																																																													
0H6462A0	XC756 FRONT PROFILE	1	PZ																																																																																													
CE1305A0	L=2MT RJ45 - RJ45 CABLE	1	PZ																																																																																													
ED1246A0	HOT SURFACE LABEL	1	PZ																																																																																													
ED1271A0	LIQUID FALLS DANGER LABE	1	PZ																																																																																													

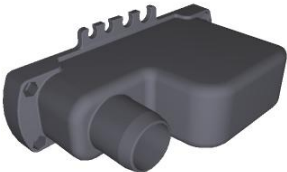

COMPONENT			SPARE PART																																																																																		
Code	Description	Image	Code	Description	Components list																																																																																
VL1005A	U-TRAP TANK		XC756	E SERIES GN 2/3 STACKING KIT	<table border="1"> <thead> <tr> <th>Code</th> <th>Description</th> <th>Qty</th> <th>UOM</th> </tr> </thead> <tbody> <tr> <td>EL1020A1</td> <td>D8 INTERMEDIAT E T-SHAPED FITTING</td> <td>2</td> <td>PZ</td> </tr> <tr> <td>GN1508A0</td> <td>O-RING GASKET COD 2400</td> <td>2</td> <td>PZ</td> </tr> <tr> <td>PD1069A0</td> <td>FOOT OVERLAP S5 CT-BT-E</td> <td>1</td> <td>PZ</td> </tr> <tr> <td>RC1008A0</td> <td>D9 ELASTIC CLIP</td> <td>3</td> <td>PZ</td> </tr> <tr> <td>RC1055A0</td> <td>Ø25-40 H12 STAINLESS STEEL PIPE CLIP</td> <td>14</td> <td>PZ</td> </tr> <tr> <td>RC1130A0</td> <td>130X2,6 CLAM</td> <td>3</td> <td>PZ</td> </tr> <tr> <td>RC1297A1</td> <td>D10 T-SHAPED FITTING</td> <td>1</td> <td>PZ</td> </tr> <tr> <td>RC1376A0</td> <td>Ø6 Y-FITTING</td> <td>1</td> <td>PZ</td> </tr> <tr> <td>TB1520A0</td> <td>INT. Ø=38 TH=4 DRAIN BLACK RUBBER PIPE</td> <td>3</td> <td>M</td> </tr> <tr> <td>TB1765A1</td> <td>STACKING KIT CHIMNEY CONNECTING PIPE</td> <td>1</td> <td>PZ</td> </tr> <tr> <td>TB2243A0</td> <td>D10 PE TRANSPAREN T PIPE</td> <td>1.500</td> <td>M</td> </tr> <tr> <td>VH1220A1</td> <td>4,2X12 TCB SELF-TAPPIN G SCREW</td> <td>4</td> <td>PZ</td> </tr> <tr> <td>VH1895A0</td> <td>BLIND NUT M4 STAINLESS STEEL DIN 917</td> <td>8</td> <td>PZ</td> </tr> <tr> <td>VH1945A0</td> <td>ENG-VITE M4X20 TCB+ INOX</td> <td>8</td> <td>PZ</td> </tr> <tr> <td>VH1950A0</td> <td>ST. STEEL 4,2X13 TCB SELF-DRILLIN G SCREW</td> <td>26</td> <td>PZ</td> </tr> <tr> <td>VL1005A1</td> <td>U-TRAP TANK</td> <td>2</td> <td>PZ</td> </tr> <tr> <td>VL1006A0</td> <td>SYPHON COVER</td> <td>2</td> <td>PZ</td> </tr> <tr> <td>VL1043A0</td> <td>D4 PIPE HOLDER - D6 J.G. TERMINAL</td> <td>3</td> <td>PZ</td> </tr> <tr> <td>VL1046A1</td> <td>D6 PIPE HOLDER - D6 J.G. TERMINAL</td> <td>3</td> <td>PZ</td> </tr> </tbody> </table>	Code	Description	Qty	UOM	EL1020A1	D8 INTERMEDIAT E T-SHAPED FITTING	2	PZ	GN1508A0	O-RING GASKET COD 2400	2	PZ	PD1069A0	FOOT OVERLAP S5 CT-BT-E	1	PZ	RC1008A0	D9 ELASTIC CLIP	3	PZ	RC1055A0	Ø25-40 H12 STAINLESS STEEL PIPE CLIP	14	PZ	RC1130A0	130X2,6 CLAM	3	PZ	RC1297A1	D10 T-SHAPED FITTING	1	PZ	RC1376A0	Ø6 Y-FITTING	1	PZ	TB1520A0	INT. Ø=38 TH=4 DRAIN BLACK RUBBER PIPE	3	M	TB1765A1	STACKING KIT CHIMNEY CONNECTING PIPE	1	PZ	TB2243A0	D10 PE TRANSPAREN T PIPE	1.500	M	VH1220A1	4,2X12 TCB SELF-TAPPIN G SCREW	4	PZ	VH1895A0	BLIND NUT M4 STAINLESS STEEL DIN 917	8	PZ	VH1945A0	ENG-VITE M4X20 TCB+ INOX	8	PZ	VH1950A0	ST. STEEL 4,2X13 TCB SELF-DRILLIN G SCREW	26	PZ	VL1005A1	U-TRAP TANK	2	PZ	VL1006A0	SYPHON COVER	2	PZ	VL1043A0	D4 PIPE HOLDER - D6 J.G. TERMINAL	3	PZ	VL1046A1	D6 PIPE HOLDER - D6 J.G. TERMINAL	3	PZ
Code	Description	Qty	UOM																																																																																		
EL1020A1	D8 INTERMEDIAT E T-SHAPED FITTING	2	PZ																																																																																		
GN1508A0	O-RING GASKET COD 2400	2	PZ																																																																																		
PD1069A0	FOOT OVERLAP S5 CT-BT-E	1	PZ																																																																																		
RC1008A0	D9 ELASTIC CLIP	3	PZ																																																																																		
RC1055A0	Ø25-40 H12 STAINLESS STEEL PIPE CLIP	14	PZ																																																																																		
RC1130A0	130X2,6 CLAM	3	PZ																																																																																		
RC1297A1	D10 T-SHAPED FITTING	1	PZ																																																																																		
RC1376A0	Ø6 Y-FITTING	1	PZ																																																																																		
TB1520A0	INT. Ø=38 TH=4 DRAIN BLACK RUBBER PIPE	3	M																																																																																		
TB1765A1	STACKING KIT CHIMNEY CONNECTING PIPE	1	PZ																																																																																		
TB2243A0	D10 PE TRANSPAREN T PIPE	1.500	M																																																																																		
VH1220A1	4,2X12 TCB SELF-TAPPIN G SCREW	4	PZ																																																																																		
VH1895A0	BLIND NUT M4 STAINLESS STEEL DIN 917	8	PZ																																																																																		
VH1945A0	ENG-VITE M4X20 TCB+ INOX	8	PZ																																																																																		
VH1950A0	ST. STEEL 4,2X13 TCB SELF-DRILLIN G SCREW	26	PZ																																																																																		
VL1005A1	U-TRAP TANK	2	PZ																																																																																		
VL1006A0	SYPHON COVER	2	PZ																																																																																		
VL1043A0	D4 PIPE HOLDER - D6 J.G. TERMINAL	3	PZ																																																																																		
VL1046A1	D6 PIPE HOLDER - D6 J.G. TERMINAL	3	PZ																																																																																		

COMPONENT			SPARE PART																																																																			
Code	Description	Image	Code	Description	Components list																																																																	
VL1005A	U-TRAP TANK		XC756	E SERIES GN 2/3 STACKING KIT	<table border="1"> <thead> <tr> <th>Code</th> <th>Description</th> <th>Qty</th> <th>UOM</th> </tr> </thead> <tbody> <tr> <td>VM1015A1</td> <td>STAINLESS STEEL Ø30X1.5 90° BEND</td> <td>1</td> <td>PZ</td> </tr> <tr> <td>VM1794A0</td> <td>250X4.8 PA66 BLACK CLAMP</td> <td>3</td> <td>PZ</td> </tr> <tr> <td>VM1987A0</td> <td>OVEN STACKING BRACKET</td> <td>1</td> <td>PZ</td> </tr> <tr> <td>VM2035A0</td> <td>DRAIN PIPE SUPPORT</td> <td>1</td> <td>PZ</td> </tr> </tbody> </table>	Code	Description	Qty	UOM	VM1015A1	STAINLESS STEEL Ø30X1.5 90° BEND	1	PZ	VM1794A0	250X4.8 PA66 BLACK CLAMP	3	PZ	VM1987A0	OVEN STACKING BRACKET	1	PZ	VM2035A0	DRAIN PIPE SUPPORT	1	PZ																																													
			Code	Description	Qty	UOM																																																																
VM1015A1	STAINLESS STEEL Ø30X1.5 90° BEND	1	PZ																																																																			
VM1794A0	250X4.8 PA66 BLACK CLAMP	3	PZ																																																																			
VM1987A0	OVEN STACKING BRACKET	1	PZ																																																																			
VM2035A0	DRAIN PIPE SUPPORT	1	PZ																																																																			
XC755	E SERIES BT-CT GN 2/1 STACKING KIT	<table border="1"> <thead> <tr> <th>Code</th> <th>Description</th> <th>Qty</th> <th>UOM</th> </tr> </thead> <tbody> <tr> <td>0H6461A0</td> <td>XC755 FRONT PROFILE</td> <td>1</td> <td>PZ</td> </tr> <tr> <td>CE1635A0</td> <td>RJ45 - RJ45 CABLE L=3M</td> <td>1</td> <td>PZ</td> </tr> <tr> <td>ED1246A0</td> <td>HOT SURFACE LABEL</td> <td>2</td> <td>PZ</td> </tr> <tr> <td>ED1271A0</td> <td>LIQUID FALLS DANGER LABE</td> <td>1</td> <td>PZ</td> </tr> <tr> <td>EL1020A1</td> <td>D8 INTERMEDIAT E T-SHAPED FITTING</td> <td>2</td> <td>PZ</td> </tr> <tr> <td>GN1508A0</td> <td>O-RING GASKET COD 2400</td> <td>2</td> <td>PZ</td> </tr> <tr> <td>PD1069A0</td> <td>FOOT OVERLAP S5 CT-BT-E</td> <td>1</td> <td>PZ</td> </tr> <tr> <td>RC1008A0</td> <td>D9 ELASTIC CLIP</td> <td>3</td> <td>PZ</td> </tr> <tr> <td>RC1055A0</td> <td>Ø25-40 H12 STAINLESS STEEL PIPE CLIP</td> <td>14</td> <td>PZ</td> </tr> <tr> <td>RC1130A0</td> <td>130X2,6 CLAM</td> <td>3</td> <td>PZ</td> </tr> <tr> <td>RC1297A1</td> <td>D10 T-SHAPED FITTING</td> <td>1</td> <td>PZ</td> </tr> <tr> <td>RC1376A0</td> <td>Ø6 Y-FITTING</td> <td>1</td> <td>PZ</td> </tr> <tr> <td>TB1520A0</td> <td>INT. Ø=38 TH=4 DRAIN BLACK RUBBER PIPE</td> <td>5</td> <td>M</td> </tr> <tr> <td>TB1765A1</td> <td>STACKING KIT CHIMNEY CONNECTING PIPE</td> <td>2</td> <td>PZ</td> </tr> <tr> <td>TB2243A0</td> <td>D10 PE TRANSPAREN T PIPE</td> <td>1.500</td> <td>M</td> </tr> <tr> <td>VI1220A1</td> <td>4,2X12 TCB SELF-TAPPIN G SCREW</td> <td>4</td> <td>PZ</td> </tr> </tbody> </table>	Code	Description	Qty	UOM	0H6461A0	XC755 FRONT PROFILE	1	PZ	CE1635A0	RJ45 - RJ45 CABLE L=3M	1	PZ	ED1246A0	HOT SURFACE LABEL	2	PZ	ED1271A0	LIQUID FALLS DANGER LABE	1	PZ	EL1020A1	D8 INTERMEDIAT E T-SHAPED FITTING	2	PZ	GN1508A0	O-RING GASKET COD 2400	2	PZ	PD1069A0	FOOT OVERLAP S5 CT-BT-E	1	PZ	RC1008A0	D9 ELASTIC CLIP	3	PZ	RC1055A0	Ø25-40 H12 STAINLESS STEEL PIPE CLIP	14	PZ	RC1130A0	130X2,6 CLAM	3	PZ	RC1297A1	D10 T-SHAPED FITTING	1	PZ	RC1376A0	Ø6 Y-FITTING	1	PZ	TB1520A0	INT. Ø=38 TH=4 DRAIN BLACK RUBBER PIPE	5	M	TB1765A1	STACKING KIT CHIMNEY CONNECTING PIPE	2	PZ	TB2243A0	D10 PE TRANSPAREN T PIPE	1.500	M	VI1220A1	4,2X12 TCB SELF-TAPPIN G SCREW	4	PZ
Code	Description	Qty	UOM																																																																			
0H6461A0	XC755 FRONT PROFILE	1	PZ																																																																			
CE1635A0	RJ45 - RJ45 CABLE L=3M	1	PZ																																																																			
ED1246A0	HOT SURFACE LABEL	2	PZ																																																																			
ED1271A0	LIQUID FALLS DANGER LABE	1	PZ																																																																			
EL1020A1	D8 INTERMEDIAT E T-SHAPED FITTING	2	PZ																																																																			
GN1508A0	O-RING GASKET COD 2400	2	PZ																																																																			
PD1069A0	FOOT OVERLAP S5 CT-BT-E	1	PZ																																																																			
RC1008A0	D9 ELASTIC CLIP	3	PZ																																																																			
RC1055A0	Ø25-40 H12 STAINLESS STEEL PIPE CLIP	14	PZ																																																																			
RC1130A0	130X2,6 CLAM	3	PZ																																																																			
RC1297A1	D10 T-SHAPED FITTING	1	PZ																																																																			
RC1376A0	Ø6 Y-FITTING	1	PZ																																																																			
TB1520A0	INT. Ø=38 TH=4 DRAIN BLACK RUBBER PIPE	5	M																																																																			
TB1765A1	STACKING KIT CHIMNEY CONNECTING PIPE	2	PZ																																																																			
TB2243A0	D10 PE TRANSPAREN T PIPE	1.500	M																																																																			
VI1220A1	4,2X12 TCB SELF-TAPPIN G SCREW	4	PZ																																																																			

COMPONENT			SPARE PART																																																																																					
Code	Description	Image	Code	Description	Components list																																																																																			
VL1005A	U-TRAP TANK		XC755	E SERIES BT-CT GN 2/1 STACKING KIT	<table border="1"> <thead> <tr> <th>Code</th> <th>Description</th> <th>Qty</th> <th>UOM</th> </tr> </thead> <tbody> <tr> <td>VI1895A0</td> <td>BLIND NUT M4 STAINLESS STEEL DIN 917</td> <td>8</td> <td>PZ</td> </tr> <tr> <td>VI1945A0</td> <td>ENG-VITE M4X20 TCB+ INOX</td> <td>8</td> <td>PZ</td> </tr> <tr> <td>VI1950A0</td> <td>ST. STEEL 4,2X13 TCB SELF-DRILLIN G SCREW</td> <td>26</td> <td>PZ</td> </tr> <tr> <td>VL1005A1</td> <td>U-TRAP TANK</td> <td>2</td> <td>PZ</td> </tr> <tr> <td>VL1006A0</td> <td>SYPHON COVER</td> <td>2</td> <td>PZ</td> </tr> <tr> <td>VL1043A0</td> <td>D4 PIPE HOLDER - D6 J.G. TERMINAL</td> <td>3</td> <td>PZ</td> </tr> <tr> <td>VL1046A1</td> <td>D6 PIPE HOLDER - D6 J.G. TERMINAL</td> <td>3</td> <td>PZ</td> </tr> <tr> <td>VM1015A1</td> <td>STAINLESS STEEL Ø30X1.5 90° BEND</td> <td>1</td> <td>PZ</td> </tr> <tr> <td>VM1794A0</td> <td>250X4.8 PA66 BLACK CLAMP</td> <td>3</td> <td>PZ</td> </tr> <tr> <td>VM1987A0</td> <td>OVEN STACKING BRACKET</td> <td>1</td> <td>PZ</td> </tr> <tr> <td>VM2035A0</td> <td>DRAIN PIPE SUPPORT</td> <td>2</td> <td>PZ</td> </tr> </tbody> </table>	Code	Description	Qty	UOM	VI1895A0	BLIND NUT M4 STAINLESS STEEL DIN 917	8	PZ	VI1945A0	ENG-VITE M4X20 TCB+ INOX	8	PZ	VI1950A0	ST. STEEL 4,2X13 TCB SELF-DRILLIN G SCREW	26	PZ	VL1005A1	U-TRAP TANK	2	PZ	VL1006A0	SYPHON COVER	2	PZ	VL1043A0	D4 PIPE HOLDER - D6 J.G. TERMINAL	3	PZ	VL1046A1	D6 PIPE HOLDER - D6 J.G. TERMINAL	3	PZ	VM1015A1	STAINLESS STEEL Ø30X1.5 90° BEND	1	PZ	VM1794A0	250X4.8 PA66 BLACK CLAMP	3	PZ	VM1987A0	OVEN STACKING BRACKET	1	PZ	VM2035A0	DRAIN PIPE SUPPORT	2	PZ	XC699	LINEMISS TOP FIRST INSTALLATION KIT	<table border="1"> <thead> <tr> <th>Code</th> <th>Description</th> <th>Qty</th> <th>UOM</th> </tr> </thead> <tbody> <tr> <td>0H1237A0</td> <td>LM TOP SIPHON SUPPORT</td> <td>1</td> <td>PZ</td> </tr> <tr> <td>GN1508A0</td> <td>O-RING GASKET COD 2400</td> <td>1</td> <td>PZ</td> </tr> <tr> <td>RC1055A0</td> <td>Ø25-40 H12 STAINLESS STEEL PIPE CLIP</td> <td>4</td> <td>PZ</td> </tr> <tr> <td>TB1520A0</td> <td>INT. Ø=38 TH=4 DRAIN BLACK RUBBER PIPE</td> <td>2.500</td> <td>M</td> </tr> <tr> <td>VI1220A1</td> <td>4,2X12 TCB SELF-TAPPIN G SCREW</td> <td>2</td> <td>PZ</td> </tr> <tr> <td>VI1895A0</td> <td>BLIND NUT M4 STAINLESS STEEL DIN 917</td> <td>4</td> <td>PZ</td> </tr> <tr> <td>VI1945A0</td> <td>ENG-VITE M4X20 TCB+ INOX</td> <td>4</td> <td>PZ</td> </tr> </tbody> </table>	Code	Description	Qty	UOM	0H1237A0	LM TOP SIPHON SUPPORT	1	PZ	GN1508A0	O-RING GASKET COD 2400	1	PZ	RC1055A0	Ø25-40 H12 STAINLESS STEEL PIPE CLIP	4	PZ	TB1520A0	INT. Ø=38 TH=4 DRAIN BLACK RUBBER PIPE	2.500	M	VI1220A1	4,2X12 TCB SELF-TAPPIN G SCREW	2	PZ	VI1895A0	BLIND NUT M4 STAINLESS STEEL DIN 917	4	PZ	VI1945A0	ENG-VITE M4X20 TCB+ INOX	4	PZ
			Code	Description	Qty	UOM																																																																																		
VI1895A0	BLIND NUT M4 STAINLESS STEEL DIN 917	8	PZ																																																																																					
VI1945A0	ENG-VITE M4X20 TCB+ INOX	8	PZ																																																																																					
VI1950A0	ST. STEEL 4,2X13 TCB SELF-DRILLIN G SCREW	26	PZ																																																																																					
VL1005A1	U-TRAP TANK	2	PZ																																																																																					
VL1006A0	SYPHON COVER	2	PZ																																																																																					
VL1043A0	D4 PIPE HOLDER - D6 J.G. TERMINAL	3	PZ																																																																																					
VL1046A1	D6 PIPE HOLDER - D6 J.G. TERMINAL	3	PZ																																																																																					
VM1015A1	STAINLESS STEEL Ø30X1.5 90° BEND	1	PZ																																																																																					
VM1794A0	250X4.8 PA66 BLACK CLAMP	3	PZ																																																																																					
VM1987A0	OVEN STACKING BRACKET	1	PZ																																																																																					
VM2035A0	DRAIN PIPE SUPPORT	2	PZ																																																																																					
Code	Description	Qty	UOM																																																																																					
0H1237A0	LM TOP SIPHON SUPPORT	1	PZ																																																																																					
GN1508A0	O-RING GASKET COD 2400	1	PZ																																																																																					
RC1055A0	Ø25-40 H12 STAINLESS STEEL PIPE CLIP	4	PZ																																																																																					
TB1520A0	INT. Ø=38 TH=4 DRAIN BLACK RUBBER PIPE	2.500	M																																																																																					
VI1220A1	4,2X12 TCB SELF-TAPPIN G SCREW	2	PZ																																																																																					
VI1895A0	BLIND NUT M4 STAINLESS STEEL DIN 917	4	PZ																																																																																					
VI1945A0	ENG-VITE M4X20 TCB+ INOX	4	PZ																																																																																					

COMPONENT			SPARE PART																																							
Code	Description	Image	Code	Description	Components list																																					
VL1005A	U-TRAP TANK		XC699	LINEMISS TOP FIRST INSTALLATION KIT	<table border="1"> <thead> <tr> <th>Code</th> <th>Description</th> <th>Qty</th> <th>UOM</th> </tr> </thead> <tbody> <tr> <td>VI1950A0</td> <td>ST. STEEL 4.2X13 TCB SELF-DRILLIN G SCREW</td> <td>2</td> <td>PZ</td> </tr> <tr> <td>VL1005A1</td> <td>U-TRAP TANK</td> <td>1</td> <td>PZ</td> </tr> <tr> <td>VL1006A0</td> <td>SYPHON COVER</td> <td>1</td> <td>PZ</td> </tr> <tr> <td>VM1015A1</td> <td>STAINLESS STEEL Ø30X1.5 90° BEND</td> <td>1</td> <td>PZ</td> </tr> </tbody> </table>	Code	Description	Qty	UOM	VI1950A0	ST. STEEL 4.2X13 TCB SELF-DRILLIN G SCREW	2	PZ	VL1005A1	U-TRAP TANK	1	PZ	VL1006A0	SYPHON COVER	1	PZ	VM1015A1	STAINLESS STEEL Ø30X1.5 90° BEND	1	PZ																	
			Code	Description	Qty	UOM																																				
			VI1950A0	ST. STEEL 4.2X13 TCB SELF-DRILLIN G SCREW	2	PZ																																				
VL1005A1	U-TRAP TANK	1	PZ																																							
VL1006A0	SYPHON COVER	1	PZ																																							
VM1015A1	STAINLESS STEEL Ø30X1.5 90° BEND	1	PZ																																							
XC673	COMPLETE P-TRAP KIT	<table border="1"> <thead> <tr> <th>Code</th> <th>Description</th> <th>Qty</th> <th>UOM</th> </tr> </thead> <tbody> <tr> <td>GN1508A0</td> <td>O-RING GASKET COD 2400</td> <td>1</td> <td>PZ</td> </tr> <tr> <td>RC1055A0</td> <td>Ø25-40 H12 STAINLESS STEEL PIPE CLIP</td> <td>2</td> <td>PZ</td> </tr> <tr> <td>TB1520A0</td> <td>INT. Ø=38 TH=4 DRAIN BLACK RUBBER PIPE</td> <td>0.050</td> <td>M</td> </tr> <tr> <td>VI1220A1</td> <td>4.2X12 TCB SELF-TAPPIN G SCREW</td> <td>2</td> <td>PZ</td> </tr> <tr> <td>VI1895A0</td> <td>BLIND NUT M4 STAINLESS STEEL DIN 917</td> <td>4</td> <td>PZ</td> </tr> <tr> <td>VI1945A0</td> <td>ENG-VITE M4X20 TCB+ INOX</td> <td>4</td> <td>PZ</td> </tr> <tr> <td>VI1950A0</td> <td>ST. STEEL 4.2X13 TCB SELF-DRILLIN G SCREW</td> <td>2</td> <td>PZ</td> </tr> <tr> <td>VL1005A1</td> <td>U-TRAP TANK</td> <td>1</td> <td>PZ</td> </tr> <tr> <td>VL1006A0</td> <td>SYPHON COVER</td> <td>1</td> <td>PZ</td> </tr> </tbody> </table>	Code	Description	Qty	UOM	GN1508A0	O-RING GASKET COD 2400	1	PZ	RC1055A0	Ø25-40 H12 STAINLESS STEEL PIPE CLIP	2	PZ	TB1520A0	INT. Ø=38 TH=4 DRAIN BLACK RUBBER PIPE	0.050	M	VI1220A1	4.2X12 TCB SELF-TAPPIN G SCREW	2	PZ	VI1895A0	BLIND NUT M4 STAINLESS STEEL DIN 917	4	PZ	VI1945A0	ENG-VITE M4X20 TCB+ INOX	4	PZ	VI1950A0	ST. STEEL 4.2X13 TCB SELF-DRILLIN G SCREW	2	PZ	VL1005A1	U-TRAP TANK	1	PZ	VL1006A0	SYPHON COVER	1	PZ
Code	Description	Qty	UOM																																							
GN1508A0	O-RING GASKET COD 2400	1	PZ																																							
RC1055A0	Ø25-40 H12 STAINLESS STEEL PIPE CLIP	2	PZ																																							
TB1520A0	INT. Ø=38 TH=4 DRAIN BLACK RUBBER PIPE	0.050	M																																							
VI1220A1	4.2X12 TCB SELF-TAPPIN G SCREW	2	PZ																																							
VI1895A0	BLIND NUT M4 STAINLESS STEEL DIN 917	4	PZ																																							
VI1945A0	ENG-VITE M4X20 TCB+ INOX	4	PZ																																							
VI1950A0	ST. STEEL 4.2X13 TCB SELF-DRILLIN G SCREW	2	PZ																																							
VL1005A1	U-TRAP TANK	1	PZ																																							
VL1006A0	SYPHON COVER	1	PZ																																							
XC653	LINEMISSTOP XFT140 STACKING KIT	<table border="1"> <thead> <tr> <th>Code</th> <th>Description</th> <th>Qty</th> <th>UOM</th> </tr> </thead> <tbody> <tr> <td>0H1237A0</td> <td>LM TOP SIPHON SUPPORT</td> <td>2</td> <td>PZ</td> </tr> <tr> <td>0H7084A0</td> <td>XC651 FRONT STACKING PROFILE</td> <td>1</td> <td>PZ</td> </tr> <tr> <td>0H7085A0</td> <td>LM 600 XC STACKING KIT BACK PROFIL</td> <td>2</td> <td>PZ</td> </tr> <tr> <td>ED1246A0</td> <td>HOT SURFACE LABEL</td> <td>1</td> <td>PZ</td> </tr> <tr> <td>ED1271A0</td> <td>LIQUID FALLS DANGER LABE</td> <td>1</td> <td>PZ</td> </tr> </tbody> </table>	Code	Description	Qty	UOM	0H1237A0	LM TOP SIPHON SUPPORT	2	PZ	0H7084A0	XC651 FRONT STACKING PROFILE	1	PZ	0H7085A0	LM 600 XC STACKING KIT BACK PROFIL	2	PZ	ED1246A0	HOT SURFACE LABEL	1	PZ	ED1271A0	LIQUID FALLS DANGER LABE	1	PZ																
Code	Description	Qty	UOM																																							
0H1237A0	LM TOP SIPHON SUPPORT	2	PZ																																							
0H7084A0	XC651 FRONT STACKING PROFILE	1	PZ																																							
0H7085A0	LM 600 XC STACKING KIT BACK PROFIL	2	PZ																																							
ED1246A0	HOT SURFACE LABEL	1	PZ																																							
ED1271A0	LIQUID FALLS DANGER LABE	1	PZ																																							

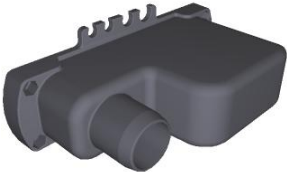

COMPONENT			SPARE PART																																																																																		
Code	Description	Image	Code	Description	Components list																																																																																
VL1005A	U-TRAP TANK		XC653	LINEMISSTOP XFT140 STACKING KIT	<table border="1"> <thead> <tr> <th>Code</th> <th>Description</th> <th>Qty</th> <th>UOM</th> </tr> </thead> <tbody> <tr> <td>EL1020A1</td> <td>D8 INTERMEDIAT E T-SHAPED FITTING</td> <td>2</td> <td>PZ</td> </tr> <tr> <td>EL1180A0</td> <td>Ø8-Ø8 FEMALE NON-RETURN CONNECTION</td> <td>2</td> <td>PZ</td> </tr> <tr> <td>GN1508A0</td> <td>O-RING GASKET COD 2400</td> <td>2</td> <td>PZ</td> </tr> <tr> <td>RC1008A0</td> <td>D9 ELASTIC CLIP</td> <td>7</td> <td>PZ</td> </tr> <tr> <td>RC1055A0</td> <td>Ø25-40 H12 STAINLESS STEEL PIPE CLIP</td> <td>10</td> <td>PZ</td> </tr> <tr> <td>RC1297A1</td> <td>D10 T-SHAPED FITTING</td> <td>1</td> <td>PZ</td> </tr> <tr> <td>RC1360A0</td> <td>10 - 10 JG ELBOW FITTIN</td> <td>1</td> <td>PZ</td> </tr> <tr> <td>RC1376A0</td> <td>Ø6 Y-FITTING</td> <td>1</td> <td>PZ</td> </tr> <tr> <td>TB1177A0</td> <td>FOOT PANEL 40X40 H58 OVERLAP LM</td> <td>4</td> <td>PZ</td> </tr> <tr> <td>TB1520A0</td> <td>INT. Ø=38 TH=4 DRAIN BLACK RUBBER PIPE</td> <td>2.700</td> <td>M</td> </tr> <tr> <td>TB1815A0</td> <td>7,93X4,75 PE TRANSP. PIPE (JG #PE08100N)</td> <td>2</td> <td>M</td> </tr> <tr> <td>TB2243A0</td> <td>D10 PE TRANSPAREN T PIPE</td> <td>1.500</td> <td>M</td> </tr> <tr> <td>VI1220A1</td> <td>4,2X12 TCB SELF-TAPPIN G SCREW</td> <td>16</td> <td>PZ</td> </tr> <tr> <td>VI1895A0</td> <td>BLIND NUT M4 STAINLESS STEEL DIN 917</td> <td>8</td> <td>PZ</td> </tr> <tr> <td>VI1945A0</td> <td>ENG-VITE M4X20 TCB+ INOX</td> <td>8</td> <td>PZ</td> </tr> <tr> <td>VI1950A0</td> <td>ST. STEEL 4,2X13 TCB SELF-DRILLIN G SCREW</td> <td>10</td> <td>PZ</td> </tr> <tr> <td>VL1005A1</td> <td>U-TRAP TANK</td> <td>2</td> <td>PZ</td> </tr> <tr> <td>VL1006A0</td> <td>SYPHON COVER</td> <td>2</td> <td>PZ</td> </tr> <tr> <td>VL1046A1</td> <td>D6 PIPE HOLDER - D6 J.G. TERMINAL</td> <td>6</td> <td>PZ</td> </tr> </tbody> </table>	Code	Description	Qty	UOM	EL1020A1	D8 INTERMEDIAT E T-SHAPED FITTING	2	PZ	EL1180A0	Ø8-Ø8 FEMALE NON-RETURN CONNECTION	2	PZ	GN1508A0	O-RING GASKET COD 2400	2	PZ	RC1008A0	D9 ELASTIC CLIP	7	PZ	RC1055A0	Ø25-40 H12 STAINLESS STEEL PIPE CLIP	10	PZ	RC1297A1	D10 T-SHAPED FITTING	1	PZ	RC1360A0	10 - 10 JG ELBOW FITTIN	1	PZ	RC1376A0	Ø6 Y-FITTING	1	PZ	TB1177A0	FOOT PANEL 40X40 H58 OVERLAP LM	4	PZ	TB1520A0	INT. Ø=38 TH=4 DRAIN BLACK RUBBER PIPE	2.700	M	TB1815A0	7,93X4,75 PE TRANSP. PIPE (JG #PE08100N)	2	M	TB2243A0	D10 PE TRANSPAREN T PIPE	1.500	M	VI1220A1	4,2X12 TCB SELF-TAPPIN G SCREW	16	PZ	VI1895A0	BLIND NUT M4 STAINLESS STEEL DIN 917	8	PZ	VI1945A0	ENG-VITE M4X20 TCB+ INOX	8	PZ	VI1950A0	ST. STEEL 4,2X13 TCB SELF-DRILLIN G SCREW	10	PZ	VL1005A1	U-TRAP TANK	2	PZ	VL1006A0	SYPHON COVER	2	PZ	VL1046A1	D6 PIPE HOLDER - D6 J.G. TERMINAL	6	PZ
Code	Description	Qty	UOM																																																																																		
EL1020A1	D8 INTERMEDIAT E T-SHAPED FITTING	2	PZ																																																																																		
EL1180A0	Ø8-Ø8 FEMALE NON-RETURN CONNECTION	2	PZ																																																																																		
GN1508A0	O-RING GASKET COD 2400	2	PZ																																																																																		
RC1008A0	D9 ELASTIC CLIP	7	PZ																																																																																		
RC1055A0	Ø25-40 H12 STAINLESS STEEL PIPE CLIP	10	PZ																																																																																		
RC1297A1	D10 T-SHAPED FITTING	1	PZ																																																																																		
RC1360A0	10 - 10 JG ELBOW FITTIN	1	PZ																																																																																		
RC1376A0	Ø6 Y-FITTING	1	PZ																																																																																		
TB1177A0	FOOT PANEL 40X40 H58 OVERLAP LM	4	PZ																																																																																		
TB1520A0	INT. Ø=38 TH=4 DRAIN BLACK RUBBER PIPE	2.700	M																																																																																		
TB1815A0	7,93X4,75 PE TRANSP. PIPE (JG #PE08100N)	2	M																																																																																		
TB2243A0	D10 PE TRANSPAREN T PIPE	1.500	M																																																																																		
VI1220A1	4,2X12 TCB SELF-TAPPIN G SCREW	16	PZ																																																																																		
VI1895A0	BLIND NUT M4 STAINLESS STEEL DIN 917	8	PZ																																																																																		
VI1945A0	ENG-VITE M4X20 TCB+ INOX	8	PZ																																																																																		
VI1950A0	ST. STEEL 4,2X13 TCB SELF-DRILLIN G SCREW	10	PZ																																																																																		
VL1005A1	U-TRAP TANK	2	PZ																																																																																		
VL1006A0	SYPHON COVER	2	PZ																																																																																		
VL1046A1	D6 PIPE HOLDER - D6 J.G. TERMINAL	6	PZ																																																																																		





COMPONENT			SPARE PART																																																											
Code	Description	Image	Code	Description	Components list																																																									
VL1005A	U-TRAP TANK		XC653	LINEMISSTOP XFT140 STACKING KIT	<table border="1"> <thead> <tr> <th>Code</th> <th>Description</th> <th>Qty</th> <th>UOM</th> </tr> </thead> <tbody> <tr> <td>VL1047A1</td> <td>D6 PIPE HOLDER - D8 J.G. TERMINAL</td> <td>2</td> <td>PZ</td> </tr> <tr> <td>VM1015A1</td> <td>STAINLESS STEEL Ø30X1.5 90° BEND</td> <td>1</td> <td>PZ</td> </tr> <tr> <td>VM1794A0</td> <td>250X4.8 PA66 BLACK CLAMP</td> <td>2</td> <td>PZ</td> </tr> <tr> <td>VM2035A0</td> <td>DRAIN PIPE SUPPORT</td> <td>1</td> <td>PZ</td> </tr> </tbody> </table>	Code	Description	Qty	UOM	VL1047A1	D6 PIPE HOLDER - D8 J.G. TERMINAL	2	PZ	VM1015A1	STAINLESS STEEL Ø30X1.5 90° BEND	1	PZ	VM1794A0	250X4.8 PA66 BLACK CLAMP	2	PZ	VM2035A0	DRAIN PIPE SUPPORT	1	PZ																																					
			Code	Description	Qty	UOM																																																								
VL1047A1	D6 PIPE HOLDER - D8 J.G. TERMINAL	2	PZ																																																											
VM1015A1	STAINLESS STEEL Ø30X1.5 90° BEND	1	PZ																																																											
VM1794A0	250X4.8 PA66 BLACK CLAMP	2	PZ																																																											
VM2035A0	DRAIN PIPE SUPPORT	1	PZ																																																											
XC649	LINEMISS TOP FULL SIZE STACKING KIT	<table border="1"> <thead> <tr> <th>Code</th> <th>Description</th> <th>Qty</th> <th>UOM</th> </tr> </thead> <tbody> <tr> <td>0H1151A0</td> <td>PROOFER-OV EN FIXING BRACKET</td> <td>4</td> <td>PZ</td> </tr> <tr> <td>0H1237A0</td> <td>LM TOP SIPHON SUPPORT</td> <td>2</td> <td>PZ</td> </tr> <tr> <td>ED1335A0</td> <td>CAUTION HOT TRIANGLE LABEL</td> <td>1</td> <td>PZ</td> </tr> <tr> <td>ED1338A0</td> <td>UL LIQUID FALLS DANGER LABE</td> <td>1</td> <td>PZ</td> </tr> <tr> <td>EL1020A1</td> <td>D8 INTERMEDIAT E T-SHAPED FITTING</td> <td>2</td> <td>PZ</td> </tr> <tr> <td>EL1185A0</td> <td>Ø8F - Ø8F ELBOW CONNECTION</td> <td>2</td> <td>PZ</td> </tr> <tr> <td>GN1508A0</td> <td>O-RING GASKET COD 2400</td> <td>2</td> <td>PZ</td> </tr> <tr> <td>RC1008A0</td> <td>D9 ELASTIC CLIP</td> <td>3</td> <td>PZ</td> </tr> <tr> <td>RC1055A0</td> <td>Ø25-40 H12 STAINLESS STEEL PIPE CLIP</td> <td>8</td> <td>PZ</td> </tr> <tr> <td>RC1297A1</td> <td>D10 T-SHAPED FITTING</td> <td>1</td> <td>PZ</td> </tr> <tr> <td>RC1360A0</td> <td>10 - 10 JG ELBOW FITTIN</td> <td>1</td> <td>PZ</td> </tr> <tr> <td>RC1376A0</td> <td>Ø6 Y-FITTING</td> <td>1</td> <td>PZ</td> </tr> <tr> <td>TB1520A0</td> <td>INT. Ø=38 TH=4 DRAIN BLACK RUBBER PIPE</td> <td>2.840</td> <td>M</td> </tr> <tr> <td>TB1815A0</td> <td>7,93X4,75 PE TRANSP. PIPE (JG #PE08100N)</td> <td>2</td> <td>M</td> </tr> </tbody> </table>	Code	Description	Qty	UOM	0H1151A0	PROOFER-OV EN FIXING BRACKET	4	PZ	0H1237A0	LM TOP SIPHON SUPPORT	2	PZ	ED1335A0	CAUTION HOT TRIANGLE LABEL	1	PZ	ED1338A0	UL LIQUID FALLS DANGER LABE	1	PZ	EL1020A1	D8 INTERMEDIAT E T-SHAPED FITTING	2	PZ	EL1185A0	Ø8F - Ø8F ELBOW CONNECTION	2	PZ	GN1508A0	O-RING GASKET COD 2400	2	PZ	RC1008A0	D9 ELASTIC CLIP	3	PZ	RC1055A0	Ø25-40 H12 STAINLESS STEEL PIPE CLIP	8	PZ	RC1297A1	D10 T-SHAPED FITTING	1	PZ	RC1360A0	10 - 10 JG ELBOW FITTIN	1	PZ	RC1376A0	Ø6 Y-FITTING	1	PZ	TB1520A0	INT. Ø=38 TH=4 DRAIN BLACK RUBBER PIPE	2.840	M	TB1815A0	7,93X4,75 PE TRANSP. PIPE (JG #PE08100N)	2	M
Code	Description	Qty	UOM																																																											
0H1151A0	PROOFER-OV EN FIXING BRACKET	4	PZ																																																											
0H1237A0	LM TOP SIPHON SUPPORT	2	PZ																																																											
ED1335A0	CAUTION HOT TRIANGLE LABEL	1	PZ																																																											
ED1338A0	UL LIQUID FALLS DANGER LABE	1	PZ																																																											
EL1020A1	D8 INTERMEDIAT E T-SHAPED FITTING	2	PZ																																																											
EL1185A0	Ø8F - Ø8F ELBOW CONNECTION	2	PZ																																																											
GN1508A0	O-RING GASKET COD 2400	2	PZ																																																											
RC1008A0	D9 ELASTIC CLIP	3	PZ																																																											
RC1055A0	Ø25-40 H12 STAINLESS STEEL PIPE CLIP	8	PZ																																																											
RC1297A1	D10 T-SHAPED FITTING	1	PZ																																																											
RC1360A0	10 - 10 JG ELBOW FITTIN	1	PZ																																																											
RC1376A0	Ø6 Y-FITTING	1	PZ																																																											
TB1520A0	INT. Ø=38 TH=4 DRAIN BLACK RUBBER PIPE	2.840	M																																																											
TB1815A0	7,93X4,75 PE TRANSP. PIPE (JG #PE08100N)	2	M																																																											



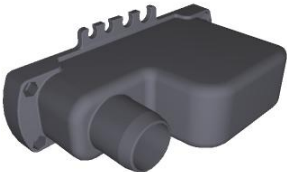

COMPONENT			SPARE PART																																														
Code	Description	Image	Code	Description	Components list																																												
VL1005A	U-TRAP TANK		XC649	LINEMISS TOP FULL SIZE STACKING KIT	<table border="1"> <thead> <tr> <th>Code</th> <th>Description</th> <th>Qty</th> <th>UOM</th> </tr> </thead> <tbody> <tr> <td>TB2243A0</td> <td>D10 PE TRANSPARENT PIPE</td> <td>1.500</td> <td>M</td> </tr> <tr> <td>VI1220A1</td> <td>4,2X12 TCB SELF-TAPPING SCREW</td> <td>7</td> <td>PZ</td> </tr> <tr> <td>VI1895A0</td> <td>BLIND NUT M4 STAINLESS STEEL DIN 917</td> <td>8</td> <td>PZ</td> </tr> <tr> <td>VI1945A0</td> <td>ENG-VITE M4X20 TCB+ INOX</td> <td>8</td> <td>PZ</td> </tr> <tr> <td>VI1950A0</td> <td>ST. STEEL 4,2X13 TCB SELF-DRILLING SCREW</td> <td>6</td> <td>PZ</td> </tr> <tr> <td>VL1005A1</td> <td>U-TRAP TANK COVER</td> <td>2</td> <td>PZ</td> </tr> <tr> <td>VL1006A0</td> <td>SYPHON COVER</td> <td>2</td> <td>PZ</td> </tr> <tr> <td>VL1046A1</td> <td>D6 PIPE HOLDER - D6 J.G. TERMINAL</td> <td>3</td> <td>PZ</td> </tr> <tr> <td>VM1794A0</td> <td>250X4.8 PA66 BLACK CLAMP</td> <td>2</td> <td>PZ</td> </tr> <tr> <td>VM2035A0</td> <td>DRAIN PIPE SUPPORT</td> <td>1</td> <td>PZ</td> </tr> </tbody> </table>	Code	Description	Qty	UOM	TB2243A0	D10 PE TRANSPARENT PIPE	1.500	M	VI1220A1	4,2X12 TCB SELF-TAPPING SCREW	7	PZ	VI1895A0	BLIND NUT M4 STAINLESS STEEL DIN 917	8	PZ	VI1945A0	ENG-VITE M4X20 TCB+ INOX	8	PZ	VI1950A0	ST. STEEL 4,2X13 TCB SELF-DRILLING SCREW	6	PZ	VL1005A1	U-TRAP TANK COVER	2	PZ	VL1006A0	SYPHON COVER	2	PZ	VL1046A1	D6 PIPE HOLDER - D6 J.G. TERMINAL	3	PZ	VM1794A0	250X4.8 PA66 BLACK CLAMP	2	PZ	VM2035A0	DRAIN PIPE SUPPORT	1	PZ
			Code	Description	Qty	UOM																																											
TB2243A0	D10 PE TRANSPARENT PIPE	1.500	M																																														
VI1220A1	4,2X12 TCB SELF-TAPPING SCREW	7	PZ																																														
VI1895A0	BLIND NUT M4 STAINLESS STEEL DIN 917	8	PZ																																														
VI1945A0	ENG-VITE M4X20 TCB+ INOX	8	PZ																																														
VI1950A0	ST. STEEL 4,2X13 TCB SELF-DRILLING SCREW	6	PZ																																														
VL1005A1	U-TRAP TANK COVER	2	PZ																																														
VL1006A0	SYPHON COVER	2	PZ																																														
VL1046A1	D6 PIPE HOLDER - D6 J.G. TERMINAL	3	PZ																																														
VM1794A0	250X4.8 PA66 BLACK CLAMP	2	PZ																																														
VM2035A0	DRAIN PIPE SUPPORT	1	PZ																																														
XC648	LINEMISS TOP XFT200 STACKING KIT	<table border="1"> <thead> <tr> <th>Code</th> <th>Description</th> <th>Qty</th> <th>UOM</th> </tr> </thead> <tbody> <tr> <td>0H1237A0</td> <td>LM TOP SIPHON SUPPORT</td> <td>2</td> <td>PZ</td> </tr> <tr> <td>0H7082A0</td> <td>LM 800 XC STACKING KIT FRONT PROFILE</td> <td>1</td> <td>PZ</td> </tr> <tr> <td>0H7083A0</td> <td>LM 800 XC STACKING KIT BACK PROFIL</td> <td>2</td> <td>PZ</td> </tr> <tr> <td>ED1246A0</td> <td>HOT SURFACE LABEL</td> <td>1</td> <td>PZ</td> </tr> <tr> <td>ED1271A0</td> <td>LIQUID FALLS DANGER LABEL</td> <td>1</td> <td>PZ</td> </tr> <tr> <td>EL1020A1</td> <td>D8 INTERMEDIATE T-SHAPED FITTING</td> <td>2</td> <td>PZ</td> </tr> <tr> <td>EL1180A0</td> <td>Ø8-Ø8 FEMALE NON-RETURN CONNECTION</td> <td>2</td> <td>PZ</td> </tr> <tr> <td>GN1508A0</td> <td>O-RING GASKET COD 2400</td> <td>2</td> <td>PZ</td> </tr> <tr> <td>RC1008A0</td> <td>D9 ELASTIC CLIP</td> <td>7</td> <td>PZ</td> </tr> </tbody> </table>	Code	Description	Qty	UOM	0H1237A0	LM TOP SIPHON SUPPORT	2	PZ	0H7082A0	LM 800 XC STACKING KIT FRONT PROFILE	1	PZ	0H7083A0	LM 800 XC STACKING KIT BACK PROFIL	2	PZ	ED1246A0	HOT SURFACE LABEL	1	PZ	ED1271A0	LIQUID FALLS DANGER LABEL	1	PZ	EL1020A1	D8 INTERMEDIATE T-SHAPED FITTING	2	PZ	EL1180A0	Ø8-Ø8 FEMALE NON-RETURN CONNECTION	2	PZ	GN1508A0	O-RING GASKET COD 2400	2	PZ	RC1008A0	D9 ELASTIC CLIP	7	PZ							
Code	Description	Qty	UOM																																														
0H1237A0	LM TOP SIPHON SUPPORT	2	PZ																																														
0H7082A0	LM 800 XC STACKING KIT FRONT PROFILE	1	PZ																																														
0H7083A0	LM 800 XC STACKING KIT BACK PROFIL	2	PZ																																														
ED1246A0	HOT SURFACE LABEL	1	PZ																																														
ED1271A0	LIQUID FALLS DANGER LABEL	1	PZ																																														
EL1020A1	D8 INTERMEDIATE T-SHAPED FITTING	2	PZ																																														
EL1180A0	Ø8-Ø8 FEMALE NON-RETURN CONNECTION	2	PZ																																														
GN1508A0	O-RING GASKET COD 2400	2	PZ																																														
RC1008A0	D9 ELASTIC CLIP	7	PZ																																														

COMPONENT			SPARE PART																																																																																		
Code	Description	Image	Code	Description	Components list																																																																																
VL1005A	U-TRAP TANK		XC648	LINEMISS TOP XFT200 STACKING KIT	<table border="1"> <thead> <tr> <th>Code</th> <th>Description</th> <th>Qty</th> <th>UOM</th> </tr> </thead> <tbody> <tr> <td>RC1055A0</td> <td>Ø25-40 H12 STAINLESS STEEL PIPE CLIP</td> <td>10</td> <td>PZ</td> </tr> <tr> <td>RC1297A1</td> <td>D10 T-SHAPED FITTING</td> <td>1</td> <td>PZ</td> </tr> <tr> <td>RC1360A0</td> <td>10 - 10 JG ELBOW FITTING</td> <td>1</td> <td>PZ</td> </tr> <tr> <td>RC1376A0</td> <td>Ø6 Y-FITTING</td> <td>1</td> <td>PZ</td> </tr> <tr> <td>TB1177A0</td> <td>FOOT PANEL 40X40 H58 OVERLAP LM</td> <td>4</td> <td>PZ</td> </tr> <tr> <td>TB1520A0</td> <td>INT. Ø=38 TH=4 DRAIN BLACK RUBBER PIPE</td> <td>2.700</td> <td>M</td> </tr> <tr> <td>TB1815A0</td> <td>7,93X4,75 PE TRANSP. PIPE (JG #PE08100N)</td> <td>2</td> <td>M</td> </tr> <tr> <td>TB2243A0</td> <td>D10 PE TRANSPAREN T PIPE</td> <td>1.500</td> <td>M</td> </tr> <tr> <td>VI1220A1</td> <td>4,2X12 TCB SELF-TAPPIN G SCREW</td> <td>16</td> <td>PZ</td> </tr> <tr> <td>VI1895A0</td> <td>BLIND NUT M4 STAINLESS STEEL DIN 917</td> <td>8</td> <td>PZ</td> </tr> <tr> <td>VI1945A0</td> <td>ENG-VITE M4X20 TCB+ INOX</td> <td>8</td> <td>PZ</td> </tr> <tr> <td>VI1950A0</td> <td>ST. STEEL 4,2X13 TCB SELF-DRILLIN G SCREW</td> <td>10</td> <td>PZ</td> </tr> <tr> <td>VL1005A1</td> <td>U-TRAP TANK</td> <td>2</td> <td>PZ</td> </tr> <tr> <td>VL1006A0</td> <td>SYPHON COVER</td> <td>2</td> <td>PZ</td> </tr> <tr> <td>VL1046A1</td> <td>D6 PIPE HOLDER - D6 J.G. TERMINAL</td> <td>6</td> <td>PZ</td> </tr> <tr> <td>VL1047A1</td> <td>D6 PIPE HOLDER - D8 J.G. TERMINAL</td> <td>4</td> <td>PZ</td> </tr> <tr> <td>VM1015A1</td> <td>STAINLESS STEEL Ø30X1.5 90° BEND</td> <td>1</td> <td>PZ</td> </tr> <tr> <td>VM1794A0</td> <td>250X4.8 PA66 BLACK CLAMP</td> <td>2</td> <td>PZ</td> </tr> <tr> <td>VM2035A0</td> <td>DRAIN PIPE SUPPORT</td> <td>1</td> <td>PZ</td> </tr> </tbody> </table>	Code	Description	Qty	UOM	RC1055A0	Ø25-40 H12 STAINLESS STEEL PIPE CLIP	10	PZ	RC1297A1	D10 T-SHAPED FITTING	1	PZ	RC1360A0	10 - 10 JG ELBOW FITTING	1	PZ	RC1376A0	Ø6 Y-FITTING	1	PZ	TB1177A0	FOOT PANEL 40X40 H58 OVERLAP LM	4	PZ	TB1520A0	INT. Ø=38 TH=4 DRAIN BLACK RUBBER PIPE	2.700	M	TB1815A0	7,93X4,75 PE TRANSP. PIPE (JG #PE08100N)	2	M	TB2243A0	D10 PE TRANSPAREN T PIPE	1.500	M	VI1220A1	4,2X12 TCB SELF-TAPPIN G SCREW	16	PZ	VI1895A0	BLIND NUT M4 STAINLESS STEEL DIN 917	8	PZ	VI1945A0	ENG-VITE M4X20 TCB+ INOX	8	PZ	VI1950A0	ST. STEEL 4,2X13 TCB SELF-DRILLIN G SCREW	10	PZ	VL1005A1	U-TRAP TANK	2	PZ	VL1006A0	SYPHON COVER	2	PZ	VL1046A1	D6 PIPE HOLDER - D6 J.G. TERMINAL	6	PZ	VL1047A1	D6 PIPE HOLDER - D8 J.G. TERMINAL	4	PZ	VM1015A1	STAINLESS STEEL Ø30X1.5 90° BEND	1	PZ	VM1794A0	250X4.8 PA66 BLACK CLAMP	2	PZ	VM2035A0	DRAIN PIPE SUPPORT	1	PZ
Code	Description	Qty	UOM																																																																																		
RC1055A0	Ø25-40 H12 STAINLESS STEEL PIPE CLIP	10	PZ																																																																																		
RC1297A1	D10 T-SHAPED FITTING	1	PZ																																																																																		
RC1360A0	10 - 10 JG ELBOW FITTING	1	PZ																																																																																		
RC1376A0	Ø6 Y-FITTING	1	PZ																																																																																		
TB1177A0	FOOT PANEL 40X40 H58 OVERLAP LM	4	PZ																																																																																		
TB1520A0	INT. Ø=38 TH=4 DRAIN BLACK RUBBER PIPE	2.700	M																																																																																		
TB1815A0	7,93X4,75 PE TRANSP. PIPE (JG #PE08100N)	2	M																																																																																		
TB2243A0	D10 PE TRANSPAREN T PIPE	1.500	M																																																																																		
VI1220A1	4,2X12 TCB SELF-TAPPIN G SCREW	16	PZ																																																																																		
VI1895A0	BLIND NUT M4 STAINLESS STEEL DIN 917	8	PZ																																																																																		
VI1945A0	ENG-VITE M4X20 TCB+ INOX	8	PZ																																																																																		
VI1950A0	ST. STEEL 4,2X13 TCB SELF-DRILLIN G SCREW	10	PZ																																																																																		
VL1005A1	U-TRAP TANK	2	PZ																																																																																		
VL1006A0	SYPHON COVER	2	PZ																																																																																		
VL1046A1	D6 PIPE HOLDER - D6 J.G. TERMINAL	6	PZ																																																																																		
VL1047A1	D6 PIPE HOLDER - D8 J.G. TERMINAL	4	PZ																																																																																		
VM1015A1	STAINLESS STEEL Ø30X1.5 90° BEND	1	PZ																																																																																		
VM1794A0	250X4.8 PA66 BLACK CLAMP	2	PZ																																																																																		
VM2035A0	DRAIN PIPE SUPPORT	1	PZ																																																																																		

COMPONENT			SPARE PART																																																														
Code	Description	Image	Code	Description	Components list																																																												
VL1005A	U-TRAP TANK		KVL1005A	5 /5E SERIES U-TRAP KIT	<table border="1"> <thead> <tr> <th>Code</th> <th>Description</th> <th>Qty</th> <th>UOM</th> </tr> </thead> <tbody> <tr> <td>GN1508A0</td> <td>O-RING GASKET COD 2400</td> <td>1</td> <td>PZ</td> </tr> <tr> <td>VI1895A0</td> <td>BLIND NUT M4 STAINLESS STEEL DIN 917</td> <td>4</td> <td>PZ</td> </tr> <tr> <td>VI1945A0</td> <td>ENG-VITE M4X20 TCB+ INOX</td> <td>4</td> <td>PZ</td> </tr> <tr> <td>VL1005A1</td> <td>U-TRAP TANK</td> <td>1</td> <td>PZ</td> </tr> <tr> <td>VL1006A0</td> <td>SYPHON COVER</td> <td>1</td> <td>PZ</td> </tr> </tbody> </table>	Code	Description	Qty	UOM	GN1508A0	O-RING GASKET COD 2400	1	PZ	VI1895A0	BLIND NUT M4 STAINLESS STEEL DIN 917	4	PZ	VI1945A0	ENG-VITE M4X20 TCB+ INOX	4	PZ	VL1005A1	U-TRAP TANK	1	PZ	VL1006A0	SYPHON COVER	1	PZ																																				
Code	Description	Qty	UOM																																																														
GN1508A0	O-RING GASKET COD 2400	1	PZ																																																														
VI1895A0	BLIND NUT M4 STAINLESS STEEL DIN 917	4	PZ																																																														
VI1945A0	ENG-VITE M4X20 TCB+ INOX	4	PZ																																																														
VL1005A1	U-TRAP TANK	1	PZ																																																														
VL1006A0	SYPHON COVER	1	PZ																																																														
VL1006A	SYPHON COVER		XUC001	SINGLE UNIT INSTALLATION KIT	<table border="1"> <thead> <tr> <th>Code</th> <th>Description</th> <th>Qty</th> <th>UOM</th> </tr> </thead> <tbody> <tr> <td>0H6567A0</td> <td>P-TRAP HOLDING BRACKET</td> <td>1</td> <td>PZ</td> </tr> <tr> <td>GN1400A0</td> <td>U-TRAP SEAL</td> <td>1</td> <td>PZ</td> </tr> <tr> <td>GN1508A0</td> <td>O-RING GASKET COD 2400</td> <td>1</td> <td>PZ</td> </tr> <tr> <td>IL1115A0</td> <td>WOODEN PALET 80X120</td> <td>0.100</td> <td>PZ</td> </tr> <tr> <td>RC1055A0</td> <td>Ø25-40 H12 STAINLESS STEEL PIPE CLIP</td> <td>3</td> <td>PZ</td> </tr> <tr> <td>TB1520A0</td> <td>INT. Ø=38 TH=4 DRAIN BLACK RUBBER PIPE</td> <td>2.500</td> <td>M</td> </tr> <tr> <td>VI1220A1</td> <td>4,2X12 TCB SELF-TAPPIN G SCREW</td> <td>2</td> <td>PZ</td> </tr> <tr> <td>VI1895A0</td> <td>BLIND NUT M4 STAINLESS STEEL DIN 917</td> <td>4</td> <td>PZ</td> </tr> <tr> <td>VI1945A0</td> <td>ENG-VITE M4X20 TCB+ INOX</td> <td>4</td> <td>PZ</td> </tr> <tr> <td>VI1950A0</td> <td>ST. STEEL 4,2X13 TCB SELF-DRILLIN G SCREW</td> <td>2</td> <td>PZ</td> </tr> <tr> <td>VL1005A1</td> <td>U-TRAP TANK</td> <td>1</td> <td>PZ</td> </tr> <tr> <td>VL1006A0</td> <td>SYPHON COVER</td> <td>1</td> <td>PZ</td> </tr> <tr> <td>VL1026A0</td> <td>BEND FOR DRAIN PIPE</td> <td>1</td> <td>PZ</td> </tr> <tr> <td>VM1015A1</td> <td>STAINLESS STEEL Ø30X1.5 90° BEND</td> <td>1</td> <td>PZ</td> </tr> </tbody> </table>	Code	Description	Qty	UOM	0H6567A0	P-TRAP HOLDING BRACKET	1	PZ	GN1400A0	U-TRAP SEAL	1	PZ	GN1508A0	O-RING GASKET COD 2400	1	PZ	IL1115A0	WOODEN PALET 80X120	0.100	PZ	RC1055A0	Ø25-40 H12 STAINLESS STEEL PIPE CLIP	3	PZ	TB1520A0	INT. Ø=38 TH=4 DRAIN BLACK RUBBER PIPE	2.500	M	VI1220A1	4,2X12 TCB SELF-TAPPIN G SCREW	2	PZ	VI1895A0	BLIND NUT M4 STAINLESS STEEL DIN 917	4	PZ	VI1945A0	ENG-VITE M4X20 TCB+ INOX	4	PZ	VI1950A0	ST. STEEL 4,2X13 TCB SELF-DRILLIN G SCREW	2	PZ	VL1005A1	U-TRAP TANK	1	PZ	VL1006A0	SYPHON COVER	1	PZ	VL1026A0	BEND FOR DRAIN PIPE	1	PZ	VM1015A1	STAINLESS STEEL Ø30X1.5 90° BEND	1	PZ
Code	Description	Qty	UOM																																																														
0H6567A0	P-TRAP HOLDING BRACKET	1	PZ																																																														
GN1400A0	U-TRAP SEAL	1	PZ																																																														
GN1508A0	O-RING GASKET COD 2400	1	PZ																																																														
IL1115A0	WOODEN PALET 80X120	0.100	PZ																																																														
RC1055A0	Ø25-40 H12 STAINLESS STEEL PIPE CLIP	3	PZ																																																														
TB1520A0	INT. Ø=38 TH=4 DRAIN BLACK RUBBER PIPE	2.500	M																																																														
VI1220A1	4,2X12 TCB SELF-TAPPIN G SCREW	2	PZ																																																														
VI1895A0	BLIND NUT M4 STAINLESS STEEL DIN 917	4	PZ																																																														
VI1945A0	ENG-VITE M4X20 TCB+ INOX	4	PZ																																																														
VI1950A0	ST. STEEL 4,2X13 TCB SELF-DRILLIN G SCREW	2	PZ																																																														
VL1005A1	U-TRAP TANK	1	PZ																																																														
VL1006A0	SYPHON COVER	1	PZ																																																														
VL1026A0	BEND FOR DRAIN PIPE	1	PZ																																																														
VM1015A1	STAINLESS STEEL Ø30X1.5 90° BEND	1	PZ																																																														

COMPONENT			SPARE PART																																																																														
Code	Description	Image	Code	Description	Components list																																																																												
VL1006A	SYPHON COVER		XC761	3 OVENS LM TOP XFT200 STACKING KIT	<table border="1"> <thead> <tr> <th>Code</th> <th>Description</th> <th>Qty</th> <th>UOM</th> </tr> </thead> <tbody> <tr> <td>0H1237A0</td> <td>LM TOP SIPHON SUPPORT</td> <td>3</td> <td>PZ</td> </tr> <tr> <td>0H7082A0</td> <td>LM 800 XC STACKING KIT FRONT PROFILE</td> <td>2</td> <td>PZ</td> </tr> <tr> <td>0H7083A0</td> <td>LM 800 XC STACKING KIT BACK PROFIL</td> <td>4</td> <td>PZ</td> </tr> <tr> <td>ED1246A0</td> <td>HOT SURFACE LABEL</td> <td>1</td> <td>PZ</td> </tr> <tr> <td>ED1271A0</td> <td>LIQUID FALLS DANGER LABE</td> <td>1</td> <td>PZ</td> </tr> <tr> <td>EL1020A1</td> <td>D8 INTERMEDIAT E T-SHAPED FITTING</td> <td>4</td> <td>PZ</td> </tr> <tr> <td>EL1180A0</td> <td>Ø8-Ø8 FEMALE NON-RETURN CONNECTION</td> <td>3</td> <td>PZ</td> </tr> <tr> <td>GN1508A0</td> <td>O-RING GASKET COD 2400</td> <td>3</td> <td>PZ</td> </tr> <tr> <td>RC1008A0</td> <td>D9 ELASTIC CLIP</td> <td>12</td> <td>PZ</td> </tr> <tr> <td>RC1055A0</td> <td>Ø25-40 H12 STAINLESS STEEL PIPE CLIP</td> <td>15</td> <td>PZ</td> </tr> <tr> <td>RC1297A1</td> <td>D10 T-SHAPED FITTING</td> <td>2</td> <td>PZ</td> </tr> <tr> <td>RC1360A0</td> <td>10 - 10 JG ELBOW FITTIN</td> <td>1</td> <td>PZ</td> </tr> <tr> <td>RC1376A0</td> <td>Ø6 Y-FITTING</td> <td>2</td> <td>PZ</td> </tr> <tr> <td>TB1177A0</td> <td>FOOT PANEL 40X40 H58 OVERLAP LM</td> <td>8</td> <td>PZ</td> </tr> <tr> <td>TB1520A0</td> <td>INT. Ø=38 TH=4 DRAIN BLACK RUBBER PIPE</td> <td>5</td> <td>M</td> </tr> <tr> <td>TB1815A0</td> <td>7,93X4,75 PE TRANSP. PIPE (JG #PE08100N)</td> <td>12</td> <td>M</td> </tr> <tr> <td>TB1816A0</td> <td>CLEAR POLYPROPYL ENE PIPE 6X4MM</td> <td>3</td> <td>M</td> </tr> <tr> <td>TB2243A0</td> <td>D10 PE TRANSPAREN T PIPE</td> <td>4</td> <td>M</td> </tr> </tbody> </table>	Code	Description	Qty	UOM	0H1237A0	LM TOP SIPHON SUPPORT	3	PZ	0H7082A0	LM 800 XC STACKING KIT FRONT PROFILE	2	PZ	0H7083A0	LM 800 XC STACKING KIT BACK PROFIL	4	PZ	ED1246A0	HOT SURFACE LABEL	1	PZ	ED1271A0	LIQUID FALLS DANGER LABE	1	PZ	EL1020A1	D8 INTERMEDIAT E T-SHAPED FITTING	4	PZ	EL1180A0	Ø8-Ø8 FEMALE NON-RETURN CONNECTION	3	PZ	GN1508A0	O-RING GASKET COD 2400	3	PZ	RC1008A0	D9 ELASTIC CLIP	12	PZ	RC1055A0	Ø25-40 H12 STAINLESS STEEL PIPE CLIP	15	PZ	RC1297A1	D10 T-SHAPED FITTING	2	PZ	RC1360A0	10 - 10 JG ELBOW FITTIN	1	PZ	RC1376A0	Ø6 Y-FITTING	2	PZ	TB1177A0	FOOT PANEL 40X40 H58 OVERLAP LM	8	PZ	TB1520A0	INT. Ø=38 TH=4 DRAIN BLACK RUBBER PIPE	5	M	TB1815A0	7,93X4,75 PE TRANSP. PIPE (JG #PE08100N)	12	M	TB1816A0	CLEAR POLYPROPYL ENE PIPE 6X4MM	3	M	TB2243A0	D10 PE TRANSPAREN T PIPE	4	M
Code	Description	Qty	UOM																																																																														
0H1237A0	LM TOP SIPHON SUPPORT	3	PZ																																																																														
0H7082A0	LM 800 XC STACKING KIT FRONT PROFILE	2	PZ																																																																														
0H7083A0	LM 800 XC STACKING KIT BACK PROFIL	4	PZ																																																																														
ED1246A0	HOT SURFACE LABEL	1	PZ																																																																														
ED1271A0	LIQUID FALLS DANGER LABE	1	PZ																																																																														
EL1020A1	D8 INTERMEDIAT E T-SHAPED FITTING	4	PZ																																																																														
EL1180A0	Ø8-Ø8 FEMALE NON-RETURN CONNECTION	3	PZ																																																																														
GN1508A0	O-RING GASKET COD 2400	3	PZ																																																																														
RC1008A0	D9 ELASTIC CLIP	12	PZ																																																																														
RC1055A0	Ø25-40 H12 STAINLESS STEEL PIPE CLIP	15	PZ																																																																														
RC1297A1	D10 T-SHAPED FITTING	2	PZ																																																																														
RC1360A0	10 - 10 JG ELBOW FITTIN	1	PZ																																																																														
RC1376A0	Ø6 Y-FITTING	2	PZ																																																																														
TB1177A0	FOOT PANEL 40X40 H58 OVERLAP LM	8	PZ																																																																														
TB1520A0	INT. Ø=38 TH=4 DRAIN BLACK RUBBER PIPE	5	M																																																																														
TB1815A0	7,93X4,75 PE TRANSP. PIPE (JG #PE08100N)	12	M																																																																														
TB1816A0	CLEAR POLYPROPYL ENE PIPE 6X4MM	3	M																																																																														
TB2243A0	D10 PE TRANSPAREN T PIPE	4	M																																																																														

COMPONENT			SPARE PART																																															
Code	Description	Image	Code	Description	Components list																																													
VL1006A	SYPHON COVER		XC761	3 OVENS LM TOP XFT200 STACKING KIT	<table border="1"> <thead> <tr> <th>Code</th> <th>Description</th> <th>Qty</th> <th>UOM</th> </tr> </thead> <tbody> <tr> <td>VI1220A1</td> <td>4,2X12 TCB SELF-TAPPIN G SCREW</td> <td>30</td> <td>PZ</td> </tr> <tr> <td>VI1895A0</td> <td>BLIND NUT M4 STAINLESS STEEL DIN 917</td> <td>12</td> <td>PZ</td> </tr> <tr> <td>VI1945A0</td> <td>ENG-VITE M4X20 TCB+ INOX</td> <td>12</td> <td>PZ</td> </tr> <tr> <td>VI1950A0</td> <td>ST. STEEL 4,2X13 TCB SELF-DRILLIN G SCREW</td> <td>20</td> <td>PZ</td> </tr> <tr> <td>VL1005A1</td> <td>U-TRAP TANK</td> <td>3</td> <td>PZ</td> </tr> <tr> <td>VL1006A0</td> <td>SYPHON COVER</td> <td>3</td> <td>PZ</td> </tr> <tr> <td>VL1046A1</td> <td>D6 PIPE HOLDER - D6 J.G. TERMINAL</td> <td>12</td> <td>PZ</td> </tr> <tr> <td>VM1015A1</td> <td>STAINLESS STEEL Ø30X1.5 90° BEND</td> <td>1</td> <td>PZ</td> </tr> <tr> <td>VM1794A0</td> <td>250X4.8 PA66 BLACK CLAMP</td> <td>3</td> <td>PZ</td> </tr> <tr> <td>VM2035A0</td> <td>DRAIN PIPE SUPPORT</td> <td>3</td> <td>PZ</td> </tr> </tbody> </table>	Code	Description	Qty	UOM	VI1220A1	4,2X12 TCB SELF-TAPPIN G SCREW	30	PZ	VI1895A0	BLIND NUT M4 STAINLESS STEEL DIN 917	12	PZ	VI1945A0	ENG-VITE M4X20 TCB+ INOX	12	PZ	VI1950A0	ST. STEEL 4,2X13 TCB SELF-DRILLIN G SCREW	20	PZ	VL1005A1	U-TRAP TANK	3	PZ	VL1006A0	SYPHON COVER	3	PZ	VL1046A1	D6 PIPE HOLDER - D6 J.G. TERMINAL	12	PZ	VM1015A1	STAINLESS STEEL Ø30X1.5 90° BEND	1	PZ	VM1794A0	250X4.8 PA66 BLACK CLAMP	3	PZ	VM2035A0	DRAIN PIPE SUPPORT	3	PZ	
			Code	Description	Qty	UOM																																												
VI1220A1	4,2X12 TCB SELF-TAPPIN G SCREW	30	PZ																																															
VI1895A0	BLIND NUT M4 STAINLESS STEEL DIN 917	12	PZ																																															
VI1945A0	ENG-VITE M4X20 TCB+ INOX	12	PZ																																															
VI1950A0	ST. STEEL 4,2X13 TCB SELF-DRILLIN G SCREW	20	PZ																																															
VL1005A1	U-TRAP TANK	3	PZ																																															
VL1006A0	SYPHON COVER	3	PZ																																															
VL1046A1	D6 PIPE HOLDER - D6 J.G. TERMINAL	12	PZ																																															
VM1015A1	STAINLESS STEEL Ø30X1.5 90° BEND	1	PZ																																															
VM1794A0	250X4.8 PA66 BLACK CLAMP	3	PZ																																															
VM2035A0	DRAIN PIPE SUPPORT	3	PZ																																															
XC757	S. E CHEFTOP GN1/1 STACKING KI	<table border="1"> <thead> <tr> <th>Code</th> <th>Description</th> <th>Qty</th> <th>UOM</th> </tr> </thead> <tbody> <tr> <td>0H6463A0</td> <td>XC757 FRONT PROFILE</td> <td>1</td> <td>PZ</td> </tr> <tr> <td>CE1305A0</td> <td>L=2MT RJ45 - RJ45 CABLE</td> <td>1</td> <td>PZ</td> </tr> <tr> <td>ED1246A0</td> <td>HOT SURFACE LABEL</td> <td>2</td> <td>PZ</td> </tr> <tr> <td>ED1271A0</td> <td>LIQUID FALLS DANGER LABE</td> <td>1</td> <td>PZ</td> </tr> <tr> <td>EL1020A1</td> <td>D8 INTERMEDIAT E T-SHAPED FITTING</td> <td>2</td> <td>PZ</td> </tr> <tr> <td>GN1508A0</td> <td>O-RING GASKET COD 2400</td> <td>2</td> <td>PZ</td> </tr> <tr> <td>PD1069A0</td> <td>FOOT OVERLAP S5 CT-BT-E</td> <td>1</td> <td>PZ</td> </tr> <tr> <td>RC1008A0</td> <td>D9 ELASTIC CLIP</td> <td>3</td> <td>PZ</td> </tr> <tr> <td>RC1055A0</td> <td>Ø25-40 H12 STAINLESS STEEL PIPE CLIP</td> <td>14</td> <td>PZ</td> </tr> <tr> <td>RC1130A0</td> <td>130X2,6 CLAM</td> <td>3</td> <td>PZ</td> </tr> <tr> <td>RC1297A1</td> <td>D10 T-SHAPED FITTING</td> <td>1</td> <td>PZ</td> </tr> </tbody> </table>	Code	Description	Qty	UOM	0H6463A0	XC757 FRONT PROFILE	1	PZ	CE1305A0	L=2MT RJ45 - RJ45 CABLE	1	PZ	ED1246A0	HOT SURFACE LABEL	2	PZ	ED1271A0	LIQUID FALLS DANGER LABE	1	PZ	EL1020A1	D8 INTERMEDIAT E T-SHAPED FITTING	2	PZ	GN1508A0	O-RING GASKET COD 2400	2	PZ	PD1069A0	FOOT OVERLAP S5 CT-BT-E	1	PZ	RC1008A0	D9 ELASTIC CLIP	3	PZ	RC1055A0	Ø25-40 H12 STAINLESS STEEL PIPE CLIP	14	PZ	RC1130A0	130X2,6 CLAM	3	PZ	RC1297A1	D10 T-SHAPED FITTING	1	PZ
Code	Description	Qty	UOM																																															
0H6463A0	XC757 FRONT PROFILE	1	PZ																																															
CE1305A0	L=2MT RJ45 - RJ45 CABLE	1	PZ																																															
ED1246A0	HOT SURFACE LABEL	2	PZ																																															
ED1271A0	LIQUID FALLS DANGER LABE	1	PZ																																															
EL1020A1	D8 INTERMEDIAT E T-SHAPED FITTING	2	PZ																																															
GN1508A0	O-RING GASKET COD 2400	2	PZ																																															
PD1069A0	FOOT OVERLAP S5 CT-BT-E	1	PZ																																															
RC1008A0	D9 ELASTIC CLIP	3	PZ																																															
RC1055A0	Ø25-40 H12 STAINLESS STEEL PIPE CLIP	14	PZ																																															
RC1130A0	130X2,6 CLAM	3	PZ																																															
RC1297A1	D10 T-SHAPED FITTING	1	PZ																																															

COMPONENT			SPARE PART																																																																																													
Code	Description	Image	Code	Description	Components list																																																																																											
VL1006A	SYPHON COVER		XC757	S. E CHEFTOP GN1/1 STACKING KI	<table border="1"> <thead> <tr> <th>Code</th> <th>Description</th> <th>Qty</th> <th>UOM</th> </tr> </thead> <tbody> <tr> <td>RC1376A0</td> <td>Ø6 Y-FITTING</td> <td>1</td> <td>PZ</td> </tr> <tr> <td>TB1520A0</td> <td>INT. Ø=38 TH=4 DRAIN BLACK RUBBER PIPE</td> <td>5</td> <td>M</td> </tr> <tr> <td>TB1765A1</td> <td>STACKING KIT CHIMNEY CONNECTING PIPE</td> <td>2</td> <td>PZ</td> </tr> <tr> <td>TB2243A0</td> <td>D10 PE TRANSPAREN T PIPE</td> <td>1.500</td> <td>M</td> </tr> <tr> <td>VI1220A1</td> <td>4,2X12 TCB SELF-TAPPIN G SCREW</td> <td>4</td> <td>PZ</td> </tr> <tr> <td>VI1895A0</td> <td>BLIND NUT M4 STAINLESS STEEL DIN 917</td> <td>8</td> <td>PZ</td> </tr> <tr> <td>VI1945A0</td> <td>ENG-VITE M4X20 TCB+ INOX</td> <td>8</td> <td>PZ</td> </tr> <tr> <td>VI1950A0</td> <td>ST. STEEL 4,2X13 TCB SELF-DRILLIN G SCREW</td> <td>26</td> <td>PZ</td> </tr> <tr> <td>VL1005A1</td> <td>U-TRAP TANK</td> <td>2</td> <td>PZ</td> </tr> <tr> <td>VL1006A0</td> <td>SYPHON COVER</td> <td>2</td> <td>PZ</td> </tr> <tr> <td>VL1043A0</td> <td>D4 PIPE HOLDER - D6 J.G. TERMINAL</td> <td>3</td> <td>PZ</td> </tr> <tr> <td>VL1046A1</td> <td>D6 PIPE HOLDER - D6 J.G. TERMINAL</td> <td>3</td> <td>PZ</td> </tr> <tr> <td>VM1015A1</td> <td>STAINLESS STEEL Ø30X1.5 90° BEND</td> <td>1</td> <td>PZ</td> </tr> <tr> <td>VM1794A0</td> <td>250X4.8 PA66 BLACK CLAMP</td> <td>3</td> <td>PZ</td> </tr> <tr> <td>VM1987A0</td> <td>OVEN STACKING BRACKET</td> <td>1</td> <td>PZ</td> </tr> <tr> <td>VM2035A0</td> <td>DRAIN PIPE SUPPORT</td> <td>2</td> <td>PZ</td> </tr> </tbody> </table>	Code	Description	Qty	UOM	RC1376A0	Ø6 Y-FITTING	1	PZ	TB1520A0	INT. Ø=38 TH=4 DRAIN BLACK RUBBER PIPE	5	M	TB1765A1	STACKING KIT CHIMNEY CONNECTING PIPE	2	PZ	TB2243A0	D10 PE TRANSPAREN T PIPE	1.500	M	VI1220A1	4,2X12 TCB SELF-TAPPIN G SCREW	4	PZ	VI1895A0	BLIND NUT M4 STAINLESS STEEL DIN 917	8	PZ	VI1945A0	ENG-VITE M4X20 TCB+ INOX	8	PZ	VI1950A0	ST. STEEL 4,2X13 TCB SELF-DRILLIN G SCREW	26	PZ	VL1005A1	U-TRAP TANK	2	PZ	VL1006A0	SYPHON COVER	2	PZ	VL1043A0	D4 PIPE HOLDER - D6 J.G. TERMINAL	3	PZ	VL1046A1	D6 PIPE HOLDER - D6 J.G. TERMINAL	3	PZ	VM1015A1	STAINLESS STEEL Ø30X1.5 90° BEND	1	PZ	VM1794A0	250X4.8 PA66 BLACK CLAMP	3	PZ	VM1987A0	OVEN STACKING BRACKET	1	PZ	VM2035A0	DRAIN PIPE SUPPORT	2	PZ	XC756	E SERIES GN 2/3 STACKING KIT	<table border="1"> <thead> <tr> <th>Code</th> <th>Description</th> <th>Qty</th> <th>UOM</th> </tr> </thead> <tbody> <tr> <td>0H6462A0</td> <td>XC756 FRONT PROFILE</td> <td>1</td> <td>PZ</td> </tr> <tr> <td>CE1305A0</td> <td>L=2MT RJ45 - RJ45 CABLE</td> <td>1</td> <td>PZ</td> </tr> <tr> <td>ED1246A0</td> <td>HOT SURFACE LABEL</td> <td>1</td> <td>PZ</td> </tr> <tr> <td>ED1271A0</td> <td>LIQUID FALLS DANGER LABE</td> <td>1</td> <td>PZ</td> </tr> </tbody> </table>	Code	Description	Qty	UOM	0H6462A0	XC756 FRONT PROFILE	1	PZ	CE1305A0	L=2MT RJ45 - RJ45 CABLE	1	PZ	ED1246A0	HOT SURFACE LABEL	1	PZ	ED1271A0	LIQUID FALLS DANGER LABE	1	PZ
					Code	Description	Qty	UOM																																																																																								
RC1376A0	Ø6 Y-FITTING	1			PZ																																																																																											
TB1520A0	INT. Ø=38 TH=4 DRAIN BLACK RUBBER PIPE	5			M																																																																																											
TB1765A1	STACKING KIT CHIMNEY CONNECTING PIPE	2			PZ																																																																																											
TB2243A0	D10 PE TRANSPAREN T PIPE	1.500			M																																																																																											
VI1220A1	4,2X12 TCB SELF-TAPPIN G SCREW	4			PZ																																																																																											
VI1895A0	BLIND NUT M4 STAINLESS STEEL DIN 917	8			PZ																																																																																											
VI1945A0	ENG-VITE M4X20 TCB+ INOX	8			PZ																																																																																											
VI1950A0	ST. STEEL 4,2X13 TCB SELF-DRILLIN G SCREW	26			PZ																																																																																											
VL1005A1	U-TRAP TANK	2			PZ																																																																																											
VL1006A0	SYPHON COVER	2			PZ																																																																																											
VL1043A0	D4 PIPE HOLDER - D6 J.G. TERMINAL	3			PZ																																																																																											
VL1046A1	D6 PIPE HOLDER - D6 J.G. TERMINAL	3			PZ																																																																																											
VM1015A1	STAINLESS STEEL Ø30X1.5 90° BEND	1			PZ																																																																																											
VM1794A0	250X4.8 PA66 BLACK CLAMP	3			PZ																																																																																											
VM1987A0	OVEN STACKING BRACKET	1			PZ																																																																																											
VM2035A0	DRAIN PIPE SUPPORT	2	PZ																																																																																													
Code	Description	Qty	UOM																																																																																													
0H6462A0	XC756 FRONT PROFILE	1	PZ																																																																																													
CE1305A0	L=2MT RJ45 - RJ45 CABLE	1	PZ																																																																																													
ED1246A0	HOT SURFACE LABEL	1	PZ																																																																																													
ED1271A0	LIQUID FALLS DANGER LABE	1	PZ																																																																																													

COMPONENT			SPARE PART																																																																																		
Code	Description	Image	Code	Description	Components list																																																																																
VL1006A	SYPHON COVER		XC756	E SERIES GN 2/3 STACKING KIT	<table border="1"> <thead> <tr> <th>Code</th> <th>Description</th> <th>Qty</th> <th>UOM</th> </tr> </thead> <tbody> <tr> <td>EL1020A1</td> <td>D8 INTERMEDIAT E T-SHAPED FITTING</td> <td>2</td> <td>PZ</td> </tr> <tr> <td>GN1508A0</td> <td>O-RING GASKET COD 2400</td> <td>2</td> <td>PZ</td> </tr> <tr> <td>PD1069A0</td> <td>FOOT OVERLAP S5 CT-BT-E</td> <td>1</td> <td>PZ</td> </tr> <tr> <td>RC1008A0</td> <td>D9 ELASTIC CLIP</td> <td>3</td> <td>PZ</td> </tr> <tr> <td>RC1055A0</td> <td>Ø25-40 H12 STAINLESS STEEL PIPE CLIP</td> <td>14</td> <td>PZ</td> </tr> <tr> <td>RC1130A0</td> <td>130X2,6 CLAM</td> <td>3</td> <td>PZ</td> </tr> <tr> <td>RC1297A1</td> <td>D10 T-SHAPED FITTING</td> <td>1</td> <td>PZ</td> </tr> <tr> <td>RC1376A0</td> <td>Ø6 Y-FITTING</td> <td>1</td> <td>PZ</td> </tr> <tr> <td>TB1520A0</td> <td>INT. Ø=38 TH=4 DRAIN BLACK RUBBER PIPE</td> <td>3</td> <td>M</td> </tr> <tr> <td>TB1765A1</td> <td>STACKING KIT CHIMNEY CONNECTING PIPE</td> <td>1</td> <td>PZ</td> </tr> <tr> <td>TB2243A0</td> <td>D10 PE TRANSPAREN T PIPE</td> <td>1.500</td> <td>M</td> </tr> <tr> <td>VH1220A1</td> <td>4,2X12 TCB SELF-TAPPIN G SCREW</td> <td>4</td> <td>PZ</td> </tr> <tr> <td>VH1895A0</td> <td>BLIND NUT M4 STAINLESS STEEL DIN 917</td> <td>8</td> <td>PZ</td> </tr> <tr> <td>VH1945A0</td> <td>ENG-VITE M4X20 TCB+ INOX</td> <td>8</td> <td>PZ</td> </tr> <tr> <td>VH1950A0</td> <td>ST. STEEL 4,2X13 TCB SELF-DRILLIN G SCREW</td> <td>26</td> <td>PZ</td> </tr> <tr> <td>VL1005A1</td> <td>U-TRAP TANK</td> <td>2</td> <td>PZ</td> </tr> <tr> <td>VL1006A0</td> <td>SYPHON COVER</td> <td>2</td> <td>PZ</td> </tr> <tr> <td>VL1043A0</td> <td>D4 PIPE HOLDER - D6 J.G. TERMINAL</td> <td>3</td> <td>PZ</td> </tr> <tr> <td>VL1046A1</td> <td>D6 PIPE HOLDER - D6 J.G. TERMINAL</td> <td>3</td> <td>PZ</td> </tr> </tbody> </table>	Code	Description	Qty	UOM	EL1020A1	D8 INTERMEDIAT E T-SHAPED FITTING	2	PZ	GN1508A0	O-RING GASKET COD 2400	2	PZ	PD1069A0	FOOT OVERLAP S5 CT-BT-E	1	PZ	RC1008A0	D9 ELASTIC CLIP	3	PZ	RC1055A0	Ø25-40 H12 STAINLESS STEEL PIPE CLIP	14	PZ	RC1130A0	130X2,6 CLAM	3	PZ	RC1297A1	D10 T-SHAPED FITTING	1	PZ	RC1376A0	Ø6 Y-FITTING	1	PZ	TB1520A0	INT. Ø=38 TH=4 DRAIN BLACK RUBBER PIPE	3	M	TB1765A1	STACKING KIT CHIMNEY CONNECTING PIPE	1	PZ	TB2243A0	D10 PE TRANSPAREN T PIPE	1.500	M	VH1220A1	4,2X12 TCB SELF-TAPPIN G SCREW	4	PZ	VH1895A0	BLIND NUT M4 STAINLESS STEEL DIN 917	8	PZ	VH1945A0	ENG-VITE M4X20 TCB+ INOX	8	PZ	VH1950A0	ST. STEEL 4,2X13 TCB SELF-DRILLIN G SCREW	26	PZ	VL1005A1	U-TRAP TANK	2	PZ	VL1006A0	SYPHON COVER	2	PZ	VL1043A0	D4 PIPE HOLDER - D6 J.G. TERMINAL	3	PZ	VL1046A1	D6 PIPE HOLDER - D6 J.G. TERMINAL	3	PZ
Code	Description	Qty	UOM																																																																																		
EL1020A1	D8 INTERMEDIAT E T-SHAPED FITTING	2	PZ																																																																																		
GN1508A0	O-RING GASKET COD 2400	2	PZ																																																																																		
PD1069A0	FOOT OVERLAP S5 CT-BT-E	1	PZ																																																																																		
RC1008A0	D9 ELASTIC CLIP	3	PZ																																																																																		
RC1055A0	Ø25-40 H12 STAINLESS STEEL PIPE CLIP	14	PZ																																																																																		
RC1130A0	130X2,6 CLAM	3	PZ																																																																																		
RC1297A1	D10 T-SHAPED FITTING	1	PZ																																																																																		
RC1376A0	Ø6 Y-FITTING	1	PZ																																																																																		
TB1520A0	INT. Ø=38 TH=4 DRAIN BLACK RUBBER PIPE	3	M																																																																																		
TB1765A1	STACKING KIT CHIMNEY CONNECTING PIPE	1	PZ																																																																																		
TB2243A0	D10 PE TRANSPAREN T PIPE	1.500	M																																																																																		
VH1220A1	4,2X12 TCB SELF-TAPPIN G SCREW	4	PZ																																																																																		
VH1895A0	BLIND NUT M4 STAINLESS STEEL DIN 917	8	PZ																																																																																		
VH1945A0	ENG-VITE M4X20 TCB+ INOX	8	PZ																																																																																		
VH1950A0	ST. STEEL 4,2X13 TCB SELF-DRILLIN G SCREW	26	PZ																																																																																		
VL1005A1	U-TRAP TANK	2	PZ																																																																																		
VL1006A0	SYPHON COVER	2	PZ																																																																																		
VL1043A0	D4 PIPE HOLDER - D6 J.G. TERMINAL	3	PZ																																																																																		
VL1046A1	D6 PIPE HOLDER - D6 J.G. TERMINAL	3	PZ																																																																																		

COMPONENT			SPARE PART																																																																			
Code	Description	Image	Code	Description	Components list																																																																	
VL1006A	SYPHON COVER		XC756	E SERIES GN 2/3 STACKING KIT	<table border="1"> <thead> <tr> <th>Code</th> <th>Description</th> <th>Qty</th> <th>UOM</th> </tr> </thead> <tbody> <tr> <td>VM1015A1</td> <td>STAINLESS STEEL Ø30X1.5 90° BEND</td> <td>1</td> <td>PZ</td> </tr> <tr> <td>VM1794A0</td> <td>250X4.8 PA66 BLACK CLAMP</td> <td>3</td> <td>PZ</td> </tr> <tr> <td>VM1987A0</td> <td>OVEN STACKING BRACKET</td> <td>1</td> <td>PZ</td> </tr> <tr> <td>VM2035A0</td> <td>DRAIN PIPE SUPPORT</td> <td>1</td> <td>PZ</td> </tr> </tbody> </table>	Code	Description	Qty	UOM	VM1015A1	STAINLESS STEEL Ø30X1.5 90° BEND	1	PZ	VM1794A0	250X4.8 PA66 BLACK CLAMP	3	PZ	VM1987A0	OVEN STACKING BRACKET	1	PZ	VM2035A0	DRAIN PIPE SUPPORT	1	PZ																																													
			Code	Description	Qty	UOM																																																																
VM1015A1	STAINLESS STEEL Ø30X1.5 90° BEND	1	PZ																																																																			
VM1794A0	250X4.8 PA66 BLACK CLAMP	3	PZ																																																																			
VM1987A0	OVEN STACKING BRACKET	1	PZ																																																																			
VM2035A0	DRAIN PIPE SUPPORT	1	PZ																																																																			
XC755	E SERIES BT-CT GN 2/1 STACKING KIT	<table border="1"> <thead> <tr> <th>Code</th> <th>Description</th> <th>Qty</th> <th>UOM</th> </tr> </thead> <tbody> <tr> <td>0H6461A0</td> <td>XC755 FRONT PROFILE</td> <td>1</td> <td>PZ</td> </tr> <tr> <td>CE1635A0</td> <td>RJ45 - RJ45 CABLE L=3M</td> <td>1</td> <td>PZ</td> </tr> <tr> <td>ED1246A0</td> <td>HOT SURFACE LABEL</td> <td>2</td> <td>PZ</td> </tr> <tr> <td>ED1271A0</td> <td>LIQUID FALLS DANGER LABE</td> <td>1</td> <td>PZ</td> </tr> <tr> <td>EL1020A1</td> <td>D8 INTERMEDIAT E T-SHAPED FITTING</td> <td>2</td> <td>PZ</td> </tr> <tr> <td>GN1508A0</td> <td>O-RING GASKET COD 2400</td> <td>2</td> <td>PZ</td> </tr> <tr> <td>PD1069A0</td> <td>FOOT OVERLAP S5 CT-BT-E</td> <td>1</td> <td>PZ</td> </tr> <tr> <td>RC1008A0</td> <td>D9 ELASTIC CLIP</td> <td>3</td> <td>PZ</td> </tr> <tr> <td>RC1055A0</td> <td>Ø25-40 H12 STAINLESS STEEL PIPE CLIP</td> <td>14</td> <td>PZ</td> </tr> <tr> <td>RC1130A0</td> <td>130X2,6 CLAM</td> <td>3</td> <td>PZ</td> </tr> <tr> <td>RC1297A1</td> <td>D10 T-SHAPED FITTING</td> <td>1</td> <td>PZ</td> </tr> <tr> <td>RC1376A0</td> <td>Ø6 Y-FITTING</td> <td>1</td> <td>PZ</td> </tr> <tr> <td>TB1520A0</td> <td>INT. Ø=38 TH=4 DRAIN BLACK RUBBER PIPE</td> <td>5</td> <td>M</td> </tr> <tr> <td>TB1765A1</td> <td>STACKING KIT CHIMNEY CONNECTING PIPE</td> <td>2</td> <td>PZ</td> </tr> <tr> <td>TB2243A0</td> <td>D10 PE TRANSPAREN T PIPE</td> <td>1.500</td> <td>M</td> </tr> <tr> <td>VI1220A1</td> <td>4,2X12 TCB SELF-TAPPIN G SCREW</td> <td>4</td> <td>PZ</td> </tr> </tbody> </table>	Code	Description	Qty	UOM	0H6461A0	XC755 FRONT PROFILE	1	PZ	CE1635A0	RJ45 - RJ45 CABLE L=3M	1	PZ	ED1246A0	HOT SURFACE LABEL	2	PZ	ED1271A0	LIQUID FALLS DANGER LABE	1	PZ	EL1020A1	D8 INTERMEDIAT E T-SHAPED FITTING	2	PZ	GN1508A0	O-RING GASKET COD 2400	2	PZ	PD1069A0	FOOT OVERLAP S5 CT-BT-E	1	PZ	RC1008A0	D9 ELASTIC CLIP	3	PZ	RC1055A0	Ø25-40 H12 STAINLESS STEEL PIPE CLIP	14	PZ	RC1130A0	130X2,6 CLAM	3	PZ	RC1297A1	D10 T-SHAPED FITTING	1	PZ	RC1376A0	Ø6 Y-FITTING	1	PZ	TB1520A0	INT. Ø=38 TH=4 DRAIN BLACK RUBBER PIPE	5	M	TB1765A1	STACKING KIT CHIMNEY CONNECTING PIPE	2	PZ	TB2243A0	D10 PE TRANSPAREN T PIPE	1.500	M	VI1220A1	4,2X12 TCB SELF-TAPPIN G SCREW	4	PZ
Code	Description	Qty	UOM																																																																			
0H6461A0	XC755 FRONT PROFILE	1	PZ																																																																			
CE1635A0	RJ45 - RJ45 CABLE L=3M	1	PZ																																																																			
ED1246A0	HOT SURFACE LABEL	2	PZ																																																																			
ED1271A0	LIQUID FALLS DANGER LABE	1	PZ																																																																			
EL1020A1	D8 INTERMEDIAT E T-SHAPED FITTING	2	PZ																																																																			
GN1508A0	O-RING GASKET COD 2400	2	PZ																																																																			
PD1069A0	FOOT OVERLAP S5 CT-BT-E	1	PZ																																																																			
RC1008A0	D9 ELASTIC CLIP	3	PZ																																																																			
RC1055A0	Ø25-40 H12 STAINLESS STEEL PIPE CLIP	14	PZ																																																																			
RC1130A0	130X2,6 CLAM	3	PZ																																																																			
RC1297A1	D10 T-SHAPED FITTING	1	PZ																																																																			
RC1376A0	Ø6 Y-FITTING	1	PZ																																																																			
TB1520A0	INT. Ø=38 TH=4 DRAIN BLACK RUBBER PIPE	5	M																																																																			
TB1765A1	STACKING KIT CHIMNEY CONNECTING PIPE	2	PZ																																																																			
TB2243A0	D10 PE TRANSPAREN T PIPE	1.500	M																																																																			
VI1220A1	4,2X12 TCB SELF-TAPPIN G SCREW	4	PZ																																																																			

COMPONENT			SPARE PART																																																																																					
Code	Description	Image	Code	Description	Components list																																																																																			
VL1006A	SYPHON COVER		XC755	E SERIES BT-CT GN 2/1 STACKING KIT	<table border="1"> <thead> <tr> <th>Code</th> <th>Description</th> <th>Qty</th> <th>UOM</th> </tr> </thead> <tbody> <tr> <td>VI1895A0</td> <td>BLIND NUT M4 STAINLESS STEEL DIN 917</td> <td>8</td> <td>PZ</td> </tr> <tr> <td>VI1945A0</td> <td>ENG-VITE M4X20 TCB+ INOX</td> <td>8</td> <td>PZ</td> </tr> <tr> <td>VI1950A0</td> <td>ST. STEEL 4,2X13 TCB SELF-DRILLIN G SCREW</td> <td>26</td> <td>PZ</td> </tr> <tr> <td>VL1005A1</td> <td>U-TRAP TANK</td> <td>2</td> <td>PZ</td> </tr> <tr> <td>VL1006A0</td> <td>SYPHON COVER</td> <td>2</td> <td>PZ</td> </tr> <tr> <td>VL1043A0</td> <td>D4 PIPE HOLDER - D6 J.G. TERMINAL</td> <td>3</td> <td>PZ</td> </tr> <tr> <td>VL1046A1</td> <td>D6 PIPE HOLDER - D6 J.G. TERMINAL</td> <td>3</td> <td>PZ</td> </tr> <tr> <td>VM1015A1</td> <td>STAINLESS STEEL Ø30X1.5 90° BEND</td> <td>1</td> <td>PZ</td> </tr> <tr> <td>VM1794A0</td> <td>250X4.8 PA66 BLACK CLAMP</td> <td>3</td> <td>PZ</td> </tr> <tr> <td>VM1987A0</td> <td>OVEN STACKING BRACKET</td> <td>1</td> <td>PZ</td> </tr> <tr> <td>VM2035A0</td> <td>DRAIN PIPE SUPPORT</td> <td>2</td> <td>PZ</td> </tr> </tbody> </table>	Code	Description	Qty	UOM	VI1895A0	BLIND NUT M4 STAINLESS STEEL DIN 917	8	PZ	VI1945A0	ENG-VITE M4X20 TCB+ INOX	8	PZ	VI1950A0	ST. STEEL 4,2X13 TCB SELF-DRILLIN G SCREW	26	PZ	VL1005A1	U-TRAP TANK	2	PZ	VL1006A0	SYPHON COVER	2	PZ	VL1043A0	D4 PIPE HOLDER - D6 J.G. TERMINAL	3	PZ	VL1046A1	D6 PIPE HOLDER - D6 J.G. TERMINAL	3	PZ	VM1015A1	STAINLESS STEEL Ø30X1.5 90° BEND	1	PZ	VM1794A0	250X4.8 PA66 BLACK CLAMP	3	PZ	VM1987A0	OVEN STACKING BRACKET	1	PZ	VM2035A0	DRAIN PIPE SUPPORT	2	PZ	XC699	LINEMISS TOP FIRST INSTALLATION KIT	<table border="1"> <thead> <tr> <th>Code</th> <th>Description</th> <th>Qty</th> <th>UOM</th> </tr> </thead> <tbody> <tr> <td>0H1237A0</td> <td>LM TOP SIPHON SUPPORT</td> <td>1</td> <td>PZ</td> </tr> <tr> <td>GN1508A0</td> <td>O-RING GASKET COD 2400</td> <td>1</td> <td>PZ</td> </tr> <tr> <td>RC1055A0</td> <td>Ø25-40 H12 STAINLESS STEEL PIPE CLIP</td> <td>4</td> <td>PZ</td> </tr> <tr> <td>TB1520A0</td> <td>INT. Ø=38 TH=4 DRAIN BLACK RUBBER PIPE</td> <td>2.500</td> <td>M</td> </tr> <tr> <td>VI1220A1</td> <td>4,2X12 TCB SELF-TAPPIN G SCREW</td> <td>2</td> <td>PZ</td> </tr> <tr> <td>VI1895A0</td> <td>BLIND NUT M4 STAINLESS STEEL DIN 917</td> <td>4</td> <td>PZ</td> </tr> <tr> <td>VI1945A0</td> <td>ENG-VITE M4X20 TCB+ INOX</td> <td>4</td> <td>PZ</td> </tr> </tbody> </table>	Code	Description	Qty	UOM	0H1237A0	LM TOP SIPHON SUPPORT	1	PZ	GN1508A0	O-RING GASKET COD 2400	1	PZ	RC1055A0	Ø25-40 H12 STAINLESS STEEL PIPE CLIP	4	PZ	TB1520A0	INT. Ø=38 TH=4 DRAIN BLACK RUBBER PIPE	2.500	M	VI1220A1	4,2X12 TCB SELF-TAPPIN G SCREW	2	PZ	VI1895A0	BLIND NUT M4 STAINLESS STEEL DIN 917	4	PZ	VI1945A0	ENG-VITE M4X20 TCB+ INOX	4	PZ
			Code	Description	Qty	UOM																																																																																		
VI1895A0	BLIND NUT M4 STAINLESS STEEL DIN 917	8	PZ																																																																																					
VI1945A0	ENG-VITE M4X20 TCB+ INOX	8	PZ																																																																																					
VI1950A0	ST. STEEL 4,2X13 TCB SELF-DRILLIN G SCREW	26	PZ																																																																																					
VL1005A1	U-TRAP TANK	2	PZ																																																																																					
VL1006A0	SYPHON COVER	2	PZ																																																																																					
VL1043A0	D4 PIPE HOLDER - D6 J.G. TERMINAL	3	PZ																																																																																					
VL1046A1	D6 PIPE HOLDER - D6 J.G. TERMINAL	3	PZ																																																																																					
VM1015A1	STAINLESS STEEL Ø30X1.5 90° BEND	1	PZ																																																																																					
VM1794A0	250X4.8 PA66 BLACK CLAMP	3	PZ																																																																																					
VM1987A0	OVEN STACKING BRACKET	1	PZ																																																																																					
VM2035A0	DRAIN PIPE SUPPORT	2	PZ																																																																																					
Code	Description	Qty	UOM																																																																																					
0H1237A0	LM TOP SIPHON SUPPORT	1	PZ																																																																																					
GN1508A0	O-RING GASKET COD 2400	1	PZ																																																																																					
RC1055A0	Ø25-40 H12 STAINLESS STEEL PIPE CLIP	4	PZ																																																																																					
TB1520A0	INT. Ø=38 TH=4 DRAIN BLACK RUBBER PIPE	2.500	M																																																																																					
VI1220A1	4,2X12 TCB SELF-TAPPIN G SCREW	2	PZ																																																																																					
VI1895A0	BLIND NUT M4 STAINLESS STEEL DIN 917	4	PZ																																																																																					
VI1945A0	ENG-VITE M4X20 TCB+ INOX	4	PZ																																																																																					

COMPONENT			SPARE PART																																							
Code	Description	Image	Code	Description	Components list																																					
VL1006A	SYPHON COVER		XC699	LINEMISS TOP FIRST INSTALLATION KIT	<table border="1"> <thead> <tr> <th>Code</th> <th>Description</th> <th>Qty</th> <th>UOM</th> </tr> </thead> <tbody> <tr> <td>VI1950A0</td> <td>ST. STEEL 4,2X13 TCB SELF-DRILLIN G SCREW</td> <td>2</td> <td>PZ</td> </tr> <tr> <td>VL1005A1</td> <td>U-TRAP TANK</td> <td>1</td> <td>PZ</td> </tr> <tr> <td>VL1006A0</td> <td>SYPHON COVER</td> <td>1</td> <td>PZ</td> </tr> <tr> <td>VM1015A1</td> <td>STAINLESS STEEL Ø30X1.5 90° BEND</td> <td>1</td> <td>PZ</td> </tr> </tbody> </table>	Code	Description	Qty	UOM	VI1950A0	ST. STEEL 4,2X13 TCB SELF-DRILLIN G SCREW	2	PZ	VL1005A1	U-TRAP TANK	1	PZ	VL1006A0	SYPHON COVER	1	PZ	VM1015A1	STAINLESS STEEL Ø30X1.5 90° BEND	1	PZ																	
			Code	Description	Qty	UOM																																				
			VI1950A0	ST. STEEL 4,2X13 TCB SELF-DRILLIN G SCREW	2	PZ																																				
VL1005A1	U-TRAP TANK	1	PZ																																							
VL1006A0	SYPHON COVER	1	PZ																																							
VM1015A1	STAINLESS STEEL Ø30X1.5 90° BEND	1	PZ																																							
XC673	COMPLETE P-TRAP KIT	<table border="1"> <thead> <tr> <th>Code</th> <th>Description</th> <th>Qty</th> <th>UOM</th> </tr> </thead> <tbody> <tr> <td>GN1508A0</td> <td>O-RING GASKET COD 2400</td> <td>1</td> <td>PZ</td> </tr> <tr> <td>RC1055A0</td> <td>Ø25-40 H12 STAINLESS STEEL PIPE CLIP</td> <td>2</td> <td>PZ</td> </tr> <tr> <td>TB1520A0</td> <td>INT. Ø=38 TH=4 DRAIN BLACK RUBBER PIPE</td> <td>0.050</td> <td>M</td> </tr> <tr> <td>VI1220A1</td> <td>4,2X12 TCB SELF-TAPPIN G SCREW</td> <td>2</td> <td>PZ</td> </tr> <tr> <td>VI1895A0</td> <td>BLIND NUT M4 STAINLESS STEEL DIN 917</td> <td>4</td> <td>PZ</td> </tr> <tr> <td>VI1945A0</td> <td>ENG-VITE M4X20 TCB+ INOX</td> <td>4</td> <td>PZ</td> </tr> <tr> <td>VI1950A0</td> <td>ST. STEEL 4,2X13 TCB SELF-DRILLIN G SCREW</td> <td>2</td> <td>PZ</td> </tr> <tr> <td>VL1005A1</td> <td>U-TRAP TANK</td> <td>1</td> <td>PZ</td> </tr> <tr> <td>VL1006A0</td> <td>SYPHON COVER</td> <td>1</td> <td>PZ</td> </tr> </tbody> </table>	Code	Description	Qty	UOM	GN1508A0	O-RING GASKET COD 2400	1	PZ	RC1055A0	Ø25-40 H12 STAINLESS STEEL PIPE CLIP	2	PZ	TB1520A0	INT. Ø=38 TH=4 DRAIN BLACK RUBBER PIPE	0.050	M	VI1220A1	4,2X12 TCB SELF-TAPPIN G SCREW	2	PZ	VI1895A0	BLIND NUT M4 STAINLESS STEEL DIN 917	4	PZ	VI1945A0	ENG-VITE M4X20 TCB+ INOX	4	PZ	VI1950A0	ST. STEEL 4,2X13 TCB SELF-DRILLIN G SCREW	2	PZ	VL1005A1	U-TRAP TANK	1	PZ	VL1006A0	SYPHON COVER	1	PZ
Code	Description	Qty	UOM																																							
GN1508A0	O-RING GASKET COD 2400	1	PZ																																							
RC1055A0	Ø25-40 H12 STAINLESS STEEL PIPE CLIP	2	PZ																																							
TB1520A0	INT. Ø=38 TH=4 DRAIN BLACK RUBBER PIPE	0.050	M																																							
VI1220A1	4,2X12 TCB SELF-TAPPIN G SCREW	2	PZ																																							
VI1895A0	BLIND NUT M4 STAINLESS STEEL DIN 917	4	PZ																																							
VI1945A0	ENG-VITE M4X20 TCB+ INOX	4	PZ																																							
VI1950A0	ST. STEEL 4,2X13 TCB SELF-DRILLIN G SCREW	2	PZ																																							
VL1005A1	U-TRAP TANK	1	PZ																																							
VL1006A0	SYPHON COVER	1	PZ																																							
XC653	LINEMISSTOP XFT140 STACKING KIT	<table border="1"> <thead> <tr> <th>Code</th> <th>Description</th> <th>Qty</th> <th>UOM</th> </tr> </thead> <tbody> <tr> <td>0H1237A0</td> <td>LM TOP SIPHON SUPPORT</td> <td>2</td> <td>PZ</td> </tr> <tr> <td>0H7084A0</td> <td>XC651 FRONT STACKING PROFILE</td> <td>1</td> <td>PZ</td> </tr> <tr> <td>0H7085A0</td> <td>LM 600 XC STACKING KIT BACK PROFIL</td> <td>2</td> <td>PZ</td> </tr> <tr> <td>ED1246A0</td> <td>HOT SURFACE LABEL</td> <td>1</td> <td>PZ</td> </tr> <tr> <td>ED1271A0</td> <td>LIQUID FALLS DANGER LABE</td> <td>1</td> <td>PZ</td> </tr> </tbody> </table>	Code	Description	Qty	UOM	0H1237A0	LM TOP SIPHON SUPPORT	2	PZ	0H7084A0	XC651 FRONT STACKING PROFILE	1	PZ	0H7085A0	LM 600 XC STACKING KIT BACK PROFIL	2	PZ	ED1246A0	HOT SURFACE LABEL	1	PZ	ED1271A0	LIQUID FALLS DANGER LABE	1	PZ																
Code	Description	Qty	UOM																																							
0H1237A0	LM TOP SIPHON SUPPORT	2	PZ																																							
0H7084A0	XC651 FRONT STACKING PROFILE	1	PZ																																							
0H7085A0	LM 600 XC STACKING KIT BACK PROFIL	2	PZ																																							
ED1246A0	HOT SURFACE LABEL	1	PZ																																							
ED1271A0	LIQUID FALLS DANGER LABE	1	PZ																																							







COMPONENT			SPARE PART																																																																																		
Code	Description	Image	Code	Description	Components list																																																																																
VL1006A	SYPHON COVER		XC653	LINEMISSTOP XFT140 STACKING KIT	<table border="1"> <thead> <tr> <th>Code</th> <th>Description</th> <th>Qty</th> <th>UOM</th> </tr> </thead> <tbody> <tr> <td>EL1020A1</td> <td>D8 INTERMEDIAT E T-SHAPED FITTING</td> <td>2</td> <td>PZ</td> </tr> <tr> <td>EL1180A0</td> <td>Ø8-Ø8 FEMALE NON-RETURN CONNECTION</td> <td>2</td> <td>PZ</td> </tr> <tr> <td>GN1508A0</td> <td>O-RING GASKET COD 2400</td> <td>2</td> <td>PZ</td> </tr> <tr> <td>RC1008A0</td> <td>D9 ELASTIC CLIP</td> <td>7</td> <td>PZ</td> </tr> <tr> <td>RC1055A0</td> <td>Ø25-40 H12 STAINLESS STEEL PIPE CLIP</td> <td>10</td> <td>PZ</td> </tr> <tr> <td>RC1297A1</td> <td>D10 T-SHAPED FITTING</td> <td>1</td> <td>PZ</td> </tr> <tr> <td>RC1360A0</td> <td>10 - 10 JG ELBOW FITTIN</td> <td>1</td> <td>PZ</td> </tr> <tr> <td>RC1376A0</td> <td>Ø6 Y-FITTING</td> <td>1</td> <td>PZ</td> </tr> <tr> <td>TB1177A0</td> <td>FOOT PANEL 40X40 H58 OVERLAP LM</td> <td>4</td> <td>PZ</td> </tr> <tr> <td>TB1520A0</td> <td>INT. Ø=38 TH=4 DRAIN BLACK RUBBER PIPE</td> <td>2.700</td> <td>M</td> </tr> <tr> <td>TB1815A0</td> <td>7,93X4,75 PE TRANSP. PIPE (JG #PE08100N)</td> <td>2</td> <td>M</td> </tr> <tr> <td>TB2243A0</td> <td>D10 PE TRANSPAREN T PIPE</td> <td>1.500</td> <td>M</td> </tr> <tr> <td>VI1220A1</td> <td>4,2X12 TCB SELF-TAPPIN G SCREW</td> <td>16</td> <td>PZ</td> </tr> <tr> <td>VI1895A0</td> <td>BLIND NUT M4 STAINLESS STEEL DIN 917</td> <td>8</td> <td>PZ</td> </tr> <tr> <td>VI1945A0</td> <td>ENG-VITE M4X20 TCB+ INOX</td> <td>8</td> <td>PZ</td> </tr> <tr> <td>VI1950A0</td> <td>ST. STEEL 4,2X13 TCB SELF-DRILLIN G SCREW</td> <td>10</td> <td>PZ</td> </tr> <tr> <td>VL1005A1</td> <td>U-TRAP TANK</td> <td>2</td> <td>PZ</td> </tr> <tr> <td>VL1006A0</td> <td>SYPHON COVER</td> <td>2</td> <td>PZ</td> </tr> <tr> <td>VL1046A1</td> <td>D6 PIPE HOLDER - D6 J.G. TERMINAL</td> <td>6</td> <td>PZ</td> </tr> </tbody> </table>	Code	Description	Qty	UOM	EL1020A1	D8 INTERMEDIAT E T-SHAPED FITTING	2	PZ	EL1180A0	Ø8-Ø8 FEMALE NON-RETURN CONNECTION	2	PZ	GN1508A0	O-RING GASKET COD 2400	2	PZ	RC1008A0	D9 ELASTIC CLIP	7	PZ	RC1055A0	Ø25-40 H12 STAINLESS STEEL PIPE CLIP	10	PZ	RC1297A1	D10 T-SHAPED FITTING	1	PZ	RC1360A0	10 - 10 JG ELBOW FITTIN	1	PZ	RC1376A0	Ø6 Y-FITTING	1	PZ	TB1177A0	FOOT PANEL 40X40 H58 OVERLAP LM	4	PZ	TB1520A0	INT. Ø=38 TH=4 DRAIN BLACK RUBBER PIPE	2.700	M	TB1815A0	7,93X4,75 PE TRANSP. PIPE (JG #PE08100N)	2	M	TB2243A0	D10 PE TRANSPAREN T PIPE	1.500	M	VI1220A1	4,2X12 TCB SELF-TAPPIN G SCREW	16	PZ	VI1895A0	BLIND NUT M4 STAINLESS STEEL DIN 917	8	PZ	VI1945A0	ENG-VITE M4X20 TCB+ INOX	8	PZ	VI1950A0	ST. STEEL 4,2X13 TCB SELF-DRILLIN G SCREW	10	PZ	VL1005A1	U-TRAP TANK	2	PZ	VL1006A0	SYPHON COVER	2	PZ	VL1046A1	D6 PIPE HOLDER - D6 J.G. TERMINAL	6	PZ
Code	Description	Qty	UOM																																																																																		
EL1020A1	D8 INTERMEDIAT E T-SHAPED FITTING	2	PZ																																																																																		
EL1180A0	Ø8-Ø8 FEMALE NON-RETURN CONNECTION	2	PZ																																																																																		
GN1508A0	O-RING GASKET COD 2400	2	PZ																																																																																		
RC1008A0	D9 ELASTIC CLIP	7	PZ																																																																																		
RC1055A0	Ø25-40 H12 STAINLESS STEEL PIPE CLIP	10	PZ																																																																																		
RC1297A1	D10 T-SHAPED FITTING	1	PZ																																																																																		
RC1360A0	10 - 10 JG ELBOW FITTIN	1	PZ																																																																																		
RC1376A0	Ø6 Y-FITTING	1	PZ																																																																																		
TB1177A0	FOOT PANEL 40X40 H58 OVERLAP LM	4	PZ																																																																																		
TB1520A0	INT. Ø=38 TH=4 DRAIN BLACK RUBBER PIPE	2.700	M																																																																																		
TB1815A0	7,93X4,75 PE TRANSP. PIPE (JG #PE08100N)	2	M																																																																																		
TB2243A0	D10 PE TRANSPAREN T PIPE	1.500	M																																																																																		
VI1220A1	4,2X12 TCB SELF-TAPPIN G SCREW	16	PZ																																																																																		
VI1895A0	BLIND NUT M4 STAINLESS STEEL DIN 917	8	PZ																																																																																		
VI1945A0	ENG-VITE M4X20 TCB+ INOX	8	PZ																																																																																		
VI1950A0	ST. STEEL 4,2X13 TCB SELF-DRILLIN G SCREW	10	PZ																																																																																		
VL1005A1	U-TRAP TANK	2	PZ																																																																																		
VL1006A0	SYPHON COVER	2	PZ																																																																																		
VL1046A1	D6 PIPE HOLDER - D6 J.G. TERMINAL	6	PZ																																																																																		

COMPONENT			SPARE PART																																																											
Code	Description	Image	Code	Description	Components list																																																									
VL1006A	SYPHON COVER		XC653	LINEMISSTOP XFT140 STACKING KIT	<table border="1"> <thead> <tr> <th>Code</th> <th>Description</th> <th>Qty</th> <th>UOM</th> </tr> </thead> <tbody> <tr> <td>VL1047A1</td> <td>D6 PIPE HOLDER - D8 J.G. TERMINAL</td> <td>2</td> <td>PZ</td> </tr> <tr> <td>VM1015A1</td> <td>STAINLESS STEEL Ø30X1.5 90° BEND</td> <td>1</td> <td>PZ</td> </tr> <tr> <td>VM1794A0</td> <td>250X4.8 PA66 BLACK CLAMP</td> <td>2</td> <td>PZ</td> </tr> <tr> <td>VM2035A0</td> <td>DRAIN PIPE SUPPORT</td> <td>1</td> <td>PZ</td> </tr> </tbody> </table>	Code	Description	Qty	UOM	VL1047A1	D6 PIPE HOLDER - D8 J.G. TERMINAL	2	PZ	VM1015A1	STAINLESS STEEL Ø30X1.5 90° BEND	1	PZ	VM1794A0	250X4.8 PA66 BLACK CLAMP	2	PZ	VM2035A0	DRAIN PIPE SUPPORT	1	PZ																																					
			Code	Description	Qty	UOM																																																								
VL1047A1	D6 PIPE HOLDER - D8 J.G. TERMINAL	2	PZ																																																											
VM1015A1	STAINLESS STEEL Ø30X1.5 90° BEND	1	PZ																																																											
VM1794A0	250X4.8 PA66 BLACK CLAMP	2	PZ																																																											
VM2035A0	DRAIN PIPE SUPPORT	1	PZ																																																											
XC649	LINEMISS TOP FULL SIZE STACKING KIT	<table border="1"> <thead> <tr> <th>Code</th> <th>Description</th> <th>Qty</th> <th>UOM</th> </tr> </thead> <tbody> <tr> <td>0H1151A0</td> <td>PROOFER-OV EN FIXING BRACKET</td> <td>4</td> <td>PZ</td> </tr> <tr> <td>0H1237A0</td> <td>LM TOP SIPHON SUPPORT</td> <td>2</td> <td>PZ</td> </tr> <tr> <td>ED1335A0</td> <td>CAUTION HOT TRIANGLE LABEL</td> <td>1</td> <td>PZ</td> </tr> <tr> <td>ED1338A0</td> <td>UL LIQUID FALLS DANGER LABE</td> <td>1</td> <td>PZ</td> </tr> <tr> <td>EL1020A1</td> <td>D8 INTERMEDIAT E T-SHAPED FITTING</td> <td>2</td> <td>PZ</td> </tr> <tr> <td>EL1185A0</td> <td>Ø8F - Ø8F ELBOW CONNECTION</td> <td>2</td> <td>PZ</td> </tr> <tr> <td>GN1508A0</td> <td>O-RING GASKET COD 2400</td> <td>2</td> <td>PZ</td> </tr> <tr> <td>RC1008A0</td> <td>D9 ELASTIC CLIP</td> <td>3</td> <td>PZ</td> </tr> <tr> <td>RC1055A0</td> <td>Ø25-40 H12 STAINLESS STEEL PIPE CLIP</td> <td>8</td> <td>PZ</td> </tr> <tr> <td>RC1297A1</td> <td>D10 T-SHAPED FITTING</td> <td>1</td> <td>PZ</td> </tr> <tr> <td>RC1360A0</td> <td>10 - 10 JG ELBOW FITTIN</td> <td>1</td> <td>PZ</td> </tr> <tr> <td>RC1376A0</td> <td>Ø6 Y-FITTING</td> <td>1</td> <td>PZ</td> </tr> <tr> <td>TB1520A0</td> <td>INT. Ø=38 TH=4 DRAIN BLACK RUBBER PIPE</td> <td>2.840</td> <td>M</td> </tr> <tr> <td>TB1815A0</td> <td>7,93X4,75 PE TRANSP. PIPE (JG #PE08100N)</td> <td>2</td> <td>M</td> </tr> </tbody> </table>	Code	Description	Qty	UOM	0H1151A0	PROOFER-OV EN FIXING BRACKET	4	PZ	0H1237A0	LM TOP SIPHON SUPPORT	2	PZ	ED1335A0	CAUTION HOT TRIANGLE LABEL	1	PZ	ED1338A0	UL LIQUID FALLS DANGER LABE	1	PZ	EL1020A1	D8 INTERMEDIAT E T-SHAPED FITTING	2	PZ	EL1185A0	Ø8F - Ø8F ELBOW CONNECTION	2	PZ	GN1508A0	O-RING GASKET COD 2400	2	PZ	RC1008A0	D9 ELASTIC CLIP	3	PZ	RC1055A0	Ø25-40 H12 STAINLESS STEEL PIPE CLIP	8	PZ	RC1297A1	D10 T-SHAPED FITTING	1	PZ	RC1360A0	10 - 10 JG ELBOW FITTIN	1	PZ	RC1376A0	Ø6 Y-FITTING	1	PZ	TB1520A0	INT. Ø=38 TH=4 DRAIN BLACK RUBBER PIPE	2.840	M	TB1815A0	7,93X4,75 PE TRANSP. PIPE (JG #PE08100N)	2	M
Code	Description	Qty	UOM																																																											
0H1151A0	PROOFER-OV EN FIXING BRACKET	4	PZ																																																											
0H1237A0	LM TOP SIPHON SUPPORT	2	PZ																																																											
ED1335A0	CAUTION HOT TRIANGLE LABEL	1	PZ																																																											
ED1338A0	UL LIQUID FALLS DANGER LABE	1	PZ																																																											
EL1020A1	D8 INTERMEDIAT E T-SHAPED FITTING	2	PZ																																																											
EL1185A0	Ø8F - Ø8F ELBOW CONNECTION	2	PZ																																																											
GN1508A0	O-RING GASKET COD 2400	2	PZ																																																											
RC1008A0	D9 ELASTIC CLIP	3	PZ																																																											
RC1055A0	Ø25-40 H12 STAINLESS STEEL PIPE CLIP	8	PZ																																																											
RC1297A1	D10 T-SHAPED FITTING	1	PZ																																																											
RC1360A0	10 - 10 JG ELBOW FITTIN	1	PZ																																																											
RC1376A0	Ø6 Y-FITTING	1	PZ																																																											
TB1520A0	INT. Ø=38 TH=4 DRAIN BLACK RUBBER PIPE	2.840	M																																																											
TB1815A0	7,93X4,75 PE TRANSP. PIPE (JG #PE08100N)	2	M																																																											



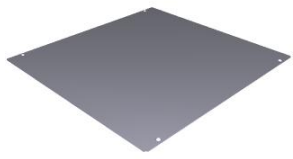

COMPONENT			SPARE PART																																														
Code	Description	Image	Code	Description	Components list																																												
VL1006A	SYPHON COVER		XC649	LINEMISS TOP FULL SIZE STACKING KIT	<table border="1"> <thead> <tr> <th>Code</th> <th>Description</th> <th>Qty</th> <th>UOM</th> </tr> </thead> <tbody> <tr> <td>TB2243A0</td> <td>D10 PE TRANSPARENT PIPE</td> <td>1.500</td> <td>M</td> </tr> <tr> <td>VI1220A1</td> <td>4,2X12 TCB SELF-TAPPING SCREW</td> <td>7</td> <td>PZ</td> </tr> <tr> <td>VI1895A0</td> <td>BLIND NUT M4 STAINLESS STEEL DIN 917</td> <td>8</td> <td>PZ</td> </tr> <tr> <td>VI1945A0</td> <td>ENG-VITE M4X20 TCB+ INOX</td> <td>8</td> <td>PZ</td> </tr> <tr> <td>VI1950A0</td> <td>ST. STEEL 4,2X13 TCB SELF-DRILLING SCREW</td> <td>6</td> <td>PZ</td> </tr> <tr> <td>VL1005A1</td> <td>U-TRAP TANK COVER</td> <td>2</td> <td>PZ</td> </tr> <tr> <td>VL1006A0</td> <td>SYPHON COVER</td> <td>2</td> <td>PZ</td> </tr> <tr> <td>VL1046A1</td> <td>D6 PIPE HOLDER - D6 J.G. TERMINAL</td> <td>3</td> <td>PZ</td> </tr> <tr> <td>VM1794A0</td> <td>250X4.8 PA66 BLACK CLAMP</td> <td>2</td> <td>PZ</td> </tr> <tr> <td>VM2035A0</td> <td>DRAIN PIPE SUPPORT</td> <td>1</td> <td>PZ</td> </tr> </tbody> </table>	Code	Description	Qty	UOM	TB2243A0	D10 PE TRANSPARENT PIPE	1.500	M	VI1220A1	4,2X12 TCB SELF-TAPPING SCREW	7	PZ	VI1895A0	BLIND NUT M4 STAINLESS STEEL DIN 917	8	PZ	VI1945A0	ENG-VITE M4X20 TCB+ INOX	8	PZ	VI1950A0	ST. STEEL 4,2X13 TCB SELF-DRILLING SCREW	6	PZ	VL1005A1	U-TRAP TANK COVER	2	PZ	VL1006A0	SYPHON COVER	2	PZ	VL1046A1	D6 PIPE HOLDER - D6 J.G. TERMINAL	3	PZ	VM1794A0	250X4.8 PA66 BLACK CLAMP	2	PZ	VM2035A0	DRAIN PIPE SUPPORT	1	PZ
			Code	Description	Qty	UOM																																											
TB2243A0	D10 PE TRANSPARENT PIPE	1.500	M																																														
VI1220A1	4,2X12 TCB SELF-TAPPING SCREW	7	PZ																																														
VI1895A0	BLIND NUT M4 STAINLESS STEEL DIN 917	8	PZ																																														
VI1945A0	ENG-VITE M4X20 TCB+ INOX	8	PZ																																														
VI1950A0	ST. STEEL 4,2X13 TCB SELF-DRILLING SCREW	6	PZ																																														
VL1005A1	U-TRAP TANK COVER	2	PZ																																														
VL1006A0	SYPHON COVER	2	PZ																																														
VL1046A1	D6 PIPE HOLDER - D6 J.G. TERMINAL	3	PZ																																														
VM1794A0	250X4.8 PA66 BLACK CLAMP	2	PZ																																														
VM2035A0	DRAIN PIPE SUPPORT	1	PZ																																														
XC648	LINEMISS TOP XFT200 STACKING KIT	<table border="1"> <thead> <tr> <th>Code</th> <th>Description</th> <th>Qty</th> <th>UOM</th> </tr> </thead> <tbody> <tr> <td>0H1237A0</td> <td>LM TOP SIPHON SUPPORT</td> <td>2</td> <td>PZ</td> </tr> <tr> <td>0H7082A0</td> <td>LM 800 XC STACKING KIT FRONT PROFILE</td> <td>1</td> <td>PZ</td> </tr> <tr> <td>0H7083A0</td> <td>LM 800 XC STACKING KIT BACK PROFIL</td> <td>2</td> <td>PZ</td> </tr> <tr> <td>ED1246A0</td> <td>HOT SURFACE LABEL</td> <td>1</td> <td>PZ</td> </tr> <tr> <td>ED1271A0</td> <td>LIQUID FALLS DANGER LABEL</td> <td>1</td> <td>PZ</td> </tr> <tr> <td>EL1020A1</td> <td>D8 INTERMEDIATE T-SHAPED FITTING</td> <td>2</td> <td>PZ</td> </tr> <tr> <td>EL1180A0</td> <td>Ø8-Ø8 FEMALE NON-RETURN CONNECTION</td> <td>2</td> <td>PZ</td> </tr> <tr> <td>GN1508A0</td> <td>O-RING GASKET COD 2400</td> <td>2</td> <td>PZ</td> </tr> <tr> <td>RC1008A0</td> <td>D9 ELASTIC CLIP</td> <td>7</td> <td>PZ</td> </tr> </tbody> </table>	Code	Description	Qty	UOM	0H1237A0	LM TOP SIPHON SUPPORT	2	PZ	0H7082A0	LM 800 XC STACKING KIT FRONT PROFILE	1	PZ	0H7083A0	LM 800 XC STACKING KIT BACK PROFIL	2	PZ	ED1246A0	HOT SURFACE LABEL	1	PZ	ED1271A0	LIQUID FALLS DANGER LABEL	1	PZ	EL1020A1	D8 INTERMEDIATE T-SHAPED FITTING	2	PZ	EL1180A0	Ø8-Ø8 FEMALE NON-RETURN CONNECTION	2	PZ	GN1508A0	O-RING GASKET COD 2400	2	PZ	RC1008A0	D9 ELASTIC CLIP	7	PZ							
Code	Description	Qty	UOM																																														
0H1237A0	LM TOP SIPHON SUPPORT	2	PZ																																														
0H7082A0	LM 800 XC STACKING KIT FRONT PROFILE	1	PZ																																														
0H7083A0	LM 800 XC STACKING KIT BACK PROFIL	2	PZ																																														
ED1246A0	HOT SURFACE LABEL	1	PZ																																														
ED1271A0	LIQUID FALLS DANGER LABEL	1	PZ																																														
EL1020A1	D8 INTERMEDIATE T-SHAPED FITTING	2	PZ																																														
EL1180A0	Ø8-Ø8 FEMALE NON-RETURN CONNECTION	2	PZ																																														
GN1508A0	O-RING GASKET COD 2400	2	PZ																																														
RC1008A0	D9 ELASTIC CLIP	7	PZ																																														

COMPONENT			SPARE PART																																																																																		
Code	Description	Image	Code	Description	Components list																																																																																
VL1006A	SYPHON COVER		XC648	LINEMISS TOP XFT200 STACKING KIT	<table border="1"> <thead> <tr> <th>Code</th> <th>Description</th> <th>Qty</th> <th>UOM</th> </tr> </thead> <tbody> <tr> <td>RC1055A0</td> <td>Ø25-40 H12 STAINLESS STEEL PIPE CLIP</td> <td>10</td> <td>PZ</td> </tr> <tr> <td>RC1297A1</td> <td>D10 T-SHAPED FITTING</td> <td>1</td> <td>PZ</td> </tr> <tr> <td>RC1360A0</td> <td>10 - 10 JG ELBOW FITTING</td> <td>1</td> <td>PZ</td> </tr> <tr> <td>RC1376A0</td> <td>Ø6 Y-FITTING</td> <td>1</td> <td>PZ</td> </tr> <tr> <td>TB1177A0</td> <td>FOOT PANEL 40X40 H58 OVERLAP LM</td> <td>4</td> <td>PZ</td> </tr> <tr> <td>TB1520A0</td> <td>INT. Ø=38 TH=4 DRAIN BLACK RUBBER PIPE</td> <td>2.700</td> <td>M</td> </tr> <tr> <td>TB1815A0</td> <td>7,93X4,75 PE TRANSP. PIPE (JG #PE08100N)</td> <td>2</td> <td>M</td> </tr> <tr> <td>TB2243A0</td> <td>D10 PE TRANSPAREN T PIPE</td> <td>1.500</td> <td>M</td> </tr> <tr> <td>VI1220A1</td> <td>4,2X12 TCB SELF-TAPPIN G SCREW</td> <td>16</td> <td>PZ</td> </tr> <tr> <td>VI1895A0</td> <td>BLIND NUT M4 STAINLESS STEEL DIN 917</td> <td>8</td> <td>PZ</td> </tr> <tr> <td>VI1945A0</td> <td>ENG-VITE M4X20 TCB+ INOX</td> <td>8</td> <td>PZ</td> </tr> <tr> <td>VI1950A0</td> <td>ST. STEEL 4,2X13 TCB SELF-DRILLIN G SCREW</td> <td>10</td> <td>PZ</td> </tr> <tr> <td>VL1005A1</td> <td>U-TRAP TANK</td> <td>2</td> <td>PZ</td> </tr> <tr> <td>VL1006A0</td> <td>SYPHON COVER</td> <td>2</td> <td>PZ</td> </tr> <tr> <td>VL1046A1</td> <td>D6 PIPE HOLDER - D6 J.G. TERMINAL</td> <td>6</td> <td>PZ</td> </tr> <tr> <td>VL1047A1</td> <td>D6 PIPE HOLDER - D8 J.G. TERMINAL</td> <td>4</td> <td>PZ</td> </tr> <tr> <td>VM1015A1</td> <td>STAINLESS STEEL Ø30X1.5 90° BEND</td> <td>1</td> <td>PZ</td> </tr> <tr> <td>VM1794A0</td> <td>250X4.8 PA66 BLACK CLAMP</td> <td>2</td> <td>PZ</td> </tr> <tr> <td>VM2035A0</td> <td>DRAIN PIPE SUPPORT</td> <td>1</td> <td>PZ</td> </tr> </tbody> </table>	Code	Description	Qty	UOM	RC1055A0	Ø25-40 H12 STAINLESS STEEL PIPE CLIP	10	PZ	RC1297A1	D10 T-SHAPED FITTING	1	PZ	RC1360A0	10 - 10 JG ELBOW FITTING	1	PZ	RC1376A0	Ø6 Y-FITTING	1	PZ	TB1177A0	FOOT PANEL 40X40 H58 OVERLAP LM	4	PZ	TB1520A0	INT. Ø=38 TH=4 DRAIN BLACK RUBBER PIPE	2.700	M	TB1815A0	7,93X4,75 PE TRANSP. PIPE (JG #PE08100N)	2	M	TB2243A0	D10 PE TRANSPAREN T PIPE	1.500	M	VI1220A1	4,2X12 TCB SELF-TAPPIN G SCREW	16	PZ	VI1895A0	BLIND NUT M4 STAINLESS STEEL DIN 917	8	PZ	VI1945A0	ENG-VITE M4X20 TCB+ INOX	8	PZ	VI1950A0	ST. STEEL 4,2X13 TCB SELF-DRILLIN G SCREW	10	PZ	VL1005A1	U-TRAP TANK	2	PZ	VL1006A0	SYPHON COVER	2	PZ	VL1046A1	D6 PIPE HOLDER - D6 J.G. TERMINAL	6	PZ	VL1047A1	D6 PIPE HOLDER - D8 J.G. TERMINAL	4	PZ	VM1015A1	STAINLESS STEEL Ø30X1.5 90° BEND	1	PZ	VM1794A0	250X4.8 PA66 BLACK CLAMP	2	PZ	VM2035A0	DRAIN PIPE SUPPORT	1	PZ
Code	Description	Qty	UOM																																																																																		
RC1055A0	Ø25-40 H12 STAINLESS STEEL PIPE CLIP	10	PZ																																																																																		
RC1297A1	D10 T-SHAPED FITTING	1	PZ																																																																																		
RC1360A0	10 - 10 JG ELBOW FITTING	1	PZ																																																																																		
RC1376A0	Ø6 Y-FITTING	1	PZ																																																																																		
TB1177A0	FOOT PANEL 40X40 H58 OVERLAP LM	4	PZ																																																																																		
TB1520A0	INT. Ø=38 TH=4 DRAIN BLACK RUBBER PIPE	2.700	M																																																																																		
TB1815A0	7,93X4,75 PE TRANSP. PIPE (JG #PE08100N)	2	M																																																																																		
TB2243A0	D10 PE TRANSPAREN T PIPE	1.500	M																																																																																		
VI1220A1	4,2X12 TCB SELF-TAPPIN G SCREW	16	PZ																																																																																		
VI1895A0	BLIND NUT M4 STAINLESS STEEL DIN 917	8	PZ																																																																																		
VI1945A0	ENG-VITE M4X20 TCB+ INOX	8	PZ																																																																																		
VI1950A0	ST. STEEL 4,2X13 TCB SELF-DRILLIN G SCREW	10	PZ																																																																																		
VL1005A1	U-TRAP TANK	2	PZ																																																																																		
VL1006A0	SYPHON COVER	2	PZ																																																																																		
VL1046A1	D6 PIPE HOLDER - D6 J.G. TERMINAL	6	PZ																																																																																		
VL1047A1	D6 PIPE HOLDER - D8 J.G. TERMINAL	4	PZ																																																																																		
VM1015A1	STAINLESS STEEL Ø30X1.5 90° BEND	1	PZ																																																																																		
VM1794A0	250X4.8 PA66 BLACK CLAMP	2	PZ																																																																																		
VM2035A0	DRAIN PIPE SUPPORT	1	PZ																																																																																		



COMPONENT			SPARE PART																		
Code	Description	Image	Code	Description	Components list																
VM2036A	DRAIN WATER PIPE SUPPORT		KVM2036A	DRAIN WATER PIPE SUPPORT KIT	<table border="1"> <thead> <tr> <th>Code</th> <th>Description</th> <th>Qty</th> <th>UOM</th> </tr> </thead> <tbody> <tr> <td>VI1220A1</td> <td>4,2X12 TCB SELF-TAPPING SCREW</td> <td>2</td> <td>PZ</td> </tr> <tr> <td>VM1224A0</td> <td></td> <td>0,200</td> <td>M</td> </tr> <tr> <td>VM2036A0</td> <td>DRAIN WATER PIPE SUPPORT</td> <td>2</td> <td>PZ</td> </tr> </tbody> </table>	Code	Description	Qty	UOM	VI1220A1	4,2X12 TCB SELF-TAPPING SCREW	2	PZ	VM1224A0		0,200	M	VM2036A0	DRAIN WATER PIPE SUPPORT	2	PZ
Code	Description	Qty	UOM																		
VI1220A1	4,2X12 TCB SELF-TAPPING SCREW	2	PZ																		
VM1224A0		0,200	M																		
VM2036A0	DRAIN WATER PIPE SUPPORT	2	PZ																		
TB2939A	XEVC-2011 WATER DRAIN PIPE		TB2939A0	XEVC-2011 WATER DRAIN PIPE																	
0H7458A	GAS FITTING FIXING PLATE		0H7458A0	GAS FITTING FIXING PLATE																	
0E1368A	2011-G BACK BOTTOM CLOSING PANEL		0E1368A0	2011-G BACK BOTTOM CLOSING PANEL																	
0H2561A	6 S. DOOR COUNTERBRACKET		0H2561A0	6 S. DOOR COUNTERBRACKET																	





COMPONENT			SPARE PART																										
Code	Description	Image	Code	Description	Components list																								
VI1995A	M5X25 ST.STEEL SCREW		VI1995A0	M5X25 ST.STEEL SCREW																									
VM2352A	MM LOWER DOOR BRACKET LEFT SCREW COVERI		VM2352A0	MM LOWER DOOR BRACKET LEFT SCREW COVERI																									
VM2353A	MM LOWER DOOR BRACKET RIGHT SCREW COVERI		VM2353A0	MM LOWER DOOR BRACKET RIGHT SCREW COVERI																									
VM1240A	NYLON SUPPORT CAP		KVM1240A	4 PCS COUNTER BRACKET SUPPORT CAP KIT	<table border="1"> <thead> <tr> <th>Code</th> <th>Description</th> <th>Qty</th> <th>UOM</th> </tr> </thead> <tbody> <tr> <td>VM1224A0</td> <td></td> <td>0.200</td> <td>M</td> </tr> <tr> <td>VM1240A0</td> <td>NYLON SUPPORT CAP</td> <td>4</td> <td>PZ</td> </tr> </tbody> </table>	Code	Description	Qty	UOM	VM1224A0		0.200	M	VM1240A0	NYLON SUPPORT CAP	4	PZ												
Code	Description	Qty	UOM																										
VM1224A0		0.200	M																										
VM1240A0	NYLON SUPPORT CAP	4	PZ																										
VM2273A	MM DOOR LEFT LOWER BRACKET		KVM2273A	MIND.MAPS DOOR LOWER LEFT BRACKET KIT	<table border="1"> <thead> <tr> <th>Code</th> <th>Description</th> <th>Qty</th> <th>UOM</th> </tr> </thead> <tbody> <tr> <td>0H7330A0</td> <td>DOOR LOWER BRACKET WASHER</td> <td>2</td> <td>PZ</td> </tr> <tr> <td>VI1995A0</td> <td>M5X25 ST.STEEL SCREW</td> <td>4</td> <td>PZ</td> </tr> <tr> <td>VM1224A0</td> <td></td> <td>0.300</td> <td>M</td> </tr> <tr> <td>VM2273A1</td> <td>MM DOOR LEFT LOWER BRACKET</td> <td>1</td> <td>PZ</td> </tr> <tr> <td>VM2352A0</td> <td>MM LOWER DOOR BRACKET LEFT SCREW COVERI</td> <td>1</td> <td>PZ</td> </tr> </tbody> </table>	Code	Description	Qty	UOM	0H7330A0	DOOR LOWER BRACKET WASHER	2	PZ	VI1995A0	M5X25 ST.STEEL SCREW	4	PZ	VM1224A0		0.300	M	VM2273A1	MM DOOR LEFT LOWER BRACKET	1	PZ	VM2352A0	MM LOWER DOOR BRACKET LEFT SCREW COVERI	1	PZ
Code	Description	Qty	UOM																										
0H7330A0	DOOR LOWER BRACKET WASHER	2	PZ																										
VI1995A0	M5X25 ST.STEEL SCREW	4	PZ																										
VM1224A0		0.300	M																										
VM2273A1	MM DOOR LEFT LOWER BRACKET	1	PZ																										
VM2352A0	MM LOWER DOOR BRACKET LEFT SCREW COVERI	1	PZ																										

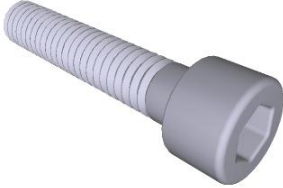





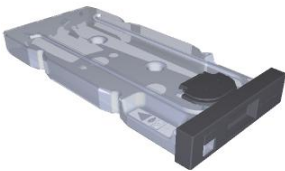



COMPONENT			SPARE PART																		
Code	Description	Image	Code	Description	Components list																
VM2273A	MM DOOR LEFT LOWER BRACKET		KVM2273A	MIND.MAPS DOOR LOWER LEFT BRACKET KIT	<table border="1"> <thead> <tr> <th>Code</th> <th>Description</th> <th>Qty</th> <th>UOM</th> </tr> </thead> <tbody> <tr> <td>VM2352A0</td> <td>MM LOWER DOOR BRACKET LEFT SCREW COVERI</td> <td>1</td> <td>PZ</td> </tr> <tr> <td>VM2353A0</td> <td>MM LOWER DOOR BRACKET RIGHT SCREW COVERI</td> <td>1</td> <td>PZ</td> </tr> <tr> <td>VM2353A0</td> <td>MM LOWER DOOR BRACKET RIGHT SCREW COVERI</td> <td>1</td> <td>PZ</td> </tr> </tbody> </table>	Code	Description	Qty	UOM	VM2352A0	MM LOWER DOOR BRACKET LEFT SCREW COVERI	1	PZ	VM2353A0	MM LOWER DOOR BRACKET RIGHT SCREW COVERI	1	PZ	VM2353A0	MM LOWER DOOR BRACKET RIGHT SCREW COVERI	1	PZ
Code	Description	Qty	UOM																		
VM2352A0	MM LOWER DOOR BRACKET LEFT SCREW COVERI	1	PZ																		
VM2353A0	MM LOWER DOOR BRACKET RIGHT SCREW COVERI	1	PZ																		
VM2353A0	MM LOWER DOOR BRACKET RIGHT SCREW COVERI	1	PZ																		
0H2561A	6 S. DOOR COUNTERBRACKET		0H2561A0	6 S. DOOR COUNTERBRACKET																	
VI1995A	M5X25 ST.STEEL SCREW		VI1995A0	M5X25 ST.STEEL SCREW																	
VM1240A	NYLON SUPPORT CAP		KVM1240A	4 PCS COUNTER BRACKET SUPPORT CAP KIT	<table border="1"> <thead> <tr> <th>Code</th> <th>Description</th> <th>Qty</th> <th>UOM</th> </tr> </thead> <tbody> <tr> <td>VM1224A0</td> <td></td> <td>0.200</td> <td>M</td> </tr> <tr> <td>VM1240A0</td> <td>NYLON SUPPORT CAP</td> <td>4</td> <td>PZ</td> </tr> </tbody> </table>	Code	Description	Qty	UOM	VM1224A0		0.200	M	VM1240A0	NYLON SUPPORT CAP	4	PZ				
Code	Description	Qty	UOM																		
VM1224A0		0.200	M																		
VM1240A0	NYLON SUPPORT CAP	4	PZ																		







COMPONENT			SPARE PART																														
Code	Description	Image	Code	Description	Components list																												
VM2298A	DOOR BRACKET UPPER COVER		KVM2298A	MIND.MAPS DOOR UPPER BRACKET COVER KIT	<table border="1"> <thead> <tr> <th>Code</th> <th>Description</th> <th>Qty</th> <th>UOM</th> </tr> </thead> <tbody> <tr> <td>VI1220A0</td> <td>SELF-TAPPIN G SCREW 4,2X12 TCB</td> <td>2</td> <td>PZ</td> </tr> <tr> <td>VM1224A0</td> <td></td> <td>0.200</td> <td>M</td> </tr> <tr> <td>VM2298A0</td> <td>DOOR BRACKET UPPER COVER</td> <td>1</td> <td>PZ</td> </tr> </tbody> </table>	Code	Description	Qty	UOM	VI1220A0	SELF-TAPPIN G SCREW 4,2X12 TCB	2	PZ	VM1224A0		0.200	M	VM2298A0	DOOR BRACKET UPPER COVER	1	PZ												
Code	Description	Qty	UOM																														
VI1220A0	SELF-TAPPIN G SCREW 4,2X12 TCB	2	PZ																														
VM1224A0		0.200	M																														
VM2298A0	DOOR BRACKET UPPER COVER	1	PZ																														
VM2271A	MM DOOR LEFT UPPER BRACKET		KVM2271A	MIND.MAPS UPPER LEFT DOOR BRACKET KIT	<table border="1"> <thead> <tr> <th>Code</th> <th>Description</th> <th>Qty</th> <th>UOM</th> </tr> </thead> <tbody> <tr> <td>VI1220A1</td> <td>4,2X12 TCB SELF-TAPPIN G SCREW</td> <td>2</td> <td>PZ</td> </tr> <tr> <td>VI1995A0</td> <td>M5X25 ST.STEEL SCREW</td> <td>4</td> <td>PZ</td> </tr> <tr> <td>VI1997A0</td> <td>5X10X1 FLAT WASHER</td> <td>4</td> <td>PZ</td> </tr> <tr> <td>VM1224A0</td> <td></td> <td>0.300</td> <td>M</td> </tr> <tr> <td>VM2271A0</td> <td>MM DOOR LEFT UPPER BRACKET</td> <td>1</td> <td>PZ</td> </tr> <tr> <td>VM2298A0</td> <td>DOOR BRACKET UPPER COVER</td> <td>1</td> <td>PZ</td> </tr> </tbody> </table>	Code	Description	Qty	UOM	VI1220A1	4,2X12 TCB SELF-TAPPIN G SCREW	2	PZ	VI1995A0	M5X25 ST.STEEL SCREW	4	PZ	VI1997A0	5X10X1 FLAT WASHER	4	PZ	VM1224A0		0.300	M	VM2271A0	MM DOOR LEFT UPPER BRACKET	1	PZ	VM2298A0	DOOR BRACKET UPPER COVER	1	PZ
Code	Description	Qty	UOM																														
VI1220A1	4,2X12 TCB SELF-TAPPIN G SCREW	2	PZ																														
VI1995A0	M5X25 ST.STEEL SCREW	4	PZ																														
VI1997A0	5X10X1 FLAT WASHER	4	PZ																														
VM1224A0		0.300	M																														
VM2271A0	MM DOOR LEFT UPPER BRACKET	1	PZ																														
VM2298A0	DOOR BRACKET UPPER COVER	1	PZ																														
0D2331B	XEVC-2011-G EXT. BACK FRONT COVE		0D2331B0	XEVC-2011-G EXT. BACK FRONT COVE																													
SB1015A	4L DETERGENT TAN		KSB1015A	4L DETERGENT TANK KIT	<table border="1"> <thead> <tr> <th>Code</th> <th>Description</th> <th>Qty</th> <th>UOM</th> </tr> </thead> <tbody> <tr> <td>IP1385A1</td> <td>CORNER POLYSTYREN E PACKING 110X80X2000</td> <td>1.200</td> <td>M</td> </tr> <tr> <td>IP1410A0</td> <td>POLYSTYREN E PACKING TO PROTECT</td> <td>2</td> <td>PZ</td> </tr> <tr> <td>SB1015A2</td> <td>4L DETERGENT TANK</td> <td>1</td> <td>PZ</td> </tr> <tr> <td>VM1059A1</td> <td>HEAT SHRINK FILM H800</td> <td>1.200</td> <td>M</td> </tr> </tbody> </table>	Code	Description	Qty	UOM	IP1385A1	CORNER POLYSTYREN E PACKING 110X80X2000	1.200	M	IP1410A0	POLYSTYREN E PACKING TO PROTECT	2	PZ	SB1015A2	4L DETERGENT TANK	1	PZ	VM1059A1	HEAT SHRINK FILM H800	1.200	M								
Code	Description	Qty	UOM																														
IP1385A1	CORNER POLYSTYREN E PACKING 110X80X2000	1.200	M																														
IP1410A0	POLYSTYREN E PACKING TO PROTECT	2	PZ																														
SB1015A2	4L DETERGENT TANK	1	PZ																														
VM1059A1	HEAT SHRINK FILM H800	1.200	M																														



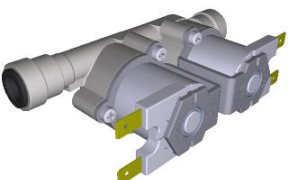

COMPONENT			SPARE PART																						
Code	Description	Image	Code	Description	Components list																				
VM1197A	MM DETERGENT TANK FRAME		KVM1197A	MM DETERGENT TANK FRAME KIT	<table border="1"> <thead> <tr> <th>Code</th> <th>Description</th> <th>Qty</th> <th>UOM</th> </tr> </thead> <tbody> <tr> <td>VM1197A1</td> <td>MM DETERGENT TANK FRAME</td> <td>1</td> <td>PZ</td> </tr> </tbody> </table>	Code	Description	Qty	UOM	VM1197A1	MM DETERGENT TANK FRAME	1	PZ												
Code	Description	Qty	UOM																						
VM1197A1	MM DETERGENT TANK FRAME	1	PZ																						
0H7480B	GAS EXCHANGER CHIMNEY D40 GASKET HOLDER		0H7480B0	GAS EXCHANGER CHIMNEY D40 GASKET HOLDER																					
VM1240A	NYLON SUPPORT CAP		KVM1240A	4 PCS COUNTER BRACKET SUPPORT CAP KIT	<table border="1"> <thead> <tr> <th>Code</th> <th>Description</th> <th>Qty</th> <th>UOM</th> </tr> </thead> <tbody> <tr> <td>VM1224A0</td> <td></td> <td>0.200</td> <td>M</td> </tr> <tr> <td>VM1240A0</td> <td>NYLON SUPPORT CAP</td> <td>4</td> <td>PZ</td> </tr> </tbody> </table>	Code	Description	Qty	UOM	VM1224A0		0.200	M	VM1240A0	NYLON SUPPORT CAP	4	PZ								
Code	Description	Qty	UOM																						
VM1224A0		0.200	M																						
VM1240A0	NYLON SUPPORT CAP	4	PZ																						
VM2282A	MICROSWITCH SUPPORT COVER		KVM2282A	MICROSWITCH SUPPORT PLATE KI	<table border="1"> <thead> <tr> <th>Code</th> <th>Description</th> <th>Qty</th> <th>UOM</th> </tr> </thead> <tbody> <tr> <td>VM1224A0</td> <td></td> <td>0.200</td> <td>M</td> </tr> <tr> <td>VM2282A0</td> <td>MICROSWITCH SUPPORT COVER</td> <td>1</td> <td>PZ</td> </tr> </tbody> </table>	Code	Description	Qty	UOM	VM1224A0		0.200	M	VM2282A0	MICROSWITCH SUPPORT COVER	1	PZ								
Code	Description	Qty	UOM																						
VM1224A0		0.200	M																						
VM2282A0	MICROSWITCH SUPPORT COVER	1	PZ																						
VE1020B	MAGNET DOOR MICROSWITCH		KVE1020B	MICROSWITCH KIT	<table border="1"> <thead> <tr> <th>Code</th> <th>Description</th> <th>Qty</th> <th>UOM</th> </tr> </thead> <tbody> <tr> <td>CE1030A0</td> <td>FEMALE FASTON COVER 6.3X0.8 0.5-1MMQ</td> <td>2</td> <td>PZ</td> </tr> <tr> <td>CE1660A0</td> <td>6,3X0,8 FEMALE FASTON COVE</td> <td>2</td> <td>PZ</td> </tr> <tr> <td>CE1730A0</td> <td>PVC CABLE NP 2 X AWG22 STYLE 2095</td> <td>0.150</td> <td>M</td> </tr> <tr> <td>CE1740A0</td> <td>MINIFIT MALE END FITTING</td> <td>2</td> <td>PZ</td> </tr> </tbody> </table>	Code	Description	Qty	UOM	CE1030A0	FEMALE FASTON COVER 6.3X0.8 0.5-1MMQ	2	PZ	CE1660A0	6,3X0,8 FEMALE FASTON COVE	2	PZ	CE1730A0	PVC CABLE NP 2 X AWG22 STYLE 2095	0.150	M	CE1740A0	MINIFIT MALE END FITTING	2	PZ
Code	Description	Qty	UOM																						
CE1030A0	FEMALE FASTON COVER 6.3X0.8 0.5-1MMQ	2	PZ																						
CE1660A0	6,3X0,8 FEMALE FASTON COVE	2	PZ																						
CE1730A0	PVC CABLE NP 2 X AWG22 STYLE 2095	0.150	M																						
CE1740A0	MINIFIT MALE END FITTING	2	PZ																						

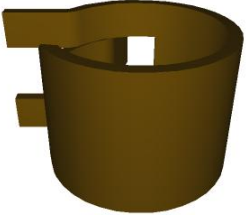
COMPONENT			SPARE PART																						
Code	Description	Image	Code	Description	Components list																				
VE1020B	MAGNET DOOR MICROSWITCH		KVE1020B	MICROSWITCH KIT	<table border="1"> <thead> <tr> <th>Code</th> <th>Description</th> <th>Qty</th> <th>UOM</th> </tr> </thead> <tbody> <tr> <td>CE1745A0</td> <td>2 WAYS FEMALE MINIFIT CONNECTOR</td> <td>1</td> <td>PZ</td> </tr> <tr> <td>VE1020B0</td> <td>MAGNET DOOR MICROSWITC</td> <td>1</td> <td>PZ</td> </tr> <tr> <td>VE1030A1</td> <td>MAGNET FOR DOOR MICROSWITC H D=22,9MM</td> <td>1</td> <td>PZ</td> </tr> <tr> <td>VM1224A0</td> <td></td> <td>0.250</td> <td>M</td> </tr> </tbody> </table>	Code	Description	Qty	UOM	CE1745A0	2 WAYS FEMALE MINIFIT CONNECTOR	1	PZ	VE1020B0	MAGNET DOOR MICROSWITC	1	PZ	VE1030A1	MAGNET FOR DOOR MICROSWITC H D=22,9MM	1	PZ	VM1224A0		0.250	M
					Code	Description	Qty	UOM																	
					CE1745A0	2 WAYS FEMALE MINIFIT CONNECTOR	1	PZ																	
					VE1020B0	MAGNET DOOR MICROSWITC	1	PZ																	
VE1030A1	MAGNET FOR DOOR MICROSWITC H D=22,9MM	1	PZ																						
VM1224A0		0.250	M																						
0H6567A	P-TRAP HOLDING BRACKET		0H6567A0	P-TRAP HOLDING BRACKET																					
VL1047A	D6 PIPE HOLDER - D8 J.G. TERMINAL		KVL1047A	Ø6 PIPE HOLDER+Ø8 JG TERMINAL 10 PCS KIT	<table border="1"> <thead> <tr> <th>Code</th> <th>Description</th> <th>Qty</th> <th>UOM</th> </tr> </thead> <tbody> <tr> <td>VL1047A1</td> <td>D6 PIPE HOLDER - D8 J.G. TERMINAL</td> <td>10</td> <td>PZ</td> </tr> <tr> <td>VM1224A0</td> <td></td> <td>0.200</td> <td>M</td> </tr> </tbody> </table>	Code	Description	Qty	UOM	VL1047A1	D6 PIPE HOLDER - D8 J.G. TERMINAL	10	PZ	VM1224A0		0.200	M								
					Code	Description	Qty	UOM																	
					VL1047A1	D6 PIPE HOLDER - D8 J.G. TERMINAL	10	PZ																	
					VM1224A0		0.200	M																	
			KVL0016A	BRITA ADAPTOR KIT FOR MM CLEANING SYSTEM	<table border="1"> <thead> <tr> <th>Code</th> <th>Description</th> <th>Qty</th> <th>UOM</th> </tr> </thead> <tbody> <tr> <td>EL1185A0</td> <td>Ø8F - Ø8F ELBOW CONNECTION</td> <td>260</td> <td>PZ</td> </tr> <tr> <td>RC1018A0</td> <td>ZINC PLATED D12 ELASTIC CLAMP</td> <td>520</td> <td>PZ</td> </tr> <tr> <td>VL1047A1</td> <td>D6 PIPE HOLDER - D8 J.G. TERMINAL</td> <td>520</td> <td>PZ</td> </tr> </tbody> </table>	Code	Description	Qty	UOM	EL1185A0	Ø8F - Ø8F ELBOW CONNECTION	260	PZ	RC1018A0	ZINC PLATED D12 ELASTIC CLAMP	520	PZ	VL1047A1	D6 PIPE HOLDER - D8 J.G. TERMINAL	520	PZ				
Code	Description	Qty	UOM																						
EL1185A0	Ø8F - Ø8F ELBOW CONNECTION	260	PZ																						
RC1018A0	ZINC PLATED D12 ELASTIC CLAMP	520	PZ																						
VL1047A1	D6 PIPE HOLDER - D8 J.G. TERMINAL	520	PZ																						
VM1794A	250X4.8 PA66 BLACK CLAMP		VM1794A0	250X4.8 PA66 BLACK CLAMP																					

COMPONENT			SPARE PART																																																										
Code	Description	Image	Code	Description	Components list																																																								
VL1095A	FITTING M-M RUBBER HOLDER D7,8-D10		KVL1095A	STRAIGHT CONNECT-HOLDER D7-D10 10PCS KIT	<table border="1"> <thead> <tr> <th>Code</th> <th>Description</th> <th>Qty</th> <th>UOM</th> </tr> </thead> <tbody> <tr> <td>VL1095A0</td> <td>FITTING M-M RUBBER HOLDER D7,8-D10</td> <td>10</td> <td>PZ</td> </tr> <tr> <td>VM1224A0</td> <td></td> <td>0.200</td> <td>M</td> </tr> </tbody> </table>	Code	Description	Qty	UOM	VL1095A0	FITTING M-M RUBBER HOLDER D7,8-D10	10	PZ	VM1224A0		0.200	M																																												
Code	Description	Qty	UOM																																																										
VL1095A0	FITTING M-M RUBBER HOLDER D7,8-D10	10	PZ																																																										
VM1224A0		0.200	M																																																										
EL1431A	STEAM SOLENOID VALVE 9+38 JG D8-D10		KEL1431A	9+38 STEAM SOLENOID VALVE KI	<table border="1"> <thead> <tr> <th>Code</th> <th>Description</th> <th>Qty</th> <th>UOM</th> </tr> </thead> <tbody> <tr> <td>EL1431A0</td> <td>STEAM SOLENOID VALVE 9+38 JG D8-D10</td> <td>1</td> <td>PZ</td> </tr> <tr> <td>VM1224A0</td> <td></td> <td>0.250</td> <td>M</td> </tr> </tbody> </table>	Code	Description	Qty	UOM	EL1431A0	STEAM SOLENOID VALVE 9+38 JG D8-D10	1	PZ	VM1224A0		0.250	M																																												
Code	Description	Qty	UOM																																																										
EL1431A0	STEAM SOLENOID VALVE 9+38 JG D8-D10	1	PZ																																																										
VM1224A0		0.250	M																																																										
VL1103C			KVL1103A	EUR 2 ROTOR ARMS PLUS CLEANING SYSTEM KIT	<table border="1"> <thead> <tr> <th>Code</th> <th>Description</th> <th>Qty</th> <th>UOM</th> </tr> </thead> <tbody> <tr> <td>0H2143A0</td> <td></td> <td>1</td> <td>PZ</td> </tr> <tr> <td>0H7820A0</td> <td>PLUS WASHING SY SUPPORT WITH STEAM VALVE</td> <td>1</td> <td>PZ</td> </tr> <tr> <td>EL1252A1</td> <td>1 WAY WATER VALVE + J.G. CONNECTION</td> <td>1</td> <td>PZ</td> </tr> <tr> <td>EL1424A0</td> <td>D8 CONNECTION WATER SOLENOID VALVE</td> <td>2</td> <td>PZ</td> </tr> <tr> <td>EL1424B0</td> <td></td> <td>2</td> <td>PZ</td> </tr> <tr> <td>EL1436A0</td> <td>H2O SOLENOID JG D8 CHECK VALVE</td> <td>1</td> <td>PZ</td> </tr> <tr> <td>EL1436B0</td> <td></td> <td>1</td> <td>PZ</td> </tr> <tr> <td>GN1526A0</td> <td>INT. D.=6.9 TH=1.8 O-RIN</td> <td>1</td> <td>PZ</td> </tr> <tr> <td>RC1019A0</td> <td>D=10 ELASTIC CLAMP</td> <td>12</td> <td>PZ</td> </tr> <tr> <td>RC1130A0</td> <td>130X2,6 CLAM</td> <td>1</td> <td>PZ</td> </tr> <tr> <td>RC1242A0</td> <td>D=10 CLOSED CAP</td> <td>2</td> <td>PZ</td> </tr> <tr> <td>RC1356A0</td> <td>STRAIGHT THREADED FEMALE END 8X1/4" BSP</td> <td>1</td> <td>PZ</td> </tr> <tr> <td>TB2820A0</td> <td>PIPE EPDM FOR WASHING SYSTEM</td> <td>1.410</td> <td>M</td> </tr> </tbody> </table>	Code	Description	Qty	UOM	0H2143A0		1	PZ	0H7820A0	PLUS WASHING SY SUPPORT WITH STEAM VALVE	1	PZ	EL1252A1	1 WAY WATER VALVE + J.G. CONNECTION	1	PZ	EL1424A0	D8 CONNECTION WATER SOLENOID VALVE	2	PZ	EL1424B0		2	PZ	EL1436A0	H2O SOLENOID JG D8 CHECK VALVE	1	PZ	EL1436B0		1	PZ	GN1526A0	INT. D.=6.9 TH=1.8 O-RIN	1	PZ	RC1019A0	D=10 ELASTIC CLAMP	12	PZ	RC1130A0	130X2,6 CLAM	1	PZ	RC1242A0	D=10 CLOSED CAP	2	PZ	RC1356A0	STRAIGHT THREADED FEMALE END 8X1/4" BSP	1	PZ	TB2820A0	PIPE EPDM FOR WASHING SYSTEM	1.410	M
Code	Description	Qty	UOM																																																										
0H2143A0		1	PZ																																																										
0H7820A0	PLUS WASHING SY SUPPORT WITH STEAM VALVE	1	PZ																																																										
EL1252A1	1 WAY WATER VALVE + J.G. CONNECTION	1	PZ																																																										
EL1424A0	D8 CONNECTION WATER SOLENOID VALVE	2	PZ																																																										
EL1424B0		2	PZ																																																										
EL1436A0	H2O SOLENOID JG D8 CHECK VALVE	1	PZ																																																										
EL1436B0		1	PZ																																																										
GN1526A0	INT. D.=6.9 TH=1.8 O-RIN	1	PZ																																																										
RC1019A0	D=10 ELASTIC CLAMP	12	PZ																																																										
RC1130A0	130X2,6 CLAM	1	PZ																																																										
RC1242A0	D=10 CLOSED CAP	2	PZ																																																										
RC1356A0	STRAIGHT THREADED FEMALE END 8X1/4" BSP	1	PZ																																																										
TB2820A0	PIPE EPDM FOR WASHING SYSTEM	1.410	M																																																										

COMPONENT			SPARE PART																																										
Code	Description	Image	Code	Description	Components list																																								
VL1103C			KVL1103A	EUR 2 ROTOR ARMS PLUS CLEANING SYSTEM KIT	<table border="1"> <thead> <tr> <th>Code</th> <th>Description</th> <th>Qty</th> <th>UOM</th> </tr> </thead> <tbody> <tr> <td>VI1220A1</td> <td>4,2X12 TCB SELF-TAPPIN G SCREW</td> <td>3</td> <td>PZ</td> </tr> <tr> <td>VL1019A0</td> <td>VIBRATION PUMP</td> <td>1</td> <td>PZ</td> </tr> <tr> <td>VL1065A1</td> <td>1/4 MALE N.O. PRESSURE SWITCH</td> <td>1</td> <td>PZ</td> </tr> <tr> <td>VL1067A0</td> <td>WASHING SYSTEM INLETS DISTRIBUTOR</td> <td>1</td> <td>PZ</td> </tr> <tr> <td>VL1092A0</td> <td>WASHING SYSTEM OUTLET DOUBLE DISTRIBUTOR</td> <td>1</td> <td>PZ</td> </tr> <tr> <td>VL1102A1</td> <td>DETERGENT LINE FILTER + BARBED VNR 6 MM</td> <td>1</td> <td>PZ</td> </tr> <tr> <td>VL1128A0</td> <td>D6 BARBED CHECK VALVE</td> <td>1</td> <td>PZ</td> </tr> <tr> <td>VL1128A1</td> <td>D6 BARBED CHECK VALVE</td> <td>1</td> <td>PZ</td> </tr> <tr> <td>VM2172A0</td> <td>PUMP-WITH-CI RCUIT LOCKING PIN</td> <td>1</td> <td>PZ</td> </tr> </tbody> </table>	Code	Description	Qty	UOM	VI1220A1	4,2X12 TCB SELF-TAPPIN G SCREW	3	PZ	VL1019A0	VIBRATION PUMP	1	PZ	VL1065A1	1/4 MALE N.O. PRESSURE SWITCH	1	PZ	VL1067A0	WASHING SYSTEM INLETS DISTRIBUTOR	1	PZ	VL1092A0	WASHING SYSTEM OUTLET DOUBLE DISTRIBUTOR	1	PZ	VL1102A1	DETERGENT LINE FILTER + BARBED VNR 6 MM	1	PZ	VL1128A0	D6 BARBED CHECK VALVE	1	PZ	VL1128A1	D6 BARBED CHECK VALVE	1	PZ	VM2172A0	PUMP-WITH-CI RCUIT LOCKING PIN	1	PZ
Code	Description	Qty	UOM																																										
VI1220A1	4,2X12 TCB SELF-TAPPIN G SCREW	3	PZ																																										
VL1019A0	VIBRATION PUMP	1	PZ																																										
VL1065A1	1/4 MALE N.O. PRESSURE SWITCH	1	PZ																																										
VL1067A0	WASHING SYSTEM INLETS DISTRIBUTOR	1	PZ																																										
VL1092A0	WASHING SYSTEM OUTLET DOUBLE DISTRIBUTOR	1	PZ																																										
VL1102A1	DETERGENT LINE FILTER + BARBED VNR 6 MM	1	PZ																																										
VL1128A0	D6 BARBED CHECK VALVE	1	PZ																																										
VL1128A1	D6 BARBED CHECK VALVE	1	PZ																																										
VM2172A0	PUMP-WITH-CI RCUIT LOCKING PIN	1	PZ																																										
RC1019A	D=10 ELASTIC CLAM		KRC1019A	Ø10 ZINC PLATED ELASTIC CLAMP 15 PCS KIT	<table border="1"> <thead> <tr> <th>Code</th> <th>Description</th> <th>Qty</th> <th>UOM</th> </tr> </thead> <tbody> <tr> <td>RC1019A0</td> <td>D=10 ELASTIC CLAMP</td> <td>17</td> <td>PZ</td> </tr> <tr> <td>VM1224A0</td> <td></td> <td>0.200</td> <td>M</td> </tr> </tbody> </table>	Code	Description	Qty	UOM	RC1019A0	D=10 ELASTIC CLAMP	17	PZ	VM1224A0		0.200	M																												
Code	Description	Qty	UOM																																										
RC1019A0	D=10 ELASTIC CLAMP	17	PZ																																										
VM1224A0		0.200	M																																										
VL1047A	D6 PIPE HOLDER - D8 J.G. TERMINAL		KVL1047A	Ø6 PIPE HOLDER+Ø8 JG TERMINAL 10 PCS KIT	<table border="1"> <thead> <tr> <th>Code</th> <th>Description</th> <th>Qty</th> <th>UOM</th> </tr> </thead> <tbody> <tr> <td>VL1047A1</td> <td>D6 PIPE HOLDER - D8 J.G. TERMINAL</td> <td>10</td> <td>PZ</td> </tr> <tr> <td>VM1224A0</td> <td></td> <td>0.200</td> <td>M</td> </tr> </tbody> </table>	Code	Description	Qty	UOM	VL1047A1	D6 PIPE HOLDER - D8 J.G. TERMINAL	10	PZ	VM1224A0		0.200	M																												
Code	Description	Qty	UOM																																										
VL1047A1	D6 PIPE HOLDER - D8 J.G. TERMINAL	10	PZ																																										
VM1224A0		0.200	M																																										
			KVL0016A	BRITA ADAPTOR KIT FOR MM CLEANING SYSTEM	<table border="1"> <thead> <tr> <th>Code</th> <th>Description</th> <th>Qty</th> <th>UOM</th> </tr> </thead> <tbody> <tr> <td>EL1185A0</td> <td>Ø8F - Ø8F ELBOW CONNECTION</td> <td>260</td> <td>PZ</td> </tr> <tr> <td>RC1018A0</td> <td>ZINC PLATED D12 ELASTIC CLAMP</td> <td>520</td> <td>PZ</td> </tr> <tr> <td>VL1047A1</td> <td>D6 PIPE HOLDER - D8 J.G. TERMINAL</td> <td>520</td> <td>PZ</td> </tr> </tbody> </table>	Code	Description	Qty	UOM	EL1185A0	Ø8F - Ø8F ELBOW CONNECTION	260	PZ	RC1018A0	ZINC PLATED D12 ELASTIC CLAMP	520	PZ	VL1047A1	D6 PIPE HOLDER - D8 J.G. TERMINAL	520	PZ																								
Code	Description	Qty	UOM																																										
EL1185A0	Ø8F - Ø8F ELBOW CONNECTION	260	PZ																																										
RC1018A0	ZINC PLATED D12 ELASTIC CLAMP	520	PZ																																										
VL1047A1	D6 PIPE HOLDER - D8 J.G. TERMINAL	520	PZ																																										

COMPONENT			SPARE PART																										
Code	Description	Image	Code	Description	Components list																								
TB3004A	TB2820A-PLUS DETERGENT COIL L=0,5M		KTB3004A	PLUS DETERGENT PIPE COIL ROTOR KI	<table border="1"> <thead> <tr> <th>Code</th> <th>Description</th> <th>Qty</th> <th>UOM</th> </tr> </thead> <tbody> <tr> <td>TB2820A0</td> <td>PIPE EPDM FOR WASHING SYSTEM</td> <td>0.500</td> <td>M</td> </tr> </tbody> </table>	Code	Description	Qty	UOM	TB2820A0	PIPE EPDM FOR WASHING SYSTEM	0.500	M																
Code	Description	Qty	UOM																										
TB2820A0	PIPE EPDM FOR WASHING SYSTEM	0.500	M																										
VL1095A	FITTING M-M RUBBER HOLDER D7,8-D10		KVL1095A	STRAIGHT CONNECT-HOLDER D7-D10 10PCS KIT	<table border="1"> <thead> <tr> <th>Code</th> <th>Description</th> <th>Qty</th> <th>UOM</th> </tr> </thead> <tbody> <tr> <td>VL1095A0</td> <td>FITTING M-M RUBBER HOLDER D7,8-D10</td> <td>10</td> <td>PZ</td> </tr> <tr> <td>VM1224A0</td> <td></td> <td>0.200</td> <td>M</td> </tr> </tbody> </table>	Code	Description	Qty	UOM	VL1095A0	FITTING M-M RUBBER HOLDER D7,8-D10	10	PZ	VM1224A0		0.200	M												
Code	Description	Qty	UOM																										
VL1095A0	FITTING M-M RUBBER HOLDER D7,8-D10	10	PZ																										
VM1224A0		0.200	M																										
VL1102A	DETERGENT LINE FILTER + BARBED VNR 6 MM		KVL1102A	DETERGENT FILTER + NRV KIT	<table border="1"> <thead> <tr> <th>Code</th> <th>Description</th> <th>Qty</th> <th>UOM</th> </tr> </thead> <tbody> <tr> <td>RC1019A0</td> <td>D=10 ELASTIC CLAMP</td> <td>5</td> <td>PZ</td> </tr> <tr> <td>TB2820A0</td> <td>PIPE EPDM FOR WASHING SYSTEM</td> <td>0.710</td> <td>M</td> </tr> <tr> <td>VL1102A1</td> <td>DETERGENT LINE FILTER + BARBED VNR 6 MM</td> <td>1</td> <td>PZ</td> </tr> <tr> <td>VM1224A0</td> <td></td> <td>0.300</td> <td>M</td> </tr> </tbody> </table>	Code	Description	Qty	UOM	RC1019A0	D=10 ELASTIC CLAMP	5	PZ	TB2820A0	PIPE EPDM FOR WASHING SYSTEM	0.710	M	VL1102A1	DETERGENT LINE FILTER + BARBED VNR 6 MM	1	PZ	VM1224A0		0.300	M				
Code	Description	Qty	UOM																										
RC1019A0	D=10 ELASTIC CLAMP	5	PZ																										
TB2820A0	PIPE EPDM FOR WASHING SYSTEM	0.710	M																										
VL1102A1	DETERGENT LINE FILTER + BARBED VNR 6 MM	1	PZ																										
VM1224A0		0.300	M																										
0H7820A	PLUS WASHING SY SUPPORT WITH STEAM VALVE		KVL1105A	USA 2ROTOR ARMS PLUS CLEANING SYSTEM KIT	<table border="1"> <thead> <tr> <th>Code</th> <th>Description</th> <th>Qty</th> <th>UOM</th> </tr> </thead> <tbody> <tr> <td>0H2143A0</td> <td></td> <td>1</td> <td>PZ</td> </tr> <tr> <td>0H7820A0</td> <td>PLUS WASHING SY SUPPORT WITH STEAM VALVE</td> <td>1</td> <td>PZ</td> </tr> <tr> <td>EL1422A1</td> <td>1 WAY SOLENOID VALVE + D8-D10 REDUCTION</td> <td>1</td> <td>PZ</td> </tr> <tr> <td>EL1426A0</td> <td>H2O UL SOLENOID JG D8-PIPE HOLDER</td> <td>2</td> <td>PZ</td> </tr> <tr> <td>EL1426B0</td> <td>UL JG D8 WATER SLENOID VALVE-PIPE HOLDER</td> <td>2</td> <td>PZ</td> </tr> </tbody> </table>	Code	Description	Qty	UOM	0H2143A0		1	PZ	0H7820A0	PLUS WASHING SY SUPPORT WITH STEAM VALVE	1	PZ	EL1422A1	1 WAY SOLENOID VALVE + D8-D10 REDUCTION	1	PZ	EL1426A0	H2O UL SOLENOID JG D8-PIPE HOLDER	2	PZ	EL1426B0	UL JG D8 WATER SLENOID VALVE-PIPE HOLDER	2	PZ
Code	Description	Qty	UOM																										
0H2143A0		1	PZ																										
0H7820A0	PLUS WASHING SY SUPPORT WITH STEAM VALVE	1	PZ																										
EL1422A1	1 WAY SOLENOID VALVE + D8-D10 REDUCTION	1	PZ																										
EL1426A0	H2O UL SOLENOID JG D8-PIPE HOLDER	2	PZ																										
EL1426B0	UL JG D8 WATER SLENOID VALVE-PIPE HOLDER	2	PZ																										



COMPONENT			SPARE PART																																																																										
Code	Description	Image	Code	Description	Components list																																																																								
0H7820A	PLUS WASHING SY SUPPORT WITH STEAM VALVE		KVL1105A	USA 2ROTOR ARMS PLUS CLEANING SYSTEM KIT	<table border="1"> <thead> <tr> <th>Code</th> <th>Description</th> <th>Qty</th> <th>UOM</th> </tr> </thead> <tbody> <tr> <td>EL1437A0</td> <td>H2O SOLENOID JG D6 UL CHECK VALVE</td> <td>1</td> <td>PZ</td> </tr> <tr> <td>EL1437B0</td> <td>JG D8 WATER SOLENOID VALVE -BARBED D6 V</td> <td>1</td> <td>PZ</td> </tr> <tr> <td>GN1526A0</td> <td>INT. D.=6.9 TH=1.8 O-RIN</td> <td>1</td> <td>PZ</td> </tr> <tr> <td>RC1019A0</td> <td>D=10 ELASTIC CLAMP</td> <td>12</td> <td>PZ</td> </tr> <tr> <td>RC1130A0</td> <td>130X2,6 CLAM</td> <td>1</td> <td>PZ</td> </tr> <tr> <td>RC1242A0</td> <td>D=10 CLOSED CAP</td> <td>2</td> <td>PZ</td> </tr> <tr> <td>RC1356A0</td> <td>STRAIGHT THREADED FEMALE END 8X1/4" BSP</td> <td>1</td> <td>PZ</td> </tr> <tr> <td>TB2820A0</td> <td>PIPE EPDM FOR WASHING SYSTEM</td> <td>1.410</td> <td>M</td> </tr> <tr> <td>VH1220A1</td> <td>4,2X12 TCB SELF-TAPPIN G SCREW</td> <td>3</td> <td>PZ</td> </tr> <tr> <td>VL1019A0</td> <td>VIBRATION PUMP</td> <td>1</td> <td>PZ</td> </tr> <tr> <td>VL1065A1</td> <td>1/4 MALE N.O. PRESSURE SWITCH</td> <td>1</td> <td>PZ</td> </tr> <tr> <td>VL1067A0</td> <td>WASHING SYSTEM INLETS DISTRIBUTOR</td> <td>1</td> <td>PZ</td> </tr> <tr> <td>VL1092A0</td> <td>WASHING SYSTEM OUTLET DOUBLE DISTRIBUTOR</td> <td>1</td> <td>PZ</td> </tr> <tr> <td>VL1102A1</td> <td>DETERGENT LINE FILTER + BARBED VNR 6 MM</td> <td>1</td> <td>PZ</td> </tr> <tr> <td>VL1128A0</td> <td>D6 BARBED CHECK VALVE</td> <td>1</td> <td>PZ</td> </tr> <tr> <td>VL1128A1</td> <td>D6 BARBED CHECK VALVE</td> <td>1</td> <td>PZ</td> </tr> <tr> <td>VM2172A0</td> <td>PUMP-WITH-CI RCUIT LOCKING PIN</td> <td>1</td> <td>PZ</td> </tr> </tbody> </table>	Code	Description	Qty	UOM	EL1437A0	H2O SOLENOID JG D6 UL CHECK VALVE	1	PZ	EL1437B0	JG D8 WATER SOLENOID VALVE -BARBED D6 V	1	PZ	GN1526A0	INT. D.=6.9 TH=1.8 O-RIN	1	PZ	RC1019A0	D=10 ELASTIC CLAMP	12	PZ	RC1130A0	130X2,6 CLAM	1	PZ	RC1242A0	D=10 CLOSED CAP	2	PZ	RC1356A0	STRAIGHT THREADED FEMALE END 8X1/4" BSP	1	PZ	TB2820A0	PIPE EPDM FOR WASHING SYSTEM	1.410	M	VH1220A1	4,2X12 TCB SELF-TAPPIN G SCREW	3	PZ	VL1019A0	VIBRATION PUMP	1	PZ	VL1065A1	1/4 MALE N.O. PRESSURE SWITCH	1	PZ	VL1067A0	WASHING SYSTEM INLETS DISTRIBUTOR	1	PZ	VL1092A0	WASHING SYSTEM OUTLET DOUBLE DISTRIBUTOR	1	PZ	VL1102A1	DETERGENT LINE FILTER + BARBED VNR 6 MM	1	PZ	VL1128A0	D6 BARBED CHECK VALVE	1	PZ	VL1128A1	D6 BARBED CHECK VALVE	1	PZ	VM2172A0	PUMP-WITH-CI RCUIT LOCKING PIN	1	PZ
					Code	Description	Qty	UOM																																																																					
					EL1437A0	H2O SOLENOID JG D6 UL CHECK VALVE	1	PZ																																																																					
					EL1437B0	JG D8 WATER SOLENOID VALVE -BARBED D6 V	1	PZ																																																																					
					GN1526A0	INT. D.=6.9 TH=1.8 O-RIN	1	PZ																																																																					
					RC1019A0	D=10 ELASTIC CLAMP	12	PZ																																																																					
					RC1130A0	130X2,6 CLAM	1	PZ																																																																					
					RC1242A0	D=10 CLOSED CAP	2	PZ																																																																					
					RC1356A0	STRAIGHT THREADED FEMALE END 8X1/4" BSP	1	PZ																																																																					
					TB2820A0	PIPE EPDM FOR WASHING SYSTEM	1.410	M																																																																					
					VH1220A1	4,2X12 TCB SELF-TAPPIN G SCREW	3	PZ																																																																					
					VL1019A0	VIBRATION PUMP	1	PZ																																																																					
					VL1065A1	1/4 MALE N.O. PRESSURE SWITCH	1	PZ																																																																					
					VL1067A0	WASHING SYSTEM INLETS DISTRIBUTOR	1	PZ																																																																					
					VL1092A0	WASHING SYSTEM OUTLET DOUBLE DISTRIBUTOR	1	PZ																																																																					
					VL1102A1	DETERGENT LINE FILTER + BARBED VNR 6 MM	1	PZ																																																																					
					VL1128A0	D6 BARBED CHECK VALVE	1	PZ																																																																					
					VL1128A1	D6 BARBED CHECK VALVE	1	PZ																																																																					
					VM2172A0	PUMP-WITH-CI RCUIT LOCKING PIN	1	PZ																																																																					





COMPONENT			SPARE PART																																																																										
Code	Description	Image	Code	Description	Components list																																																																								
0H7820A	PLUS WASHING SY SUPPORT WITH STEAM VALVE		KVL1104A	USA 1 ROTOR ARM PLUS CLEANING SYSTEM KIT	<table border="1"> <thead> <tr> <th>Code</th> <th>Description</th> <th>Qty</th> <th>UOM</th> </tr> </thead> <tbody> <tr> <td>0H2143A0</td> <td></td> <td>1</td> <td>PZ</td> </tr> <tr> <td>0H7820A0</td> <td>PLUS WASHING SY SUPPORT WITH STEAM VALVE</td> <td>1</td> <td>PZ</td> </tr> <tr> <td>EL1422A1</td> <td>1 WAY SOLENOID VALVE + D8-D10 REDUCTION</td> <td>1</td> <td>PZ</td> </tr> <tr> <td>EL1426A0</td> <td>H2O UL SOLENOID JG D8-PIPE HOLDER</td> <td>1</td> <td>PZ</td> </tr> <tr> <td>EL1426B0</td> <td>UL JG D8 WATER SOLENOID VALVE-PIPE HOLDER</td> <td>1</td> <td>PZ</td> </tr> <tr> <td>EL1437A0</td> <td>H2O SOLENOID JG D6 UL CHECK VALVE</td> <td>1</td> <td>PZ</td> </tr> <tr> <td>EL1437B0</td> <td>JG D8 WATER SOLENOID VALVE -BARBED D6 V</td> <td>1</td> <td>PZ</td> </tr> <tr> <td>GN1526A0</td> <td>INT. D.=6.9 TH=1.8 O-RIN</td> <td>1</td> <td>PZ</td> </tr> <tr> <td>RC1019A0</td> <td>D=10 ELASTIC CLAMP</td> <td>12</td> <td>PZ</td> </tr> <tr> <td>RC1130A0</td> <td>130X2,6 CLAM</td> <td>1</td> <td>PZ</td> </tr> <tr> <td>RC1242A0</td> <td>D=10 CLOSED CAP</td> <td>2</td> <td>PZ</td> </tr> <tr> <td>RC1356A0</td> <td>STRAIGHT THREADED FEMALE END 8X1/4" BSP</td> <td>1</td> <td>PZ</td> </tr> <tr> <td>TB2820A0</td> <td>PIPE EPDM FOR WASHING SYSTEM</td> <td>1.410</td> <td>M</td> </tr> <tr> <td>VI1220A1</td> <td>4,2X12 TCB SELF-TAPPIN G SCREW</td> <td>3</td> <td>PZ</td> </tr> <tr> <td>VL1019A0</td> <td>VIBRATION PUMP</td> <td>1</td> <td>PZ</td> </tr> <tr> <td>VL1064A0</td> <td>WASHING SYSTEM OUTLETS DISTRIBUTOR</td> <td>1</td> <td>PZ</td> </tr> <tr> <td>VL1065A1</td> <td>1/4 MALE N.O. PRESSURE SWITCH</td> <td>1</td> <td>PZ</td> </tr> </tbody> </table>	Code	Description	Qty	UOM	0H2143A0		1	PZ	0H7820A0	PLUS WASHING SY SUPPORT WITH STEAM VALVE	1	PZ	EL1422A1	1 WAY SOLENOID VALVE + D8-D10 REDUCTION	1	PZ	EL1426A0	H2O UL SOLENOID JG D8-PIPE HOLDER	1	PZ	EL1426B0	UL JG D8 WATER SOLENOID VALVE-PIPE HOLDER	1	PZ	EL1437A0	H2O SOLENOID JG D6 UL CHECK VALVE	1	PZ	EL1437B0	JG D8 WATER SOLENOID VALVE -BARBED D6 V	1	PZ	GN1526A0	INT. D.=6.9 TH=1.8 O-RIN	1	PZ	RC1019A0	D=10 ELASTIC CLAMP	12	PZ	RC1130A0	130X2,6 CLAM	1	PZ	RC1242A0	D=10 CLOSED CAP	2	PZ	RC1356A0	STRAIGHT THREADED FEMALE END 8X1/4" BSP	1	PZ	TB2820A0	PIPE EPDM FOR WASHING SYSTEM	1.410	M	VI1220A1	4,2X12 TCB SELF-TAPPIN G SCREW	3	PZ	VL1019A0	VIBRATION PUMP	1	PZ	VL1064A0	WASHING SYSTEM OUTLETS DISTRIBUTOR	1	PZ	VL1065A1	1/4 MALE N.O. PRESSURE SWITCH	1	PZ
					Code	Description	Qty	UOM																																																																					
					0H2143A0		1	PZ																																																																					
					0H7820A0	PLUS WASHING SY SUPPORT WITH STEAM VALVE	1	PZ																																																																					
					EL1422A1	1 WAY SOLENOID VALVE + D8-D10 REDUCTION	1	PZ																																																																					
					EL1426A0	H2O UL SOLENOID JG D8-PIPE HOLDER	1	PZ																																																																					
					EL1426B0	UL JG D8 WATER SOLENOID VALVE-PIPE HOLDER	1	PZ																																																																					
					EL1437A0	H2O SOLENOID JG D6 UL CHECK VALVE	1	PZ																																																																					
					EL1437B0	JG D8 WATER SOLENOID VALVE -BARBED D6 V	1	PZ																																																																					
					GN1526A0	INT. D.=6.9 TH=1.8 O-RIN	1	PZ																																																																					
					RC1019A0	D=10 ELASTIC CLAMP	12	PZ																																																																					
					RC1130A0	130X2,6 CLAM	1	PZ																																																																					
					RC1242A0	D=10 CLOSED CAP	2	PZ																																																																					
					RC1356A0	STRAIGHT THREADED FEMALE END 8X1/4" BSP	1	PZ																																																																					
					TB2820A0	PIPE EPDM FOR WASHING SYSTEM	1.410	M																																																																					
					VI1220A1	4,2X12 TCB SELF-TAPPIN G SCREW	3	PZ																																																																					
					VL1019A0	VIBRATION PUMP	1	PZ																																																																					
					VL1064A0	WASHING SYSTEM OUTLETS DISTRIBUTOR	1	PZ																																																																					
					VL1065A1	1/4 MALE N.O. PRESSURE SWITCH	1	PZ																																																																					





COMPONENT			SPARE PART																																																															
Code	Description	Image	Code	Description	Components list																																																													
0H7820A	PLUS WASHING SY SUPPORT WITH STEAM VALVE		KVL1104A	USA 1 ROTOR ARM PLUS CLEANING SYSTEM KIT	<table border="1"> <thead> <tr> <th>Code</th> <th>Description</th> <th>Qty</th> <th>UOM</th> </tr> </thead> <tbody> <tr> <td>VL1067A0</td> <td>WASHING SYSTEM INLETS DISTRIBUTOR</td> <td>1</td> <td>PZ</td> </tr> <tr> <td>VL1102A1</td> <td>DETERGENT LINE FILTER + BARBED VNR 6 MM</td> <td>1</td> <td>PZ</td> </tr> <tr> <td>VL1128A0</td> <td>D6 BARBED CHECK VALVE</td> <td>1</td> <td>PZ</td> </tr> <tr> <td>VL1128A1</td> <td>D6 BARBED CHECK VALVE</td> <td>1</td> <td>PZ</td> </tr> <tr> <td>VM2172A0</td> <td>PUMP-WITH-CI RCUIT LOCKING PIN</td> <td>1</td> <td>PZ</td> </tr> </tbody> </table>	Code	Description	Qty	UOM	VL1067A0	WASHING SYSTEM INLETS DISTRIBUTOR	1	PZ	VL1102A1	DETERGENT LINE FILTER + BARBED VNR 6 MM	1	PZ	VL1128A0	D6 BARBED CHECK VALVE	1	PZ	VL1128A1	D6 BARBED CHECK VALVE	1	PZ	VM2172A0	PUMP-WITH-CI RCUIT LOCKING PIN	1	PZ																																					
			Code	Description	Qty	UOM																																																												
VL1067A0	WASHING SYSTEM INLETS DISTRIBUTOR	1	PZ																																																															
VL1102A1	DETERGENT LINE FILTER + BARBED VNR 6 MM	1	PZ																																																															
VL1128A0	D6 BARBED CHECK VALVE	1	PZ																																																															
VL1128A1	D6 BARBED CHECK VALVE	1	PZ																																																															
VM2172A0	PUMP-WITH-CI RCUIT LOCKING PIN	1	PZ																																																															
KVL1103A	EUR 2ROTOR ARMS PLUS CLEANING SYSTEM KIT	<table border="1"> <thead> <tr> <th>Code</th> <th>Description</th> <th>Qty</th> <th>UOM</th> </tr> </thead> <tbody> <tr> <td>0H2143A0</td> <td></td> <td>1</td> <td>PZ</td> </tr> <tr> <td>0H7820A0</td> <td>PLUS WASHING SY SUPPORT WITH STEAM VALVE</td> <td>1</td> <td>PZ</td> </tr> <tr> <td>EL1252A1</td> <td>1 WAY WATER VALVE + J.G. CONNECTION</td> <td>1</td> <td>PZ</td> </tr> <tr> <td>EL1424A0</td> <td>D8 CONNECTION WATER SOLENOID VALVE</td> <td>2</td> <td>PZ</td> </tr> <tr> <td>EL1424B0</td> <td></td> <td>2</td> <td>PZ</td> </tr> <tr> <td>EL1436A0</td> <td>H2O SOLENOID JG D8 CHECK VALVE</td> <td>1</td> <td>PZ</td> </tr> <tr> <td>EL1436B0</td> <td></td> <td>1</td> <td>PZ</td> </tr> <tr> <td>GN1526A0</td> <td>INT. D.=6.9 TH=1.8 O-RIN</td> <td>1</td> <td>PZ</td> </tr> <tr> <td>RC1019A0</td> <td>D=10 ELASTIC CLAMP</td> <td>12</td> <td>PZ</td> </tr> <tr> <td>RC1130A0</td> <td>130X2,6 CLAM</td> <td>1</td> <td>PZ</td> </tr> <tr> <td>RC1242A0</td> <td>D=10 CLOSED CAP</td> <td>2</td> <td>PZ</td> </tr> <tr> <td>RC1356A0</td> <td>STRAIGHT THREADED FEMALE END 8X1/4" BSP</td> <td>1</td> <td>PZ</td> </tr> <tr> <td>TB2820A0</td> <td>PIPE EPDM FOR WASHING SYSTEM</td> <td>1.410</td> <td>M</td> </tr> <tr> <td>VI1220A1</td> <td>4,2X12 TCB SELF-TAPPIN G SCREW</td> <td>3</td> <td>PZ</td> </tr> <tr> <td>VL1019A0</td> <td>VIBRATION PUMP</td> <td>1</td> <td>PZ</td> </tr> </tbody> </table>	Code	Description	Qty	UOM	0H2143A0		1	PZ	0H7820A0	PLUS WASHING SY SUPPORT WITH STEAM VALVE	1	PZ	EL1252A1	1 WAY WATER VALVE + J.G. CONNECTION	1	PZ	EL1424A0	D8 CONNECTION WATER SOLENOID VALVE	2	PZ	EL1424B0		2	PZ	EL1436A0	H2O SOLENOID JG D8 CHECK VALVE	1	PZ	EL1436B0		1	PZ	GN1526A0	INT. D.=6.9 TH=1.8 O-RIN	1	PZ	RC1019A0	D=10 ELASTIC CLAMP	12	PZ	RC1130A0	130X2,6 CLAM	1	PZ	RC1242A0	D=10 CLOSED CAP	2	PZ	RC1356A0	STRAIGHT THREADED FEMALE END 8X1/4" BSP	1	PZ	TB2820A0	PIPE EPDM FOR WASHING SYSTEM	1.410	M	VI1220A1	4,2X12 TCB SELF-TAPPIN G SCREW	3	PZ	VL1019A0	VIBRATION PUMP	1	PZ
Code	Description	Qty	UOM																																																															
0H2143A0		1	PZ																																																															
0H7820A0	PLUS WASHING SY SUPPORT WITH STEAM VALVE	1	PZ																																																															
EL1252A1	1 WAY WATER VALVE + J.G. CONNECTION	1	PZ																																																															
EL1424A0	D8 CONNECTION WATER SOLENOID VALVE	2	PZ																																																															
EL1424B0		2	PZ																																																															
EL1436A0	H2O SOLENOID JG D8 CHECK VALVE	1	PZ																																																															
EL1436B0		1	PZ																																																															
GN1526A0	INT. D.=6.9 TH=1.8 O-RIN	1	PZ																																																															
RC1019A0	D=10 ELASTIC CLAMP	12	PZ																																																															
RC1130A0	130X2,6 CLAM	1	PZ																																																															
RC1242A0	D=10 CLOSED CAP	2	PZ																																																															
RC1356A0	STRAIGHT THREADED FEMALE END 8X1/4" BSP	1	PZ																																																															
TB2820A0	PIPE EPDM FOR WASHING SYSTEM	1.410	M																																																															
VI1220A1	4,2X12 TCB SELF-TAPPIN G SCREW	3	PZ																																																															
VL1019A0	VIBRATION PUMP	1	PZ																																																															



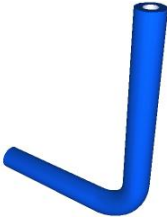

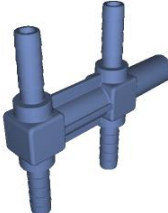
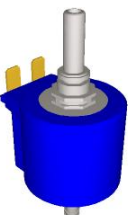
COMPONENT			SPARE PART																																																			
Code	Description	Image	Code	Description	Components list																																																	
0H7820A	PLUS WASHING SY SUPPORT WITH STEAM VALVE		KVL1103A	EUR 2 ROTOR ARMS PLUS CLEANING SYSTEM KIT	<table border="1"> <thead> <tr> <th>Code</th> <th>Description</th> <th>Qty</th> <th>UOM</th> </tr> </thead> <tbody> <tr> <td>VL1065A1</td> <td>1/4 MALE N.O. PRESSURE SWITCH</td> <td>1</td> <td>PZ</td> </tr> <tr> <td>VL1067A0</td> <td>WASHING SYSTEM INLETS DISTRIBUTOR</td> <td>1</td> <td>PZ</td> </tr> <tr> <td>VL1092A0</td> <td>WASHING SYSTEM OUTLET DOUBLE DISTRIBUTOR</td> <td>1</td> <td>PZ</td> </tr> <tr> <td>VL1102A1</td> <td>DETERGENT LINE FILTER + BARBED VNR 6 MM</td> <td>1</td> <td>PZ</td> </tr> <tr> <td>VL1128A0</td> <td>D6 BARBED CHECK VALVE</td> <td>1</td> <td>PZ</td> </tr> <tr> <td>VL1128A1</td> <td>D6 BARBED CHECK VALVE</td> <td>1</td> <td>PZ</td> </tr> <tr> <td>VM2172A0</td> <td>PUMP-WITH-CI RCUIT LOCKING PIN</td> <td>1</td> <td>PZ</td> </tr> </tbody> </table>	Code	Description	Qty	UOM	VL1065A1	1/4 MALE N.O. PRESSURE SWITCH	1	PZ	VL1067A0	WASHING SYSTEM INLETS DISTRIBUTOR	1	PZ	VL1092A0	WASHING SYSTEM OUTLET DOUBLE DISTRIBUTOR	1	PZ	VL1102A1	DETERGENT LINE FILTER + BARBED VNR 6 MM	1	PZ	VL1128A0	D6 BARBED CHECK VALVE	1	PZ	VL1128A1	D6 BARBED CHECK VALVE	1	PZ	VM2172A0	PUMP-WITH-CI RCUIT LOCKING PIN	1	PZ																	
			Code	Description	Qty	UOM																																																
VL1065A1	1/4 MALE N.O. PRESSURE SWITCH	1	PZ																																																			
VL1067A0	WASHING SYSTEM INLETS DISTRIBUTOR	1	PZ																																																			
VL1092A0	WASHING SYSTEM OUTLET DOUBLE DISTRIBUTOR	1	PZ																																																			
VL1102A1	DETERGENT LINE FILTER + BARBED VNR 6 MM	1	PZ																																																			
VL1128A0	D6 BARBED CHECK VALVE	1	PZ																																																			
VL1128A1	D6 BARBED CHECK VALVE	1	PZ																																																			
VM2172A0	PUMP-WITH-CI RCUIT LOCKING PIN	1	PZ																																																			
KVL1101A	EUR 1 ROTOR ARM PLUS CLEANING SYSTEM KIT	<table border="1"> <thead> <tr> <th>Code</th> <th>Description</th> <th>Qty</th> <th>UOM</th> </tr> </thead> <tbody> <tr> <td>0H2143A0</td> <td></td> <td>1</td> <td>PZ</td> </tr> <tr> <td>0H7820A0</td> <td>PLUS WASHING SY SUPPORT WITH STEAM VALVE</td> <td>1</td> <td>PZ</td> </tr> <tr> <td>EL1252A1</td> <td>1 WAY WATER VALVE + J.G. CONNECTION</td> <td>1</td> <td>PZ</td> </tr> <tr> <td>EL1424A0</td> <td>D8 CONNECTION WATER SOLENOID VALVE</td> <td>1</td> <td>PZ</td> </tr> <tr> <td>EL1424B0</td> <td></td> <td>1</td> <td>PZ</td> </tr> <tr> <td>EL1436A0</td> <td>H2O SOLENOID JG D8 CHECK VALVE</td> <td>1</td> <td>PZ</td> </tr> <tr> <td>EL1436B0</td> <td></td> <td>1</td> <td>PZ</td> </tr> <tr> <td>GN1526A0</td> <td>INT. D.=6.9 TH=1.8 O-RIN</td> <td>1</td> <td>PZ</td> </tr> <tr> <td>RC1019A0</td> <td>D=10 ELASTIC CLAMP</td> <td>12</td> <td>PZ</td> </tr> <tr> <td>RC1130A0</td> <td>130X2,6 CLAM</td> <td>1</td> <td>PZ</td> </tr> <tr> <td>RC1242A0</td> <td>D=10 CLOSED CAP</td> <td>2</td> <td>PZ</td> </tr> <tr> <td>RC1356A0</td> <td>STRAIGHT THREADED FEMALE END 8X1/4" BSP</td> <td>1</td> <td>PZ</td> </tr> </tbody> </table>	Code	Description	Qty	UOM	0H2143A0		1	PZ	0H7820A0	PLUS WASHING SY SUPPORT WITH STEAM VALVE	1	PZ	EL1252A1	1 WAY WATER VALVE + J.G. CONNECTION	1	PZ	EL1424A0	D8 CONNECTION WATER SOLENOID VALVE	1	PZ	EL1424B0		1	PZ	EL1436A0	H2O SOLENOID JG D8 CHECK VALVE	1	PZ	EL1436B0		1	PZ	GN1526A0	INT. D.=6.9 TH=1.8 O-RIN	1	PZ	RC1019A0	D=10 ELASTIC CLAMP	12	PZ	RC1130A0	130X2,6 CLAM	1	PZ	RC1242A0	D=10 CLOSED CAP	2	PZ	RC1356A0	STRAIGHT THREADED FEMALE END 8X1/4" BSP	1	PZ
Code	Description	Qty	UOM																																																			
0H2143A0		1	PZ																																																			
0H7820A0	PLUS WASHING SY SUPPORT WITH STEAM VALVE	1	PZ																																																			
EL1252A1	1 WAY WATER VALVE + J.G. CONNECTION	1	PZ																																																			
EL1424A0	D8 CONNECTION WATER SOLENOID VALVE	1	PZ																																																			
EL1424B0		1	PZ																																																			
EL1436A0	H2O SOLENOID JG D8 CHECK VALVE	1	PZ																																																			
EL1436B0		1	PZ																																																			
GN1526A0	INT. D.=6.9 TH=1.8 O-RIN	1	PZ																																																			
RC1019A0	D=10 ELASTIC CLAMP	12	PZ																																																			
RC1130A0	130X2,6 CLAM	1	PZ																																																			
RC1242A0	D=10 CLOSED CAP	2	PZ																																																			
RC1356A0	STRAIGHT THREADED FEMALE END 8X1/4" BSP	1	PZ																																																			

COMPONENT			SPARE PART																																														
Code	Description	Image	Code	Description	Components list																																												
0H7820A	PLUS WASHING SY SUPPORT WITH STEAM VALVE		KVL1101A	EUR 1 ROTOR ARM PLUS CLEANING SYSTEM KIT	<table border="1"> <thead> <tr> <th>Code</th> <th>Description</th> <th>Qty</th> <th>UOM</th> </tr> </thead> <tbody> <tr> <td>TB2820A0</td> <td>PIPE EPDM FOR WASHING SYSTEM</td> <td>1.410</td> <td>M</td> </tr> <tr> <td>VI1220A1</td> <td>4,2X12 TCB SELF-TAPPIN G SCREW</td> <td>3</td> <td>PZ</td> </tr> <tr> <td>VL1019A0</td> <td>VIBRATION PUMP</td> <td>1</td> <td>PZ</td> </tr> <tr> <td>VL1064A0</td> <td>WASHING SYSTEM OUTLETS DISTRIBUTOR</td> <td>1</td> <td>PZ</td> </tr> <tr> <td>VL1065A1</td> <td>1/4 MALE N.O. PRESSURE SWITCH</td> <td>1</td> <td>PZ</td> </tr> <tr> <td>VL1067A0</td> <td>WASHING SYSTEM INLETS DISTRIBUTOR</td> <td>1</td> <td>PZ</td> </tr> <tr> <td>VL1102A1</td> <td>DETERGENT LINE FILTER + BARBED VNR 6 MM</td> <td>1</td> <td>PZ</td> </tr> <tr> <td>VL1128A0</td> <td>D6 BARBED CHECK VALVE</td> <td>1</td> <td>PZ</td> </tr> <tr> <td>VL1128A1</td> <td>D6 BARBED CHECK VALVE</td> <td>1</td> <td>PZ</td> </tr> <tr> <td>VM2172A0</td> <td>PUMP-WITH-CI RCUIT LOCKING PIN</td> <td>1</td> <td>PZ</td> </tr> </tbody> </table>	Code	Description	Qty	UOM	TB2820A0	PIPE EPDM FOR WASHING SYSTEM	1.410	M	VI1220A1	4,2X12 TCB SELF-TAPPIN G SCREW	3	PZ	VL1019A0	VIBRATION PUMP	1	PZ	VL1064A0	WASHING SYSTEM OUTLETS DISTRIBUTOR	1	PZ	VL1065A1	1/4 MALE N.O. PRESSURE SWITCH	1	PZ	VL1067A0	WASHING SYSTEM INLETS DISTRIBUTOR	1	PZ	VL1102A1	DETERGENT LINE FILTER + BARBED VNR 6 MM	1	PZ	VL1128A0	D6 BARBED CHECK VALVE	1	PZ	VL1128A1	D6 BARBED CHECK VALVE	1	PZ	VM2172A0	PUMP-WITH-CI RCUIT LOCKING PIN	1	PZ
					Code	Description	Qty	UOM																																									
					TB2820A0	PIPE EPDM FOR WASHING SYSTEM	1.410	M																																									
					VI1220A1	4,2X12 TCB SELF-TAPPIN G SCREW	3	PZ																																									
					VL1019A0	VIBRATION PUMP	1	PZ																																									
					VL1064A0	WASHING SYSTEM OUTLETS DISTRIBUTOR	1	PZ																																									
					VL1065A1	1/4 MALE N.O. PRESSURE SWITCH	1	PZ																																									
					VL1067A0	WASHING SYSTEM INLETS DISTRIBUTOR	1	PZ																																									
					VL1102A1	DETERGENT LINE FILTER + BARBED VNR 6 MM	1	PZ																																									
					VL1128A0	D6 BARBED CHECK VALVE	1	PZ																																									
					VL1128A1	D6 BARBED CHECK VALVE	1	PZ																																									
					VM2172A0	PUMP-WITH-CI RCUIT LOCKING PIN	1	PZ																																									
					TB3005B	TB3132A-DETERGE NT PLUS WASHING		KTB3132A	WHITE-BLU 6X12 REINFORCED PIPE 3M KIT	<table border="1"> <thead> <tr> <th>Code</th> <th>Description</th> <th>Qty</th> <th>UOM</th> </tr> </thead> <tbody> <tr> <td>TB3132A0</td> <td>WHITE-BLUE EPDM TEXTILE BRAID HOSE 6X12</td> <td>3</td> <td>M</td> </tr> <tr> <td>VM1794A0</td> <td>250X4.8 PA66 BLACK CLAMP</td> <td>1</td> <td>PZ</td> </tr> </tbody> </table>	Code	Description	Qty	UOM	TB3132A0	WHITE-BLUE EPDM TEXTILE BRAID HOSE 6X12	3	M	VM1794A0	250X4.8 PA66 BLACK CLAMP	1	PZ																											
Code	Description	Qty	UOM																																														
TB3132A0	WHITE-BLUE EPDM TEXTILE BRAID HOSE 6X12	3	M																																														
VM1794A0	250X4.8 PA66 BLACK CLAMP	1	PZ																																														
TB3026C	TB3132A-WASHING PLUS INLET PIPE L=200		KVL0012A	KIT 100M TUBE 6X12	<table border="1"> <thead> <tr> <th>Code</th> <th>Description</th> <th>Qty</th> <th>UOM</th> </tr> </thead> <tbody> <tr> <td>TB3132A0</td> <td>WHITE-BLUE EPDM TEXTILE BRAID HOSE 6X12</td> <td>100</td> <td>M</td> </tr> <tr> <td>VM1059A1</td> <td>HEAT SHRINK FILM H800</td> <td>2</td> <td>M</td> </tr> </tbody> </table>	Code	Description	Qty	UOM	TB3132A0	WHITE-BLUE EPDM TEXTILE BRAID HOSE 6X12	100	M	VM1059A1	HEAT SHRINK FILM H800	2	M																																
					Code	Description	Qty	UOM																																									
			TB3132A0	WHITE-BLUE EPDM TEXTILE BRAID HOSE 6X12	100	M																																											
			VM1059A1	HEAT SHRINK FILM H800	2	M																																											
KTB3132A	WHITE-BLU 6X12 REINFORCED PIPE 3M KIT	<table border="1"> <thead> <tr> <th>Code</th> <th>Description</th> <th>Qty</th> <th>UOM</th> </tr> </thead> <tbody> <tr> <td>TB3132A0</td> <td>WHITE-BLUE EPDM TEXTILE BRAID HOSE 6X12</td> <td>3</td> <td>M</td> </tr> <tr> <td>VM1794A0</td> <td>250X4.8 PA66 BLACK CLAMP</td> <td>1</td> <td>PZ</td> </tr> </tbody> </table>	Code	Description	Qty	UOM	TB3132A0	WHITE-BLUE EPDM TEXTILE BRAID HOSE 6X12	3	M	VM1794A0	250X4.8 PA66 BLACK CLAMP	1	PZ																																			
		Code	Description	Qty	UOM																																												
TB3132A0	WHITE-BLUE EPDM TEXTILE BRAID HOSE 6X12	3	M																																														
VM1794A0	250X4.8 PA66 BLACK CLAMP	1	PZ																																														

COMPONENT			SPARE PART																																																						
Code	Description	Image	Code	Description	Components list																																																				
TB3024C			KTB1419A	TB1818A JG Ø8 WASHING PIPE 1,5M	<table border="1"> <thead> <tr> <th>Code</th> <th>Description</th> <th>Qty</th> <th>UOM</th> </tr> </thead> <tbody> <tr> <td>TB1818A0</td> <td>JG Ø8 BLUE PE PIPE</td> <td>1.500</td> <td>M</td> </tr> </tbody> </table>	Code	Description	Qty	UOM	TB1818A0	JG Ø8 BLUE PE PIPE	1.500	M																																												
			Code	Description	Qty	UOM																																																			
TB1818A0	JG Ø8 BLUE PE PIPE	1.500	M																																																						
KTB1349A	JGØ8 TB1818A WATER INLET PIPE L30M KIT	<table border="1"> <thead> <tr> <th>Code</th> <th>Description</th> <th>Qty</th> <th>UOM</th> </tr> </thead> <tbody> <tr> <td>TB1818A0</td> <td>JG Ø8 BLUE PE PIPE</td> <td>30</td> <td>M</td> </tr> </tbody> </table>	Code	Description	Qty	UOM	TB1818A0	JG Ø8 BLUE PE PIPE	30	M																																															
Code	Description	Qty	UOM																																																						
TB1818A0	JG Ø8 BLUE PE PIPE	30	M																																																						
VL1067A	WASHING SYSTEM INLETS DISTRIBUTO		KVL1073A	EUR 1 ROTOR ARM PLUS CHEMICAL PUMP KIT	<table border="1"> <thead> <tr> <th>Code</th> <th>Description</th> <th>Qty</th> <th>UOM</th> </tr> </thead> <tbody> <tr> <td>0H2143A0</td> <td></td> <td>1</td> <td>PZ</td> </tr> <tr> <td>GN1526A0</td> <td>INT. D.=6.9 TH=1.8 O-RIN</td> <td>1</td> <td>PZ</td> </tr> <tr> <td>RC1019A0</td> <td>D=10 ELASTIC CLAMP</td> <td>6</td> <td>PZ</td> </tr> <tr> <td>RC1130A0</td> <td>130X2,6 CLAM</td> <td>1</td> <td>PZ</td> </tr> <tr> <td>RC1242A0</td> <td>D=10 CLOSED CAP</td> <td>2</td> <td>PZ</td> </tr> <tr> <td>TB2820A0</td> <td>PIPE EPDM FOR WASHING SYSTEM</td> <td>0.120</td> <td>M</td> </tr> <tr> <td>VL1019A0</td> <td>VIBRATION PUMP</td> <td>1</td> <td>PZ</td> </tr> <tr> <td>VL1064A0</td> <td>WASHING SYSTEM OUTLETS DISTRIBUTOR</td> <td>1</td> <td>PZ</td> </tr> <tr> <td>VL1067A0</td> <td>WASHING SYSTEM INLETS DISTRIBUTOR</td> <td>1</td> <td>PZ</td> </tr> <tr> <td>VL1128A0</td> <td>D6 BARBED CHECK VALVE</td> <td>1</td> <td>PZ</td> </tr> <tr> <td>VL1128A1</td> <td>D6 BARBED CHECK VALVE</td> <td>1</td> <td>PZ</td> </tr> <tr> <td>VM2172A0</td> <td>PUMP-WITH-CI RCUIT LOCKING PIN</td> <td>1</td> <td>PZ</td> </tr> </tbody> </table>	Code	Description	Qty	UOM	0H2143A0		1	PZ	GN1526A0	INT. D.=6.9 TH=1.8 O-RIN	1	PZ	RC1019A0	D=10 ELASTIC CLAMP	6	PZ	RC1130A0	130X2,6 CLAM	1	PZ	RC1242A0	D=10 CLOSED CAP	2	PZ	TB2820A0	PIPE EPDM FOR WASHING SYSTEM	0.120	M	VL1019A0	VIBRATION PUMP	1	PZ	VL1064A0	WASHING SYSTEM OUTLETS DISTRIBUTOR	1	PZ	VL1067A0	WASHING SYSTEM INLETS DISTRIBUTOR	1	PZ	VL1128A0	D6 BARBED CHECK VALVE	1	PZ	VL1128A1	D6 BARBED CHECK VALVE	1	PZ	VM2172A0	PUMP-WITH-CI RCUIT LOCKING PIN	1	PZ
Code	Description	Qty	UOM																																																						
0H2143A0		1	PZ																																																						
GN1526A0	INT. D.=6.9 TH=1.8 O-RIN	1	PZ																																																						
RC1019A0	D=10 ELASTIC CLAMP	6	PZ																																																						
RC1130A0	130X2,6 CLAM	1	PZ																																																						
RC1242A0	D=10 CLOSED CAP	2	PZ																																																						
TB2820A0	PIPE EPDM FOR WASHING SYSTEM	0.120	M																																																						
VL1019A0	VIBRATION PUMP	1	PZ																																																						
VL1064A0	WASHING SYSTEM OUTLETS DISTRIBUTOR	1	PZ																																																						
VL1067A0	WASHING SYSTEM INLETS DISTRIBUTOR	1	PZ																																																						
VL1128A0	D6 BARBED CHECK VALVE	1	PZ																																																						
VL1128A1	D6 BARBED CHECK VALVE	1	PZ																																																						
VM2172A0	PUMP-WITH-CI RCUIT LOCKING PIN	1	PZ																																																						
VL1019A	VIBRATION PUMP		KVL1187A	2021 BIG-L CLEANING SYSTEM KIT	<table border="1"> <thead> <tr> <th>Code</th> <th>Description</th> <th>Qty</th> <th>UOM</th> </tr> </thead> <tbody> <tr> <td>0H2143A0</td> <td></td> <td>3</td> <td>PZ</td> </tr> <tr> <td>0H2168A0</td> <td></td> <td>1</td> <td>PZ</td> </tr> <tr> <td>0H2354A0</td> <td></td> <td>1</td> <td>PZ</td> </tr> <tr> <td>EL1120A0</td> <td>D8-D6 FEMALE STRAIGHT INTERM. CONNECTION</td> <td>1</td> <td>PZ</td> </tr> <tr> <td>EL1220A0</td> <td>JG STRAIGHT CONNECTION Ø8F-Ø8F</td> <td>2</td> <td>PZ</td> </tr> <tr> <td>EL1440A0</td> <td>WATER SELF CLEANING VALVE</td> <td>4</td> <td>PZ</td> </tr> <tr> <td>GN1526A0</td> <td>INT. D.=6.9 TH=1.8 O-RIN</td> <td>9</td> <td>PZ</td> </tr> </tbody> </table>	Code	Description	Qty	UOM	0H2143A0		3	PZ	0H2168A0		1	PZ	0H2354A0		1	PZ	EL1120A0	D8-D6 FEMALE STRAIGHT INTERM. CONNECTION	1	PZ	EL1220A0	JG STRAIGHT CONNECTION Ø8F-Ø8F	2	PZ	EL1440A0	WATER SELF CLEANING VALVE	4	PZ	GN1526A0	INT. D.=6.9 TH=1.8 O-RIN	9	PZ																				
Code	Description	Qty	UOM																																																						
0H2143A0		3	PZ																																																						
0H2168A0		1	PZ																																																						
0H2354A0		1	PZ																																																						
EL1120A0	D8-D6 FEMALE STRAIGHT INTERM. CONNECTION	1	PZ																																																						
EL1220A0	JG STRAIGHT CONNECTION Ø8F-Ø8F	2	PZ																																																						
EL1440A0	WATER SELF CLEANING VALVE	4	PZ																																																						
GN1526A0	INT. D.=6.9 TH=1.8 O-RIN	9	PZ																																																						

COMPONENT			SPARE PART																																																																														
Code	Description	Image	Code	Description	Components list																																																																												
VL1019A	VIBRATION PUMP		KVL1187A	2021 BIG-L CLEANING SYSTEM KIT	<table border="1"> <thead> <tr> <th>Code</th> <th>Description</th> <th>Qty</th> <th>UOM</th> </tr> </thead> <tbody> <tr> <td>RC1018A0</td> <td>ZINC PLATED D12 ELASTIC CLAMP</td> <td>10</td> <td>PZ</td> </tr> <tr> <td>RC1019A0</td> <td>D=10 ELASTIC CLAMP</td> <td>22</td> <td>PZ</td> </tr> <tr> <td>RC1130A0</td> <td>130X2,6 CLAM</td> <td>4</td> <td>PZ</td> </tr> <tr> <td>RC1131A0</td> <td></td> <td>3</td> <td>PZ</td> </tr> <tr> <td>RC1242A0</td> <td>D=10 CLOSED CAP</td> <td>2</td> <td>PZ</td> </tr> <tr> <td>RC1310A0</td> <td>140X4 CLAMP WITH CLIP</td> <td>1</td> <td>PZ</td> </tr> <tr> <td>RC1356A0</td> <td>STRAIGHT THREADED FEMALE END 8X1/4" BSP</td> <td>1</td> <td>PZ</td> </tr> <tr> <td>TB2820A0</td> <td>PIPE EPDM FOR WASHING SYSTEM</td> <td>1.510</td> <td>M</td> </tr> <tr> <td>TB3132A0</td> <td>WHITE-BLUE EPDM TEXTILE BRAID HOSE 6X12</td> <td>1.210</td> <td>M</td> </tr> <tr> <td>VH1220A1</td> <td>4,2X12 TCB SELF-TAPPIN G SCREW</td> <td>3</td> <td>PZ</td> </tr> <tr> <td>VL1019A0</td> <td>VIBRATION PUMP</td> <td>1</td> <td>PZ</td> </tr> <tr> <td>VL1046A1</td> <td>D6 PIPE HOLDER - D6 J.G. TERMINAL</td> <td>3</td> <td>PZ</td> </tr> <tr> <td>VL1047A1</td> <td>D6 PIPE HOLDER - D8 J.G. TERMINAL</td> <td>1</td> <td>PZ</td> </tr> <tr> <td>VL1064A0</td> <td>WASHING SYSTEM OUTLETS DISTRIBUTOR</td> <td>1</td> <td>PZ</td> </tr> <tr> <td>VL1065A1</td> <td>1/4 MALE N.O. PRESSURE SWITCH</td> <td>1</td> <td>PZ</td> </tr> <tr> <td>VL1067A0</td> <td>WASHING SYSTEM INLETS DISTRIBUTOR</td> <td>1</td> <td>PZ</td> </tr> <tr> <td>VL1092A0</td> <td>WASHING SYSTEM OUTLET DOUBLE DISTRIBUTOR</td> <td>1</td> <td>PZ</td> </tr> <tr> <td>VL1102A1</td> <td>DETERGENT LINE FILTER + BARBED VNR 6 MM</td> <td>1</td> <td>PZ</td> </tr> </tbody> </table>	Code	Description	Qty	UOM	RC1018A0	ZINC PLATED D12 ELASTIC CLAMP	10	PZ	RC1019A0	D=10 ELASTIC CLAMP	22	PZ	RC1130A0	130X2,6 CLAM	4	PZ	RC1131A0		3	PZ	RC1242A0	D=10 CLOSED CAP	2	PZ	RC1310A0	140X4 CLAMP WITH CLIP	1	PZ	RC1356A0	STRAIGHT THREADED FEMALE END 8X1/4" BSP	1	PZ	TB2820A0	PIPE EPDM FOR WASHING SYSTEM	1.510	M	TB3132A0	WHITE-BLUE EPDM TEXTILE BRAID HOSE 6X12	1.210	M	VH1220A1	4,2X12 TCB SELF-TAPPIN G SCREW	3	PZ	VL1019A0	VIBRATION PUMP	1	PZ	VL1046A1	D6 PIPE HOLDER - D6 J.G. TERMINAL	3	PZ	VL1047A1	D6 PIPE HOLDER - D8 J.G. TERMINAL	1	PZ	VL1064A0	WASHING SYSTEM OUTLETS DISTRIBUTOR	1	PZ	VL1065A1	1/4 MALE N.O. PRESSURE SWITCH	1	PZ	VL1067A0	WASHING SYSTEM INLETS DISTRIBUTOR	1	PZ	VL1092A0	WASHING SYSTEM OUTLET DOUBLE DISTRIBUTOR	1	PZ	VL1102A1	DETERGENT LINE FILTER + BARBED VNR 6 MM	1	PZ
Code	Description	Qty	UOM																																																																														
RC1018A0	ZINC PLATED D12 ELASTIC CLAMP	10	PZ																																																																														
RC1019A0	D=10 ELASTIC CLAMP	22	PZ																																																																														
RC1130A0	130X2,6 CLAM	4	PZ																																																																														
RC1131A0		3	PZ																																																																														
RC1242A0	D=10 CLOSED CAP	2	PZ																																																																														
RC1310A0	140X4 CLAMP WITH CLIP	1	PZ																																																																														
RC1356A0	STRAIGHT THREADED FEMALE END 8X1/4" BSP	1	PZ																																																																														
TB2820A0	PIPE EPDM FOR WASHING SYSTEM	1.510	M																																																																														
TB3132A0	WHITE-BLUE EPDM TEXTILE BRAID HOSE 6X12	1.210	M																																																																														
VH1220A1	4,2X12 TCB SELF-TAPPIN G SCREW	3	PZ																																																																														
VL1019A0	VIBRATION PUMP	1	PZ																																																																														
VL1046A1	D6 PIPE HOLDER - D6 J.G. TERMINAL	3	PZ																																																																														
VL1047A1	D6 PIPE HOLDER - D8 J.G. TERMINAL	1	PZ																																																																														
VL1064A0	WASHING SYSTEM OUTLETS DISTRIBUTOR	1	PZ																																																																														
VL1065A1	1/4 MALE N.O. PRESSURE SWITCH	1	PZ																																																																														
VL1067A0	WASHING SYSTEM INLETS DISTRIBUTOR	1	PZ																																																																														
VL1092A0	WASHING SYSTEM OUTLET DOUBLE DISTRIBUTOR	1	PZ																																																																														
VL1102A1	DETERGENT LINE FILTER + BARBED VNR 6 MM	1	PZ																																																																														

COMPONENT			SPARE PART																																																																																																									
Code	Description	Image	Code	Description	Components list																																																																																																							
VL1019A	VIBRATION PUMP		KVL1187A	2021 BIG-L CLEANING SYSTEM KIT	<table border="1"> <thead> <tr> <th>Code</th> <th>Description</th> <th>Qty</th> <th>UOM</th> </tr> </thead> <tbody> <tr> <td>VL1127A1</td> <td>6MM BARBED T-SHAPED FITTING</td> <td>2</td> <td>PZ</td> </tr> <tr> <td>VL1128A0</td> <td>D6 BARBED CHECK VALVE</td> <td>3</td> <td>PZ</td> </tr> <tr> <td>VL1128A1</td> <td>D6 BARBED CHECK VALVE</td> <td>3</td> <td>PZ</td> </tr> <tr> <td>VL1165A0</td> <td>BB6-AR6 STRAIGHT FITTING</td> <td>4</td> <td>PZ</td> </tr> <tr> <td>VL1166A0</td> <td>BB6-AR6 L FITTING</td> <td>4</td> <td>PZ</td> </tr> <tr> <td>VL1167A0</td> <td></td> <td>1</td> <td>PZ</td> </tr> <tr> <td>VL1174C0</td> <td>D1.2 MM CALIBRATED NOZZLE</td> <td>1</td> <td>PZ</td> </tr> <tr> <td>VL1185A0</td> <td>2 WAYS PLUS WASHING DISTRIBUTOR</td> <td>1</td> <td>PZ</td> </tr> <tr> <td>VL1186A0</td> <td>3 WAYS PLUS WASHING DISTRIBUTOR</td> <td>1</td> <td>PZ</td> </tr> <tr> <td>VL1190A0</td> <td>PLUS WASHING SYSTEM INLET DISTRIBUTOR</td> <td>1</td> <td>PZ</td> </tr> <tr> <td>VM1605A0</td> <td>CLIP TWIST LOCK DIAM. 10.2-12.7 MM</td> <td>3</td> <td>PZ</td> </tr> <tr> <td>VM2172A0</td> <td>PUMP-WITH-CI RCUIT LOCKING PIN</td> <td>9</td> <td>PZ</td> </tr> </tbody> </table>	Code	Description	Qty	UOM	VL1127A1	6MM BARBED T-SHAPED FITTING	2	PZ	VL1128A0	D6 BARBED CHECK VALVE	3	PZ	VL1128A1	D6 BARBED CHECK VALVE	3	PZ	VL1165A0	BB6-AR6 STRAIGHT FITTING	4	PZ	VL1166A0	BB6-AR6 L FITTING	4	PZ	VL1167A0		1	PZ	VL1174C0	D1.2 MM CALIBRATED NOZZLE	1	PZ	VL1185A0	2 WAYS PLUS WASHING DISTRIBUTOR	1	PZ	VL1186A0	3 WAYS PLUS WASHING DISTRIBUTOR	1	PZ	VL1190A0	PLUS WASHING SYSTEM INLET DISTRIBUTOR	1	PZ	VM1605A0	CLIP TWIST LOCK DIAM. 10.2-12.7 MM	3	PZ	VM2172A0	PUMP-WITH-CI RCUIT LOCKING PIN	9	PZ	KVL1184A	2011/16EU BIG-L CLEANING SYSTEM KIT	<table border="1"> <thead> <tr> <th>Code</th> <th>Description</th> <th>Qty</th> <th>UOM</th> </tr> </thead> <tbody> <tr> <td>0H2143A0</td> <td></td> <td>2</td> <td>PZ</td> </tr> <tr> <td>0H2168A0</td> <td></td> <td>1</td> <td>PZ</td> </tr> <tr> <td>0H2354A0</td> <td></td> <td>1</td> <td>PZ</td> </tr> <tr> <td>EL1220A0</td> <td>JG STRAIGHT CONNECTION Ø8F-Ø8F</td> <td>3</td> <td>PZ</td> </tr> <tr> <td>EL1440A0</td> <td>WATER SELF CLEANING VALVE</td> <td>4</td> <td>PZ</td> </tr> <tr> <td>GN1526A0</td> <td>INT. D.=6.9 TH=1.8 O-RIN</td> <td>9</td> <td>PZ</td> </tr> <tr> <td>RC1018A0</td> <td>ZINC PLATED D12 ELASTIC CLAMP</td> <td>2</td> <td>PZ</td> </tr> <tr> <td>RC1019A0</td> <td>D=10 ELASTIC CLAMP</td> <td>21</td> <td>PZ</td> </tr> <tr> <td>RC1130A0</td> <td>130X2,6 CLAM</td> <td>7</td> <td>PZ</td> </tr> <tr> <td>RC1131A0</td> <td></td> <td>3</td> <td>PZ</td> </tr> <tr> <td>RC1242A0</td> <td>D=10 CLOSED CAP</td> <td>2</td> <td>PZ</td> </tr> </tbody> </table>	Code	Description	Qty	UOM	0H2143A0		2	PZ	0H2168A0		1	PZ	0H2354A0		1	PZ	EL1220A0	JG STRAIGHT CONNECTION Ø8F-Ø8F	3	PZ	EL1440A0	WATER SELF CLEANING VALVE	4	PZ	GN1526A0	INT. D.=6.9 TH=1.8 O-RIN	9	PZ	RC1018A0	ZINC PLATED D12 ELASTIC CLAMP	2	PZ	RC1019A0	D=10 ELASTIC CLAMP	21	PZ	RC1130A0	130X2,6 CLAM	7	PZ	RC1131A0		3	PZ	RC1242A0	D=10 CLOSED CAP	2	PZ
			Code	Description	Qty	UOM																																																																																																						
VL1127A1	6MM BARBED T-SHAPED FITTING	2	PZ																																																																																																									
VL1128A0	D6 BARBED CHECK VALVE	3	PZ																																																																																																									
VL1128A1	D6 BARBED CHECK VALVE	3	PZ																																																																																																									
VL1165A0	BB6-AR6 STRAIGHT FITTING	4	PZ																																																																																																									
VL1166A0	BB6-AR6 L FITTING	4	PZ																																																																																																									
VL1167A0		1	PZ																																																																																																									
VL1174C0	D1.2 MM CALIBRATED NOZZLE	1	PZ																																																																																																									
VL1185A0	2 WAYS PLUS WASHING DISTRIBUTOR	1	PZ																																																																																																									
VL1186A0	3 WAYS PLUS WASHING DISTRIBUTOR	1	PZ																																																																																																									
VL1190A0	PLUS WASHING SYSTEM INLET DISTRIBUTOR	1	PZ																																																																																																									
VM1605A0	CLIP TWIST LOCK DIAM. 10.2-12.7 MM	3	PZ																																																																																																									
VM2172A0	PUMP-WITH-CI RCUIT LOCKING PIN	9	PZ																																																																																																									
Code	Description	Qty	UOM																																																																																																									
0H2143A0		2	PZ																																																																																																									
0H2168A0		1	PZ																																																																																																									
0H2354A0		1	PZ																																																																																																									
EL1220A0	JG STRAIGHT CONNECTION Ø8F-Ø8F	3	PZ																																																																																																									
EL1440A0	WATER SELF CLEANING VALVE	4	PZ																																																																																																									
GN1526A0	INT. D.=6.9 TH=1.8 O-RIN	9	PZ																																																																																																									
RC1018A0	ZINC PLATED D12 ELASTIC CLAMP	2	PZ																																																																																																									
RC1019A0	D=10 ELASTIC CLAMP	21	PZ																																																																																																									
RC1130A0	130X2,6 CLAM	7	PZ																																																																																																									
RC1131A0		3	PZ																																																																																																									
RC1242A0	D=10 CLOSED CAP	2	PZ																																																																																																									

COMPONENT			SPARE PART																																																																										
Code	Description	Image	Code	Description	Components list																																																																								
VL1019A	VIBRATION PUMP		KVL1184A	2011/16EU BIG-L CLEANING SYSTEM KIT	<table border="1"> <thead> <tr> <th>Code</th> <th>Description</th> <th>Qty</th> <th>UOM</th> </tr> </thead> <tbody> <tr> <td>RC1356A0</td> <td>STRAIGHT THREADED FEMALE END 8X1/4" BSP</td> <td>1</td> <td>PZ</td> </tr> <tr> <td>TB2820A0</td> <td>PIPE EPDM FOR WASHING SYSTEM</td> <td>2.400</td> <td>M</td> </tr> <tr> <td>TB3132A0</td> <td>WHITE-BLUE EPDM TEXTILE BRAID HOSE 6X12</td> <td>1.220</td> <td>M</td> </tr> <tr> <td>VL1019A0</td> <td>VIBRATION PUMP</td> <td>1</td> <td>PZ</td> </tr> <tr> <td>VL1046A1</td> <td>D6 PIPE HOLDER - D6 J.G. TERMINAL</td> <td>3</td> <td>PZ</td> </tr> <tr> <td>VL1047A1</td> <td>D6 PIPE HOLDER - D8 J.G. TERMINAL</td> <td>1</td> <td>PZ</td> </tr> <tr> <td>VL1065A1</td> <td>1/4 MALE N.O. PRESSURE SWITCH</td> <td>1</td> <td>PZ</td> </tr> <tr> <td>VL1067A0</td> <td>WASHING SYSTEM INLETS DISTRIBUTOR</td> <td>1</td> <td>PZ</td> </tr> <tr> <td>VL1092A0</td> <td>WASHING SYSTEM OUTLET DOUBLE DISTRIBUTOR</td> <td>1</td> <td>PZ</td> </tr> <tr> <td>VL1102A1</td> <td>DETERGENT LINE FILTER + BARBED VNR 6 MM</td> <td>1</td> <td>PZ</td> </tr> <tr> <td>VL1128A0</td> <td>D6 BARBED CHECK VALVE</td> <td>2</td> <td>PZ</td> </tr> <tr> <td>VL1128A1</td> <td>D6 BARBED CHECK VALVE</td> <td>2</td> <td>PZ</td> </tr> <tr> <td>VL1141A1</td> <td>STRAIGHT CONNECT BB6-BB6</td> <td>1</td> <td>PZ</td> </tr> <tr> <td>VL1165A0</td> <td>BB6-AR6 STRAIGHT FITTING</td> <td>4</td> <td>PZ</td> </tr> <tr> <td>VL1166A0</td> <td>BB6-AR6 L FITTING</td> <td>4</td> <td>PZ</td> </tr> <tr> <td>VL1174C0</td> <td>D1.2 MM CALIBRATED NOZZLE</td> <td>1</td> <td>PZ</td> </tr> <tr> <td>VL1186A0</td> <td>3 WAYS PLUS WASHING DISTRIBUTOR</td> <td>1</td> <td>PZ</td> </tr> </tbody> </table>	Code	Description	Qty	UOM	RC1356A0	STRAIGHT THREADED FEMALE END 8X1/4" BSP	1	PZ	TB2820A0	PIPE EPDM FOR WASHING SYSTEM	2.400	M	TB3132A0	WHITE-BLUE EPDM TEXTILE BRAID HOSE 6X12	1.220	M	VL1019A0	VIBRATION PUMP	1	PZ	VL1046A1	D6 PIPE HOLDER - D6 J.G. TERMINAL	3	PZ	VL1047A1	D6 PIPE HOLDER - D8 J.G. TERMINAL	1	PZ	VL1065A1	1/4 MALE N.O. PRESSURE SWITCH	1	PZ	VL1067A0	WASHING SYSTEM INLETS DISTRIBUTOR	1	PZ	VL1092A0	WASHING SYSTEM OUTLET DOUBLE DISTRIBUTOR	1	PZ	VL1102A1	DETERGENT LINE FILTER + BARBED VNR 6 MM	1	PZ	VL1128A0	D6 BARBED CHECK VALVE	2	PZ	VL1128A1	D6 BARBED CHECK VALVE	2	PZ	VL1141A1	STRAIGHT CONNECT BB6-BB6	1	PZ	VL1165A0	BB6-AR6 STRAIGHT FITTING	4	PZ	VL1166A0	BB6-AR6 L FITTING	4	PZ	VL1174C0	D1.2 MM CALIBRATED NOZZLE	1	PZ	VL1186A0	3 WAYS PLUS WASHING DISTRIBUTOR	1	PZ
Code	Description	Qty	UOM																																																																										
RC1356A0	STRAIGHT THREADED FEMALE END 8X1/4" BSP	1	PZ																																																																										
TB2820A0	PIPE EPDM FOR WASHING SYSTEM	2.400	M																																																																										
TB3132A0	WHITE-BLUE EPDM TEXTILE BRAID HOSE 6X12	1.220	M																																																																										
VL1019A0	VIBRATION PUMP	1	PZ																																																																										
VL1046A1	D6 PIPE HOLDER - D6 J.G. TERMINAL	3	PZ																																																																										
VL1047A1	D6 PIPE HOLDER - D8 J.G. TERMINAL	1	PZ																																																																										
VL1065A1	1/4 MALE N.O. PRESSURE SWITCH	1	PZ																																																																										
VL1067A0	WASHING SYSTEM INLETS DISTRIBUTOR	1	PZ																																																																										
VL1092A0	WASHING SYSTEM OUTLET DOUBLE DISTRIBUTOR	1	PZ																																																																										
VL1102A1	DETERGENT LINE FILTER + BARBED VNR 6 MM	1	PZ																																																																										
VL1128A0	D6 BARBED CHECK VALVE	2	PZ																																																																										
VL1128A1	D6 BARBED CHECK VALVE	2	PZ																																																																										
VL1141A1	STRAIGHT CONNECT BB6-BB6	1	PZ																																																																										
VL1165A0	BB6-AR6 STRAIGHT FITTING	4	PZ																																																																										
VL1166A0	BB6-AR6 L FITTING	4	PZ																																																																										
VL1174C0	D1.2 MM CALIBRATED NOZZLE	1	PZ																																																																										
VL1186A0	3 WAYS PLUS WASHING DISTRIBUTOR	1	PZ																																																																										

COMPONENT			SPARE PART																																																																											
Code	Description	Image	Code	Description	Components list																																																																									
VL1019A	VIBRATION PUMP		KVL1184A	2011/16EU BIG-L CLEANING SYSTEM KIT	<table border="1"> <thead> <tr> <th>Code</th> <th>Description</th> <th>Qty</th> <th>UOM</th> </tr> </thead> <tbody> <tr> <td>VL1190A0</td> <td>PLUS WASHING SYSTEM INLET DISTRIBUTOR</td> <td>1</td> <td>PZ</td> </tr> <tr> <td>VM1605A0</td> <td>CLIP TWIST LOCK DIAM. 10,2-12,7 MM</td> <td>4</td> <td>PZ</td> </tr> <tr> <td>VM2172A0</td> <td>PUMP-WITH-CI RCUIT LOCKING PIN</td> <td>9</td> <td>PZ</td> </tr> </tbody> </table>	Code	Description	Qty	UOM	VL1190A0	PLUS WASHING SYSTEM INLET DISTRIBUTOR	1	PZ	VM1605A0	CLIP TWIST LOCK DIAM. 10,2-12,7 MM	4	PZ	VM2172A0	PUMP-WITH-CI RCUIT LOCKING PIN	9	PZ																																																									
			Code	Description	Qty	UOM																																																																								
VL1190A0	PLUS WASHING SYSTEM INLET DISTRIBUTOR	1	PZ																																																																											
VM1605A0	CLIP TWIST LOCK DIAM. 10,2-12,7 MM	4	PZ																																																																											
VM2172A0	PUMP-WITH-CI RCUIT LOCKING PIN	9	PZ																																																																											
KVL1183A	1 ROTOR ARM PLUS CLEANING SYSTEM KIT	<table border="1"> <thead> <tr> <th>Code</th> <th>Description</th> <th>Qty</th> <th>UOM</th> </tr> </thead> <tbody> <tr> <td>0H2143A0</td> <td></td> <td>2</td> <td>PZ</td> </tr> <tr> <td>0H2168A1</td> <td></td> <td>1</td> <td>PZ</td> </tr> <tr> <td>0H2354A0</td> <td></td> <td>1</td> <td>PZ</td> </tr> <tr> <td>EL1440A0</td> <td>WATER SELF CLEANING VALVE</td> <td>3</td> <td>PZ</td> </tr> <tr> <td>GN1526A0</td> <td>INT. D.=6.9 TH=1.8 O-RIN</td> <td>7</td> <td>PZ</td> </tr> <tr> <td>RC1018A0</td> <td>ZINC PLATED D12 ELASTIC CLAMP</td> <td>2</td> <td>PZ</td> </tr> <tr> <td>RC1019A0</td> <td>D=10 ELASTIC CLAMP</td> <td>14</td> <td>PZ</td> </tr> <tr> <td>RC1130A0</td> <td>130X2,6 CLAM</td> <td>5</td> <td>PZ</td> </tr> <tr> <td>RC1131A0</td> <td></td> <td>2</td> <td>PZ</td> </tr> <tr> <td>RC1242A0</td> <td>D=10 CLOSED CAP</td> <td>2</td> <td>PZ</td> </tr> <tr> <td>RC1356A0</td> <td>STRAIGHT THREADED FEMALE END 8X1/4" BSP</td> <td>1</td> <td>PZ</td> </tr> <tr> <td>TB2820A0</td> <td>PIPE EPDM FOR WASHING SYSTEM</td> <td>1.410</td> <td>M</td> </tr> <tr> <td>TB3132A0</td> <td>WHITE-BLUE EPDM TEXTILE BRAID HOSE 6X12</td> <td>0.770</td> <td>M</td> </tr> <tr> <td>VI1220A1</td> <td>4,2X12 TCB SELF-TAPPIN G SCREW</td> <td>3</td> <td>PZ</td> </tr> <tr> <td>VL1019A0</td> <td>VIBRATION PUMP</td> <td>1</td> <td>PZ</td> </tr> <tr> <td>VL1047A1</td> <td>D6 PIPE HOLDER - D8 J.G. TERMINAL</td> <td>1</td> <td>PZ</td> </tr> <tr> <td>VL1065A1</td> <td>1/4 MALE N.O. PRESSURE SWITCH</td> <td>1</td> <td>PZ</td> </tr> <tr> <td>VL1102A1</td> <td>DETERGENT LINE FILTER + BARBED VNR 6 MM</td> <td>1</td> <td>PZ</td> </tr> </tbody> </table>	Code	Description	Qty	UOM	0H2143A0		2	PZ	0H2168A1		1	PZ	0H2354A0		1	PZ	EL1440A0	WATER SELF CLEANING VALVE	3	PZ	GN1526A0	INT. D.=6.9 TH=1.8 O-RIN	7	PZ	RC1018A0	ZINC PLATED D12 ELASTIC CLAMP	2	PZ	RC1019A0	D=10 ELASTIC CLAMP	14	PZ	RC1130A0	130X2,6 CLAM	5	PZ	RC1131A0		2	PZ	RC1242A0	D=10 CLOSED CAP	2	PZ	RC1356A0	STRAIGHT THREADED FEMALE END 8X1/4" BSP	1	PZ	TB2820A0	PIPE EPDM FOR WASHING SYSTEM	1.410	M	TB3132A0	WHITE-BLUE EPDM TEXTILE BRAID HOSE 6X12	0.770	M	VI1220A1	4,2X12 TCB SELF-TAPPIN G SCREW	3	PZ	VL1019A0	VIBRATION PUMP	1	PZ	VL1047A1	D6 PIPE HOLDER - D8 J.G. TERMINAL	1	PZ	VL1065A1	1/4 MALE N.O. PRESSURE SWITCH	1	PZ	VL1102A1	DETERGENT LINE FILTER + BARBED VNR 6 MM	1	PZ
Code	Description	Qty	UOM																																																																											
0H2143A0		2	PZ																																																																											
0H2168A1		1	PZ																																																																											
0H2354A0		1	PZ																																																																											
EL1440A0	WATER SELF CLEANING VALVE	3	PZ																																																																											
GN1526A0	INT. D.=6.9 TH=1.8 O-RIN	7	PZ																																																																											
RC1018A0	ZINC PLATED D12 ELASTIC CLAMP	2	PZ																																																																											
RC1019A0	D=10 ELASTIC CLAMP	14	PZ																																																																											
RC1130A0	130X2,6 CLAM	5	PZ																																																																											
RC1131A0		2	PZ																																																																											
RC1242A0	D=10 CLOSED CAP	2	PZ																																																																											
RC1356A0	STRAIGHT THREADED FEMALE END 8X1/4" BSP	1	PZ																																																																											
TB2820A0	PIPE EPDM FOR WASHING SYSTEM	1.410	M																																																																											
TB3132A0	WHITE-BLUE EPDM TEXTILE BRAID HOSE 6X12	0.770	M																																																																											
VI1220A1	4,2X12 TCB SELF-TAPPIN G SCREW	3	PZ																																																																											
VL1019A0	VIBRATION PUMP	1	PZ																																																																											
VL1047A1	D6 PIPE HOLDER - D8 J.G. TERMINAL	1	PZ																																																																											
VL1065A1	1/4 MALE N.O. PRESSURE SWITCH	1	PZ																																																																											
VL1102A1	DETERGENT LINE FILTER + BARBED VNR 6 MM	1	PZ																																																																											

COMPONENT			SPARE PART																																																			
Code	Description	Image	Code	Description	Components list																																																	
VL1019A	VIBRATION PUMP		KVL1183A	1 ROTOR ARM PLUS CLEANING SYSTEM KIT	<table border="1"> <thead> <tr> <th>Code</th> <th>Description</th> <th>Qty</th> <th>UOM</th> </tr> </thead> <tbody> <tr> <td>VL1128A0</td> <td>D6 BARBED CHECK VALVE</td> <td>2</td> <td>PZ</td> </tr> <tr> <td>VL1128A1</td> <td>D6 BARBED CHECK VALVE</td> <td>2</td> <td>PZ</td> </tr> <tr> <td>VL1165A0</td> <td>BB6-AR6 STRAIGHT FITTING</td> <td>1</td> <td>PZ</td> </tr> <tr> <td>VL1166A0</td> <td>BB6-AR6 L FITTING</td> <td>3</td> <td>PZ</td> </tr> <tr> <td>VL1174C0</td> <td>D1.2 MM CALIBRATED NOZZLE</td> <td>1</td> <td>PZ</td> </tr> <tr> <td>VL1185A0</td> <td>2 WAYS PLUS WASHING DISTRIBUTOR</td> <td>1</td> <td>PZ</td> </tr> <tr> <td>VL1190A0</td> <td>PLUS WASHING SYSTEM INLET DISTRIBUTOR</td> <td>1</td> <td>PZ</td> </tr> <tr> <td>VM1605A0</td> <td>CLIP TWIST LOCK DIAM. 10,2-12,7 MM</td> <td>3</td> <td>PZ</td> </tr> <tr> <td>VM2172A0</td> <td>PUMP-WITH-CI RCUIT LOCKING PIN</td> <td>7</td> <td>PZ</td> </tr> </tbody> </table>	Code	Description	Qty	UOM	VL1128A0	D6 BARBED CHECK VALVE	2	PZ	VL1128A1	D6 BARBED CHECK VALVE	2	PZ	VL1165A0	BB6-AR6 STRAIGHT FITTING	1	PZ	VL1166A0	BB6-AR6 L FITTING	3	PZ	VL1174C0	D1.2 MM CALIBRATED NOZZLE	1	PZ	VL1185A0	2 WAYS PLUS WASHING DISTRIBUTOR	1	PZ	VL1190A0	PLUS WASHING SYSTEM INLET DISTRIBUTOR	1	PZ	VM1605A0	CLIP TWIST LOCK DIAM. 10,2-12,7 MM	3	PZ	VM2172A0	PUMP-WITH-CI RCUIT LOCKING PIN	7	PZ									
			Code	Description	Qty	UOM																																																
VL1128A0	D6 BARBED CHECK VALVE	2	PZ																																																			
VL1128A1	D6 BARBED CHECK VALVE	2	PZ																																																			
VL1165A0	BB6-AR6 STRAIGHT FITTING	1	PZ																																																			
VL1166A0	BB6-AR6 L FITTING	3	PZ																																																			
VL1174C0	D1.2 MM CALIBRATED NOZZLE	1	PZ																																																			
VL1185A0	2 WAYS PLUS WASHING DISTRIBUTOR	1	PZ																																																			
VL1190A0	PLUS WASHING SYSTEM INLET DISTRIBUTOR	1	PZ																																																			
VM1605A0	CLIP TWIST LOCK DIAM. 10,2-12,7 MM	3	PZ																																																			
VM2172A0	PUMP-WITH-CI RCUIT LOCKING PIN	7	PZ																																																			
KVL1182A	ONE CLEANING SYSTEM KIT	<table border="1"> <thead> <tr> <th>Code</th> <th>Description</th> <th>Qty</th> <th>UOM</th> </tr> </thead> <tbody> <tr> <td>0H2143A0</td> <td></td> <td>2</td> <td>PZ</td> </tr> <tr> <td>0H2202A1</td> <td></td> <td>1</td> <td>PZ</td> </tr> <tr> <td>EL1440A0</td> <td>WATER SELF CLEANING VALVE</td> <td>1</td> <td>PZ</td> </tr> <tr> <td>GN1526A0</td> <td>INT. D.=6.9 TH=1.8 O-RING</td> <td>3</td> <td>PZ</td> </tr> <tr> <td>RC1018A0</td> <td>ZINC PLATED D12 ELASTIC CLAMP</td> <td>1</td> <td>PZ</td> </tr> <tr> <td>RC1019A0</td> <td>D=10 ELASTIC CLAMP</td> <td>14</td> <td>PZ</td> </tr> <tr> <td>RC1130A0</td> <td>130X2,6 CLAM</td> <td>2</td> <td>PZ</td> </tr> <tr> <td>RC1242A0</td> <td>D=10 CLOSED CAP</td> <td>2</td> <td>PZ</td> </tr> <tr> <td>TB2820A0</td> <td>PIPE EPDM FOR WASHING SYSTEM</td> <td>1.410</td> <td>M</td> </tr> <tr> <td>TB3132A0</td> <td>WHITE-BLUE EPDM TEXTILE BRAID HOSE 6X12</td> <td>0.670</td> <td>M</td> </tr> <tr> <td>VI1220A1</td> <td>4,2X12 TCB SELF-TAPPIN G SCREW</td> <td>1</td> <td>PZ</td> </tr> <tr> <td>VL1019A0</td> <td>VIBRATION PUMP</td> <td>1</td> <td>PZ</td> </tr> </tbody> </table>	Code	Description	Qty	UOM	0H2143A0		2	PZ	0H2202A1		1	PZ	EL1440A0	WATER SELF CLEANING VALVE	1	PZ	GN1526A0	INT. D.=6.9 TH=1.8 O-RING	3	PZ	RC1018A0	ZINC PLATED D12 ELASTIC CLAMP	1	PZ	RC1019A0	D=10 ELASTIC CLAMP	14	PZ	RC1130A0	130X2,6 CLAM	2	PZ	RC1242A0	D=10 CLOSED CAP	2	PZ	TB2820A0	PIPE EPDM FOR WASHING SYSTEM	1.410	M	TB3132A0	WHITE-BLUE EPDM TEXTILE BRAID HOSE 6X12	0.670	M	VI1220A1	4,2X12 TCB SELF-TAPPIN G SCREW	1	PZ	VL1019A0	VIBRATION PUMP	1	PZ
Code	Description	Qty	UOM																																																			
0H2143A0		2	PZ																																																			
0H2202A1		1	PZ																																																			
EL1440A0	WATER SELF CLEANING VALVE	1	PZ																																																			
GN1526A0	INT. D.=6.9 TH=1.8 O-RING	3	PZ																																																			
RC1018A0	ZINC PLATED D12 ELASTIC CLAMP	1	PZ																																																			
RC1019A0	D=10 ELASTIC CLAMP	14	PZ																																																			
RC1130A0	130X2,6 CLAM	2	PZ																																																			
RC1242A0	D=10 CLOSED CAP	2	PZ																																																			
TB2820A0	PIPE EPDM FOR WASHING SYSTEM	1.410	M																																																			
TB3132A0	WHITE-BLUE EPDM TEXTILE BRAID HOSE 6X12	0.670	M																																																			
VI1220A1	4,2X12 TCB SELF-TAPPIN G SCREW	1	PZ																																																			
VL1019A0	VIBRATION PUMP	1	PZ																																																			

COMPONENT			SPARE PART																																																																																	
Code	Description	Image	Code	Description	Components list																																																																															
VL1019A	VIBRATION PUMP		KVL1182A	ONE CLEANING SYSTEM KIT	<table border="1"> <thead> <tr> <th>Code</th> <th>Description</th> <th>Qty</th> <th>UOM</th> </tr> </thead> <tbody> <tr> <td>VL1047A1</td> <td>D6 PIPE HOLDER - D8 J.G. TERMINAL</td> <td>1</td> <td>PZ</td> </tr> <tr> <td>VL1054B0</td> <td>ONE WASHING SYS INLET DISTRIBUTOR</td> <td>1</td> <td>PZ</td> </tr> <tr> <td>VL1102A1</td> <td>DETERGENT LINE FILTER + BARBED VNR 6 MM</td> <td>1</td> <td>PZ</td> </tr> <tr> <td>VL1128A0</td> <td>D6 BARBED CHECK VALVE</td> <td>2</td> <td>PZ</td> </tr> <tr> <td>VL1128A1</td> <td>D6 BARBED CHECK VALVE</td> <td>2</td> <td>PZ</td> </tr> <tr> <td>VL1165A0</td> <td>BB6-AR6 STRAIGHT FITTING</td> <td>1</td> <td>PZ</td> </tr> <tr> <td>VL1166A0</td> <td>BB6-AR6 L FITTING</td> <td>1</td> <td>PZ</td> </tr> <tr> <td>VL1174C0</td> <td>D1.2 MM CALIBRATED NOZZLE</td> <td>1</td> <td>PZ</td> </tr> <tr> <td>VL1191A0</td> <td>ONE WASHING DISTRIBUTOR OUTLETS KIT</td> <td>1</td> <td>PZ</td> </tr> <tr> <td>VM1605A0</td> <td>CLIP TWIST LOCK DIAM. 10.2-12.7 MM</td> <td>3</td> <td>PZ</td> </tr> <tr> <td>VM2172A0</td> <td>PUMP-WITH-CI RCUIT LOCKING PIN</td> <td>2</td> <td>PZ</td> </tr> </tbody> </table>	Code	Description	Qty	UOM	VL1047A1	D6 PIPE HOLDER - D8 J.G. TERMINAL	1	PZ	VL1054B0	ONE WASHING SYS INLET DISTRIBUTOR	1	PZ	VL1102A1	DETERGENT LINE FILTER + BARBED VNR 6 MM	1	PZ	VL1128A0	D6 BARBED CHECK VALVE	2	PZ	VL1128A1	D6 BARBED CHECK VALVE	2	PZ	VL1165A0	BB6-AR6 STRAIGHT FITTING	1	PZ	VL1166A0	BB6-AR6 L FITTING	1	PZ	VL1174C0	D1.2 MM CALIBRATED NOZZLE	1	PZ	VL1191A0	ONE WASHING DISTRIBUTOR OUTLETS KIT	1	PZ	VM1605A0	CLIP TWIST LOCK DIAM. 10.2-12.7 MM	3	PZ	VM2172A0	PUMP-WITH-CI RCUIT LOCKING PIN	2	PZ	KVL1122A	USA HOOD CLEANING SYSTEM KIT	<table border="1"> <thead> <tr> <th>Code</th> <th>Description</th> <th>Qty</th> <th>UOM</th> </tr> </thead> <tbody> <tr> <td>0H7368A0</td> <td>S6 HOOD WATER SYSTEM PLAT</td> <td>1</td> <td>PZ</td> </tr> <tr> <td>EL1426B0</td> <td>UL JG D8 WATER SOLENOID VALVE-PIPE HOLDER</td> <td>1</td> <td>PZ</td> </tr> <tr> <td>EL1437B0</td> <td>JG D8 WATER SOLENOID VALVE -BARBED D6 V</td> <td>1</td> <td>PZ</td> </tr> <tr> <td>GN1526A0</td> <td>INT. D.=6.9 TH=1.8 O-RIN</td> <td>1</td> <td>PZ</td> </tr> <tr> <td>RC1018A0</td> <td>ZINC PLATED D12 ELASTIC CLAMP</td> <td>2</td> <td>PZ</td> </tr> <tr> <td>RC1019A0</td> <td>D=10 ELASTIC CLAMP</td> <td>12</td> <td>PZ</td> </tr> </tbody> </table>	Code	Description	Qty	UOM	0H7368A0	S6 HOOD WATER SYSTEM PLAT	1	PZ	EL1426B0	UL JG D8 WATER SOLENOID VALVE-PIPE HOLDER	1	PZ	EL1437B0	JG D8 WATER SOLENOID VALVE -BARBED D6 V	1	PZ	GN1526A0	INT. D.=6.9 TH=1.8 O-RIN	1	PZ	RC1018A0	ZINC PLATED D12 ELASTIC CLAMP	2	PZ	RC1019A0	D=10 ELASTIC CLAMP	12	PZ
			Code	Description	Qty	UOM																																																																														
VL1047A1	D6 PIPE HOLDER - D8 J.G. TERMINAL	1	PZ																																																																																	
VL1054B0	ONE WASHING SYS INLET DISTRIBUTOR	1	PZ																																																																																	
VL1102A1	DETERGENT LINE FILTER + BARBED VNR 6 MM	1	PZ																																																																																	
VL1128A0	D6 BARBED CHECK VALVE	2	PZ																																																																																	
VL1128A1	D6 BARBED CHECK VALVE	2	PZ																																																																																	
VL1165A0	BB6-AR6 STRAIGHT FITTING	1	PZ																																																																																	
VL1166A0	BB6-AR6 L FITTING	1	PZ																																																																																	
VL1174C0	D1.2 MM CALIBRATED NOZZLE	1	PZ																																																																																	
VL1191A0	ONE WASHING DISTRIBUTOR OUTLETS KIT	1	PZ																																																																																	
VM1605A0	CLIP TWIST LOCK DIAM. 10.2-12.7 MM	3	PZ																																																																																	
VM2172A0	PUMP-WITH-CI RCUIT LOCKING PIN	2	PZ																																																																																	
Code	Description	Qty	UOM																																																																																	
0H7368A0	S6 HOOD WATER SYSTEM PLAT	1	PZ																																																																																	
EL1426B0	UL JG D8 WATER SOLENOID VALVE-PIPE HOLDER	1	PZ																																																																																	
EL1437B0	JG D8 WATER SOLENOID VALVE -BARBED D6 V	1	PZ																																																																																	
GN1526A0	INT. D.=6.9 TH=1.8 O-RIN	1	PZ																																																																																	
RC1018A0	ZINC PLATED D12 ELASTIC CLAMP	2	PZ																																																																																	
RC1019A0	D=10 ELASTIC CLAMP	12	PZ																																																																																	

COMPONENT			SPARE PART																																																																										
Code	Description	Image	Code	Description	Components list																																																																								
VL1019A	VIBRATION PUMP		KVL1122A	USA HOOD CLEANING SYSTEM KIT	<table border="1"> <thead> <tr> <th>Code</th> <th>Description</th> <th>Qty</th> <th>UOM</th> </tr> </thead> <tbody> <tr> <td>RC1242A0</td> <td>D=10 CLOSED CAP</td> <td>2</td> <td>PZ</td> </tr> <tr> <td>RC1408A0</td> <td>DOUBLE WIRE SPRING CLAMP D10.8 ZN</td> <td>2</td> <td>PZ</td> </tr> <tr> <td>RC1414A0</td> <td></td> <td>2</td> <td>PZ</td> </tr> <tr> <td>TB2820A0</td> <td>PIPE EPDM FOR WASHING SYSTEM</td> <td>2.200</td> <td>M</td> </tr> <tr> <td>TB3132A0</td> <td>WHITE-BLUE EPDM TEXTILE BRAID HOSE 6X12</td> <td>0.540</td> <td>M</td> </tr> <tr> <td>VI1220A1</td> <td>4,2X12 TCB SELF-TAPPIN G SCREW</td> <td>5</td> <td>PZ</td> </tr> <tr> <td>VL1019A0</td> <td>VIBRATION PUMP</td> <td>1</td> <td>PZ</td> </tr> <tr> <td>VL1047A1</td> <td>D6 PIPE HOLDER - D8 J.G. TERMINAL</td> <td>2</td> <td>PZ</td> </tr> <tr> <td>VL1053B0</td> <td>ONE WASHING SYS EXT DISTRIBUTOR</td> <td>1</td> <td>PZ</td> </tr> <tr> <td>VL1054B0</td> <td>ONE WASHING SYS INLET DISTRIBUTOR</td> <td>1</td> <td>PZ</td> </tr> <tr> <td>VL1081A0</td> <td>D6 BARBED NO RETURN VALVE</td> <td>1</td> <td>PZ</td> </tr> <tr> <td>VL1102A1</td> <td>DETERGENT LINE FILTER + BARBED VNR 6 MM</td> <td>1</td> <td>PZ</td> </tr> <tr> <td>VL1127A1</td> <td>6MM BARBED T-SHAPED FITTING</td> <td>1</td> <td>PZ</td> </tr> <tr> <td>VL1128A0</td> <td>D6 BARBED CHECK VALVE</td> <td>1</td> <td>PZ</td> </tr> <tr> <td>VL1128A1</td> <td>D6 BARBED CHECK VALVE</td> <td>1</td> <td>PZ</td> </tr> <tr> <td>VM1605A0</td> <td>CLIP TWIST LOCK DIAM. 10,2-12,7 MM</td> <td>2</td> <td>PZ</td> </tr> <tr> <td>VM2172A0</td> <td>PUMP-WITH-CI RCUIT LOCKING PIN</td> <td>1</td> <td>PZ</td> </tr> </tbody> </table>	Code	Description	Qty	UOM	RC1242A0	D=10 CLOSED CAP	2	PZ	RC1408A0	DOUBLE WIRE SPRING CLAMP D10.8 ZN	2	PZ	RC1414A0		2	PZ	TB2820A0	PIPE EPDM FOR WASHING SYSTEM	2.200	M	TB3132A0	WHITE-BLUE EPDM TEXTILE BRAID HOSE 6X12	0.540	M	VI1220A1	4,2X12 TCB SELF-TAPPIN G SCREW	5	PZ	VL1019A0	VIBRATION PUMP	1	PZ	VL1047A1	D6 PIPE HOLDER - D8 J.G. TERMINAL	2	PZ	VL1053B0	ONE WASHING SYS EXT DISTRIBUTOR	1	PZ	VL1054B0	ONE WASHING SYS INLET DISTRIBUTOR	1	PZ	VL1081A0	D6 BARBED NO RETURN VALVE	1	PZ	VL1102A1	DETERGENT LINE FILTER + BARBED VNR 6 MM	1	PZ	VL1127A1	6MM BARBED T-SHAPED FITTING	1	PZ	VL1128A0	D6 BARBED CHECK VALVE	1	PZ	VL1128A1	D6 BARBED CHECK VALVE	1	PZ	VM1605A0	CLIP TWIST LOCK DIAM. 10,2-12,7 MM	2	PZ	VM2172A0	PUMP-WITH-CI RCUIT LOCKING PIN	1	PZ
Code	Description	Qty	UOM																																																																										
RC1242A0	D=10 CLOSED CAP	2	PZ																																																																										
RC1408A0	DOUBLE WIRE SPRING CLAMP D10.8 ZN	2	PZ																																																																										
RC1414A0		2	PZ																																																																										
TB2820A0	PIPE EPDM FOR WASHING SYSTEM	2.200	M																																																																										
TB3132A0	WHITE-BLUE EPDM TEXTILE BRAID HOSE 6X12	0.540	M																																																																										
VI1220A1	4,2X12 TCB SELF-TAPPIN G SCREW	5	PZ																																																																										
VL1019A0	VIBRATION PUMP	1	PZ																																																																										
VL1047A1	D6 PIPE HOLDER - D8 J.G. TERMINAL	2	PZ																																																																										
VL1053B0	ONE WASHING SYS EXT DISTRIBUTOR	1	PZ																																																																										
VL1054B0	ONE WASHING SYS INLET DISTRIBUTOR	1	PZ																																																																										
VL1081A0	D6 BARBED NO RETURN VALVE	1	PZ																																																																										
VL1102A1	DETERGENT LINE FILTER + BARBED VNR 6 MM	1	PZ																																																																										
VL1127A1	6MM BARBED T-SHAPED FITTING	1	PZ																																																																										
VL1128A0	D6 BARBED CHECK VALVE	1	PZ																																																																										
VL1128A1	D6 BARBED CHECK VALVE	1	PZ																																																																										
VM1605A0	CLIP TWIST LOCK DIAM. 10,2-12,7 MM	2	PZ																																																																										
VM2172A0	PUMP-WITH-CI RCUIT LOCKING PIN	1	PZ																																																																										

COMPONENT			SPARE PART																																																																																		
Code	Description	Image	Code	Description	Components list																																																																																
VL1019A	VIBRATION PUMP		KVL1121A	EUR MIND.MAPS HOOD CLEANING SYSTEM KIT	<table border="1"> <thead> <tr> <th>Code</th> <th>Description</th> <th>Qty</th> <th>UOM</th> </tr> </thead> <tbody> <tr> <td>0H2143A0</td> <td></td> <td>1</td> <td>PZ</td> </tr> <tr> <td>0H7368A0</td> <td>S6 HOOD WATER SYSTEM PLAT</td> <td>1</td> <td>PZ</td> </tr> <tr> <td>EL1424A0</td> <td>D8 CONNECTION WATER SOLENOID VALVE</td> <td>1</td> <td>PZ</td> </tr> <tr> <td>EL1424B0</td> <td></td> <td>1</td> <td>PZ</td> </tr> <tr> <td>EL1436A0</td> <td>H2O SOLENOID JG D8 CHECK VALVE</td> <td>1</td> <td>PZ</td> </tr> <tr> <td>EL1436B0</td> <td></td> <td>1</td> <td>PZ</td> </tr> <tr> <td>GN1526A0</td> <td>INT. D.=6.9 TH=1.8 O-RIN</td> <td>1</td> <td>PZ</td> </tr> <tr> <td>RC1019A0</td> <td>D=10 ELASTIC CLAMP</td> <td>12</td> <td>PZ</td> </tr> <tr> <td>RC1242A0</td> <td>D=10 CLOSED CAP</td> <td>2</td> <td>PZ</td> </tr> <tr> <td>RC1408A0</td> <td>DOUBLE WIRE SPRING CLAMP D10.8 ZN</td> <td>2</td> <td>PZ</td> </tr> <tr> <td>TB2820A0</td> <td>PIPE EPDM FOR WASHING SYSTEM</td> <td>2.200</td> <td>M</td> </tr> <tr> <td>VH1220A1</td> <td>4,2X12 TCB SELF-TAPPIN G SCREW</td> <td>5</td> <td>PZ</td> </tr> <tr> <td>VL1019A0</td> <td>VIBRATION PUMP</td> <td>1</td> <td>PZ</td> </tr> <tr> <td>VL1053B0</td> <td>ONE WASHING SYS EXT DISTRIBUTOR</td> <td>1</td> <td>PZ</td> </tr> <tr> <td>VL1054B0</td> <td>ONE WASHING SYS INLET DISTRIBUTOR</td> <td>1</td> <td>PZ</td> </tr> <tr> <td>VL1102A1</td> <td>DETERGENT LINE FILTER + BARBED VNR 6 MM</td> <td>1</td> <td>PZ</td> </tr> <tr> <td>VL1128A0</td> <td>D6 BARBED CHECK VALVE</td> <td>1</td> <td>PZ</td> </tr> <tr> <td>VL1128A1</td> <td>D6 BARBED CHECK VALVE</td> <td>1</td> <td>PZ</td> </tr> <tr> <td>VM2172A0</td> <td>PUMP-WITH-CI RCUIT LOCKING PIN</td> <td>1</td> <td>PZ</td> </tr> </tbody> </table>	Code	Description	Qty	UOM	0H2143A0		1	PZ	0H7368A0	S6 HOOD WATER SYSTEM PLAT	1	PZ	EL1424A0	D8 CONNECTION WATER SOLENOID VALVE	1	PZ	EL1424B0		1	PZ	EL1436A0	H2O SOLENOID JG D8 CHECK VALVE	1	PZ	EL1436B0		1	PZ	GN1526A0	INT. D.=6.9 TH=1.8 O-RIN	1	PZ	RC1019A0	D=10 ELASTIC CLAMP	12	PZ	RC1242A0	D=10 CLOSED CAP	2	PZ	RC1408A0	DOUBLE WIRE SPRING CLAMP D10.8 ZN	2	PZ	TB2820A0	PIPE EPDM FOR WASHING SYSTEM	2.200	M	VH1220A1	4,2X12 TCB SELF-TAPPIN G SCREW	5	PZ	VL1019A0	VIBRATION PUMP	1	PZ	VL1053B0	ONE WASHING SYS EXT DISTRIBUTOR	1	PZ	VL1054B0	ONE WASHING SYS INLET DISTRIBUTOR	1	PZ	VL1102A1	DETERGENT LINE FILTER + BARBED VNR 6 MM	1	PZ	VL1128A0	D6 BARBED CHECK VALVE	1	PZ	VL1128A1	D6 BARBED CHECK VALVE	1	PZ	VM2172A0	PUMP-WITH-CI RCUIT LOCKING PIN	1	PZ
Code	Description	Qty	UOM																																																																																		
0H2143A0		1	PZ																																																																																		
0H7368A0	S6 HOOD WATER SYSTEM PLAT	1	PZ																																																																																		
EL1424A0	D8 CONNECTION WATER SOLENOID VALVE	1	PZ																																																																																		
EL1424B0		1	PZ																																																																																		
EL1436A0	H2O SOLENOID JG D8 CHECK VALVE	1	PZ																																																																																		
EL1436B0		1	PZ																																																																																		
GN1526A0	INT. D.=6.9 TH=1.8 O-RIN	1	PZ																																																																																		
RC1019A0	D=10 ELASTIC CLAMP	12	PZ																																																																																		
RC1242A0	D=10 CLOSED CAP	2	PZ																																																																																		
RC1408A0	DOUBLE WIRE SPRING CLAMP D10.8 ZN	2	PZ																																																																																		
TB2820A0	PIPE EPDM FOR WASHING SYSTEM	2.200	M																																																																																		
VH1220A1	4,2X12 TCB SELF-TAPPIN G SCREW	5	PZ																																																																																		
VL1019A0	VIBRATION PUMP	1	PZ																																																																																		
VL1053B0	ONE WASHING SYS EXT DISTRIBUTOR	1	PZ																																																																																		
VL1054B0	ONE WASHING SYS INLET DISTRIBUTOR	1	PZ																																																																																		
VL1102A1	DETERGENT LINE FILTER + BARBED VNR 6 MM	1	PZ																																																																																		
VL1128A0	D6 BARBED CHECK VALVE	1	PZ																																																																																		
VL1128A1	D6 BARBED CHECK VALVE	1	PZ																																																																																		
VM2172A0	PUMP-WITH-CI RCUIT LOCKING PIN	1	PZ																																																																																		

COMPONENT			SPARE PART																																																																						
Code	Description	Image	Code	Description	Components list																																																																				
VL1019A	VIBRATION PUMP		KVL1120A	USA COMPACT PLUS CLEANING SYSTEM KIT	<table border="1"> <thead> <tr> <th>Code</th> <th>Description</th> <th>Qty</th> <th>UOM</th> </tr> </thead> <tbody> <tr> <td>0H2143A0</td> <td></td> <td>1</td> <td>PZ</td> </tr> <tr> <td>0H7553D0</td> <td>XECC PLUS WASHING SYSTEM PLAT</td> <td>1</td> <td>PZ</td> </tr> <tr> <td>EL1422A1</td> <td>1 WAY SOLENOID VALVE + D8-D10 REDUCTION</td> <td>1</td> <td>PZ</td> </tr> <tr> <td>EL1426A0</td> <td>H2O UL SOLENOID JG D8-PIPE HOLDER</td> <td>1</td> <td>PZ</td> </tr> <tr> <td>EL1426B0</td> <td>UL JG D8 WATER SLENOID VALVE-PIPE HOLDER</td> <td>1</td> <td>PZ</td> </tr> <tr> <td>EL1437A0</td> <td>H2O SOLENOID JG D6 UL CHECK VALVE</td> <td>1</td> <td>PZ</td> </tr> <tr> <td>EL1437B0</td> <td>JG D8 WATER SOLENOID VALVE -BARBED D6 V</td> <td>1</td> <td>PZ</td> </tr> <tr> <td>GN1312A0</td> <td>RUBBER CABLE-PASSI NG DE=26 DI=15 SP=10</td> <td>1</td> <td>PZ</td> </tr> <tr> <td>GN1526A0</td> <td>INT. D.=6.9 TH=1.8 O-RIN</td> <td>1</td> <td>PZ</td> </tr> <tr> <td>RC1019A0</td> <td>D=10 ELASTIC CLAMP</td> <td>10</td> <td>PZ</td> </tr> <tr> <td>RC1242A0</td> <td>D=10 CLOSED CAP</td> <td>2</td> <td>PZ</td> </tr> <tr> <td>RC1356A0</td> <td>STRAIGHT THREADED FEMALE END 8X1/4" BSP</td> <td>1</td> <td>PZ</td> </tr> <tr> <td>TB2820A0</td> <td>PIPE EPDM FOR WASHING SYSTEM</td> <td>1.200</td> <td>M</td> </tr> <tr> <td>VH1220A1</td> <td>4,2X12 TCB SELF-TAPPIN G SCREW</td> <td>9</td> <td>PZ</td> </tr> <tr> <td>VL1019A0</td> <td>VIBRATION PUMP</td> <td>1</td> <td>PZ</td> </tr> <tr> <td>VL1054B0</td> <td>ONE WASHING SYS INLET DISTRIBUTOR</td> <td>1</td> <td>PZ</td> </tr> </tbody> </table>	Code	Description	Qty	UOM	0H2143A0		1	PZ	0H7553D0	XECC PLUS WASHING SYSTEM PLAT	1	PZ	EL1422A1	1 WAY SOLENOID VALVE + D8-D10 REDUCTION	1	PZ	EL1426A0	H2O UL SOLENOID JG D8-PIPE HOLDER	1	PZ	EL1426B0	UL JG D8 WATER SLENOID VALVE-PIPE HOLDER	1	PZ	EL1437A0	H2O SOLENOID JG D6 UL CHECK VALVE	1	PZ	EL1437B0	JG D8 WATER SOLENOID VALVE -BARBED D6 V	1	PZ	GN1312A0	RUBBER CABLE-PASSI NG DE=26 DI=15 SP=10	1	PZ	GN1526A0	INT. D.=6.9 TH=1.8 O-RIN	1	PZ	RC1019A0	D=10 ELASTIC CLAMP	10	PZ	RC1242A0	D=10 CLOSED CAP	2	PZ	RC1356A0	STRAIGHT THREADED FEMALE END 8X1/4" BSP	1	PZ	TB2820A0	PIPE EPDM FOR WASHING SYSTEM	1.200	M	VH1220A1	4,2X12 TCB SELF-TAPPIN G SCREW	9	PZ	VL1019A0	VIBRATION PUMP	1	PZ	VL1054B0	ONE WASHING SYS INLET DISTRIBUTOR	1	PZ
Code	Description	Qty	UOM																																																																						
0H2143A0		1	PZ																																																																						
0H7553D0	XECC PLUS WASHING SYSTEM PLAT	1	PZ																																																																						
EL1422A1	1 WAY SOLENOID VALVE + D8-D10 REDUCTION	1	PZ																																																																						
EL1426A0	H2O UL SOLENOID JG D8-PIPE HOLDER	1	PZ																																																																						
EL1426B0	UL JG D8 WATER SLENOID VALVE-PIPE HOLDER	1	PZ																																																																						
EL1437A0	H2O SOLENOID JG D6 UL CHECK VALVE	1	PZ																																																																						
EL1437B0	JG D8 WATER SOLENOID VALVE -BARBED D6 V	1	PZ																																																																						
GN1312A0	RUBBER CABLE-PASSI NG DE=26 DI=15 SP=10	1	PZ																																																																						
GN1526A0	INT. D.=6.9 TH=1.8 O-RIN	1	PZ																																																																						
RC1019A0	D=10 ELASTIC CLAMP	10	PZ																																																																						
RC1242A0	D=10 CLOSED CAP	2	PZ																																																																						
RC1356A0	STRAIGHT THREADED FEMALE END 8X1/4" BSP	1	PZ																																																																						
TB2820A0	PIPE EPDM FOR WASHING SYSTEM	1.200	M																																																																						
VH1220A1	4,2X12 TCB SELF-TAPPIN G SCREW	9	PZ																																																																						
VL1019A0	VIBRATION PUMP	1	PZ																																																																						
VL1054B0	ONE WASHING SYS INLET DISTRIBUTOR	1	PZ																																																																						



COMPONENT			SPARE PART																																																							
Code	Description	Image	Code	Description	Components list																																																					
VL1019A	VIBRATION PUMP		KVL1120A	USA COMPACT PLUS CLEANING SYSTEM KIT	<table border="1"> <thead> <tr> <th>Code</th> <th>Description</th> <th>Qty</th> <th>UOM</th> </tr> </thead> <tbody> <tr> <td>VL1064A0</td> <td>WASHING SYSTEM OUTLETS DISTRIBUTOR</td> <td>1</td> <td>PZ</td> </tr> <tr> <td>VL1065A1</td> <td>1/4 MALE N.O. PRESSURE SWITCH</td> <td>1</td> <td>PZ</td> </tr> <tr> <td>VL1102A1</td> <td>DETERGENT LINE FILTER + BARBED VNR 6 MM</td> <td>1</td> <td>PZ</td> </tr> <tr> <td>VL1128A0</td> <td>D6 BARBED CHECK VALVE</td> <td>1</td> <td>PZ</td> </tr> <tr> <td>VL1128A1</td> <td>D6 BARBED CHECK VALVE</td> <td>1</td> <td>PZ</td> </tr> <tr> <td>VM2172A0</td> <td>PUMP-WITH-CI RCUIT LOCKING PIN</td> <td>1</td> <td>PZ</td> </tr> </tbody> </table>	Code	Description	Qty	UOM	VL1064A0	WASHING SYSTEM OUTLETS DISTRIBUTOR	1	PZ	VL1065A1	1/4 MALE N.O. PRESSURE SWITCH	1	PZ	VL1102A1	DETERGENT LINE FILTER + BARBED VNR 6 MM	1	PZ	VL1128A0	D6 BARBED CHECK VALVE	1	PZ	VL1128A1	D6 BARBED CHECK VALVE	1	PZ	VM2172A0	PUMP-WITH-CI RCUIT LOCKING PIN	1	PZ																									
			Code	Description	Qty	UOM																																																				
VL1064A0	WASHING SYSTEM OUTLETS DISTRIBUTOR	1	PZ																																																							
VL1065A1	1/4 MALE N.O. PRESSURE SWITCH	1	PZ																																																							
VL1102A1	DETERGENT LINE FILTER + BARBED VNR 6 MM	1	PZ																																																							
VL1128A0	D6 BARBED CHECK VALVE	1	PZ																																																							
VL1128A1	D6 BARBED CHECK VALVE	1	PZ																																																							
VM2172A0	PUMP-WITH-CI RCUIT LOCKING PIN	1	PZ																																																							
KVL1119A	EUR COMPACT PLUS CLEANING SYSTEM KIT	<table border="1"> <thead> <tr> <th>Code</th> <th>Description</th> <th>Qty</th> <th>UOM</th> </tr> </thead> <tbody> <tr> <td>0H2143A0</td> <td></td> <td>1</td> <td>PZ</td> </tr> <tr> <td>0H7553D0</td> <td>XECC PLUS WASHING SYSTEM PLAT</td> <td>1</td> <td>PZ</td> </tr> <tr> <td>EL1252A1</td> <td>1 WAY WATER VALVE + J.G. CONNECTION</td> <td>1</td> <td>PZ</td> </tr> <tr> <td>EL1424A0</td> <td>D8 CONNECTION WATER SOLENOID VALVE</td> <td>1</td> <td>PZ</td> </tr> <tr> <td>EL1424B0</td> <td></td> <td>1</td> <td>PZ</td> </tr> <tr> <td>EL1436A0</td> <td>H2O SOLENOID JG D8 CHECK VALVE</td> <td>1</td> <td>PZ</td> </tr> <tr> <td>EL1436B0</td> <td></td> <td>1</td> <td>PZ</td> </tr> <tr> <td>GN1312A0</td> <td>RUBBER CABLE-PASSI NG DE=26 DI=15 SP=10</td> <td>1</td> <td>PZ</td> </tr> <tr> <td>GN1526A0</td> <td>INT. D.=6.9 TH=1.8 O-RIN</td> <td>1</td> <td>PZ</td> </tr> <tr> <td>RC1019A0</td> <td>D=10 ELASTIC CLAMP</td> <td>11</td> <td>PZ</td> </tr> <tr> <td>RC1242A0</td> <td>D=10 CLOSED CAP</td> <td>2</td> <td>PZ</td> </tr> <tr> <td>RC1356A0</td> <td>STRAIGHT THREADED FEMALE END 8X1/4" BSP</td> <td>1</td> <td>PZ</td> </tr> <tr> <td>TB2820A0</td> <td>PIPE EPDM FOR WASHING SYSTEM</td> <td>1.200</td> <td>M</td> </tr> </tbody> </table>	Code	Description	Qty	UOM	0H2143A0		1	PZ	0H7553D0	XECC PLUS WASHING SYSTEM PLAT	1	PZ	EL1252A1	1 WAY WATER VALVE + J.G. CONNECTION	1	PZ	EL1424A0	D8 CONNECTION WATER SOLENOID VALVE	1	PZ	EL1424B0		1	PZ	EL1436A0	H2O SOLENOID JG D8 CHECK VALVE	1	PZ	EL1436B0		1	PZ	GN1312A0	RUBBER CABLE-PASSI NG DE=26 DI=15 SP=10	1	PZ	GN1526A0	INT. D.=6.9 TH=1.8 O-RIN	1	PZ	RC1019A0	D=10 ELASTIC CLAMP	11	PZ	RC1242A0	D=10 CLOSED CAP	2	PZ	RC1356A0	STRAIGHT THREADED FEMALE END 8X1/4" BSP	1	PZ	TB2820A0	PIPE EPDM FOR WASHING SYSTEM	1.200	M
Code	Description	Qty	UOM																																																							
0H2143A0		1	PZ																																																							
0H7553D0	XECC PLUS WASHING SYSTEM PLAT	1	PZ																																																							
EL1252A1	1 WAY WATER VALVE + J.G. CONNECTION	1	PZ																																																							
EL1424A0	D8 CONNECTION WATER SOLENOID VALVE	1	PZ																																																							
EL1424B0		1	PZ																																																							
EL1436A0	H2O SOLENOID JG D8 CHECK VALVE	1	PZ																																																							
EL1436B0		1	PZ																																																							
GN1312A0	RUBBER CABLE-PASSI NG DE=26 DI=15 SP=10	1	PZ																																																							
GN1526A0	INT. D.=6.9 TH=1.8 O-RIN	1	PZ																																																							
RC1019A0	D=10 ELASTIC CLAMP	11	PZ																																																							
RC1242A0	D=10 CLOSED CAP	2	PZ																																																							
RC1356A0	STRAIGHT THREADED FEMALE END 8X1/4" BSP	1	PZ																																																							
TB2820A0	PIPE EPDM FOR WASHING SYSTEM	1.200	M																																																							

COMPONENT			SPARE PART																																															
Code	Description	Image	Code	Description	Components list																																													
VL1019A	VIBRATION PUMP		KVL1119A	EUR COMPACT PLUS CLEANING SYSTEM KIT	<table border="1"> <thead> <tr> <th>Code</th> <th>Description</th> <th>Qty</th> <th>UOM</th> </tr> </thead> <tbody> <tr> <td>VI1220A1</td> <td>4,2X12 TCB SELF-TAPPIN G SCREW</td> <td>16</td> <td>PZ</td> </tr> <tr> <td>VL1019A0</td> <td>VIBRATION PUMP</td> <td>1</td> <td>PZ</td> </tr> <tr> <td>VL1054B0</td> <td>ONE WASHING SYS INLET DISTRIBUTOR</td> <td>1</td> <td>PZ</td> </tr> <tr> <td>VL1064A0</td> <td>WASHING SYSTEM OUTLETS DISTRIBUTOR</td> <td>1</td> <td>PZ</td> </tr> <tr> <td>VL1065A1</td> <td>1/4 MALE N.O. PRESSURE SWITCH</td> <td>1</td> <td>PZ</td> </tr> <tr> <td>VL1102A1</td> <td>DETERGENT LINE FILTER + BARBED VNR 6 MM</td> <td>1</td> <td>PZ</td> </tr> <tr> <td>VL1128A0</td> <td>D6 BARBED CHECK VALVE</td> <td>1</td> <td>PZ</td> </tr> <tr> <td>VL1128A1</td> <td>D6 BARBED CHECK VALVE</td> <td>1</td> <td>PZ</td> </tr> <tr> <td>VM2172A0</td> <td>PUMP-WITH-CI RCUIT LOCKING PIN</td> <td>1</td> <td>PZ</td> </tr> </tbody> </table>	Code	Description	Qty	UOM	VI1220A1	4,2X12 TCB SELF-TAPPIN G SCREW	16	PZ	VL1019A0	VIBRATION PUMP	1	PZ	VL1054B0	ONE WASHING SYS INLET DISTRIBUTOR	1	PZ	VL1064A0	WASHING SYSTEM OUTLETS DISTRIBUTOR	1	PZ	VL1065A1	1/4 MALE N.O. PRESSURE SWITCH	1	PZ	VL1102A1	DETERGENT LINE FILTER + BARBED VNR 6 MM	1	PZ	VL1128A0	D6 BARBED CHECK VALVE	1	PZ	VL1128A1	D6 BARBED CHECK VALVE	1	PZ	VM2172A0	PUMP-WITH-CI RCUIT LOCKING PIN	1	PZ					
			Code	Description	Qty	UOM																																												
VI1220A1	4,2X12 TCB SELF-TAPPIN G SCREW	16	PZ																																															
VL1019A0	VIBRATION PUMP	1	PZ																																															
VL1054B0	ONE WASHING SYS INLET DISTRIBUTOR	1	PZ																																															
VL1064A0	WASHING SYSTEM OUTLETS DISTRIBUTOR	1	PZ																																															
VL1065A1	1/4 MALE N.O. PRESSURE SWITCH	1	PZ																																															
VL1102A1	DETERGENT LINE FILTER + BARBED VNR 6 MM	1	PZ																																															
VL1128A0	D6 BARBED CHECK VALVE	1	PZ																																															
VL1128A1	D6 BARBED CHECK VALVE	1	PZ																																															
VM2172A0	PUMP-WITH-CI RCUIT LOCKING PIN	1	PZ																																															
KVL1118A	EUR COMPACT ONE CLEANING SYSTEM KIT	<table border="1"> <thead> <tr> <th>Code</th> <th>Description</th> <th>Qty</th> <th>UOM</th> </tr> </thead> <tbody> <tr> <td>0H2143A0</td> <td></td> <td>1</td> <td>PZ</td> </tr> <tr> <td>0H7173C0</td> <td>XECC ONE WASHING SYSTEM PLAT</td> <td>1</td> <td>PZ</td> </tr> <tr> <td>EL1436A0</td> <td>H2O SOLENOID JG D8 CHECK VALVE</td> <td>1</td> <td>PZ</td> </tr> <tr> <td>EL1436B0</td> <td></td> <td>1</td> <td>PZ</td> </tr> <tr> <td>GN1526A0</td> <td>INT. D.=6.9 TH=1.8 O-RIN</td> <td>1</td> <td>PZ</td> </tr> <tr> <td>RC1019A0</td> <td>D=10 ELASTIC CLAMP</td> <td>12</td> <td>PZ</td> </tr> <tr> <td>RC1242A0</td> <td>D=10 CLOSED CAP</td> <td>2</td> <td>PZ</td> </tr> <tr> <td>TB2820A0</td> <td>PIPE EPDM FOR WASHING SYSTEM</td> <td>1.200</td> <td>M</td> </tr> <tr> <td>VI1220A1</td> <td>4,2X12 TCB SELF-TAPPIN G SCREW</td> <td>6</td> <td>PZ</td> </tr> <tr> <td>VL1019A0</td> <td>VIBRATION PUMP</td> <td>1</td> <td>PZ</td> </tr> <tr> <td>VL1053B0</td> <td>ONE WASHING SYS EXT DISTRIBUTOR</td> <td>1</td> <td>PZ</td> </tr> </tbody> </table>	Code	Description	Qty	UOM	0H2143A0		1	PZ	0H7173C0	XECC ONE WASHING SYSTEM PLAT	1	PZ	EL1436A0	H2O SOLENOID JG D8 CHECK VALVE	1	PZ	EL1436B0		1	PZ	GN1526A0	INT. D.=6.9 TH=1.8 O-RIN	1	PZ	RC1019A0	D=10 ELASTIC CLAMP	12	PZ	RC1242A0	D=10 CLOSED CAP	2	PZ	TB2820A0	PIPE EPDM FOR WASHING SYSTEM	1.200	M	VI1220A1	4,2X12 TCB SELF-TAPPIN G SCREW	6	PZ	VL1019A0	VIBRATION PUMP	1	PZ	VL1053B0	ONE WASHING SYS EXT DISTRIBUTOR	1	PZ
Code	Description	Qty	UOM																																															
0H2143A0		1	PZ																																															
0H7173C0	XECC ONE WASHING SYSTEM PLAT	1	PZ																																															
EL1436A0	H2O SOLENOID JG D8 CHECK VALVE	1	PZ																																															
EL1436B0		1	PZ																																															
GN1526A0	INT. D.=6.9 TH=1.8 O-RIN	1	PZ																																															
RC1019A0	D=10 ELASTIC CLAMP	12	PZ																																															
RC1242A0	D=10 CLOSED CAP	2	PZ																																															
TB2820A0	PIPE EPDM FOR WASHING SYSTEM	1.200	M																																															
VI1220A1	4,2X12 TCB SELF-TAPPIN G SCREW	6	PZ																																															
VL1019A0	VIBRATION PUMP	1	PZ																																															
VL1053B0	ONE WASHING SYS EXT DISTRIBUTOR	1	PZ																																															

COMPONENT			SPARE PART																																																															
Code	Description	Image	Code	Description	Components list																																																													
VL1019A	VIBRATION PUMP		KVL1118A	EUR COMPACT ONE CLEANING SYSTEM KIT	<table border="1"> <thead> <tr> <th>Code</th> <th>Description</th> <th>Qty</th> <th>UOM</th> </tr> </thead> <tbody> <tr> <td>VL1054B0</td> <td>ONE WASHING SYS INLET DISTRIBUTOR</td> <td>1</td> <td>PZ</td> </tr> <tr> <td>VL1102A1</td> <td>DETERGENT LINE FILTER + BARBED VNR 6 MM</td> <td>1</td> <td>PZ</td> </tr> <tr> <td>VL1128A0</td> <td>D6 BARBED CHECK VALVE</td> <td>1</td> <td>PZ</td> </tr> <tr> <td>VL1128A1</td> <td>D6 BARBED CHECK VALVE</td> <td>1</td> <td>PZ</td> </tr> <tr> <td>VM2172A0</td> <td>PUMP-WITH-CI RCUIT LOCKING PIN</td> <td>1</td> <td>PZ</td> </tr> </tbody> </table>	Code	Description	Qty	UOM	VL1054B0	ONE WASHING SYS INLET DISTRIBUTOR	1	PZ	VL1102A1	DETERGENT LINE FILTER + BARBED VNR 6 MM	1	PZ	VL1128A0	D6 BARBED CHECK VALVE	1	PZ	VL1128A1	D6 BARBED CHECK VALVE	1	PZ	VM2172A0	PUMP-WITH-CI RCUIT LOCKING PIN	1	PZ																																					
			Code	Description	Qty	UOM																																																												
VL1054B0	ONE WASHING SYS INLET DISTRIBUTOR	1	PZ																																																															
VL1102A1	DETERGENT LINE FILTER + BARBED VNR 6 MM	1	PZ																																																															
VL1128A0	D6 BARBED CHECK VALVE	1	PZ																																																															
VL1128A1	D6 BARBED CHECK VALVE	1	PZ																																																															
VM2172A0	PUMP-WITH-CI RCUIT LOCKING PIN	1	PZ																																																															
KVL1109A	EUR 2 ROTOR ARMS ONE CLEANING SYSTEM KIT	<table border="1"> <thead> <tr> <th>Code</th> <th>Description</th> <th>Qty</th> <th>UOM</th> </tr> </thead> <tbody> <tr> <td>0H2143A0</td> <td></td> <td>2</td> <td>PZ</td> </tr> <tr> <td>0H7324A0</td> <td>ONE OVENS WASHING SYST HOLDING PLATE</td> <td>2</td> <td>PZ</td> </tr> <tr> <td>0H7515A0</td> <td>XEVC-2011-E1 R DOUBLE WASHING SYS PLATE</td> <td>1</td> <td>PZ</td> </tr> <tr> <td>CH1000A0</td> <td>SNIP PIPE CUTTER</td> <td>1</td> <td>PZ</td> </tr> <tr> <td>EL1115A0</td> <td>Ø8 Y CONNECTION</td> <td>1</td> <td>PZ</td> </tr> <tr> <td>EL1436A0</td> <td>H2O SOLENOID JG D8 CHECK VALVE</td> <td>2</td> <td>PZ</td> </tr> <tr> <td>EL1436B0</td> <td></td> <td>2</td> <td>PZ</td> </tr> <tr> <td>GN1526A0</td> <td>INT. D.=6.9 TH=1.8 O-RIN</td> <td>2</td> <td>PZ</td> </tr> <tr> <td>RC1006A0</td> <td>D8 PET PIPE GUIDE BEND</td> <td>4</td> <td>PZ</td> </tr> <tr> <td>RC1019A0</td> <td>D=10 ELASTIC CLAMP</td> <td>26</td> <td>PZ</td> </tr> <tr> <td>RC1242A0</td> <td>D=10 CLOSED CAP</td> <td>4</td> <td>PZ</td> </tr> <tr> <td>TB1818A0</td> <td>JG Ø8 BLUE PE PIPE</td> <td>1.640</td> <td>M</td> </tr> <tr> <td>TB2820A0</td> <td>PIPE EPDM FOR WASHING SYSTEM</td> <td>3.940</td> <td>M</td> </tr> <tr> <td>VI1220A1</td> <td>4,2X12 TCB SELF-TAPPIN G SCREW</td> <td>8</td> <td>PZ</td> </tr> <tr> <td>VL1019A0</td> <td>VIBRATION PUMP</td> <td>2</td> <td>PZ</td> </tr> </tbody> </table>	Code	Description	Qty	UOM	0H2143A0		2	PZ	0H7324A0	ONE OVENS WASHING SYST HOLDING PLATE	2	PZ	0H7515A0	XEVC-2011-E1 R DOUBLE WASHING SYS PLATE	1	PZ	CH1000A0	SNIP PIPE CUTTER	1	PZ	EL1115A0	Ø8 Y CONNECTION	1	PZ	EL1436A0	H2O SOLENOID JG D8 CHECK VALVE	2	PZ	EL1436B0		2	PZ	GN1526A0	INT. D.=6.9 TH=1.8 O-RIN	2	PZ	RC1006A0	D8 PET PIPE GUIDE BEND	4	PZ	RC1019A0	D=10 ELASTIC CLAMP	26	PZ	RC1242A0	D=10 CLOSED CAP	4	PZ	TB1818A0	JG Ø8 BLUE PE PIPE	1.640	M	TB2820A0	PIPE EPDM FOR WASHING SYSTEM	3.940	M	VI1220A1	4,2X12 TCB SELF-TAPPIN G SCREW	8	PZ	VL1019A0	VIBRATION PUMP	2	PZ
Code	Description	Qty	UOM																																																															
0H2143A0		2	PZ																																																															
0H7324A0	ONE OVENS WASHING SYST HOLDING PLATE	2	PZ																																																															
0H7515A0	XEVC-2011-E1 R DOUBLE WASHING SYS PLATE	1	PZ																																																															
CH1000A0	SNIP PIPE CUTTER	1	PZ																																																															
EL1115A0	Ø8 Y CONNECTION	1	PZ																																																															
EL1436A0	H2O SOLENOID JG D8 CHECK VALVE	2	PZ																																																															
EL1436B0		2	PZ																																																															
GN1526A0	INT. D.=6.9 TH=1.8 O-RIN	2	PZ																																																															
RC1006A0	D8 PET PIPE GUIDE BEND	4	PZ																																																															
RC1019A0	D=10 ELASTIC CLAMP	26	PZ																																																															
RC1242A0	D=10 CLOSED CAP	4	PZ																																																															
TB1818A0	JG Ø8 BLUE PE PIPE	1.640	M																																																															
TB2820A0	PIPE EPDM FOR WASHING SYSTEM	3.940	M																																																															
VI1220A1	4,2X12 TCB SELF-TAPPIN G SCREW	8	PZ																																																															
VL1019A0	VIBRATION PUMP	2	PZ																																																															

COMPONENT			SPARE PART																																																											
Code	Description	Image	Code	Description	Components list																																																									
VL1019A	VIBRATION PUMP		KVL1109A	EUR 2 ROTOR ARMS ONE CLEANING SYSTEM KIT	<table border="1"> <thead> <tr> <th>Code</th> <th>Description</th> <th>Qty</th> <th>UOM</th> </tr> </thead> <tbody> <tr> <td>VL1053B0</td> <td>ONE WASHING SYS EXT DISTRIBUTOR</td> <td>2</td> <td>PZ</td> </tr> <tr> <td>VL1054B0</td> <td>ONE WASHING SYS INLET DISTRIBUTOR</td> <td>2</td> <td>PZ</td> </tr> <tr> <td>VL1102A1</td> <td>DETERGENT LINE FILTER + BARBED VNR 6 MM</td> <td>2</td> <td>PZ</td> </tr> <tr> <td>VL1128A0</td> <td>D6 BARBED CHECK VALVE</td> <td>2</td> <td>PZ</td> </tr> <tr> <td>VM2172A0</td> <td>PUMP-WITH-CI RCUIT LOCKING PIN</td> <td>2</td> <td>PZ</td> </tr> </tbody> </table>	Code	Description	Qty	UOM	VL1053B0	ONE WASHING SYS EXT DISTRIBUTOR	2	PZ	VL1054B0	ONE WASHING SYS INLET DISTRIBUTOR	2	PZ	VL1102A1	DETERGENT LINE FILTER + BARBED VNR 6 MM	2	PZ	VL1128A0	D6 BARBED CHECK VALVE	2	PZ	VM2172A0	PUMP-WITH-CI RCUIT LOCKING PIN	2	PZ																																	
			Code	Description	Qty	UOM																																																								
VL1053B0	ONE WASHING SYS EXT DISTRIBUTOR	2	PZ																																																											
VL1054B0	ONE WASHING SYS INLET DISTRIBUTOR	2	PZ																																																											
VL1102A1	DETERGENT LINE FILTER + BARBED VNR 6 MM	2	PZ																																																											
VL1128A0	D6 BARBED CHECK VALVE	2	PZ																																																											
VM2172A0	PUMP-WITH-CI RCUIT LOCKING PIN	2	PZ																																																											
KVL1108A	04EU ONE EUR 1 ROTOR CLEANING SYSTEM KIT	<table border="1"> <thead> <tr> <th>Code</th> <th>Description</th> <th>Qty</th> <th>UOM</th> </tr> </thead> <tbody> <tr> <td>0H2143A0</td> <td></td> <td>1</td> <td>PZ</td> </tr> <tr> <td>0H7511A0</td> <td>ONE OVENS WASHING SYST HOLDING PLATE</td> <td>1</td> <td>PZ</td> </tr> <tr> <td>EL1436A0</td> <td>H2O SOLENOID JG D8 CHECK VALVE</td> <td>1</td> <td>PZ</td> </tr> <tr> <td>EL1436B0</td> <td></td> <td>1</td> <td>PZ</td> </tr> <tr> <td>GN1526A0</td> <td>INT. D.=6.9 TH=1.8 O-RIN</td> <td>1</td> <td>PZ</td> </tr> <tr> <td>RC1006A0</td> <td>D8 PET PIPE GUIDE BEND</td> <td>2</td> <td>PZ</td> </tr> <tr> <td>RC1019A0</td> <td>D=10 ELASTIC CLAMP</td> <td>17</td> <td>PZ</td> </tr> <tr> <td>RC1242A0</td> <td>D=10 CLOSED CAP</td> <td>2</td> <td>PZ</td> </tr> <tr> <td>TB1818A0</td> <td>JG Ø8 BLUE PE PIPE</td> <td>0.320</td> <td>M</td> </tr> <tr> <td>TB2820A0</td> <td>PIPE EPDM FOR WASHING SYSTEM</td> <td>1.380</td> <td>M</td> </tr> <tr> <td>VI1220A1</td> <td>4,2X12 TCB SELF-TAPPIN G SCREW</td> <td>1</td> <td>PZ</td> </tr> <tr> <td>VL1019A0</td> <td>VIBRATION PUMP</td> <td>2</td> <td>PZ</td> </tr> <tr> <td>VL1053B0</td> <td>ONE WASHING SYS EXT DISTRIBUTOR</td> <td>1</td> <td>PZ</td> </tr> <tr> <td>VL1054B0</td> <td>ONE WASHING SYS INLET DISTRIBUTOR</td> <td>1</td> <td>PZ</td> </tr> </tbody> </table>	Code	Description	Qty	UOM	0H2143A0		1	PZ	0H7511A0	ONE OVENS WASHING SYST HOLDING PLATE	1	PZ	EL1436A0	H2O SOLENOID JG D8 CHECK VALVE	1	PZ	EL1436B0		1	PZ	GN1526A0	INT. D.=6.9 TH=1.8 O-RIN	1	PZ	RC1006A0	D8 PET PIPE GUIDE BEND	2	PZ	RC1019A0	D=10 ELASTIC CLAMP	17	PZ	RC1242A0	D=10 CLOSED CAP	2	PZ	TB1818A0	JG Ø8 BLUE PE PIPE	0.320	M	TB2820A0	PIPE EPDM FOR WASHING SYSTEM	1.380	M	VI1220A1	4,2X12 TCB SELF-TAPPIN G SCREW	1	PZ	VL1019A0	VIBRATION PUMP	2	PZ	VL1053B0	ONE WASHING SYS EXT DISTRIBUTOR	1	PZ	VL1054B0	ONE WASHING SYS INLET DISTRIBUTOR	1	PZ
Code	Description	Qty	UOM																																																											
0H2143A0		1	PZ																																																											
0H7511A0	ONE OVENS WASHING SYST HOLDING PLATE	1	PZ																																																											
EL1436A0	H2O SOLENOID JG D8 CHECK VALVE	1	PZ																																																											
EL1436B0		1	PZ																																																											
GN1526A0	INT. D.=6.9 TH=1.8 O-RIN	1	PZ																																																											
RC1006A0	D8 PET PIPE GUIDE BEND	2	PZ																																																											
RC1019A0	D=10 ELASTIC CLAMP	17	PZ																																																											
RC1242A0	D=10 CLOSED CAP	2	PZ																																																											
TB1818A0	JG Ø8 BLUE PE PIPE	0.320	M																																																											
TB2820A0	PIPE EPDM FOR WASHING SYSTEM	1.380	M																																																											
VI1220A1	4,2X12 TCB SELF-TAPPIN G SCREW	1	PZ																																																											
VL1019A0	VIBRATION PUMP	2	PZ																																																											
VL1053B0	ONE WASHING SYS EXT DISTRIBUTOR	1	PZ																																																											
VL1054B0	ONE WASHING SYS INLET DISTRIBUTOR	1	PZ																																																											

COMPONENT			SPARE PART																																																															
Code	Description	Image	Code	Description	Components list																																																													
VL1019A	VIBRATION PUMP		KVL1108A	04EU ONE EUR 1 ROTOR CLEANING SYSTEM KIT	<table border="1"> <thead> <tr> <th>Code</th> <th>Description</th> <th>Qty</th> <th>UOM</th> </tr> </thead> <tbody> <tr> <td>VL1128A0</td> <td>D6 BARBED CHECK VALVE</td> <td>1</td> <td>PZ</td> </tr> <tr> <td>VM2172A0</td> <td>PUMP-WITH-CI RCUIT LOCKING PIN</td> <td>1</td> <td>PZ</td> </tr> </tbody> </table>	Code	Description	Qty	UOM	VL1128A0	D6 BARBED CHECK VALVE	1	PZ	VM2172A0	PUMP-WITH-CI RCUIT LOCKING PIN	1	PZ																																																	
			Code	Description	Qty	UOM																																																												
VL1128A0	D6 BARBED CHECK VALVE	1	PZ																																																															
VM2172A0	PUMP-WITH-CI RCUIT LOCKING PIN	1	PZ																																																															
KVL1105A	USA 2ROTOR ARMS PLUS CLEANING SYSTEM KIT	<table border="1"> <thead> <tr> <th>Code</th> <th>Description</th> <th>Qty</th> <th>UOM</th> </tr> </thead> <tbody> <tr> <td>0H2143A0</td> <td></td> <td>1</td> <td>PZ</td> </tr> <tr> <td>0H7820A0</td> <td>PLUS WASHING SY SUPPORT WITH STEAM VALVE</td> <td>1</td> <td>PZ</td> </tr> <tr> <td>EL1422A1</td> <td>1 WAY SOLENOID VALVE + D8-D10 REDUCTION</td> <td>1</td> <td>PZ</td> </tr> <tr> <td>EL1426A0</td> <td>H2O UL SOLENOID JG D8-PIPE HOLDER</td> <td>2</td> <td>PZ</td> </tr> <tr> <td>EL1426B0</td> <td>UL JG D8 WATER SLENOID VALVE-PIPE HOLDER</td> <td>2</td> <td>PZ</td> </tr> <tr> <td>EL1437A0</td> <td>H2O SOLENOID JG D6 UL CHECK VALVE</td> <td>1</td> <td>PZ</td> </tr> <tr> <td>EL1437B0</td> <td>JG D8 WATER SOLENOID VALVE -BARBED D6 V</td> <td>1</td> <td>PZ</td> </tr> <tr> <td>GN1526A0</td> <td>INT. D.=6.9 TH=1.8 O-RIN</td> <td>1</td> <td>PZ</td> </tr> <tr> <td>RC1019A0</td> <td>D=10 ELASTIC CLAMP</td> <td>12</td> <td>PZ</td> </tr> <tr> <td>RC1130A0</td> <td>130X2,6 CLAM</td> <td>1</td> <td>PZ</td> </tr> <tr> <td>RC1242A0</td> <td>D=10 CLOSED CAP</td> <td>2</td> <td>PZ</td> </tr> <tr> <td>RC1356A0</td> <td>STRAIGHT THREADED FEMALE END 8X1/4" BSP</td> <td>1</td> <td>PZ</td> </tr> <tr> <td>TB2820A0</td> <td>PIPE EPDM FOR WASHING SYSTEM</td> <td>1.410</td> <td>M</td> </tr> <tr> <td>V11220A1</td> <td>4,2X12 TCB SELF-TAPPIN G SCREW</td> <td>3</td> <td>PZ</td> </tr> <tr> <td>VL1019A0</td> <td>VIBRATION PUMP</td> <td>1</td> <td>PZ</td> </tr> </tbody> </table>	Code	Description	Qty	UOM	0H2143A0		1	PZ	0H7820A0	PLUS WASHING SY SUPPORT WITH STEAM VALVE	1	PZ	EL1422A1	1 WAY SOLENOID VALVE + D8-D10 REDUCTION	1	PZ	EL1426A0	H2O UL SOLENOID JG D8-PIPE HOLDER	2	PZ	EL1426B0	UL JG D8 WATER SLENOID VALVE-PIPE HOLDER	2	PZ	EL1437A0	H2O SOLENOID JG D6 UL CHECK VALVE	1	PZ	EL1437B0	JG D8 WATER SOLENOID VALVE -BARBED D6 V	1	PZ	GN1526A0	INT. D.=6.9 TH=1.8 O-RIN	1	PZ	RC1019A0	D=10 ELASTIC CLAMP	12	PZ	RC1130A0	130X2,6 CLAM	1	PZ	RC1242A0	D=10 CLOSED CAP	2	PZ	RC1356A0	STRAIGHT THREADED FEMALE END 8X1/4" BSP	1	PZ	TB2820A0	PIPE EPDM FOR WASHING SYSTEM	1.410	M	V11220A1	4,2X12 TCB SELF-TAPPIN G SCREW	3	PZ	VL1019A0	VIBRATION PUMP	1	PZ
Code	Description	Qty	UOM																																																															
0H2143A0		1	PZ																																																															
0H7820A0	PLUS WASHING SY SUPPORT WITH STEAM VALVE	1	PZ																																																															
EL1422A1	1 WAY SOLENOID VALVE + D8-D10 REDUCTION	1	PZ																																																															
EL1426A0	H2O UL SOLENOID JG D8-PIPE HOLDER	2	PZ																																																															
EL1426B0	UL JG D8 WATER SLENOID VALVE-PIPE HOLDER	2	PZ																																																															
EL1437A0	H2O SOLENOID JG D6 UL CHECK VALVE	1	PZ																																																															
EL1437B0	JG D8 WATER SOLENOID VALVE -BARBED D6 V	1	PZ																																																															
GN1526A0	INT. D.=6.9 TH=1.8 O-RIN	1	PZ																																																															
RC1019A0	D=10 ELASTIC CLAMP	12	PZ																																																															
RC1130A0	130X2,6 CLAM	1	PZ																																																															
RC1242A0	D=10 CLOSED CAP	2	PZ																																																															
RC1356A0	STRAIGHT THREADED FEMALE END 8X1/4" BSP	1	PZ																																																															
TB2820A0	PIPE EPDM FOR WASHING SYSTEM	1.410	M																																																															
V11220A1	4,2X12 TCB SELF-TAPPIN G SCREW	3	PZ																																																															
VL1019A0	VIBRATION PUMP	1	PZ																																																															





COMPONENT			SPARE PART																																			
Code	Description	Image	Code	Description	Components list																																	
VL1019A	VIBRATION PUMP		KVL1105A	USA 2 ROTOR ARMS PLUS CLEANING SYSTEM KIT	<table border="1"> <thead> <tr> <th>Code</th> <th>Description</th> <th>Qty</th> <th>UOM</th> </tr> </thead> <tbody> <tr> <td>VL1065A1</td> <td>1/4 MALE N.O. PRESSURE SWITCH</td> <td>1</td> <td>PZ</td> </tr> <tr> <td>VL1067A0</td> <td>WASHING SYSTEM INLETS DISTRIBUTOR</td> <td>1</td> <td>PZ</td> </tr> <tr> <td>VL1092A0</td> <td>WASHING SYSTEM OUTLET DOUBLE DISTRIBUTOR</td> <td>1</td> <td>PZ</td> </tr> <tr> <td>VL1102A1</td> <td>DETERGENT LINE FILTER + BARBED VNR 6 MM</td> <td>1</td> <td>PZ</td> </tr> <tr> <td>VL1128A0</td> <td>D6 BARBED CHECK VALVE</td> <td>1</td> <td>PZ</td> </tr> <tr> <td>VL1128A1</td> <td>D6 BARBED CHECK VALVE</td> <td>1</td> <td>PZ</td> </tr> <tr> <td>VM2172A0</td> <td>PUMP-WITH-CI RCUIT LOCKING PIN</td> <td>1</td> <td>PZ</td> </tr> </tbody> </table>	Code	Description	Qty	UOM	VL1065A1	1/4 MALE N.O. PRESSURE SWITCH	1	PZ	VL1067A0	WASHING SYSTEM INLETS DISTRIBUTOR	1	PZ	VL1092A0	WASHING SYSTEM OUTLET DOUBLE DISTRIBUTOR	1	PZ	VL1102A1	DETERGENT LINE FILTER + BARBED VNR 6 MM	1	PZ	VL1128A0	D6 BARBED CHECK VALVE	1	PZ	VL1128A1	D6 BARBED CHECK VALVE	1	PZ	VM2172A0	PUMP-WITH-CI RCUIT LOCKING PIN	1	PZ	
			Code	Description	Qty	UOM																																
VL1065A1	1/4 MALE N.O. PRESSURE SWITCH	1	PZ																																			
VL1067A0	WASHING SYSTEM INLETS DISTRIBUTOR	1	PZ																																			
VL1092A0	WASHING SYSTEM OUTLET DOUBLE DISTRIBUTOR	1	PZ																																			
VL1102A1	DETERGENT LINE FILTER + BARBED VNR 6 MM	1	PZ																																			
VL1128A0	D6 BARBED CHECK VALVE	1	PZ																																			
VL1128A1	D6 BARBED CHECK VALVE	1	PZ																																			
VM2172A0	PUMP-WITH-CI RCUIT LOCKING PIN	1	PZ																																			
KVL1104A	USA 1 ROTOR ARM PLUS CLEANING SYSTEM KIT	<table border="1"> <thead> <tr> <th>Code</th> <th>Description</th> <th>Qty</th> <th>UOM</th> </tr> </thead> <tbody> <tr> <td>0H2143A0</td> <td></td> <td>1</td> <td>PZ</td> </tr> <tr> <td>0H7820A0</td> <td>PLUS WASHING SY SUPPORT WITH STEAM VALVE</td> <td>1</td> <td>PZ</td> </tr> <tr> <td>EL1422A1</td> <td>1 WAY SOLENOID VALVE + D8-D10 REDUCTION</td> <td>1</td> <td>PZ</td> </tr> <tr> <td>EL1426A0</td> <td>H2O UL SOLENOID JG D8-PIPE HOLDER</td> <td>1</td> <td>PZ</td> </tr> <tr> <td>EL1426B0</td> <td>UL JG D8 WATER SLENOID VALVE-PIPE HOLDER</td> <td>1</td> <td>PZ</td> </tr> <tr> <td>EL1437A0</td> <td>H2O SOLENOID JG D6 UL CHECK VALVE</td> <td>1</td> <td>PZ</td> </tr> <tr> <td>EL1437B0</td> <td>JG D8 WATER SOLENOID VALVE -BARBED D6 V</td> <td>1</td> <td>PZ</td> </tr> <tr> <td>GN1526A0</td> <td>INT. D.=6.9 TH=1.8 O-RIN</td> <td>1</td> <td>PZ</td> </tr> </tbody> </table>	Code	Description	Qty	UOM	0H2143A0		1	PZ	0H7820A0	PLUS WASHING SY SUPPORT WITH STEAM VALVE	1	PZ	EL1422A1	1 WAY SOLENOID VALVE + D8-D10 REDUCTION	1	PZ	EL1426A0	H2O UL SOLENOID JG D8-PIPE HOLDER	1	PZ	EL1426B0	UL JG D8 WATER SLENOID VALVE-PIPE HOLDER	1	PZ	EL1437A0	H2O SOLENOID JG D6 UL CHECK VALVE	1	PZ	EL1437B0	JG D8 WATER SOLENOID VALVE -BARBED D6 V	1	PZ	GN1526A0	INT. D.=6.9 TH=1.8 O-RIN	1	PZ
Code	Description	Qty	UOM																																			
0H2143A0		1	PZ																																			
0H7820A0	PLUS WASHING SY SUPPORT WITH STEAM VALVE	1	PZ																																			
EL1422A1	1 WAY SOLENOID VALVE + D8-D10 REDUCTION	1	PZ																																			
EL1426A0	H2O UL SOLENOID JG D8-PIPE HOLDER	1	PZ																																			
EL1426B0	UL JG D8 WATER SLENOID VALVE-PIPE HOLDER	1	PZ																																			
EL1437A0	H2O SOLENOID JG D6 UL CHECK VALVE	1	PZ																																			
EL1437B0	JG D8 WATER SOLENOID VALVE -BARBED D6 V	1	PZ																																			
GN1526A0	INT. D.=6.9 TH=1.8 O-RIN	1	PZ																																			





COMPONENT			SPARE PART																																																																																					
Code	Description	Image	Code	Description	Components list																																																																																			
VL1019A	VIBRATION PUMP		KVL1104A	USA 1 ROTOR ARM PLUS CLEANING SYSTEM KIT	<table border="1"> <thead> <tr> <th>Code</th> <th>Description</th> <th>Qty</th> <th>UOM</th> </tr> </thead> <tbody> <tr> <td>RC1019A0</td> <td>D=10 ELASTIC CLAMP</td> <td>12</td> <td>PZ</td> </tr> <tr> <td>RC1130A0</td> <td>130X2,6 CLAM</td> <td>1</td> <td>PZ</td> </tr> <tr> <td>RC1242A0</td> <td>D=10 CLOSED CAP</td> <td>2</td> <td>PZ</td> </tr> <tr> <td>RC1356A0</td> <td>STRAIGHT THREADED FEMALE END 8X1/4" BSP</td> <td>1</td> <td>PZ</td> </tr> <tr> <td>TB2820A0</td> <td>PIPE EPDM FOR WASHING SYSTEM</td> <td>1.410</td> <td>M</td> </tr> <tr> <td>VI1220A1</td> <td>4,2X12 TCB SELF-TAPPIN G SCREW</td> <td>3</td> <td>PZ</td> </tr> <tr> <td>VL1019A0</td> <td>VIBRATION PUMP</td> <td>1</td> <td>PZ</td> </tr> <tr> <td>VL1064A0</td> <td>WASHING SYSTEM OUTLETS DISTRIBUTOR</td> <td>1</td> <td>PZ</td> </tr> <tr> <td>VL1065A1</td> <td>1/4 MALE N.O. PRESSURE SWITCH</td> <td>1</td> <td>PZ</td> </tr> <tr> <td>VL1067A0</td> <td>WASHING SYSTEM INLETS DISTRIBUTOR</td> <td>1</td> <td>PZ</td> </tr> <tr> <td>VL1102A1</td> <td>DETERGENT LINE FILTER + BARBED VNR 6 MM</td> <td>1</td> <td>PZ</td> </tr> <tr> <td>VL1128A0</td> <td>D6 BARBED CHECK VALVE</td> <td>1</td> <td>PZ</td> </tr> <tr> <td>VL1128A1</td> <td>D6 BARBED CHECK VALVE</td> <td>1</td> <td>PZ</td> </tr> <tr> <td>VM2172A0</td> <td>PUMP-WITH-CI RCUIT LOCKING PIN</td> <td>1</td> <td>PZ</td> </tr> </tbody> </table>	Code	Description	Qty	UOM	RC1019A0	D=10 ELASTIC CLAMP	12	PZ	RC1130A0	130X2,6 CLAM	1	PZ	RC1242A0	D=10 CLOSED CAP	2	PZ	RC1356A0	STRAIGHT THREADED FEMALE END 8X1/4" BSP	1	PZ	TB2820A0	PIPE EPDM FOR WASHING SYSTEM	1.410	M	VI1220A1	4,2X12 TCB SELF-TAPPIN G SCREW	3	PZ	VL1019A0	VIBRATION PUMP	1	PZ	VL1064A0	WASHING SYSTEM OUTLETS DISTRIBUTOR	1	PZ	VL1065A1	1/4 MALE N.O. PRESSURE SWITCH	1	PZ	VL1067A0	WASHING SYSTEM INLETS DISTRIBUTOR	1	PZ	VL1102A1	DETERGENT LINE FILTER + BARBED VNR 6 MM	1	PZ	VL1128A0	D6 BARBED CHECK VALVE	1	PZ	VL1128A1	D6 BARBED CHECK VALVE	1	PZ	VM2172A0	PUMP-WITH-CI RCUIT LOCKING PIN	1	PZ	KVL1103A	EUR 2 ROTOR ARMS PLUS CLEANING SYSTEM KIT	<table border="1"> <thead> <tr> <th>Code</th> <th>Description</th> <th>Qty</th> <th>UOM</th> </tr> </thead> <tbody> <tr> <td>0H2143A0</td> <td></td> <td>1</td> <td>PZ</td> </tr> <tr> <td>0H7820A0</td> <td>PLUS WASHING SY SUPPORT WITH STEAM VALVE</td> <td>1</td> <td>PZ</td> </tr> <tr> <td>EL1252A1</td> <td>1 WAY WATER VALVE + J.G. CONNECTION</td> <td>1</td> <td>PZ</td> </tr> <tr> <td>EL1424A0</td> <td>D8 CONNECTION WATER SOLENOID VALVE</td> <td>2</td> <td>PZ</td> </tr> </tbody> </table>	Code	Description	Qty	UOM	0H2143A0		1	PZ	0H7820A0	PLUS WASHING SY SUPPORT WITH STEAM VALVE	1	PZ	EL1252A1	1 WAY WATER VALVE + J.G. CONNECTION	1	PZ	EL1424A0	D8 CONNECTION WATER SOLENOID VALVE	2	PZ
			Code	Description	Qty	UOM																																																																																		
RC1019A0	D=10 ELASTIC CLAMP	12	PZ																																																																																					
RC1130A0	130X2,6 CLAM	1	PZ																																																																																					
RC1242A0	D=10 CLOSED CAP	2	PZ																																																																																					
RC1356A0	STRAIGHT THREADED FEMALE END 8X1/4" BSP	1	PZ																																																																																					
TB2820A0	PIPE EPDM FOR WASHING SYSTEM	1.410	M																																																																																					
VI1220A1	4,2X12 TCB SELF-TAPPIN G SCREW	3	PZ																																																																																					
VL1019A0	VIBRATION PUMP	1	PZ																																																																																					
VL1064A0	WASHING SYSTEM OUTLETS DISTRIBUTOR	1	PZ																																																																																					
VL1065A1	1/4 MALE N.O. PRESSURE SWITCH	1	PZ																																																																																					
VL1067A0	WASHING SYSTEM INLETS DISTRIBUTOR	1	PZ																																																																																					
VL1102A1	DETERGENT LINE FILTER + BARBED VNR 6 MM	1	PZ																																																																																					
VL1128A0	D6 BARBED CHECK VALVE	1	PZ																																																																																					
VL1128A1	D6 BARBED CHECK VALVE	1	PZ																																																																																					
VM2172A0	PUMP-WITH-CI RCUIT LOCKING PIN	1	PZ																																																																																					
Code	Description	Qty	UOM																																																																																					
0H2143A0		1	PZ																																																																																					
0H7820A0	PLUS WASHING SY SUPPORT WITH STEAM VALVE	1	PZ																																																																																					
EL1252A1	1 WAY WATER VALVE + J.G. CONNECTION	1	PZ																																																																																					
EL1424A0	D8 CONNECTION WATER SOLENOID VALVE	2	PZ																																																																																					

COMPONENT			SPARE PART																																																																																									
Code	Description	Image	Code	Description	Components list																																																																																							
VL1019A	VIBRATION PUMP		KVL1103A	EUR 2ROTOR ARMS PLUS CLEANING SYSTEM KIT	<table border="1"> <thead> <tr> <th>Code</th> <th>Description</th> <th>Qty</th> <th>UOM</th> </tr> </thead> <tbody> <tr> <td>EL1424B0</td> <td></td> <td>2</td> <td>PZ</td> </tr> <tr> <td>EL1436A0</td> <td>H2O SOLENOID JG D8 CHECK VALVE</td> <td>1</td> <td>PZ</td> </tr> <tr> <td>EL1436B0</td> <td></td> <td>1</td> <td>PZ</td> </tr> <tr> <td>GN1526A0</td> <td>INT. D.=6.9 TH=1.8 O-RIN</td> <td>1</td> <td>PZ</td> </tr> <tr> <td>RC1019A0</td> <td>D=10 ELASTIC CLAMP</td> <td>12</td> <td>PZ</td> </tr> <tr> <td>RC1130A0</td> <td>130X2,6 CLAM</td> <td>1</td> <td>PZ</td> </tr> <tr> <td>RC1242A0</td> <td>D=10 CLOSED CAP</td> <td>2</td> <td>PZ</td> </tr> <tr> <td>RC1356A0</td> <td>STRAIGHT THREADED FEMALE END 8X1/4" BSP</td> <td>1</td> <td>PZ</td> </tr> <tr> <td>TB2820A0</td> <td>PIPE EPDM FOR WASHING SYSTEM</td> <td>1.410</td> <td>M</td> </tr> <tr> <td>VI1220A1</td> <td>4,2X12 TCB SELF-TAPPIN G SCREW</td> <td>3</td> <td>PZ</td> </tr> <tr> <td>VL1019A0</td> <td>VIBRATION PUMP</td> <td>1</td> <td>PZ</td> </tr> <tr> <td>VL1065A1</td> <td>1/4 MALE N.O. PRESSURE SWITCH</td> <td>1</td> <td>PZ</td> </tr> <tr> <td>VL1067A0</td> <td>WASHING SYSTEM INLETS DISTRIBUTOR</td> <td>1</td> <td>PZ</td> </tr> <tr> <td>VL1092A0</td> <td>WASHING SYSTEM OUTLET DOUBLE DISTRIBUTOR</td> <td>1</td> <td>PZ</td> </tr> <tr> <td>VL1102A1</td> <td>DETERGENT LINE FILTER + BARBED VNR 6 MM</td> <td>1</td> <td>PZ</td> </tr> <tr> <td>VL1128A0</td> <td>D6 BARBED CHECK VALVE</td> <td>1</td> <td>PZ</td> </tr> <tr> <td>VL1128A1</td> <td>D6 BARBED CHECK VALVE</td> <td>1</td> <td>PZ</td> </tr> <tr> <td>VM2172A0</td> <td>PUMP-WITH-CI RCUIT LOCKING PIN</td> <td>1</td> <td>PZ</td> </tr> </tbody> </table>	Code	Description	Qty	UOM	EL1424B0		2	PZ	EL1436A0	H2O SOLENOID JG D8 CHECK VALVE	1	PZ	EL1436B0		1	PZ	GN1526A0	INT. D.=6.9 TH=1.8 O-RIN	1	PZ	RC1019A0	D=10 ELASTIC CLAMP	12	PZ	RC1130A0	130X2,6 CLAM	1	PZ	RC1242A0	D=10 CLOSED CAP	2	PZ	RC1356A0	STRAIGHT THREADED FEMALE END 8X1/4" BSP	1	PZ	TB2820A0	PIPE EPDM FOR WASHING SYSTEM	1.410	M	VI1220A1	4,2X12 TCB SELF-TAPPIN G SCREW	3	PZ	VL1019A0	VIBRATION PUMP	1	PZ	VL1065A1	1/4 MALE N.O. PRESSURE SWITCH	1	PZ	VL1067A0	WASHING SYSTEM INLETS DISTRIBUTOR	1	PZ	VL1092A0	WASHING SYSTEM OUTLET DOUBLE DISTRIBUTOR	1	PZ	VL1102A1	DETERGENT LINE FILTER + BARBED VNR 6 MM	1	PZ	VL1128A0	D6 BARBED CHECK VALVE	1	PZ	VL1128A1	D6 BARBED CHECK VALVE	1	PZ	VM2172A0	PUMP-WITH-CI RCUIT LOCKING PIN	1	PZ	KVL1094A	0311 EUR CLEANING SYSTEM KIT	<table border="1"> <thead> <tr> <th>Code</th> <th>Description</th> <th>Qty</th> <th>UOM</th> </tr> </thead> <tbody> <tr> <td>0H2143A0</td> <td></td> <td>1</td> <td>PZ</td> </tr> </tbody> </table>	Code	Description	Qty	UOM	0H2143A0		1	PZ
			Code	Description	Qty	UOM																																																																																						
EL1424B0		2	PZ																																																																																									
EL1436A0	H2O SOLENOID JG D8 CHECK VALVE	1	PZ																																																																																									
EL1436B0		1	PZ																																																																																									
GN1526A0	INT. D.=6.9 TH=1.8 O-RIN	1	PZ																																																																																									
RC1019A0	D=10 ELASTIC CLAMP	12	PZ																																																																																									
RC1130A0	130X2,6 CLAM	1	PZ																																																																																									
RC1242A0	D=10 CLOSED CAP	2	PZ																																																																																									
RC1356A0	STRAIGHT THREADED FEMALE END 8X1/4" BSP	1	PZ																																																																																									
TB2820A0	PIPE EPDM FOR WASHING SYSTEM	1.410	M																																																																																									
VI1220A1	4,2X12 TCB SELF-TAPPIN G SCREW	3	PZ																																																																																									
VL1019A0	VIBRATION PUMP	1	PZ																																																																																									
VL1065A1	1/4 MALE N.O. PRESSURE SWITCH	1	PZ																																																																																									
VL1067A0	WASHING SYSTEM INLETS DISTRIBUTOR	1	PZ																																																																																									
VL1092A0	WASHING SYSTEM OUTLET DOUBLE DISTRIBUTOR	1	PZ																																																																																									
VL1102A1	DETERGENT LINE FILTER + BARBED VNR 6 MM	1	PZ																																																																																									
VL1128A0	D6 BARBED CHECK VALVE	1	PZ																																																																																									
VL1128A1	D6 BARBED CHECK VALVE	1	PZ																																																																																									
VM2172A0	PUMP-WITH-CI RCUIT LOCKING PIN	1	PZ																																																																																									
Code	Description	Qty	UOM																																																																																									
0H2143A0		1	PZ																																																																																									





COMPONENT			SPARE PART																																																																																													
Code	Description	Image	Code	Description	Components list																																																																																											
VL1019A	VIBRATION PUMP		KVL1094A	0311 EUR CLEANING SYSTEM KIT	<table border="1"> <thead> <tr> <th>Code</th> <th>Description</th> <th>Qty</th> <th>UOM</th> </tr> </thead> <tbody> <tr> <td>0H7494B0</td> <td>ONE-03 WASHING SYST HOLDING PLATE</td> <td>1</td> <td>PZ</td> </tr> <tr> <td>EL1436A0</td> <td>H2O SOLENOID JG D8 CHECK VALVE</td> <td>1</td> <td>PZ</td> </tr> <tr> <td>EL1436B0</td> <td></td> <td>1</td> <td>PZ</td> </tr> <tr> <td>GN1526A0</td> <td>INT. D.=6.9 TH=1.8 O-RIN</td> <td>1</td> <td>PZ</td> </tr> <tr> <td>RC1242A0</td> <td>D=10 CLOSED CAP</td> <td>2</td> <td>PZ</td> </tr> <tr> <td>TB2820A0</td> <td>PIPE EPDM FOR WASHING SYSTEM</td> <td>1.420</td> <td>M</td> </tr> <tr> <td>VI1220A1</td> <td>4,2X12 TCB SELF-TAPPIN G SCREW</td> <td>1</td> <td>PZ</td> </tr> <tr> <td>VL1019A0</td> <td>VIBRATION PUMP</td> <td>1</td> <td>PZ</td> </tr> <tr> <td>VL1053B0</td> <td>ONE WASHING SYS EXT DISTRIBUTOR</td> <td>1</td> <td>PZ</td> </tr> <tr> <td>VL1054B0</td> <td>ONE WASHING SYS INLET DISTRIBUTOR</td> <td>1</td> <td>PZ</td> </tr> <tr> <td>VL1102A1</td> <td>DETERGENT LINE FILTER + BARBED VNR 6 MM</td> <td>1</td> <td>PZ</td> </tr> <tr> <td>VL1128A0</td> <td>D6 BARBED CHECK VALVE</td> <td>1</td> <td>PZ</td> </tr> <tr> <td>VL1128A1</td> <td>D6 BARBED CHECK VALVE</td> <td>1</td> <td>PZ</td> </tr> <tr> <td>VM2172A0</td> <td>PUMP-WITH-CI RCUIT LOCKING PIN</td> <td>1</td> <td>PZ</td> </tr> </tbody> </table>	Code	Description	Qty	UOM	0H7494B0	ONE-03 WASHING SYST HOLDING PLATE	1	PZ	EL1436A0	H2O SOLENOID JG D8 CHECK VALVE	1	PZ	EL1436B0		1	PZ	GN1526A0	INT. D.=6.9 TH=1.8 O-RIN	1	PZ	RC1242A0	D=10 CLOSED CAP	2	PZ	TB2820A0	PIPE EPDM FOR WASHING SYSTEM	1.420	M	VI1220A1	4,2X12 TCB SELF-TAPPIN G SCREW	1	PZ	VL1019A0	VIBRATION PUMP	1	PZ	VL1053B0	ONE WASHING SYS EXT DISTRIBUTOR	1	PZ	VL1054B0	ONE WASHING SYS INLET DISTRIBUTOR	1	PZ	VL1102A1	DETERGENT LINE FILTER + BARBED VNR 6 MM	1	PZ	VL1128A0	D6 BARBED CHECK VALVE	1	PZ	VL1128A1	D6 BARBED CHECK VALVE	1	PZ	VM2172A0	PUMP-WITH-CI RCUIT LOCKING PIN	1	PZ	KVL1092A	EUR 2 ROTOR ARMS PLUS CHEMICAL PUMP KIT	<table border="1"> <thead> <tr> <th>Code</th> <th>Description</th> <th>Qty</th> <th>UOM</th> </tr> </thead> <tbody> <tr> <td>0H2143A0</td> <td></td> <td>1</td> <td>PZ</td> </tr> <tr> <td>GN1526A0</td> <td>INT. D.=6.9 TH=1.8 O-RIN</td> <td>1</td> <td>PZ</td> </tr> <tr> <td>RC1019A0</td> <td>D=10 ELASTIC CLAMP</td> <td>6</td> <td>PZ</td> </tr> <tr> <td>RC1130A0</td> <td>130X2,6 CLAM</td> <td>1</td> <td>PZ</td> </tr> <tr> <td>RC1242A0</td> <td>D=10 CLOSED CAP</td> <td>2</td> <td>PZ</td> </tr> <tr> <td>TB2820A0</td> <td>PIPE EPDM FOR WASHING SYSTEM</td> <td>0.120</td> <td>M</td> </tr> </tbody> </table>	Code	Description	Qty	UOM	0H2143A0		1	PZ	GN1526A0	INT. D.=6.9 TH=1.8 O-RIN	1	PZ	RC1019A0	D=10 ELASTIC CLAMP	6	PZ	RC1130A0	130X2,6 CLAM	1	PZ	RC1242A0	D=10 CLOSED CAP	2	PZ	TB2820A0	PIPE EPDM FOR WASHING SYSTEM	0.120	M
			Code	Description	Qty	UOM																																																																																										
0H7494B0	ONE-03 WASHING SYST HOLDING PLATE	1	PZ																																																																																													
EL1436A0	H2O SOLENOID JG D8 CHECK VALVE	1	PZ																																																																																													
EL1436B0		1	PZ																																																																																													
GN1526A0	INT. D.=6.9 TH=1.8 O-RIN	1	PZ																																																																																													
RC1242A0	D=10 CLOSED CAP	2	PZ																																																																																													
TB2820A0	PIPE EPDM FOR WASHING SYSTEM	1.420	M																																																																																													
VI1220A1	4,2X12 TCB SELF-TAPPIN G SCREW	1	PZ																																																																																													
VL1019A0	VIBRATION PUMP	1	PZ																																																																																													
VL1053B0	ONE WASHING SYS EXT DISTRIBUTOR	1	PZ																																																																																													
VL1054B0	ONE WASHING SYS INLET DISTRIBUTOR	1	PZ																																																																																													
VL1102A1	DETERGENT LINE FILTER + BARBED VNR 6 MM	1	PZ																																																																																													
VL1128A0	D6 BARBED CHECK VALVE	1	PZ																																																																																													
VL1128A1	D6 BARBED CHECK VALVE	1	PZ																																																																																													
VM2172A0	PUMP-WITH-CI RCUIT LOCKING PIN	1	PZ																																																																																													
Code	Description	Qty	UOM																																																																																													
0H2143A0		1	PZ																																																																																													
GN1526A0	INT. D.=6.9 TH=1.8 O-RIN	1	PZ																																																																																													
RC1019A0	D=10 ELASTIC CLAMP	6	PZ																																																																																													
RC1130A0	130X2,6 CLAM	1	PZ																																																																																													
RC1242A0	D=10 CLOSED CAP	2	PZ																																																																																													
TB2820A0	PIPE EPDM FOR WASHING SYSTEM	0.120	M																																																																																													

COMPONENT			SPARE PART																																																			
Code	Description	Image	Code	Description	Components list																																																	
VL1019A	VIBRATION PUMP		KVL1092A	EUR 2 ROTOR ARMS PLUS CHEMICAL PUMP KIT	<table border="1"> <thead> <tr> <th>Code</th> <th>Description</th> <th>Qty</th> <th>UOM</th> </tr> </thead> <tbody> <tr> <td>VL1019A0</td> <td>VIBRATION PUMP</td> <td>1</td> <td>PZ</td> </tr> <tr> <td>VL1067A0</td> <td>WASHING SYSTEM INLETS DISTRIBUTOR</td> <td>1</td> <td>PZ</td> </tr> <tr> <td>VL1092A0</td> <td>WASHING SYSTEM OUTLET DOUBLE DISTRIBUTOR</td> <td>1</td> <td>PZ</td> </tr> <tr> <td>VL1128A0</td> <td>D6 BARBED CHECK VALVE</td> <td>1</td> <td>PZ</td> </tr> <tr> <td>VL1128A1</td> <td>D6 BARBED CHECK VALVE</td> <td>1</td> <td>PZ</td> </tr> <tr> <td>VM2172A0</td> <td>PUMP-WITH-CI RCUIT LOCKING PIN</td> <td>1</td> <td>PZ</td> </tr> </tbody> </table>	Code	Description	Qty	UOM	VL1019A0	VIBRATION PUMP	1	PZ	VL1067A0	WASHING SYSTEM INLETS DISTRIBUTOR	1	PZ	VL1092A0	WASHING SYSTEM OUTLET DOUBLE DISTRIBUTOR	1	PZ	VL1128A0	D6 BARBED CHECK VALVE	1	PZ	VL1128A1	D6 BARBED CHECK VALVE	1	PZ	VM2172A0	PUMP-WITH-CI RCUIT LOCKING PIN	1	PZ																					
			Code	Description	Qty	UOM																																																
			VL1019A0	VIBRATION PUMP	1	PZ																																																
VL1067A0	WASHING SYSTEM INLETS DISTRIBUTOR	1	PZ																																																			
VL1092A0	WASHING SYSTEM OUTLET DOUBLE DISTRIBUTOR	1	PZ																																																			
VL1128A0	D6 BARBED CHECK VALVE	1	PZ																																																			
VL1128A1	D6 BARBED CHECK VALVE	1	PZ																																																			
VM2172A0	PUMP-WITH-CI RCUIT LOCKING PIN	1	PZ																																																			
KVL1073A	EUR 1 ROTOR ARM PLUS CHEMICAL PUMP KIT	<table border="1"> <thead> <tr> <th>Code</th> <th>Description</th> <th>Qty</th> <th>UOM</th> </tr> </thead> <tbody> <tr> <td>0H2143A0</td> <td></td> <td>1</td> <td>PZ</td> </tr> <tr> <td>GN1526A0</td> <td>INT. D.=6.9 TH=1.8 O-RING</td> <td>1</td> <td>PZ</td> </tr> <tr> <td>RC1019A0</td> <td>D=10 ELASTIC CLAMP</td> <td>6</td> <td>PZ</td> </tr> <tr> <td>RC1130A0</td> <td>130X2,6 CLAM</td> <td>1</td> <td>PZ</td> </tr> <tr> <td>RC1242A0</td> <td>D=10 CLOSED CAP</td> <td>2</td> <td>PZ</td> </tr> <tr> <td>TB2820A0</td> <td>PIPE EPDM FOR WASHING SYSTEM</td> <td>0.120</td> <td>M</td> </tr> <tr> <td>VL1019A0</td> <td>VIBRATION PUMP</td> <td>1</td> <td>PZ</td> </tr> <tr> <td>VL1064A0</td> <td>WASHING SYSTEM OUTLETS DISTRIBUTOR</td> <td>1</td> <td>PZ</td> </tr> <tr> <td>VL1067A0</td> <td>WASHING SYSTEM INLETS DISTRIBUTOR</td> <td>1</td> <td>PZ</td> </tr> <tr> <td>VL1128A0</td> <td>D6 BARBED CHECK VALVE</td> <td>1</td> <td>PZ</td> </tr> <tr> <td>VL1128A1</td> <td>D6 BARBED CHECK VALVE</td> <td>1</td> <td>PZ</td> </tr> <tr> <td>VM2172A0</td> <td>PUMP-WITH-CI RCUIT LOCKING PIN</td> <td>1</td> <td>PZ</td> </tr> </tbody> </table>	Code	Description	Qty	UOM	0H2143A0		1	PZ	GN1526A0	INT. D.=6.9 TH=1.8 O-RING	1	PZ	RC1019A0	D=10 ELASTIC CLAMP	6	PZ	RC1130A0	130X2,6 CLAM	1	PZ	RC1242A0	D=10 CLOSED CAP	2	PZ	TB2820A0	PIPE EPDM FOR WASHING SYSTEM	0.120	M	VL1019A0	VIBRATION PUMP	1	PZ	VL1064A0	WASHING SYSTEM OUTLETS DISTRIBUTOR	1	PZ	VL1067A0	WASHING SYSTEM INLETS DISTRIBUTOR	1	PZ	VL1128A0	D6 BARBED CHECK VALVE	1	PZ	VL1128A1	D6 BARBED CHECK VALVE	1	PZ	VM2172A0	PUMP-WITH-CI RCUIT LOCKING PIN	1	PZ
Code	Description	Qty	UOM																																																			
0H2143A0		1	PZ																																																			
GN1526A0	INT. D.=6.9 TH=1.8 O-RING	1	PZ																																																			
RC1019A0	D=10 ELASTIC CLAMP	6	PZ																																																			
RC1130A0	130X2,6 CLAM	1	PZ																																																			
RC1242A0	D=10 CLOSED CAP	2	PZ																																																			
TB2820A0	PIPE EPDM FOR WASHING SYSTEM	0.120	M																																																			
VL1019A0	VIBRATION PUMP	1	PZ																																																			
VL1064A0	WASHING SYSTEM OUTLETS DISTRIBUTOR	1	PZ																																																			
VL1067A0	WASHING SYSTEM INLETS DISTRIBUTOR	1	PZ																																																			
VL1128A0	D6 BARBED CHECK VALVE	1	PZ																																																			
VL1128A1	D6 BARBED CHECK VALVE	1	PZ																																																			
VM2172A0	PUMP-WITH-CI RCUIT LOCKING PIN	1	PZ																																																			
KVL1072A	ONE SERIES AND HOODS CHEMICAL PUMP KIT	<table border="1"> <thead> <tr> <th>Code</th> <th>Description</th> <th>Qty</th> <th>UOM</th> </tr> </thead> <tbody> <tr> <td>0H2143A0</td> <td></td> <td>1</td> <td>PZ</td> </tr> <tr> <td>GN1526A0</td> <td>INT. D.=6.9 TH=1.8 O-RING</td> <td>1</td> <td>PZ</td> </tr> <tr> <td>RC1019A0</td> <td>D=10 ELASTIC CLAMP</td> <td>6</td> <td>PZ</td> </tr> </tbody> </table>	Code	Description	Qty	UOM	0H2143A0		1	PZ	GN1526A0	INT. D.=6.9 TH=1.8 O-RING	1	PZ	RC1019A0	D=10 ELASTIC CLAMP	6	PZ																																				
Code	Description	Qty	UOM																																																			
0H2143A0		1	PZ																																																			
GN1526A0	INT. D.=6.9 TH=1.8 O-RING	1	PZ																																																			
RC1019A0	D=10 ELASTIC CLAMP	6	PZ																																																			



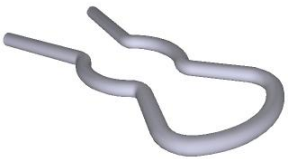

COMPONENT			SPARE PART																																																			
Code	Description	Image	Code	Description	Components list																																																	
VL1019A	VIBRATION PUMP		KVL1072A	ONE SERIES AND HOODS CHEMICAL PUMP KIT	<table border="1"> <thead> <tr> <th>Code</th> <th>Description</th> <th>Qty</th> <th>UOM</th> </tr> </thead> <tbody> <tr> <td>RC1242A0</td> <td>D=10 CLOSED CAP</td> <td>2</td> <td>PZ</td> </tr> <tr> <td>TB2820A0</td> <td>PIPE EPDM FOR WASHING SYSTEM</td> <td>0.120</td> <td>M</td> </tr> <tr> <td>VI1220A1</td> <td>4,2X12 TCB SELF-TAPPIN G SCREW</td> <td>1</td> <td>PZ</td> </tr> <tr> <td>VL1019A0</td> <td>VIBRATION PUMP</td> <td>1</td> <td>PZ</td> </tr> <tr> <td>VL1053B0</td> <td>ONE WASHING SYS EXT DISTRIBUTOR</td> <td>1</td> <td>PZ</td> </tr> <tr> <td>VL1054B0</td> <td>ONE WASHING SYS INLET DISTRIBUTOR</td> <td>1</td> <td>PZ</td> </tr> <tr> <td>VL1128A0</td> <td>D6 BARBED CHECK VALVE</td> <td>1</td> <td>PZ</td> </tr> <tr> <td>VL1128A1</td> <td>D6 BARBED CHECK VALVE</td> <td>1</td> <td>PZ</td> </tr> <tr> <td>VM2172A0</td> <td>PUMP-WITH-CI RCUIT LOCKING PIN</td> <td>1</td> <td>PZ</td> </tr> </tbody> </table>	Code	Description	Qty	UOM	RC1242A0	D=10 CLOSED CAP	2	PZ	TB2820A0	PIPE EPDM FOR WASHING SYSTEM	0.120	M	VI1220A1	4,2X12 TCB SELF-TAPPIN G SCREW	1	PZ	VL1019A0	VIBRATION PUMP	1	PZ	VL1053B0	ONE WASHING SYS EXT DISTRIBUTOR	1	PZ	VL1054B0	ONE WASHING SYS INLET DISTRIBUTOR	1	PZ	VL1128A0	D6 BARBED CHECK VALVE	1	PZ	VL1128A1	D6 BARBED CHECK VALVE	1	PZ	VM2172A0	PUMP-WITH-CI RCUIT LOCKING PIN	1	PZ									
			Code	Description	Qty	UOM																																																
RC1242A0	D=10 CLOSED CAP	2	PZ																																																			
TB2820A0	PIPE EPDM FOR WASHING SYSTEM	0.120	M																																																			
VI1220A1	4,2X12 TCB SELF-TAPPIN G SCREW	1	PZ																																																			
VL1019A0	VIBRATION PUMP	1	PZ																																																			
VL1053B0	ONE WASHING SYS EXT DISTRIBUTOR	1	PZ																																																			
VL1054B0	ONE WASHING SYS INLET DISTRIBUTOR	1	PZ																																																			
VL1128A0	D6 BARBED CHECK VALVE	1	PZ																																																			
VL1128A1	D6 BARBED CHECK VALVE	1	PZ																																																			
VM2172A0	PUMP-WITH-CI RCUIT LOCKING PIN	1	PZ																																																			
KVL0684A		<table border="1"> <thead> <tr> <th>Code</th> <th>Description</th> <th>Qty</th> <th>UOM</th> </tr> </thead> <tbody> <tr> <td>GN1526A0</td> <td>INT. D.=6.9 TH=1.8 O-RIN</td> <td>4</td> <td>PZ</td> </tr> <tr> <td>RC1019A0</td> <td>D=10 ELASTIC CLAMP</td> <td>4</td> <td>PZ</td> </tr> <tr> <td>RC1130A0</td> <td>130X2,6 CLAM</td> <td>1</td> <td>PZ</td> </tr> <tr> <td>RC1131A0</td> <td></td> <td>3</td> <td>PZ</td> </tr> <tr> <td>RC1242A0</td> <td>D=10 CLOSED CAP</td> <td>2</td> <td>PZ</td> </tr> <tr> <td>TB2820A0</td> <td>PIPE EPDM FOR WASHING SYSTEM</td> <td>0.120</td> <td>M</td> </tr> <tr> <td>VL1019A0</td> <td>VIBRATION PUMP</td> <td>1</td> <td>PZ</td> </tr> <tr> <td>VL1128A1</td> <td>D6 BARBED CHECK VALVE</td> <td>1</td> <td>PZ</td> </tr> <tr> <td>VL1174C0</td> <td>D1.2 MM CALIBRATED NOZZLE</td> <td>1</td> <td>PZ</td> </tr> <tr> <td>VL1186A0</td> <td>3 WAYS PLUS WASHING DISTRIBUTOR</td> <td>1</td> <td>PZ</td> </tr> <tr> <td>VL1190A0</td> <td>PLUS WASHING SYSTEM INLET DISTRIBUTOR</td> <td>1</td> <td>PZ</td> </tr> <tr> <td>VM2172A0</td> <td>PUMP-WITH-CI RCUIT LOCKING PIN</td> <td>1</td> <td>PZ</td> </tr> </tbody> </table>	Code	Description	Qty	UOM	GN1526A0	INT. D.=6.9 TH=1.8 O-RIN	4	PZ	RC1019A0	D=10 ELASTIC CLAMP	4	PZ	RC1130A0	130X2,6 CLAM	1	PZ	RC1131A0		3	PZ	RC1242A0	D=10 CLOSED CAP	2	PZ	TB2820A0	PIPE EPDM FOR WASHING SYSTEM	0.120	M	VL1019A0	VIBRATION PUMP	1	PZ	VL1128A1	D6 BARBED CHECK VALVE	1	PZ	VL1174C0	D1.2 MM CALIBRATED NOZZLE	1	PZ	VL1186A0	3 WAYS PLUS WASHING DISTRIBUTOR	1	PZ	VL1190A0	PLUS WASHING SYSTEM INLET DISTRIBUTOR	1	PZ	VM2172A0	PUMP-WITH-CI RCUIT LOCKING PIN	1	PZ
Code	Description	Qty	UOM																																																			
GN1526A0	INT. D.=6.9 TH=1.8 O-RIN	4	PZ																																																			
RC1019A0	D=10 ELASTIC CLAMP	4	PZ																																																			
RC1130A0	130X2,6 CLAM	1	PZ																																																			
RC1131A0		3	PZ																																																			
RC1242A0	D=10 CLOSED CAP	2	PZ																																																			
TB2820A0	PIPE EPDM FOR WASHING SYSTEM	0.120	M																																																			
VL1019A0	VIBRATION PUMP	1	PZ																																																			
VL1128A1	D6 BARBED CHECK VALVE	1	PZ																																																			
VL1174C0	D1.2 MM CALIBRATED NOZZLE	1	PZ																																																			
VL1186A0	3 WAYS PLUS WASHING DISTRIBUTOR	1	PZ																																																			
VL1190A0	PLUS WASHING SYSTEM INLET DISTRIBUTOR	1	PZ																																																			
VM2172A0	PUMP-WITH-CI RCUIT LOCKING PIN	1	PZ																																																			



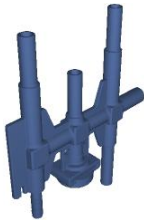

COMPONENT			SPARE PART																																																																																																					
Code	Description	Image	Code	Description	Components list																																																																																																			
VL1019A	VIBRATION PUMP		KVL0683A	1 ROTOR ARM PLUS WASH PUMP+NOZZLE KIT	<table border="1"> <thead> <tr> <th>Code</th> <th>Description</th> <th>Qty</th> <th>UOM</th> </tr> </thead> <tbody> <tr> <td>GN1526A0</td> <td>INT. D.=6.9 TH=1.8 O-RIN</td> <td>3</td> <td>PZ</td> </tr> <tr> <td>RC1019A0</td> <td>D=10 ELASTIC CLAMP</td> <td>4</td> <td>PZ</td> </tr> <tr> <td>RC1130A0</td> <td>130X2,6 CLAM</td> <td>1</td> <td>PZ</td> </tr> <tr> <td>RC1131A0</td> <td></td> <td>2</td> <td>PZ</td> </tr> <tr> <td>RC1242A0</td> <td>D=10 CLOSED CAP</td> <td>2</td> <td>PZ</td> </tr> <tr> <td>TB2820A0</td> <td>PIPE EPDM FOR WASHING SYSTEM</td> <td>0.120</td> <td>M</td> </tr> <tr> <td>VL1019A0</td> <td>VIBRATION PUMP</td> <td>1</td> <td>PZ</td> </tr> <tr> <td>VL1128A1</td> <td>D6 BARBED CHECK VALVE</td> <td>1</td> <td>PZ</td> </tr> <tr> <td>VL1174C0</td> <td>D1.2 MM CALIBRATED NOZZLE</td> <td>1</td> <td>PZ</td> </tr> <tr> <td>VL1185A0</td> <td>2 WAYS PLUS WASHING DISTRIBUTOR</td> <td>1</td> <td>PZ</td> </tr> <tr> <td>VL1190A0</td> <td>PLUS WASHING SYSTEM INLET DISTRIBUTOR</td> <td>1</td> <td>PZ</td> </tr> <tr> <td>VM2172A0</td> <td>PUMP-WITH-CI RCUIT LOCKING PIN</td> <td>1</td> <td>PZ</td> </tr> </tbody> </table>	Code	Description	Qty	UOM	GN1526A0	INT. D.=6.9 TH=1.8 O-RIN	3	PZ	RC1019A0	D=10 ELASTIC CLAMP	4	PZ	RC1130A0	130X2,6 CLAM	1	PZ	RC1131A0		2	PZ	RC1242A0	D=10 CLOSED CAP	2	PZ	TB2820A0	PIPE EPDM FOR WASHING SYSTEM	0.120	M	VL1019A0	VIBRATION PUMP	1	PZ	VL1128A1	D6 BARBED CHECK VALVE	1	PZ	VL1174C0	D1.2 MM CALIBRATED NOZZLE	1	PZ	VL1185A0	2 WAYS PLUS WASHING DISTRIBUTOR	1	PZ	VL1190A0	PLUS WASHING SYSTEM INLET DISTRIBUTOR	1	PZ	VM2172A0	PUMP-WITH-CI RCUIT LOCKING PIN	1	PZ	KVL0682A	ONE+HOODS WASHING SYSTEM PUMP+NOZZLE KIT	<table border="1"> <thead> <tr> <th>Code</th> <th>Description</th> <th>Qty</th> <th>UOM</th> </tr> </thead> <tbody> <tr> <td>GN1526A0</td> <td>INT. D.=6.9 TH=1.8 O-RIN</td> <td>1</td> <td>PZ</td> </tr> <tr> <td>RC1019A0</td> <td>D=10 ELASTIC CLAMP</td> <td>3</td> <td>PZ</td> </tr> <tr> <td>RC1242A0</td> <td>D=10 CLOSED CAP</td> <td>2</td> <td>PZ</td> </tr> <tr> <td>TB2820A0</td> <td>PIPE EPDM FOR WASHING SYSTEM</td> <td>0.120</td> <td>M</td> </tr> <tr> <td>VL1019A0</td> <td>VIBRATION PUMP</td> <td>1</td> <td>PZ</td> </tr> <tr> <td>VL1054B0</td> <td>ONE WASHING SYS INLET DISTRIBUTOR</td> <td>1</td> <td>PZ</td> </tr> <tr> <td>VL1128A1</td> <td>D6 BARBED CHECK VALVE</td> <td>2</td> <td>PZ</td> </tr> <tr> <td>VL1174C0</td> <td>D1.2 MM CALIBRATED NOZZLE</td> <td>1</td> <td>PZ</td> </tr> <tr> <td>VL1191A0</td> <td>ONE WASHING DISTRIBUTOR OUTLETS KIT</td> <td>1</td> <td>PZ</td> </tr> <tr> <td>VM2172A0</td> <td>PUMP-WITH-CI RCUIT LOCKING PIN</td> <td>1</td> <td>PZ</td> </tr> </tbody> </table>	Code	Description	Qty	UOM	GN1526A0	INT. D.=6.9 TH=1.8 O-RIN	1	PZ	RC1019A0	D=10 ELASTIC CLAMP	3	PZ	RC1242A0	D=10 CLOSED CAP	2	PZ	TB2820A0	PIPE EPDM FOR WASHING SYSTEM	0.120	M	VL1019A0	VIBRATION PUMP	1	PZ	VL1054B0	ONE WASHING SYS INLET DISTRIBUTOR	1	PZ	VL1128A1	D6 BARBED CHECK VALVE	2	PZ	VL1174C0	D1.2 MM CALIBRATED NOZZLE	1	PZ	VL1191A0	ONE WASHING DISTRIBUTOR OUTLETS KIT	1	PZ	VM2172A0	PUMP-WITH-CI RCUIT LOCKING PIN	1	PZ
			Code	Description	Qty	UOM																																																																																																		
GN1526A0	INT. D.=6.9 TH=1.8 O-RIN	3	PZ																																																																																																					
RC1019A0	D=10 ELASTIC CLAMP	4	PZ																																																																																																					
RC1130A0	130X2,6 CLAM	1	PZ																																																																																																					
RC1131A0		2	PZ																																																																																																					
RC1242A0	D=10 CLOSED CAP	2	PZ																																																																																																					
TB2820A0	PIPE EPDM FOR WASHING SYSTEM	0.120	M																																																																																																					
VL1019A0	VIBRATION PUMP	1	PZ																																																																																																					
VL1128A1	D6 BARBED CHECK VALVE	1	PZ																																																																																																					
VL1174C0	D1.2 MM CALIBRATED NOZZLE	1	PZ																																																																																																					
VL1185A0	2 WAYS PLUS WASHING DISTRIBUTOR	1	PZ																																																																																																					
VL1190A0	PLUS WASHING SYSTEM INLET DISTRIBUTOR	1	PZ																																																																																																					
VM2172A0	PUMP-WITH-CI RCUIT LOCKING PIN	1	PZ																																																																																																					
Code	Description	Qty	UOM																																																																																																					
GN1526A0	INT. D.=6.9 TH=1.8 O-RIN	1	PZ																																																																																																					
RC1019A0	D=10 ELASTIC CLAMP	3	PZ																																																																																																					
RC1242A0	D=10 CLOSED CAP	2	PZ																																																																																																					
TB2820A0	PIPE EPDM FOR WASHING SYSTEM	0.120	M																																																																																																					
VL1019A0	VIBRATION PUMP	1	PZ																																																																																																					
VL1054B0	ONE WASHING SYS INLET DISTRIBUTOR	1	PZ																																																																																																					
VL1128A1	D6 BARBED CHECK VALVE	2	PZ																																																																																																					
VL1174C0	D1.2 MM CALIBRATED NOZZLE	1	PZ																																																																																																					
VL1191A0	ONE WASHING DISTRIBUTOR OUTLETS KIT	1	PZ																																																																																																					
VM2172A0	PUMP-WITH-CI RCUIT LOCKING PIN	1	PZ																																																																																																					

COMPONENT			SPARE PART																																																																																		
Code	Description	Image	Code	Description	Components list																																																																																
VL1019A	VIBRATION PUMP		KVL0001A	LM TOP CLEANING SYSTEM KIT	<table border="1"> <thead> <tr> <th>Code</th> <th>Description</th> <th>Qty</th> <th>UOM</th> </tr> </thead> <tbody> <tr> <td>0H1226B0</td> <td>LINEMISSTOP WASHING SYTEM CIRCUIT COVE</td> <td>1</td> <td>PZ</td> </tr> <tr> <td>0H2143A0</td> <td></td> <td>2</td> <td>PZ</td> </tr> <tr> <td>GN1312A0</td> <td>RUBBER CABLE-PASSI NG DE=26 DI=15 SP=10</td> <td>1</td> <td>PZ</td> </tr> <tr> <td>GN1526A0</td> <td>INT. D.=6.9 TH=1.8 O-RIN</td> <td>1</td> <td>PZ</td> </tr> <tr> <td>RC1019A0</td> <td>D=10 ELASTIC CLAMP</td> <td>5</td> <td>PZ</td> </tr> <tr> <td>RC1242A0</td> <td>D=10 CLOSED CAP</td> <td>2</td> <td>PZ</td> </tr> <tr> <td>RC1381A0</td> <td>BIFILAR PIPE CLIP D10.7</td> <td>3</td> <td>PZ</td> </tr> <tr> <td>TB2343A0</td> <td>9X6 PVC TRANSPAREN T PIPE</td> <td>1.650</td> <td>M</td> </tr> <tr> <td>TB2820A0</td> <td>PIPE EPDM FOR WASHING SYSTEM</td> <td>0.990</td> <td>M</td> </tr> <tr> <td>VI1220A1</td> <td>4,2X12 TCB SELF-TAPPIN G SCREW</td> <td>1</td> <td>PZ</td> </tr> <tr> <td>VL1019A0</td> <td>VIBRATION PUMP</td> <td>1</td> <td>PZ</td> </tr> <tr> <td>VL1041C0</td> <td>DETERGENT CAP WITH Ø12 HOLE</td> <td>1</td> <td>PZ</td> </tr> <tr> <td>VL1047A1</td> <td>D6 PIPE HOLDER - D8 J.G. TERMINAL</td> <td>1</td> <td>PZ</td> </tr> <tr> <td>VL1053B0</td> <td>ONE WASHING SYS EXT DISTRIBUTOR</td> <td>1</td> <td>PZ</td> </tr> <tr> <td>VL1054B0</td> <td>ONE WASHING SYS INLET DISTRIBUTOR</td> <td>1</td> <td>PZ</td> </tr> <tr> <td>VL1061A0</td> <td>HOLD DOWN WEIGHT+NET FILTER+NON-RET. V.</td> <td>1</td> <td>PZ</td> </tr> <tr> <td>VL1128A0</td> <td>D6 BARBED CHECK VALVE</td> <td>2</td> <td>PZ</td> </tr> <tr> <td>VL1128A1</td> <td>D6 BARBED CHECK VALVE</td> <td>2</td> <td>PZ</td> </tr> <tr> <td>VM1066A0</td> <td>SADDLE CLIP FOR CABLES PASSING</td> <td>3</td> <td>PZ</td> </tr> </tbody> </table>	Code	Description	Qty	UOM	0H1226B0	LINEMISSTOP WASHING SYTEM CIRCUIT COVE	1	PZ	0H2143A0		2	PZ	GN1312A0	RUBBER CABLE-PASSI NG DE=26 DI=15 SP=10	1	PZ	GN1526A0	INT. D.=6.9 TH=1.8 O-RIN	1	PZ	RC1019A0	D=10 ELASTIC CLAMP	5	PZ	RC1242A0	D=10 CLOSED CAP	2	PZ	RC1381A0	BIFILAR PIPE CLIP D10.7	3	PZ	TB2343A0	9X6 PVC TRANSPAREN T PIPE	1.650	M	TB2820A0	PIPE EPDM FOR WASHING SYSTEM	0.990	M	VI1220A1	4,2X12 TCB SELF-TAPPIN G SCREW	1	PZ	VL1019A0	VIBRATION PUMP	1	PZ	VL1041C0	DETERGENT CAP WITH Ø12 HOLE	1	PZ	VL1047A1	D6 PIPE HOLDER - D8 J.G. TERMINAL	1	PZ	VL1053B0	ONE WASHING SYS EXT DISTRIBUTOR	1	PZ	VL1054B0	ONE WASHING SYS INLET DISTRIBUTOR	1	PZ	VL1061A0	HOLD DOWN WEIGHT+NET FILTER+NON-RET. V.	1	PZ	VL1128A0	D6 BARBED CHECK VALVE	2	PZ	VL1128A1	D6 BARBED CHECK VALVE	2	PZ	VM1066A0	SADDLE CLIP FOR CABLES PASSING	3	PZ
Code	Description	Qty	UOM																																																																																		
0H1226B0	LINEMISSTOP WASHING SYTEM CIRCUIT COVE	1	PZ																																																																																		
0H2143A0		2	PZ																																																																																		
GN1312A0	RUBBER CABLE-PASSI NG DE=26 DI=15 SP=10	1	PZ																																																																																		
GN1526A0	INT. D.=6.9 TH=1.8 O-RIN	1	PZ																																																																																		
RC1019A0	D=10 ELASTIC CLAMP	5	PZ																																																																																		
RC1242A0	D=10 CLOSED CAP	2	PZ																																																																																		
RC1381A0	BIFILAR PIPE CLIP D10.7	3	PZ																																																																																		
TB2343A0	9X6 PVC TRANSPAREN T PIPE	1.650	M																																																																																		
TB2820A0	PIPE EPDM FOR WASHING SYSTEM	0.990	M																																																																																		
VI1220A1	4,2X12 TCB SELF-TAPPIN G SCREW	1	PZ																																																																																		
VL1019A0	VIBRATION PUMP	1	PZ																																																																																		
VL1041C0	DETERGENT CAP WITH Ø12 HOLE	1	PZ																																																																																		
VL1047A1	D6 PIPE HOLDER - D8 J.G. TERMINAL	1	PZ																																																																																		
VL1053B0	ONE WASHING SYS EXT DISTRIBUTOR	1	PZ																																																																																		
VL1054B0	ONE WASHING SYS INLET DISTRIBUTOR	1	PZ																																																																																		
VL1061A0	HOLD DOWN WEIGHT+NET FILTER+NON-RET. V.	1	PZ																																																																																		
VL1128A0	D6 BARBED CHECK VALVE	2	PZ																																																																																		
VL1128A1	D6 BARBED CHECK VALVE	2	PZ																																																																																		
VM1066A0	SADDLE CLIP FOR CABLES PASSING	3	PZ																																																																																		



COMPONENT			SPARE PART																																		
Code	Description	Image	Code	Description	Components list																																
VL1019A	VIBRATION PUMP		KVL0001A	LM TOP CLEANING SYSTEM KIT	<table border="1"> <thead> <tr> <th>Code</th> <th>Description</th> <th>Qty</th> <th>UOM</th> </tr> </thead> <tbody> <tr> <td>VM1088A0</td> <td>NYLON CLICK CLAMP D7.9-D9.2</td> <td>1</td> <td>PZ</td> </tr> <tr> <td>VM1605A0</td> <td>CLIP TWIST LOCK DIAM. 10,2-12,7 MM</td> <td>1</td> <td>PZ</td> </tr> <tr> <td>VM2172A0</td> <td>PUMP-WITH-CIRCUIT RCUIT LOCKING PIN</td> <td>1</td> <td>PZ</td> </tr> </tbody> </table>	Code	Description	Qty	UOM	VM1088A0	NYLON CLICK CLAMP D7.9-D9.2	1	PZ	VM1605A0	CLIP TWIST LOCK DIAM. 10,2-12,7 MM	1	PZ	VM2172A0	PUMP-WITH-CIRCUIT RCUIT LOCKING PIN	1	PZ																
Code	Description	Qty	UOM																																		
VM1088A0	NYLON CLICK CLAMP D7.9-D9.2	1	PZ																																		
VM1605A0	CLIP TWIST LOCK DIAM. 10,2-12,7 MM	1	PZ																																		
VM2172A0	PUMP-WITH-CIRCUIT RCUIT LOCKING PIN	1	PZ																																		
VM2172A	PUMP-WITH-CIRCUIT LOCKING PIN		VM2172A0	PUMP-WITH-CIRCUIT LOCKING PIN																																	
RC1019A	D=10 ELASTIC CLAMP		KRC1019A	Ø10 ZINC PLATED ELASTIC CLAMP 15 PCS KIT	<table border="1"> <thead> <tr> <th>Code</th> <th>Description</th> <th>Qty</th> <th>UOM</th> </tr> </thead> <tbody> <tr> <td>RC1019A0</td> <td>D=10 ELASTIC CLAMP</td> <td>17</td> <td>PZ</td> </tr> <tr> <td>VM1224A0</td> <td></td> <td>0.200</td> <td>M</td> </tr> </tbody> </table>	Code	Description	Qty	UOM	RC1019A0	D=10 ELASTIC CLAMP	17	PZ	VM1224A0		0.200	M																				
Code	Description	Qty	UOM																																		
RC1019A0	D=10 ELASTIC CLAMP	17	PZ																																		
VM1224A0		0.200	M																																		
VL1065A	1/4 MALE N.O. PRESSURE SWITCH		KVL1065A	1/4 M N.O. CIL. PRESSURE SWITCH KIT	<table border="1"> <thead> <tr> <th>Code</th> <th>Description</th> <th>Qty</th> <th>UOM</th> </tr> </thead> <tbody> <tr> <td>VL1065A1</td> <td>1/4 MALE N.O. PRESSURE SWITCH</td> <td>1</td> <td>PZ</td> </tr> <tr> <td>VM1224A0</td> <td></td> <td>0.150</td> <td>M</td> </tr> </tbody> </table>	Code	Description	Qty	UOM	VL1065A1	1/4 MALE N.O. PRESSURE SWITCH	1	PZ	VM1224A0		0.150	M																				
Code	Description	Qty	UOM																																		
VL1065A1	1/4 MALE N.O. PRESSURE SWITCH	1	PZ																																		
VM1224A0		0.150	M																																		
VL1092A	WASHING SYSTEM OUTLET DOUBLE DISTRIBUTOR		KVL1092A	EUR 2 ROTOR ARMS PLUS CHEMICAL PUMP KIT	<table border="1"> <thead> <tr> <th>Code</th> <th>Description</th> <th>Qty</th> <th>UOM</th> </tr> </thead> <tbody> <tr> <td>0H2143A0</td> <td></td> <td>1</td> <td>PZ</td> </tr> <tr> <td>GN1526A0</td> <td>INT. D.=6.9 TH=1.8 O-RING</td> <td>1</td> <td>PZ</td> </tr> <tr> <td>RC1019A0</td> <td>D=10 ELASTIC CLAMP</td> <td>6</td> <td>PZ</td> </tr> <tr> <td>RC1130A0</td> <td>130X2,6 CLAM</td> <td>1</td> <td>PZ</td> </tr> <tr> <td>RC1242A0</td> <td>D=10 CLOSED CAP</td> <td>2</td> <td>PZ</td> </tr> <tr> <td>TB2820A0</td> <td>PIPE EPDM FOR WASHING SYSTEM</td> <td>0.120</td> <td>M</td> </tr> <tr> <td>VL1019A0</td> <td>VIBRATION PUMP</td> <td>1</td> <td>PZ</td> </tr> </tbody> </table>	Code	Description	Qty	UOM	0H2143A0		1	PZ	GN1526A0	INT. D.=6.9 TH=1.8 O-RING	1	PZ	RC1019A0	D=10 ELASTIC CLAMP	6	PZ	RC1130A0	130X2,6 CLAM	1	PZ	RC1242A0	D=10 CLOSED CAP	2	PZ	TB2820A0	PIPE EPDM FOR WASHING SYSTEM	0.120	M	VL1019A0	VIBRATION PUMP	1	PZ
Code	Description	Qty	UOM																																		
0H2143A0		1	PZ																																		
GN1526A0	INT. D.=6.9 TH=1.8 O-RING	1	PZ																																		
RC1019A0	D=10 ELASTIC CLAMP	6	PZ																																		
RC1130A0	130X2,6 CLAM	1	PZ																																		
RC1242A0	D=10 CLOSED CAP	2	PZ																																		
TB2820A0	PIPE EPDM FOR WASHING SYSTEM	0.120	M																																		
VL1019A0	VIBRATION PUMP	1	PZ																																		

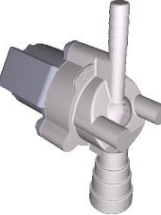

COMPONENT			SPARE PART																																		
Code	Description	Image	Code	Description	Components list																																
VL1092A	WASHING SYSTEM OUTLET DOUBLE DISTRIBUTOR		KVL1092A	EUR 2 ROTOR ARMS PLUS CHEMICAL PUMP KIT	<table border="1"> <thead> <tr> <th>Code</th> <th>Description</th> <th>Qty</th> <th>UOM</th> </tr> </thead> <tbody> <tr> <td>VL1067A0</td> <td>WASHING SYSTEM INLETS DISTRIBUTOR</td> <td>1</td> <td>PZ</td> </tr> <tr> <td>VL1092A0</td> <td>WASHING SYSTEM OUTLET DOUBLE DISTRIBUTOR</td> <td>1</td> <td>PZ</td> </tr> <tr> <td>VL1128A0</td> <td>D6 BARBED CHECK VALVE</td> <td>1</td> <td>PZ</td> </tr> <tr> <td>VL1128A1</td> <td>D6 BARBED CHECK VALVE</td> <td>1</td> <td>PZ</td> </tr> <tr> <td>VM2172A0</td> <td>PUMP-WITH-CI RCUIT LOCKING PIN</td> <td>1</td> <td>PZ</td> </tr> </tbody> </table>	Code	Description	Qty	UOM	VL1067A0	WASHING SYSTEM INLETS DISTRIBUTOR	1	PZ	VL1092A0	WASHING SYSTEM OUTLET DOUBLE DISTRIBUTOR	1	PZ	VL1128A0	D6 BARBED CHECK VALVE	1	PZ	VL1128A1	D6 BARBED CHECK VALVE	1	PZ	VM2172A0	PUMP-WITH-CI RCUIT LOCKING PIN	1	PZ								
					Code	Description	Qty	UOM																													
					VL1067A0	WASHING SYSTEM INLETS DISTRIBUTOR	1	PZ																													
					VL1092A0	WASHING SYSTEM OUTLET DOUBLE DISTRIBUTOR	1	PZ																													
					VL1128A0	D6 BARBED CHECK VALVE	1	PZ																													
VL1128A1	D6 BARBED CHECK VALVE	1	PZ																																		
VM2172A0	PUMP-WITH-CI RCUIT LOCKING PIN	1	PZ																																		
VL1128A	D6 BARBED CHECK VALVE		KVL1128A	D6 VNR BARBED VALVE KIT	<table border="1"> <thead> <tr> <th>Code</th> <th>Description</th> <th>Qty</th> <th>UOM</th> </tr> </thead> <tbody> <tr> <td>0H2143A0</td> <td></td> <td>1</td> <td>PZ</td> </tr> <tr> <td>RC1019A0</td> <td>D=10 ELASTIC CLAMP</td> <td>4</td> <td>PZ</td> </tr> <tr> <td>RC1130A0</td> <td>130X2,6 CLAM</td> <td>1</td> <td>PZ</td> </tr> <tr> <td>TB2820A0</td> <td>PIPE EPDM FOR WASHING SYSTEM</td> <td>0.080</td> <td>M</td> </tr> <tr> <td>VL1128A0</td> <td>D6 BARBED CHECK VALVE</td> <td>1</td> <td>PZ</td> </tr> <tr> <td>VL1128A1</td> <td>D6 BARBED CHECK VALVE</td> <td>1</td> <td>PZ</td> </tr> <tr> <td>VM1224A0</td> <td></td> <td>0.200</td> <td>M</td> </tr> </tbody> </table>	Code	Description	Qty	UOM	0H2143A0		1	PZ	RC1019A0	D=10 ELASTIC CLAMP	4	PZ	RC1130A0	130X2,6 CLAM	1	PZ	TB2820A0	PIPE EPDM FOR WASHING SYSTEM	0.080	M	VL1128A0	D6 BARBED CHECK VALVE	1	PZ	VL1128A1	D6 BARBED CHECK VALVE	1	PZ	VM1224A0		0.200	M
					Code	Description	Qty	UOM																													
					0H2143A0		1	PZ																													
					RC1019A0	D=10 ELASTIC CLAMP	4	PZ																													
					RC1130A0	130X2,6 CLAM	1	PZ																													
TB2820A0	PIPE EPDM FOR WASHING SYSTEM	0.080	M																																		
VL1128A0	D6 BARBED CHECK VALVE	1	PZ																																		
VL1128A1	D6 BARBED CHECK VALVE	1	PZ																																		
VM1224A0		0.200	M																																		
RC1356A	STRAIGHT THREADED FEMALE END 8X1/4" BSP		KRC1356A	STRAIGHT THREADED FEMALE END 8X1/4 BS	<table border="1"> <thead> <tr> <th>Code</th> <th>Description</th> <th>Qty</th> <th>UOM</th> </tr> </thead> <tbody> <tr> <td>RC1356A0</td> <td>STRAIGHT THREADED FEMALE END 8X1/4" BSP</td> <td>1</td> <td>PZ</td> </tr> <tr> <td>VM1224A0</td> <td></td> <td>0.150</td> <td>M</td> </tr> </tbody> </table>	Code	Description	Qty	UOM	RC1356A0	STRAIGHT THREADED FEMALE END 8X1/4" BSP	1	PZ	VM1224A0		0.150	M																				
					Code	Description	Qty	UOM																													
RC1356A0	STRAIGHT THREADED FEMALE END 8X1/4" BSP	1	PZ																																		
VM1224A0		0.150	M																																		
0H2143A			0H2143A0																																		

COMPONENT			SPARE PART																						
Code	Description	Image	Code	Description	Components list																				
RC1242A	D=10 CLOSED CAP		KRC1242A	Ø10 CLOSED CONNECTION 20PCS KIT	<table border="1"> <thead> <tr> <th>Code</th> <th>Description</th> <th>Qty</th> <th>UOM</th> </tr> </thead> <tbody> <tr> <td>RC1242A0</td> <td>D=10 CLOSED CAP</td> <td>20</td> <td>PZ</td> </tr> <tr> <td>VM1224A0</td> <td></td> <td>0.200</td> <td>M</td> </tr> </tbody> </table>	Code	Description	Qty	UOM	RC1242A0	D=10 CLOSED CAP	20	PZ	VM1224A0		0.200	M								
Code	Description	Qty	UOM																						
RC1242A0	D=10 CLOSED CAP	20	PZ																						
VM1224A0		0.200	M																						
EL1252A	1 WAY WATER VALVE + J.G. CONNECTION		KEL1252A	EL2 JG D8-D10 1 WAY SOLENOID VALVE KIT	<table border="1"> <thead> <tr> <th>Code</th> <th>Description</th> <th>Qty</th> <th>UOM</th> </tr> </thead> <tbody> <tr> <td>EL1252A1</td> <td>1 WAY WATER VALVE + J.G. CONNECTION</td> <td>1</td> <td>PZ</td> </tr> <tr> <td>VM1224A0</td> <td></td> <td>0.250</td> <td>M</td> </tr> </tbody> </table>	Code	Description	Qty	UOM	EL1252A1	1 WAY WATER VALVE + J.G. CONNECTION	1	PZ	VM1224A0		0.250	M								
Code	Description	Qty	UOM																						
EL1252A1	1 WAY WATER VALVE + J.G. CONNECTION	1	PZ																						
VM1224A0		0.250	M																						
EL1424B			KEL1424B	EG1 JG D8-D6 SOLENOID VALVE KI	<table border="1"> <thead> <tr> <th>Code</th> <th>Description</th> <th>Qty</th> <th>UOM</th> </tr> </thead> <tbody> <tr> <td>EL1424B0</td> <td></td> <td>1</td> <td>PZ</td> </tr> <tr> <td>VI1095A0</td> <td>3,9X9,5 SELF-THREADING SCREW</td> <td>2</td> <td>PZ</td> </tr> <tr> <td>VI1095B0</td> <td></td> <td>2</td> <td>PZ</td> </tr> <tr> <td>VM1224A0</td> <td></td> <td>0.250</td> <td>M</td> </tr> </tbody> </table>	Code	Description	Qty	UOM	EL1424B0		1	PZ	VI1095A0	3,9X9,5 SELF-THREADING SCREW	2	PZ	VI1095B0		2	PZ	VM1224A0		0.250	M
Code	Description	Qty	UOM																						
EL1424B0		1	PZ																						
VI1095A0	3,9X9,5 SELF-THREADING SCREW	2	PZ																						
VI1095B0		2	PZ																						
VM1224A0		0.250	M																						
EL1436B			KEL1436B	D8 CONNECTION D6 SOLEN. VALVE KIT	<table border="1"> <thead> <tr> <th>Code</th> <th>Description</th> <th>Qty</th> <th>UOM</th> </tr> </thead> <tbody> <tr> <td>EL1436B0</td> <td></td> <td>1</td> <td>PZ</td> </tr> <tr> <td>VM1224A0</td> <td></td> <td>0.250</td> <td>M</td> </tr> </tbody> </table>	Code	Description	Qty	UOM	EL1436B0		1	PZ	VM1224A0		0.250	M								
Code	Description	Qty	UOM																						
EL1436B0		1	PZ																						
VM1224A0		0.250	M																						
0F1506A	XEVC-2011 EXTERNAL UPPER BACK PANEL		0F1506A0	XEVC-2011 EXTERNAL UPPER BACK PANEL																					

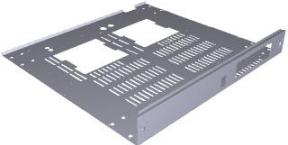
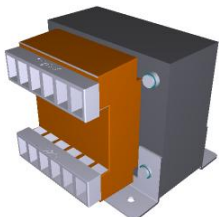

COMPONENT			SPARE PART																		
Code	Description	Image	Code	Description	Components list																
0H3750A	INOX PLATE REINFORCEMENT SIDE XVC1004P		0H3750A1	INOX PLATE REINFORCEMENT SIDE XVC1004P																	
0D2312A	XEVC-2011 LEFT SIDE PANEL		0D2312A0	XEVC-2011 LEFT SIDE PANEL																	
0D2330A	XEVC-2011-G EXT. TOP FRONT COVER		0D2330A0	XEVC-2011-G EXT. TOP FRONT COVER																	
0E1358B	XEVC-2011-G EXTERNAL BOTTOM PANEL		0E1358B1	XEVC-2011-G EXTERNAL BOTTOM PANEL																	
VE1648A			KVE1648A	INSULATION TRANSFORMER 230-220/40VA KI	<table border="1"> <thead> <tr> <th>Code</th> <th>Description</th> <th>Qty</th> <th>UOM</th> </tr> </thead> <tbody> <tr> <td>0H1988A0</td> <td>GAS INSULATION PERFORATED PLATE</td> <td>1</td> <td>PZ</td> </tr> <tr> <td>CE1006A0</td> <td>2 WAYS FEMALE INAR-LOCK CONNECTOR</td> <td>1</td> <td>PZ</td> </tr> <tr> <td>CE1030A0</td> <td>FEMALE FASTON COVER 6.3X0.8 0,5-1MMQ</td> <td>3</td> <td>PZ</td> </tr> </tbody> </table>	Code	Description	Qty	UOM	0H1988A0	GAS INSULATION PERFORATED PLATE	1	PZ	CE1006A0	2 WAYS FEMALE INAR-LOCK CONNECTOR	1	PZ	CE1030A0	FEMALE FASTON COVER 6.3X0.8 0,5-1MMQ	3	PZ
Code	Description	Qty	UOM																		
0H1988A0	GAS INSULATION PERFORATED PLATE	1	PZ																		
CE1006A0	2 WAYS FEMALE INAR-LOCK CONNECTOR	1	PZ																		
CE1030A0	FEMALE FASTON COVER 6.3X0.8 0,5-1MMQ	3	PZ																		

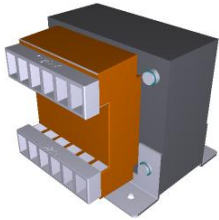
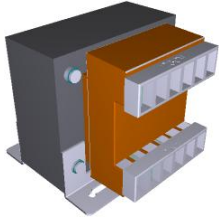
COMPONENT			SPARE PART																																														
Code	Description	Image	Code	Description	Components list																																												
VE1648A			KVE1648A	INSULATION TRANSFORMER 230-220/40VA KI	<table border="1"> <thead> <tr> <th>Code</th> <th>Description</th> <th>Qty</th> <th>UOM</th> </tr> </thead> <tbody> <tr> <td>CE1205A0</td> <td>FEMALE INAR-LOCK END CONNECTOR</td> <td>2</td> <td>PZ</td> </tr> <tr> <td>CE1225A0</td> <td>BROWN UNIP SIL RUBB WIRE D 0,75MMQ</td> <td>0.400</td> <td>M</td> </tr> <tr> <td>CE1230A0</td> <td>BLUE UNIP SIL RUBB WIRE D 0,75MMQ</td> <td>0.400</td> <td>M</td> </tr> <tr> <td>CE1270A0</td> <td>YELL/GREEN UNIP SIL RUBB WIRE D 0,75MMQ</td> <td>0.300</td> <td>M</td> </tr> <tr> <td>CE1325A0</td> <td>2 WAYS MALE INAR-LOCK CONNECTOR</td> <td>1</td> <td>PZ</td> </tr> <tr> <td>CE1350A0</td> <td>MALE INAR-LOCK END CONNECTOR</td> <td>2</td> <td>PZ</td> </tr> <tr> <td>CE1660A0</td> <td>6,3X0,8 FEMALE FASTON COVE</td> <td>3</td> <td>PZ</td> </tr> <tr> <td>VE1647A0</td> <td>INSULATION TRANSFORME R 230-220 / 40VA</td> <td>1</td> <td>PZ</td> </tr> <tr> <td>VI1950A0</td> <td>ST. STEEL 4,2X13 TCB SELF-DRILLIN G SCREW</td> <td>2</td> <td>PZ</td> </tr> <tr> <td>VM2147A0</td> <td>410X343X15 MM PINK SMOOTH ESD SPONGE</td> <td>1</td> <td>PZ</td> </tr> </tbody> </table>	Code	Description	Qty	UOM	CE1205A0	FEMALE INAR-LOCK END CONNECTOR	2	PZ	CE1225A0	BROWN UNIP SIL RUBB WIRE D 0,75MMQ	0.400	M	CE1230A0	BLUE UNIP SIL RUBB WIRE D 0,75MMQ	0.400	M	CE1270A0	YELL/GREEN UNIP SIL RUBB WIRE D 0,75MMQ	0.300	M	CE1325A0	2 WAYS MALE INAR-LOCK CONNECTOR	1	PZ	CE1350A0	MALE INAR-LOCK END CONNECTOR	2	PZ	CE1660A0	6,3X0,8 FEMALE FASTON COVE	3	PZ	VE1647A0	INSULATION TRANSFORME R 230-220 / 40VA	1	PZ	VI1950A0	ST. STEEL 4,2X13 TCB SELF-DRILLIN G SCREW	2	PZ	VM2147A0	410X343X15 MM PINK SMOOTH ESD SPONGE	1	PZ
Code	Description	Qty	UOM																																														
CE1205A0	FEMALE INAR-LOCK END CONNECTOR	2	PZ																																														
CE1225A0	BROWN UNIP SIL RUBB WIRE D 0,75MMQ	0.400	M																																														
CE1230A0	BLUE UNIP SIL RUBB WIRE D 0,75MMQ	0.400	M																																														
CE1270A0	YELL/GREEN UNIP SIL RUBB WIRE D 0,75MMQ	0.300	M																																														
CE1325A0	2 WAYS MALE INAR-LOCK CONNECTOR	1	PZ																																														
CE1350A0	MALE INAR-LOCK END CONNECTOR	2	PZ																																														
CE1660A0	6,3X0,8 FEMALE FASTON COVE	3	PZ																																														
VE1647A0	INSULATION TRANSFORME R 230-220 / 40VA	1	PZ																																														
VI1950A0	ST. STEEL 4,2X13 TCB SELF-DRILLIN G SCREW	2	PZ																																														
VM2147A0	410X343X15 MM PINK SMOOTH ESD SPONGE	1	PZ																																														
VE1647A	INSULATION TRANSFORMER 230-220 / 40VA		KVE1648A	INSULATION TRANSFORMER 230-220/40VA KI	<table border="1"> <thead> <tr> <th>Code</th> <th>Description</th> <th>Qty</th> <th>UOM</th> </tr> </thead> <tbody> <tr> <td>0H1988A0</td> <td>GAS INSULATION PERFORATED PLATE</td> <td>1</td> <td>PZ</td> </tr> <tr> <td>CE1006A0</td> <td>2 WAYS FEMALE INAR-LOCK CONNECTOR</td> <td>1</td> <td>PZ</td> </tr> <tr> <td>CE1030A0</td> <td>FEMALE FASTON COVER 6.3X0.8 0,5-1MMQ</td> <td>3</td> <td>PZ</td> </tr> <tr> <td>CE1205A0</td> <td>FEMALE INAR-LOCK END CONNECTOR</td> <td>2</td> <td>PZ</td> </tr> </tbody> </table>	Code	Description	Qty	UOM	0H1988A0	GAS INSULATION PERFORATED PLATE	1	PZ	CE1006A0	2 WAYS FEMALE INAR-LOCK CONNECTOR	1	PZ	CE1030A0	FEMALE FASTON COVER 6.3X0.8 0,5-1MMQ	3	PZ	CE1205A0	FEMALE INAR-LOCK END CONNECTOR	2	PZ																								
Code	Description	Qty	UOM																																														
0H1988A0	GAS INSULATION PERFORATED PLATE	1	PZ																																														
CE1006A0	2 WAYS FEMALE INAR-LOCK CONNECTOR	1	PZ																																														
CE1030A0	FEMALE FASTON COVER 6.3X0.8 0,5-1MMQ	3	PZ																																														
CE1205A0	FEMALE INAR-LOCK END CONNECTOR	2	PZ																																														

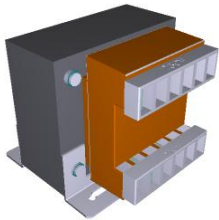
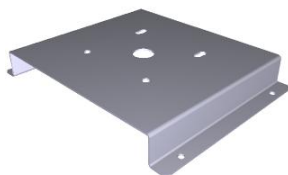
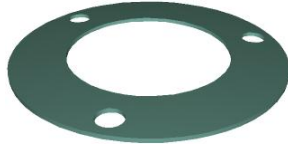
COMPONENT			SPARE PART																																										
Code	Description	Image	Code	Description	Components list																																								
VE1647A	INSULATION TRANSFORMER 230-220 / 40VA		KVE1648A	INSULATION TRANSFORMER 230-220/40VA KI	<table border="1"> <thead> <tr> <th>Code</th> <th>Description</th> <th>Qty</th> <th>UOM</th> </tr> </thead> <tbody> <tr> <td>CE1225A0</td> <td>BROWN UNIP SIL RUBB WIRE D 0,75MMQ</td> <td>0.400</td> <td>M</td> </tr> <tr> <td>CE1230A0</td> <td>BLUE UNIP SIL RUBB WIRE D 0,75MMQ</td> <td>0.400</td> <td>M</td> </tr> <tr> <td>CE1270A0</td> <td>YELL/GREEN UNIP SIL RUBB WIRE D 0,75MMQ</td> <td>0.300</td> <td>M</td> </tr> <tr> <td>CE1325A0</td> <td>2 WAYS MALE INAR-LOCK CONNECTOR</td> <td>1</td> <td>PZ</td> </tr> <tr> <td>CE1350A0</td> <td>MALE INAR-LOCK END CONNECTOR</td> <td>2</td> <td>PZ</td> </tr> <tr> <td>CE1660A0</td> <td>6,3X0,8 FEMALE FASTON COVE</td> <td>3</td> <td>PZ</td> </tr> <tr> <td>VE1647A0</td> <td>INSULATION TRANSFORME R 230-220 / 40VA</td> <td>1</td> <td>PZ</td> </tr> <tr> <td>VI1950A0</td> <td>ST. STEEL 4,2X13 TCB SELF-DRILLIN G SCREW</td> <td>2</td> <td>PZ</td> </tr> <tr> <td>VM2147A0</td> <td>410X343X15 MM PINK SMOOTH ESD SPONGE</td> <td>1</td> <td>PZ</td> </tr> </tbody> </table>	Code	Description	Qty	UOM	CE1225A0	BROWN UNIP SIL RUBB WIRE D 0,75MMQ	0.400	M	CE1230A0	BLUE UNIP SIL RUBB WIRE D 0,75MMQ	0.400	M	CE1270A0	YELL/GREEN UNIP SIL RUBB WIRE D 0,75MMQ	0.300	M	CE1325A0	2 WAYS MALE INAR-LOCK CONNECTOR	1	PZ	CE1350A0	MALE INAR-LOCK END CONNECTOR	2	PZ	CE1660A0	6,3X0,8 FEMALE FASTON COVE	3	PZ	VE1647A0	INSULATION TRANSFORME R 230-220 / 40VA	1	PZ	VI1950A0	ST. STEEL 4,2X13 TCB SELF-DRILLIN G SCREW	2	PZ	VM2147A0	410X343X15 MM PINK SMOOTH ESD SPONGE	1	PZ
Code	Description	Qty	UOM																																										
CE1225A0	BROWN UNIP SIL RUBB WIRE D 0,75MMQ	0.400	M																																										
CE1230A0	BLUE UNIP SIL RUBB WIRE D 0,75MMQ	0.400	M																																										
CE1270A0	YELL/GREEN UNIP SIL RUBB WIRE D 0,75MMQ	0.300	M																																										
CE1325A0	2 WAYS MALE INAR-LOCK CONNECTOR	1	PZ																																										
CE1350A0	MALE INAR-LOCK END CONNECTOR	2	PZ																																										
CE1660A0	6,3X0,8 FEMALE FASTON COVE	3	PZ																																										
VE1647A0	INSULATION TRANSFORME R 230-220 / 40VA	1	PZ																																										
VI1950A0	ST. STEEL 4,2X13 TCB SELF-DRILLIN G SCREW	2	PZ																																										
VM2147A0	410X343X15 MM PINK SMOOTH ESD SPONGE	1	PZ																																										
0H7489A	VE1022A TRANSFORMER HOLDING PLATE		0H7489A1	VE1022A TRANSFORMER HOLDING PLATE																																									
GN1585B	D40 CHIMNEY - EXHCHANGER HOLDING GASKET		KG1585A	2PCS CHIMNEYS BAFFLE GASKET KIT	<table border="1"> <thead> <tr> <th>Code</th> <th>Description</th> <th>Qty</th> <th>UOM</th> </tr> </thead> <tbody> <tr> <td>GN1585A0</td> <td>Ø30X1 T FITTING</td> <td>2</td> <td>PZ</td> </tr> <tr> <td>VM1224A0</td> <td></td> <td>0.250</td> <td>M</td> </tr> </tbody> </table>	Code	Description	Qty	UOM	GN1585A0	Ø30X1 T FITTING	2	PZ	VM1224A0		0.250	M																												
Code	Description	Qty	UOM																																										
GN1585A0	Ø30X1 T FITTING	2	PZ																																										
VM1224A0		0.250	M																																										



COMPONENT			SPARE PART																						
Code	Description	Image	Code	Description	Components list																				
0F1507B	XEVC-2011 SERIES LOWER BACK		0F1507B0	XEVC-2011 SERIES LOWER BACK																					
VL1086A	LIMESCALE REMOVER NEODYMIUM MAGNET		KVL1086A	NEODYMIUM MAGNET ANTI-LIMESCALE KI	<table border="1"> <thead> <tr> <th>Code</th> <th>Description</th> <th>Qty</th> <th>UOM</th> </tr> </thead> <tbody> <tr> <td>VL1086A0</td> <td>LIMESCALE REMOVER NEODYMIUM MAGNET</td> <td>2</td> <td>PZ</td> </tr> <tr> <td>VM1224A0</td> <td></td> <td>0.200</td> <td>M</td> </tr> </tbody> </table>	Code	Description	Qty	UOM	VL1086A0	LIMESCALE REMOVER NEODYMIUM MAGNET	2	PZ	VM1224A0		0.200	M								
Code	Description	Qty	UOM																						
VL1086A0	LIMESCALE REMOVER NEODYMIUM MAGNET	2	PZ																						
VM1224A0		0.200	M																						
VL1096A	2PCS T-SHAPED FIT-D6-D10 HOLD-MAGNET		KVL1096A	T - SHAPED FIT-D6-D10 HOLD-2 MAGNETS KIT	<table border="1"> <thead> <tr> <th>Code</th> <th>Description</th> <th>Qty</th> <th>UOM</th> </tr> </thead> <tbody> <tr> <td>RC1018A0</td> <td>ZINC PLATED D12 ELASTIC CLAMP</td> <td>2</td> <td>PZ</td> </tr> <tr> <td>VL1086A0</td> <td>LIMESCALE REMOVER NEODYMIUM MAGNET</td> <td>2</td> <td>PZ</td> </tr> <tr> <td>VL1096A1</td> <td>2PCS T-SHAPED FIT-D6-D10 HOLD-MAGNE</td> <td>1</td> <td>PZ</td> </tr> <tr> <td>VM1224A0</td> <td></td> <td>0.200</td> <td>M</td> </tr> </tbody> </table>	Code	Description	Qty	UOM	RC1018A0	ZINC PLATED D12 ELASTIC CLAMP	2	PZ	VL1086A0	LIMESCALE REMOVER NEODYMIUM MAGNET	2	PZ	VL1096A1	2PCS T-SHAPED FIT-D6-D10 HOLD-MAGNE	1	PZ	VM1224A0		0.200	M
Code	Description	Qty	UOM																						
RC1018A0	ZINC PLATED D12 ELASTIC CLAMP	2	PZ																						
VL1086A0	LIMESCALE REMOVER NEODYMIUM MAGNET	2	PZ																						
VL1096A1	2PCS T-SHAPED FIT-D6-D10 HOLD-MAGNE	1	PZ																						
VM1224A0		0.200	M																						
VM1054A	H7.8 PRESSURE REDUCER RING NUT		KVM1054A	H7.8 PRESSURE REDUCER DIAL KIT	<table border="1"> <thead> <tr> <th>Code</th> <th>Description</th> <th>Qty</th> <th>UOM</th> </tr> </thead> <tbody> <tr> <td>VM1054A0</td> <td>H7.8 PRESSURE REDUCER RING NUT</td> <td>1</td> <td>PZ</td> </tr> <tr> <td>VM1224A0</td> <td></td> <td>0.200</td> <td>M</td> </tr> </tbody> </table>	Code	Description	Qty	UOM	VM1054A0	H7.8 PRESSURE REDUCER RING NUT	1	PZ	VM1224A0		0.200	M								
Code	Description	Qty	UOM																						
VM1054A0	H7.8 PRESSURE REDUCER RING NUT	1	PZ																						
VM1224A0		0.200	M																						
			KVL1117A	EUR MM 2016+LMT FILTER+PRESS. RED. KIT	<table border="1"> <thead> <tr> <th>Code</th> <th>Description</th> <th>Qty</th> <th>UOM</th> </tr> </thead> <tbody> <tr> <td>0H7472A1</td> <td>DISTRIBUTOR SUPPORT PLATE</td> <td>1</td> <td>PZ</td> </tr> <tr> <td>RC1004A0</td> <td>Ø10-Ø8-8 Y CONNECTION</td> <td>1</td> <td>PZ</td> </tr> <tr> <td>RC1243A0</td> <td>Ø10F-Ø10M ELBOW CONNECTION + JG END KIT</td> <td>1</td> <td>PZ</td> </tr> <tr> <td>RC1372A0</td> <td>Ø10M-1/4 M CIL. STRAIGHT FITTING</td> <td>2</td> <td>PZ</td> </tr> </tbody> </table>	Code	Description	Qty	UOM	0H7472A1	DISTRIBUTOR SUPPORT PLATE	1	PZ	RC1004A0	Ø10-Ø8-8 Y CONNECTION	1	PZ	RC1243A0	Ø10F-Ø10M ELBOW CONNECTION + JG END KIT	1	PZ	RC1372A0	Ø10M-1/4 M CIL. STRAIGHT FITTING	2	PZ
Code	Description	Qty	UOM																						
0H7472A1	DISTRIBUTOR SUPPORT PLATE	1	PZ																						
RC1004A0	Ø10-Ø8-8 Y CONNECTION	1	PZ																						
RC1243A0	Ø10F-Ø10M ELBOW CONNECTION + JG END KIT	1	PZ																						
RC1372A0	Ø10M-1/4 M CIL. STRAIGHT FITTING	2	PZ																						



COMPONENT			SPARE PART																														
Code	Description	Image	Code	Description	Components list																												
VM1054A	H7.8 PRESSURE REDUCER RING NUT		KVL1117A	EUR MM 2016+LMT FILTER+PRESS. RED. KIT	<table border="1"> <thead> <tr> <th>Code</th> <th>Description</th> <th>Qty</th> <th>UOM</th> </tr> </thead> <tbody> <tr> <td>VI1220A1</td> <td>4,2X12 TCB SELF-TAPPIN G SCREW</td> <td>4</td> <td>PZ</td> </tr> <tr> <td>VL1014B1</td> <td>PRESSURE REDUCER WITH DISTRIBUTOR</td> <td>1</td> <td>PZ</td> </tr> <tr> <td>VL1014B2</td> <td></td> <td>1</td> <td>PZ</td> </tr> <tr> <td>VL1034C0</td> <td>MESH WATER FILTER D10</td> <td>1</td> <td>PZ</td> </tr> <tr> <td>VL1062C0</td> <td>PRESSURE REDUCER-FILTER LOCKING FORK</td> <td>1</td> <td>PZ</td> </tr> <tr> <td>VM1054A0</td> <td>H7.8 PRESSURE REDUCER RING NUT</td> <td>1</td> <td>PZ</td> </tr> </tbody> </table>	Code	Description	Qty	UOM	VI1220A1	4,2X12 TCB SELF-TAPPIN G SCREW	4	PZ	VL1014B1	PRESSURE REDUCER WITH DISTRIBUTOR	1	PZ	VL1014B2		1	PZ	VL1034C0	MESH WATER FILTER D10	1	PZ	VL1062C0	PRESSURE REDUCER-FILTER LOCKING FORK	1	PZ	VM1054A0	H7.8 PRESSURE REDUCER RING NUT	1	PZ
Code	Description	Qty	UOM																														
VI1220A1	4,2X12 TCB SELF-TAPPIN G SCREW	4	PZ																														
VL1014B1	PRESSURE REDUCER WITH DISTRIBUTOR	1	PZ																														
VL1014B2		1	PZ																														
VL1034C0	MESH WATER FILTER D10	1	PZ																														
VL1062C0	PRESSURE REDUCER-FILTER LOCKING FORK	1	PZ																														
VM1054A0	H7.8 PRESSURE REDUCER RING NUT	1	PZ																														
RC1396A	JG D10-1/4 STRAIGHT END FITTING		KVL0014B	EUR 2017 MIND.MAPS PRESSURE REDUCER KIT	<table border="1"> <thead> <tr> <th>Code</th> <th>Description</th> <th>Qty</th> <th>UOM</th> </tr> </thead> <tbody> <tr> <td>RC1372A0</td> <td>Ø10M-1/4 M CIL. STRAIGHT FITTING</td> <td>1</td> <td>PZ</td> </tr> <tr> <td>RC1396A0</td> <td>JG D10-1/4 STRAIGHT END FITTING</td> <td>1</td> <td>PZ</td> </tr> <tr> <td>VL1014B1</td> <td>PRESSURE REDUCER WITH DISTRIBUTOR</td> <td>1</td> <td>PZ</td> </tr> <tr> <td>VL1014B2</td> <td></td> <td>1</td> <td>PZ</td> </tr> <tr> <td>VM1054A0</td> <td>H7.8 PRESSURE REDUCER RING NUT</td> <td>1</td> <td>PZ</td> </tr> </tbody> </table>	Code	Description	Qty	UOM	RC1372A0	Ø10M-1/4 M CIL. STRAIGHT FITTING	1	PZ	RC1396A0	JG D10-1/4 STRAIGHT END FITTING	1	PZ	VL1014B1	PRESSURE REDUCER WITH DISTRIBUTOR	1	PZ	VL1014B2		1	PZ	VM1054A0	H7.8 PRESSURE REDUCER RING NUT	1	PZ				
Code	Description	Qty	UOM																														
RC1372A0	Ø10M-1/4 M CIL. STRAIGHT FITTING	1	PZ																														
RC1396A0	JG D10-1/4 STRAIGHT END FITTING	1	PZ																														
VL1014B1	PRESSURE REDUCER WITH DISTRIBUTOR	1	PZ																														
VL1014B2		1	PZ																														
VM1054A0	H7.8 PRESSURE REDUCER RING NUT	1	PZ																														
VL1014B			KVL1117A	EUR MM 2016+LMT FILTER+PRESS. RED. KIT	<table border="1"> <thead> <tr> <th>Code</th> <th>Description</th> <th>Qty</th> <th>UOM</th> </tr> </thead> <tbody> <tr> <td>0H7472A1</td> <td>DISTRIBUTOR SUPPORT PLATE</td> <td>1</td> <td>PZ</td> </tr> <tr> <td>RC1004A0</td> <td>Ø10-Ø8-8 Y CONNECTION</td> <td>1</td> <td>PZ</td> </tr> <tr> <td>RC1243A0</td> <td>Ø10F-Ø10M ELBOW CONNECTION + JG END KIT</td> <td>1</td> <td>PZ</td> </tr> <tr> <td>RC1372A0</td> <td>Ø10M-1/4 M CIL. STRAIGHT FITTING</td> <td>2</td> <td>PZ</td> </tr> <tr> <td>VI1220A1</td> <td>4,2X12 TCB SELF-TAPPIN G SCREW</td> <td>4</td> <td>PZ</td> </tr> </tbody> </table>	Code	Description	Qty	UOM	0H7472A1	DISTRIBUTOR SUPPORT PLATE	1	PZ	RC1004A0	Ø10-Ø8-8 Y CONNECTION	1	PZ	RC1243A0	Ø10F-Ø10M ELBOW CONNECTION + JG END KIT	1	PZ	RC1372A0	Ø10M-1/4 M CIL. STRAIGHT FITTING	2	PZ	VI1220A1	4,2X12 TCB SELF-TAPPIN G SCREW	4	PZ				
Code	Description	Qty	UOM																														
0H7472A1	DISTRIBUTOR SUPPORT PLATE	1	PZ																														
RC1004A0	Ø10-Ø8-8 Y CONNECTION	1	PZ																														
RC1243A0	Ø10F-Ø10M ELBOW CONNECTION + JG END KIT	1	PZ																														
RC1372A0	Ø10M-1/4 M CIL. STRAIGHT FITTING	2	PZ																														
VI1220A1	4,2X12 TCB SELF-TAPPIN G SCREW	4	PZ																														





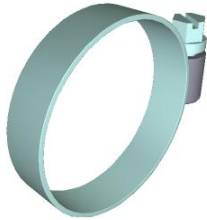

COMPONENT			SPARE PART																										
Code	Description	Image	Code	Description	Components list																								
VL1014B			KVL1117A	EUR MM 2016+LMT FILTER+PRESS. RED. KIT	<table border="1"> <thead> <tr> <th>Code</th> <th>Description</th> <th>Qty</th> <th>UOM</th> </tr> </thead> <tbody> <tr> <td>VL1014B1</td> <td>PRESSURE REDUCER WITH DISTRIBUTOR</td> <td>1</td> <td>PZ</td> </tr> <tr> <td>VL1014B2</td> <td></td> <td>1</td> <td>PZ</td> </tr> <tr> <td>VL1034C0</td> <td>MESH WATER FILTER D10</td> <td>1</td> <td>PZ</td> </tr> <tr> <td>VL1062C0</td> <td>PRESSURE REDUCER-FIL TER LOCKING FORK</td> <td>1</td> <td>PZ</td> </tr> <tr> <td>VM1054A0</td> <td>H7.8 PRESSURE REDUCER RING NUT</td> <td>1</td> <td>PZ</td> </tr> </tbody> </table>	Code	Description	Qty	UOM	VL1014B1	PRESSURE REDUCER WITH DISTRIBUTOR	1	PZ	VL1014B2		1	PZ	VL1034C0	MESH WATER FILTER D10	1	PZ	VL1062C0	PRESSURE REDUCER-FIL TER LOCKING FORK	1	PZ	VM1054A0	H7.8 PRESSURE REDUCER RING NUT	1	PZ
			Code	Description	Qty	UOM																							
			VL1014B1	PRESSURE REDUCER WITH DISTRIBUTOR	1	PZ																							
			VL1014B2		1	PZ																							
VL1034C0	MESH WATER FILTER D10	1	PZ																										
VL1062C0	PRESSURE REDUCER-FIL TER LOCKING FORK	1	PZ																										
VM1054A0	H7.8 PRESSURE REDUCER RING NUT	1	PZ																										
KVL0020A	PRESSURE REDUCER 0311-05XX FROM 10/2018	<table border="1"> <thead> <tr> <th>Code</th> <th>Description</th> <th>Qty</th> <th>UOM</th> </tr> </thead> <tbody> <tr> <td>RC1396A0</td> <td>JG D10-1/4 STRAIGHT END FITTING</td> <td>2</td> <td>PZ</td> </tr> <tr> <td>VL1014B1</td> <td>PRESSURE REDUCER WITH DISTRIBUTOR</td> <td>1</td> <td>PZ</td> </tr> <tr> <td>VL1014B2</td> <td></td> <td>1</td> <td>PZ</td> </tr> <tr> <td>VM1054A0</td> <td>H7.8 PRESSURE REDUCER RING NUT</td> <td>1</td> <td>PZ</td> </tr> </tbody> </table>	Code	Description	Qty	UOM	RC1396A0	JG D10-1/4 STRAIGHT END FITTING	2	PZ	VL1014B1	PRESSURE REDUCER WITH DISTRIBUTOR	1	PZ	VL1014B2		1	PZ	VM1054A0	H7.8 PRESSURE REDUCER RING NUT	1	PZ							
Code	Description	Qty	UOM																										
RC1396A0	JG D10-1/4 STRAIGHT END FITTING	2	PZ																										
VL1014B1	PRESSURE REDUCER WITH DISTRIBUTOR	1	PZ																										
VL1014B2		1	PZ																										
VM1054A0	H7.8 PRESSURE REDUCER RING NUT	1	PZ																										
KVL0014B	EUR 2017 MIND.MAPS PRESSURE REDUCER KIT	<table border="1"> <thead> <tr> <th>Code</th> <th>Description</th> <th>Qty</th> <th>UOM</th> </tr> </thead> <tbody> <tr> <td>RC1372A0</td> <td>Ø10M-1/4 M CIL. STRAIGHT FITTING</td> <td>1</td> <td>PZ</td> </tr> <tr> <td>RC1396A0</td> <td>JG D10-1/4 STRAIGHT END FITTING</td> <td>1</td> <td>PZ</td> </tr> <tr> <td>VL1014B1</td> <td>PRESSURE REDUCER WITH DISTRIBUTOR</td> <td>1</td> <td>PZ</td> </tr> <tr> <td>VL1014B2</td> <td></td> <td>1</td> <td>PZ</td> </tr> <tr> <td>VM1054A0</td> <td>H7.8 PRESSURE REDUCER RING NUT</td> <td>1</td> <td>PZ</td> </tr> </tbody> </table>	Code	Description	Qty	UOM	RC1372A0	Ø10M-1/4 M CIL. STRAIGHT FITTING	1	PZ	RC1396A0	JG D10-1/4 STRAIGHT END FITTING	1	PZ	VL1014B1	PRESSURE REDUCER WITH DISTRIBUTOR	1	PZ	VL1014B2		1	PZ	VM1054A0	H7.8 PRESSURE REDUCER RING NUT	1	PZ			
Code	Description	Qty	UOM																										
RC1372A0	Ø10M-1/4 M CIL. STRAIGHT FITTING	1	PZ																										
RC1396A0	JG D10-1/4 STRAIGHT END FITTING	1	PZ																										
VL1014B1	PRESSURE REDUCER WITH DISTRIBUTOR	1	PZ																										
VL1014B2		1	PZ																										
VM1054A0	H7.8 PRESSURE REDUCER RING NUT	1	PZ																										
KVL0014A	EUR MIND.MAPS PRESSURE REDUCER KIT 2016	<table border="1"> <thead> <tr> <th>Code</th> <th>Description</th> <th>Qty</th> <th>UOM</th> </tr> </thead> <tbody> <tr> <td>RC1372A0</td> <td>Ø10M-1/4 M CIL. STRAIGHT FITTING</td> <td>2</td> <td>PZ</td> </tr> </tbody> </table>	Code	Description	Qty	UOM	RC1372A0	Ø10M-1/4 M CIL. STRAIGHT FITTING	2	PZ																			
Code	Description	Qty	UOM																										
RC1372A0	Ø10M-1/4 M CIL. STRAIGHT FITTING	2	PZ																										

COMPONENT			SPARE PART																																														
Code	Description	Image	Code	Description	Components list																																												
VL1014B			KVL0014A	EUR MIND.MAPS PRESSURE REDUCER KIT 2016	<table border="1"> <thead> <tr> <th>Code</th> <th>Description</th> <th>Qty</th> <th>UOM</th> </tr> </thead> <tbody> <tr> <td>VL1014B1</td> <td>PRESSURE REDUCER WITH DISTRIBUTOR</td> <td>1</td> <td>PZ</td> </tr> <tr> <td>VL1014B2</td> <td></td> <td>1</td> <td>PZ</td> </tr> <tr> <td>VM1054A0</td> <td>H7.8 PRESSURE REDUCER RING NUT</td> <td>1</td> <td>PZ</td> </tr> </tbody> </table>	Code	Description	Qty	UOM	VL1014B1	PRESSURE REDUCER WITH DISTRIBUTOR	1	PZ	VL1014B2		1	PZ	VM1054A0	H7.8 PRESSURE REDUCER RING NUT	1	PZ																												
			Code	Description	Qty	UOM																																											
VL1014B1	PRESSURE REDUCER WITH DISTRIBUTOR	1	PZ																																														
VL1014B2		1	PZ																																														
VM1054A0	H7.8 PRESSURE REDUCER RING NUT	1	PZ																																														
KVL0010A	S.4 - 5 WATER PRESSURE REDUCER KIT	<table border="1"> <thead> <tr> <th>Code</th> <th>Description</th> <th>Qty</th> <th>UOM</th> </tr> </thead> <tbody> <tr> <td>EL1210A0</td> <td>D8-BSP1/4 JG STRAIGHT END CONNECTION</td> <td>2</td> <td>PZ</td> </tr> <tr> <td>VL1014B1</td> <td>PRESSURE REDUCER WITH DISTRIBUTOR</td> <td>1</td> <td>PZ</td> </tr> <tr> <td>VL1014B2</td> <td></td> <td>1</td> <td>PZ</td> </tr> </tbody> </table>	Code	Description	Qty	UOM	EL1210A0	D8-BSP1/4 JG STRAIGHT END CONNECTION	2	PZ	VL1014B1	PRESSURE REDUCER WITH DISTRIBUTOR	1	PZ	VL1014B2		1	PZ																															
Code	Description	Qty	UOM																																														
EL1210A0	D8-BSP1/4 JG STRAIGHT END CONNECTION	2	PZ																																														
VL1014B1	PRESSURE REDUCER WITH DISTRIBUTOR	1	PZ																																														
VL1014B2		1	PZ																																														
RC1243A	Ø10F-Ø10M ELBOW CONNECTION + JG END KIT		KVL1117A	EUR MM 2016+LMT FILTER+PRESS. RED. KIT	<table border="1"> <thead> <tr> <th>Code</th> <th>Description</th> <th>Qty</th> <th>UOM</th> </tr> </thead> <tbody> <tr> <td>0H7472A1</td> <td>DISTRIBUTOR SUPPORT PLATE</td> <td>1</td> <td>PZ</td> </tr> <tr> <td>RC1004A0</td> <td>Ø10-Ø8-8 Y CONNECTION</td> <td>1</td> <td>PZ</td> </tr> <tr> <td>RC1243A0</td> <td>Ø10F-Ø10M ELBOW CONNECTION + JG END KIT</td> <td>1</td> <td>PZ</td> </tr> <tr> <td>RC1372A0</td> <td>Ø10M-1/4 M CIL. STRAIGHT FITTING</td> <td>2</td> <td>PZ</td> </tr> <tr> <td>VI1220A1</td> <td>4,2X12 TCB SELF-TAPPIN G SCREW</td> <td>4</td> <td>PZ</td> </tr> <tr> <td>VL1014B1</td> <td>PRESSURE REDUCER WITH DISTRIBUTOR</td> <td>1</td> <td>PZ</td> </tr> <tr> <td>VL1014B2</td> <td></td> <td>1</td> <td>PZ</td> </tr> <tr> <td>VL1034C0</td> <td>MESH WATER FILTER D10</td> <td>1</td> <td>PZ</td> </tr> <tr> <td>VL1062C0</td> <td>PRESSURE REDUCER-FIL TER LOCKING FORK</td> <td>1</td> <td>PZ</td> </tr> <tr> <td>VM1054A0</td> <td>H7.8 PRESSURE REDUCER RING NUT</td> <td>1</td> <td>PZ</td> </tr> </tbody> </table>	Code	Description	Qty	UOM	0H7472A1	DISTRIBUTOR SUPPORT PLATE	1	PZ	RC1004A0	Ø10-Ø8-8 Y CONNECTION	1	PZ	RC1243A0	Ø10F-Ø10M ELBOW CONNECTION + JG END KIT	1	PZ	RC1372A0	Ø10M-1/4 M CIL. STRAIGHT FITTING	2	PZ	VI1220A1	4,2X12 TCB SELF-TAPPIN G SCREW	4	PZ	VL1014B1	PRESSURE REDUCER WITH DISTRIBUTOR	1	PZ	VL1014B2		1	PZ	VL1034C0	MESH WATER FILTER D10	1	PZ	VL1062C0	PRESSURE REDUCER-FIL TER LOCKING FORK	1	PZ	VM1054A0	H7.8 PRESSURE REDUCER RING NUT	1	PZ
Code	Description	Qty	UOM																																														
0H7472A1	DISTRIBUTOR SUPPORT PLATE	1	PZ																																														
RC1004A0	Ø10-Ø8-8 Y CONNECTION	1	PZ																																														
RC1243A0	Ø10F-Ø10M ELBOW CONNECTION + JG END KIT	1	PZ																																														
RC1372A0	Ø10M-1/4 M CIL. STRAIGHT FITTING	2	PZ																																														
VI1220A1	4,2X12 TCB SELF-TAPPIN G SCREW	4	PZ																																														
VL1014B1	PRESSURE REDUCER WITH DISTRIBUTOR	1	PZ																																														
VL1014B2		1	PZ																																														
VL1034C0	MESH WATER FILTER D10	1	PZ																																														
VL1062C0	PRESSURE REDUCER-FIL TER LOCKING FORK	1	PZ																																														
VM1054A0	H7.8 PRESSURE REDUCER RING NUT	1	PZ																																														



COMPONENT			SPARE PART																										
Code	Description	Image	Code	Description	Components list																								
RC1243A	Ø10F-Ø10M ELBOW CONNECTION + JG END KIT		KRC1243A	Ø10F-Ø10M ELBOW CONN + JG END 10 PCS KIT	<table border="1"> <thead> <tr> <th>Code</th> <th>Description</th> <th>Qty</th> <th>UOM</th> </tr> </thead> <tbody> <tr> <td>RC1243A0</td> <td>Ø10F-Ø10M ELBOW CONNECTION + JG END KIT</td> <td>10</td> <td>PZ</td> </tr> <tr> <td>VM1224A0</td> <td></td> <td>0.200</td> <td>M</td> </tr> </tbody> </table>	Code	Description	Qty	UOM	RC1243A0	Ø10F-Ø10M ELBOW CONNECTION + JG END KIT	10	PZ	VM1224A0		0.200	M												
					Code	Description	Qty	UOM																					
RC1243A0	Ø10F-Ø10M ELBOW CONNECTION + JG END KIT	10	PZ																										
VM1224A0		0.200	M																										
<table border="1"> <thead> <tr> <th>Code</th> <th>Description</th> <th>Qty</th> <th>UOM</th> </tr> </thead> <tbody> <tr> <td>VL1135A0</td> <td></td> <td>1</td> <td>PZ</td> </tr> <tr> <td>VM1224A0</td> <td></td> <td>0.150</td> <td>M</td> </tr> </tbody> </table>	Code	Description	Qty	UOM	VL1135A0		1	PZ	VM1224A0		0.150	M																	
Code	Description	Qty	UOM																										
VL1135A0		1	PZ																										
VM1224A0		0.150	M																										
VL1135A			KVL1135A	3/4-JG10 FITTING WITH FILTER AND VNR KIT	<table border="1"> <thead> <tr> <th>Code</th> <th>Description</th> <th>Qty</th> <th>UOM</th> </tr> </thead> <tbody> <tr> <td>VL1135A0</td> <td></td> <td>1</td> <td>PZ</td> </tr> <tr> <td>VM1224A0</td> <td></td> <td>0.150</td> <td>M</td> </tr> </tbody> </table>	Code	Description	Qty	UOM	VL1135A0		1	PZ	VM1224A0		0.150	M												
Code	Description	Qty	UOM																										
VL1135A0		1	PZ																										
VM1224A0		0.150	M																										
OH8039A	MM COMPACT REDUCER SUPPORT PLATE		OH8039A0	MM COMPACT REDUCER SUPPORT PLATE																									
TR1136A	330 °C 1 POLE SAFETY THERMOSTAT		KTR1136A	330 °C SAFETY THERMOSTAT KIT	<table border="1"> <thead> <tr> <th>Code</th> <th>Description</th> <th>Qty</th> <th>UOM</th> </tr> </thead> <tbody> <tr> <td>OH7030A0</td> <td>THERMOSTAT BULB INLET COVER</td> <td>1</td> <td>PZ</td> </tr> <tr> <td>GN1531A0</td> <td>THERMOSTAT BULB INLET SEALING</td> <td>1</td> <td>PZ</td> </tr> <tr> <td>SL1045A0</td> <td>S57 BLACK SILICONE - 80ML CARTRIDGE</td> <td>1</td> <td>PZ</td> </tr> <tr> <td>TR1136A0</td> <td>330 °C 1 POLE SAFETY THERMOSTAT</td> <td>1</td> <td>PZ</td> </tr> <tr> <td>VH1220A1</td> <td>4,2X12 TCB SELF-TAPPING SCREW</td> <td>3</td> <td>PZ</td> </tr> </tbody> </table>	Code	Description	Qty	UOM	OH7030A0	THERMOSTAT BULB INLET COVER	1	PZ	GN1531A0	THERMOSTAT BULB INLET SEALING	1	PZ	SL1045A0	S57 BLACK SILICONE - 80ML CARTRIDGE	1	PZ	TR1136A0	330 °C 1 POLE SAFETY THERMOSTAT	1	PZ	VH1220A1	4,2X12 TCB SELF-TAPPING SCREW	3	PZ
					Code	Description	Qty	UOM																					
					OH7030A0	THERMOSTAT BULB INLET COVER	1	PZ																					
					GN1531A0	THERMOSTAT BULB INLET SEALING	1	PZ																					
					SL1045A0	S57 BLACK SILICONE - 80ML CARTRIDGE	1	PZ																					
					TR1136A0	330 °C 1 POLE SAFETY THERMOSTAT	1	PZ																					
VH1220A1	4,2X12 TCB SELF-TAPPING SCREW	3	PZ																										

COMPONENT			SPARE PART																																																														
Code	Description	Image	Code	Description	Components list																																																												
RC1378A	HOSE CLAMP		KVE1135A	SERIES 5/5E VENTURI KIT	<table border="1"> <thead> <tr> <th>Code</th> <th>Description</th> <th>Qty</th> <th>UOM</th> </tr> </thead> <tbody> <tr> <td>GN1556A0</td> <td>MM VENTURI SEAL</td> <td>1</td> <td>PZ</td> </tr> <tr> <td>RC1378A0</td> <td>HOSE CLAMP</td> <td>2</td> <td>PZ</td> </tr> <tr> <td>TB1520A0</td> <td>INT. Ø=38 TH=4 DRAIN BLACK RUBBER PIPE</td> <td>0.050</td> <td>M</td> </tr> <tr> <td>VE1135A0</td> <td>220 V 50/60 HZ VENTURI ACTUATOR</td> <td>1</td> <td>PZ</td> </tr> <tr> <td>VI1032A0</td> <td>SCREW M4X16 TCB+ INOX</td> <td>1</td> <td>PZ</td> </tr> <tr> <td>VI1511A0</td> <td>STAINLESS STEEL WASHER 4.2X12X1</td> <td>2</td> <td>PZ</td> </tr> <tr> <td>VI1850A0</td> <td>M4X6 NICKEL PLATED FIXING SCRE</td> <td>2</td> <td>PZ</td> </tr> <tr> <td>VI1865A0</td> <td>5X10 TCB+ SELF-THREADI NG SCREW</td> <td>3</td> <td>PZ</td> </tr> <tr> <td>VI1965A0</td> <td></td> <td>2</td> <td>PZ</td> </tr> <tr> <td>VM1224A0</td> <td></td> <td>0.250</td> <td>M</td> </tr> <tr> <td>VM1565B0</td> <td>VENTURI LOWER COIL SUPPORT</td> <td>1</td> <td>PZ</td> </tr> <tr> <td>VM1566A0</td> <td>VENTURI UPPER COIL SUPPORT</td> <td>1</td> <td>PZ</td> </tr> <tr> <td>VM1567A0</td> <td>VENTURI LOWER BUSHING</td> <td>1</td> <td>PZ</td> </tr> <tr> <td>VM1568A0</td> <td>VENTURI PLATE SPACE</td> <td>1</td> <td>PZ</td> </tr> </tbody> </table>	Code	Description	Qty	UOM	GN1556A0	MM VENTURI SEAL	1	PZ	RC1378A0	HOSE CLAMP	2	PZ	TB1520A0	INT. Ø=38 TH=4 DRAIN BLACK RUBBER PIPE	0.050	M	VE1135A0	220 V 50/60 HZ VENTURI ACTUATOR	1	PZ	VI1032A0	SCREW M4X16 TCB+ INOX	1	PZ	VI1511A0	STAINLESS STEEL WASHER 4.2X12X1	2	PZ	VI1850A0	M4X6 NICKEL PLATED FIXING SCRE	2	PZ	VI1865A0	5X10 TCB+ SELF-THREADI NG SCREW	3	PZ	VI1965A0		2	PZ	VM1224A0		0.250	M	VM1565B0	VENTURI LOWER COIL SUPPORT	1	PZ	VM1566A0	VENTURI UPPER COIL SUPPORT	1	PZ	VM1567A0	VENTURI LOWER BUSHING	1	PZ	VM1568A0	VENTURI PLATE SPACE	1	PZ
					Code	Description	Qty	UOM																																																									
					GN1556A0	MM VENTURI SEAL	1	PZ																																																									
					RC1378A0	HOSE CLAMP	2	PZ																																																									
					TB1520A0	INT. Ø=38 TH=4 DRAIN BLACK RUBBER PIPE	0.050	M																																																									
					VE1135A0	220 V 50/60 HZ VENTURI ACTUATOR	1	PZ																																																									
					VI1032A0	SCREW M4X16 TCB+ INOX	1	PZ																																																									
					VI1511A0	STAINLESS STEEL WASHER 4.2X12X1	2	PZ																																																									
					VI1850A0	M4X6 NICKEL PLATED FIXING SCRE	2	PZ																																																									
					VI1865A0	5X10 TCB+ SELF-THREADI NG SCREW	3	PZ																																																									
					VI1965A0		2	PZ																																																									
					VM1224A0		0.250	M																																																									
					VM1565B0	VENTURI LOWER COIL SUPPORT	1	PZ																																																									
					VM1566A0	VENTURI UPPER COIL SUPPORT	1	PZ																																																									
					VM1567A0	VENTURI LOWER BUSHING	1	PZ																																																									
VM1568A0	VENTURI PLATE SPACE	1	PZ																																																														
VM2249A	COOKING CHAMBER FRONT CORNER		KVM2249A	CHAMBER FRONT PROFILE CORNER KIT	<table border="1"> <thead> <tr> <th>Code</th> <th>Description</th> <th>Qty</th> <th>UOM</th> </tr> </thead> <tbody> <tr> <td>VM1224A0</td> <td></td> <td>0.150</td> <td>M</td> </tr> <tr> <td>VM2249A0</td> <td>COOKING CHAMBER FRONT CORNER</td> <td>1</td> <td>PZ</td> </tr> </tbody> </table>	Code	Description	Qty	UOM	VM1224A0		0.150	M	VM2249A0	COOKING CHAMBER FRONT CORNER	1	PZ																																																
					Code	Description	Qty	UOM																																																									
VM1224A0		0.150	M																																																														
VM2249A0	COOKING CHAMBER FRONT CORNER	1	PZ																																																														



COMPONENT			SPARE PART																										
Code	Description	Image	Code	Description	Components list																								
VM1810A	RIGHT WATERTIGHT CAP		VM1810A0	RIGHT WATERTIGHT CAP																									
VM1811A	LEFT WATERTIGHT CAP		VM1811A0	LEFT WATERTIGHT CAP																									
VM2281A	DOOR LATCH HOLES COVER		KVM2281A	HOLE PLATE COVER KIT	<table border="1"> <thead> <tr> <th>Code</th> <th>Description</th> <th>Qty</th> <th>UOM</th> </tr> </thead> <tbody> <tr> <td>VM1224A0</td> <td></td> <td>0.200</td> <td>M</td> </tr> <tr> <td>VM2281A0</td> <td>DOOR LATCH HOLES COVER</td> <td>1</td> <td>PZ</td> </tr> </tbody> </table>	Code	Description	Qty	UOM	VM1224A0		0.200	M	VM2281A0	DOOR LATCH HOLES COVER	1	PZ												
Code	Description	Qty	UOM																										
VM1224A0		0.200	M																										
VM2281A0	DOOR LATCH HOLES COVER	1	PZ																										
VL1026A	BEND FOR DRAIN PIPE		KVL1026A	DRAIN PIPE BEND KIT	<table border="1"> <thead> <tr> <th>Code</th> <th>Description</th> <th>Qty</th> <th>UOM</th> </tr> </thead> <tbody> <tr> <td>GN1400A0</td> <td>U-TRAP SEAL</td> <td>1</td> <td>PZ</td> </tr> <tr> <td>VL1026A0</td> <td>BEND FOR DRAIN PIPE</td> <td>1</td> <td>PZ</td> </tr> <tr> <td>VM1224A0</td> <td></td> <td>0.300</td> <td>M</td> </tr> <tr> <td>VM2039A0</td> <td>DRAIN BEND FIXING RING</td> <td>1</td> <td>PZ</td> </tr> </tbody> </table>	Code	Description	Qty	UOM	GN1400A0	U-TRAP SEAL	1	PZ	VL1026A0	BEND FOR DRAIN PIPE	1	PZ	VM1224A0		0.300	M	VM2039A0	DRAIN BEND FIXING RING	1	PZ				
Code	Description	Qty	UOM																										
GN1400A0	U-TRAP SEAL	1	PZ																										
VL1026A0	BEND FOR DRAIN PIPE	1	PZ																										
VM1224A0		0.300	M																										
VM2039A0	DRAIN BEND FIXING RING	1	PZ																										
VM1505A	WALL PASSING WITH DIAPHRAGM		KVM1505A	THROUGH-WALL CONNECTION+DIAPHRAGM KIT	<table border="1"> <thead> <tr> <th>Code</th> <th>Description</th> <th>Qty</th> <th>UOM</th> </tr> </thead> <tbody> <tr> <td>V11220A1</td> <td>4,2X12 TCB SELF-TAPPING SCREW</td> <td>1</td> <td>PZ</td> </tr> <tr> <td>VM1224A0</td> <td></td> <td>0.200</td> <td>M</td> </tr> <tr> <td>VM1505A0</td> <td>WALL PASSING WITH DIAPHRAGM</td> <td>3</td> <td>PZ</td> </tr> <tr> <td>VM2055A0</td> <td>UPPER WALL PASSING ACCESSORY CABLES</td> <td>1</td> <td>PZ</td> </tr> <tr> <td>VM2056A0</td> <td>LOWER WALL PASSING ACCESSORY CABLES</td> <td>1</td> <td>PZ</td> </tr> </tbody> </table>	Code	Description	Qty	UOM	V11220A1	4,2X12 TCB SELF-TAPPING SCREW	1	PZ	VM1224A0		0.200	M	VM1505A0	WALL PASSING WITH DIAPHRAGM	3	PZ	VM2055A0	UPPER WALL PASSING ACCESSORY CABLES	1	PZ	VM2056A0	LOWER WALL PASSING ACCESSORY CABLES	1	PZ
Code	Description	Qty	UOM																										
V11220A1	4,2X12 TCB SELF-TAPPING SCREW	1	PZ																										
VM1224A0		0.200	M																										
VM1505A0	WALL PASSING WITH DIAPHRAGM	3	PZ																										
VM2055A0	UPPER WALL PASSING ACCESSORY CABLES	1	PZ																										
VM2056A0	LOWER WALL PASSING ACCESSORY CABLES	1	PZ																										



COMPONENT			SPARE PART														
Code	Description	Image	Code	Description	Components list												
VM1014A	RING MOUNTING OVEN TO THE FLOOR		KVM1014A	BRACKETS TO FIX OVEN TO FLOOR 4PCS KIT	<table border="1"> <thead> <tr> <th>Code</th> <th>Description</th> <th>Qty</th> <th>UOM</th> </tr> </thead> <tbody> <tr> <td>VM1014A0</td> <td>RING MOUNTING OVEN TO THE FLOOR</td> <td>4</td> <td>PZ</td> </tr> <tr> <td>VM1224A0</td> <td></td> <td>0.300</td> <td>M</td> </tr> </tbody> </table>	Code	Description	Qty	UOM	VM1014A0	RING MOUNTING OVEN TO THE FLOOR	4	PZ	VM1224A0		0.300	M
Code	Description	Qty	UOM														
VM1014A0	RING MOUNTING OVEN TO THE FLOOR	4	PZ														
VM1224A0		0.300	M														
TB2585A	BIG DRAIN SILICON PIPE		TB2585A0	BIG DRAIN SILICON PIPE													
VM2319A	DOOR SUPPORT PLASTIC BRACKET		KVM2319A	DOOR SUPPORT CAP KIT	<table border="1"> <thead> <tr> <th>Code</th> <th>Description</th> <th>Qty</th> <th>UOM</th> </tr> </thead> <tbody> <tr> <td>VM1224A0</td> <td></td> <td>0.300</td> <td>M</td> </tr> <tr> <td>VM2319A0</td> <td>DOOR SUPPORT PLASTIC BRACKET</td> <td>1</td> <td>PZ</td> </tr> </tbody> </table>	Code	Description	Qty	UOM	VM1224A0		0.300	M	VM2319A0	DOOR SUPPORT PLASTIC BRACKET	1	PZ
Code	Description	Qty	UOM														
VM1224A0		0.300	M														
VM2319A0	DOOR SUPPORT PLASTIC BRACKET	1	PZ														
VE1275A	STRAIN RELIEF PG 13.5		VE1275A0	STRAIN RELIEF PG 13.5													
VE1280A	NUT WITH COLLAR FOR STRAIN RELIEF PG13,5		VE1280A0	NUT WITH COLLAR FOR STRAIN RELIEF PG13,5													