

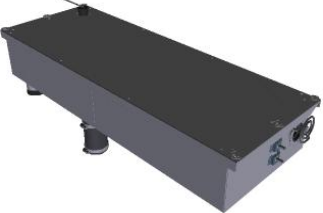

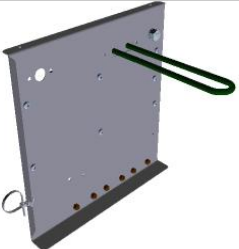



Codice assieme	Descrizione assieme	Immagine assieme
ASM2975A/0.D00	Assieme generico	
ASM2978A/0.D00	Assieme generico	
ASM2976A/0.D00	Assieme generico	
ASM2977A/0.D00	Assieme generico	
ASM1760A/0.D00	Assieme generico	

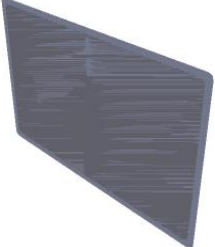
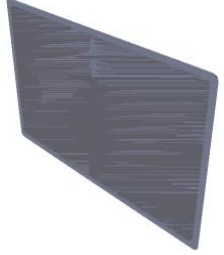

Codice assieme	Descrizione assieme	Immagine assieme
ASM1760A/0.D00	Assieme generico	
ASM4250A/0.D00	Assieme generico	
VL1121A/0.D00	ASM LAVAGGIO CAPPA EU	

**ASM2975A/0.D00 - Assieme generico**

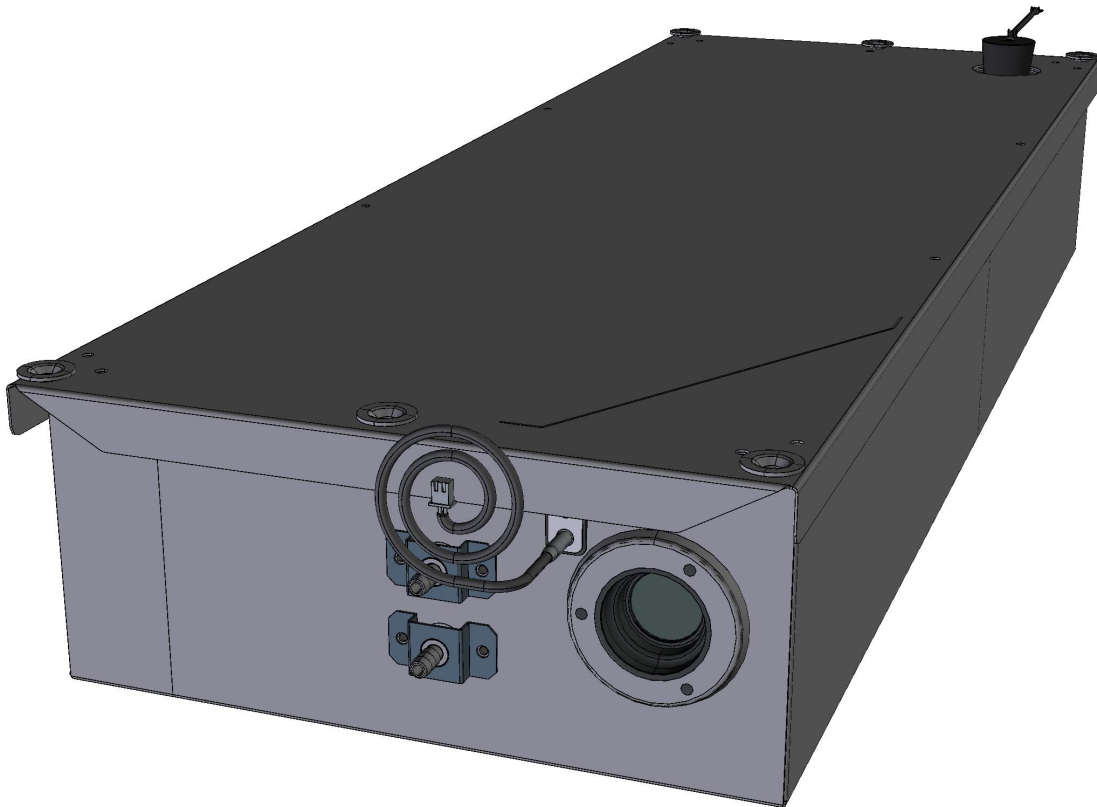

**FRONTE**





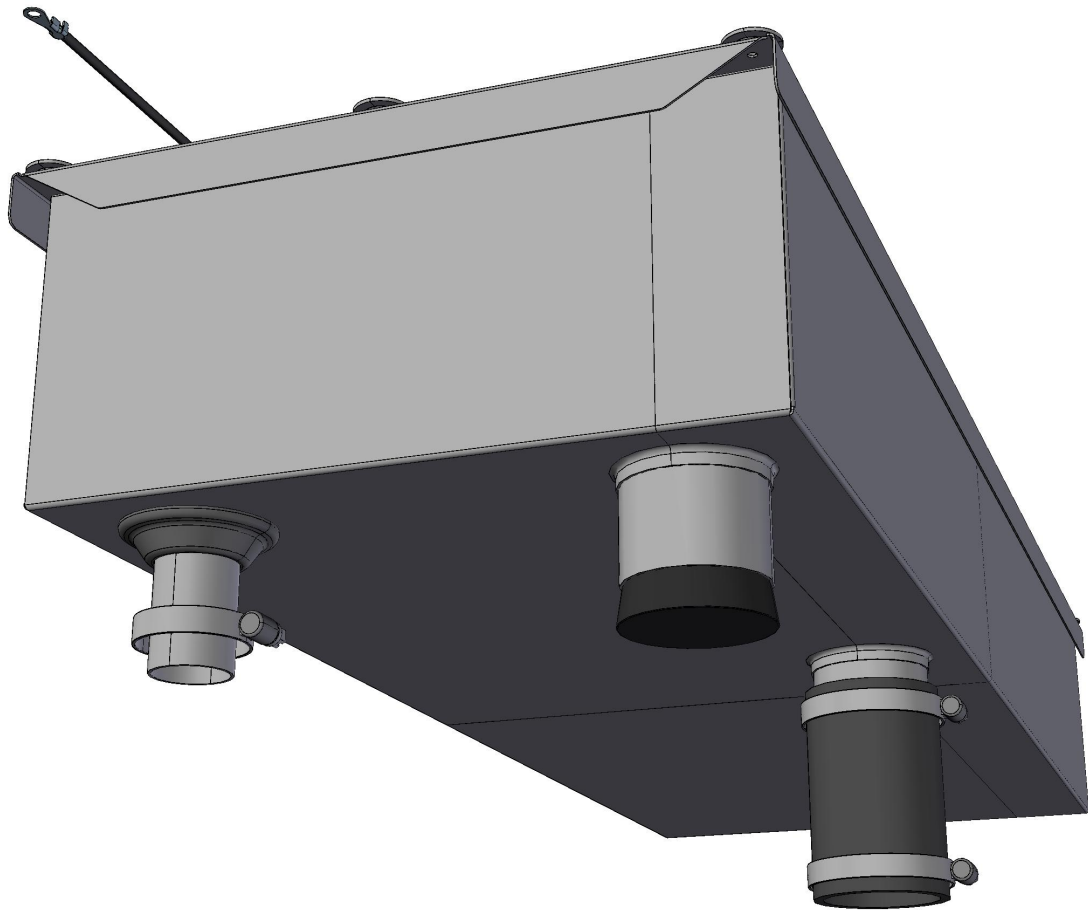

**ASM2975A/0.D00 - Assieme generico**



**RETRO**



COMPONENTE			RICAMBIO																																										
Codice	Descrizione	Immagine	Codice	Descrizione	Lista componenti																																								
TR1105A	SONDA TEMPERATURA PT100 L1000		KTR1105A	KIT SONDA TEMPERATURA PT100 L1000	<table border="1"> <thead> <tr> <th>Codice</th> <th>Descrizione</th> <th>Qtà</th> <th>UM</th> </tr> </thead> <tbody> <tr> <td>GN1120A0</td> <td>GUARNIZIONE SONDA DI TEMPERATUR A NTC</td> <td>1</td> <td>PZ</td> </tr> <tr> <td>GN1120A1</td> <td>GUARNIZIONE SONDA TEMPERATUR A NTC LM</td> <td>1</td> <td>PZ</td> </tr> <tr> <td>GN1285A0</td> <td>GUARNIZIONE SONDA DI TEMPERATUR A NTC</td> <td>1</td> <td>PZ</td> </tr> <tr> <td>SL1045A0</td> <td>SILICONE ANTRACITE S57 80 ML</td> <td>1</td> <td>PZ</td> </tr> <tr> <td>TR1105A4</td> <td>SONDA TEMPERATUR A PT100 L1000</td> <td>1</td> <td>PZ</td> </tr> <tr> <td>VI1220A1</td> <td>VITE AUTOFILETTA NTE 4.2X11 TCS+ MARUTE</td> <td>2</td> <td>PZ</td> </tr> <tr> <td>VM1464A1</td> <td>COPERCHIO SONDA TEMPERATUR A CT BT CON PA</td> <td>1</td> <td>PZ</td> </tr> <tr> <td>VM1465A1</td> <td>COPERCHIO SONDA TEMPERATUR A CT BT</td> <td>1</td> <td>PZ</td> </tr> <tr> <td>VM2052A0</td> <td>COPERCHIO SONDA TEMPERATUR A LM</td> <td>1</td> <td>PZ</td> </tr> </tbody> </table>	Codice	Descrizione	Qtà	UM	GN1120A0	GUARNIZIONE SONDA DI TEMPERATUR A NTC	1	PZ	GN1120A1	GUARNIZIONE SONDA TEMPERATUR A NTC LM	1	PZ	GN1285A0	GUARNIZIONE SONDA DI TEMPERATUR A NTC	1	PZ	SL1045A0	SILICONE ANTRACITE S57 80 ML	1	PZ	TR1105A4	SONDA TEMPERATUR A PT100 L1000	1	PZ	VI1220A1	VITE AUTOFILETTA NTE 4.2X11 TCS+ MARUTE	2	PZ	VM1464A1	COPERCHIO SONDA TEMPERATUR A CT BT CON PA	1	PZ	VM1465A1	COPERCHIO SONDA TEMPERATUR A CT BT	1	PZ	VM2052A0	COPERCHIO SONDA TEMPERATUR A LM	1	PZ
Codice	Descrizione	Qtà	UM																																										
GN1120A0	GUARNIZIONE SONDA DI TEMPERATUR A NTC	1	PZ																																										
GN1120A1	GUARNIZIONE SONDA TEMPERATUR A NTC LM	1	PZ																																										
GN1285A0	GUARNIZIONE SONDA DI TEMPERATUR A NTC	1	PZ																																										
SL1045A0	SILICONE ANTRACITE S57 80 ML	1	PZ																																										
TR1105A4	SONDA TEMPERATUR A PT100 L1000	1	PZ																																										
VI1220A1	VITE AUTOFILETTA NTE 4.2X11 TCS+ MARUTE	2	PZ																																										
VM1464A1	COPERCHIO SONDA TEMPERATUR A CT BT CON PA	1	PZ																																										
VM1465A1	COPERCHIO SONDA TEMPERATUR A CT BT	1	PZ																																										
VM2052A0	COPERCHIO SONDA TEMPERATUR A LM	1	PZ																																										
GN1120A	GUARNIZIONE SONDA DI TEMPERATURA NTC		KTR1106A	KIT SONDA TEMP. CAMERA L2000 S.5-5	<table border="1"> <thead> <tr> <th>Codice</th> <th>Descrizione</th> <th>Qtà</th> <th>UM</th> </tr> </thead> <tbody> <tr> <td>GN1285A0</td> <td>GUARNIZIONE SONDA DI TEMPERATUR A NTC</td> <td>1</td> <td>PZ</td> </tr> <tr> <td>SL1045A0</td> <td>SILICONE ANTRACITE S57 80 ML</td> <td>1</td> <td>PZ</td> </tr> <tr> <td>TR1106A3</td> <td>SONDA TEMPERATUR A PT100 L2000</td> <td>1</td> <td>PZ</td> </tr> <tr> <td>VI1220A1</td> <td>VITE AUTOFILETTA NTE 4.2X11 TCS+ MARUTE</td> <td>2</td> <td>PZ</td> </tr> <tr> <td>VM1465A0</td> <td>COPERCHIO SONDA TEMPERATUR A CHEFTOP</td> <td>1</td> <td>PZ</td> </tr> <tr> <td>VM1465A1</td> <td>COPERCHIO SONDA TEMPERATUR A CT BT</td> <td>1</td> <td>PZ</td> </tr> </tbody> </table>	Codice	Descrizione	Qtà	UM	GN1285A0	GUARNIZIONE SONDA DI TEMPERATUR A NTC	1	PZ	SL1045A0	SILICONE ANTRACITE S57 80 ML	1	PZ	TR1106A3	SONDA TEMPERATUR A PT100 L2000	1	PZ	VI1220A1	VITE AUTOFILETTA NTE 4.2X11 TCS+ MARUTE	2	PZ	VM1465A0	COPERCHIO SONDA TEMPERATUR A CHEFTOP	1	PZ	VM1465A1	COPERCHIO SONDA TEMPERATUR A CT BT	1	PZ												
Codice	Descrizione	Qtà	UM																																										
GN1285A0	GUARNIZIONE SONDA DI TEMPERATUR A NTC	1	PZ																																										
SL1045A0	SILICONE ANTRACITE S57 80 ML	1	PZ																																										
TR1106A3	SONDA TEMPERATUR A PT100 L2000	1	PZ																																										
VI1220A1	VITE AUTOFILETTA NTE 4.2X11 TCS+ MARUTE	2	PZ																																										
VM1465A0	COPERCHIO SONDA TEMPERATUR A CHEFTOP	1	PZ																																										
VM1465A1	COPERCHIO SONDA TEMPERATUR A CT BT	1	PZ																																										

COMPONENTE			RICAMBIO																																						
Codice	Descrizione	Immagine	Codice	Descrizione	Lista componenti																																				
GN1120A	GUARNIZIONE SONDA DI TEMPERATURA NTC		KTR1096A	KIT SONDA TEMPERATURA NTC 150 L=1500	<table border="1"> <thead> <tr> <th>Codice</th> <th>Descrizione</th> <th>Qtà</th> <th>UM</th> </tr> </thead> <tbody> <tr> <td>GN1120A0</td> <td>GUARNIZIONE SONDA DI TEMPERATUR A NTC</td> <td>1</td> <td>PZ</td> </tr> <tr> <td>GN1120A1</td> <td>GUARNIZIONE SONDA TEMPERATUR A NTC LM</td> <td>1</td> <td>PZ</td> </tr> <tr> <td>GN1285A0</td> <td>GUARNIZIONE SONDA DI TEMPERATUR A NTC</td> <td>2</td> <td>PZ</td> </tr> <tr> <td>SL1045A0</td> <td>SILICONE ANTRACITE S57 80 ML</td> <td>1</td> <td>PZ</td> </tr> <tr> <td>TR1096A0</td> <td>SONDA TEMPERATUR A NTC 150 L=1500</td> <td>1</td> <td>PZ</td> </tr> <tr> <td>VI1220A1</td> <td>VITE AUTOFILETTA NTE 4.2X11 TCS+ MARUTE</td> <td>2</td> <td>PZ</td> </tr> <tr> <td>VM1465A0</td> <td>COPERCHIO SONDA TEMPERATUR A CHEFTOP</td> <td>1</td> <td>PZ</td> </tr> <tr> <td>VM1465A1</td> <td>COPERCHIO SONDA TEMPERATUR A CT BT</td> <td>1</td> <td>PZ</td> </tr> </tbody> </table>	Codice	Descrizione	Qtà	UM	GN1120A0	GUARNIZIONE SONDA DI TEMPERATUR A NTC	1	PZ	GN1120A1	GUARNIZIONE SONDA TEMPERATUR A NTC LM	1	PZ	GN1285A0	GUARNIZIONE SONDA DI TEMPERATUR A NTC	2	PZ	SL1045A0	SILICONE ANTRACITE S57 80 ML	1	PZ	TR1096A0	SONDA TEMPERATUR A NTC 150 L=1500	1	PZ	VI1220A1	VITE AUTOFILETTA NTE 4.2X11 TCS+ MARUTE	2	PZ	VM1465A0	COPERCHIO SONDA TEMPERATUR A CHEFTOP	1	PZ	VM1465A1	COPERCHIO SONDA TEMPERATUR A CT BT	1	PZ
			Codice	Descrizione	Qtà	UM																																			
GN1120A0	GUARNIZIONE SONDA DI TEMPERATUR A NTC	1	PZ																																						
GN1120A1	GUARNIZIONE SONDA TEMPERATUR A NTC LM	1	PZ																																						
GN1285A0	GUARNIZIONE SONDA DI TEMPERATUR A NTC	2	PZ																																						
SL1045A0	SILICONE ANTRACITE S57 80 ML	1	PZ																																						
TR1096A0	SONDA TEMPERATUR A NTC 150 L=1500	1	PZ																																						
VI1220A1	VITE AUTOFILETTA NTE 4.2X11 TCS+ MARUTE	2	PZ																																						
VM1465A0	COPERCHIO SONDA TEMPERATUR A CHEFTOP	1	PZ																																						
VM1465A1	COPERCHIO SONDA TEMPERATUR A CT BT	1	PZ																																						
KTR1095A	KIT SONDA TEMPERATURA NTC 150 L=1050	<table border="1"> <thead> <tr> <th>Codice</th> <th>Descrizione</th> <th>Qtà</th> <th>UM</th> </tr> </thead> <tbody> <tr> <td>GN1120A0</td> <td>GUARNIZIONE SONDA DI TEMPERATUR A NTC</td> <td>1</td> <td>PZ</td> </tr> <tr> <td>GN1120A1</td> <td>GUARNIZIONE SONDA TEMPERATUR A NTC LM</td> <td>1</td> <td>PZ</td> </tr> <tr> <td>GN1285A0</td> <td>GUARNIZIONE SONDA DI TEMPERATUR A NTC</td> <td>1</td> <td>PZ</td> </tr> <tr> <td>SL1045A0</td> <td>SILICONE ANTRACITE S57 80 ML</td> <td>1</td> <td>PZ</td> </tr> <tr> <td>TR1095A0</td> <td>SONDA TEMPERATUR A NTC 150 L=1050</td> <td>1</td> <td>PZ</td> </tr> </tbody> </table>	Codice	Descrizione	Qtà	UM	GN1120A0	GUARNIZIONE SONDA DI TEMPERATUR A NTC	1	PZ	GN1120A1	GUARNIZIONE SONDA TEMPERATUR A NTC LM	1	PZ	GN1285A0	GUARNIZIONE SONDA DI TEMPERATUR A NTC	1	PZ	SL1045A0	SILICONE ANTRACITE S57 80 ML	1	PZ	TR1095A0	SONDA TEMPERATUR A NTC 150 L=1050	1	PZ															
Codice	Descrizione	Qtà	UM																																						
GN1120A0	GUARNIZIONE SONDA DI TEMPERATUR A NTC	1	PZ																																						
GN1120A1	GUARNIZIONE SONDA TEMPERATUR A NTC LM	1	PZ																																						
GN1285A0	GUARNIZIONE SONDA DI TEMPERATUR A NTC	1	PZ																																						
SL1045A0	SILICONE ANTRACITE S57 80 ML	1	PZ																																						
TR1095A0	SONDA TEMPERATUR A NTC 150 L=1050	1	PZ																																						

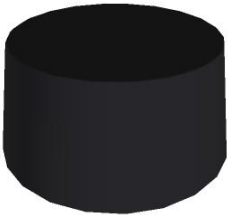
COMPONENTE			RICAMBIO																														
Codice	Descrizione	Immagine	Codice	Descrizione	Lista componenti																												
GN1120A	GUARNIZIONE SONDA DI TEMPERATURA NTC		KTR1095A	KIT SONDA TEMPERATURA NTC 150 L=1050	<table border="1"> <thead> <tr> <th>Codice</th> <th>Descrizione</th> <th>Qtà</th> <th>UM</th> </tr> </thead> <tbody> <tr> <td>VI1220A1</td> <td>VITE AUTOFILETTA NTE 4.2X11 TCS+ MARUTE</td> <td>2</td> <td>PZ</td> </tr> <tr> <td>VM1465A0</td> <td>COPERCHIO SONDA TEMPERATUR A CHEFTOP</td> <td>1</td> <td>PZ</td> </tr> <tr> <td>VM1465A1</td> <td>COPERCHIO SONDA TEMPERATUR A CT BT</td> <td>1</td> <td>PZ</td> </tr> </tbody> </table>	Codice	Descrizione	Qtà	UM	VI1220A1	VITE AUTOFILETTA NTE 4.2X11 TCS+ MARUTE	2	PZ	VM1465A0	COPERCHIO SONDA TEMPERATUR A CHEFTOP	1	PZ	VM1465A1	COPERCHIO SONDA TEMPERATUR A CT BT	1	PZ												
Codice	Descrizione	Qtà	UM																														
VI1220A1	VITE AUTOFILETTA NTE 4.2X11 TCS+ MARUTE	2	PZ																														
VM1465A0	COPERCHIO SONDA TEMPERATUR A CHEFTOP	1	PZ																														
VM1465A1	COPERCHIO SONDA TEMPERATUR A CT BT	1	PZ																														
TR1002A	SONDA TEMPERATURA UL PT100 L1000		KTR1002A	KIT SONDA TEMPERATURA UL PT100 L1000	<table border="1"> <thead> <tr> <th>Codice</th> <th>Descrizione</th> <th>Qtà</th> <th>UM</th> </tr> </thead> <tbody> <tr> <td>GN1285A0</td> <td>GUARNIZIONE SONDA DI TEMPERATUR A NTC</td> <td>2</td> <td>PZ</td> </tr> <tr> <td>SL1045A0</td> <td>SILICONE ANTRACITE S57 80 ML</td> <td>1</td> <td>PZ</td> </tr> <tr> <td>TR1002A1</td> <td>SONDA TEMPERATUR A UL PT100 L1000</td> <td>1</td> <td>PZ</td> </tr> <tr> <td>VI1220A1</td> <td>VITE AUTOFILETTA NTE 4.2X11 TCS+ MARUTE</td> <td>2</td> <td>PZ</td> </tr> <tr> <td>VM1465A0</td> <td>COPERCHIO SONDA TEMPERATUR A CHEFTOP</td> <td>1</td> <td>PZ</td> </tr> <tr> <td>VM1465A1</td> <td>COPERCHIO SONDA TEMPERATUR A CT BT</td> <td>1</td> <td>PZ</td> </tr> </tbody> </table>	Codice	Descrizione	Qtà	UM	GN1285A0	GUARNIZIONE SONDA DI TEMPERATUR A NTC	2	PZ	SL1045A0	SILICONE ANTRACITE S57 80 ML	1	PZ	TR1002A1	SONDA TEMPERATUR A UL PT100 L1000	1	PZ	VI1220A1	VITE AUTOFILETTA NTE 4.2X11 TCS+ MARUTE	2	PZ	VM1465A0	COPERCHIO SONDA TEMPERATUR A CHEFTOP	1	PZ	VM1465A1	COPERCHIO SONDA TEMPERATUR A CT BT	1	PZ
Codice	Descrizione	Qtà	UM																														
GN1285A0	GUARNIZIONE SONDA DI TEMPERATUR A NTC	2	PZ																														
SL1045A0	SILICONE ANTRACITE S57 80 ML	1	PZ																														
TR1002A1	SONDA TEMPERATUR A UL PT100 L1000	1	PZ																														
VI1220A1	VITE AUTOFILETTA NTE 4.2X11 TCS+ MARUTE	2	PZ																														
VM1465A0	COPERCHIO SONDA TEMPERATUR A CHEFTOP	1	PZ																														
VM1465A1	COPERCHIO SONDA TEMPERATUR A CT BT	1	PZ																														
0H3790A	LAMIERA TENUTA CAMINO		0H3790A0	LAMIERA TENUTA CAMINO																													

COMPONENTE			RICAMBIO																		
Codice	Descrizione	Immagine	Codice	Descrizione	Lista componenti																
GN1275A	GUARNIZIONE CAMINO SILICONE NERO XVC		KGN1275A	KIT GUARNIZIONE CAMINO SILICONE NERO 4PZ	<table border="1"> <thead> <tr> <th>Codice</th> <th>Descrizione</th> <th>Qtà</th> <th>UM</th> </tr> </thead> <tbody> <tr> <td>GN1275A0</td> <td>GUARNIZIONE CAMINO SILICONE NERO XVC</td> <td>4</td> <td>PZ</td> </tr> <tr> <td>VM1224A0</td> <td>TUBOLARE TERMORETR 65MY 220MM 2 COLORI</td> <td>0.200</td> <td>M</td> </tr> </tbody> </table>	Codice	Descrizione	Qtà	UM	GN1275A0	GUARNIZIONE CAMINO SILICONE NERO XVC	4	PZ	VM1224A0	TUBOLARE TERMORETR 65MY 220MM 2 COLORI	0.200	M				
Codice	Descrizione	Qtà	UM																		
GN1275A0	GUARNIZIONE CAMINO SILICONE NERO XVC	4	PZ																		
VM1224A0	TUBOLARE TERMORETR 65MY 220MM 2 COLORI	0.200	M																		
VM2317A	TRONCHETTO CONICO CHIUSURA TUBO D50		VM2317A0	TRONCHETTO CONICO CHIUSURA TUBO D50																	
IE1391A	FILO FISSAGGIO TAPPO CARRELLI BI		KIE1391A	KIT FILO FISS TAPPO CARRELLI BIG 100 PZ	<table border="1"> <thead> <tr> <th>Codice</th> <th>Descrizione</th> <th>Qtà</th> <th>UM</th> </tr> </thead> <tbody> <tr> <td>CE1016A0</td> <td>TERMINALE AD OCCHIELLO D=4,3 MM</td> <td>200</td> <td>PZ</td> </tr> <tr> <td>CE1630A1</td> <td>CAVO UNIP AWG16 ST.3135 NERO</td> <td>15</td> <td>M</td> </tr> <tr> <td>VM1224A0</td> <td>TUBOLARE TERMORETR 65MY 220MM 2 COLORI</td> <td>0.250</td> <td>M</td> </tr> </tbody> </table>	Codice	Descrizione	Qtà	UM	CE1016A0	TERMINALE AD OCCHIELLO D=4,3 MM	200	PZ	CE1630A1	CAVO UNIP AWG16 ST.3135 NERO	15	M	VM1224A0	TUBOLARE TERMORETR 65MY 220MM 2 COLORI	0.250	M
Codice	Descrizione	Qtà	UM																		
CE1016A0	TERMINALE AD OCCHIELLO D=4,3 MM	200	PZ																		
CE1630A1	CAVO UNIP AWG16 ST.3135 NERO	15	M																		
VM1224A0	TUBOLARE TERMORETR 65MY 220MM 2 COLORI	0.250	M																		
RC1055A	FASCETTA STRINGI TUBO Ø25-40 H12 INOX		KRC1055A	KIT 10PZ FASCETTA STRINGI TUBO Ø25-40	<table border="1"> <thead> <tr> <th>Codice</th> <th>Descrizione</th> <th>Qtà</th> <th>UM</th> </tr> </thead> <tbody> <tr> <td>RC1055A0</td> <td>FASCETTA STRINGI TUBO Ø25-40 H12 INOX</td> <td>10</td> <td>PZ</td> </tr> <tr> <td>VM1224A0</td> <td>TUBOLARE TERMORETR 65MY 220MM 2 COLORI</td> <td>0.250</td> <td>M</td> </tr> </tbody> </table>	Codice	Descrizione	Qtà	UM	RC1055A0	FASCETTA STRINGI TUBO Ø25-40 H12 INOX	10	PZ	VM1224A0	TUBOLARE TERMORETR 65MY 220MM 2 COLORI	0.250	M				
Codice	Descrizione	Qtà	UM																		
RC1055A0	FASCETTA STRINGI TUBO Ø25-40 H12 INOX	10	PZ																		
VM1224A0	TUBOLARE TERMORETR 65MY 220MM 2 COLORI	0.250	M																		
RC1391A	FASCETTA STRINGI TUBO D60 H12 INOX		RC1391A0	FASCETTA STRINGI TUBO D60 H12 INOX																	



COMPONENTE			RICAMBIO																																																		
Codice	Descrizione	Immagine	Codice	Descrizione	Lista componenti																																																
TB2992A	TB2993A0-SIL D. INT. 50 CAPPE 0,10M		KTB2992A	KIT TUBO SILICONE D. INT. 50 TB2992A0	<table border="1"> <thead> <tr> <th>Codice</th> <th>Descrizione</th> <th>Qtà</th> <th>UM</th> </tr> </thead> <tbody> <tr> <td>TB2993A0</td> <td>TUBO DI-50 SP-4 SILICONE GRIGIO</td> <td>0.100</td> <td>M</td> </tr> </tbody> </table>	Codice	Descrizione	Qtà	UM	TB2993A0	TUBO DI-50 SP-4 SILICONE GRIGIO	0.100	M																																								
Codice	Descrizione	Qtà	UM																																																		
TB2993A0	TUBO DI-50 SP-4 SILICONE GRIGIO	0.100	M																																																		
UG1004A	UGELLO ACQUA 1/8" XC415-515-625		KUG1004A	KIT UGELLO ACQUA 1/8" XC415-515-625	<table border="1"> <thead> <tr> <th>Codice</th> <th>Descrizione</th> <th>Qtà</th> <th>UM</th> </tr> </thead> <tbody> <tr> <td>UG1004A0</td> <td>UGELLO ACQUA 1/8" XC415-515-625</td> <td>1</td> <td>PZ</td> </tr> <tr> <td>VM1224A0</td> <td>TUBOLARE TERMORETR 65MY 220MM 2 COLORI</td> <td>0.150</td> <td>M</td> </tr> </tbody> </table>	Codice	Descrizione	Qtà	UM	UG1004A0	UGELLO ACQUA 1/8" XC415-515-625	1	PZ	VM1224A0	TUBOLARE TERMORETR 65MY 220MM 2 COLORI	0.150	M																																				
Codice	Descrizione	Qtà	UM																																																		
UG1004A0	UGELLO ACQUA 1/8" XC415-515-625	1	PZ																																																		
VM1224A0	TUBOLARE TERMORETR 65MY 220MM 2 COLORI	0.150	M																																																		
0H2425C	STAFFETTA SUPPORTO UGELL		K0H2425C	KIT CONDENSATORE VAPORE	<table border="1"> <thead> <tr> <th>Codice</th> <th>Descrizione</th> <th>Qtà</th> <th>UM</th> </tr> </thead> <tbody> <tr> <td>0H2425C0</td> <td>STAFFETTA SUPPORTO UGELLO</td> <td>1</td> <td>PZ</td> </tr> <tr> <td>0H2760A0</td> <td>TUBO DI SCARICO CONDENSATO RE Ø30X1</td> <td>1</td> <td>PZ</td> </tr> <tr> <td>0H2765A0</td> <td>TUBO DI INGRESSO FUMI COND. Ø30X1</td> <td>2</td> <td>PZ</td> </tr> <tr> <td>0H4600B0</td> <td>SCATOLA CONDENSATO RE XC315</td> <td>1</td> <td>PZ</td> </tr> <tr> <td>0H4605A0</td> <td>COPERCHIO COND.DX CAPP A XC315</td> <td>1</td> <td>PZ</td> </tr> <tr> <td>0H4610A0</td> <td>PARATIA COND.DX CAPP A XC315</td> <td>1</td> <td>PZ</td> </tr> <tr> <td>BR1205B0</td> <td>UGELLO CONDENSATO RE CORPO UNICO</td> <td>1</td> <td>PZ</td> </tr> <tr> <td>RC1286A0</td> <td>RACCORDO A GOMITO CON CODOLO D=8-D=1/8GA</td> <td>1</td> <td>PZ</td> </tr> <tr> <td>TR1105A4</td> <td>SONDA TEMPERATUR A PT100 L1000</td> <td>1</td> <td>PZ</td> </tr> <tr> <td>VH1220A1</td> <td>VITE AUTOFILETTA NTE 4.2X11 TCS+ MARUTE</td> <td>2</td> <td>PZ</td> </tr> <tr> <td>VI1225A0</td> <td>RIVETTO STRUTT. 4X8 INOX</td> <td>12</td> <td>PZ</td> </tr> </tbody> </table>	Codice	Descrizione	Qtà	UM	0H2425C0	STAFFETTA SUPPORTO UGELLO	1	PZ	0H2760A0	TUBO DI SCARICO CONDENSATO RE Ø30X1	1	PZ	0H2765A0	TUBO DI INGRESSO FUMI COND. Ø30X1	2	PZ	0H4600B0	SCATOLA CONDENSATO RE XC315	1	PZ	0H4605A0	COPERCHIO COND.DX CAPP A XC315	1	PZ	0H4610A0	PARATIA COND.DX CAPP A XC315	1	PZ	BR1205B0	UGELLO CONDENSATO RE CORPO UNICO	1	PZ	RC1286A0	RACCORDO A GOMITO CON CODOLO D=8-D=1/8GA	1	PZ	TR1105A4	SONDA TEMPERATUR A PT100 L1000	1	PZ	VH1220A1	VITE AUTOFILETTA NTE 4.2X11 TCS+ MARUTE	2	PZ	VI1225A0	RIVETTO STRUTT. 4X8 INOX	12	PZ
Codice	Descrizione	Qtà	UM																																																		
0H2425C0	STAFFETTA SUPPORTO UGELLO	1	PZ																																																		
0H2760A0	TUBO DI SCARICO CONDENSATO RE Ø30X1	1	PZ																																																		
0H2765A0	TUBO DI INGRESSO FUMI COND. Ø30X1	2	PZ																																																		
0H4600B0	SCATOLA CONDENSATO RE XC315	1	PZ																																																		
0H4605A0	COPERCHIO COND.DX CAPP A XC315	1	PZ																																																		
0H4610A0	PARATIA COND.DX CAPP A XC315	1	PZ																																																		
BR1205B0	UGELLO CONDENSATO RE CORPO UNICO	1	PZ																																																		
RC1286A0	RACCORDO A GOMITO CON CODOLO D=8-D=1/8GA	1	PZ																																																		
TR1105A4	SONDA TEMPERATUR A PT100 L1000	1	PZ																																																		
VH1220A1	VITE AUTOFILETTA NTE 4.2X11 TCS+ MARUTE	2	PZ																																																		
VI1225A0	RIVETTO STRUTT. 4X8 INOX	12	PZ																																																		

COMPONENTE			RICAMBIO																																														
Codice	Descrizione	Immagine	Codice	Descrizione	Lista componenti																																												
RC1409A	RACCORDO UGELLO-PORTAGO MMA CAPP		KRC1409A	KIT RACCORDO E UGELLO CAPP	<table border="1"> <thead> <tr> <th>Codice</th> <th>Descrizione</th> <th>Qtà</th> <th>UM</th> </tr> </thead> <tbody> <tr> <td>0H2425C0</td> <td>STAFFETTA SUPPORTO UGELLO</td> <td>1</td> <td>PZ</td> </tr> <tr> <td>RC1019A0</td> <td>FASCETTA ELASTICA D10 ZINCATA</td> <td>3</td> <td>PZ</td> </tr> <tr> <td>RC1409A1</td> <td>RACCORDO UGELLO-POR TAGOMMA CAPP</td> <td>1</td> <td>PZ</td> </tr> <tr> <td>UG1004A0</td> <td>UGELLO ACQUA 1/8" XC415-515-625</td> <td>1</td> <td>PZ</td> </tr> <tr> <td>VI1220A1</td> <td>VITE AUTOFILLET NTE 4.2X11 TCS+ MARUTE</td> <td>2</td> <td>PZ</td> </tr> <tr> <td>VM1224A0</td> <td>TUBOLARE TERMORETR 65MY 220MM 2 COLORI</td> <td>0.200</td> <td>M</td> </tr> </tbody> </table>	Codice	Descrizione	Qtà	UM	0H2425C0	STAFFETTA SUPPORTO UGELLO	1	PZ	RC1019A0	FASCETTA ELASTICA D10 ZINCATA	3	PZ	RC1409A1	RACCORDO UGELLO-POR TAGOMMA CAPP	1	PZ	UG1004A0	UGELLO ACQUA 1/8" XC415-515-625	1	PZ	VI1220A1	VITE AUTOFILLET NTE 4.2X11 TCS+ MARUTE	2	PZ	VM1224A0	TUBOLARE TERMORETR 65MY 220MM 2 COLORI	0.200	M																
Codice	Descrizione	Qtà	UM																																														
0H2425C0	STAFFETTA SUPPORTO UGELLO	1	PZ																																														
RC1019A0	FASCETTA ELASTICA D10 ZINCATA	3	PZ																																														
RC1409A1	RACCORDO UGELLO-POR TAGOMMA CAPP	1	PZ																																														
UG1004A0	UGELLO ACQUA 1/8" XC415-515-625	1	PZ																																														
VI1220A1	VITE AUTOFILLET NTE 4.2X11 TCS+ MARUTE	2	PZ																																														
VM1224A0	TUBOLARE TERMORETR 65MY 220MM 2 COLORI	0.200	M																																														
0H7178B	SCATOLA CONDENSATORE CAPP BAKERTOP		K0H2012A	KIT CONDENSATORE CAPP BAKERTOP MM	<table border="1"> <thead> <tr> <th>Codice</th> <th>Descrizione</th> <th>Qtà</th> <th>UM</th> </tr> </thead> <tbody> <tr> <td>0H2425C0</td> <td>STAFFETTA SUPPORTO UGELLO</td> <td>2</td> <td>PZ</td> </tr> <tr> <td>0H2760A0</td> <td>TUBO DI SCARICO CONDENSATO RE Ø30X1</td> <td>1</td> <td>PZ</td> </tr> <tr> <td>0H7178B0</td> <td>SCATOLA CONDENSATO RE CAPP BAKERTOP</td> <td>1</td> <td>PZ</td> </tr> <tr> <td>0H7179A0</td> <td>COPERCHIO CONDENSATO RE CAPP BAKERTOP</td> <td>1</td> <td>PZ</td> </tr> <tr> <td>0H7180A0</td> <td>PARATIA POSTERIORE CAPP</td> <td>1</td> <td>PZ</td> </tr> <tr> <td>0H7181A0</td> <td>PARATIA INTERMEDIA CAPP</td> <td>1</td> <td>PZ</td> </tr> <tr> <td>0H7182A0</td> <td>PARATIA FRONTALE CAPP</td> <td>1</td> <td>PZ</td> </tr> <tr> <td>0H7390A0</td> <td>PROFILO GUIDA TEGLIA</td> <td>1</td> <td>PZ</td> </tr> <tr> <td>CE1016A0</td> <td>TERMINALE AD OCCHIELLO D=4,3 MM</td> <td>2</td> <td>PZ</td> </tr> <tr> <td>CE1630A1</td> <td>CAVO UNIP AWG16 ST.3135 NERO</td> <td>0.150</td> <td>M</td> </tr> </tbody> </table>	Codice	Descrizione	Qtà	UM	0H2425C0	STAFFETTA SUPPORTO UGELLO	2	PZ	0H2760A0	TUBO DI SCARICO CONDENSATO RE Ø30X1	1	PZ	0H7178B0	SCATOLA CONDENSATO RE CAPP BAKERTOP	1	PZ	0H7179A0	COPERCHIO CONDENSATO RE CAPP BAKERTOP	1	PZ	0H7180A0	PARATIA POSTERIORE CAPP	1	PZ	0H7181A0	PARATIA INTERMEDIA CAPP	1	PZ	0H7182A0	PARATIA FRONTALE CAPP	1	PZ	0H7390A0	PROFILO GUIDA TEGLIA	1	PZ	CE1016A0	TERMINALE AD OCCHIELLO D=4,3 MM	2	PZ	CE1630A1	CAVO UNIP AWG16 ST.3135 NERO	0.150	M
Codice	Descrizione	Qtà	UM																																														
0H2425C0	STAFFETTA SUPPORTO UGELLO	2	PZ																																														
0H2760A0	TUBO DI SCARICO CONDENSATO RE Ø30X1	1	PZ																																														
0H7178B0	SCATOLA CONDENSATO RE CAPP BAKERTOP	1	PZ																																														
0H7179A0	COPERCHIO CONDENSATO RE CAPP BAKERTOP	1	PZ																																														
0H7180A0	PARATIA POSTERIORE CAPP	1	PZ																																														
0H7181A0	PARATIA INTERMEDIA CAPP	1	PZ																																														
0H7182A0	PARATIA FRONTALE CAPP	1	PZ																																														
0H7390A0	PROFILO GUIDA TEGLIA	1	PZ																																														
CE1016A0	TERMINALE AD OCCHIELLO D=4,3 MM	2	PZ																																														
CE1630A1	CAVO UNIP AWG16 ST.3135 NERO	0.150	M																																														

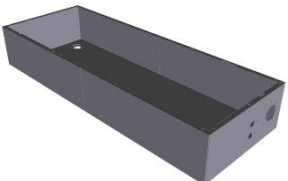
COMPONENTE			RICAMBIO																																																																		
Codice	Descrizione	Immagine	Codice	Descrizione	Lista componenti																																																																
0H7178B	SCATOLA CONDENSATORE CAPPA BAKERTOP		K0H2012A	KIT CONDENSATORE CAPPA BAKERTOP MM	<table border="1"> <thead> <tr> <th>Codice</th> <th>Descrizione</th> <th>Qtà</th> <th>UM</th> </tr> </thead> <tbody> <tr> <td>GN1120A1</td> <td>GUARNIZIONE SONDA TEMPERATUR A NTC LM</td> <td>1</td> <td>PZ</td> </tr> <tr> <td>GN1275A0</td> <td>GUARNIZIONE CAMINO SILICONE NERO XVC</td> <td>1</td> <td>PZ</td> </tr> <tr> <td>RC1055A0</td> <td>FASCETTA STRINGI TUBO Ø25-40 H12 INOX</td> <td>1</td> <td>PZ</td> </tr> <tr> <td>RC1391A0</td> <td>FASCETTA STRINGI TUBO D60 H12 INOX</td> <td>2</td> <td>PZ</td> </tr> <tr> <td>RC1409A1</td> <td>RACCORDO UGELLO-POR TAGOMMA CAPPA</td> <td>2</td> <td>PZ</td> </tr> <tr> <td>TB2896A0</td> <td>TUBO CONDENSATO RE D-EST50</td> <td>2</td> <td>PZ</td> </tr> <tr> <td>TB2993A0</td> <td>TUBO DI-50 SP-4 SILICONE GRIGIO</td> <td>0.100</td> <td>M</td> </tr> <tr> <td>TR1105A4</td> <td>SONDA TEMPERATUR A PT100 L1000</td> <td>1</td> <td>PZ</td> </tr> <tr> <td>UG1004A0</td> <td>UGELLO ACQUA 1/8" XC415-515-625</td> <td>1</td> <td>PZ</td> </tr> <tr> <td>VI1060A0</td> <td>ROND. 6X20X1,5 INOX A2 IMBUTITA</td> <td>6</td> <td>PZ</td> </tr> <tr> <td>VI1220A1</td> <td>VITE AUTOFILETTA NTE 4.2X11 TCS+ MARUTE</td> <td>14</td> <td>PZ</td> </tr> <tr> <td>VI1225A0</td> <td>RIVETTO STRUTT. 4X8 INOX</td> <td>14</td> <td>PZ</td> </tr> <tr> <td>VM1120A0</td> <td>TRONCHETTO CONICO NERO CHIUSURA TUBO D30</td> <td>1</td> <td>PZ</td> </tr> <tr> <td>VM2085A0</td> <td>ANELLO COVER SILICONE CAPPE</td> <td>1</td> <td>PZ</td> </tr> <tr> <td>VM2317A0</td> <td>TRONCHETTO CONICO CHIUSURA TUBO D50</td> <td>1</td> <td>PZ</td> </tr> </tbody> </table>	Codice	Descrizione	Qtà	UM	GN1120A1	GUARNIZIONE SONDA TEMPERATUR A NTC LM	1	PZ	GN1275A0	GUARNIZIONE CAMINO SILICONE NERO XVC	1	PZ	RC1055A0	FASCETTA STRINGI TUBO Ø25-40 H12 INOX	1	PZ	RC1391A0	FASCETTA STRINGI TUBO D60 H12 INOX	2	PZ	RC1409A1	RACCORDO UGELLO-POR TAGOMMA CAPPA	2	PZ	TB2896A0	TUBO CONDENSATO RE D-EST50	2	PZ	TB2993A0	TUBO DI-50 SP-4 SILICONE GRIGIO	0.100	M	TR1105A4	SONDA TEMPERATUR A PT100 L1000	1	PZ	UG1004A0	UGELLO ACQUA 1/8" XC415-515-625	1	PZ	VI1060A0	ROND. 6X20X1,5 INOX A2 IMBUTITA	6	PZ	VI1220A1	VITE AUTOFILETTA NTE 4.2X11 TCS+ MARUTE	14	PZ	VI1225A0	RIVETTO STRUTT. 4X8 INOX	14	PZ	VM1120A0	TRONCHETTO CONICO NERO CHIUSURA TUBO D30	1	PZ	VM2085A0	ANELLO COVER SILICONE CAPPE	1	PZ	VM2317A0	TRONCHETTO CONICO CHIUSURA TUBO D50	1	PZ
Codice	Descrizione	Qtà	UM																																																																		
GN1120A1	GUARNIZIONE SONDA TEMPERATUR A NTC LM	1	PZ																																																																		
GN1275A0	GUARNIZIONE CAMINO SILICONE NERO XVC	1	PZ																																																																		
RC1055A0	FASCETTA STRINGI TUBO Ø25-40 H12 INOX	1	PZ																																																																		
RC1391A0	FASCETTA STRINGI TUBO D60 H12 INOX	2	PZ																																																																		
RC1409A1	RACCORDO UGELLO-POR TAGOMMA CAPPA	2	PZ																																																																		
TB2896A0	TUBO CONDENSATO RE D-EST50	2	PZ																																																																		
TB2993A0	TUBO DI-50 SP-4 SILICONE GRIGIO	0.100	M																																																																		
TR1105A4	SONDA TEMPERATUR A PT100 L1000	1	PZ																																																																		
UG1004A0	UGELLO ACQUA 1/8" XC415-515-625	1	PZ																																																																		
VI1060A0	ROND. 6X20X1,5 INOX A2 IMBUTITA	6	PZ																																																																		
VI1220A1	VITE AUTOFILETTA NTE 4.2X11 TCS+ MARUTE	14	PZ																																																																		
VI1225A0	RIVETTO STRUTT. 4X8 INOX	14	PZ																																																																		
VM1120A0	TRONCHETTO CONICO NERO CHIUSURA TUBO D30	1	PZ																																																																		
VM2085A0	ANELLO COVER SILICONE CAPPE	1	PZ																																																																		
VM2317A0	TRONCHETTO CONICO CHIUSURA TUBO D50	1	PZ																																																																		



COMPONENTE			RICAMBIO		
<i>Codice</i>	<i>Descrizione</i>	<i>Immagine</i>	<i>Codice</i>	<i>Descrizione</i>	<i>Lista componenti</i>
VM1120A	TRONCHETTO CONICO NERO CHIUSURA TUBO D3		VM1120A0	TRONCHETTO CONICO NERO CHIUSURA TUBO D3	

ASM2978A/0.D00 - Assieme generico



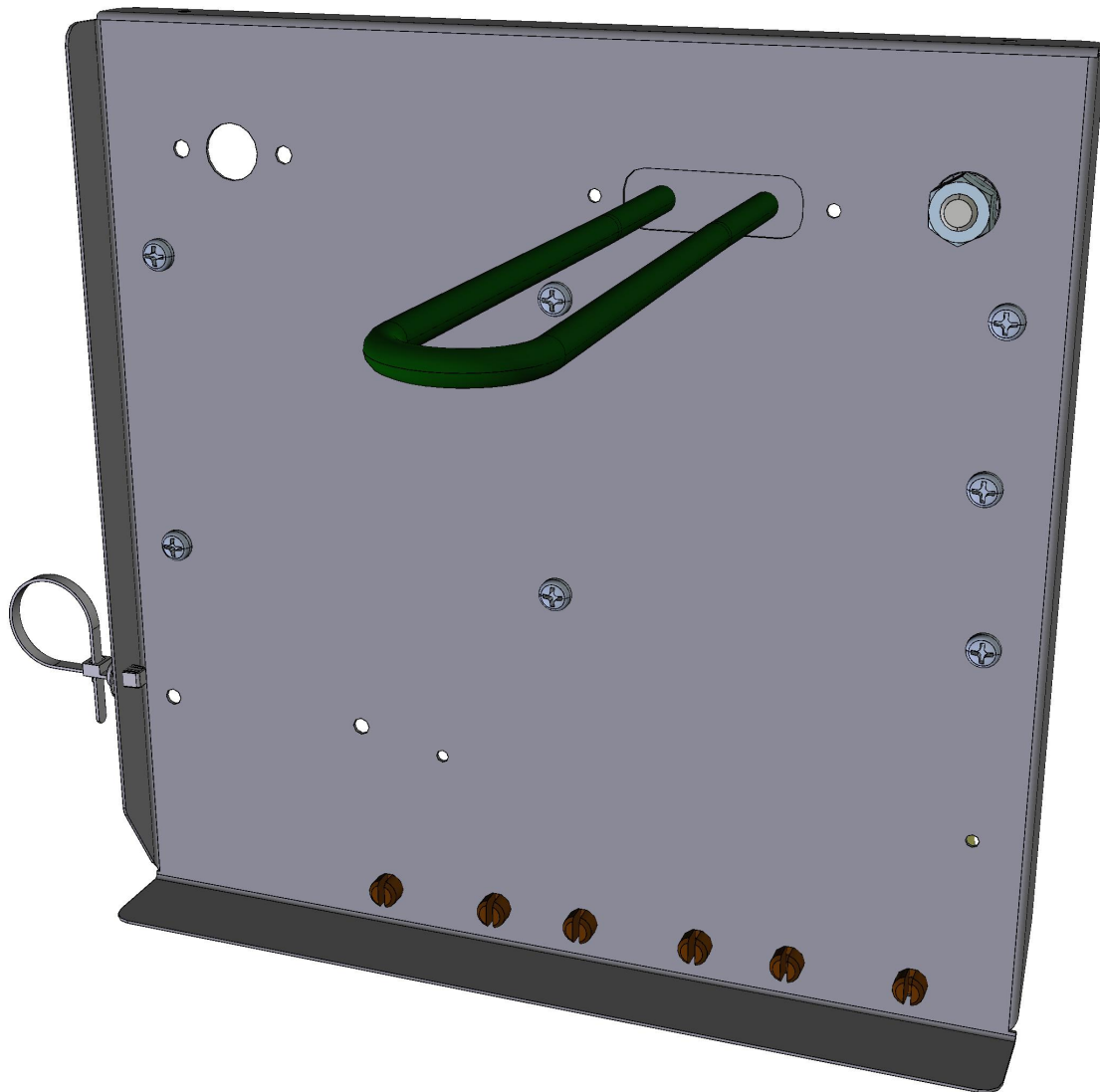

FRONTE

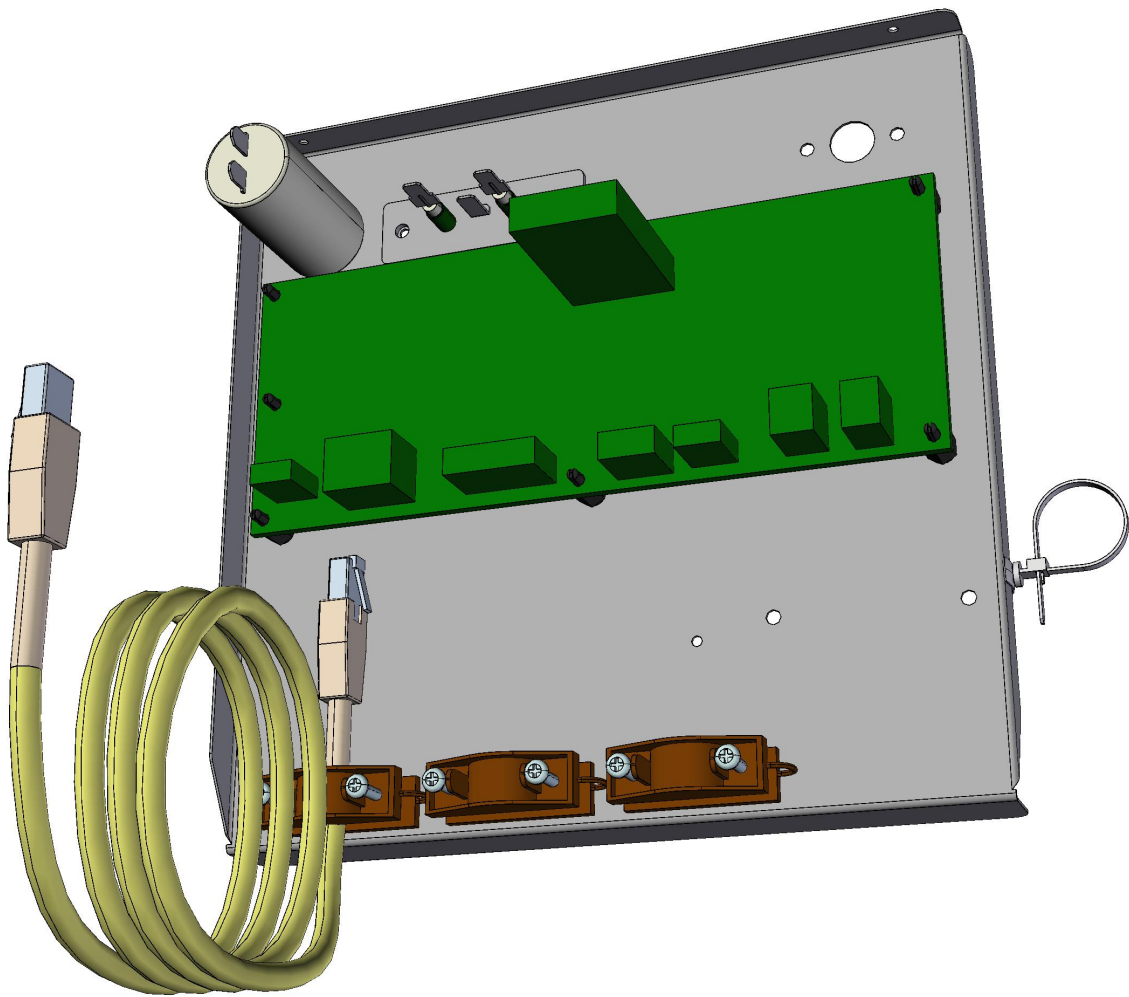

**ASM2978A/0.D00 - Assieme generico**

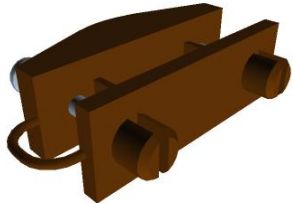
**RETRO**

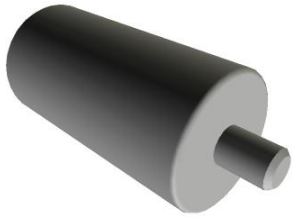

COMPONENTE			RICAMBIO														
Codice	Descrizione	Immagine	Codice	Descrizione	Lista componenti												
0H7185A	LAMIERA PORTACOMPONEN TI ELETTRICI CAPP		0H7185A0	LAMIERA PORTACOMPONEN TI ELETTRICI CAPP													
VE1075A	PRESSACAVO DA PANNELLO PA6 UL94-V2		KVE1075A	KIT 10 PZ PRESSACAVO DA PANNELLO	<table border="1"> <thead> <tr> <th>Codice</th> <th>Descrizione</th> <th>Qtà</th> <th>UM</th> </tr> </thead> <tbody> <tr> <td>VE1075A0</td> <td>PRESSACAVO DA PANNELLO PA6 UL94-V2</td> <td>10</td> <td>PZ</td> </tr> <tr> <td>VM1224A0</td> <td>TUBOLARE TERMORETR 65MY 220MM 2 COLORI</td> <td>0.250</td> <td>M</td> </tr> </tbody> </table>	Codice	Descrizione	Qtà	UM	VE1075A0	PRESSACAVO DA PANNELLO PA6 UL94-V2	10	PZ	VM1224A0	TUBOLARE TERMORETR 65MY 220MM 2 COLORI	0.250	M
Codice	Descrizione	Qtà	UM														
VE1075A0	PRESSACAVO DA PANNELLO PA6 UL94-V2	10	PZ														
VM1224A0	TUBOLARE TERMORETR 65MY 220MM 2 COLORI	0.250	M														
RS1100A	RESISTENZA C.D.T. 90W 110V		KRS1100A	KIT RESISTENZA C.D.T.90W 110V	<table border="1"> <thead> <tr> <th>Codice</th> <th>Descrizione</th> <th>Qtà</th> <th>UM</th> </tr> </thead> <tbody> <tr> <td>RS1100A0</td> <td>RESISTENZA C.D.T. 90W 110</td> <td>1</td> <td>PZ</td> </tr> <tr> <td>VM2147A0</td> <td>SPUGNA ESD ROSA LISCIA 410X343X15 M</td> <td>1</td> <td>PZ</td> </tr> </tbody> </table>	Codice	Descrizione	Qtà	UM	RS1100A0	RESISTENZA C.D.T. 90W 110	1	PZ	VM2147A0	SPUGNA ESD ROSA LISCIA 410X343X15 M	1	PZ
Codice	Descrizione	Qtà	UM														
RS1100A0	RESISTENZA C.D.T. 90W 110	1	PZ														
VM2147A0	SPUGNA ESD ROSA LISCIA 410X343X15 M	1	PZ														
CN1011A	CONDENSATORE 2UF 450V CE/UL CLASSE P2		CN1011A0	CONDENSATORE 2UF 450V CE/UL CLASSE P2													
CE1635A	CAVO RJ45 - RJ45 L=3MT		CE1635A0	CAVO RJ45 - RJ45 L=3MT													

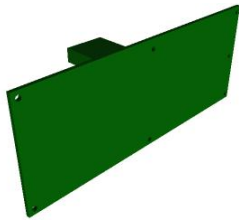
COMPONENTE			RICAMBIO																						
Codice	Descrizione	Immagine	Codice	Descrizione	Lista componenti																				
PE1956D	SCHEDA POTENZA PER CAPPА CON THERMOSTATO		KPE1956D	KIT SCHEDA POTENZA CAPPА CON THERMOSTATO	<table border="1"> <thead> <tr> <th>Codice</th> <th>Descrizione</th> <th>Qtà</th> <th>UM</th> </tr> </thead> <tbody> <tr> <td>PE1956D1</td> <td>SCHEDA POTENZA PER CAPPА CON THERMOSTATO</td> <td>1</td> <td>PZ</td> </tr> <tr> <td>VI1850A0</td> <td>VITE M4X6 TCB+ NICHELATA</td> <td>7</td> <td>PZ</td> </tr> <tr> <td>VM1745A0</td> <td>SUPPORTO PER SCHEDA</td> <td>7</td> <td>PZ</td> </tr> <tr> <td>VM2147A0</td> <td>SPUGNA ESD ROSA LISCIA 410X343X15 M</td> <td>1</td> <td>PZ</td> </tr> </tbody> </table>	Codice	Descrizione	Qtà	UM	PE1956D1	SCHEDA POTENZA PER CAPPА CON THERMOSTATO	1	PZ	VI1850A0	VITE M4X6 TCB+ NICHELATA	7	PZ	VM1745A0	SUPPORTO PER SCHEDA	7	PZ	VM2147A0	SPUGNA ESD ROSA LISCIA 410X343X15 M	1	PZ
Codice	Descrizione	Qtà	UM																						
PE1956D1	SCHEDA POTENZA PER CAPPА CON THERMOSTATO	1	PZ																						
VI1850A0	VITE M4X6 TCB+ NICHELATA	7	PZ																						
VM1745A0	SUPPORTO PER SCHEDA	7	PZ																						
VM2147A0	SPUGNA ESD ROSA LISCIA 410X343X15 M	1	PZ																						



**ASM2976A/0.D00 - Assieme generico**

**FRONTE**

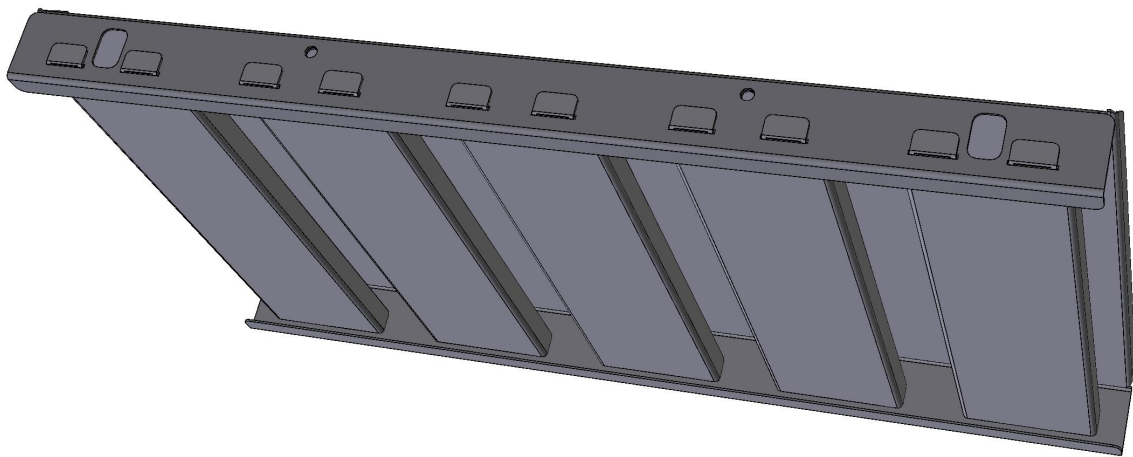

**ASM2976A/0.D00 - Assieme generico**

**RETRO**

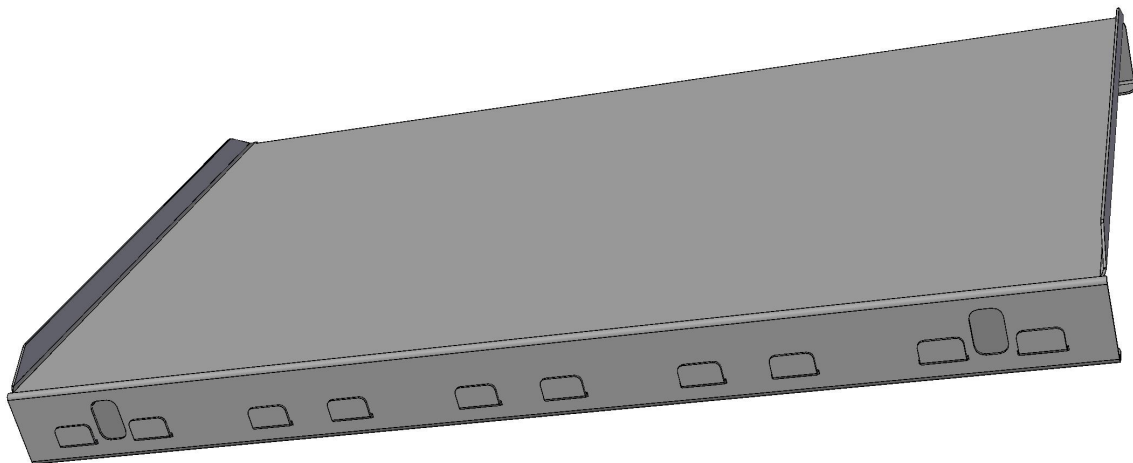



---

COMPONENTE			RICAMBIO		
<i>Codice</i>	<i>Descrizione</i>	<i>Immagine</i>	<i>Codice</i>	<i>Descrizione</i>	<i>Lista componenti</i>

**ASM2977A/0.D00 - Assieme generico**

**FRONTE**

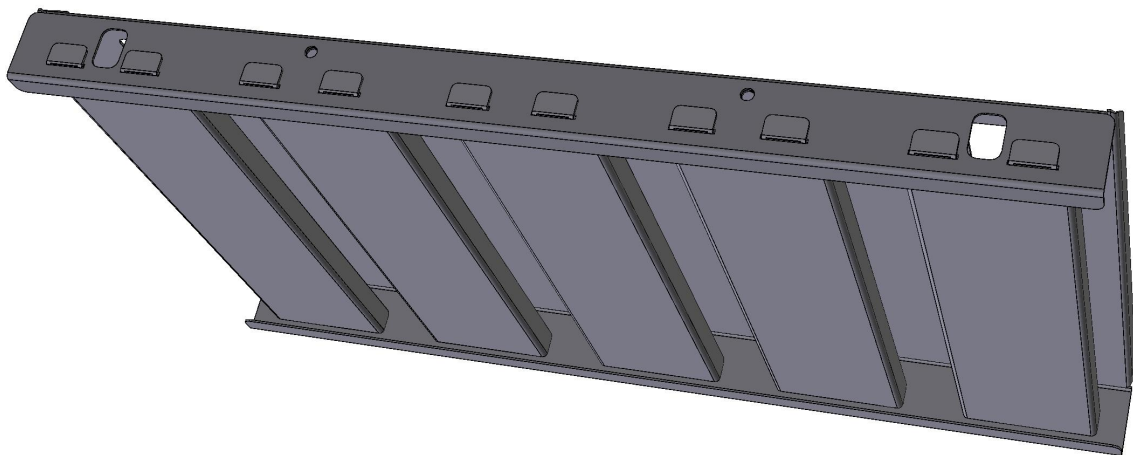

**ASM2977A/0.D00 - Assieme generico**

**RETRO**

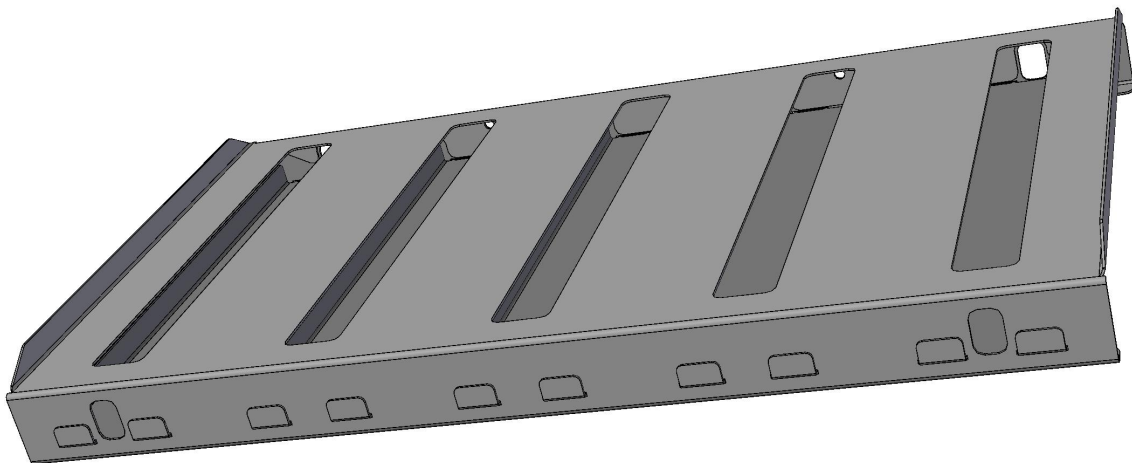



---

COMPONENTE			RICAMBIO		
<i>Codice</i>	<i>Descrizione</i>	<i>Immagine</i>	<i>Codice</i>	<i>Descrizione</i>	<i>Lista componenti</i>

**ASM1760A/0.D00 - Assieme generico**

A dark gray, shaded silhouette of a mechanical part, oriented vertically. The part has a wide top edge, a narrow bottom edge, and a diagonal cutout on the right side. The word "FRONTE" is printed in the center of the part.

**FRONTE**

**ASM1760A/0.D00 - Assieme generico**

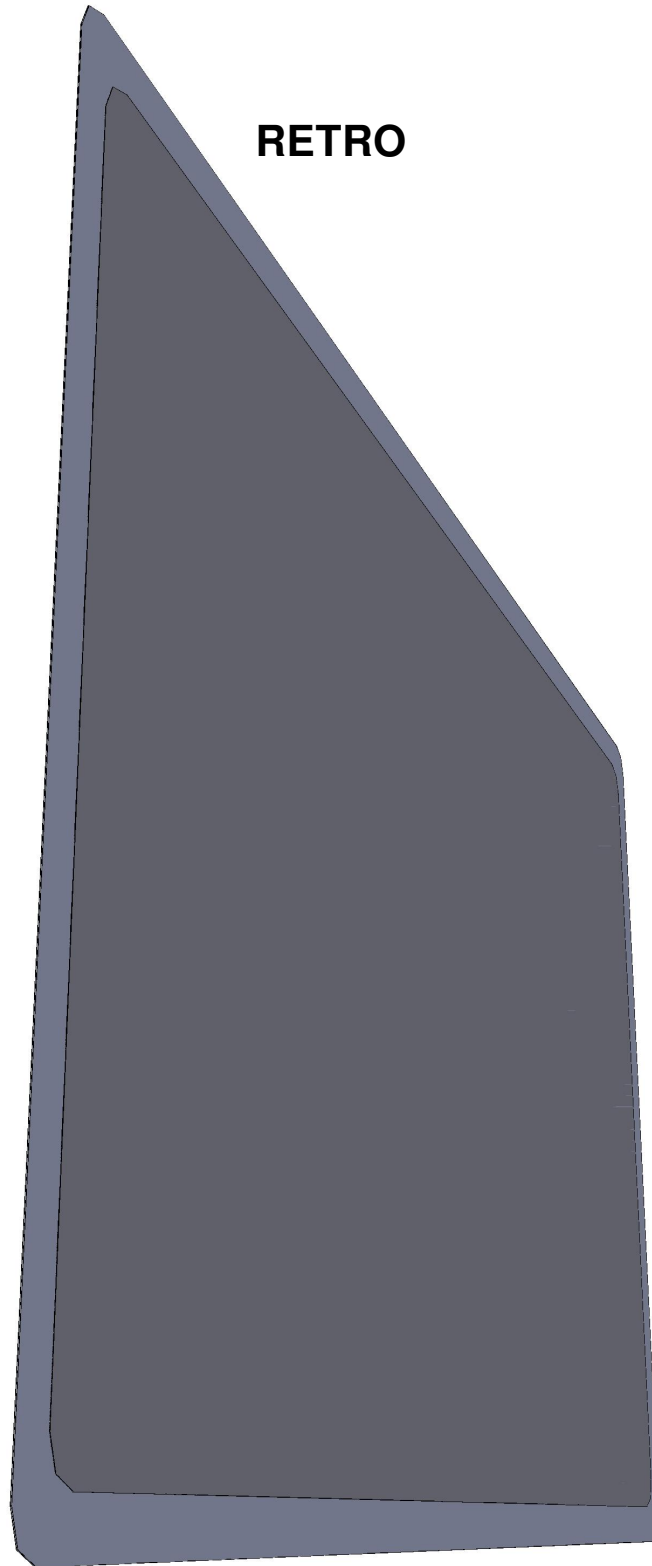





---

COMPONENTE			RICAMBIO		
<i>Codice</i>	<i>Descrizione</i>	<i>Immagine</i>	<i>Codice</i>	<i>Descrizione</i>	<i>Lista componenti</i>

**ASM4250A/0.D00 - Assieme generico**

**FRONTE**

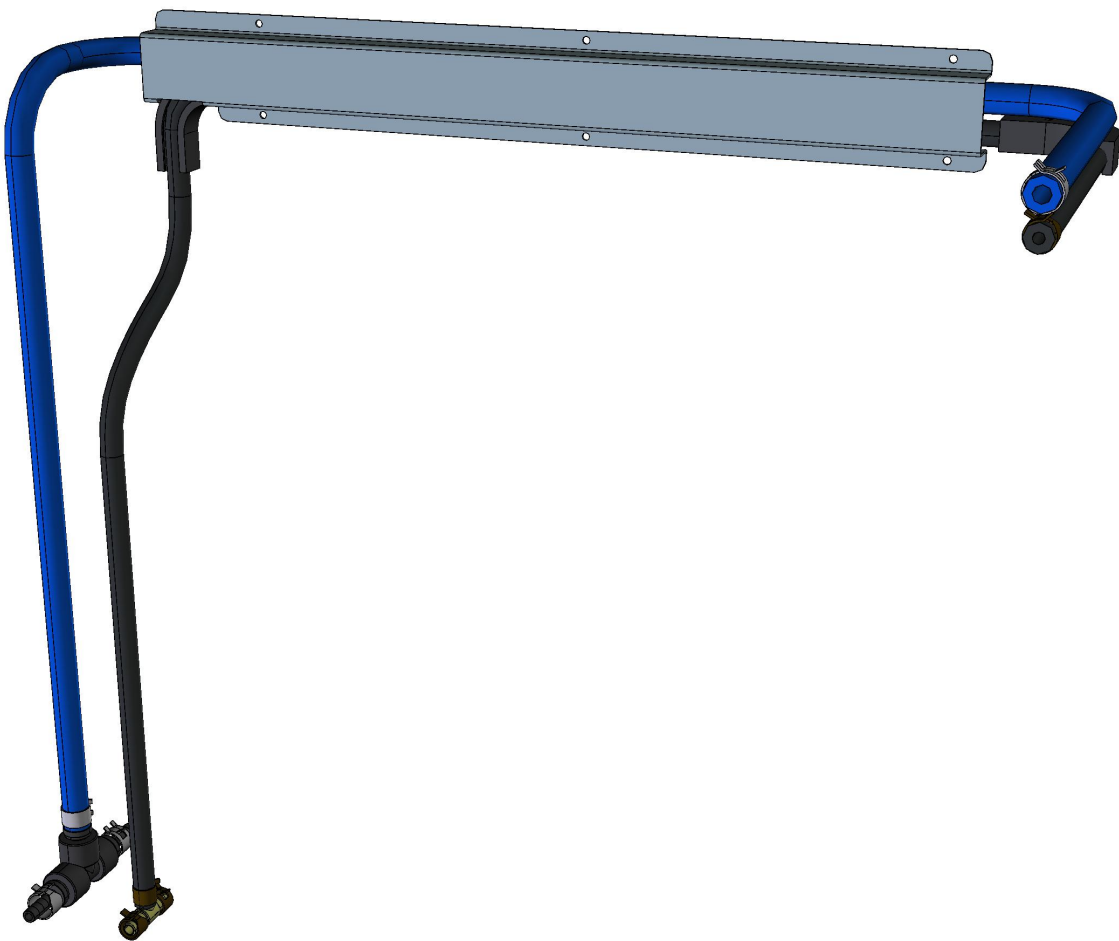

**ASM4250A/0.D00 - Assieme generico**

**RETRO**



COMPONENTE			RICAMBIO																		
Codice	Descrizione	Immagine	Codice	Descrizione	Lista componenti																
RC1019A	FASCETTA ELASTICA D10 ZINCATA		KRC1019A	KIT 15 PZ FASCETTA ELASTICA D10 ZINCATA	<table border="1"> <thead> <tr> <th>Codice</th> <th>Descrizione</th> <th>Qtà</th> <th>UM</th> </tr> </thead> <tbody> <tr> <td>RC1019A0</td> <td>FASCETTA ELASTICA D10 ZINCATA</td> <td>17</td> <td>PZ</td> </tr> <tr> <td>VM1224A0</td> <td>TUBOLARE TERMORETR 65MY 220MM 2 COLORI</td> <td>0.200</td> <td>M</td> </tr> </tbody> </table>	Codice	Descrizione	Qtà	UM	RC1019A0	FASCETTA ELASTICA D10 ZINCATA	17	PZ	VM1224A0	TUBOLARE TERMORETR 65MY 220MM 2 COLORI	0.200	M				
Codice	Descrizione	Qtà	UM																		
RC1019A0	FASCETTA ELASTICA D10 ZINCATA	17	PZ																		
VM1224A0	TUBOLARE TERMORETR 65MY 220MM 2 COLORI	0.200	M																		
VL1047A	PORTAGOMMA D6 CODOLO D8		KVL1047A	KIT 10 PZ PORTAGOMMA Ø6 CODOLO Ø8	<table border="1"> <thead> <tr> <th>Codice</th> <th>Descrizione</th> <th>Qtà</th> <th>UM</th> </tr> </thead> <tbody> <tr> <td>VL1047A1</td> <td>PORTAGOMM A D6 CODOLO D8</td> <td>10</td> <td>PZ</td> </tr> <tr> <td>VM1224A0</td> <td>TUBOLARE TERMORETR 65MY 220MM 2 COLORI</td> <td>0.200</td> <td>M</td> </tr> </tbody> </table>	Codice	Descrizione	Qtà	UM	VL1047A1	PORTAGOMM A D6 CODOLO D8	10	PZ	VM1224A0	TUBOLARE TERMORETR 65MY 220MM 2 COLORI	0.200	M				
Codice	Descrizione	Qtà	UM																		
VL1047A1	PORTAGOMM A D6 CODOLO D8	10	PZ																		
VM1224A0	TUBOLARE TERMORETR 65MY 220MM 2 COLORI	0.200	M																		
			KVL0016A	KIT 260PZ ADATTAMENTO BRITA IMP.LAVAG M	<table border="1"> <thead> <tr> <th>Codice</th> <th>Descrizione</th> <th>Qtà</th> <th>UM</th> </tr> </thead> <tbody> <tr> <td>EL1185A0</td> <td>RACCORDO A GOMITO J.GUEST Ø8F - Ø8F</td> <td>260</td> <td>PZ</td> </tr> <tr> <td>RC1018A0</td> <td>FASCETTA ELASTICA D12 ZINCATA</td> <td>520</td> <td>PZ</td> </tr> <tr> <td>VL1047A1</td> <td>PORTAGOMM A D6 CODOLO D8</td> <td>520</td> <td>PZ</td> </tr> </tbody> </table>	Codice	Descrizione	Qtà	UM	EL1185A0	RACCORDO A GOMITO J.GUEST Ø8F - Ø8F	260	PZ	RC1018A0	FASCETTA ELASTICA D12 ZINCATA	520	PZ	VL1047A1	PORTAGOMM A D6 CODOLO D8	520	PZ
Codice	Descrizione	Qtà	UM																		
EL1185A0	RACCORDO A GOMITO J.GUEST Ø8F - Ø8F	260	PZ																		
RC1018A0	FASCETTA ELASTICA D12 ZINCATA	520	PZ																		
VL1047A1	PORTAGOMM A D6 CODOLO D8	520	PZ																		
EL1020A	RACCORDO INTERMEDIO "T" TUBO D8 JG		KEL1020A	KIT 10 PZ RACCORDO T JG Ø8	<table border="1"> <thead> <tr> <th>Codice</th> <th>Descrizione</th> <th>Qtà</th> <th>UM</th> </tr> </thead> <tbody> <tr> <td>EL1020A1</td> <td>RACCORDO INTERMEDIO "T" TUBO D8 J</td> <td>10</td> <td>PZ</td> </tr> <tr> <td>VM1224A0</td> <td>TUBOLARE TERMORETR 65MY 220MM 2 COLORI</td> <td>0.200</td> <td>M</td> </tr> </tbody> </table>	Codice	Descrizione	Qtà	UM	EL1020A1	RACCORDO INTERMEDIO "T" TUBO D8 J	10	PZ	VM1224A0	TUBOLARE TERMORETR 65MY 220MM 2 COLORI	0.200	M				
Codice	Descrizione	Qtà	UM																		
EL1020A1	RACCORDO INTERMEDIO "T" TUBO D8 J	10	PZ																		
VM1224A0	TUBOLARE TERMORETR 65MY 220MM 2 COLORI	0.200	M																		
VL1084A	RACCORDO A T 1/4 BARBED		KVL1084A	KIT 10 PZ RACCORDO A T 1/4 BARBED	<table border="1"> <thead> <tr> <th>Codice</th> <th>Descrizione</th> <th>Qtà</th> <th>UM</th> </tr> </thead> <tbody> <tr> <td>VL1084A0</td> <td>RACCORDO A T 1/4 BARBED</td> <td>10</td> <td>PZ</td> </tr> <tr> <td>VM1224A0</td> <td>TUBOLARE TERMORETR 65MY 220MM 2 COLORI</td> <td>0.200</td> <td>M</td> </tr> </tbody> </table>	Codice	Descrizione	Qtà	UM	VL1084A0	RACCORDO A T 1/4 BARBED	10	PZ	VM1224A0	TUBOLARE TERMORETR 65MY 220MM 2 COLORI	0.200	M				
Codice	Descrizione	Qtà	UM																		
VL1084A0	RACCORDO A T 1/4 BARBED	10	PZ																		
VM1224A0	TUBOLARE TERMORETR 65MY 220MM 2 COLORI	0.200	M																		

<b>COMPONENTE</b>			<b>RICAMBIO</b>		
<i>Codice</i>	<i>Descrizione</i>	<i>Immagine</i>	<i>Codice</i>	<i>Descrizione</i>	<i>Lista componenti</i>
RC1389A	CURVA GUIDA TUBO PET D10		RC1389A0	CURVA GUIDA TUBO PET D10	
0H7362B	CANALINA PASSATUBI CAPPA		0H7362B0	CANALINA PASSATUBI CAPPA	
TB3247A	TUBO EPDM BIANCO-BLU ALLACCIAMENTO		TB3247A0	TUBO EPDM BIANCO-BLU ALLACCIAMENTO	
TB3248A	TUBO EPDM NERO ALLACCIAMENTO DETERGENTE		TB3248A0	TUBO EPDM NERO ALLACCIAMENTO DETERGENTE	

**VL1121A/0.D00 - ASM LAVAGGIO CAPPA EU**



**FRONTE**

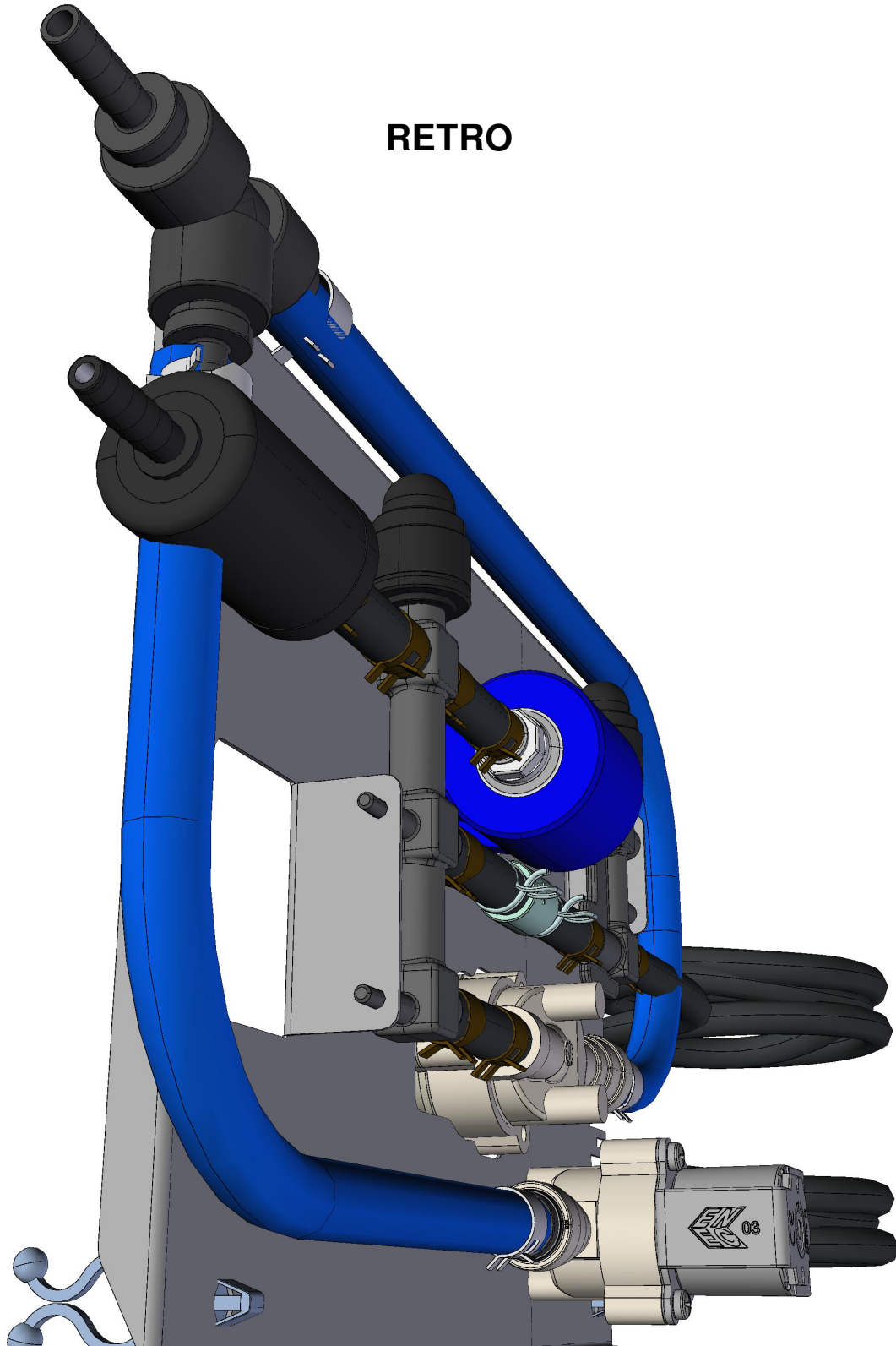

VL1121A/0.D00 - ASM LAVAGGIO CAPP A EU

RETRO

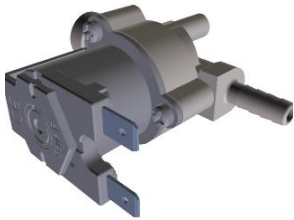

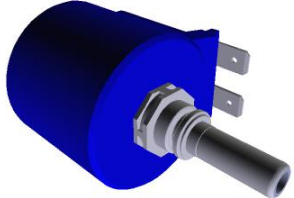
COMPONENTE			RICAMBIO																																														
Codice	Descrizione	Immagine	Codice	Descrizione	Lista componenti																																												
EL1424A	ELETTROVALVOLA UL H2O JG D8-PORTAGOMMA		KEL1426A	KIT EL.VALVOLA UL H2O JG D8-PORTAGOMMA	<table border="1"> <thead> <tr> <th>Codice</th> <th>Descrizione</th> <th>Qtà</th> <th>UM</th> </tr> </thead> <tbody> <tr> <td>EL1426A0</td> <td>ELETTROVALV OLA UL H2O JG D8-PORTAGO MMA D</td> <td>1</td> <td>PZ</td> </tr> <tr> <td>VM1224A0</td> <td>TUBOLARE TERMORETR 65MY 220MM 2 COLORI</td> <td>0.250</td> <td>M</td> </tr> </tbody> </table>	Codice	Descrizione	Qtà	UM	EL1426A0	ELETTROVALV OLA UL H2O JG D8-PORTAGO MMA D	1	PZ	VM1224A0	TUBOLARE TERMORETR 65MY 220MM 2 COLORI	0.250	M																																
Codice	Descrizione	Qtà	UM																																														
EL1426A0	ELETTROVALV OLA UL H2O JG D8-PORTAGO MMA D	1	PZ																																														
VM1224A0	TUBOLARE TERMORETR 65MY 220MM 2 COLORI	0.250	M																																														
EL1436A	EV H2O JG D8-PORTAGOMMA D6 CHECK VALVE		KEL1436B	KIT EV H2O JG D8-PORTAGOMMA D6 VNR	<table border="1"> <thead> <tr> <th>Codice</th> <th>Descrizione</th> <th>Qtà</th> <th>UM</th> </tr> </thead> <tbody> <tr> <td>EL1436B0</td> <td>ELETTROV. H2O JG D8-BARBED D6 VNR</td> <td>1</td> <td>PZ</td> </tr> <tr> <td>VM1224A0</td> <td>TUBOLARE TERMORETR 65MY 220MM 2 COLORI</td> <td>0.250</td> <td>M</td> </tr> </tbody> </table>	Codice	Descrizione	Qtà	UM	EL1436B0	ELETTROV. H2O JG D8-BARBED D6 VNR	1	PZ	VM1224A0	TUBOLARE TERMORETR 65MY 220MM 2 COLORI	0.250	M																																
Codice	Descrizione	Qtà	UM																																														
EL1436B0	ELETTROV. H2O JG D8-BARBED D6 VNR	1	PZ																																														
VM1224A0	TUBOLARE TERMORETR 65MY 220MM 2 COLORI	0.250	M																																														
VL1019A	POMPA VIBRAZIONE		KVL1122A	KIT IMPIANTO LAVAGGIO CAPPA USA	<table border="1"> <thead> <tr> <th>Codice</th> <th>Descrizione</th> <th>Qtà</th> <th>UM</th> </tr> </thead> <tbody> <tr> <td>0H7368A0</td> <td>LAMIERA IMPIANTO IDRICO CAPPA S6</td> <td>1</td> <td>PZ</td> </tr> <tr> <td>EL1426B0</td> <td>ELETTROVALV OLA UL H2O JG D8-PORTAGO MMA D</td> <td>1</td> <td>PZ</td> </tr> <tr> <td>EL1437B0</td> <td>ELETTROV. H2O JG D8-BARBED D6 VNR UL</td> <td>1</td> <td>PZ</td> </tr> <tr> <td>GN1526A0</td> <td>O-RING D.INT6.9 SP1.8</td> <td>1</td> <td>PZ</td> </tr> <tr> <td>RC1018A0</td> <td>FASCETTA ELASTICA D12 ZINCATA</td> <td>2</td> <td>PZ</td> </tr> <tr> <td>RC1019A0</td> <td>FASCETTA ELASTICA D10 ZINCATA</td> <td>12</td> <td>PZ</td> </tr> <tr> <td>RC1242A0</td> <td>TERMINALE CHIUSO D10</td> <td>2</td> <td>PZ</td> </tr> <tr> <td>RC1408A0</td> <td>FASCETTA BIFILARE A MOLLA D10.8 TUBO ZN</td> <td>2</td> <td>PZ</td> </tr> <tr> <td>RC1414A0</td> <td>FASCETTA STRINGITUBO A SCATTO PER D 12</td> <td>2</td> <td>PZ</td> </tr> <tr> <td>TB2820A0</td> <td>TUBO EPDM 6X10</td> <td>2.200</td> <td>M</td> </tr> </tbody> </table>	Codice	Descrizione	Qtà	UM	0H7368A0	LAMIERA IMPIANTO IDRICO CAPPA S6	1	PZ	EL1426B0	ELETTROVALV OLA UL H2O JG D8-PORTAGO MMA D	1	PZ	EL1437B0	ELETTROV. H2O JG D8-BARBED D6 VNR UL	1	PZ	GN1526A0	O-RING D.INT6.9 SP1.8	1	PZ	RC1018A0	FASCETTA ELASTICA D12 ZINCATA	2	PZ	RC1019A0	FASCETTA ELASTICA D10 ZINCATA	12	PZ	RC1242A0	TERMINALE CHIUSO D10	2	PZ	RC1408A0	FASCETTA BIFILARE A MOLLA D10.8 TUBO ZN	2	PZ	RC1414A0	FASCETTA STRINGITUBO A SCATTO PER D 12	2	PZ	TB2820A0	TUBO EPDM 6X10	2.200	M
Codice	Descrizione	Qtà	UM																																														
0H7368A0	LAMIERA IMPIANTO IDRICO CAPPA S6	1	PZ																																														
EL1426B0	ELETTROVALV OLA UL H2O JG D8-PORTAGO MMA D	1	PZ																																														
EL1437B0	ELETTROV. H2O JG D8-BARBED D6 VNR UL	1	PZ																																														
GN1526A0	O-RING D.INT6.9 SP1.8	1	PZ																																														
RC1018A0	FASCETTA ELASTICA D12 ZINCATA	2	PZ																																														
RC1019A0	FASCETTA ELASTICA D10 ZINCATA	12	PZ																																														
RC1242A0	TERMINALE CHIUSO D10	2	PZ																																														
RC1408A0	FASCETTA BIFILARE A MOLLA D10.8 TUBO ZN	2	PZ																																														
RC1414A0	FASCETTA STRINGITUBO A SCATTO PER D 12	2	PZ																																														
TB2820A0	TUBO EPDM 6X10	2.200	M																																														

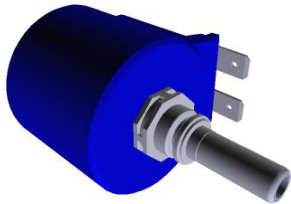

COMPONENTE			RICAMBIO																																																						
Codice	Descrizione	Immagine	Codice	Descrizione	Lista componenti																																																				
VL1019A	POMPA VIBRAZIONE		KVL1122A	KIT IMPIANTO LAVAGGIO CAPP A USA	<table border="1"> <thead> <tr> <th>Codice</th> <th>Descrizione</th> <th>Qtà</th> <th>UM</th> </tr> </thead> <tbody> <tr> <td>TB3132A0</td> <td>TUBO TELATO EPDM BIANCO-BLU 6X12</td> <td>0.540</td> <td>M</td> </tr> <tr> <td>V11220A1</td> <td>VITE AUTOFILETTA NTE 4.2X11 TCS+ MARUTE</td> <td>5</td> <td>PZ</td> </tr> <tr> <td>VL1019A0</td> <td>POMPA VIBRAZIONE</td> <td>1</td> <td>PZ</td> </tr> <tr> <td>VL1047A1</td> <td>PORTAGOMM A D6 CODOLO D8</td> <td>2</td> <td>PZ</td> </tr> <tr> <td>VL1053B0</td> <td>DISTRIBUTOR E USCITA LAVAGGIO ON</td> <td>1</td> <td>PZ</td> </tr> <tr> <td>VL1054B0</td> <td>DISTRIBUTOR E INGRESSI LAVAGGIO ON</td> <td>1</td> <td>PZ</td> </tr> <tr> <td>VL1081A0</td> <td>VALVOLA NON RITORNO BARBED D6</td> <td>1</td> <td>PZ</td> </tr> <tr> <td>VL1102A1</td> <td>FILTRO IN LINEA DET. + VNR BARBED 6 MM</td> <td>1</td> <td>PZ</td> </tr> <tr> <td>VL1127A1</td> <td>RACCORDO A T BARBED 6</td> <td>1</td> <td>PZ</td> </tr> <tr> <td>VL1128A0</td> <td>VALVOLA VNR BARBED D6</td> <td>1</td> <td>PZ</td> </tr> <tr> <td>VM1605A0</td> <td>CLIP TWIST LOCK DIAM. 10.2-12.7 MM</td> <td>2</td> <td>PZ</td> </tr> <tr> <td>VM2172A0</td> <td>CLIP BLOCCAGGIO POMPA CON CIRCUITO</td> <td>1</td> <td>PZ</td> </tr> </tbody> </table>	Codice	Descrizione	Qtà	UM	TB3132A0	TUBO TELATO EPDM BIANCO-BLU 6X12	0.540	M	V11220A1	VITE AUTOFILETTA NTE 4.2X11 TCS+ MARUTE	5	PZ	VL1019A0	POMPA VIBRAZIONE	1	PZ	VL1047A1	PORTAGOMM A D6 CODOLO D8	2	PZ	VL1053B0	DISTRIBUTOR E USCITA LAVAGGIO ON	1	PZ	VL1054B0	DISTRIBUTOR E INGRESSI LAVAGGIO ON	1	PZ	VL1081A0	VALVOLA NON RITORNO BARBED D6	1	PZ	VL1102A1	FILTRO IN LINEA DET. + VNR BARBED 6 MM	1	PZ	VL1127A1	RACCORDO A T BARBED 6	1	PZ	VL1128A0	VALVOLA VNR BARBED D6	1	PZ	VM1605A0	CLIP TWIST LOCK DIAM. 10.2-12.7 MM	2	PZ	VM2172A0	CLIP BLOCCAGGIO POMPA CON CIRCUITO	1	PZ
Codice	Descrizione	Qtà	UM																																																						
TB3132A0	TUBO TELATO EPDM BIANCO-BLU 6X12	0.540	M																																																						
V11220A1	VITE AUTOFILETTA NTE 4.2X11 TCS+ MARUTE	5	PZ																																																						
VL1019A0	POMPA VIBRAZIONE	1	PZ																																																						
VL1047A1	PORTAGOMM A D6 CODOLO D8	2	PZ																																																						
VL1053B0	DISTRIBUTOR E USCITA LAVAGGIO ON	1	PZ																																																						
VL1054B0	DISTRIBUTOR E INGRESSI LAVAGGIO ON	1	PZ																																																						
VL1081A0	VALVOLA NON RITORNO BARBED D6	1	PZ																																																						
VL1102A1	FILTRO IN LINEA DET. + VNR BARBED 6 MM	1	PZ																																																						
VL1127A1	RACCORDO A T BARBED 6	1	PZ																																																						
VL1128A0	VALVOLA VNR BARBED D6	1	PZ																																																						
VM1605A0	CLIP TWIST LOCK DIAM. 10.2-12.7 MM	2	PZ																																																						
VM2172A0	CLIP BLOCCAGGIO POMPA CON CIRCUITO	1	PZ																																																						
			KVL1121A	KIT IMPIANTO LAVAGGIO CAPP A MM EU	<table border="1"> <thead> <tr> <th>Codice</th> <th>Descrizione</th> <th>Qtà</th> <th>UM</th> </tr> </thead> <tbody> <tr> <td>0H2143A0</td> <td>LAMIERA BLOCCA VNR VL1128</td> <td>1</td> <td>PZ</td> </tr> <tr> <td>0H7368A0</td> <td>LAMIERA IMPIANTO IDRICO CAPP A S6</td> <td>1</td> <td>PZ</td> </tr> <tr> <td>EL1424A0</td> <td>ELETTROVALV OLA H2O JG D8-PORTAGO MMA D6</td> <td>1</td> <td>PZ</td> </tr> <tr> <td>EL1424B0</td> <td>ELETTROVALV OLA H2O JG D8-PORTAGO MMA D6</td> <td>1</td> <td>PZ</td> </tr> </tbody> </table>	Codice	Descrizione	Qtà	UM	0H2143A0	LAMIERA BLOCCA VNR VL1128	1	PZ	0H7368A0	LAMIERA IMPIANTO IDRICO CAPP A S6	1	PZ	EL1424A0	ELETTROVALV OLA H2O JG D8-PORTAGO MMA D6	1	PZ	EL1424B0	ELETTROVALV OLA H2O JG D8-PORTAGO MMA D6	1	PZ																																
Codice	Descrizione	Qtà	UM																																																						
0H2143A0	LAMIERA BLOCCA VNR VL1128	1	PZ																																																						
0H7368A0	LAMIERA IMPIANTO IDRICO CAPP A S6	1	PZ																																																						
EL1424A0	ELETTROVALV OLA H2O JG D8-PORTAGO MMA D6	1	PZ																																																						
EL1424B0	ELETTROVALV OLA H2O JG D8-PORTAGO MMA D6	1	PZ																																																						

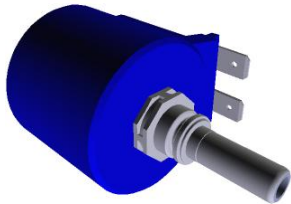
COMPONENTE			RICAMBIO																																																														
Codice	Descrizione	Immagine	Codice	Descrizione	Lista componenti																																																												
VL1019A	POMPA VIBRAZIONE		KVL1121A	KIT IMPIANTO LAVAGGIO CAPPA MM EU	<table border="1"> <thead> <tr> <th>Codice</th> <th>Descrizione</th> <th>Qtà</th> <th>UM</th> </tr> </thead> <tbody> <tr> <td>EL1436A0</td> <td>EV H2O JG D8-PORTAGO MMA D6 CHECK VALVE</td> <td>1</td> <td>PZ</td> </tr> <tr> <td>EL1436B0</td> <td>ELETTROV. H2O JG D8-BARBED D6 VNR</td> <td>1</td> <td>PZ</td> </tr> <tr> <td>GN1526A0</td> <td>O-RING D.INT6.9 SP1.8</td> <td>1</td> <td>PZ</td> </tr> <tr> <td>RC1019A0</td> <td>FASCETTA ELASTICA D10 ZINCATA</td> <td>12</td> <td>PZ</td> </tr> <tr> <td>RC1242A0</td> <td>TERMINALE CHIUSO D10</td> <td>2</td> <td>PZ</td> </tr> <tr> <td>RC1408A0</td> <td>FASCETTA BIFILARE A MOLLA D10.8 TUBO ZN</td> <td>2</td> <td>PZ</td> </tr> <tr> <td>TB2820A0</td> <td>TUBO EPDM 6X10</td> <td>2.200</td> <td>M</td> </tr> <tr> <td>VI1220A1</td> <td>VITE AUTOFILETTA NTE 4.2X11 TCS+ MARUTE</td> <td>5</td> <td>PZ</td> </tr> <tr> <td>VL1019A0</td> <td>POMPA VIBRAZIONE</td> <td>1</td> <td>PZ</td> </tr> <tr> <td>VL1053B0</td> <td>DISTRIBUTOR E USCITA LAVAGGIO ON</td> <td>1</td> <td>PZ</td> </tr> <tr> <td>VL1054B0</td> <td>DISTRIBUTOR E INGRESSI LAVAGGIO ON</td> <td>1</td> <td>PZ</td> </tr> <tr> <td>VL1102A1</td> <td>FILTRO IN LINEA DET. + VNR BARBED 6 MM</td> <td>1</td> <td>PZ</td> </tr> <tr> <td>VL1128A0</td> <td>VALVOLA VNR BARBED D6</td> <td>1</td> <td>PZ</td> </tr> <tr> <td>VM2172A0</td> <td>CLIP BLOCCAGGIO POMPA CON CIRCUITO</td> <td>1</td> <td>PZ</td> </tr> </tbody> </table>	Codice	Descrizione	Qtà	UM	EL1436A0	EV H2O JG D8-PORTAGO MMA D6 CHECK VALVE	1	PZ	EL1436B0	ELETTROV. H2O JG D8-BARBED D6 VNR	1	PZ	GN1526A0	O-RING D.INT6.9 SP1.8	1	PZ	RC1019A0	FASCETTA ELASTICA D10 ZINCATA	12	PZ	RC1242A0	TERMINALE CHIUSO D10	2	PZ	RC1408A0	FASCETTA BIFILARE A MOLLA D10.8 TUBO ZN	2	PZ	TB2820A0	TUBO EPDM 6X10	2.200	M	VI1220A1	VITE AUTOFILETTA NTE 4.2X11 TCS+ MARUTE	5	PZ	VL1019A0	POMPA VIBRAZIONE	1	PZ	VL1053B0	DISTRIBUTOR E USCITA LAVAGGIO ON	1	PZ	VL1054B0	DISTRIBUTOR E INGRESSI LAVAGGIO ON	1	PZ	VL1102A1	FILTRO IN LINEA DET. + VNR BARBED 6 MM	1	PZ	VL1128A0	VALVOLA VNR BARBED D6	1	PZ	VM2172A0	CLIP BLOCCAGGIO POMPA CON CIRCUITO	1	PZ
Codice	Descrizione	Qtà	UM																																																														
EL1436A0	EV H2O JG D8-PORTAGO MMA D6 CHECK VALVE	1	PZ																																																														
EL1436B0	ELETTROV. H2O JG D8-BARBED D6 VNR	1	PZ																																																														
GN1526A0	O-RING D.INT6.9 SP1.8	1	PZ																																																														
RC1019A0	FASCETTA ELASTICA D10 ZINCATA	12	PZ																																																														
RC1242A0	TERMINALE CHIUSO D10	2	PZ																																																														
RC1408A0	FASCETTA BIFILARE A MOLLA D10.8 TUBO ZN	2	PZ																																																														
TB2820A0	TUBO EPDM 6X10	2.200	M																																																														
VI1220A1	VITE AUTOFILETTA NTE 4.2X11 TCS+ MARUTE	5	PZ																																																														
VL1019A0	POMPA VIBRAZIONE	1	PZ																																																														
VL1053B0	DISTRIBUTOR E USCITA LAVAGGIO ON	1	PZ																																																														
VL1054B0	DISTRIBUTOR E INGRESSI LAVAGGIO ON	1	PZ																																																														
VL1102A1	FILTRO IN LINEA DET. + VNR BARBED 6 MM	1	PZ																																																														
VL1128A0	VALVOLA VNR BARBED D6	1	PZ																																																														
VM2172A0	CLIP BLOCCAGGIO POMPA CON CIRCUITO	1	PZ																																																														
			KVL1120A	KIT IMPIANTO LAVAGGIO PLUS COMPACT USA	<table border="1"> <thead> <tr> <th>Codice</th> <th>Descrizione</th> <th>Qtà</th> <th>UM</th> </tr> </thead> <tbody> <tr> <td>0H2143A0</td> <td>LAMIERA BLOCCA VNR VL1128</td> <td>1</td> <td>PZ</td> </tr> <tr> <td>0H7553D0</td> <td>LAMIERA CIRCUITO LAVAGGIO XECC PLUS</td> <td>1</td> <td>PZ</td> </tr> </tbody> </table>	Codice	Descrizione	Qtà	UM	0H2143A0	LAMIERA BLOCCA VNR VL1128	1	PZ	0H7553D0	LAMIERA CIRCUITO LAVAGGIO XECC PLUS	1	PZ																																																
Codice	Descrizione	Qtà	UM																																																														
0H2143A0	LAMIERA BLOCCA VNR VL1128	1	PZ																																																														
0H7553D0	LAMIERA CIRCUITO LAVAGGIO XECC PLUS	1	PZ																																																														

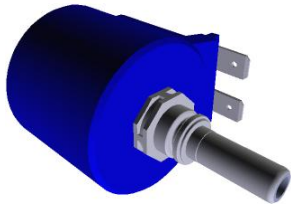
COMPONENTE			RICAMBIO																																																																						
Codice	Descrizione	Immagine	Codice	Descrizione	Lista componenti																																																																				
VL1019A	POMPA VIBRAZIONE		KVL1120A	KIT IMPIANTO LAVAGGIO PLUS COMPACT USA	<table border="1"> <thead> <tr> <th>Codice</th> <th>Descrizione</th> <th>Qtà</th> <th>UM</th> </tr> </thead> <tbody> <tr> <td>EL1422A1</td> <td>ELETTROVALV 1 VIA RID.VERDE JG D8-D10 UL</td> <td>1</td> <td>PZ</td> </tr> <tr> <td>EL1426A0</td> <td>ELETTROVALV OLA UL H2O JG D8-PORTAGO MMA D</td> <td>1</td> <td>PZ</td> </tr> <tr> <td>EL1426B0</td> <td>ELETTROVALV OLA UL H2O JG D8-PORTAGO MMA D</td> <td>1</td> <td>PZ</td> </tr> <tr> <td>EL1437A0</td> <td>EV H2O JG D8-PORTAGO MMA D6 CH. VALVE UL</td> <td>1</td> <td>PZ</td> </tr> <tr> <td>EL1437B0</td> <td>ELETTROV. H2O JG D8-BARBED D6 VNR UL</td> <td>1</td> <td>PZ</td> </tr> <tr> <td>GN1312A0</td> <td>PASSACAVO GOMMA DE=26 DI=15 SP=10</td> <td>1</td> <td>PZ</td> </tr> <tr> <td>GN1526A0</td> <td>O-RING D.INT6.9 SP1.8</td> <td>1</td> <td>PZ</td> </tr> <tr> <td>RC1019A0</td> <td>FASCETTA ELASTICA D10 ZINCATA</td> <td>10</td> <td>PZ</td> </tr> <tr> <td>RC1242A0</td> <td>TERMINALE CHIUSO D10</td> <td>2</td> <td>PZ</td> </tr> <tr> <td>RC1356A0</td> <td>RACCORDO DRITTO FIL. FEMM 8X1/4 BSP</td> <td>1</td> <td>PZ</td> </tr> <tr> <td>TB2820A0</td> <td>TUBO EPDM 6X10</td> <td>1.200</td> <td>M</td> </tr> <tr> <td>VI1220A1</td> <td>VITE AUTOFILETTA NTE 4.2X11 TCS+ MARUTE</td> <td>9</td> <td>PZ</td> </tr> <tr> <td>VL1019A0</td> <td>POMPA VIBRAZIONE</td> <td>1</td> <td>PZ</td> </tr> <tr> <td>VL1054B0</td> <td>DISTRIBUTOR E INGRESSI LAVAGGIO ON</td> <td>1</td> <td>PZ</td> </tr> <tr> <td>VL1064A0</td> <td>DISTRIBUTOR E USCITE CIRCUITO LAVAGGIO PL</td> <td>1</td> <td>PZ</td> </tr> <tr> <td>VL1065A1</td> <td>PRESSOSTAT O.N.O. 1/4 M CI</td> <td>1</td> <td>PZ</td> </tr> </tbody> </table>	Codice	Descrizione	Qtà	UM	EL1422A1	ELETTROVALV 1 VIA RID.VERDE JG D8-D10 UL	1	PZ	EL1426A0	ELETTROVALV OLA UL H2O JG D8-PORTAGO MMA D	1	PZ	EL1426B0	ELETTROVALV OLA UL H2O JG D8-PORTAGO MMA D	1	PZ	EL1437A0	EV H2O JG D8-PORTAGO MMA D6 CH. VALVE UL	1	PZ	EL1437B0	ELETTROV. H2O JG D8-BARBED D6 VNR UL	1	PZ	GN1312A0	PASSACAVO GOMMA DE=26 DI=15 SP=10	1	PZ	GN1526A0	O-RING D.INT6.9 SP1.8	1	PZ	RC1019A0	FASCETTA ELASTICA D10 ZINCATA	10	PZ	RC1242A0	TERMINALE CHIUSO D10	2	PZ	RC1356A0	RACCORDO DRITTO FIL. FEMM 8X1/4 BSP	1	PZ	TB2820A0	TUBO EPDM 6X10	1.200	M	VI1220A1	VITE AUTOFILETTA NTE 4.2X11 TCS+ MARUTE	9	PZ	VL1019A0	POMPA VIBRAZIONE	1	PZ	VL1054B0	DISTRIBUTOR E INGRESSI LAVAGGIO ON	1	PZ	VL1064A0	DISTRIBUTOR E USCITE CIRCUITO LAVAGGIO PL	1	PZ	VL1065A1	PRESSOSTAT O.N.O. 1/4 M CI	1	PZ
Codice	Descrizione	Qtà	UM																																																																						
EL1422A1	ELETTROVALV 1 VIA RID.VERDE JG D8-D10 UL	1	PZ																																																																						
EL1426A0	ELETTROVALV OLA UL H2O JG D8-PORTAGO MMA D	1	PZ																																																																						
EL1426B0	ELETTROVALV OLA UL H2O JG D8-PORTAGO MMA D	1	PZ																																																																						
EL1437A0	EV H2O JG D8-PORTAGO MMA D6 CH. VALVE UL	1	PZ																																																																						
EL1437B0	ELETTROV. H2O JG D8-BARBED D6 VNR UL	1	PZ																																																																						
GN1312A0	PASSACAVO GOMMA DE=26 DI=15 SP=10	1	PZ																																																																						
GN1526A0	O-RING D.INT6.9 SP1.8	1	PZ																																																																						
RC1019A0	FASCETTA ELASTICA D10 ZINCATA	10	PZ																																																																						
RC1242A0	TERMINALE CHIUSO D10	2	PZ																																																																						
RC1356A0	RACCORDO DRITTO FIL. FEMM 8X1/4 BSP	1	PZ																																																																						
TB2820A0	TUBO EPDM 6X10	1.200	M																																																																						
VI1220A1	VITE AUTOFILETTA NTE 4.2X11 TCS+ MARUTE	9	PZ																																																																						
VL1019A0	POMPA VIBRAZIONE	1	PZ																																																																						
VL1054B0	DISTRIBUTOR E INGRESSI LAVAGGIO ON	1	PZ																																																																						
VL1064A0	DISTRIBUTOR E USCITE CIRCUITO LAVAGGIO PL	1	PZ																																																																						
VL1065A1	PRESSOSTAT O.N.O. 1/4 M CI	1	PZ																																																																						

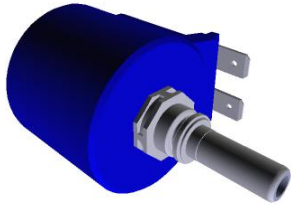
COMPONENTE			RICAMBIO																																																										
Codice	Descrizione	Immagine	Codice	Descrizione	Lista componenti																																																								
VL1019A	POMPA VIBRAZIONE		KVL1120A	KIT IMPIANTO LAVAGGIO PLUS COMPACT USA	<table border="1"> <thead> <tr> <th>Codice</th> <th>Descrizione</th> <th>Qtà</th> <th>UM</th> </tr> </thead> <tbody> <tr> <td>VL1102A1</td> <td>FILTRO IN LINEA DET. + VNR BARBED 6 MM</td> <td>1</td> <td>PZ</td> </tr> <tr> <td>VL1128A0</td> <td>VALVOLA VNR BARBED D6</td> <td>1</td> <td>PZ</td> </tr> <tr> <td>VM2172A0</td> <td>CLIP BLOCCAGGIO POMPA CON CIRCUITO</td> <td>1</td> <td>PZ</td> </tr> </tbody> </table>	Codice	Descrizione	Qtà	UM	VL1102A1	FILTRO IN LINEA DET. + VNR BARBED 6 MM	1	PZ	VL1128A0	VALVOLA VNR BARBED D6	1	PZ	VM2172A0	CLIP BLOCCAGGIO POMPA CON CIRCUITO	1	PZ																																								
Codice	Descrizione	Qtà	UM																																																										
VL1102A1	FILTRO IN LINEA DET. + VNR BARBED 6 MM	1	PZ																																																										
VL1128A0	VALVOLA VNR BARBED D6	1	PZ																																																										
VM2172A0	CLIP BLOCCAGGIO POMPA CON CIRCUITO	1	PZ																																																										
			KVL1119A	KIT IMPIANTO LAVAGGIO PLUS COMPACT EUR	<table border="1"> <thead> <tr> <th>Codice</th> <th>Descrizione</th> <th>Qtà</th> <th>UM</th> </tr> </thead> <tbody> <tr> <td>0H2143A0</td> <td>LAMIERA BLOCCA VNR VL1128</td> <td>1</td> <td>PZ</td> </tr> <tr> <td>0H7553D0</td> <td>LAMIERA CIRCUITO LAVAGGIO XECC PLUS</td> <td>1</td> <td>PZ</td> </tr> <tr> <td>EL1252A1</td> <td>ELETTROVALV OLA 1 VIA RID.VERDE JG D8-D10</td> <td>1</td> <td>PZ</td> </tr> <tr> <td>EL1424A0</td> <td>ELETTROVALV OLA H2O JG D8-PORTAGO MMA D6</td> <td>1</td> <td>PZ</td> </tr> <tr> <td>EL1424B0</td> <td>ELETTROVALV OLA H2O JG D8-PORTAGO MMA D6</td> <td>1</td> <td>PZ</td> </tr> <tr> <td>EL1436A0</td> <td>EV H2O JG D8-PORTAGO MMA D6 CHECK VALVE</td> <td>1</td> <td>PZ</td> </tr> <tr> <td>EL1436B0</td> <td>ELETTROV. H2O JG D8-BARBED D6 VNR</td> <td>1</td> <td>PZ</td> </tr> <tr> <td>GN1312A0</td> <td>PASSACAVO GOMMA DE=26 DI=15 SP=10</td> <td>1</td> <td>PZ</td> </tr> <tr> <td>GN1526A0</td> <td>O-RING D.INT6.9 SP1.8</td> <td>1</td> <td>PZ</td> </tr> <tr> <td>RC1019A0</td> <td>FASCETTA ELASTICA D10 ZINCATA</td> <td>11</td> <td>PZ</td> </tr> <tr> <td>RC1242A0</td> <td>TERMINALE CHIUSO D10</td> <td>2</td> <td>PZ</td> </tr> <tr> <td>RC1356A0</td> <td>RACCORDO DRITTO FIL. FEMM 8X1/4 BSP</td> <td>1</td> <td>PZ</td> </tr> <tr> <td>TB2820A0</td> <td>TUBO EPDM 6X10</td> <td>1.200</td> <td>M</td> </tr> </tbody> </table>	Codice	Descrizione	Qtà	UM	0H2143A0	LAMIERA BLOCCA VNR VL1128	1	PZ	0H7553D0	LAMIERA CIRCUITO LAVAGGIO XECC PLUS	1	PZ	EL1252A1	ELETTROVALV OLA 1 VIA RID.VERDE JG D8-D10	1	PZ	EL1424A0	ELETTROVALV OLA H2O JG D8-PORTAGO MMA D6	1	PZ	EL1424B0	ELETTROVALV OLA H2O JG D8-PORTAGO MMA D6	1	PZ	EL1436A0	EV H2O JG D8-PORTAGO MMA D6 CHECK VALVE	1	PZ	EL1436B0	ELETTROV. H2O JG D8-BARBED D6 VNR	1	PZ	GN1312A0	PASSACAVO GOMMA DE=26 DI=15 SP=10	1	PZ	GN1526A0	O-RING D.INT6.9 SP1.8	1	PZ	RC1019A0	FASCETTA ELASTICA D10 ZINCATA	11	PZ	RC1242A0	TERMINALE CHIUSO D10	2	PZ	RC1356A0	RACCORDO DRITTO FIL. FEMM 8X1/4 BSP	1	PZ	TB2820A0	TUBO EPDM 6X10	1.200	M
Codice	Descrizione	Qtà	UM																																																										
0H2143A0	LAMIERA BLOCCA VNR VL1128	1	PZ																																																										
0H7553D0	LAMIERA CIRCUITO LAVAGGIO XECC PLUS	1	PZ																																																										
EL1252A1	ELETTROVALV OLA 1 VIA RID.VERDE JG D8-D10	1	PZ																																																										
EL1424A0	ELETTROVALV OLA H2O JG D8-PORTAGO MMA D6	1	PZ																																																										
EL1424B0	ELETTROVALV OLA H2O JG D8-PORTAGO MMA D6	1	PZ																																																										
EL1436A0	EV H2O JG D8-PORTAGO MMA D6 CHECK VALVE	1	PZ																																																										
EL1436B0	ELETTROV. H2O JG D8-BARBED D6 VNR	1	PZ																																																										
GN1312A0	PASSACAVO GOMMA DE=26 DI=15 SP=10	1	PZ																																																										
GN1526A0	O-RING D.INT6.9 SP1.8	1	PZ																																																										
RC1019A0	FASCETTA ELASTICA D10 ZINCATA	11	PZ																																																										
RC1242A0	TERMINALE CHIUSO D10	2	PZ																																																										
RC1356A0	RACCORDO DRITTO FIL. FEMM 8X1/4 BSP	1	PZ																																																										
TB2820A0	TUBO EPDM 6X10	1.200	M																																																										

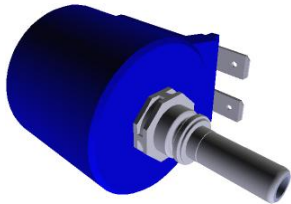
COMPONENTE			RICAMBIO																																										
Codice	Descrizione	Immagine	Codice	Descrizione	Lista componenti																																								
VL1019A	POMPA VIBRAZIONE		KVL1119A	KIT IMPIANTO LAVAGGIO PLUS COMPACT EUR	<table border="1"> <thead> <tr> <th>Codice</th> <th>Descrizione</th> <th>Qtà</th> <th>UM</th> </tr> </thead> <tbody> <tr> <td>VI1220A1</td> <td>VITE AUTOFILETTA NTE 4.2X11 TCS+ MARUTE</td> <td>16</td> <td>PZ</td> </tr> <tr> <td>VL1019A0</td> <td>POMPA VIBRAZIONE</td> <td>1</td> <td>PZ</td> </tr> <tr> <td>VL1054B0</td> <td>DISTRIBUTOR E INGRESSI LAVAGGIO ON</td> <td>1</td> <td>PZ</td> </tr> <tr> <td>VL1064A0</td> <td>DISTRIBUTOR E USCITE CIRCUITO LAVAGGIO PL</td> <td>1</td> <td>PZ</td> </tr> <tr> <td>VL1065A1</td> <td>PRESSOSTAT O.N.O. 1/4 M.CI</td> <td>1</td> <td>PZ</td> </tr> <tr> <td>VL1102A1</td> <td>FILTRO IN LINEA DET. + VNR BARBED 6 MM</td> <td>1</td> <td>PZ</td> </tr> <tr> <td>VL1128A0</td> <td>VALVOLA VNR BARBED D6</td> <td>1</td> <td>PZ</td> </tr> <tr> <td>VM2172A0</td> <td>CLIP BLOCCAGGIO POMPA CON CIRCUITO</td> <td>1</td> <td>PZ</td> </tr> </tbody> </table>	Codice	Descrizione	Qtà	UM	VI1220A1	VITE AUTOFILETTA NTE 4.2X11 TCS+ MARUTE	16	PZ	VL1019A0	POMPA VIBRAZIONE	1	PZ	VL1054B0	DISTRIBUTOR E INGRESSI LAVAGGIO ON	1	PZ	VL1064A0	DISTRIBUTOR E USCITE CIRCUITO LAVAGGIO PL	1	PZ	VL1065A1	PRESSOSTAT O.N.O. 1/4 M.CI	1	PZ	VL1102A1	FILTRO IN LINEA DET. + VNR BARBED 6 MM	1	PZ	VL1128A0	VALVOLA VNR BARBED D6	1	PZ	VM2172A0	CLIP BLOCCAGGIO POMPA CON CIRCUITO	1	PZ				
Codice	Descrizione	Qtà	UM																																										
VI1220A1	VITE AUTOFILETTA NTE 4.2X11 TCS+ MARUTE	16	PZ																																										
VL1019A0	POMPA VIBRAZIONE	1	PZ																																										
VL1054B0	DISTRIBUTOR E INGRESSI LAVAGGIO ON	1	PZ																																										
VL1064A0	DISTRIBUTOR E USCITE CIRCUITO LAVAGGIO PL	1	PZ																																										
VL1065A1	PRESSOSTAT O.N.O. 1/4 M.CI	1	PZ																																										
VL1102A1	FILTRO IN LINEA DET. + VNR BARBED 6 MM	1	PZ																																										
VL1128A0	VALVOLA VNR BARBED D6	1	PZ																																										
VM2172A0	CLIP BLOCCAGGIO POMPA CON CIRCUITO	1	PZ																																										
			KVL1118A	KIT IMPIANTO LAVAGGIO ONE COMPACT EUR	<table border="1"> <thead> <tr> <th>Codice</th> <th>Descrizione</th> <th>Qtà</th> <th>UM</th> </tr> </thead> <tbody> <tr> <td>0H2143A0</td> <td>LAMIERA BLOCCA VNR VL1128</td> <td>1</td> <td>PZ</td> </tr> <tr> <td>0H7173C0</td> <td>LAMIERA CIRCUITO LAVAGGIO XECC ONE</td> <td>1</td> <td>PZ</td> </tr> <tr> <td>EL1436A0</td> <td>EV H2O JG D8-PORTAGO MMA D6 CHECK VALVE</td> <td>1</td> <td>PZ</td> </tr> <tr> <td>EL1436B0</td> <td>ELETTROV. H2O JG D8-BARBED D6 VNR</td> <td>1</td> <td>PZ</td> </tr> <tr> <td>GN1526A0</td> <td>O-RING D.INT6.9 SP1.8</td> <td>1</td> <td>PZ</td> </tr> <tr> <td>RC1019A0</td> <td>FASCETTA ELASTICA D10 ZINCATA</td> <td>12</td> <td>PZ</td> </tr> <tr> <td>RC1242A0</td> <td>TERMINALE CHIUSO D10</td> <td>2</td> <td>PZ</td> </tr> <tr> <td>TB2820A0</td> <td>TUBO EPDM 6X10</td> <td>1.200</td> <td>M</td> </tr> <tr> <td>VI1220A1</td> <td>VITE AUTOFILETTA NTE 4.2X11 TCS+ MARUTE</td> <td>6</td> <td>PZ</td> </tr> </tbody> </table>	Codice	Descrizione	Qtà	UM	0H2143A0	LAMIERA BLOCCA VNR VL1128	1	PZ	0H7173C0	LAMIERA CIRCUITO LAVAGGIO XECC ONE	1	PZ	EL1436A0	EV H2O JG D8-PORTAGO MMA D6 CHECK VALVE	1	PZ	EL1436B0	ELETTROV. H2O JG D8-BARBED D6 VNR	1	PZ	GN1526A0	O-RING D.INT6.9 SP1.8	1	PZ	RC1019A0	FASCETTA ELASTICA D10 ZINCATA	12	PZ	RC1242A0	TERMINALE CHIUSO D10	2	PZ	TB2820A0	TUBO EPDM 6X10	1.200	M	VI1220A1	VITE AUTOFILETTA NTE 4.2X11 TCS+ MARUTE	6	PZ
Codice	Descrizione	Qtà	UM																																										
0H2143A0	LAMIERA BLOCCA VNR VL1128	1	PZ																																										
0H7173C0	LAMIERA CIRCUITO LAVAGGIO XECC ONE	1	PZ																																										
EL1436A0	EV H2O JG D8-PORTAGO MMA D6 CHECK VALVE	1	PZ																																										
EL1436B0	ELETTROV. H2O JG D8-BARBED D6 VNR	1	PZ																																										
GN1526A0	O-RING D.INT6.9 SP1.8	1	PZ																																										
RC1019A0	FASCETTA ELASTICA D10 ZINCATA	12	PZ																																										
RC1242A0	TERMINALE CHIUSO D10	2	PZ																																										
TB2820A0	TUBO EPDM 6X10	1.200	M																																										
VI1220A1	VITE AUTOFILETTA NTE 4.2X11 TCS+ MARUTE	6	PZ																																										

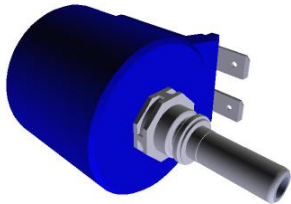
<b>COMPONENTE</b>			<b>RICAMBIO</b>																																																										
<i>Codice</i>	<i>Descrizione</i>	<i>Immagine</i>	<i>Codice</i>	<i>Descrizione</i>	<i>Lista componenti</i>																																																								
VL1019A	POMPA VIBRAZIONE		KVL1118A	KIT IMPIANTO LAVAGGIO ONE COMPACT EUR	<table border="1"> <thead> <tr> <th><i>Codice</i></th> <th><i>Descrizione</i></th> <th><i>Qtà</i></th> <th><i>UM</i></th> </tr> </thead> <tbody> <tr> <td>VL1019A0</td> <td>POMPA VIBRAZIONE</td> <td>1</td> <td>PZ</td> </tr> <tr> <td>VL1053B0</td> <td>DISTRIBUTOR E USCITA LAVAGGIO ON</td> <td>1</td> <td>PZ</td> </tr> <tr> <td>VL1054B0</td> <td>DISTRIBUTOR E INGRESSI LAVAGGIO ON</td> <td>1</td> <td>PZ</td> </tr> <tr> <td>VL1102A1</td> <td>FILTRO IN LINEA DET. + VNR BARBED 6 MM</td> <td>1</td> <td>PZ</td> </tr> <tr> <td>VL1128A0</td> <td>VALVOLA VNR BARBED D6</td> <td>1</td> <td>PZ</td> </tr> <tr> <td>VM2172A0</td> <td>CLIP BLOCCAGGIO POMPA CON CIRCUITO</td> <td>1</td> <td>PZ</td> </tr> </tbody> </table>	<i>Codice</i>	<i>Descrizione</i>	<i>Qtà</i>	<i>UM</i>	VL1019A0	POMPA VIBRAZIONE	1	PZ	VL1053B0	DISTRIBUTOR E USCITA LAVAGGIO ON	1	PZ	VL1054B0	DISTRIBUTOR E INGRESSI LAVAGGIO ON	1	PZ	VL1102A1	FILTRO IN LINEA DET. + VNR BARBED 6 MM	1	PZ	VL1128A0	VALVOLA VNR BARBED D6	1	PZ	VM2172A0	CLIP BLOCCAGGIO POMPA CON CIRCUITO	1	PZ																												
<i>Codice</i>	<i>Descrizione</i>	<i>Qtà</i>	<i>UM</i>																																																										
VL1019A0	POMPA VIBRAZIONE	1	PZ																																																										
VL1053B0	DISTRIBUTOR E USCITA LAVAGGIO ON	1	PZ																																																										
VL1054B0	DISTRIBUTOR E INGRESSI LAVAGGIO ON	1	PZ																																																										
VL1102A1	FILTRO IN LINEA DET. + VNR BARBED 6 MM	1	PZ																																																										
VL1128A0	VALVOLA VNR BARBED D6	1	PZ																																																										
VM2172A0	CLIP BLOCCAGGIO POMPA CON CIRCUITO	1	PZ																																																										
			KVL1109A	KIT IMPIANTO LAVAGGIO ONE 2 GIRANTI EUR	<table border="1"> <thead> <tr> <th><i>Codice</i></th> <th><i>Descrizione</i></th> <th><i>Qtà</i></th> <th><i>UM</i></th> </tr> </thead> <tbody> <tr> <td>0H2143A0</td> <td>LAMIERA BLOCCA VNR VL1128</td> <td>2</td> <td>PZ</td> </tr> <tr> <td>0H7324A0</td> <td>LAMIERA SUPPORTO LAVAGGIO ON</td> <td>2</td> <td>PZ</td> </tr> <tr> <td>0H7515A0</td> <td>LAMIERA DOPPIO LAVAGGIO XEVC-2011-E1</td> <td>1</td> <td>PZ</td> </tr> <tr> <td>CH1000A0</td> <td>TAGLIATUBI SNIP</td> <td>1</td> <td>PZ</td> </tr> <tr> <td>EL1115A0</td> <td>RACCORDO A Y Ø8 FEMMINA</td> <td>1</td> <td>PZ</td> </tr> <tr> <td>EL1436A0</td> <td>EV H2O JG D8-PORTAGO MMA D6 CHECK VALVE</td> <td>2</td> <td>PZ</td> </tr> <tr> <td>EL1436B0</td> <td>ELETTROV. H2O JG D8-BARBED D6 VNR</td> <td>2</td> <td>PZ</td> </tr> <tr> <td>GN1526A0</td> <td>O-RING D.INT6.9 SP1.8</td> <td>2</td> <td>PZ</td> </tr> <tr> <td>RC1006A0</td> <td>CURVA GUIDA TUBO PET D8</td> <td>4</td> <td>PZ</td> </tr> <tr> <td>RC1019A0</td> <td>FASCETTA ELASTICA D10 ZINCATA</td> <td>26</td> <td>PZ</td> </tr> <tr> <td>RC1242A0</td> <td>TERMINALE CHIUSO D10</td> <td>4</td> <td>PZ</td> </tr> <tr> <td>TB1818A0</td> <td>TUBO JG Ø8 PE BLU</td> <td>1.640</td> <td>M</td> </tr> <tr> <td>TB2820A0</td> <td>TUBO EPDM 6X10</td> <td>3.940</td> <td>M</td> </tr> </tbody> </table>	<i>Codice</i>	<i>Descrizione</i>	<i>Qtà</i>	<i>UM</i>	0H2143A0	LAMIERA BLOCCA VNR VL1128	2	PZ	0H7324A0	LAMIERA SUPPORTO LAVAGGIO ON	2	PZ	0H7515A0	LAMIERA DOPPIO LAVAGGIO XEVC-2011-E1	1	PZ	CH1000A0	TAGLIATUBI SNIP	1	PZ	EL1115A0	RACCORDO A Y Ø8 FEMMINA	1	PZ	EL1436A0	EV H2O JG D8-PORTAGO MMA D6 CHECK VALVE	2	PZ	EL1436B0	ELETTROV. H2O JG D8-BARBED D6 VNR	2	PZ	GN1526A0	O-RING D.INT6.9 SP1.8	2	PZ	RC1006A0	CURVA GUIDA TUBO PET D8	4	PZ	RC1019A0	FASCETTA ELASTICA D10 ZINCATA	26	PZ	RC1242A0	TERMINALE CHIUSO D10	4	PZ	TB1818A0	TUBO JG Ø8 PE BLU	1.640	M	TB2820A0	TUBO EPDM 6X10	3.940	M
<i>Codice</i>	<i>Descrizione</i>	<i>Qtà</i>	<i>UM</i>																																																										
0H2143A0	LAMIERA BLOCCA VNR VL1128	2	PZ																																																										
0H7324A0	LAMIERA SUPPORTO LAVAGGIO ON	2	PZ																																																										
0H7515A0	LAMIERA DOPPIO LAVAGGIO XEVC-2011-E1	1	PZ																																																										
CH1000A0	TAGLIATUBI SNIP	1	PZ																																																										
EL1115A0	RACCORDO A Y Ø8 FEMMINA	1	PZ																																																										
EL1436A0	EV H2O JG D8-PORTAGO MMA D6 CHECK VALVE	2	PZ																																																										
EL1436B0	ELETTROV. H2O JG D8-BARBED D6 VNR	2	PZ																																																										
GN1526A0	O-RING D.INT6.9 SP1.8	2	PZ																																																										
RC1006A0	CURVA GUIDA TUBO PET D8	4	PZ																																																										
RC1019A0	FASCETTA ELASTICA D10 ZINCATA	26	PZ																																																										
RC1242A0	TERMINALE CHIUSO D10	4	PZ																																																										
TB1818A0	TUBO JG Ø8 PE BLU	1.640	M																																																										
TB2820A0	TUBO EPDM 6X10	3.940	M																																																										

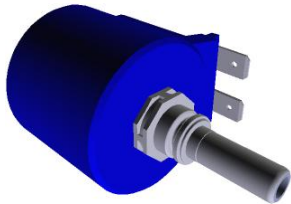
COMPONENTE			RICAMBIO																																																		
Codice	Descrizione	Immagine	Codice	Descrizione	Lista componenti																																																
VL1019A	POMPA VIBRAZIONE		KVL1109A	KIT IMPIANTO LAVAGGIO ONE 2 GIRANTI EUR	<table border="1"> <thead> <tr> <th>Codice</th> <th>Descrizione</th> <th>Qtà</th> <th>UM</th> </tr> </thead> <tbody> <tr> <td>VI1220A1</td> <td>VITE AUTOFILETTA NTE 4.2X11 TCS+ MARUTE</td> <td>8</td> <td>PZ</td> </tr> <tr> <td>VL1019A0</td> <td>POMPA VIBRAZIONE</td> <td>2</td> <td>PZ</td> </tr> <tr> <td>VL1053B0</td> <td>DISTRIBUTOR E USCITA LAVAGGIO ON</td> <td>2</td> <td>PZ</td> </tr> <tr> <td>VL1054B0</td> <td>DISTRIBUTOR E INGRESSI LAVAGGIO ON</td> <td>2</td> <td>PZ</td> </tr> <tr> <td>VL1102A1</td> <td>FILTRO IN LINEA DET. + VNR BARBED 6 MM</td> <td>2</td> <td>PZ</td> </tr> <tr> <td>VL1128A0</td> <td>VALVOLA VNR BARBED D6</td> <td>2</td> <td>PZ</td> </tr> <tr> <td>VM2172A0</td> <td>CLIP BLOCCAGGIO POMPA CON CIRCUITO</td> <td>2</td> <td>PZ</td> </tr> </tbody> </table>	Codice	Descrizione	Qtà	UM	VI1220A1	VITE AUTOFILETTA NTE 4.2X11 TCS+ MARUTE	8	PZ	VL1019A0	POMPA VIBRAZIONE	2	PZ	VL1053B0	DISTRIBUTOR E USCITA LAVAGGIO ON	2	PZ	VL1054B0	DISTRIBUTOR E INGRESSI LAVAGGIO ON	2	PZ	VL1102A1	FILTRO IN LINEA DET. + VNR BARBED 6 MM	2	PZ	VL1128A0	VALVOLA VNR BARBED D6	2	PZ	VM2172A0	CLIP BLOCCAGGIO POMPA CON CIRCUITO	2	PZ																
Codice	Descrizione	Qtà	UM																																																		
VI1220A1	VITE AUTOFILETTA NTE 4.2X11 TCS+ MARUTE	8	PZ																																																		
VL1019A0	POMPA VIBRAZIONE	2	PZ																																																		
VL1053B0	DISTRIBUTOR E USCITA LAVAGGIO ON	2	PZ																																																		
VL1054B0	DISTRIBUTOR E INGRESSI LAVAGGIO ON	2	PZ																																																		
VL1102A1	FILTRO IN LINEA DET. + VNR BARBED 6 MM	2	PZ																																																		
VL1128A0	VALVOLA VNR BARBED D6	2	PZ																																																		
VM2172A0	CLIP BLOCCAGGIO POMPA CON CIRCUITO	2	PZ																																																		
			KVL1108A	KIT IMPIANTO LAVAGGIO ONE 04EU 1 GIR EUR	<table border="1"> <thead> <tr> <th>Codice</th> <th>Descrizione</th> <th>Qtà</th> <th>UM</th> </tr> </thead> <tbody> <tr> <td>0H2143A0</td> <td>LAMIERA BLOCCA VNR VL1128</td> <td>1</td> <td>PZ</td> </tr> <tr> <td>0H7511A0</td> <td>LAMIERA SUPPORTO LAVAGGIO ON</td> <td>1</td> <td>PZ</td> </tr> <tr> <td>EL1436A0</td> <td>EV H2O JG D8-PORTAGO MMA D6 CHECK VALVE</td> <td>1</td> <td>PZ</td> </tr> <tr> <td>EL1436B0</td> <td>ELETTROV. H2O JG D8-BARBED D6 VNR</td> <td>1</td> <td>PZ</td> </tr> <tr> <td>GN1526A0</td> <td>O-RING D.INT6.9 SP1.8</td> <td>1</td> <td>PZ</td> </tr> <tr> <td>RC1006A0</td> <td>CURVA GUIDA TUBO PET D8</td> <td>2</td> <td>PZ</td> </tr> <tr> <td>RC1019A0</td> <td>FASCETTA ELASTICA D10 ZINCATA</td> <td>17</td> <td>PZ</td> </tr> <tr> <td>RC1242A0</td> <td>TERMINALE CHIUSO D10</td> <td>2</td> <td>PZ</td> </tr> <tr> <td>TB1818A0</td> <td>TUBO JG Ø8 PE BLU</td> <td>0.320</td> <td>M</td> </tr> <tr> <td>TB2820A0</td> <td>TUBO EPDM 6X10</td> <td>1.380</td> <td>M</td> </tr> <tr> <td>VI1220A1</td> <td>VITE AUTOFILETTA NTE 4.2X11 TCS+ MARUTE</td> <td>1</td> <td>PZ</td> </tr> </tbody> </table>	Codice	Descrizione	Qtà	UM	0H2143A0	LAMIERA BLOCCA VNR VL1128	1	PZ	0H7511A0	LAMIERA SUPPORTO LAVAGGIO ON	1	PZ	EL1436A0	EV H2O JG D8-PORTAGO MMA D6 CHECK VALVE	1	PZ	EL1436B0	ELETTROV. H2O JG D8-BARBED D6 VNR	1	PZ	GN1526A0	O-RING D.INT6.9 SP1.8	1	PZ	RC1006A0	CURVA GUIDA TUBO PET D8	2	PZ	RC1019A0	FASCETTA ELASTICA D10 ZINCATA	17	PZ	RC1242A0	TERMINALE CHIUSO D10	2	PZ	TB1818A0	TUBO JG Ø8 PE BLU	0.320	M	TB2820A0	TUBO EPDM 6X10	1.380	M	VI1220A1	VITE AUTOFILETTA NTE 4.2X11 TCS+ MARUTE	1	PZ
Codice	Descrizione	Qtà	UM																																																		
0H2143A0	LAMIERA BLOCCA VNR VL1128	1	PZ																																																		
0H7511A0	LAMIERA SUPPORTO LAVAGGIO ON	1	PZ																																																		
EL1436A0	EV H2O JG D8-PORTAGO MMA D6 CHECK VALVE	1	PZ																																																		
EL1436B0	ELETTROV. H2O JG D8-BARBED D6 VNR	1	PZ																																																		
GN1526A0	O-RING D.INT6.9 SP1.8	1	PZ																																																		
RC1006A0	CURVA GUIDA TUBO PET D8	2	PZ																																																		
RC1019A0	FASCETTA ELASTICA D10 ZINCATA	17	PZ																																																		
RC1242A0	TERMINALE CHIUSO D10	2	PZ																																																		
TB1818A0	TUBO JG Ø8 PE BLU	0.320	M																																																		
TB2820A0	TUBO EPDM 6X10	1.380	M																																																		
VI1220A1	VITE AUTOFILETTA NTE 4.2X11 TCS+ MARUTE	1	PZ																																																		

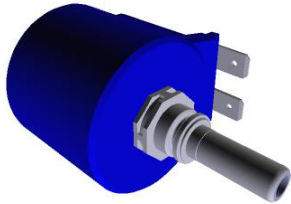
COMPONENTE			RICAMBIO																																																														
Codice	Descrizione	Immagine	Codice	Descrizione	Lista componenti																																																												
VL1019A	POMPA VIBRAZIONE		KVL1108A	KIT IMPIANTO LAVAGGIO ONE 04EU 1 GIR EUR	<table border="1"> <thead> <tr> <th>Codice</th> <th>Descrizione</th> <th>Qtà</th> <th>UM</th> </tr> </thead> <tbody> <tr> <td>VL1019A0</td> <td>POMPA VIBRAZIONE</td> <td>2</td> <td>PZ</td> </tr> <tr> <td>VL1053B0</td> <td>DISTRIBUTOR E USCITA LAVAGGIO ON</td> <td>1</td> <td>PZ</td> </tr> <tr> <td>VL1054B0</td> <td>DISTRIBUTOR E INGRESSI LAVAGGIO ON</td> <td>1</td> <td>PZ</td> </tr> <tr> <td>VL1128A0</td> <td>VALVOLA VNR BARBED D6</td> <td>1</td> <td>PZ</td> </tr> <tr> <td>VM2172A0</td> <td>CLIP BLOCCAGGIO POMPA CON CIRCUITO</td> <td>1</td> <td>PZ</td> </tr> </tbody> </table>	Codice	Descrizione	Qtà	UM	VL1019A0	POMPA VIBRAZIONE	2	PZ	VL1053B0	DISTRIBUTOR E USCITA LAVAGGIO ON	1	PZ	VL1054B0	DISTRIBUTOR E INGRESSI LAVAGGIO ON	1	PZ	VL1128A0	VALVOLA VNR BARBED D6	1	PZ	VM2172A0	CLIP BLOCCAGGIO POMPA CON CIRCUITO	1	PZ																																				
Codice	Descrizione	Qtà	UM																																																														
VL1019A0	POMPA VIBRAZIONE	2	PZ																																																														
VL1053B0	DISTRIBUTOR E USCITA LAVAGGIO ON	1	PZ																																																														
VL1054B0	DISTRIBUTOR E INGRESSI LAVAGGIO ON	1	PZ																																																														
VL1128A0	VALVOLA VNR BARBED D6	1	PZ																																																														
VM2172A0	CLIP BLOCCAGGIO POMPA CON CIRCUITO	1	PZ																																																														
			KVL1106A	KIT IMPIANTO LAVAGGIO ONE 1 GIRANTE EUR	<table border="1"> <thead> <tr> <th>Codice</th> <th>Descrizione</th> <th>Qtà</th> <th>UM</th> </tr> </thead> <tbody> <tr> <td>0H2143A0</td> <td>LAMIERA BLOCCA VNR VL1128</td> <td>1</td> <td>PZ</td> </tr> <tr> <td>0H7819A0</td> <td>SUPPORTO LAVAGGIO ONE CON ELV STEAM</td> <td>1</td> <td>PZ</td> </tr> <tr> <td>EL1436A0</td> <td>EV H2O JG D8-PORTAGO MMA D6 CHECK VALVE</td> <td>1</td> <td>PZ</td> </tr> <tr> <td>EL1436B0</td> <td>ELETTROV. H2O JG D8-BARBED D6 VNR</td> <td>1</td> <td>PZ</td> </tr> <tr> <td>GN1526A0</td> <td>O-RING D.INT6.9 SP1.8</td> <td>1</td> <td>PZ</td> </tr> <tr> <td>RC1242A0</td> <td>TERMINALE CHIUSO D10</td> <td>2</td> <td>PZ</td> </tr> <tr> <td>TB2820A0</td> <td>TUBO EPDM 6X10</td> <td>1.420</td> <td>M</td> </tr> <tr> <td>VI1220A1</td> <td>VITE AUTOFILETTA NTE 4.2X11 TCS+ MARLITE</td> <td>1</td> <td>PZ</td> </tr> <tr> <td>VL1019A0</td> <td>POMPA VIBRAZIONE</td> <td>1</td> <td>PZ</td> </tr> <tr> <td>VL1053B0</td> <td>DISTRIBUTOR E USCITA LAVAGGIO ON</td> <td>1</td> <td>PZ</td> </tr> <tr> <td>VL1054B0</td> <td>DISTRIBUTOR E INGRESSI LAVAGGIO ON</td> <td>1</td> <td>PZ</td> </tr> <tr> <td>VL1102A1</td> <td>FILTRO IN LINEA DET. + VNR BARBED 6 MM</td> <td>1</td> <td>PZ</td> </tr> <tr> <td>VL1128A0</td> <td>VALVOLA VNR BARBED D6</td> <td>1</td> <td>PZ</td> </tr> <tr> <td>VM2172A0</td> <td>CLIP BLOCCAGGIO POMPA CON CIRCUITO</td> <td>1</td> <td>PZ</td> </tr> </tbody> </table>	Codice	Descrizione	Qtà	UM	0H2143A0	LAMIERA BLOCCA VNR VL1128	1	PZ	0H7819A0	SUPPORTO LAVAGGIO ONE CON ELV STEAM	1	PZ	EL1436A0	EV H2O JG D8-PORTAGO MMA D6 CHECK VALVE	1	PZ	EL1436B0	ELETTROV. H2O JG D8-BARBED D6 VNR	1	PZ	GN1526A0	O-RING D.INT6.9 SP1.8	1	PZ	RC1242A0	TERMINALE CHIUSO D10	2	PZ	TB2820A0	TUBO EPDM 6X10	1.420	M	VI1220A1	VITE AUTOFILETTA NTE 4.2X11 TCS+ MARLITE	1	PZ	VL1019A0	POMPA VIBRAZIONE	1	PZ	VL1053B0	DISTRIBUTOR E USCITA LAVAGGIO ON	1	PZ	VL1054B0	DISTRIBUTOR E INGRESSI LAVAGGIO ON	1	PZ	VL1102A1	FILTRO IN LINEA DET. + VNR BARBED 6 MM	1	PZ	VL1128A0	VALVOLA VNR BARBED D6	1	PZ	VM2172A0	CLIP BLOCCAGGIO POMPA CON CIRCUITO	1	PZ
Codice	Descrizione	Qtà	UM																																																														
0H2143A0	LAMIERA BLOCCA VNR VL1128	1	PZ																																																														
0H7819A0	SUPPORTO LAVAGGIO ONE CON ELV STEAM	1	PZ																																																														
EL1436A0	EV H2O JG D8-PORTAGO MMA D6 CHECK VALVE	1	PZ																																																														
EL1436B0	ELETTROV. H2O JG D8-BARBED D6 VNR	1	PZ																																																														
GN1526A0	O-RING D.INT6.9 SP1.8	1	PZ																																																														
RC1242A0	TERMINALE CHIUSO D10	2	PZ																																																														
TB2820A0	TUBO EPDM 6X10	1.420	M																																																														
VI1220A1	VITE AUTOFILETTA NTE 4.2X11 TCS+ MARLITE	1	PZ																																																														
VL1019A0	POMPA VIBRAZIONE	1	PZ																																																														
VL1053B0	DISTRIBUTOR E USCITA LAVAGGIO ON	1	PZ																																																														
VL1054B0	DISTRIBUTOR E INGRESSI LAVAGGIO ON	1	PZ																																																														
VL1102A1	FILTRO IN LINEA DET. + VNR BARBED 6 MM	1	PZ																																																														
VL1128A0	VALVOLA VNR BARBED D6	1	PZ																																																														
VM2172A0	CLIP BLOCCAGGIO POMPA CON CIRCUITO	1	PZ																																																														

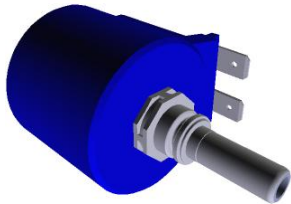

COMPONENTE			RICAMBIO																																																																						
Codice	Descrizione	Immagine	Codice	Descrizione	Lista componenti																																																																				
VL1019A	POMPA VIBRAZIONE		KVL1105A	KIT IMPIANTO LAVAGGIO PLUS 2 GIRANTI USA	<table border="1"> <thead> <tr> <th>Codice</th> <th>Descrizione</th> <th>Qtà</th> <th>UM</th> </tr> </thead> <tbody> <tr> <td>0H2143A0</td> <td>LAMIERA BLOCCA VNR VL1128</td> <td>1</td> <td>PZ</td> </tr> <tr> <td>0H7820A0</td> <td>SUPPORTO LAVAGGIO PLUS CON ELV STEAM</td> <td>1</td> <td>PZ</td> </tr> <tr> <td>EL1422A1</td> <td>ELETTROVALV 1 VIA RID.VERDE JG D8-D10 UL</td> <td>1</td> <td>PZ</td> </tr> <tr> <td>EL1426A0</td> <td>ELETTROVALV OLA UL H2O JG D8-PORTAGO MMA D</td> <td>2</td> <td>PZ</td> </tr> <tr> <td>EL1426B0</td> <td>ELETTROVALV OLA UL H2O JG D8-PORTAGO MMA D</td> <td>2</td> <td>PZ</td> </tr> <tr> <td>EL1437A0</td> <td>EV H2O JG D8-PORTAGO MMA D6 CH. VALVE UL</td> <td>1</td> <td>PZ</td> </tr> <tr> <td>EL1437B0</td> <td>ELETTROV. H2O JG D8-BARBED D6 VNR UL</td> <td>1</td> <td>PZ</td> </tr> <tr> <td>GN1526A0</td> <td>O-RING D.INT6.9 SP1.8</td> <td>1</td> <td>PZ</td> </tr> <tr> <td>RC1019A0</td> <td>FASCETTA ELASTICA D10 ZINCATA</td> <td>12</td> <td>PZ</td> </tr> <tr> <td>RC1130A0</td> <td>FASCETTA 130X2,6</td> <td>1</td> <td>PZ</td> </tr> <tr> <td>RC1242A0</td> <td>TERMINALE CHIUSO D10</td> <td>2</td> <td>PZ</td> </tr> <tr> <td>RC1356A0</td> <td>RACCORDO DRITTO FIL. FEMM 8X1/4 BSP</td> <td>1</td> <td>PZ</td> </tr> <tr> <td>TB2820A0</td> <td>TUBO EPDM 6X10</td> <td>1.410</td> <td>M</td> </tr> <tr> <td>VI1220A1</td> <td>VITE AUTOFILETTA NTE 4.2X11 TCS+ MARUTE</td> <td>3</td> <td>PZ</td> </tr> <tr> <td>VL1019A0</td> <td>POMPA VIBRAZIONE</td> <td>1</td> <td>PZ</td> </tr> <tr> <td>VL1065A1</td> <td>PRESSOSTAT O.N.O. 1/4 M CI</td> <td>1</td> <td>PZ</td> </tr> </tbody> </table>	Codice	Descrizione	Qtà	UM	0H2143A0	LAMIERA BLOCCA VNR VL1128	1	PZ	0H7820A0	SUPPORTO LAVAGGIO PLUS CON ELV STEAM	1	PZ	EL1422A1	ELETTROVALV 1 VIA RID.VERDE JG D8-D10 UL	1	PZ	EL1426A0	ELETTROVALV OLA UL H2O JG D8-PORTAGO MMA D	2	PZ	EL1426B0	ELETTROVALV OLA UL H2O JG D8-PORTAGO MMA D	2	PZ	EL1437A0	EV H2O JG D8-PORTAGO MMA D6 CH. VALVE UL	1	PZ	EL1437B0	ELETTROV. H2O JG D8-BARBED D6 VNR UL	1	PZ	GN1526A0	O-RING D.INT6.9 SP1.8	1	PZ	RC1019A0	FASCETTA ELASTICA D10 ZINCATA	12	PZ	RC1130A0	FASCETTA 130X2,6	1	PZ	RC1242A0	TERMINALE CHIUSO D10	2	PZ	RC1356A0	RACCORDO DRITTO FIL. FEMM 8X1/4 BSP	1	PZ	TB2820A0	TUBO EPDM 6X10	1.410	M	VI1220A1	VITE AUTOFILETTA NTE 4.2X11 TCS+ MARUTE	3	PZ	VL1019A0	POMPA VIBRAZIONE	1	PZ	VL1065A1	PRESSOSTAT O.N.O. 1/4 M CI	1	PZ
Codice	Descrizione	Qtà	UM																																																																						
0H2143A0	LAMIERA BLOCCA VNR VL1128	1	PZ																																																																						
0H7820A0	SUPPORTO LAVAGGIO PLUS CON ELV STEAM	1	PZ																																																																						
EL1422A1	ELETTROVALV 1 VIA RID.VERDE JG D8-D10 UL	1	PZ																																																																						
EL1426A0	ELETTROVALV OLA UL H2O JG D8-PORTAGO MMA D	2	PZ																																																																						
EL1426B0	ELETTROVALV OLA UL H2O JG D8-PORTAGO MMA D	2	PZ																																																																						
EL1437A0	EV H2O JG D8-PORTAGO MMA D6 CH. VALVE UL	1	PZ																																																																						
EL1437B0	ELETTROV. H2O JG D8-BARBED D6 VNR UL	1	PZ																																																																						
GN1526A0	O-RING D.INT6.9 SP1.8	1	PZ																																																																						
RC1019A0	FASCETTA ELASTICA D10 ZINCATA	12	PZ																																																																						
RC1130A0	FASCETTA 130X2,6	1	PZ																																																																						
RC1242A0	TERMINALE CHIUSO D10	2	PZ																																																																						
RC1356A0	RACCORDO DRITTO FIL. FEMM 8X1/4 BSP	1	PZ																																																																						
TB2820A0	TUBO EPDM 6X10	1.410	M																																																																						
VI1220A1	VITE AUTOFILETTA NTE 4.2X11 TCS+ MARUTE	3	PZ																																																																						
VL1019A0	POMPA VIBRAZIONE	1	PZ																																																																						
VL1065A1	PRESSOSTAT O.N.O. 1/4 M CI	1	PZ																																																																						

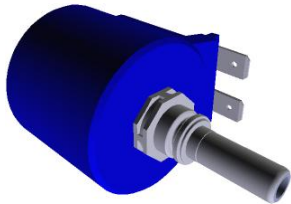
COMPONENTE			RICAMBIO																																										
Codice	Descrizione	Immagine	Codice	Descrizione	Lista componenti																																								
VL1019A	POMPA VIBRAZIONE		KVL1105A	KIT IMPIANTO LAVAGGIO PLUS 2 GIRANTI USA	<table border="1"> <thead> <tr> <th>Codice</th> <th>Descrizione</th> <th>Qtà</th> <th>UM</th> </tr> </thead> <tbody> <tr> <td>VL1067A0</td> <td>DISTRIBUTOR E INGRESSI CIRCUITO LAVAGGIO</td> <td>1</td> <td>PZ</td> </tr> <tr> <td>VL1092A0</td> <td>DISTRIBUTOR E USCITE LAVAGGIO PLUS DOPPIA</td> <td>1</td> <td>PZ</td> </tr> <tr> <td>VL1102A1</td> <td>FILTRO IN LINEA DET. + VNR BARBED 6 MM</td> <td>1</td> <td>PZ</td> </tr> <tr> <td>VL1128A0</td> <td>VALVOLA VNR BARBED D6</td> <td>1</td> <td>PZ</td> </tr> <tr> <td>VM2172A0</td> <td>CLIP BLOCCAGGIO POMPA CON CIRCUITO</td> <td>1</td> <td>PZ</td> </tr> </tbody> </table>	Codice	Descrizione	Qtà	UM	VL1067A0	DISTRIBUTOR E INGRESSI CIRCUITO LAVAGGIO	1	PZ	VL1092A0	DISTRIBUTOR E USCITE LAVAGGIO PLUS DOPPIA	1	PZ	VL1102A1	FILTRO IN LINEA DET. + VNR BARBED 6 MM	1	PZ	VL1128A0	VALVOLA VNR BARBED D6	1	PZ	VM2172A0	CLIP BLOCCAGGIO POMPA CON CIRCUITO	1	PZ																
Codice	Descrizione	Qtà	UM																																										
VL1067A0	DISTRIBUTOR E INGRESSI CIRCUITO LAVAGGIO	1	PZ																																										
VL1092A0	DISTRIBUTOR E USCITE LAVAGGIO PLUS DOPPIA	1	PZ																																										
VL1102A1	FILTRO IN LINEA DET. + VNR BARBED 6 MM	1	PZ																																										
VL1128A0	VALVOLA VNR BARBED D6	1	PZ																																										
VM2172A0	CLIP BLOCCAGGIO POMPA CON CIRCUITO	1	PZ																																										
			KVL1104A	KIT IMPIANTO LAVAGGIO PLUS 1 GIRANTE USA	<table border="1"> <thead> <tr> <th>Codice</th> <th>Descrizione</th> <th>Qtà</th> <th>UM</th> </tr> </thead> <tbody> <tr> <td>0H2143A0</td> <td>LAMIERA BLOCCA VNR VL1128</td> <td>1</td> <td>PZ</td> </tr> <tr> <td>0H7820A0</td> <td>SUPPORTO LAVAGGIO PLUS CON ELV STEAM</td> <td>1</td> <td>PZ</td> </tr> <tr> <td>EL1422A1</td> <td>ELETTROVALV 1 VIA RID.VERDE JG D8-D10 UL</td> <td>1</td> <td>PZ</td> </tr> <tr> <td>EL1426A0</td> <td>ELETTROVALV OLA UL H2O JG D8-PORTAGO MMA D</td> <td>1</td> <td>PZ</td> </tr> <tr> <td>EL1426B0</td> <td>ELETTROVALV OLA UL H2O JG D8-PORTAGO MMA D</td> <td>1</td> <td>PZ</td> </tr> <tr> <td>EL1437A0</td> <td>EV H2O JG D8-PORTAGO MMA D6 CH. VALVE UL</td> <td>1</td> <td>PZ</td> </tr> <tr> <td>EL1437B0</td> <td>ELETTROV. H2O JG D8-BARBED D6 VNR UL</td> <td>1</td> <td>PZ</td> </tr> <tr> <td>GN1526A0</td> <td>O-RING D.INT6.9 SP1.8</td> <td>1</td> <td>PZ</td> </tr> <tr> <td>RC1019A0</td> <td>FASCETTA ELASTICA D10 ZINCATA</td> <td>12</td> <td>PZ</td> </tr> </tbody> </table>	Codice	Descrizione	Qtà	UM	0H2143A0	LAMIERA BLOCCA VNR VL1128	1	PZ	0H7820A0	SUPPORTO LAVAGGIO PLUS CON ELV STEAM	1	PZ	EL1422A1	ELETTROVALV 1 VIA RID.VERDE JG D8-D10 UL	1	PZ	EL1426A0	ELETTROVALV OLA UL H2O JG D8-PORTAGO MMA D	1	PZ	EL1426B0	ELETTROVALV OLA UL H2O JG D8-PORTAGO MMA D	1	PZ	EL1437A0	EV H2O JG D8-PORTAGO MMA D6 CH. VALVE UL	1	PZ	EL1437B0	ELETTROV. H2O JG D8-BARBED D6 VNR UL	1	PZ	GN1526A0	O-RING D.INT6.9 SP1.8	1	PZ	RC1019A0	FASCETTA ELASTICA D10 ZINCATA	12	PZ
Codice	Descrizione	Qtà	UM																																										
0H2143A0	LAMIERA BLOCCA VNR VL1128	1	PZ																																										
0H7820A0	SUPPORTO LAVAGGIO PLUS CON ELV STEAM	1	PZ																																										
EL1422A1	ELETTROVALV 1 VIA RID.VERDE JG D8-D10 UL	1	PZ																																										
EL1426A0	ELETTROVALV OLA UL H2O JG D8-PORTAGO MMA D	1	PZ																																										
EL1426B0	ELETTROVALV OLA UL H2O JG D8-PORTAGO MMA D	1	PZ																																										
EL1437A0	EV H2O JG D8-PORTAGO MMA D6 CH. VALVE UL	1	PZ																																										
EL1437B0	ELETTROV. H2O JG D8-BARBED D6 VNR UL	1	PZ																																										
GN1526A0	O-RING D.INT6.9 SP1.8	1	PZ																																										
RC1019A0	FASCETTA ELASTICA D10 ZINCATA	12	PZ																																										

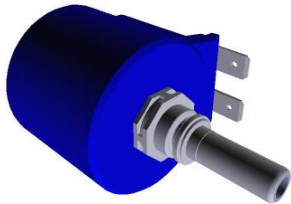
COMPONENTE			RICAMBIO																																																						
Codice	Descrizione	Immagine	Codice	Descrizione	Lista componenti																																																				
VL1019A	POMPA VIBRAZIONE		KVL1104A	KIT IMPIANTO LAVAGGIO PLUS 1 GIRANTE USA	<table border="1"> <thead> <tr> <th>Codice</th> <th>Descrizione</th> <th>Qtà</th> <th>UM</th> </tr> </thead> <tbody> <tr> <td>RC1130A0</td> <td>FASCETTA 130X2,6</td> <td>1</td> <td>PZ</td> </tr> <tr> <td>RC1242A0</td> <td>TERMINALE CHIUSO D10</td> <td>2</td> <td>PZ</td> </tr> <tr> <td>RC1356A0</td> <td>RACCORDO DRITTO FIL. FEMM 8X1/4 BSP</td> <td>1</td> <td>PZ</td> </tr> <tr> <td>TB2820A0</td> <td>TUBO EPDM 6X10</td> <td>1.410</td> <td>M</td> </tr> <tr> <td>VI1220A1</td> <td>VITE AUTOFILETTA NTE 4.2X11 TCS+ MARUTE</td> <td>3</td> <td>PZ</td> </tr> <tr> <td>VL1019A0</td> <td>POMPA VIBRAZIONE</td> <td>1</td> <td>PZ</td> </tr> <tr> <td>VL1064A0</td> <td>DISTRIBUTOR E USCITE CIRCUITO LAVAGGIO PL</td> <td>1</td> <td>PZ</td> </tr> <tr> <td>VL1065A1</td> <td>PRESSOSTAT O.N.O. 1/4 M CI</td> <td>1</td> <td>PZ</td> </tr> <tr> <td>VL1067A0</td> <td>DISTRIBUTOR E INGRESSI CIRCUITO LAVAGGIO</td> <td>1</td> <td>PZ</td> </tr> <tr> <td>VL1102A1</td> <td>FILTRO IN LINEA DET. + VNR BARBED 6 MM</td> <td>1</td> <td>PZ</td> </tr> <tr> <td>VL1128A0</td> <td>VALVOLA VNR BARBED D6</td> <td>1</td> <td>PZ</td> </tr> <tr> <td>VM2172A0</td> <td>CLIP BLOCCAGGIO POMPA CON CIRCUITO</td> <td>1</td> <td>PZ</td> </tr> </tbody> </table>	Codice	Descrizione	Qtà	UM	RC1130A0	FASCETTA 130X2,6	1	PZ	RC1242A0	TERMINALE CHIUSO D10	2	PZ	RC1356A0	RACCORDO DRITTO FIL. FEMM 8X1/4 BSP	1	PZ	TB2820A0	TUBO EPDM 6X10	1.410	M	VI1220A1	VITE AUTOFILETTA NTE 4.2X11 TCS+ MARUTE	3	PZ	VL1019A0	POMPA VIBRAZIONE	1	PZ	VL1064A0	DISTRIBUTOR E USCITE CIRCUITO LAVAGGIO PL	1	PZ	VL1065A1	PRESSOSTAT O.N.O. 1/4 M CI	1	PZ	VL1067A0	DISTRIBUTOR E INGRESSI CIRCUITO LAVAGGIO	1	PZ	VL1102A1	FILTRO IN LINEA DET. + VNR BARBED 6 MM	1	PZ	VL1128A0	VALVOLA VNR BARBED D6	1	PZ	VM2172A0	CLIP BLOCCAGGIO POMPA CON CIRCUITO	1	PZ
Codice	Descrizione	Qtà	UM																																																						
RC1130A0	FASCETTA 130X2,6	1	PZ																																																						
RC1242A0	TERMINALE CHIUSO D10	2	PZ																																																						
RC1356A0	RACCORDO DRITTO FIL. FEMM 8X1/4 BSP	1	PZ																																																						
TB2820A0	TUBO EPDM 6X10	1.410	M																																																						
VI1220A1	VITE AUTOFILETTA NTE 4.2X11 TCS+ MARUTE	3	PZ																																																						
VL1019A0	POMPA VIBRAZIONE	1	PZ																																																						
VL1064A0	DISTRIBUTOR E USCITE CIRCUITO LAVAGGIO PL	1	PZ																																																						
VL1065A1	PRESSOSTAT O.N.O. 1/4 M CI	1	PZ																																																						
VL1067A0	DISTRIBUTOR E INGRESSI CIRCUITO LAVAGGIO	1	PZ																																																						
VL1102A1	FILTRO IN LINEA DET. + VNR BARBED 6 MM	1	PZ																																																						
VL1128A0	VALVOLA VNR BARBED D6	1	PZ																																																						
VM2172A0	CLIP BLOCCAGGIO POMPA CON CIRCUITO	1	PZ																																																						
			KVL1103A	KIT IMPIANTO LAVAGGIO PLUS 2 GIRANTI EUR	<table border="1"> <thead> <tr> <th>Codice</th> <th>Descrizione</th> <th>Qtà</th> <th>UM</th> </tr> </thead> <tbody> <tr> <td>0H2143A0</td> <td>LAMIERA BLOCCA VNR VL1128</td> <td>1</td> <td>PZ</td> </tr> <tr> <td>0H7820A0</td> <td>SUPPORTO LAVAGGIO PLUS CON ELV STEAM</td> <td>1</td> <td>PZ</td> </tr> <tr> <td>EL1252A1</td> <td>ELETTROVALV OLA 1 VIA RID.VERDE JG D8-D10</td> <td>1</td> <td>PZ</td> </tr> <tr> <td>EL1424A0</td> <td>ELETTROVALV OLA H2O JG D8-PORTAGO MMA D6</td> <td>2</td> <td>PZ</td> </tr> </tbody> </table>	Codice	Descrizione	Qtà	UM	0H2143A0	LAMIERA BLOCCA VNR VL1128	1	PZ	0H7820A0	SUPPORTO LAVAGGIO PLUS CON ELV STEAM	1	PZ	EL1252A1	ELETTROVALV OLA 1 VIA RID.VERDE JG D8-D10	1	PZ	EL1424A0	ELETTROVALV OLA H2O JG D8-PORTAGO MMA D6	2	PZ																																
Codice	Descrizione	Qtà	UM																																																						
0H2143A0	LAMIERA BLOCCA VNR VL1128	1	PZ																																																						
0H7820A0	SUPPORTO LAVAGGIO PLUS CON ELV STEAM	1	PZ																																																						
EL1252A1	ELETTROVALV OLA 1 VIA RID.VERDE JG D8-D10	1	PZ																																																						
EL1424A0	ELETTROVALV OLA H2O JG D8-PORTAGO MMA D6	2	PZ																																																						

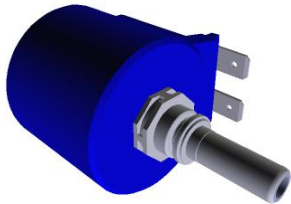
<b>COMPONENTE</b>			<b>RICAMBIO</b>																																																																										
<i>Codice</i>	<i>Descrizione</i>	<i>Immagine</i>	<i>Codice</i>	<i>Descrizione</i>	<i>Lista componenti</i>																																																																								
VL1019A	POMPA VIBRAZIONE		KVL1103A	KIT IMPIANTO LAVAGGIO PLUS 2 GIRANTI EUR	<table border="1"> <thead> <tr> <th><i>Codice</i></th> <th><i>Descrizione</i></th> <th><i>Qtà</i></th> <th><i>UM</i></th> </tr> </thead> <tbody> <tr> <td>EL1424B0</td> <td>ELETTROVALV OLA H2O JG D8-PORTAGO MMA D6</td> <td>2</td> <td>PZ</td> </tr> <tr> <td>EL1436A0</td> <td>EV H2O JG D8-PORTAGO MMA D6 CHECK VALVE</td> <td>1</td> <td>PZ</td> </tr> <tr> <td>EL1436B0</td> <td>ELETTROV. H2O JG D8-BARBED D6 VNR</td> <td>1</td> <td>PZ</td> </tr> <tr> <td>GN1526A0</td> <td>O-RING D.INT6.9 SP1.8</td> <td>1</td> <td>PZ</td> </tr> <tr> <td>RC1019A0</td> <td>FASCETTA ELASTICA D10 ZINCATA</td> <td>12</td> <td>PZ</td> </tr> <tr> <td>RC1130A0</td> <td>FASCETTA 130X2,6</td> <td>1</td> <td>PZ</td> </tr> <tr> <td>RC1242A0</td> <td>TERMINALE CHIUSO D10</td> <td>2</td> <td>PZ</td> </tr> <tr> <td>RC1356A0</td> <td>RACCORDO DRITTO FIL. FEMM 8X1/4 BSP</td> <td>1</td> <td>PZ</td> </tr> <tr> <td>TB2820A0</td> <td>TUBO EPDM 6X10</td> <td>1.410</td> <td>M</td> </tr> <tr> <td>VI1220A1</td> <td>VITE AUTOFILETTA NTE 4.2X11 TCS+ MARUTE</td> <td>3</td> <td>PZ</td> </tr> <tr> <td>VL1019A0</td> <td>POMPA VIBRAZIONE</td> <td>1</td> <td>PZ</td> </tr> <tr> <td>VL1065A1</td> <td>PRESSOSTAT O.N.O. 1/4 M CI</td> <td>1</td> <td>PZ</td> </tr> <tr> <td>VL1067A0</td> <td>DISTRIBUTOR E INGRESSI CIRCUITO LAVAGGIO</td> <td>1</td> <td>PZ</td> </tr> <tr> <td>VL1092A0</td> <td>DISTRIBUTOR E USCITE LAVAGGIO PLUS DOPPIA</td> <td>1</td> <td>PZ</td> </tr> <tr> <td>VL1102A1</td> <td>FILTRO IN LINEA DET. + VNR BARBED 6 MM</td> <td>1</td> <td>PZ</td> </tr> <tr> <td>VL1128A0</td> <td>VALVOLA VNR BARBED D6</td> <td>1</td> <td>PZ</td> </tr> <tr> <td>VM2172A0</td> <td>CLIP BLOCCAGGIO POMPA CON CIRCUITO</td> <td>1</td> <td>PZ</td> </tr> </tbody> </table>	<i>Codice</i>	<i>Descrizione</i>	<i>Qtà</i>	<i>UM</i>	EL1424B0	ELETTROVALV OLA H2O JG D8-PORTAGO MMA D6	2	PZ	EL1436A0	EV H2O JG D8-PORTAGO MMA D6 CHECK VALVE	1	PZ	EL1436B0	ELETTROV. H2O JG D8-BARBED D6 VNR	1	PZ	GN1526A0	O-RING D.INT6.9 SP1.8	1	PZ	RC1019A0	FASCETTA ELASTICA D10 ZINCATA	12	PZ	RC1130A0	FASCETTA 130X2,6	1	PZ	RC1242A0	TERMINALE CHIUSO D10	2	PZ	RC1356A0	RACCORDO DRITTO FIL. FEMM 8X1/4 BSP	1	PZ	TB2820A0	TUBO EPDM 6X10	1.410	M	VI1220A1	VITE AUTOFILETTA NTE 4.2X11 TCS+ MARUTE	3	PZ	VL1019A0	POMPA VIBRAZIONE	1	PZ	VL1065A1	PRESSOSTAT O.N.O. 1/4 M CI	1	PZ	VL1067A0	DISTRIBUTOR E INGRESSI CIRCUITO LAVAGGIO	1	PZ	VL1092A0	DISTRIBUTOR E USCITE LAVAGGIO PLUS DOPPIA	1	PZ	VL1102A1	FILTRO IN LINEA DET. + VNR BARBED 6 MM	1	PZ	VL1128A0	VALVOLA VNR BARBED D6	1	PZ	VM2172A0	CLIP BLOCCAGGIO POMPA CON CIRCUITO	1	PZ
<i>Codice</i>	<i>Descrizione</i>	<i>Qtà</i>	<i>UM</i>																																																																										
EL1424B0	ELETTROVALV OLA H2O JG D8-PORTAGO MMA D6	2	PZ																																																																										
EL1436A0	EV H2O JG D8-PORTAGO MMA D6 CHECK VALVE	1	PZ																																																																										
EL1436B0	ELETTROV. H2O JG D8-BARBED D6 VNR	1	PZ																																																																										
GN1526A0	O-RING D.INT6.9 SP1.8	1	PZ																																																																										
RC1019A0	FASCETTA ELASTICA D10 ZINCATA	12	PZ																																																																										
RC1130A0	FASCETTA 130X2,6	1	PZ																																																																										
RC1242A0	TERMINALE CHIUSO D10	2	PZ																																																																										
RC1356A0	RACCORDO DRITTO FIL. FEMM 8X1/4 BSP	1	PZ																																																																										
TB2820A0	TUBO EPDM 6X10	1.410	M																																																																										
VI1220A1	VITE AUTOFILETTA NTE 4.2X11 TCS+ MARUTE	3	PZ																																																																										
VL1019A0	POMPA VIBRAZIONE	1	PZ																																																																										
VL1065A1	PRESSOSTAT O.N.O. 1/4 M CI	1	PZ																																																																										
VL1067A0	DISTRIBUTOR E INGRESSI CIRCUITO LAVAGGIO	1	PZ																																																																										
VL1092A0	DISTRIBUTOR E USCITE LAVAGGIO PLUS DOPPIA	1	PZ																																																																										
VL1102A1	FILTRO IN LINEA DET. + VNR BARBED 6 MM	1	PZ																																																																										
VL1128A0	VALVOLA VNR BARBED D6	1	PZ																																																																										
VM2172A0	CLIP BLOCCAGGIO POMPA CON CIRCUITO	1	PZ																																																																										

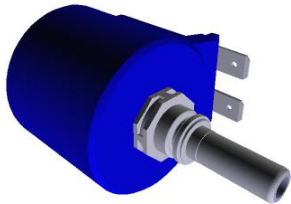
<b>COMPONENTE</b>			<b>RICAMBIO</b>																																																																										
<i>Codice</i>	<i>Descrizione</i>	<i>Immagine</i>	<i>Codice</i>	<i>Descrizione</i>	<i>Lista componenti</i>																																																																								
VL1019A	POMPA VIBRAZIONE		KVL1101A	KIT IMPIANTO LAVAGGIO PLUS 1 GIRANTE EUR	<table border="1"> <thead> <tr> <th><i>Codice</i></th> <th><i>Descrizione</i></th> <th><i>Qtà</i></th> <th><i>UM</i></th> </tr> </thead> <tbody> <tr> <td>0H2143A0</td> <td>LAMIERA BLOCCA VNR VL1128</td> <td>1</td> <td>PZ</td> </tr> <tr> <td>0H7820A0</td> <td>SUPPORTO LAVAGGIO PLUS CON ELV STEAM</td> <td>1</td> <td>PZ</td> </tr> <tr> <td>EL1252A1</td> <td>ELETTROVALV OLA 1 VIA RID.VERDE JG D8-D10</td> <td>1</td> <td>PZ</td> </tr> <tr> <td>EL1424A0</td> <td>ELETTROVALV OLA H2O JG D8-PORTAGO MMA D6</td> <td>1</td> <td>PZ</td> </tr> <tr> <td>EL1424B0</td> <td>ELETTROVALV OLA H2O JG D8-PORTAGO MMA D6</td> <td>1</td> <td>PZ</td> </tr> <tr> <td>EL1436A0</td> <td>EV H2O JG D8-PORTAGO MMA D6 CHECK VALVE</td> <td>1</td> <td>PZ</td> </tr> <tr> <td>EL1436B0</td> <td>ELETTROV. H2O JG D8-BARBED D6 VNR</td> <td>1</td> <td>PZ</td> </tr> <tr> <td>GN1526A0</td> <td>O-RING D.INT6.9 SP1.8</td> <td>1</td> <td>PZ</td> </tr> <tr> <td>RC1019A0</td> <td>FASCETTA ELASTICA D10 ZINCATA</td> <td>12</td> <td>PZ</td> </tr> <tr> <td>RC1130A0</td> <td>FASCETTA 130X2,6</td> <td>1</td> <td>PZ</td> </tr> <tr> <td>RC1242A0</td> <td>TERMINALE CHIUSO D10</td> <td>2</td> <td>PZ</td> </tr> <tr> <td>RC1356A0</td> <td>RACCORDO DRITTO FIL. FEMM 8X1/4 BSP</td> <td>1</td> <td>PZ</td> </tr> <tr> <td>TB2820A0</td> <td>TUBO EPDM 6X10</td> <td>1.410</td> <td>M</td> </tr> <tr> <td>VI1220A1</td> <td>VITE AUTOFISETTA NTE 4.2X11 TCS+ MARUTE</td> <td>3</td> <td>PZ</td> </tr> <tr> <td>VL1019A0</td> <td>POMPA VIBRAZIONE</td> <td>1</td> <td>PZ</td> </tr> <tr> <td>VL1064A0</td> <td>DISTRIBUTOR E USCITE CIRCUITO LAVAGGIO PL</td> <td>1</td> <td>PZ</td> </tr> <tr> <td>VL1065A1</td> <td>PRESSOSTAT O N.O. 1/4 M CI</td> <td>1</td> <td>PZ</td> </tr> </tbody> </table>	<i>Codice</i>	<i>Descrizione</i>	<i>Qtà</i>	<i>UM</i>	0H2143A0	LAMIERA BLOCCA VNR VL1128	1	PZ	0H7820A0	SUPPORTO LAVAGGIO PLUS CON ELV STEAM	1	PZ	EL1252A1	ELETTROVALV OLA 1 VIA RID.VERDE JG D8-D10	1	PZ	EL1424A0	ELETTROVALV OLA H2O JG D8-PORTAGO MMA D6	1	PZ	EL1424B0	ELETTROVALV OLA H2O JG D8-PORTAGO MMA D6	1	PZ	EL1436A0	EV H2O JG D8-PORTAGO MMA D6 CHECK VALVE	1	PZ	EL1436B0	ELETTROV. H2O JG D8-BARBED D6 VNR	1	PZ	GN1526A0	O-RING D.INT6.9 SP1.8	1	PZ	RC1019A0	FASCETTA ELASTICA D10 ZINCATA	12	PZ	RC1130A0	FASCETTA 130X2,6	1	PZ	RC1242A0	TERMINALE CHIUSO D10	2	PZ	RC1356A0	RACCORDO DRITTO FIL. FEMM 8X1/4 BSP	1	PZ	TB2820A0	TUBO EPDM 6X10	1.410	M	VI1220A1	VITE AUTOFISETTA NTE 4.2X11 TCS+ MARUTE	3	PZ	VL1019A0	POMPA VIBRAZIONE	1	PZ	VL1064A0	DISTRIBUTOR E USCITE CIRCUITO LAVAGGIO PL	1	PZ	VL1065A1	PRESSOSTAT O N.O. 1/4 M CI	1	PZ
<i>Codice</i>	<i>Descrizione</i>	<i>Qtà</i>	<i>UM</i>																																																																										
0H2143A0	LAMIERA BLOCCA VNR VL1128	1	PZ																																																																										
0H7820A0	SUPPORTO LAVAGGIO PLUS CON ELV STEAM	1	PZ																																																																										
EL1252A1	ELETTROVALV OLA 1 VIA RID.VERDE JG D8-D10	1	PZ																																																																										
EL1424A0	ELETTROVALV OLA H2O JG D8-PORTAGO MMA D6	1	PZ																																																																										
EL1424B0	ELETTROVALV OLA H2O JG D8-PORTAGO MMA D6	1	PZ																																																																										
EL1436A0	EV H2O JG D8-PORTAGO MMA D6 CHECK VALVE	1	PZ																																																																										
EL1436B0	ELETTROV. H2O JG D8-BARBED D6 VNR	1	PZ																																																																										
GN1526A0	O-RING D.INT6.9 SP1.8	1	PZ																																																																										
RC1019A0	FASCETTA ELASTICA D10 ZINCATA	12	PZ																																																																										
RC1130A0	FASCETTA 130X2,6	1	PZ																																																																										
RC1242A0	TERMINALE CHIUSO D10	2	PZ																																																																										
RC1356A0	RACCORDO DRITTO FIL. FEMM 8X1/4 BSP	1	PZ																																																																										
TB2820A0	TUBO EPDM 6X10	1.410	M																																																																										
VI1220A1	VITE AUTOFISETTA NTE 4.2X11 TCS+ MARUTE	3	PZ																																																																										
VL1019A0	POMPA VIBRAZIONE	1	PZ																																																																										
VL1064A0	DISTRIBUTOR E USCITE CIRCUITO LAVAGGIO PL	1	PZ																																																																										
VL1065A1	PRESSOSTAT O N.O. 1/4 M CI	1	PZ																																																																										

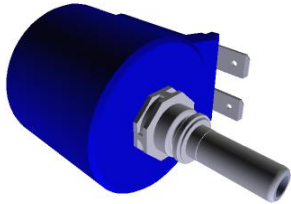

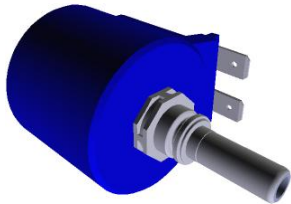

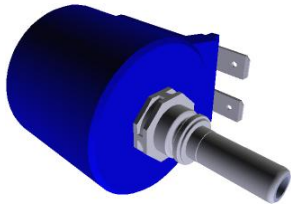
COMPONENTE			RICAMBIO																																																											
Codice	Descrizione	Immagine	Codice	Descrizione	Lista componenti																																																									
VL1019A	POMPA VIBRAZIONE		KVL1101A	KIT IMPIANTO LAVAGGIO PLUS 1 GIRANTE EUR	<table border="1"> <thead> <tr> <th>Codice</th> <th>Descrizione</th> <th>Qtà</th> <th>UM</th> </tr> </thead> <tbody> <tr> <td>VL1067A0</td> <td>DISTRIBUTOR E INGRESSI CIRCUITO LAVAGGIO</td> <td>1</td> <td>PZ</td> </tr> <tr> <td>VL1102A1</td> <td>FILTRO IN LINEA DET. + VNR BARBED 6 MM</td> <td>1</td> <td>PZ</td> </tr> <tr> <td>VL1128A0</td> <td>VALVOLA VNR BARBED D6</td> <td>1</td> <td>PZ</td> </tr> <tr> <td>VM2172A0</td> <td>CLIP BLOCCAGGIO POMPA CON CIRCUITO</td> <td>1</td> <td>PZ</td> </tr> </tbody> </table>	Codice	Descrizione	Qtà	UM	VL1067A0	DISTRIBUTOR E INGRESSI CIRCUITO LAVAGGIO	1	PZ	VL1102A1	FILTRO IN LINEA DET. + VNR BARBED 6 MM	1	PZ	VL1128A0	VALVOLA VNR BARBED D6	1	PZ	VM2172A0	CLIP BLOCCAGGIO POMPA CON CIRCUITO	1	PZ																																					
			Codice	Descrizione	Qtà	UM																																																								
VL1067A0	DISTRIBUTOR E INGRESSI CIRCUITO LAVAGGIO	1	PZ																																																											
VL1102A1	FILTRO IN LINEA DET. + VNR BARBED 6 MM	1	PZ																																																											
VL1128A0	VALVOLA VNR BARBED D6	1	PZ																																																											
VM2172A0	CLIP BLOCCAGGIO POMPA CON CIRCUITO	1	PZ																																																											
KVL1094A	KIT IMPIANTO LAVAGGIO 0311 EU	<table border="1"> <thead> <tr> <th>Codice</th> <th>Descrizione</th> <th>Qtà</th> <th>UM</th> </tr> </thead> <tbody> <tr> <td>0H2143A0</td> <td>LAMIERA BLOCCA VNR VL1128</td> <td>1</td> <td>PZ</td> </tr> <tr> <td>0H7494B0</td> <td>LAMIERA SUPPORTO LAVAGGIO ONE-03</td> <td>1</td> <td>PZ</td> </tr> <tr> <td>EL1436A0</td> <td>EV H2O JG D8-PORTAGO MMA D6 CHECK VALVE</td> <td>1</td> <td>PZ</td> </tr> <tr> <td>EL1436B0</td> <td>ELETTROV. H2O JG D8-BARBED D6 VNR</td> <td>1</td> <td>PZ</td> </tr> <tr> <td>GN1526A0</td> <td>O-RING D.INT6.9 SP1.8</td> <td>1</td> <td>PZ</td> </tr> <tr> <td>RC1242A0</td> <td>TERMINALE CHIUSO D10</td> <td>2</td> <td>PZ</td> </tr> <tr> <td>TB2820A0</td> <td>TUBO EPDM 6X10</td> <td>1.420</td> <td>M</td> </tr> <tr> <td>VI1220A1</td> <td>VITE AUTOFILETTA NTE 4.2X11 TCS+ MARLITE</td> <td>1</td> <td>PZ</td> </tr> <tr> <td>VL1019A0</td> <td>POMPA VIBRAZIONE</td> <td>1</td> <td>PZ</td> </tr> <tr> <td>VL1053B0</td> <td>DISTRIBUTOR E USCITA LAVAGGIO ON</td> <td>1</td> <td>PZ</td> </tr> <tr> <td>VL1054B0</td> <td>DISTRIBUTOR E INGRESSI LAVAGGIO ON</td> <td>1</td> <td>PZ</td> </tr> <tr> <td>VL1102A1</td> <td>FILTRO IN LINEA DET. + VNR BARBED 6 MM</td> <td>1</td> <td>PZ</td> </tr> <tr> <td>VL1128A0</td> <td>VALVOLA VNR BARBED D6</td> <td>1</td> <td>PZ</td> </tr> <tr> <td>VM2172A0</td> <td>CLIP BLOCCAGGIO POMPA CON CIRCUITO</td> <td>1</td> <td>PZ</td> </tr> </tbody> </table>	Codice	Descrizione	Qtà	UM	0H2143A0	LAMIERA BLOCCA VNR VL1128	1	PZ	0H7494B0	LAMIERA SUPPORTO LAVAGGIO ONE-03	1	PZ	EL1436A0	EV H2O JG D8-PORTAGO MMA D6 CHECK VALVE	1	PZ	EL1436B0	ELETTROV. H2O JG D8-BARBED D6 VNR	1	PZ	GN1526A0	O-RING D.INT6.9 SP1.8	1	PZ	RC1242A0	TERMINALE CHIUSO D10	2	PZ	TB2820A0	TUBO EPDM 6X10	1.420	M	VI1220A1	VITE AUTOFILETTA NTE 4.2X11 TCS+ MARLITE	1	PZ	VL1019A0	POMPA VIBRAZIONE	1	PZ	VL1053B0	DISTRIBUTOR E USCITA LAVAGGIO ON	1	PZ	VL1054B0	DISTRIBUTOR E INGRESSI LAVAGGIO ON	1	PZ	VL1102A1	FILTRO IN LINEA DET. + VNR BARBED 6 MM	1	PZ	VL1128A0	VALVOLA VNR BARBED D6	1	PZ	VM2172A0	CLIP BLOCCAGGIO POMPA CON CIRCUITO	1	PZ
Codice	Descrizione	Qtà	UM																																																											
0H2143A0	LAMIERA BLOCCA VNR VL1128	1	PZ																																																											
0H7494B0	LAMIERA SUPPORTO LAVAGGIO ONE-03	1	PZ																																																											
EL1436A0	EV H2O JG D8-PORTAGO MMA D6 CHECK VALVE	1	PZ																																																											
EL1436B0	ELETTROV. H2O JG D8-BARBED D6 VNR	1	PZ																																																											
GN1526A0	O-RING D.INT6.9 SP1.8	1	PZ																																																											
RC1242A0	TERMINALE CHIUSO D10	2	PZ																																																											
TB2820A0	TUBO EPDM 6X10	1.420	M																																																											
VI1220A1	VITE AUTOFILETTA NTE 4.2X11 TCS+ MARLITE	1	PZ																																																											
VL1019A0	POMPA VIBRAZIONE	1	PZ																																																											
VL1053B0	DISTRIBUTOR E USCITA LAVAGGIO ON	1	PZ																																																											
VL1054B0	DISTRIBUTOR E INGRESSI LAVAGGIO ON	1	PZ																																																											
VL1102A1	FILTRO IN LINEA DET. + VNR BARBED 6 MM	1	PZ																																																											
VL1128A0	VALVOLA VNR BARBED D6	1	PZ																																																											
VM2172A0	CLIP BLOCCAGGIO POMPA CON CIRCUITO	1	PZ																																																											

<b>COMPONENTE</b>			<b>RICAMBIO</b>																																																		
<i>Codice</i>	<i>Descrizione</i>	<i>Immagine</i>	<i>Codice</i>	<i>Descrizione</i>	<i>Lista componenti</i>																																																
VL1019A	POMPA VIBRAZIONE		KVL1092A	KIT POMPA IMPIANTO LAVAGGIO PLUS 2GIR EU	<table border="1"> <thead> <tr> <th>Codice</th> <th>Descrizione</th> <th>Qtà</th> <th>UM</th> </tr> </thead> <tbody> <tr> <td>0H2143A0</td> <td>LAMIERA BLOCCA VNR VL1128</td> <td>1</td> <td>PZ</td> </tr> <tr> <td>GN1526A0</td> <td>O-RING D.INT6.9 SP1.8</td> <td>1</td> <td>PZ</td> </tr> <tr> <td>RC1019A0</td> <td>FASCETTA ELASTICA D10 ZINCATA</td> <td>6</td> <td>PZ</td> </tr> <tr> <td>RC1130A0</td> <td>FASCETTA 130X2,6</td> <td>1</td> <td>PZ</td> </tr> <tr> <td>RC1242A0</td> <td>TERMINALE CHIUSO D10</td> <td>2</td> <td>PZ</td> </tr> <tr> <td>TB2820A0</td> <td>TUBO EPDM 6X10</td> <td>0.120</td> <td>M</td> </tr> <tr> <td>VL1019A0</td> <td>POMPA VIBRAZIONE</td> <td>1</td> <td>PZ</td> </tr> <tr> <td>VL1067A0</td> <td>DISTRIBUTOR E INGRESSI CIRCUITO LAVAGGIO</td> <td>1</td> <td>PZ</td> </tr> <tr> <td>VL1092A0</td> <td>DISTRIBUTOR E USCITE LAVAGGIO PLUS DOPPIA</td> <td>1</td> <td>PZ</td> </tr> <tr> <td>VL1128A0</td> <td>VALVOLA VNR BARBED D6</td> <td>1</td> <td>PZ</td> </tr> <tr> <td>VM2172A0</td> <td>CLIP BLOCCAGGIO POMPA CON CIRCUITO</td> <td>1</td> <td>PZ</td> </tr> </tbody> </table>	Codice	Descrizione	Qtà	UM	0H2143A0	LAMIERA BLOCCA VNR VL1128	1	PZ	GN1526A0	O-RING D.INT6.9 SP1.8	1	PZ	RC1019A0	FASCETTA ELASTICA D10 ZINCATA	6	PZ	RC1130A0	FASCETTA 130X2,6	1	PZ	RC1242A0	TERMINALE CHIUSO D10	2	PZ	TB2820A0	TUBO EPDM 6X10	0.120	M	VL1019A0	POMPA VIBRAZIONE	1	PZ	VL1067A0	DISTRIBUTOR E INGRESSI CIRCUITO LAVAGGIO	1	PZ	VL1092A0	DISTRIBUTOR E USCITE LAVAGGIO PLUS DOPPIA	1	PZ	VL1128A0	VALVOLA VNR BARBED D6	1	PZ	VM2172A0	CLIP BLOCCAGGIO POMPA CON CIRCUITO	1	PZ
Codice	Descrizione	Qtà	UM																																																		
0H2143A0	LAMIERA BLOCCA VNR VL1128	1	PZ																																																		
GN1526A0	O-RING D.INT6.9 SP1.8	1	PZ																																																		
RC1019A0	FASCETTA ELASTICA D10 ZINCATA	6	PZ																																																		
RC1130A0	FASCETTA 130X2,6	1	PZ																																																		
RC1242A0	TERMINALE CHIUSO D10	2	PZ																																																		
TB2820A0	TUBO EPDM 6X10	0.120	M																																																		
VL1019A0	POMPA VIBRAZIONE	1	PZ																																																		
VL1067A0	DISTRIBUTOR E INGRESSI CIRCUITO LAVAGGIO	1	PZ																																																		
VL1092A0	DISTRIBUTOR E USCITE LAVAGGIO PLUS DOPPIA	1	PZ																																																		
VL1128A0	VALVOLA VNR BARBED D6	1	PZ																																																		
VM2172A0	CLIP BLOCCAGGIO POMPA CON CIRCUITO	1	PZ																																																		
			KVL1073A	KIT POMPA IMPIANTO LAVAGGIO PLUS 1GIR EU	<table border="1"> <thead> <tr> <th>Codice</th> <th>Descrizione</th> <th>Qtà</th> <th>UM</th> </tr> </thead> <tbody> <tr> <td>0H2143A0</td> <td>LAMIERA BLOCCA VNR VL1128</td> <td>1</td> <td>PZ</td> </tr> <tr> <td>GN1526A0</td> <td>O-RING D.INT6.9 SP1.8</td> <td>1</td> <td>PZ</td> </tr> <tr> <td>RC1019A0</td> <td>FASCETTA ELASTICA D10 ZINCATA</td> <td>6</td> <td>PZ</td> </tr> <tr> <td>RC1130A0</td> <td>FASCETTA 130X2,6</td> <td>1</td> <td>PZ</td> </tr> <tr> <td>RC1242A0</td> <td>TERMINALE CHIUSO D10</td> <td>2</td> <td>PZ</td> </tr> <tr> <td>TB2820A0</td> <td>TUBO EPDM 6X10</td> <td>0.120</td> <td>M</td> </tr> <tr> <td>VL1019A0</td> <td>POMPA VIBRAZIONE</td> <td>1</td> <td>PZ</td> </tr> <tr> <td>VL1064A0</td> <td>DISTRIBUTOR E USCITE CIRCUITO LAVAGGIO PL</td> <td>1</td> <td>PZ</td> </tr> </tbody> </table>	Codice	Descrizione	Qtà	UM	0H2143A0	LAMIERA BLOCCA VNR VL1128	1	PZ	GN1526A0	O-RING D.INT6.9 SP1.8	1	PZ	RC1019A0	FASCETTA ELASTICA D10 ZINCATA	6	PZ	RC1130A0	FASCETTA 130X2,6	1	PZ	RC1242A0	TERMINALE CHIUSO D10	2	PZ	TB2820A0	TUBO EPDM 6X10	0.120	M	VL1019A0	POMPA VIBRAZIONE	1	PZ	VL1064A0	DISTRIBUTOR E USCITE CIRCUITO LAVAGGIO PL	1	PZ												
Codice	Descrizione	Qtà	UM																																																		
0H2143A0	LAMIERA BLOCCA VNR VL1128	1	PZ																																																		
GN1526A0	O-RING D.INT6.9 SP1.8	1	PZ																																																		
RC1019A0	FASCETTA ELASTICA D10 ZINCATA	6	PZ																																																		
RC1130A0	FASCETTA 130X2,6	1	PZ																																																		
RC1242A0	TERMINALE CHIUSO D10	2	PZ																																																		
TB2820A0	TUBO EPDM 6X10	0.120	M																																																		
VL1019A0	POMPA VIBRAZIONE	1	PZ																																																		
VL1064A0	DISTRIBUTOR E USCITE CIRCUITO LAVAGGIO PL	1	PZ																																																		

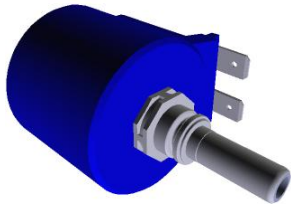

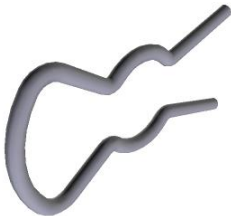
COMPONENTE			RICAMBIO																																															
Codice	Descrizione	Immagine	Codice	Descrizione	Lista componenti																																													
VL1019A	POMPA VIBRAZIONE		KVL1073A	KIT POMPA IMPIANTO LAVAGGIO PLUS 1GIR EU	<table border="1"> <thead> <tr> <th>Codice</th> <th>Descrizione</th> <th>Qtà</th> <th>UM</th> </tr> </thead> <tbody> <tr> <td>VL1067A0</td> <td>DISTRIBUTOR E INGRESSI CIRCUITO LAVAGGIO</td> <td>1</td> <td>PZ</td> </tr> <tr> <td>VL1128A0</td> <td>VALVOLA VNR BARBED D6</td> <td>1</td> <td>PZ</td> </tr> <tr> <td>VM2172A0</td> <td>CLIP BLOCCAGGIO POMPA CON CIRCUITO</td> <td>1</td> <td>PZ</td> </tr> </tbody> </table>	Codice	Descrizione	Qtà	UM	VL1067A0	DISTRIBUTOR E INGRESSI CIRCUITO LAVAGGIO	1	PZ	VL1128A0	VALVOLA VNR BARBED D6	1	PZ	VM2172A0	CLIP BLOCCAGGIO POMPA CON CIRCUITO	1	PZ																													
			Codice	Descrizione	Qtà	UM																																												
			VL1067A0	DISTRIBUTOR E INGRESSI CIRCUITO LAVAGGIO	1	PZ																																												
VL1128A0	VALVOLA VNR BARBED D6	1	PZ																																															
VM2172A0	CLIP BLOCCAGGIO POMPA CON CIRCUITO	1	PZ																																															
KVL1072A	KIT POMPA IMPIANTO LAVAGGIO ONE	<table border="1"> <thead> <tr> <th>Codice</th> <th>Descrizione</th> <th>Qtà</th> <th>UM</th> </tr> </thead> <tbody> <tr> <td>0H2143A0</td> <td>LAMIERA BLOCCA VNR VL1128</td> <td>1</td> <td>PZ</td> </tr> <tr> <td>GN1526A0</td> <td>O-RING D.INT6.9 SP1.8</td> <td>1</td> <td>PZ</td> </tr> <tr> <td>RC1019A0</td> <td>FASCETTA ELASTICA D10 ZINCATO</td> <td>6</td> <td>PZ</td> </tr> <tr> <td>RC1242A0</td> <td>TERMINALE CHIUSO D10</td> <td>2</td> <td>PZ</td> </tr> <tr> <td>TB2820A0</td> <td>TUBO EPDM 6X10</td> <td>0.120</td> <td>M</td> </tr> <tr> <td>VI1220A1</td> <td>VITE AUTOFILETTA NTE 4.2X11 TCS+ MARUTE</td> <td>1</td> <td>PZ</td> </tr> <tr> <td>VL1019A0</td> <td>POMPA VIBRAZIONE</td> <td>1</td> <td>PZ</td> </tr> <tr> <td>VL1053B0</td> <td>DISTRIBUTOR E USCITA LAVAGGIO ON</td> <td>1</td> <td>PZ</td> </tr> <tr> <td>VL1054B0</td> <td>DISTRIBUTOR E INGRESSI LAVAGGIO ON</td> <td>1</td> <td>PZ</td> </tr> <tr> <td>VL1128A0</td> <td>VALVOLA VNR BARBED D6</td> <td>1</td> <td>PZ</td> </tr> <tr> <td>VM2172A0</td> <td>CLIP BLOCCAGGIO POMPA CON CIRCUITO</td> <td>1</td> <td>PZ</td> </tr> </tbody> </table>	Codice	Descrizione	Qtà	UM	0H2143A0	LAMIERA BLOCCA VNR VL1128	1	PZ	GN1526A0	O-RING D.INT6.9 SP1.8	1	PZ	RC1019A0	FASCETTA ELASTICA D10 ZINCATO	6	PZ	RC1242A0	TERMINALE CHIUSO D10	2	PZ	TB2820A0	TUBO EPDM 6X10	0.120	M	VI1220A1	VITE AUTOFILETTA NTE 4.2X11 TCS+ MARUTE	1	PZ	VL1019A0	POMPA VIBRAZIONE	1	PZ	VL1053B0	DISTRIBUTOR E USCITA LAVAGGIO ON	1	PZ	VL1054B0	DISTRIBUTOR E INGRESSI LAVAGGIO ON	1	PZ	VL1128A0	VALVOLA VNR BARBED D6	1	PZ	VM2172A0	CLIP BLOCCAGGIO POMPA CON CIRCUITO	1	PZ
Codice	Descrizione	Qtà	UM																																															
0H2143A0	LAMIERA BLOCCA VNR VL1128	1	PZ																																															
GN1526A0	O-RING D.INT6.9 SP1.8	1	PZ																																															
RC1019A0	FASCETTA ELASTICA D10 ZINCATO	6	PZ																																															
RC1242A0	TERMINALE CHIUSO D10	2	PZ																																															
TB2820A0	TUBO EPDM 6X10	0.120	M																																															
VI1220A1	VITE AUTOFILETTA NTE 4.2X11 TCS+ MARUTE	1	PZ																																															
VL1019A0	POMPA VIBRAZIONE	1	PZ																																															
VL1053B0	DISTRIBUTOR E USCITA LAVAGGIO ON	1	PZ																																															
VL1054B0	DISTRIBUTOR E INGRESSI LAVAGGIO ON	1	PZ																																															
VL1128A0	VALVOLA VNR BARBED D6	1	PZ																																															
VM2172A0	CLIP BLOCCAGGIO POMPA CON CIRCUITO	1	PZ																																															
KVL0001A	KIT IMPIANTO LAVAGGIO LM TOP	<table border="1"> <thead> <tr> <th>Codice</th> <th>Descrizione</th> <th>Qtà</th> <th>UM</th> </tr> </thead> <tbody> <tr> <td>0H1226B0</td> <td>LAMIERA CIRCUITO LAVAGGIO LINEMISS</td> <td>1</td> <td>PZ</td> </tr> <tr> <td>0H2143A0</td> <td>LAMIERA BLOCCA VNR VL1128</td> <td>2</td> <td>PZ</td> </tr> <tr> <td>GN1312A0</td> <td>PASSACAVO GOMMA DE=26 DI=15 SP=10</td> <td>1</td> <td>PZ</td> </tr> </tbody> </table>	Codice	Descrizione	Qtà	UM	0H1226B0	LAMIERA CIRCUITO LAVAGGIO LINEMISS	1	PZ	0H2143A0	LAMIERA BLOCCA VNR VL1128	2	PZ	GN1312A0	PASSACAVO GOMMA DE=26 DI=15 SP=10	1	PZ																																
Codice	Descrizione	Qtà	UM																																															
0H1226B0	LAMIERA CIRCUITO LAVAGGIO LINEMISS	1	PZ																																															
0H2143A0	LAMIERA BLOCCA VNR VL1128	2	PZ																																															
GN1312A0	PASSACAVO GOMMA DE=26 DI=15 SP=10	1	PZ																																															



COMPONENTE			RICAMBIO																																																																														
Codice	Descrizione	Immagine	Codice	Descrizione	Lista componenti																																																																												
VL1019A	POMPA VIBRAZIONE		KVL0001A	KIT IMPIANTO LAVAGGIO LM TOP	<table border="1"> <thead> <tr> <th>Codice</th> <th>Descrizione</th> <th>Qtà</th> <th>UM</th> </tr> </thead> <tbody> <tr> <td>GN1526A0</td> <td>O-RING D.INT6.9 SP1.8</td> <td>1</td> <td>PZ</td> </tr> <tr> <td>RC1019A0</td> <td>FASCETTA ELASTICA D10 ZINCATA</td> <td>5</td> <td>PZ</td> </tr> <tr> <td>RC1242A0</td> <td>TERMINALE CHIUSO D10</td> <td>2</td> <td>PZ</td> </tr> <tr> <td>RC1381A0</td> <td>BIFILARI STRINGI TUBO D10.7 ZINCAT</td> <td>3</td> <td>PZ</td> </tr> <tr> <td>TB2343A0</td> <td>TUBO PVC TRASPARENT E 9X6</td> <td>1.650</td> <td>M</td> </tr> <tr> <td>TB2820A0</td> <td>TUBO EPDM 6X10</td> <td>0.990</td> <td>M</td> </tr> <tr> <td>VI1220A1</td> <td>VITE AUTOFILETTA NTE 4.2X11 TCS+ MARUTE</td> <td>1</td> <td>PZ</td> </tr> <tr> <td>VL1019A0</td> <td>POMPA VIBRAZIONE</td> <td>1</td> <td>PZ</td> </tr> <tr> <td>VL1041C0</td> <td>TAPPO DETERGENTE FORATO Ø12</td> <td>1</td> <td>PZ</td> </tr> <tr> <td>VL1047A1</td> <td>PORTAGOMM A D6 CODOLO D8</td> <td>1</td> <td>PZ</td> </tr> <tr> <td>VL1053B0</td> <td>DISTRIBUTOR E USCITA LAVAGGIO ON</td> <td>1</td> <td>PZ</td> </tr> <tr> <td>VL1054B0</td> <td>DISTRIBUTOR E INGRESSI LAVAGGIO ON</td> <td>1</td> <td>PZ</td> </tr> <tr> <td>VL1061A0</td> <td>FILTRO RETINATO+AF FONDANTE+V NR XFT200</td> <td>1</td> <td>PZ</td> </tr> <tr> <td>VL1128A0</td> <td>VALVOLA VNR BARBED D6</td> <td>2</td> <td>PZ</td> </tr> <tr> <td>VM1066A0</td> <td>CLIP A SELLA PASSAGGIO CAVI</td> <td>3</td> <td>PZ</td> </tr> <tr> <td>VM1088A0</td> <td>FASCETTA A SCATTO D7.9-D9.2 PP</td> <td>1</td> <td>PZ</td> </tr> <tr> <td>VM1605A0</td> <td>CLIP TWIST LOCK DIAM. 10.2-12.7 MM</td> <td>1</td> <td>PZ</td> </tr> <tr> <td>VM2172A0</td> <td>CLIP BLOCCAGGIO POMPA CON CIRCUITO</td> <td>1</td> <td>PZ</td> </tr> </tbody> </table>	Codice	Descrizione	Qtà	UM	GN1526A0	O-RING D.INT6.9 SP1.8	1	PZ	RC1019A0	FASCETTA ELASTICA D10 ZINCATA	5	PZ	RC1242A0	TERMINALE CHIUSO D10	2	PZ	RC1381A0	BIFILARI STRINGI TUBO D10.7 ZINCAT	3	PZ	TB2343A0	TUBO PVC TRASPARENT E 9X6	1.650	M	TB2820A0	TUBO EPDM 6X10	0.990	M	VI1220A1	VITE AUTOFILETTA NTE 4.2X11 TCS+ MARUTE	1	PZ	VL1019A0	POMPA VIBRAZIONE	1	PZ	VL1041C0	TAPPO DETERGENTE FORATO Ø12	1	PZ	VL1047A1	PORTAGOMM A D6 CODOLO D8	1	PZ	VL1053B0	DISTRIBUTOR E USCITA LAVAGGIO ON	1	PZ	VL1054B0	DISTRIBUTOR E INGRESSI LAVAGGIO ON	1	PZ	VL1061A0	FILTRO RETINATO+AF FONDANTE+V NR XFT200	1	PZ	VL1128A0	VALVOLA VNR BARBED D6	2	PZ	VM1066A0	CLIP A SELLA PASSAGGIO CAVI	3	PZ	VM1088A0	FASCETTA A SCATTO D7.9-D9.2 PP	1	PZ	VM1605A0	CLIP TWIST LOCK DIAM. 10.2-12.7 MM	1	PZ	VM2172A0	CLIP BLOCCAGGIO POMPA CON CIRCUITO	1	PZ
Codice	Descrizione	Qtà	UM																																																																														
GN1526A0	O-RING D.INT6.9 SP1.8	1	PZ																																																																														
RC1019A0	FASCETTA ELASTICA D10 ZINCATA	5	PZ																																																																														
RC1242A0	TERMINALE CHIUSO D10	2	PZ																																																																														
RC1381A0	BIFILARI STRINGI TUBO D10.7 ZINCAT	3	PZ																																																																														
TB2343A0	TUBO PVC TRASPARENT E 9X6	1.650	M																																																																														
TB2820A0	TUBO EPDM 6X10	0.990	M																																																																														
VI1220A1	VITE AUTOFILETTA NTE 4.2X11 TCS+ MARUTE	1	PZ																																																																														
VL1019A0	POMPA VIBRAZIONE	1	PZ																																																																														
VL1041C0	TAPPO DETERGENTE FORATO Ø12	1	PZ																																																																														
VL1047A1	PORTAGOMM A D6 CODOLO D8	1	PZ																																																																														
VL1053B0	DISTRIBUTOR E USCITA LAVAGGIO ON	1	PZ																																																																														
VL1054B0	DISTRIBUTOR E INGRESSI LAVAGGIO ON	1	PZ																																																																														
VL1061A0	FILTRO RETINATO+AF FONDANTE+V NR XFT200	1	PZ																																																																														
VL1128A0	VALVOLA VNR BARBED D6	2	PZ																																																																														
VM1066A0	CLIP A SELLA PASSAGGIO CAVI	3	PZ																																																																														
VM1088A0	FASCETTA A SCATTO D7.9-D9.2 PP	1	PZ																																																																														
VM1605A0	CLIP TWIST LOCK DIAM. 10.2-12.7 MM	1	PZ																																																																														
VM2172A0	CLIP BLOCCAGGIO POMPA CON CIRCUITO	1	PZ																																																																														

COMPONENTE			RICAMBIO																														
Codice	Descrizione	Immagine	Codice	Descrizione	Lista componenti																												
VM2172A	CLIP BLOCCAGGIO POMPA CON CIRCUITO		VM2172A0	CLIP BLOCCAGGIO POMPA CON CIRCUITO																													
RC1019A	FASCETTA ELASTICA D10 ZINCATA		KRC1019A	KIT 15 PZ FASCETTA ELASTICA D10 ZINCATA	<table border="1"> <thead> <tr> <th>Codice</th> <th>Descrizione</th> <th>Qtà</th> <th>UM</th> </tr> </thead> <tbody> <tr> <td>RC1019A0</td> <td>FASCETTA ELASTICA D10 ZINCATA</td> <td>17</td> <td>PZ</td> </tr> <tr> <td>VM1224A0</td> <td>TUBOLARE TERMORETR 65MY 220MM 2 COLORI</td> <td>0.200</td> <td>M</td> </tr> </tbody> </table>	Codice	Descrizione	Qtà	UM	RC1019A0	FASCETTA ELASTICA D10 ZINCATA	17	PZ	VM1224A0	TUBOLARE TERMORETR 65MY 220MM 2 COLORI	0.200	M																
Codice	Descrizione	Qtà	UM																														
RC1019A0	FASCETTA ELASTICA D10 ZINCATA	17	PZ																														
VM1224A0	TUBOLARE TERMORETR 65MY 220MM 2 COLORI	0.200	M																														
VL1081A	VALVOLA NON RITORNO BARBED D		KVL1128A	KIT VALVOLA VNR BARBED D6	<table border="1"> <thead> <tr> <th>Codice</th> <th>Descrizione</th> <th>Qtà</th> <th>UM</th> </tr> </thead> <tbody> <tr> <td>0H2143A0</td> <td>LAMIERA BLOCCA VNR VL1128</td> <td>1</td> <td>PZ</td> </tr> <tr> <td>RC1019A0</td> <td>FASCETTA ELASTICA D10 ZINCATA</td> <td>4</td> <td>PZ</td> </tr> <tr> <td>RC1130A0</td> <td>FASCETTA 130X2,6</td> <td>1</td> <td>PZ</td> </tr> <tr> <td>TB2820A0</td> <td>TUBO EPDM 6X10</td> <td>0.080</td> <td>M</td> </tr> <tr> <td>VL1128A0</td> <td>VALVOLA VNR BARBED D6</td> <td>1</td> <td>PZ</td> </tr> <tr> <td>VM1224A0</td> <td>TUBOLARE TERMORETR 65MY 220MM 2 COLORI</td> <td>0.200</td> <td>M</td> </tr> </tbody> </table>	Codice	Descrizione	Qtà	UM	0H2143A0	LAMIERA BLOCCA VNR VL1128	1	PZ	RC1019A0	FASCETTA ELASTICA D10 ZINCATA	4	PZ	RC1130A0	FASCETTA 130X2,6	1	PZ	TB2820A0	TUBO EPDM 6X10	0.080	M	VL1128A0	VALVOLA VNR BARBED D6	1	PZ	VM1224A0	TUBOLARE TERMORETR 65MY 220MM 2 COLORI	0.200	M
Codice	Descrizione	Qtà	UM																														
0H2143A0	LAMIERA BLOCCA VNR VL1128	1	PZ																														
RC1019A0	FASCETTA ELASTICA D10 ZINCATA	4	PZ																														
RC1130A0	FASCETTA 130X2,6	1	PZ																														
TB2820A0	TUBO EPDM 6X10	0.080	M																														
VL1128A0	VALVOLA VNR BARBED D6	1	PZ																														
VM1224A0	TUBOLARE TERMORETR 65MY 220MM 2 COLORI	0.200	M																														
RC1242A	TERMINALE CHIUSO D10		KRC1242A	KIT 20 PZ.TERMINALE CHIUSO Ø10	<table border="1"> <thead> <tr> <th>Codice</th> <th>Descrizione</th> <th>Qtà</th> <th>UM</th> </tr> </thead> <tbody> <tr> <td>RC1242A0</td> <td>TERMINALE CHIUSO D10</td> <td>20</td> <td>PZ</td> </tr> <tr> <td>VM1224A0</td> <td>TUBOLARE TERMORETR 65MY 220MM 2 COLORI</td> <td>0.200</td> <td>M</td> </tr> </tbody> </table>	Codice	Descrizione	Qtà	UM	RC1242A0	TERMINALE CHIUSO D10	20	PZ	VM1224A0	TUBOLARE TERMORETR 65MY 220MM 2 COLORI	0.200	M																
Codice	Descrizione	Qtà	UM																														
RC1242A0	TERMINALE CHIUSO D10	20	PZ																														
VM1224A0	TUBOLARE TERMORETR 65MY 220MM 2 COLORI	0.200	M																														

COMPONENTE			RICAMBIO															
Codice	Descrizione	Immagine	Codice	Descrizione	Lista componenti													
VL1047A	PORTAGOMMA D6 CODOLO D8		KVL1047A	KIT 10 PZ PORTAGOMMA Ø6 CODOLO Ø8	<table border="1"> <thead> <tr> <th>Codice</th> <th>Descrizione</th> <th>Qtà</th> <th>UM</th> </tr> </thead> <tbody> <tr> <td>VL1047A1</td> <td>PORTAGOMM A D6 CODOLO D8</td> <td>10</td> <td>PZ</td> </tr> <tr> <td>VM1224A0</td> <td>TUBOLARE TERMORETR 65MY 220MM 2 COLORI</td> <td>0.200</td> <td>M</td> </tr> </tbody> </table>	Codice	Descrizione	Qtà	UM	VL1047A1	PORTAGOMM A D6 CODOLO D8	10	PZ	VM1224A0	TUBOLARE TERMORETR 65MY 220MM 2 COLORI	0.200	M	
			Codice	Descrizione	Qtà	UM												
VL1047A1	PORTAGOMM A D6 CODOLO D8	10	PZ															
VM1224A0	TUBOLARE TERMORETR 65MY 220MM 2 COLORI	0.200	M															
KVL0016A	KIT 260PZ ADATTAMENTO BRITA IMP.LAVAG M	<table border="1"> <thead> <tr> <th>Codice</th> <th>Descrizione</th> <th>Qtà</th> <th>UM</th> </tr> </thead> <tbody> <tr> <td>EL1185A0</td> <td>RACCORDO A GOMITO J.GUEST Ø8F - Ø8F</td> <td>260</td> <td>PZ</td> </tr> <tr> <td>RC1018A0</td> <td>FASCETTA ELASTICA D12 ZINCATA</td> <td>520</td> <td>PZ</td> </tr> <tr> <td>VL1047A1</td> <td>PORTAGOMM A D6 CODOLO D8</td> <td>520</td> <td>PZ</td> </tr> </tbody> </table>	Codice	Descrizione	Qtà	UM	EL1185A0	RACCORDO A GOMITO J.GUEST Ø8F - Ø8F	260	PZ	RC1018A0	FASCETTA ELASTICA D12 ZINCATA	520	PZ	VL1047A1	PORTAGOMM A D6 CODOLO D8	520	PZ
Codice	Descrizione	Qtà	UM															
EL1185A0	RACCORDO A GOMITO J.GUEST Ø8F - Ø8F	260	PZ															
RC1018A0	FASCETTA ELASTICA D12 ZINCATA	520	PZ															
VL1047A1	PORTAGOMM A D6 CODOLO D8	520	PZ															
TB2994A	TB2820A0-TUBO DETERGENTE CAPPE 1M		TB2994A0	TB2820A0-TUBO DETERGENTE CAPPE 1M														
EL1020A	RACCORDO INTERMEDIO "T" TUBO D8 JG		KEL1020A	KIT 10 PZ RACCORDO T JG Ø8	<table border="1"> <thead> <tr> <th>Codice</th> <th>Descrizione</th> <th>Qtà</th> <th>UM</th> </tr> </thead> <tbody> <tr> <td>EL1020A1</td> <td>RACCORDO INTERMEDIO "T" TUBO D8 J</td> <td>10</td> <td>PZ</td> </tr> <tr> <td>VM1224A0</td> <td>TUBOLARE TERMORETR 65MY 220MM 2 COLORI</td> <td>0.200</td> <td>M</td> </tr> </tbody> </table>	Codice	Descrizione	Qtà	UM	EL1020A1	RACCORDO INTERMEDIO "T" TUBO D8 J	10	PZ	VM1224A0	TUBOLARE TERMORETR 65MY 220MM 2 COLORI	0.200	M	
					Codice	Descrizione	Qtà	UM										
EL1020A1	RACCORDO INTERMEDIO "T" TUBO D8 J	10	PZ															
VM1224A0	TUBOLARE TERMORETR 65MY 220MM 2 COLORI	0.200	M															
<table border="1"> <thead> <tr> <th>Codice</th> <th>Descrizione</th> <th>Qtà</th> <th>UM</th> </tr> </thead> <tbody> <tr> <td>VL1054B0</td> <td>DISTRIBUTORE E INGRESSI LAVAGGIO ON</td> <td>1</td> <td>PZ</td> </tr> <tr> <td>VM1224A0</td> <td>TUBOLARE TERMORETR 65MY 220MM 2 COLORI</td> <td>0.250</td> <td>M</td> </tr> </tbody> </table>	Codice	Descrizione	Qtà	UM	VL1054B0	DISTRIBUTORE E INGRESSI LAVAGGIO ON	1	PZ	VM1224A0	TUBOLARE TERMORETR 65MY 220MM 2 COLORI	0.250	M						
Codice	Descrizione	Qtà	UM															
VL1054B0	DISTRIBUTORE E INGRESSI LAVAGGIO ON	1	PZ															
VM1224A0	TUBOLARE TERMORETR 65MY 220MM 2 COLORI	0.250	M															
VL1054B	DISTRIBUTORE INGRESSI LAVAGGIO ONE		KVL1054B	KIT DISTRIBUTORE INGRESSI LAVAGGIO ONE														

COMPONENTE			RICAMBIO																																																		
Codice	Descrizione	Immagine	Codice	Descrizione	Lista componenti																																																
VL1053B	DISTRIBUTORE USCITA LAVAGGIO ONE		KVL1072A	KIT POMPA IMPIANTO LAVAGGIO ONE	<table border="1"> <thead> <tr> <th>Codice</th> <th>Descrizione</th> <th>Qtà</th> <th>UM</th> </tr> </thead> <tbody> <tr> <td>0H2143A0</td> <td>LAMIERA BLOCCA VNR VL1128</td> <td>1</td> <td>PZ</td> </tr> <tr> <td>GN1526A0</td> <td>O-RING D.INT6.9 SP1.8</td> <td>1</td> <td>PZ</td> </tr> <tr> <td>RC1019A0</td> <td>FASCETTA ELASTICA D10 ZINCATA</td> <td>6</td> <td>PZ</td> </tr> <tr> <td>RC1242A0</td> <td>TERMINALE CHIUSO D10</td> <td>2</td> <td>PZ</td> </tr> <tr> <td>TB2820A0</td> <td>TUBO EPDM 6X10</td> <td>0.120</td> <td>M</td> </tr> <tr> <td>VI1220A1</td> <td>VITE AUTOFILETTA NTE 4.2X11 TCS+ MARUTE</td> <td>1</td> <td>PZ</td> </tr> <tr> <td>VL1019A0</td> <td>POMPA VIBRAZIONE</td> <td>1</td> <td>PZ</td> </tr> <tr> <td>VL1053B0</td> <td>DISTRIBUTORE USCITA LAVAGGIO ON</td> <td>1</td> <td>PZ</td> </tr> <tr> <td>VL1054B0</td> <td>DISTRIBUTORE INGRESSI LAVAGGIO ON</td> <td>1</td> <td>PZ</td> </tr> <tr> <td>VL1128A0</td> <td>VALVOLA VNR BARBED D6</td> <td>1</td> <td>PZ</td> </tr> <tr> <td>VM2172A0</td> <td>CLIP BLOCCAGGIO POMPA CON CIRCUITO</td> <td>1</td> <td>PZ</td> </tr> </tbody> </table>	Codice	Descrizione	Qtà	UM	0H2143A0	LAMIERA BLOCCA VNR VL1128	1	PZ	GN1526A0	O-RING D.INT6.9 SP1.8	1	PZ	RC1019A0	FASCETTA ELASTICA D10 ZINCATA	6	PZ	RC1242A0	TERMINALE CHIUSO D10	2	PZ	TB2820A0	TUBO EPDM 6X10	0.120	M	VI1220A1	VITE AUTOFILETTA NTE 4.2X11 TCS+ MARUTE	1	PZ	VL1019A0	POMPA VIBRAZIONE	1	PZ	VL1053B0	DISTRIBUTORE USCITA LAVAGGIO ON	1	PZ	VL1054B0	DISTRIBUTORE INGRESSI LAVAGGIO ON	1	PZ	VL1128A0	VALVOLA VNR BARBED D6	1	PZ	VM2172A0	CLIP BLOCCAGGIO POMPA CON CIRCUITO	1	PZ
Codice	Descrizione	Qtà	UM																																																		
0H2143A0	LAMIERA BLOCCA VNR VL1128	1	PZ																																																		
GN1526A0	O-RING D.INT6.9 SP1.8	1	PZ																																																		
RC1019A0	FASCETTA ELASTICA D10 ZINCATA	6	PZ																																																		
RC1242A0	TERMINALE CHIUSO D10	2	PZ																																																		
TB2820A0	TUBO EPDM 6X10	0.120	M																																																		
VI1220A1	VITE AUTOFILETTA NTE 4.2X11 TCS+ MARUTE	1	PZ																																																		
VL1019A0	POMPA VIBRAZIONE	1	PZ																																																		
VL1053B0	DISTRIBUTORE USCITA LAVAGGIO ON	1	PZ																																																		
VL1054B0	DISTRIBUTORE INGRESSI LAVAGGIO ON	1	PZ																																																		
VL1128A0	VALVOLA VNR BARBED D6	1	PZ																																																		
VM2172A0	CLIP BLOCCAGGIO POMPA CON CIRCUITO	1	PZ																																																		
RC1408A	FASCETTA BIFILARE A MOLLA D10.8 TUBO ZN		KRC1408A	KIT FASCETTA BIFILARE A MOLLA D10.8 4PZ	<table border="1"> <thead> <tr> <th>Codice</th> <th>Descrizione</th> <th>Qtà</th> <th>UM</th> </tr> </thead> <tbody> <tr> <td>RC1408A0</td> <td>FASCETTA BIFILARE A MOLLA D10.8 TUBO ZN</td> <td>4</td> <td>PZ</td> </tr> <tr> <td>VM1224A0</td> <td>TUBOLARE TERMORETR 65MY 220MM 2 COLORI</td> <td>0.200</td> <td>M</td> </tr> </tbody> </table>	Codice	Descrizione	Qtà	UM	RC1408A0	FASCETTA BIFILARE A MOLLA D10.8 TUBO ZN	4	PZ	VM1224A0	TUBOLARE TERMORETR 65MY 220MM 2 COLORI	0.200	M																																				
Codice	Descrizione	Qtà	UM																																																		
RC1408A0	FASCETTA BIFILARE A MOLLA D10.8 TUBO ZN	4	PZ																																																		
VM1224A0	TUBOLARE TERMORETR 65MY 220MM 2 COLORI	0.200	M																																																		
0H7368A	LAMIERA IMPIANTO IDRICO CAPPA S6		0H7368A0	LAMIERA IMPIANTO IDRICO CAPPA S6																																																	

COMPONENTE			RICAMBIO																						
Codice	Descrizione	Immagine	Codice	Descrizione	Lista componenti																				
VL1102A	FILTRO IN LINEA CON VNR BARBED 6 MM		KVL1102A	KIT FILTRO IN LINEA DETERGENTE CON VNR	<table border="1"> <thead> <tr> <th>Codice</th> <th>Descrizione</th> <th>Qtà</th> <th>UM</th> </tr> </thead> <tbody> <tr> <td>RC1019A0</td> <td>FASCETTA ELASTICA D10 ZINCATA</td> <td>5</td> <td>PZ</td> </tr> <tr> <td>TB2820A0</td> <td>TUBO EPDM 6X10</td> <td>0.710</td> <td>M</td> </tr> <tr> <td>VL1102A1</td> <td>FILTRO IN LINEA DET. + VNR BARBED 6 MM</td> <td>1</td> <td>PZ</td> </tr> <tr> <td>VM1224A0</td> <td>TUBOLARE TERMORETR 65MY 220MM 2 COLORI</td> <td>0.300</td> <td>M</td> </tr> </tbody> </table>	Codice	Descrizione	Qtà	UM	RC1019A0	FASCETTA ELASTICA D10 ZINCATA	5	PZ	TB2820A0	TUBO EPDM 6X10	0.710	M	VL1102A1	FILTRO IN LINEA DET. + VNR BARBED 6 MM	1	PZ	VM1224A0	TUBOLARE TERMORETR 65MY 220MM 2 COLORI	0.300	M
Codice	Descrizione	Qtà	UM																						
RC1019A0	FASCETTA ELASTICA D10 ZINCATA	5	PZ																						
TB2820A0	TUBO EPDM 6X10	0.710	M																						
VL1102A1	FILTRO IN LINEA DET. + VNR BARBED 6 MM	1	PZ																						
VM1224A0	TUBOLARE TERMORETR 65MY 220MM 2 COLORI	0.300	M																						