





Assembly code	Assembly revision	Assembly image
ASM3045A/0.D00	External cover	
ASM3047A/0.D00	General overview	
ASM3046B/0.D00	General overview	

**ASM3045A/0.D00 - External cover**

**FRONT**

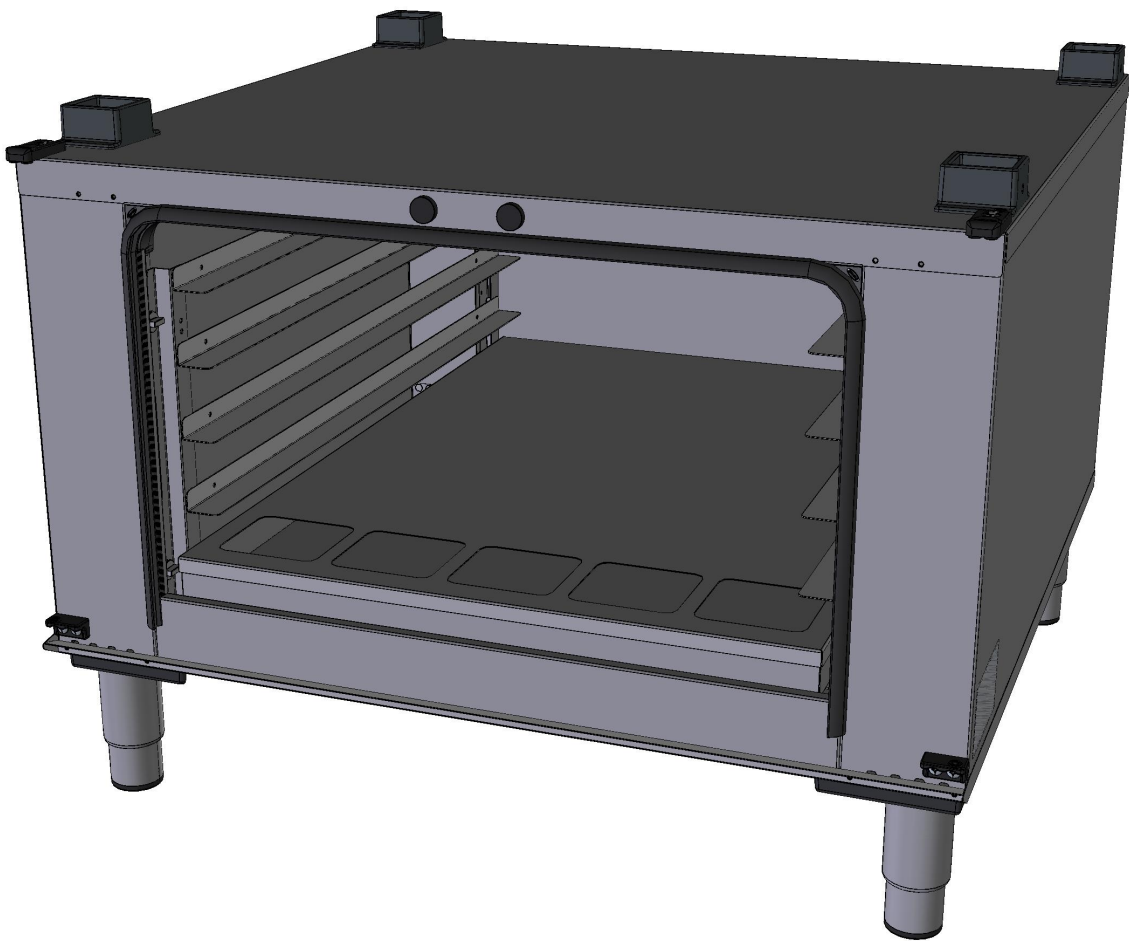



**ASM3045A/0.D00 - External cover**

**REAR**

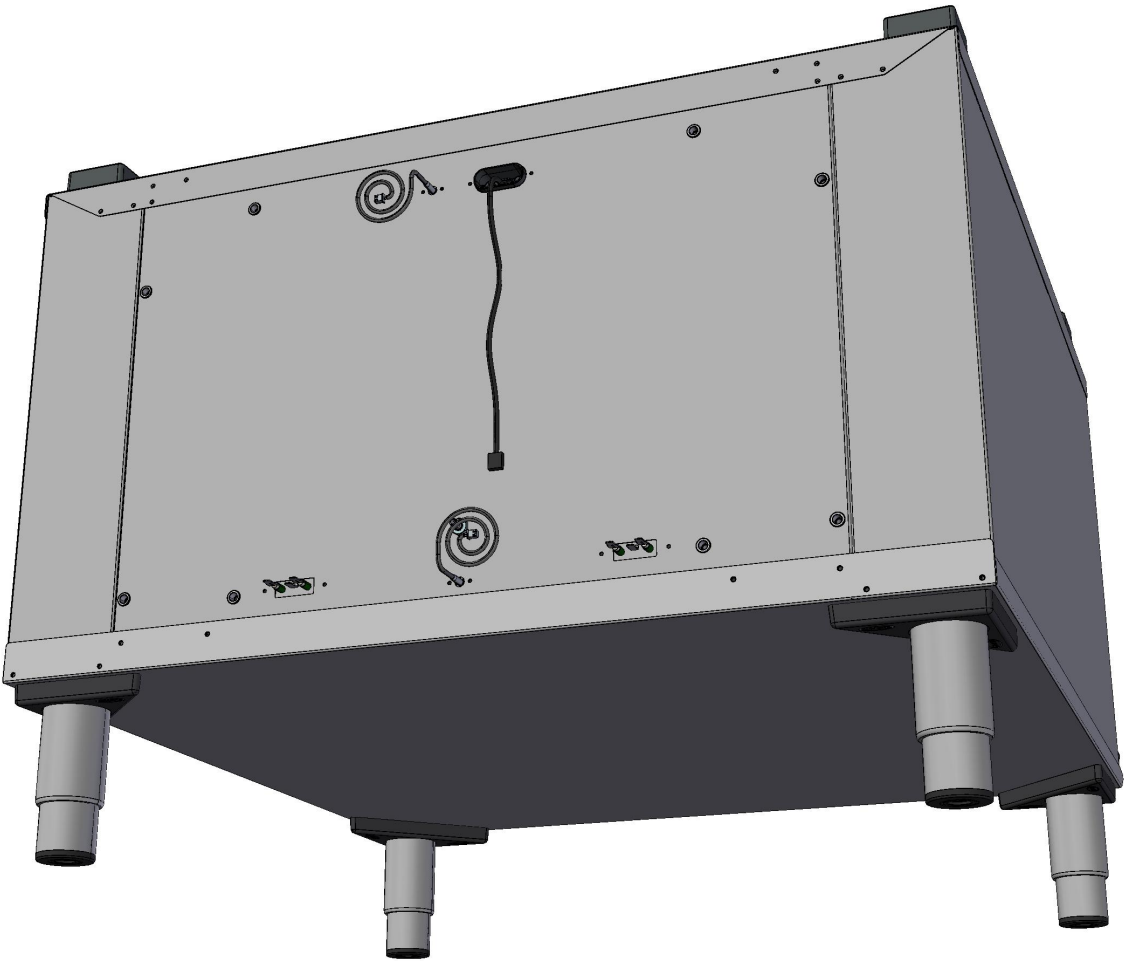



COMPONENT			SPARE PART																		
Code	Description	Image	Code	Description	Components list																
VM1820A	LATERAL SUPPORTS M6 FIXING BOLT		KVM1820A	THUMB SCREW 10PCS KIT	<table border="1"> <thead> <tr> <th>Code</th> <th>Description</th> <th>Qty</th> <th>UOM</th> </tr> </thead> <tbody> <tr> <td>VM1224A0</td> <td></td> <td>0.200</td> <td>M</td> </tr> <tr> <td>VM1820A0</td> <td>LATERAL SUPPORTS M6 FIXING BOLT</td> <td>10</td> <td>PZ</td> </tr> </tbody> </table>	Code	Description	Qty	UOM	VM1224A0		0.200	M	VM1820A0	LATERAL SUPPORTS M6 FIXING BOLT	10	PZ				
Code	Description	Qty	UOM																		
VM1224A0		0.200	M																		
VM1820A0	LATERAL SUPPORTS M6 FIXING BOLT	10	PZ																		
PD1075A	FOOT LOCKING BRACKET		KPD1075A	OVEN FOOT STOPPING BRACKET KIT	<table border="1"> <thead> <tr> <th>Code</th> <th>Description</th> <th>Qty</th> <th>UOM</th> </tr> </thead> <tbody> <tr> <td>PD1075A0</td> <td>FOOT LOCKING BRACKET</td> <td>4</td> <td>PZ</td> </tr> <tr> <td>PD1075A1</td> <td>PD1074 FOOT LOCKING BRACKET</td> <td>4</td> <td>PZ</td> </tr> <tr> <td>VI1950A0</td> <td>ST. STEEL 4,2X13 TCB SELF-DRILLING SCREW</td> <td>8</td> <td>PZ</td> </tr> </tbody> </table>	Code	Description	Qty	UOM	PD1075A0	FOOT LOCKING BRACKET	4	PZ	PD1075A1	PD1074 FOOT LOCKING BRACKET	4	PZ	VI1950A0	ST. STEEL 4,2X13 TCB SELF-DRILLING SCREW	8	PZ
Code	Description	Qty	UOM																		
PD1075A0	FOOT LOCKING BRACKET	4	PZ																		
PD1075A1	PD1074 FOOT LOCKING BRACKET	4	PZ																		
VI1950A0	ST. STEEL 4,2X13 TCB SELF-DRILLING SCREW	8	PZ																		
0D2283A	EU VERSION ELECTRONIC PROOFER EXT.COVER		0D2283A0	EU VERSION ELECTRONIC PROOFER EXT.COVER																	
PD1064A	100-150MM ADJUSTABLE FOOT		XR608	E SERIES 150 MM FEET KIT	<table border="1"> <thead> <tr> <th>Code</th> <th>Description</th> <th>Qty</th> <th>UOM</th> </tr> </thead> <tbody> <tr> <td>PD1064A0</td> <td>100-150MM ADJUSTABLE FOOT</td> <td>4</td> <td>PZ</td> </tr> </tbody> </table>	Code	Description	Qty	UOM	PD1064A0	100-150MM ADJUSTABLE FOOT	4	PZ								
Code	Description	Qty	UOM																		
PD1064A0	100-150MM ADJUSTABLE FOOT	4	PZ																		
0H7389A	EUROPEAN PROOFER HORIZ GASKET GUIDE		0H7389A0	EUROPEAN PROOFER HORIZ GASKET GUIDE																	



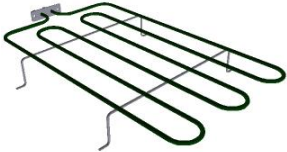

COMPONENT			SPARE PART																		
Code	Description	Image	Code	Description	Components list																
VM1645A	XL405 PROOFER GASKET CORNER		VM1645A1	XL405 PROOFER GASKET CORNER																	
0H7206A	EUROPEAN PROOFER FRONT BARRIER		0H7206A0	EUROPEAN PROOFER FRONT BARRIER																	
VE1607A	RUBBER MAGNETIC SUCTION CUP		KVE1607A	MAGNETIC SUCTION CUP	<table border="1"> <thead> <tr> <th>Code</th> <th>Description</th> <th>Qty</th> <th>UOM</th> </tr> </thead> <tbody> <tr> <td>VE1607A1</td> <td>RUBBER MAGNETIC SUCTION CUP</td> <td>2</td> <td>PZ</td> </tr> <tr> <td>VI1700A0</td> <td>18X6.4X1.5 STAINLESS STEEL FLAT WASHER</td> <td>2</td> <td>PZ</td> </tr> <tr> <td>VM1224A0</td> <td></td> <td>0.200</td> <td>M</td> </tr> </tbody> </table>	Code	Description	Qty	UOM	VE1607A1	RUBBER MAGNETIC SUCTION CUP	2	PZ	VI1700A0	18X6.4X1.5 STAINLESS STEEL FLAT WASHER	2	PZ	VM1224A0		0.200	M
Code	Description	Qty	UOM																		
VE1607A1	RUBBER MAGNETIC SUCTION CUP	2	PZ																		
VI1700A0	18X6.4X1.5 STAINLESS STEEL FLAT WASHER	2	PZ																		
VM1224A0		0.200	M																		
VM1022B	PROOFER DOOR UPPER BRACKET		KVM1022B	PROOFER DOOR UPPER BRACKET	<table border="1"> <thead> <tr> <th>Code</th> <th>Description</th> <th>Qty</th> <th>UOM</th> </tr> </thead> <tbody> <tr> <td>VM1022B0</td> <td>PROOFER DOOR UPPER BRACKET</td> <td>1</td> <td>PZ</td> </tr> <tr> <td>VM1224A0</td> <td></td> <td>0.150</td> <td>M</td> </tr> </tbody> </table>	Code	Description	Qty	UOM	VM1022B0	PROOFER DOOR UPPER BRACKET	1	PZ	VM1224A0		0.150	M				
Code	Description	Qty	UOM																		
VM1022B0	PROOFER DOOR UPPER BRACKET	1	PZ																		
VM1224A0		0.150	M																		
VM1024B	PROOFER DOOR LEFT LOWER BRACKET		KVM1024B	PROOFER DOOR LEFT+RIGHT LOWER BRACKET KI	<table border="1"> <thead> <tr> <th>Code</th> <th>Description</th> <th>Qty</th> <th>UOM</th> </tr> </thead> <tbody> <tr> <td>VM1023B0</td> <td>PROOFER DOOR RIGHT LOWER BRACKET</td> <td>1</td> <td>PZ</td> </tr> <tr> <td>VM1024B0</td> <td>PROOFER DOOR LEFT LOWER BRACKET</td> <td>1</td> <td>PZ</td> </tr> <tr> <td>VM1224A0</td> <td></td> <td>0.150</td> <td>M</td> </tr> </tbody> </table>	Code	Description	Qty	UOM	VM1023B0	PROOFER DOOR RIGHT LOWER BRACKET	1	PZ	VM1024B0	PROOFER DOOR LEFT LOWER BRACKET	1	PZ	VM1224A0		0.150	M
Code	Description	Qty	UOM																		
VM1023B0	PROOFER DOOR RIGHT LOWER BRACKET	1	PZ																		
VM1024B0	PROOFER DOOR LEFT LOWER BRACKET	1	PZ																		
VM1224A0		0.150	M																		



COMPONENT			SPARE PART																														
Code	Description	Image	Code	Description	Components list																												
VM1023B	PROOFER DOOR RIGHT LOWER BRACKET		KVM1024A	PROOFER LF/RG DOOR LOWER BRACKET KIT	<table border="1"> <thead> <tr> <th>Code</th> <th>Description</th> <th>Qty</th> <th>UOM</th> </tr> </thead> <tbody> <tr> <td>VM1023A0</td> <td>PROOFER DOOR RIGHT LOWER BRACKET</td> <td>1</td> <td>PZ</td> </tr> <tr> <td>VM1024A0</td> <td>PROOFER DOOR LEFT LOWER BRACKET</td> <td>1</td> <td>PZ</td> </tr> <tr> <td>VM1224A0</td> <td></td> <td>0.250</td> <td>M</td> </tr> </tbody> </table>	Code	Description	Qty	UOM	VM1023A0	PROOFER DOOR RIGHT LOWER BRACKET	1	PZ	VM1024A0	PROOFER DOOR LEFT LOWER BRACKET	1	PZ	VM1224A0		0.250	M												
Code	Description	Qty	UOM																														
VM1023A0	PROOFER DOOR RIGHT LOWER BRACKET	1	PZ																														
VM1024A0	PROOFER DOOR LEFT LOWER BRACKET	1	PZ																														
VM1224A0		0.250	M																														
0H7211A	EUROPEAN PROOFER WATER TRAY		0H7211A0	EUROPEAN PROOFER WATER TRAY																													
RS1095A	HEATING ELEMENT 1200W 230V		KRS1095A	1.2KW HEATING ELEMENT KIT	<table border="1"> <thead> <tr> <th>Code</th> <th>Description</th> <th>Qty</th> <th>UOM</th> </tr> </thead> <tbody> <tr> <td>GN1326A1</td> <td>ELEMENT SEALING</td> <td>1</td> <td>PZ</td> </tr> <tr> <td>IP1385A1</td> <td>CORNER POLYSTYREN E PACKING 110X80X2000</td> <td>0.500</td> <td>M</td> </tr> <tr> <td>RS1095A1</td> <td>HEATING ELEMENT 1200W 230V</td> <td>1</td> <td>PZ</td> </tr> <tr> <td>SL1045A0</td> <td>S57 BLACK SILICONE - 80ML CARTRIDGE</td> <td>1</td> <td>PZ</td> </tr> <tr> <td>VI1220A1</td> <td>4,2X12 TCB SELF-TAPPIN G SCREW</td> <td>2</td> <td>PZ</td> </tr> <tr> <td>VM1059A1</td> <td>HEAT SHRINK FILM H800</td> <td>1.200</td> <td>M</td> </tr> </tbody> </table>	Code	Description	Qty	UOM	GN1326A1	ELEMENT SEALING	1	PZ	IP1385A1	CORNER POLYSTYREN E PACKING 110X80X2000	0.500	M	RS1095A1	HEATING ELEMENT 1200W 230V	1	PZ	SL1045A0	S57 BLACK SILICONE - 80ML CARTRIDGE	1	PZ	VI1220A1	4,2X12 TCB SELF-TAPPIN G SCREW	2	PZ	VM1059A1	HEAT SHRINK FILM H800	1.200	M
Code	Description	Qty	UOM																														
GN1326A1	ELEMENT SEALING	1	PZ																														
IP1385A1	CORNER POLYSTYREN E PACKING 110X80X2000	0.500	M																														
RS1095A1	HEATING ELEMENT 1200W 230V	1	PZ																														
SL1045A0	S57 BLACK SILICONE - 80ML CARTRIDGE	1	PZ																														
VI1220A1	4,2X12 TCB SELF-TAPPIN G SCREW	2	PZ																														
VM1059A1	HEAT SHRINK FILM H800	1.200	M																														
0D2317A	8 600X400 PROOFER EXTERNAL SIDE PANEL		0D2317A0	8 600X400 PROOFER EXTERNAL SIDE PANEL																													



COMPONENT			SPARE PART																																		
Code	Description	Image	Code	Description	Components list																																
GN1285A	NTC TEMPERATURE PROBE SEALING		KTR1106B	MIND.MAPS L2000 CHAMBER TEMP. PROBE KIT	<table border="1"> <thead> <tr> <th>Code</th> <th>Description</th> <th>Qty</th> <th>UOM</th> </tr> </thead> <tbody> <tr> <td>GN1285A0</td> <td>NTC TEMPERATUR E PROBE SEALING</td> <td>1</td> <td>PZ</td> </tr> <tr> <td>SL1045A0</td> <td>S57 BLACK SILICONE - 80ML CARTRIDGE</td> <td>1</td> <td>PZ</td> </tr> <tr> <td>TR1106B0</td> <td></td> <td>1</td> <td>PZ</td> </tr> <tr> <td>VI1220A1</td> <td>4,2X12 TCB SELF-TAPPIN G SCREW</td> <td>2</td> <td>PZ</td> </tr> <tr> <td>VM1464A1</td> <td>CT BT TEMPERATUR E PROBE COVER</td> <td>1</td> <td>PZ</td> </tr> <tr> <td>VM1465A0</td> <td>CHEFTOP TEMPERATUR E PROBE COVER</td> <td>1</td> <td>PZ</td> </tr> <tr> <td>VM1465A1</td> <td>CT BT TEMPERATUR E PROBE COVER</td> <td>1</td> <td>PZ</td> </tr> </tbody> </table>	Code	Description	Qty	UOM	GN1285A0	NTC TEMPERATUR E PROBE SEALING	1	PZ	SL1045A0	S57 BLACK SILICONE - 80ML CARTRIDGE	1	PZ	TR1106B0		1	PZ	VI1220A1	4,2X12 TCB SELF-TAPPIN G SCREW	2	PZ	VM1464A1	CT BT TEMPERATUR E PROBE COVER	1	PZ	VM1465A0	CHEFTOP TEMPERATUR E PROBE COVER	1	PZ	VM1465A1	CT BT TEMPERATUR E PROBE COVER	1	PZ
			Code	Description	Qty	UOM																															
			GN1285A0	NTC TEMPERATUR E PROBE SEALING	1	PZ																															
SL1045A0	S57 BLACK SILICONE - 80ML CARTRIDGE	1	PZ																																		
TR1106B0		1	PZ																																		
VI1220A1	4,2X12 TCB SELF-TAPPIN G SCREW	2	PZ																																		
VM1464A1	CT BT TEMPERATUR E PROBE COVER	1	PZ																																		
VM1465A0	CHEFTOP TEMPERATUR E PROBE COVER	1	PZ																																		
VM1465A1	CT BT TEMPERATUR E PROBE COVER	1	PZ																																		
KTR1106A	5-5E S. L2000 CHAMBER TEMP. PROBE KIT	<table border="1"> <thead> <tr> <th>Code</th> <th>Description</th> <th>Qty</th> <th>UOM</th> </tr> </thead> <tbody> <tr> <td>GN1285A0</td> <td>NTC TEMPERATUR E PROBE SEALING</td> <td>1</td> <td>PZ</td> </tr> <tr> <td>SL1045A0</td> <td>S57 BLACK SILICONE - 80ML CARTRIDGE</td> <td>1</td> <td>PZ</td> </tr> <tr> <td>TR1106A3</td> <td>PT100 L=2000 TEMPERATUR E PROBE</td> <td>1</td> <td>PZ</td> </tr> <tr> <td>VI1220A1</td> <td>4,2X12 TCB SELF-TAPPIN G SCREW</td> <td>2</td> <td>PZ</td> </tr> <tr> <td>VM1465A0</td> <td>CHEFTOP TEMPERATUR E PROBE COVER</td> <td>1</td> <td>PZ</td> </tr> <tr> <td>VM1465A1</td> <td>CT BT TEMPERATUR E PROBE COVER</td> <td>1</td> <td>PZ</td> </tr> </tbody> </table>	Code	Description	Qty	UOM	GN1285A0	NTC TEMPERATUR E PROBE SEALING	1	PZ	SL1045A0	S57 BLACK SILICONE - 80ML CARTRIDGE	1	PZ	TR1106A3	PT100 L=2000 TEMPERATUR E PROBE	1	PZ	VI1220A1	4,2X12 TCB SELF-TAPPIN G SCREW	2	PZ	VM1465A0	CHEFTOP TEMPERATUR E PROBE COVER	1	PZ	VM1465A1	CT BT TEMPERATUR E PROBE COVER	1	PZ							
Code	Description	Qty	UOM																																		
GN1285A0	NTC TEMPERATUR E PROBE SEALING	1	PZ																																		
SL1045A0	S57 BLACK SILICONE - 80ML CARTRIDGE	1	PZ																																		
TR1106A3	PT100 L=2000 TEMPERATUR E PROBE	1	PZ																																		
VI1220A1	4,2X12 TCB SELF-TAPPIN G SCREW	2	PZ																																		
VM1465A0	CHEFTOP TEMPERATUR E PROBE COVER	1	PZ																																		
VM1465A1	CT BT TEMPERATUR E PROBE COVER	1	PZ																																		
KTR1105A	PT100 L1000 TEMPERATURE PROBE KIT	<table border="1"> <thead> <tr> <th>Code</th> <th>Description</th> <th>Qty</th> <th>UOM</th> </tr> </thead> <tbody> <tr> <td>GN1120A0</td> <td>TEMPERATUR E PROBE NTC SEAL</td> <td>1</td> <td>PZ</td> </tr> <tr> <td>GN1120A1</td> <td></td> <td>1</td> <td>PZ</td> </tr> </tbody> </table>	Code	Description	Qty	UOM	GN1120A0	TEMPERATUR E PROBE NTC SEAL	1	PZ	GN1120A1		1	PZ																							
Code	Description	Qty	UOM																																		
GN1120A0	TEMPERATUR E PROBE NTC SEAL	1	PZ																																		
GN1120A1		1	PZ																																		

COMPONENT			SPARE PART																																						
Code	Description	Image	Code	Description	Components list																																				
GN1285A	NTC TEMPERATURE PROBE SEALING		KTR1105A	PT100 L1000 TEMPERATURE PROBE KIT	<table border="1"> <thead> <tr> <th>Code</th> <th>Description</th> <th>Qty</th> <th>UOM</th> </tr> </thead> <tbody> <tr> <td>GN1285A0</td> <td>NTC TEMPERATUR E PROBE SEALING</td> <td>1</td> <td>PZ</td> </tr> <tr> <td>MOV0010A0</td> <td>HOOD RING GASKET GN1110A2</td> <td>0.100</td> <td>PZ</td> </tr> <tr> <td>SL1045A0</td> <td>S57 BLACK SILICONE - 80ML CARTRIDGE</td> <td>1</td> <td>PZ</td> </tr> <tr> <td>TR1105A4</td> <td></td> <td>1</td> <td>PZ</td> </tr> <tr> <td>VI1220A1</td> <td>4,2X12 TCB SELF-TAPPIN G SCREW</td> <td>2</td> <td>PZ</td> </tr> <tr> <td>VM1464A1</td> <td>CT BT TEMPERATUR E PROBE COVER</td> <td>1</td> <td>PZ</td> </tr> <tr> <td>VM1465A1</td> <td>CT BT TEMPERATUR E PROBE COVER</td> <td>1</td> <td>PZ</td> </tr> <tr> <td>VM2052A0</td> <td>LM CORE PROBE COVE</td> <td>1</td> <td>PZ</td> </tr> </tbody> </table>	Code	Description	Qty	UOM	GN1285A0	NTC TEMPERATUR E PROBE SEALING	1	PZ	MOV0010A0	HOOD RING GASKET GN1110A2	0.100	PZ	SL1045A0	S57 BLACK SILICONE - 80ML CARTRIDGE	1	PZ	TR1105A4		1	PZ	VI1220A1	4,2X12 TCB SELF-TAPPIN G SCREW	2	PZ	VM1464A1	CT BT TEMPERATUR E PROBE COVER	1	PZ	VM1465A1	CT BT TEMPERATUR E PROBE COVER	1	PZ	VM2052A0	LM CORE PROBE COVE	1	PZ
			Code	Description	Qty	UOM																																			
GN1285A0	NTC TEMPERATUR E PROBE SEALING	1	PZ																																						
MOV0010A0	HOOD RING GASKET GN1110A2	0.100	PZ																																						
SL1045A0	S57 BLACK SILICONE - 80ML CARTRIDGE	1	PZ																																						
TR1105A4		1	PZ																																						
VI1220A1	4,2X12 TCB SELF-TAPPIN G SCREW	2	PZ																																						
VM1464A1	CT BT TEMPERATUR E PROBE COVER	1	PZ																																						
VM1465A1	CT BT TEMPERATUR E PROBE COVER	1	PZ																																						
VM2052A0	LM CORE PROBE COVE	1	PZ																																						
KTR1096A	NTC 150 L=1500 TEMPERATURE PROBE KIT	<table border="1"> <thead> <tr> <th>Code</th> <th>Description</th> <th>Qty</th> <th>UOM</th> </tr> </thead> <tbody> <tr> <td>GN1120A0</td> <td>TEMPERATUR E PROBE NTC SEAL</td> <td>1</td> <td>PZ</td> </tr> <tr> <td>GN1120A1</td> <td></td> <td>1</td> <td>PZ</td> </tr> <tr> <td>GN1285A0</td> <td>NTC TEMPERATUR E PROBE SEALING</td> <td>2</td> <td>PZ</td> </tr> <tr> <td>SL1045A0</td> <td>S57 BLACK SILICONE - 80ML CARTRIDGE</td> <td>1</td> <td>PZ</td> </tr> <tr> <td>TR1096A0</td> <td>TEMPERATUR E PROBE NTC 150 L=1500</td> <td>1</td> <td>PZ</td> </tr> <tr> <td>VI1220A1</td> <td>4,2X12 TCB SELF-TAPPIN G SCREW</td> <td>2</td> <td>PZ</td> </tr> <tr> <td>VM1465A0</td> <td>CHEFTOP TEMPERATUR E PROBE COVER</td> <td>1</td> <td>PZ</td> </tr> <tr> <td>VM1465A1</td> <td>CT BT TEMPERATUR E PROBE COVER</td> <td>1</td> <td>PZ</td> </tr> </tbody> </table>	Code	Description	Qty	UOM	GN1120A0	TEMPERATUR E PROBE NTC SEAL	1	PZ	GN1120A1		1	PZ	GN1285A0	NTC TEMPERATUR E PROBE SEALING	2	PZ	SL1045A0	S57 BLACK SILICONE - 80ML CARTRIDGE	1	PZ	TR1096A0	TEMPERATUR E PROBE NTC 150 L=1500	1	PZ	VI1220A1	4,2X12 TCB SELF-TAPPIN G SCREW	2	PZ	VM1465A0	CHEFTOP TEMPERATUR E PROBE COVER	1	PZ	VM1465A1	CT BT TEMPERATUR E PROBE COVER	1	PZ			
Code	Description	Qty	UOM																																						
GN1120A0	TEMPERATUR E PROBE NTC SEAL	1	PZ																																						
GN1120A1		1	PZ																																						
GN1285A0	NTC TEMPERATUR E PROBE SEALING	2	PZ																																						
SL1045A0	S57 BLACK SILICONE - 80ML CARTRIDGE	1	PZ																																						
TR1096A0	TEMPERATUR E PROBE NTC 150 L=1500	1	PZ																																						
VI1220A1	4,2X12 TCB SELF-TAPPIN G SCREW	2	PZ																																						
VM1465A0	CHEFTOP TEMPERATUR E PROBE COVER	1	PZ																																						
VM1465A1	CT BT TEMPERATUR E PROBE COVER	1	PZ																																						







COMPONENT			SPARE PART																																						
Code	Description	Image	Code	Description	Components list																																				
GN1285A	NTC TEMPERATURE PROBE SEALING		KTR1095A	NTC 150 L=1050 TEMPERATURE PROBE KIT	<table border="1"> <thead> <tr> <th>Code</th> <th>Description</th> <th>Qty</th> <th>UOM</th> </tr> </thead> <tbody> <tr> <td>GN1120A0</td> <td>TEMPERATUR E PROBE NTC SEAL</td> <td>1</td> <td>PZ</td> </tr> <tr> <td>GN1120A1</td> <td></td> <td>1</td> <td>PZ</td> </tr> <tr> <td>GN1285A0</td> <td>NTC TEMPERATUR E PROBE SEALING</td> <td>1</td> <td>PZ</td> </tr> <tr> <td>SL1045A0</td> <td>S57 BLACK SILICONE - 80ML CARTRIDGE</td> <td>1</td> <td>PZ</td> </tr> <tr> <td>TR1095A0</td> <td>TEMPERATUR E PROBE NTC 150 L=1050</td> <td>1</td> <td>PZ</td> </tr> <tr> <td>VI1220A1</td> <td>4,2X12 TCB SELF-TAPPIN G SCREW</td> <td>2</td> <td>PZ</td> </tr> <tr> <td>VM1465A0</td> <td>CHEFTOP TEMPERATUR E PROBE COVER</td> <td>1</td> <td>PZ</td> </tr> <tr> <td>VM1465A1</td> <td>CT BT TEMPERATUR E PROBE COVER</td> <td>1</td> <td>PZ</td> </tr> </tbody> </table>	Code	Description	Qty	UOM	GN1120A0	TEMPERATUR E PROBE NTC SEAL	1	PZ	GN1120A1		1	PZ	GN1285A0	NTC TEMPERATUR E PROBE SEALING	1	PZ	SL1045A0	S57 BLACK SILICONE - 80ML CARTRIDGE	1	PZ	TR1095A0	TEMPERATUR E PROBE NTC 150 L=1050	1	PZ	VI1220A1	4,2X12 TCB SELF-TAPPIN G SCREW	2	PZ	VM1465A0	CHEFTOP TEMPERATUR E PROBE COVER	1	PZ	VM1465A1	CT BT TEMPERATUR E PROBE COVER	1	PZ
			Code	Description	Qty	UOM																																			
GN1120A0	TEMPERATUR E PROBE NTC SEAL	1	PZ																																						
GN1120A1		1	PZ																																						
GN1285A0	NTC TEMPERATUR E PROBE SEALING	1	PZ																																						
SL1045A0	S57 BLACK SILICONE - 80ML CARTRIDGE	1	PZ																																						
TR1095A0	TEMPERATUR E PROBE NTC 150 L=1050	1	PZ																																						
VI1220A1	4,2X12 TCB SELF-TAPPIN G SCREW	2	PZ																																						
VM1465A0	CHEFTOP TEMPERATUR E PROBE COVER	1	PZ																																						
VM1465A1	CT BT TEMPERATUR E PROBE COVER	1	PZ																																						
KTR1002A	PT100 L1000 UL TEMPERATURE PROBE KIT	<table border="1"> <thead> <tr> <th>Code</th> <th>Description</th> <th>Qty</th> <th>UOM</th> </tr> </thead> <tbody> <tr> <td>GN1285A0</td> <td>NTC TEMPERATUR E PROBE SEALING</td> <td>2</td> <td>PZ</td> </tr> <tr> <td>SL1045A0</td> <td>S57 BLACK SILICONE - 80ML CARTRIDGE</td> <td>1</td> <td>PZ</td> </tr> <tr> <td>TR1002A1</td> <td></td> <td>1</td> <td>PZ</td> </tr> <tr> <td>VI1220A1</td> <td>4,2X12 TCB SELF-TAPPIN G SCREW</td> <td>2</td> <td>PZ</td> </tr> <tr> <td>VM1465A0</td> <td>CHEFTOP TEMPERATUR E PROBE COVER</td> <td>1</td> <td>PZ</td> </tr> <tr> <td>VM1465A1</td> <td>CT BT TEMPERATUR E PROBE COVER</td> <td>1</td> <td>PZ</td> </tr> </tbody> </table>	Code	Description	Qty	UOM	GN1285A0	NTC TEMPERATUR E PROBE SEALING	2	PZ	SL1045A0	S57 BLACK SILICONE - 80ML CARTRIDGE	1	PZ	TR1002A1		1	PZ	VI1220A1	4,2X12 TCB SELF-TAPPIN G SCREW	2	PZ	VM1465A0	CHEFTOP TEMPERATUR E PROBE COVER	1	PZ	VM1465A1	CT BT TEMPERATUR E PROBE COVER	1	PZ											
Code	Description	Qty	UOM																																						
GN1285A0	NTC TEMPERATUR E PROBE SEALING	2	PZ																																						
SL1045A0	S57 BLACK SILICONE - 80ML CARTRIDGE	1	PZ																																						
TR1002A1		1	PZ																																						
VI1220A1	4,2X12 TCB SELF-TAPPIN G SCREW	2	PZ																																						
VM1465A0	CHEFTOP TEMPERATUR E PROBE COVER	1	PZ																																						
VM1465A1	CT BT TEMPERATUR E PROBE COVER	1	PZ																																						





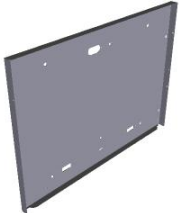

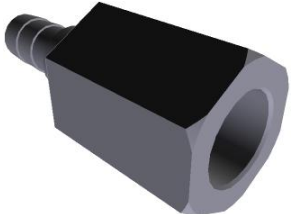
COMPONENT			SPARE PART																																														
Code	Description	Image	Code	Description	Components list																																												
VM1465A	CHEFTOP TEMPERATURE PROBE COVER		VM1465A1	CT BT TEMPERATURE PROBE COVER																																													
TR1105A	L=1000 PT1000 TEMPERATURE PROBE		KTR1105A	PT100 L1000 TEMPERATURE PROBE KIT	<table border="1"> <thead> <tr> <th>Code</th> <th>Description</th> <th>Qty</th> <th>UOM</th> </tr> </thead> <tbody> <tr> <td>GN1120A0</td> <td>TEMPERATUR E PROBE NTC SEAL</td> <td>1</td> <td>PZ</td> </tr> <tr> <td>GN1120A1</td> <td></td> <td>1</td> <td>PZ</td> </tr> <tr> <td>GN1285A0</td> <td>NTC TEMPERATUR E PROBE SEALING</td> <td>1</td> <td>PZ</td> </tr> <tr> <td>MOV0010A0</td> <td>HOOD RING GASKET GN1110A2</td> <td>0.100</td> <td>PZ</td> </tr> <tr> <td>SL1045A0</td> <td>S57 BLACK SILICONE - 80ML CARTRIDGE</td> <td>1</td> <td>PZ</td> </tr> <tr> <td>TR1105A4</td> <td></td> <td>1</td> <td>PZ</td> </tr> <tr> <td>VH1220A1</td> <td>4,2X12 TCB SELF-TAPPIN G SCREW</td> <td>2</td> <td>PZ</td> </tr> <tr> <td>VM1464A1</td> <td>CT BT TEMPERATUR E PROBE COVER</td> <td>1</td> <td>PZ</td> </tr> <tr> <td>VM1465A1</td> <td>CT BT TEMPERATUR E PROBE COVER</td> <td>1</td> <td>PZ</td> </tr> <tr> <td>VM2052A0</td> <td>LM CORE PROBE COVE</td> <td>1</td> <td>PZ</td> </tr> </tbody> </table>	Code	Description	Qty	UOM	GN1120A0	TEMPERATUR E PROBE NTC SEAL	1	PZ	GN1120A1		1	PZ	GN1285A0	NTC TEMPERATUR E PROBE SEALING	1	PZ	MOV0010A0	HOOD RING GASKET GN1110A2	0.100	PZ	SL1045A0	S57 BLACK SILICONE - 80ML CARTRIDGE	1	PZ	TR1105A4		1	PZ	VH1220A1	4,2X12 TCB SELF-TAPPIN G SCREW	2	PZ	VM1464A1	CT BT TEMPERATUR E PROBE COVER	1	PZ	VM1465A1	CT BT TEMPERATUR E PROBE COVER	1	PZ	VM2052A0	LM CORE PROBE COVE	1	PZ
Code	Description	Qty	UOM																																														
GN1120A0	TEMPERATUR E PROBE NTC SEAL	1	PZ																																														
GN1120A1		1	PZ																																														
GN1285A0	NTC TEMPERATUR E PROBE SEALING	1	PZ																																														
MOV0010A0	HOOD RING GASKET GN1110A2	0.100	PZ																																														
SL1045A0	S57 BLACK SILICONE - 80ML CARTRIDGE	1	PZ																																														
TR1105A4		1	PZ																																														
VH1220A1	4,2X12 TCB SELF-TAPPIN G SCREW	2	PZ																																														
VM1464A1	CT BT TEMPERATUR E PROBE COVER	1	PZ																																														
VM1465A1	CT BT TEMPERATUR E PROBE COVER	1	PZ																																														
VM2052A0	LM CORE PROBE COVE	1	PZ																																														
UG1004A	XC415-515-625 1/8" WATER NOZZLE		KUG1004A	XC415-515-625 1/8" WATER NOZZLE KIT	<table border="1"> <thead> <tr> <th>Code</th> <th>Description</th> <th>Qty</th> <th>UOM</th> </tr> </thead> <tbody> <tr> <td>UG1004A0</td> <td>XC415-515-625 1/8\" WATER NOZZLE</td> <td>1</td> <td>PZ</td> </tr> <tr> <td>VM1224A0</td> <td></td> <td>0.150</td> <td>M</td> </tr> </tbody> </table>	Code	Description	Qty	UOM	UG1004A0	XC415-515-625 1/8\" WATER NOZZLE	1	PZ	VM1224A0		0.150	M																																
Code	Description	Qty	UOM																																														
UG1004A0	XC415-515-625 1/8\" WATER NOZZLE	1	PZ																																														
VM1224A0		0.150	M																																														





COMPONENT			SPARE PART																						
Code	Description	Image	Code	Description	Components list																				
VM1690A	HUMIDITY PROBE SUPPORT XL405		KVM1690A	HUMIDITY SENSOR SUPPORT KIT	<table border="1"> <thead> <tr> <th>Code</th> <th>Description</th> <th>Qty</th> <th>UOM</th> </tr> </thead> <tbody> <tr> <td>VM1224A0</td> <td></td> <td>0.150</td> <td>M</td> </tr> <tr> <td>VM1690A0</td> <td>HUMIDITY PROBE SUPPORT XL405</td> <td>1</td> <td>PZ</td> </tr> </tbody> </table>	Code	Description	Qty	UOM	VM1224A0		0.150	M	VM1690A0	HUMIDITY PROBE SUPPORT XL405	1	PZ								
Code	Description	Qty	UOM																						
VM1224A0		0.150	M																						
VM1690A0	HUMIDITY PROBE SUPPORT XL405	1	PZ																						
VM2160A	HUMIDITY SENSOR EXTENSION CABLE		VM2160A0	HUMIDITY SENSOR EXTENSION CABLE																					
0F1508A	8 600X400 EL.PROOFER EXTERNAL BACK PANEL		0F1508A0	8 600X400 EL.PROOFER EXTERNAL BACK PANEL																					
TR1120A	HUMIDITY SENSOR		KTR1120A	HUMIDITY PROBE KI	<table border="1"> <thead> <tr> <th>Code</th> <th>Description</th> <th>Qty</th> <th>UOM</th> </tr> </thead> <tbody> <tr> <td>SL1045A0</td> <td>S57 BLACK SILICONE - 80ML CARTRIDGE</td> <td>1</td> <td>PZ</td> </tr> <tr> <td>TR1120A0</td> <td>HUMIDITY SENSOR</td> <td>1</td> <td>PZ</td> </tr> <tr> <td>VI1220A1</td> <td>4,2X12 TCB SELF-TAPPIN G SCREW</td> <td>2</td> <td>PZ</td> </tr> <tr> <td>VM1690A0</td> <td>HUMIDITY PROBE SUPPORT XL405</td> <td>1</td> <td>PZ</td> </tr> </tbody> </table>	Code	Description	Qty	UOM	SL1045A0	S57 BLACK SILICONE - 80ML CARTRIDGE	1	PZ	TR1120A0	HUMIDITY SENSOR	1	PZ	VI1220A1	4,2X12 TCB SELF-TAPPIN G SCREW	2	PZ	VM1690A0	HUMIDITY PROBE SUPPORT XL405	1	PZ
Code	Description	Qty	UOM																						
SL1045A0	S57 BLACK SILICONE - 80ML CARTRIDGE	1	PZ																						
TR1120A0	HUMIDITY SENSOR	1	PZ																						
VI1220A1	4,2X12 TCB SELF-TAPPIN G SCREW	2	PZ																						
VM1690A0	HUMIDITY PROBE SUPPORT XL405	1	PZ																						
RC1400A	PROOFER TURNED FITTING		RC1400A1	PROOFER TURNED FITTING																					

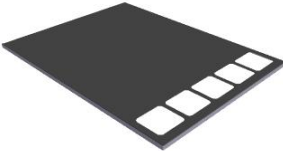

COMPONENT			SPARE PART														
Code	Description	Image	Code	Description	Components list												
0H7329A	8TRAY PROOFER LATERAL GASKET PLACE		0H7329A0	8TRAY PROOFER LATERAL GASKET PLACE													
GN1557A	8TRAY PROOFER DOOR GASKET - GN1110A		KG1557A	MM PROVER 8 TRAYS DOOR GASKET KIT	<table border="1"> <thead> <tr> <th>Code</th> <th>Description</th> <th>Qty</th> <th>UOM</th> </tr> </thead> <tbody> <tr> <td>GN1110A2</td> <td>LINE MISS/XVC105-055/XK/XL DOOR GASKE</td> <td>1.500</td> <td>M</td> </tr> <tr> <td>VM1224A0</td> <td></td> <td>0.450</td> <td>M</td> </tr> </tbody> </table>	Code	Description	Qty	UOM	GN1110A2	LINE MISS/XVC105-055/XK/XL DOOR GASKE	1.500	M	VM1224A0		0.450	M
Code	Description	Qty	UOM														
GN1110A2	LINE MISS/XVC105-055/XK/XL DOOR GASKE	1.500	M														
VM1224A0		0.450	M														
GRL1401A	8 600X400 PROOFER LEFT LATERAL SUPPORT		GRL1401A0	8 600X400 PROOFER LEFT LATERAL SUPPORT													
GRL1402A	8 600X400 PROOFER RIGHT LATERAL SUPPORT		GRL1402A0	8 600X400 PROOFER RIGHT LATERAL SUPPORT													
0H7213A	EUROPEAN PROOFER COVER TRAY		0H7213A0	EUROPEAN PROOFER COVER TRAY													

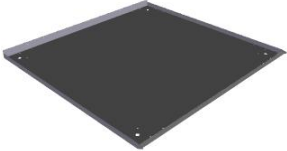

COMPONENT			SPARE PART		
<i>Code</i>	<i>Description</i>	<i>Image</i>	<i>Code</i>	<i>Description</i>	<i>Components list</i>
0E1347A	EU VERSION PROOFER EXT.BOTTOM PANE		0E1347A1	EU VERSION PROOFER EXT.BOTTOM PANE	
VM1281A	TRIANGULAR SUPPORT FOOT-WHEEL		OUTOFPRODUCTIO		



**ASM3047A/0.D00 - General overview**

**FRONT**

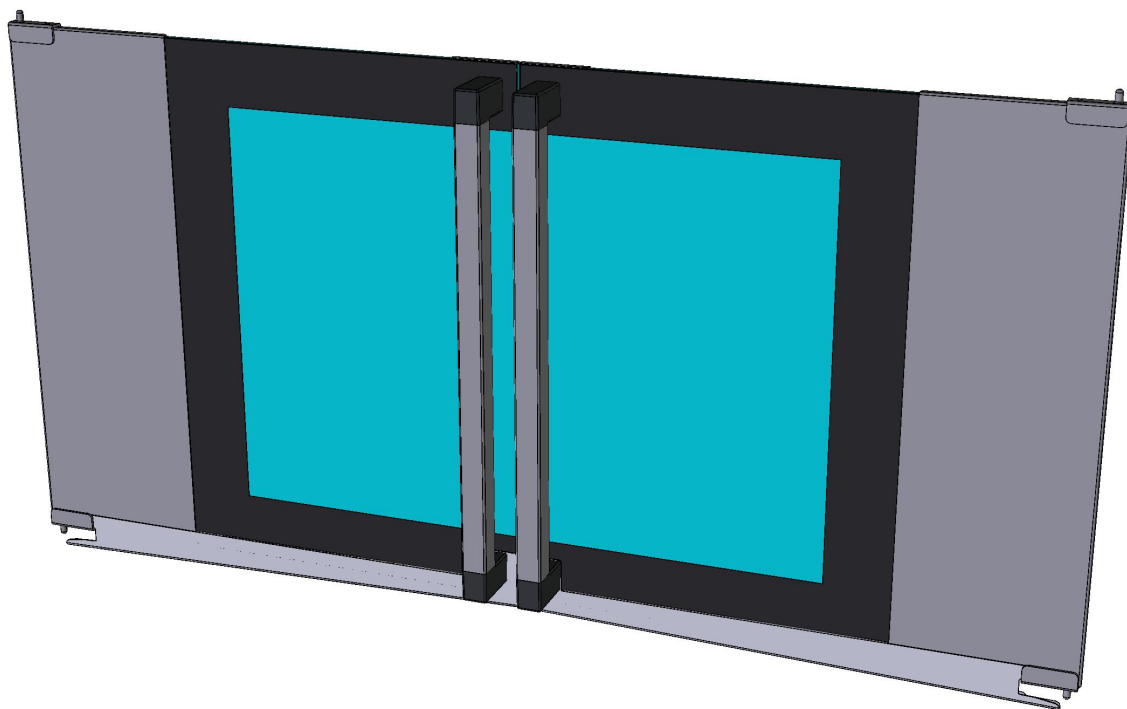

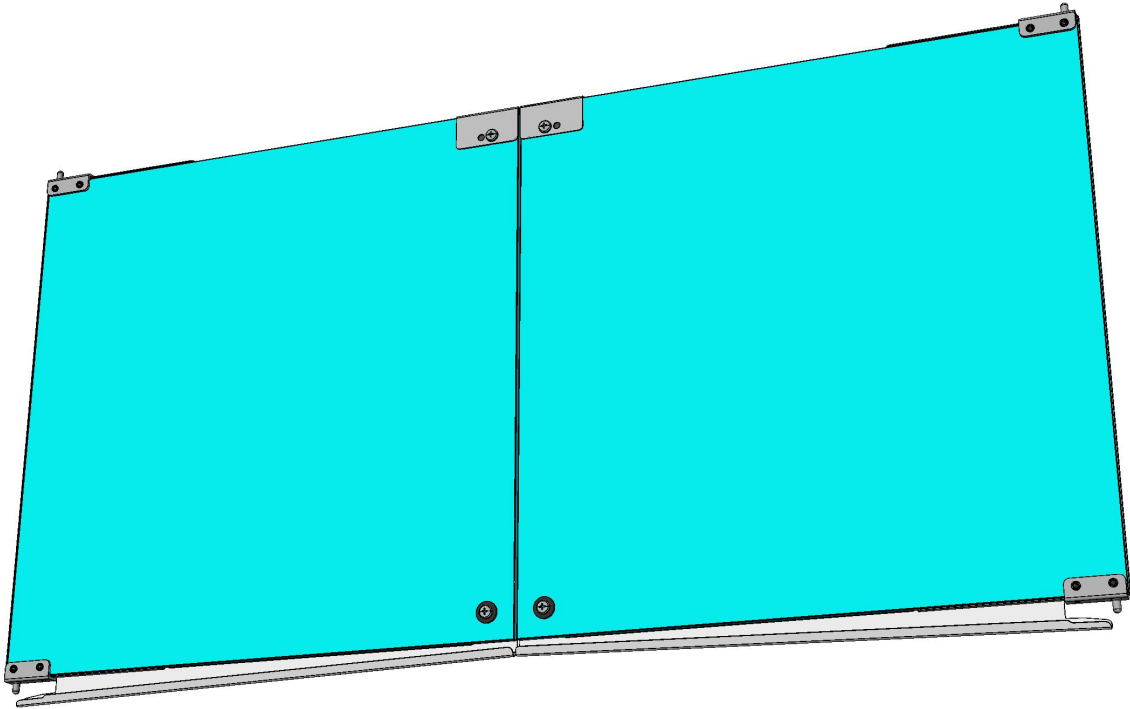

**ASM3047A/0.D00 - General overview**

**REAR**



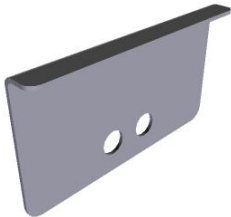



COMPONENT			SPARE PART																																																						
Code	Description	Image	Code	Description	Components list																																																				
0H4540A	DOOR PLATES MAGNET XL405		0H4540A0	DOOR PLATES MAGNET XL405																																																					
VM1720A	XL405 DOOR WASKER		VM1720A0	XL405 DOOR WASKER																																																					
GN1330A	FERRITIC PLATE GASKET XL405		KVT1086BR	XLT195/XLT193 RIGHT COMPLETE DOOR KIT	<table border="1"> <thead> <tr> <th>Code</th> <th>Description</th> <th>Qty</th> <th>UOM</th> </tr> </thead> <tbody> <tr> <td>0H4540A0</td> <td>DOOR PLATES MAGNET XL40</td> <td>1</td> <td>PZ</td> </tr> <tr> <td>CR1080A0</td> <td>XV-XL-XB ST. STEEL RIGHT HINGE</td> <td>1</td> <td>PZ</td> </tr> <tr> <td>CR1081A0</td> <td>XV-XL-XB ST. STEEL LEFT HINGE</td> <td>1</td> <td>PZ</td> </tr> <tr> <td>GN1320A1</td> <td>DOOR GLASS GASKET</td> <td>2</td> <td>PZ</td> </tr> <tr> <td>GN1330A0</td> <td>FERRITIC PLATE GASKET XL40</td> <td>1</td> <td>PZ</td> </tr> <tr> <td>MG1015B0</td> <td>L.MISS/L.MICR O/CHEFTOP HANDLE END</td> <td>2</td> <td>PZ</td> </tr> <tr> <td>TB1077A0</td> <td>XLT135/XLT19 5 Ø18X1 HANDLE TUBE</td> <td>1</td> <td>PZ</td> </tr> <tr> <td>V11685A0</td> <td>M6X6 STAINLESS STEEL SCREW</td> <td>4</td> <td>PZ</td> </tr> <tr> <td>V11930A0</td> <td>5X25 ST. STEEL SCREW CHIP</td> <td>2</td> <td>PZ</td> </tr> <tr> <td>VM1720A0</td> <td>XL405 DOOR WASKER</td> <td>1</td> <td>PZ</td> </tr> <tr> <td>VT1086B0</td> <td>XLT195/XLT19 3 DOOR BLACK GLASS 399X661</td> <td>1</td> <td>PZ</td> </tr> <tr> <td>VT1086B0</td> <td>XLT195/XLT19 3 DOOR BLACK GLASS 399X661</td> <td>1</td> <td>PZ</td> </tr> </tbody> </table>	Code	Description	Qty	UOM	0H4540A0	DOOR PLATES MAGNET XL40	1	PZ	CR1080A0	XV-XL-XB ST. STEEL RIGHT HINGE	1	PZ	CR1081A0	XV-XL-XB ST. STEEL LEFT HINGE	1	PZ	GN1320A1	DOOR GLASS GASKET	2	PZ	GN1330A0	FERRITIC PLATE GASKET XL40	1	PZ	MG1015B0	L.MISS/L.MICR O/CHEFTOP HANDLE END	2	PZ	TB1077A0	XLT135/XLT19 5 Ø18X1 HANDLE TUBE	1	PZ	V11685A0	M6X6 STAINLESS STEEL SCREW	4	PZ	V11930A0	5X25 ST. STEEL SCREW CHIP	2	PZ	VM1720A0	XL405 DOOR WASKER	1	PZ	VT1086B0	XLT195/XLT19 3 DOOR BLACK GLASS 399X661	1	PZ	VT1086B0	XLT195/XLT19 3 DOOR BLACK GLASS 399X661	1	PZ
Code	Description	Qty	UOM																																																						
0H4540A0	DOOR PLATES MAGNET XL40	1	PZ																																																						
CR1080A0	XV-XL-XB ST. STEEL RIGHT HINGE	1	PZ																																																						
CR1081A0	XV-XL-XB ST. STEEL LEFT HINGE	1	PZ																																																						
GN1320A1	DOOR GLASS GASKET	2	PZ																																																						
GN1330A0	FERRITIC PLATE GASKET XL40	1	PZ																																																						
MG1015B0	L.MISS/L.MICR O/CHEFTOP HANDLE END	2	PZ																																																						
TB1077A0	XLT135/XLT19 5 Ø18X1 HANDLE TUBE	1	PZ																																																						
V11685A0	M6X6 STAINLESS STEEL SCREW	4	PZ																																																						
V11930A0	5X25 ST. STEEL SCREW CHIP	2	PZ																																																						
VM1720A0	XL405 DOOR WASKER	1	PZ																																																						
VT1086B0	XLT195/XLT19 3 DOOR BLACK GLASS 399X661	1	PZ																																																						
VT1086B0	XLT195/XLT19 3 DOOR BLACK GLASS 399X661	1	PZ																																																						





COMPONENT			SPARE PART																																																																																					
Code	Description	Image	Code	Description	Components list																																																																																			
GN1330A	FERRITIC PLATE GASKET XL405		KVT1086BL	XLT195/XLT193 LEFT COMPLETE DOOR KIT	<table border="1"> <thead> <tr> <th>Code</th> <th>Description</th> <th>Qty</th> <th>UOM</th> </tr> </thead> <tbody> <tr> <td>0H4540A0</td> <td>DOOR PLATES MAGNET XL40</td> <td>1</td> <td>PZ</td> </tr> <tr> <td>CR1080A0</td> <td>XV-XL-XB ST. STEEL RIGHT HINGE</td> <td>1</td> <td>PZ</td> </tr> <tr> <td>CR1081A0</td> <td>XV-XL-XB ST. STEEL LEFT HINGE</td> <td>1</td> <td>PZ</td> </tr> <tr> <td>GN1320A1</td> <td>DOOR GLASS GASKET</td> <td>2</td> <td>PZ</td> </tr> <tr> <td>GN1330A0</td> <td>FERRITIC PLATE GASKET XL40</td> <td>1</td> <td>PZ</td> </tr> <tr> <td>MG1015B0</td> <td>L.MISS/L.MICR O/CHEFTOP HANDLE END</td> <td>2</td> <td>PZ</td> </tr> <tr> <td>TB1077A0</td> <td>XLT135/XLT19 5 Ø18X1 HANDLE TUBE</td> <td>1</td> <td>PZ</td> </tr> <tr> <td>VI1685A0</td> <td>M6X6 STAINLESS STEEL SCREW</td> <td>4</td> <td>PZ</td> </tr> <tr> <td>VI1930A0</td> <td>5X25 ST. STEEL SCREW CHIP</td> <td>2</td> <td>PZ</td> </tr> <tr> <td>VM1720A0</td> <td>XL405 DOOR WASKER</td> <td>1</td> <td>PZ</td> </tr> <tr> <td>VT1086B0</td> <td>XLT195/XLT19 3 DOOR BLACK GLASS 399X661</td> <td>1</td> <td>PZ</td> </tr> <tr> <td>VT1086B0</td> <td>XLT195/XLT19 3 DOOR BLACK GLASS 399X661</td> <td>1</td> <td>PZ</td> </tr> </tbody> </table>	Code	Description	Qty	UOM	0H4540A0	DOOR PLATES MAGNET XL40	1	PZ	CR1080A0	XV-XL-XB ST. STEEL RIGHT HINGE	1	PZ	CR1081A0	XV-XL-XB ST. STEEL LEFT HINGE	1	PZ	GN1320A1	DOOR GLASS GASKET	2	PZ	GN1330A0	FERRITIC PLATE GASKET XL40	1	PZ	MG1015B0	L.MISS/L.MICR O/CHEFTOP HANDLE END	2	PZ	TB1077A0	XLT135/XLT19 5 Ø18X1 HANDLE TUBE	1	PZ	VI1685A0	M6X6 STAINLESS STEEL SCREW	4	PZ	VI1930A0	5X25 ST. STEEL SCREW CHIP	2	PZ	VM1720A0	XL405 DOOR WASKER	1	PZ	VT1086B0	XLT195/XLT19 3 DOOR BLACK GLASS 399X661	1	PZ	VT1086B0	XLT195/XLT19 3 DOOR BLACK GLASS 399X661	1	PZ	KVT1076BR	XLT135/XLT133 RIGHT COMPLETE DOOR KIT	<table border="1"> <thead> <tr> <th>Code</th> <th>Description</th> <th>Qty</th> <th>UOM</th> </tr> </thead> <tbody> <tr> <td>0H4540A0</td> <td>DOOR PLATES MAGNET XL40</td> <td>1</td> <td>PZ</td> </tr> <tr> <td>CR1080A0</td> <td>XV-XL-XB ST. STEEL RIGHT HINGE</td> <td>1</td> <td>PZ</td> </tr> <tr> <td>CR1081A0</td> <td>XV-XL-XB ST. STEEL LEFT HINGE</td> <td>1</td> <td>PZ</td> </tr> <tr> <td>GN1320A1</td> <td>DOOR GLASS GASKET</td> <td>2</td> <td>PZ</td> </tr> <tr> <td>GN1330A0</td> <td>FERRITIC PLATE GASKET XL40</td> <td>1</td> <td>PZ</td> </tr> <tr> <td>IP1385A1</td> <td>CORNER POLYSTYREN E PACKING 110X80X2000</td> <td>1.400</td> <td>M</td> </tr> </tbody> </table>	Code	Description	Qty	UOM	0H4540A0	DOOR PLATES MAGNET XL40	1	PZ	CR1080A0	XV-XL-XB ST. STEEL RIGHT HINGE	1	PZ	CR1081A0	XV-XL-XB ST. STEEL LEFT HINGE	1	PZ	GN1320A1	DOOR GLASS GASKET	2	PZ	GN1330A0	FERRITIC PLATE GASKET XL40	1	PZ	IP1385A1	CORNER POLYSTYREN E PACKING 110X80X2000	1.400	M
			Code	Description	Qty	UOM																																																																																		
0H4540A0	DOOR PLATES MAGNET XL40	1	PZ																																																																																					
CR1080A0	XV-XL-XB ST. STEEL RIGHT HINGE	1	PZ																																																																																					
CR1081A0	XV-XL-XB ST. STEEL LEFT HINGE	1	PZ																																																																																					
GN1320A1	DOOR GLASS GASKET	2	PZ																																																																																					
GN1330A0	FERRITIC PLATE GASKET XL40	1	PZ																																																																																					
MG1015B0	L.MISS/L.MICR O/CHEFTOP HANDLE END	2	PZ																																																																																					
TB1077A0	XLT135/XLT19 5 Ø18X1 HANDLE TUBE	1	PZ																																																																																					
VI1685A0	M6X6 STAINLESS STEEL SCREW	4	PZ																																																																																					
VI1930A0	5X25 ST. STEEL SCREW CHIP	2	PZ																																																																																					
VM1720A0	XL405 DOOR WASKER	1	PZ																																																																																					
VT1086B0	XLT195/XLT19 3 DOOR BLACK GLASS 399X661	1	PZ																																																																																					
VT1086B0	XLT195/XLT19 3 DOOR BLACK GLASS 399X661	1	PZ																																																																																					
Code	Description	Qty	UOM																																																																																					
0H4540A0	DOOR PLATES MAGNET XL40	1	PZ																																																																																					
CR1080A0	XV-XL-XB ST. STEEL RIGHT HINGE	1	PZ																																																																																					
CR1081A0	XV-XL-XB ST. STEEL LEFT HINGE	1	PZ																																																																																					
GN1320A1	DOOR GLASS GASKET	2	PZ																																																																																					
GN1330A0	FERRITIC PLATE GASKET XL40	1	PZ																																																																																					
IP1385A1	CORNER POLYSTYREN E PACKING 110X80X2000	1.400	M																																																																																					



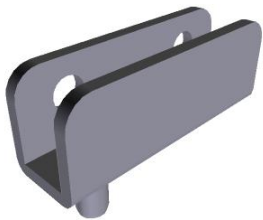
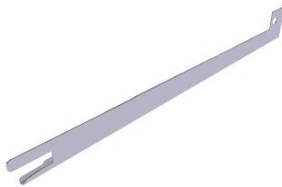

COMPONENT			SPARE PART																																										
Code	Description	Image	Code	Description	Components list																																								
GN1330A	FERRITIC PLATE GASKET XL405		KVT1076BR	XLT135/XLT133 RIGHT COMPLETE DOOR KIT	<table border="1"> <thead> <tr> <th>Code</th> <th>Description</th> <th>Qty</th> <th>UOM</th> </tr> </thead> <tbody> <tr> <td>IP1508A1</td> <td>POLYSTYREN E U SHAPED PROFILE 2000X60X60</td> <td>0.300</td> <td>M</td> </tr> <tr> <td>MG1015B0</td> <td>L.MISS/L.MICR O/CHEFTOP HANDLE END</td> <td>2</td> <td>PZ</td> </tr> <tr> <td>TB1077A0</td> <td>XLT135/XLT19 5 Ø18X1 HANDLE TUBE</td> <td>1</td> <td>PZ</td> </tr> <tr> <td>VI1685A0</td> <td>M6X6 STAINLESS STEEL SCREW</td> <td>4</td> <td>PZ</td> </tr> <tr> <td>VI1930A0</td> <td>5X25 ST. STEEL SCREW CHIP</td> <td>2</td> <td>PZ</td> </tr> <tr> <td>VM1059A1</td> <td>HEAT SHRINK FILM H800</td> <td>1.500</td> <td>M</td> </tr> <tr> <td>VM1720A0</td> <td>XL405 DOOR WASKER</td> <td>1</td> <td>PZ</td> </tr> <tr> <td>VT1076B0</td> <td>XLT135/XLT13 3 BLACK DOOR GLASS 299X661</td> <td>1</td> <td>PZ</td> </tr> <tr> <td>VT1076B0</td> <td>XLT135/XLT13 3 BLACK DOOR GLASS 299X661</td> <td>1</td> <td>PZ</td> </tr> </tbody> </table>	Code	Description	Qty	UOM	IP1508A1	POLYSTYREN E U SHAPED PROFILE 2000X60X60	0.300	M	MG1015B0	L.MISS/L.MICR O/CHEFTOP HANDLE END	2	PZ	TB1077A0	XLT135/XLT19 5 Ø18X1 HANDLE TUBE	1	PZ	VI1685A0	M6X6 STAINLESS STEEL SCREW	4	PZ	VI1930A0	5X25 ST. STEEL SCREW CHIP	2	PZ	VM1059A1	HEAT SHRINK FILM H800	1.500	M	VM1720A0	XL405 DOOR WASKER	1	PZ	VT1076B0	XLT135/XLT13 3 BLACK DOOR GLASS 299X661	1	PZ	VT1076B0	XLT135/XLT13 3 BLACK DOOR GLASS 299X661	1	PZ
			Code	Description	Qty	UOM																																							
IP1508A1	POLYSTYREN E U SHAPED PROFILE 2000X60X60	0.300	M																																										
MG1015B0	L.MISS/L.MICR O/CHEFTOP HANDLE END	2	PZ																																										
TB1077A0	XLT135/XLT19 5 Ø18X1 HANDLE TUBE	1	PZ																																										
VI1685A0	M6X6 STAINLESS STEEL SCREW	4	PZ																																										
VI1930A0	5X25 ST. STEEL SCREW CHIP	2	PZ																																										
VM1059A1	HEAT SHRINK FILM H800	1.500	M																																										
VM1720A0	XL405 DOOR WASKER	1	PZ																																										
VT1076B0	XLT135/XLT13 3 BLACK DOOR GLASS 299X661	1	PZ																																										
VT1076B0	XLT135/XLT13 3 BLACK DOOR GLASS 299X661	1	PZ																																										
KVT1076BL	XLT135/XLT133 LEFT COMPLETE DOOR KIT	<table border="1"> <thead> <tr> <th>Code</th> <th>Description</th> <th>Qty</th> <th>UOM</th> </tr> </thead> <tbody> <tr> <td>0H4540A0</td> <td>DOOR PLATES MAGNET XL40</td> <td>1</td> <td>PZ</td> </tr> <tr> <td>CR1080A0</td> <td>XV-XL-XB ST. STEEL RIGHT HINGE</td> <td>1</td> <td>PZ</td> </tr> <tr> <td>CR1081A0</td> <td>XV-XL-XB ST. STEEL LEFT HINGE</td> <td>1</td> <td>PZ</td> </tr> <tr> <td>GN1320A1</td> <td>DOOR GLASS GASKET</td> <td>2</td> <td>PZ</td> </tr> <tr> <td>GN1330A0</td> <td>FERRITIC PLATE GASKET XL40</td> <td>1</td> <td>PZ</td> </tr> <tr> <td>IP1385A1</td> <td>CORNER POLYSTYREN E PACKING 110X80X2000</td> <td>1.400</td> <td>M</td> </tr> <tr> <td>IP1508A1</td> <td>POLYSTYREN E U SHAPED PROFILE 2000X60X60</td> <td>0.300</td> <td>M</td> </tr> <tr> <td>MG1015B0</td> <td>L.MISS/L.MICR O/CHEFTOP HANDLE END</td> <td>2</td> <td>PZ</td> </tr> </tbody> </table>	Code	Description	Qty	UOM	0H4540A0	DOOR PLATES MAGNET XL40	1	PZ	CR1080A0	XV-XL-XB ST. STEEL RIGHT HINGE	1	PZ	CR1081A0	XV-XL-XB ST. STEEL LEFT HINGE	1	PZ	GN1320A1	DOOR GLASS GASKET	2	PZ	GN1330A0	FERRITIC PLATE GASKET XL40	1	PZ	IP1385A1	CORNER POLYSTYREN E PACKING 110X80X2000	1.400	M	IP1508A1	POLYSTYREN E U SHAPED PROFILE 2000X60X60	0.300	M	MG1015B0	L.MISS/L.MICR O/CHEFTOP HANDLE END	2	PZ							
Code	Description	Qty	UOM																																										
0H4540A0	DOOR PLATES MAGNET XL40	1	PZ																																										
CR1080A0	XV-XL-XB ST. STEEL RIGHT HINGE	1	PZ																																										
CR1081A0	XV-XL-XB ST. STEEL LEFT HINGE	1	PZ																																										
GN1320A1	DOOR GLASS GASKET	2	PZ																																										
GN1330A0	FERRITIC PLATE GASKET XL40	1	PZ																																										
IP1385A1	CORNER POLYSTYREN E PACKING 110X80X2000	1.400	M																																										
IP1508A1	POLYSTYREN E U SHAPED PROFILE 2000X60X60	0.300	M																																										
MG1015B0	L.MISS/L.MICR O/CHEFTOP HANDLE END	2	PZ																																										

COMPONENT			SPARE PART																																																		
Code	Description	Image	Code	Description	Components list																																																
GN1330A	FERRITIC PLATE		KVT1076BL	XLT135/XLT133 LEFT COMPLETE DOOR KIT	<table border="1"> <thead> <tr> <th>Code</th> <th>Description</th> <th>Qty</th> <th>UOM</th> </tr> </thead> <tbody> <tr> <td>TB1077A0</td> <td>XLT135/XLT19 5 Ø18X1 HANDLE TUBE</td> <td>1</td> <td>PZ</td> </tr> <tr> <td>VI1685A0</td> <td>M6X6 STAINLESS STEEL SCREW</td> <td>4</td> <td>PZ</td> </tr> <tr> <td>VI1930A0</td> <td>5X25 ST. STEEL SCREW CHIP</td> <td>2</td> <td>PZ</td> </tr> <tr> <td>VM1059A1</td> <td>HEAT SHRINK FILM H800</td> <td>1.500</td> <td>M</td> </tr> <tr> <td>VM1720A0</td> <td>XL405 DOOR WASKER</td> <td>1</td> <td>PZ</td> </tr> <tr> <td>VT1076B0</td> <td>XLT135/XLT13 3 BLACK DOOR GLASS 299X661</td> <td>1</td> <td>PZ</td> </tr> <tr> <td>VT1076B0</td> <td>XLT135/XLT13 3 BLACK DOOR GLASS 299X661</td> <td>1</td> <td>PZ</td> </tr> </tbody> </table>	Code	Description	Qty	UOM	TB1077A0	XLT135/XLT19 5 Ø18X1 HANDLE TUBE	1	PZ	VI1685A0	M6X6 STAINLESS STEEL SCREW	4	PZ	VI1930A0	5X25 ST. STEEL SCREW CHIP	2	PZ	VM1059A1	HEAT SHRINK FILM H800	1.500	M	VM1720A0	XL405 DOOR WASKER	1	PZ	VT1076B0	XLT135/XLT13 3 BLACK DOOR GLASS 299X661	1	PZ	VT1076B0	XLT135/XLT13 3 BLACK DOOR GLASS 299X661	1	PZ																
	Code		Description	Qty	UOM																																																
TB1077A0	XLT135/XLT19 5 Ø18X1 HANDLE TUBE	1	PZ																																																		
VI1685A0	M6X6 STAINLESS STEEL SCREW	4	PZ																																																		
VI1930A0	5X25 ST. STEEL SCREW CHIP	2	PZ																																																		
VM1059A1	HEAT SHRINK FILM H800	1.500	M																																																		
VM1720A0	XL405 DOOR WASKER	1	PZ																																																		
VT1076B0	XLT135/XLT13 3 BLACK DOOR GLASS 299X661	1	PZ																																																		
VT1076B0	XLT135/XLT13 3 BLACK DOOR GLASS 299X661	1	PZ																																																		
	GASKET XL405		KDR1210AR	XL405 COMPLETE RIGHT DOOR	<table border="1"> <thead> <tr> <th>Code</th> <th>Description</th> <th>Qty</th> <th>UOM</th> </tr> </thead> <tbody> <tr> <td>0H4530C0</td> <td>RIGHT DOOR DRIPPING TRAY XL415</td> <td>1</td> <td>PZ</td> </tr> <tr> <td>0H4540A0</td> <td>DOOR PLATES MAGNET XL40</td> <td>1</td> <td>PZ</td> </tr> <tr> <td>CR1080A0</td> <td>XV-XL-XB ST. STEEL RIGHT HINGE</td> <td>1</td> <td>PZ</td> </tr> <tr> <td>CR1081A0</td> <td>XV-XL-XB ST. STEEL LEFT HINGE</td> <td>1</td> <td>PZ</td> </tr> <tr> <td>GN1320A1</td> <td>DOOR GLASS GASKET</td> <td>2</td> <td>PZ</td> </tr> <tr> <td>GN1330A0</td> <td>FERRITIC PLATE GASKET XL40</td> <td>1</td> <td>PZ</td> </tr> <tr> <td>IP1385A1</td> <td>CORNER POLYSTYREN E PACKING 110X80X2000</td> <td>1.300</td> <td>M</td> </tr> <tr> <td>IP1508A1</td> <td>POLYSTYREN E U SHAPED PROFILE 2000X60X60</td> <td>0.570</td> <td>M</td> </tr> <tr> <td>MG1015B0</td> <td>L.MISS/L.MICR O/CHEFTOP HANDLE END</td> <td>2</td> <td>PZ</td> </tr> <tr> <td>TB1730A0</td> <td>XL405-413-415 HANDLE TUBE</td> <td>1</td> <td>PZ</td> </tr> <tr> <td>VI1685A0</td> <td>M6X6 STAINLESS STEEL SCREW</td> <td>4</td> <td>PZ</td> </tr> </tbody> </table>	Code	Description	Qty	UOM	0H4530C0	RIGHT DOOR DRIPPING TRAY XL415	1	PZ	0H4540A0	DOOR PLATES MAGNET XL40	1	PZ	CR1080A0	XV-XL-XB ST. STEEL RIGHT HINGE	1	PZ	CR1081A0	XV-XL-XB ST. STEEL LEFT HINGE	1	PZ	GN1320A1	DOOR GLASS GASKET	2	PZ	GN1330A0	FERRITIC PLATE GASKET XL40	1	PZ	IP1385A1	CORNER POLYSTYREN E PACKING 110X80X2000	1.300	M	IP1508A1	POLYSTYREN E U SHAPED PROFILE 2000X60X60	0.570	M	MG1015B0	L.MISS/L.MICR O/CHEFTOP HANDLE END	2	PZ	TB1730A0	XL405-413-415 HANDLE TUBE	1	PZ	VI1685A0	M6X6 STAINLESS STEEL SCREW	4	PZ
Code	Description	Qty	UOM																																																		
0H4530C0	RIGHT DOOR DRIPPING TRAY XL415	1	PZ																																																		
0H4540A0	DOOR PLATES MAGNET XL40	1	PZ																																																		
CR1080A0	XV-XL-XB ST. STEEL RIGHT HINGE	1	PZ																																																		
CR1081A0	XV-XL-XB ST. STEEL LEFT HINGE	1	PZ																																																		
GN1320A1	DOOR GLASS GASKET	2	PZ																																																		
GN1330A0	FERRITIC PLATE GASKET XL40	1	PZ																																																		
IP1385A1	CORNER POLYSTYREN E PACKING 110X80X2000	1.300	M																																																		
IP1508A1	POLYSTYREN E U SHAPED PROFILE 2000X60X60	0.570	M																																																		
MG1015B0	L.MISS/L.MICR O/CHEFTOP HANDLE END	2	PZ																																																		
TB1730A0	XL405-413-415 HANDLE TUBE	1	PZ																																																		
VI1685A0	M6X6 STAINLESS STEEL SCREW	4	PZ																																																		

COMPONENT			SPARE PART																																																															
Code	Description	Image	Code	Description	Components list																																																													
GN1330A	FERRITIC PLATE GASKET XL405		KDR1210AR	XL405 COMPLETE RIGHT DOOR	<table border="1"> <thead> <tr> <th>Code</th> <th>Description</th> <th>Qty</th> <th>UOM</th> </tr> </thead> <tbody> <tr> <td>VI1930A0</td> <td>5X25 ST. STEEL SCREW CHIP</td> <td>2</td> <td>PZ</td> </tr> <tr> <td>VM1059A1</td> <td>HEAT SHRINK FILM H800</td> <td>1.300</td> <td>M</td> </tr> <tr> <td>VM1720A0</td> <td>XL405 DOOR WASKER</td> <td>1</td> <td>PZ</td> </tr> <tr> <td>VM1790A0</td> <td>HINGE BUSH 12X6.5 DI5.3</td> <td>2</td> <td>PZ</td> </tr> <tr> <td>VT1210A0</td> <td>XL405-413-415 DOOR GLASS</td> <td>1</td> <td>PZ</td> </tr> <tr> <td>VT1210A0</td> <td>XL405-413-415 DOOR GLASS</td> <td>1</td> <td>PZ</td> </tr> </tbody> </table>	Code	Description	Qty	UOM	VI1930A0	5X25 ST. STEEL SCREW CHIP	2	PZ	VM1059A1	HEAT SHRINK FILM H800	1.300	M	VM1720A0	XL405 DOOR WASKER	1	PZ	VM1790A0	HINGE BUSH 12X6.5 DI5.3	2	PZ	VT1210A0	XL405-413-415 DOOR GLASS	1	PZ	VT1210A0	XL405-413-415 DOOR GLASS	1	PZ																																	
			Code	Description	Qty	UOM																																																												
VI1930A0	5X25 ST. STEEL SCREW CHIP	2	PZ																																																															
VM1059A1	HEAT SHRINK FILM H800	1.300	M																																																															
VM1720A0	XL405 DOOR WASKER	1	PZ																																																															
VM1790A0	HINGE BUSH 12X6.5 DI5.3	2	PZ																																																															
VT1210A0	XL405-413-415 DOOR GLASS	1	PZ																																																															
VT1210A0	XL405-413-415 DOOR GLASS	1	PZ																																																															
KDR1210AL	XL405 COMPLETE LEFT DOOR	<table border="1"> <thead> <tr> <th>Code</th> <th>Description</th> <th>Qty</th> <th>UOM</th> </tr> </thead> <tbody> <tr> <td>0H4535C0</td> <td>LEFT DOOR DRIPPING TRAY XL415</td> <td>1</td> <td>PZ</td> </tr> <tr> <td>0H4540A0</td> <td>DOOR PLATES MAGNET XL40</td> <td>1</td> <td>PZ</td> </tr> <tr> <td>CR1080A0</td> <td>XV-XL-XB ST. STEEL RIGHT HINGE</td> <td>1</td> <td>PZ</td> </tr> <tr> <td>CR1081A0</td> <td>XV-XL-XB ST. STEEL LEFT HINGE</td> <td>1</td> <td>PZ</td> </tr> <tr> <td>GN1320A1</td> <td>DOOR GLASS GASKET</td> <td>2</td> <td>PZ</td> </tr> <tr> <td>GN1330A0</td> <td>FERRITIC PLATE GASKET XL40</td> <td>1</td> <td>PZ</td> </tr> <tr> <td>IP1385A1</td> <td>CORNER POLYSTYREN E PACKING 110X80X2000</td> <td>1.300</td> <td>M</td> </tr> <tr> <td>IP1508A1</td> <td>POLYSTYREN E U SHAPED PROFILE 2000X60X60</td> <td>0.570</td> <td>M</td> </tr> <tr> <td>MG1015B0</td> <td>L.MISS/L.MICR O/CHEFTOP HANDLE END</td> <td>2</td> <td>PZ</td> </tr> <tr> <td>TB1730A0</td> <td>XL405-413-415 HANDLE TUBE</td> <td>1</td> <td>PZ</td> </tr> <tr> <td>VI1685A0</td> <td>M6X6 STAINLESS STEEL SCREW</td> <td>4</td> <td>PZ</td> </tr> <tr> <td>VI1930A0</td> <td>5X25 ST. STEEL SCREW CHIP</td> <td>2</td> <td>PZ</td> </tr> <tr> <td>VM1059A1</td> <td>HEAT SHRINK FILM H800</td> <td>1.300</td> <td>M</td> </tr> <tr> <td>VM1720A0</td> <td>XL405 DOOR WASKER</td> <td>1</td> <td>PZ</td> </tr> <tr> <td>VM1790A0</td> <td>HINGE BUSH 12X6.5 DI5.3</td> <td>2</td> <td>PZ</td> </tr> </tbody> </table>	Code	Description	Qty	UOM	0H4535C0	LEFT DOOR DRIPPING TRAY XL415	1	PZ	0H4540A0	DOOR PLATES MAGNET XL40	1	PZ	CR1080A0	XV-XL-XB ST. STEEL RIGHT HINGE	1	PZ	CR1081A0	XV-XL-XB ST. STEEL LEFT HINGE	1	PZ	GN1320A1	DOOR GLASS GASKET	2	PZ	GN1330A0	FERRITIC PLATE GASKET XL40	1	PZ	IP1385A1	CORNER POLYSTYREN E PACKING 110X80X2000	1.300	M	IP1508A1	POLYSTYREN E U SHAPED PROFILE 2000X60X60	0.570	M	MG1015B0	L.MISS/L.MICR O/CHEFTOP HANDLE END	2	PZ	TB1730A0	XL405-413-415 HANDLE TUBE	1	PZ	VI1685A0	M6X6 STAINLESS STEEL SCREW	4	PZ	VI1930A0	5X25 ST. STEEL SCREW CHIP	2	PZ	VM1059A1	HEAT SHRINK FILM H800	1.300	M	VM1720A0	XL405 DOOR WASKER	1	PZ	VM1790A0	HINGE BUSH 12X6.5 DI5.3	2	PZ
Code	Description	Qty	UOM																																																															
0H4535C0	LEFT DOOR DRIPPING TRAY XL415	1	PZ																																																															
0H4540A0	DOOR PLATES MAGNET XL40	1	PZ																																																															
CR1080A0	XV-XL-XB ST. STEEL RIGHT HINGE	1	PZ																																																															
CR1081A0	XV-XL-XB ST. STEEL LEFT HINGE	1	PZ																																																															
GN1320A1	DOOR GLASS GASKET	2	PZ																																																															
GN1330A0	FERRITIC PLATE GASKET XL40	1	PZ																																																															
IP1385A1	CORNER POLYSTYREN E PACKING 110X80X2000	1.300	M																																																															
IP1508A1	POLYSTYREN E U SHAPED PROFILE 2000X60X60	0.570	M																																																															
MG1015B0	L.MISS/L.MICR O/CHEFTOP HANDLE END	2	PZ																																																															
TB1730A0	XL405-413-415 HANDLE TUBE	1	PZ																																																															
VI1685A0	M6X6 STAINLESS STEEL SCREW	4	PZ																																																															
VI1930A0	5X25 ST. STEEL SCREW CHIP	2	PZ																																																															
VM1059A1	HEAT SHRINK FILM H800	1.300	M																																																															
VM1720A0	XL405 DOOR WASKER	1	PZ																																																															
VM1790A0	HINGE BUSH 12X6.5 DI5.3	2	PZ																																																															

COMPONENT			SPARE PART																														
Code	Description	Image	Code	Description	Components list																												
GN1330A	FERRITIC PLATE GASKET XL405		KDR1210AL	XL405 COMPLETE LEFT DOOR	<table border="1"> <thead> <tr> <th>Code</th> <th>Description</th> <th>Qty</th> <th>UOM</th> </tr> </thead> <tbody> <tr> <td>VT1210A0</td> <td>XL405-413-415 DOOR GLASS</td> <td>1</td> <td>PZ</td> </tr> <tr> <td>VT1210A0</td> <td>XL405-413-415 DOOR GLASS</td> <td>1</td> <td>PZ</td> </tr> </tbody> </table>	Code	Description	Qty	UOM	VT1210A0	XL405-413-415 DOOR GLASS	1	PZ	VT1210A0	XL405-413-415 DOOR GLASS	1	PZ																
Code	Description	Qty	UOM																														
VT1210A0	XL405-413-415 DOOR GLASS	1	PZ																														
VT1210A0	XL405-413-415 DOOR GLASS	1	PZ																														
CR1081A	XV-XL-XB ST. STEEL LEFT HINGE		KCR1080A	RIGHT/LEFT HINGES KIT CR1080A+CR1081A	<table border="1"> <thead> <tr> <th>Code</th> <th>Description</th> <th>Qty</th> <th>UOM</th> </tr> </thead> <tbody> <tr> <td>CR1080A0</td> <td>XV-XL-XB ST. STEEL RIGHT HINGE</td> <td>1</td> <td>PZ</td> </tr> <tr> <td>CR1081A0</td> <td>XV-XL-XB ST. STEEL LEFT HINGE</td> <td>1</td> <td>PZ</td> </tr> <tr> <td>GN1320A1</td> <td>DOOR GLASS GASKET</td> <td>2</td> <td>PZ</td> </tr> <tr> <td>VI1685A0</td> <td>M6X6 STAINLESS STEEL SCREW</td> <td>4</td> <td>PZ</td> </tr> <tr> <td>VM1224A0</td> <td></td> <td>0.200</td> <td>M</td> </tr> <tr> <td>VM1790A0</td> <td>HINGE BUSH 12X6.5 DI5.3</td> <td>2</td> <td>PZ</td> </tr> </tbody> </table>	Code	Description	Qty	UOM	CR1080A0	XV-XL-XB ST. STEEL RIGHT HINGE	1	PZ	CR1081A0	XV-XL-XB ST. STEEL LEFT HINGE	1	PZ	GN1320A1	DOOR GLASS GASKET	2	PZ	VI1685A0	M6X6 STAINLESS STEEL SCREW	4	PZ	VM1224A0		0.200	M	VM1790A0	HINGE BUSH 12X6.5 DI5.3	2	PZ
Code	Description	Qty	UOM																														
CR1080A0	XV-XL-XB ST. STEEL RIGHT HINGE	1	PZ																														
CR1081A0	XV-XL-XB ST. STEEL LEFT HINGE	1	PZ																														
GN1320A1	DOOR GLASS GASKET	2	PZ																														
VI1685A0	M6X6 STAINLESS STEEL SCREW	4	PZ																														
VM1224A0		0.200	M																														
VM1790A0	HINGE BUSH 12X6.5 DI5.3	2	PZ																														
CR1080A	XV-XL-XB ST. STEEL RIGHT HINGE		KCR1080A	RIGHT/LEFT HINGES KIT CR1080A+CR1081A	<table border="1"> <thead> <tr> <th>Code</th> <th>Description</th> <th>Qty</th> <th>UOM</th> </tr> </thead> <tbody> <tr> <td>CR1080A0</td> <td>XV-XL-XB ST. STEEL RIGHT HINGE</td> <td>1</td> <td>PZ</td> </tr> <tr> <td>CR1081A0</td> <td>XV-XL-XB ST. STEEL LEFT HINGE</td> <td>1</td> <td>PZ</td> </tr> <tr> <td>GN1320A1</td> <td>DOOR GLASS GASKET</td> <td>2</td> <td>PZ</td> </tr> <tr> <td>VI1685A0</td> <td>M6X6 STAINLESS STEEL SCREW</td> <td>4</td> <td>PZ</td> </tr> <tr> <td>VM1224A0</td> <td></td> <td>0.200</td> <td>M</td> </tr> <tr> <td>VM1790A0</td> <td>HINGE BUSH 12X6.5 DI5.3</td> <td>2</td> <td>PZ</td> </tr> </tbody> </table>	Code	Description	Qty	UOM	CR1080A0	XV-XL-XB ST. STEEL RIGHT HINGE	1	PZ	CR1081A0	XV-XL-XB ST. STEEL LEFT HINGE	1	PZ	GN1320A1	DOOR GLASS GASKET	2	PZ	VI1685A0	M6X6 STAINLESS STEEL SCREW	4	PZ	VM1224A0		0.200	M	VM1790A0	HINGE BUSH 12X6.5 DI5.3	2	PZ
Code	Description	Qty	UOM																														
CR1080A0	XV-XL-XB ST. STEEL RIGHT HINGE	1	PZ																														
CR1081A0	XV-XL-XB ST. STEEL LEFT HINGE	1	PZ																														
GN1320A1	DOOR GLASS GASKET	2	PZ																														
VI1685A0	M6X6 STAINLESS STEEL SCREW	4	PZ																														
VM1224A0		0.200	M																														
VM1790A0	HINGE BUSH 12X6.5 DI5.3	2	PZ																														
0H7216A	BAKERTOP PROOFER LEFT DRIP TRAY		0H7216A0	BAKERTOP PROOFER LEFT DRIP TRAY																													



COMPONENT			SPARE PART																						
Code	Description	Image	Code	Description	Components list																				
MG1082A	HANDLE END PROFILE 20X20		MG1082A0	HANDLE END PROFILE 20X20																					
GN1554A	PROOFER HANDLE GASKET		GN1554A0	PROOFER HANDLE GASKET																					
0H7325A	600X400 8TRAY PROOFER DOOR BAND		0H7325A0	600X400 8TRAY PROOFER DOOR BAND																					
TB2969A	8TRAY PROOFER HANDLE PROFILE 20X20		TB2969A0	8TRAY PROOFER HANDLE PROFILE 20X20																					
VT1308A	LOW PROVER DOOR GLASS		KVT1308AR	8 TRAYS PROVER RIGHT DOOR GLASS KIT	<table border="1"> <thead> <tr> <th>Code</th> <th>Description</th> <th>Qty</th> <th>UOM</th> </tr> </thead> <tbody> <tr> <td>0H4540A0</td> <td>DOOR PLATES MAGNET XL40</td> <td>1</td> <td>PZ</td> </tr> <tr> <td>0H7217A0</td> <td>BAKERTOP PROOFER RIGHT DRIP TRAY</td> <td>1</td> <td>PZ</td> </tr> <tr> <td>0H7325A0</td> <td>600X400 8TRAY PROOFER DOOR BAND</td> <td>1</td> <td>PZ</td> </tr> <tr> <td>CR1080A0</td> <td>XV-XL-XB ST. STEEL RIGHT HINGE</td> <td>1</td> <td>PZ</td> </tr> </tbody> </table>	Code	Description	Qty	UOM	0H4540A0	DOOR PLATES MAGNET XL40	1	PZ	0H7217A0	BAKERTOP PROOFER RIGHT DRIP TRAY	1	PZ	0H7325A0	600X400 8TRAY PROOFER DOOR BAND	1	PZ	CR1080A0	XV-XL-XB ST. STEEL RIGHT HINGE	1	PZ
Code	Description	Qty	UOM																						
0H4540A0	DOOR PLATES MAGNET XL40	1	PZ																						
0H7217A0	BAKERTOP PROOFER RIGHT DRIP TRAY	1	PZ																						
0H7325A0	600X400 8TRAY PROOFER DOOR BAND	1	PZ																						
CR1080A0	XV-XL-XB ST. STEEL RIGHT HINGE	1	PZ																						





COMPONENT			SPARE PART																																																																																									
Code	Description	Image	Code	Description	Components list																																																																																							
VT1308A	LOW PROVER DOOR GLASS		KVT1308AR	8 TRAYS PROVER RIGHT DOOR GLASS KIT	<table border="1"> <thead> <tr> <th>Code</th> <th>Description</th> <th>Qty</th> <th>UOM</th> </tr> </thead> <tbody> <tr> <td>CR1081A0</td> <td>XV-XL-XB ST. STEEL LEFT HINGE</td> <td>1</td> <td>PZ</td> </tr> <tr> <td>GN1330A0</td> <td>FERRITIC PLATE GASKET XL40</td> <td>1</td> <td>PZ</td> </tr> <tr> <td>GN1554A0</td> <td>PROOFER HANDLE GASKET</td> <td>1</td> <td>PZ</td> </tr> <tr> <td>GN1577A1</td> <td>PROOFER HINGE GASKE</td> <td>2</td> <td>PZ</td> </tr> <tr> <td>IP1508A1</td> <td>POLYSTYREN E U SHAPED PROFILE 2000X60X60</td> <td>1.500</td> <td>M</td> </tr> <tr> <td>MG1082A0</td> <td>HANDLE END PROFILE 20X2</td> <td>2</td> <td>PZ</td> </tr> <tr> <td>TB2969A0</td> <td>8TRAY PROOFER HANDLE PROFILE 20X2</td> <td>1</td> <td>PZ</td> </tr> <tr> <td>VI1685A0</td> <td>M6X6 STAINLESS STEEL SCREW</td> <td>4</td> <td>PZ</td> </tr> <tr> <td>VI1930A0</td> <td>5X25 ST. STEEL SCREW CHIP</td> <td>2</td> <td>PZ</td> </tr> <tr> <td>VM1059A1</td> <td>HEAT SHRINK FILM H800</td> <td>1</td> <td>M</td> </tr> <tr> <td>VM1720A0</td> <td>XL405 DOOR WASKER</td> <td>1</td> <td>PZ</td> </tr> <tr> <td>VM2000A0</td> <td>M4 SOCKET HEAD SCREW COVER</td> <td>4</td> <td>PZ</td> </tr> <tr> <td>VT1308A0</td> <td>LOW PROVER DOOR GLASS</td> <td></td> <td></td> <td>1</td> <td>PZ</td> </tr> <tr> <td>VT1308A0</td> <td>LOW PROVER DOOR GLASS</td> <td></td> <td></td> <td>1</td> <td>PZ</td> </tr> </tbody> </table>	Code	Description	Qty	UOM	CR1081A0	XV-XL-XB ST. STEEL LEFT HINGE	1	PZ	GN1330A0	FERRITIC PLATE GASKET XL40	1	PZ	GN1554A0	PROOFER HANDLE GASKET	1	PZ	GN1577A1	PROOFER HINGE GASKE	2	PZ	IP1508A1	POLYSTYREN E U SHAPED PROFILE 2000X60X60	1.500	M	MG1082A0	HANDLE END PROFILE 20X2	2	PZ	TB2969A0	8TRAY PROOFER HANDLE PROFILE 20X2	1	PZ	VI1685A0	M6X6 STAINLESS STEEL SCREW	4	PZ	VI1930A0	5X25 ST. STEEL SCREW CHIP	2	PZ	VM1059A1	HEAT SHRINK FILM H800	1	M	VM1720A0	XL405 DOOR WASKER	1	PZ	VM2000A0	M4 SOCKET HEAD SCREW COVER	4	PZ	VT1308A0	LOW PROVER DOOR GLASS			1	PZ	VT1308A0	LOW PROVER DOOR GLASS			1	PZ	KVT1308AL	8 TRAYS PROVER LEFT DOOR GLASS KIT	<table border="1"> <thead> <tr> <th>Code</th> <th>Description</th> <th>Qty</th> <th>UOM</th> </tr> </thead> <tbody> <tr> <td>0H4540A0</td> <td>DOOR PLATES MAGNET XL40</td> <td>1</td> <td>PZ</td> </tr> <tr> <td>0H7216A0</td> <td>BAKERTOP PROOFER LEFT DRIP TRAY</td> <td>1</td> <td>PZ</td> </tr> <tr> <td>0H7325A0</td> <td>600X400 8TRAY PROOFER DOOR BAND</td> <td>1</td> <td>PZ</td> </tr> <tr> <td>CR1080A0</td> <td>XV-XL-XB ST. STEEL RIGHT HINGE</td> <td>1</td> <td>PZ</td> </tr> </tbody> </table>	Code	Description	Qty	UOM	0H4540A0	DOOR PLATES MAGNET XL40	1	PZ	0H7216A0	BAKERTOP PROOFER LEFT DRIP TRAY	1	PZ	0H7325A0	600X400 8TRAY PROOFER DOOR BAND	1	PZ	CR1080A0	XV-XL-XB ST. STEEL RIGHT HINGE	1	PZ
			Code	Description	Qty	UOM																																																																																						
CR1081A0	XV-XL-XB ST. STEEL LEFT HINGE	1	PZ																																																																																									
GN1330A0	FERRITIC PLATE GASKET XL40	1	PZ																																																																																									
GN1554A0	PROOFER HANDLE GASKET	1	PZ																																																																																									
GN1577A1	PROOFER HINGE GASKE	2	PZ																																																																																									
IP1508A1	POLYSTYREN E U SHAPED PROFILE 2000X60X60	1.500	M																																																																																									
MG1082A0	HANDLE END PROFILE 20X2	2	PZ																																																																																									
TB2969A0	8TRAY PROOFER HANDLE PROFILE 20X2	1	PZ																																																																																									
VI1685A0	M6X6 STAINLESS STEEL SCREW	4	PZ																																																																																									
VI1930A0	5X25 ST. STEEL SCREW CHIP	2	PZ																																																																																									
VM1059A1	HEAT SHRINK FILM H800	1	M																																																																																									
VM1720A0	XL405 DOOR WASKER	1	PZ																																																																																									
VM2000A0	M4 SOCKET HEAD SCREW COVER	4	PZ																																																																																									
VT1308A0	LOW PROVER DOOR GLASS			1	PZ																																																																																							
VT1308A0	LOW PROVER DOOR GLASS			1	PZ																																																																																							
Code	Description	Qty	UOM																																																																																									
0H4540A0	DOOR PLATES MAGNET XL40	1	PZ																																																																																									
0H7216A0	BAKERTOP PROOFER LEFT DRIP TRAY	1	PZ																																																																																									
0H7325A0	600X400 8TRAY PROOFER DOOR BAND	1	PZ																																																																																									
CR1080A0	XV-XL-XB ST. STEEL RIGHT HINGE	1	PZ																																																																																									

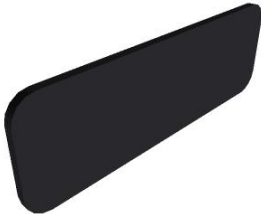



COMPONENT			SPARE PART																																																														
Code	Description	Image	Code	Description	Components list																																																												
VT1308A	LOW PROVER DOOR GLASS		KVT1308AL	8 TRAYS PROVER LEFT DOOR GLASS KIT	<table border="1"> <thead> <tr> <th>Code</th> <th>Description</th> <th>Qty</th> <th>UOM</th> </tr> </thead> <tbody> <tr> <td>CR1081A0</td> <td>XV-XL-XB ST. STEEL LEFT HINGE</td> <td>1</td> <td>PZ</td> </tr> <tr> <td>GN1330A0</td> <td>FERRITIC PLATE GASKET XL40</td> <td>1</td> <td>PZ</td> </tr> <tr> <td>GN1554A0</td> <td>PROOFER HANDLE GASKET</td> <td>1</td> <td>PZ</td> </tr> <tr> <td>GN1577A1</td> <td>PROOFER HINGE GASKE</td> <td>2</td> <td>PZ</td> </tr> <tr> <td>IP1508A1</td> <td>POLYSTYREN E U SHAPED PROFILE 2000X60X60</td> <td>1.500</td> <td>M</td> </tr> <tr> <td>MG1082A0</td> <td>HANDLE END PROFILE 20X2</td> <td>2</td> <td>PZ</td> </tr> <tr> <td>TB2969A0</td> <td>8TRAY PROOFER HANDLE PROFILE 20X2</td> <td>1</td> <td>PZ</td> </tr> <tr> <td>VI1685A0</td> <td>M6X6 STAINLESS STEEL SCREW</td> <td>4</td> <td>PZ</td> </tr> <tr> <td>VI1930A0</td> <td>5X25 ST. STEEL SCREW CHIP</td> <td>2</td> <td>PZ</td> </tr> <tr> <td>VM1059A1</td> <td>HEAT SHRINK FILM H800</td> <td>1</td> <td>M</td> </tr> <tr> <td>VM1720A0</td> <td>XL405 DOOR WASKER</td> <td>1</td> <td>PZ</td> </tr> <tr> <td>VM2000A0</td> <td>M4 SOCKET HEAD SCREW COVER</td> <td>4</td> <td>PZ</td> </tr> <tr> <td>VT1308A0</td> <td>LOW PROVER DOOR GLASS</td> <td>1</td> <td>PZ</td> </tr> <tr> <td>VT1308A0</td> <td>LOW PROVER DOOR GLASS</td> <td>1</td> <td>PZ</td> </tr> </tbody> </table>	Code	Description	Qty	UOM	CR1081A0	XV-XL-XB ST. STEEL LEFT HINGE	1	PZ	GN1330A0	FERRITIC PLATE GASKET XL40	1	PZ	GN1554A0	PROOFER HANDLE GASKET	1	PZ	GN1577A1	PROOFER HINGE GASKE	2	PZ	IP1508A1	POLYSTYREN E U SHAPED PROFILE 2000X60X60	1.500	M	MG1082A0	HANDLE END PROFILE 20X2	2	PZ	TB2969A0	8TRAY PROOFER HANDLE PROFILE 20X2	1	PZ	VI1685A0	M6X6 STAINLESS STEEL SCREW	4	PZ	VI1930A0	5X25 ST. STEEL SCREW CHIP	2	PZ	VM1059A1	HEAT SHRINK FILM H800	1	M	VM1720A0	XL405 DOOR WASKER	1	PZ	VM2000A0	M4 SOCKET HEAD SCREW COVER	4	PZ	VT1308A0	LOW PROVER DOOR GLASS	1	PZ	VT1308A0	LOW PROVER DOOR GLASS	1	PZ
					Code	Description	Qty	UOM																																																									
					CR1081A0	XV-XL-XB ST. STEEL LEFT HINGE	1	PZ																																																									
					GN1330A0	FERRITIC PLATE GASKET XL40	1	PZ																																																									
					GN1554A0	PROOFER HANDLE GASKET	1	PZ																																																									
					GN1577A1	PROOFER HINGE GASKE	2	PZ																																																									
					IP1508A1	POLYSTYREN E U SHAPED PROFILE 2000X60X60	1.500	M																																																									
					MG1082A0	HANDLE END PROFILE 20X2	2	PZ																																																									
					TB2969A0	8TRAY PROOFER HANDLE PROFILE 20X2	1	PZ																																																									
					VI1685A0	M6X6 STAINLESS STEEL SCREW	4	PZ																																																									
					VI1930A0	5X25 ST. STEEL SCREW CHIP	2	PZ																																																									
					VM1059A1	HEAT SHRINK FILM H800	1	M																																																									
					VM1720A0	XL405 DOOR WASKER	1	PZ																																																									
					VM2000A0	M4 SOCKET HEAD SCREW COVER	4	PZ																																																									
VT1308A0	LOW PROVER DOOR GLASS	1	PZ																																																														
VT1308A0	LOW PROVER DOOR GLASS	1	PZ																																																														
GN1577A	PROOFER HINGE GASKET		GN1577A1	PROOFER HINGE GASKET																																																													

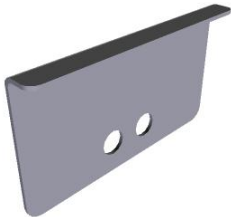





COMPONENT			SPARE PART																																																						
Code	Description	Image	Code	Description	Components list																																																				
0H4540A	DOOR PLATES MAGNET XL405		0H4540A0	DOOR PLATES MAGNET XL405																																																					
VM1720A	XL405 DOOR WASKER		VM1720A0	XL405 DOOR WASKER																																																					
GN1330A	FERRITIC PLATE GASKET XL405		KVT1086BR	XLT195/XLT193 RIGHT COMPLETE DOOR KIT	<table border="1"> <thead> <tr> <th>Code</th> <th>Description</th> <th>Qty</th> <th>UOM</th> </tr> </thead> <tbody> <tr> <td>0H4540A0</td> <td>DOOR PLATES MAGNET XL40</td> <td>1</td> <td>PZ</td> </tr> <tr> <td>CR1080A0</td> <td>XV-XL-XB ST. STEEL RIGHT HINGE</td> <td>1</td> <td>PZ</td> </tr> <tr> <td>CR1081A0</td> <td>XV-XL-XB ST. STEEL LEFT HINGE</td> <td>1</td> <td>PZ</td> </tr> <tr> <td>GN1320A1</td> <td>DOOR GLASS GASKET</td> <td>2</td> <td>PZ</td> </tr> <tr> <td>GN1330A0</td> <td>FERRITIC PLATE GASKET XL40</td> <td>1</td> <td>PZ</td> </tr> <tr> <td>MG1015B0</td> <td>L.MISS/L.MICR O/CHEFTOP HANDLE END</td> <td>2</td> <td>PZ</td> </tr> <tr> <td>TB1077A0</td> <td>XLT135/XLT19 5 Ø18X1 HANDLE TUBE</td> <td>1</td> <td>PZ</td> </tr> <tr> <td>V11685A0</td> <td>M6X6 STAINLESS STEEL SCREW</td> <td>4</td> <td>PZ</td> </tr> <tr> <td>V11930A0</td> <td>5X25 ST. STEEL SCREW CHIP</td> <td>2</td> <td>PZ</td> </tr> <tr> <td>VM1720A0</td> <td>XL405 DOOR WASKER</td> <td>1</td> <td>PZ</td> </tr> <tr> <td>VT1086B0</td> <td>XLT195/XLT19 3 DOOR BLACK GLASS 399X661</td> <td>1</td> <td>PZ</td> </tr> <tr> <td>VT1086B0</td> <td>XLT195/XLT19 3 DOOR BLACK GLASS 399X661</td> <td>1</td> <td>PZ</td> </tr> </tbody> </table>	Code	Description	Qty	UOM	0H4540A0	DOOR PLATES MAGNET XL40	1	PZ	CR1080A0	XV-XL-XB ST. STEEL RIGHT HINGE	1	PZ	CR1081A0	XV-XL-XB ST. STEEL LEFT HINGE	1	PZ	GN1320A1	DOOR GLASS GASKET	2	PZ	GN1330A0	FERRITIC PLATE GASKET XL40	1	PZ	MG1015B0	L.MISS/L.MICR O/CHEFTOP HANDLE END	2	PZ	TB1077A0	XLT135/XLT19 5 Ø18X1 HANDLE TUBE	1	PZ	V11685A0	M6X6 STAINLESS STEEL SCREW	4	PZ	V11930A0	5X25 ST. STEEL SCREW CHIP	2	PZ	VM1720A0	XL405 DOOR WASKER	1	PZ	VT1086B0	XLT195/XLT19 3 DOOR BLACK GLASS 399X661	1	PZ	VT1086B0	XLT195/XLT19 3 DOOR BLACK GLASS 399X661	1	PZ
Code	Description	Qty	UOM																																																						
0H4540A0	DOOR PLATES MAGNET XL40	1	PZ																																																						
CR1080A0	XV-XL-XB ST. STEEL RIGHT HINGE	1	PZ																																																						
CR1081A0	XV-XL-XB ST. STEEL LEFT HINGE	1	PZ																																																						
GN1320A1	DOOR GLASS GASKET	2	PZ																																																						
GN1330A0	FERRITIC PLATE GASKET XL40	1	PZ																																																						
MG1015B0	L.MISS/L.MICR O/CHEFTOP HANDLE END	2	PZ																																																						
TB1077A0	XLT135/XLT19 5 Ø18X1 HANDLE TUBE	1	PZ																																																						
V11685A0	M6X6 STAINLESS STEEL SCREW	4	PZ																																																						
V11930A0	5X25 ST. STEEL SCREW CHIP	2	PZ																																																						
VM1720A0	XL405 DOOR WASKER	1	PZ																																																						
VT1086B0	XLT195/XLT19 3 DOOR BLACK GLASS 399X661	1	PZ																																																						
VT1086B0	XLT195/XLT19 3 DOOR BLACK GLASS 399X661	1	PZ																																																						

COMPONENT			SPARE PART																																																																																					
Code	Description	Image	Code	Description	Components list																																																																																			
GN1330A	FERRITIC PLATE GASKET XL405		KVT1086BL	XLT195/XLT193 LEFT COMPLETE DOOR KIT	<table border="1"> <thead> <tr> <th>Code</th> <th>Description</th> <th>Qty</th> <th>UOM</th> </tr> </thead> <tbody> <tr> <td>0H4540A0</td> <td>DOOR PLATES MAGNET XL40</td> <td>1</td> <td>PZ</td> </tr> <tr> <td>CR1080A0</td> <td>XV-XL-XB ST. STEEL RIGHT HINGE</td> <td>1</td> <td>PZ</td> </tr> <tr> <td>CR1081A0</td> <td>XV-XL-XB ST. STEEL LEFT HINGE</td> <td>1</td> <td>PZ</td> </tr> <tr> <td>GN1320A1</td> <td>DOOR GLASS GASKET</td> <td>2</td> <td>PZ</td> </tr> <tr> <td>GN1330A0</td> <td>FERRITIC PLATE GASKET XL40</td> <td>1</td> <td>PZ</td> </tr> <tr> <td>MG1015B0</td> <td>L.MISS/L.MICR O/CHEFTOP HANDLE END</td> <td>2</td> <td>PZ</td> </tr> <tr> <td>TB1077A0</td> <td>XLT135/XLT19 5 Ø18X1 HANDLE TUBE</td> <td>1</td> <td>PZ</td> </tr> <tr> <td>VI1685A0</td> <td>M6X6 STAINLESS STEEL SCREW</td> <td>4</td> <td>PZ</td> </tr> <tr> <td>VI1930A0</td> <td>5X25 ST. STEEL SCREW CHIP</td> <td>2</td> <td>PZ</td> </tr> <tr> <td>VM1720A0</td> <td>XL405 DOOR WASKER</td> <td>1</td> <td>PZ</td> </tr> <tr> <td>VT1086B0</td> <td>XLT195/XLT19 3 DOOR BLACK GLASS 399X661</td> <td>1</td> <td>PZ</td> </tr> <tr> <td>VT1086B0</td> <td>XLT195/XLT19 3 DOOR BLACK GLASS 399X661</td> <td>1</td> <td>PZ</td> </tr> </tbody> </table>	Code	Description	Qty	UOM	0H4540A0	DOOR PLATES MAGNET XL40	1	PZ	CR1080A0	XV-XL-XB ST. STEEL RIGHT HINGE	1	PZ	CR1081A0	XV-XL-XB ST. STEEL LEFT HINGE	1	PZ	GN1320A1	DOOR GLASS GASKET	2	PZ	GN1330A0	FERRITIC PLATE GASKET XL40	1	PZ	MG1015B0	L.MISS/L.MICR O/CHEFTOP HANDLE END	2	PZ	TB1077A0	XLT135/XLT19 5 Ø18X1 HANDLE TUBE	1	PZ	VI1685A0	M6X6 STAINLESS STEEL SCREW	4	PZ	VI1930A0	5X25 ST. STEEL SCREW CHIP	2	PZ	VM1720A0	XL405 DOOR WASKER	1	PZ	VT1086B0	XLT195/XLT19 3 DOOR BLACK GLASS 399X661	1	PZ	VT1086B0	XLT195/XLT19 3 DOOR BLACK GLASS 399X661	1	PZ	KVT1076BR	XLT135/XLT133 RIGHT COMPLETE DOOR KIT	<table border="1"> <thead> <tr> <th>Code</th> <th>Description</th> <th>Qty</th> <th>UOM</th> </tr> </thead> <tbody> <tr> <td>0H4540A0</td> <td>DOOR PLATES MAGNET XL40</td> <td>1</td> <td>PZ</td> </tr> <tr> <td>CR1080A0</td> <td>XV-XL-XB ST. STEEL RIGHT HINGE</td> <td>1</td> <td>PZ</td> </tr> <tr> <td>CR1081A0</td> <td>XV-XL-XB ST. STEEL LEFT HINGE</td> <td>1</td> <td>PZ</td> </tr> <tr> <td>GN1320A1</td> <td>DOOR GLASS GASKET</td> <td>2</td> <td>PZ</td> </tr> <tr> <td>GN1330A0</td> <td>FERRITIC PLATE GASKET XL40</td> <td>1</td> <td>PZ</td> </tr> <tr> <td>IP1385A1</td> <td>CORNER POLYSTYREN E PACKING 110X80X2000</td> <td>1.400</td> <td>M</td> </tr> </tbody> </table>	Code	Description	Qty	UOM	0H4540A0	DOOR PLATES MAGNET XL40	1	PZ	CR1080A0	XV-XL-XB ST. STEEL RIGHT HINGE	1	PZ	CR1081A0	XV-XL-XB ST. STEEL LEFT HINGE	1	PZ	GN1320A1	DOOR GLASS GASKET	2	PZ	GN1330A0	FERRITIC PLATE GASKET XL40	1	PZ	IP1385A1	CORNER POLYSTYREN E PACKING 110X80X2000	1.400	M
			Code	Description	Qty	UOM																																																																																		
0H4540A0	DOOR PLATES MAGNET XL40	1	PZ																																																																																					
CR1080A0	XV-XL-XB ST. STEEL RIGHT HINGE	1	PZ																																																																																					
CR1081A0	XV-XL-XB ST. STEEL LEFT HINGE	1	PZ																																																																																					
GN1320A1	DOOR GLASS GASKET	2	PZ																																																																																					
GN1330A0	FERRITIC PLATE GASKET XL40	1	PZ																																																																																					
MG1015B0	L.MISS/L.MICR O/CHEFTOP HANDLE END	2	PZ																																																																																					
TB1077A0	XLT135/XLT19 5 Ø18X1 HANDLE TUBE	1	PZ																																																																																					
VI1685A0	M6X6 STAINLESS STEEL SCREW	4	PZ																																																																																					
VI1930A0	5X25 ST. STEEL SCREW CHIP	2	PZ																																																																																					
VM1720A0	XL405 DOOR WASKER	1	PZ																																																																																					
VT1086B0	XLT195/XLT19 3 DOOR BLACK GLASS 399X661	1	PZ																																																																																					
VT1086B0	XLT195/XLT19 3 DOOR BLACK GLASS 399X661	1	PZ																																																																																					
Code	Description	Qty	UOM																																																																																					
0H4540A0	DOOR PLATES MAGNET XL40	1	PZ																																																																																					
CR1080A0	XV-XL-XB ST. STEEL RIGHT HINGE	1	PZ																																																																																					
CR1081A0	XV-XL-XB ST. STEEL LEFT HINGE	1	PZ																																																																																					
GN1320A1	DOOR GLASS GASKET	2	PZ																																																																																					
GN1330A0	FERRITIC PLATE GASKET XL40	1	PZ																																																																																					
IP1385A1	CORNER POLYSTYREN E PACKING 110X80X2000	1.400	M																																																																																					





COMPONENT			SPARE PART																																										
Code	Description	Image	Code	Description	Components list																																								
GN1330A	FERRITIC PLATE GASKET XL405		KVT1076BR	XLT135/XLT133 RIGHT COMPLETE DOOR KIT	<table border="1"> <thead> <tr> <th>Code</th> <th>Description</th> <th>Qty</th> <th>UOM</th> </tr> </thead> <tbody> <tr> <td>IP1508A1</td> <td>POLYSTYREN E U SHAPED PROFILE 2000X60X60</td> <td>0.300</td> <td>M</td> </tr> <tr> <td>MG1015B0</td> <td>L.MISS/L.MICR O/CHEFTOP HANDLE END</td> <td>2</td> <td>PZ</td> </tr> <tr> <td>TB1077A0</td> <td>XLT135/XLT19 5 Ø18X1 HANDLE TUBE</td> <td>1</td> <td>PZ</td> </tr> <tr> <td>VI1685A0</td> <td>M6X6 STAINLESS STEEL SCREW</td> <td>4</td> <td>PZ</td> </tr> <tr> <td>VI1930A0</td> <td>5X25 ST. STEEL SCREW CHIP</td> <td>2</td> <td>PZ</td> </tr> <tr> <td>VM1059A1</td> <td>HEAT SHRINK FILM H800</td> <td>1.500</td> <td>M</td> </tr> <tr> <td>VM1720A0</td> <td>XL405 DOOR WASKER</td> <td>1</td> <td>PZ</td> </tr> <tr> <td>VT1076B0</td> <td>XLT135/XLT13 3 BLACK DOOR GLASS 299X661</td> <td>1</td> <td>PZ</td> </tr> <tr> <td>VT1076B0</td> <td>XLT135/XLT13 3 BLACK DOOR GLASS 299X661</td> <td>1</td> <td>PZ</td> </tr> </tbody> </table>	Code	Description	Qty	UOM	IP1508A1	POLYSTYREN E U SHAPED PROFILE 2000X60X60	0.300	M	MG1015B0	L.MISS/L.MICR O/CHEFTOP HANDLE END	2	PZ	TB1077A0	XLT135/XLT19 5 Ø18X1 HANDLE TUBE	1	PZ	VI1685A0	M6X6 STAINLESS STEEL SCREW	4	PZ	VI1930A0	5X25 ST. STEEL SCREW CHIP	2	PZ	VM1059A1	HEAT SHRINK FILM H800	1.500	M	VM1720A0	XL405 DOOR WASKER	1	PZ	VT1076B0	XLT135/XLT13 3 BLACK DOOR GLASS 299X661	1	PZ	VT1076B0	XLT135/XLT13 3 BLACK DOOR GLASS 299X661	1	PZ
			Code	Description	Qty	UOM																																							
IP1508A1	POLYSTYREN E U SHAPED PROFILE 2000X60X60	0.300	M																																										
MG1015B0	L.MISS/L.MICR O/CHEFTOP HANDLE END	2	PZ																																										
TB1077A0	XLT135/XLT19 5 Ø18X1 HANDLE TUBE	1	PZ																																										
VI1685A0	M6X6 STAINLESS STEEL SCREW	4	PZ																																										
VI1930A0	5X25 ST. STEEL SCREW CHIP	2	PZ																																										
VM1059A1	HEAT SHRINK FILM H800	1.500	M																																										
VM1720A0	XL405 DOOR WASKER	1	PZ																																										
VT1076B0	XLT135/XLT13 3 BLACK DOOR GLASS 299X661	1	PZ																																										
VT1076B0	XLT135/XLT13 3 BLACK DOOR GLASS 299X661	1	PZ																																										
KVT1076BL	XLT135/XLT133 LEFT COMPLETE DOOR KIT	<table border="1"> <thead> <tr> <th>Code</th> <th>Description</th> <th>Qty</th> <th>UOM</th> </tr> </thead> <tbody> <tr> <td>0H4540A0</td> <td>DOOR PLATES MAGNET XL40</td> <td>1</td> <td>PZ</td> </tr> <tr> <td>CR1080A0</td> <td>XV-XL-XB ST. STEEL RIGHT HINGE</td> <td>1</td> <td>PZ</td> </tr> <tr> <td>CR1081A0</td> <td>XV-XL-XB ST. STEEL LEFT HINGE</td> <td>1</td> <td>PZ</td> </tr> <tr> <td>GN1320A1</td> <td>DOOR GLASS GASKET</td> <td>2</td> <td>PZ</td> </tr> <tr> <td>GN1330A0</td> <td>FERRITIC PLATE GASKET XL40</td> <td>1</td> <td>PZ</td> </tr> <tr> <td>IP1385A1</td> <td>CORNER POLYSTYREN E PACKING 110X80X2000</td> <td>1.400</td> <td>M</td> </tr> <tr> <td>IP1508A1</td> <td>POLYSTYREN E U SHAPED PROFILE 2000X60X60</td> <td>0.300</td> <td>M</td> </tr> <tr> <td>MG1015B0</td> <td>L.MISS/L.MICR O/CHEFTOP HANDLE END</td> <td>2</td> <td>PZ</td> </tr> </tbody> </table>	Code	Description	Qty	UOM	0H4540A0	DOOR PLATES MAGNET XL40	1	PZ	CR1080A0	XV-XL-XB ST. STEEL RIGHT HINGE	1	PZ	CR1081A0	XV-XL-XB ST. STEEL LEFT HINGE	1	PZ	GN1320A1	DOOR GLASS GASKET	2	PZ	GN1330A0	FERRITIC PLATE GASKET XL40	1	PZ	IP1385A1	CORNER POLYSTYREN E PACKING 110X80X2000	1.400	M	IP1508A1	POLYSTYREN E U SHAPED PROFILE 2000X60X60	0.300	M	MG1015B0	L.MISS/L.MICR O/CHEFTOP HANDLE END	2	PZ							
Code	Description	Qty	UOM																																										
0H4540A0	DOOR PLATES MAGNET XL40	1	PZ																																										
CR1080A0	XV-XL-XB ST. STEEL RIGHT HINGE	1	PZ																																										
CR1081A0	XV-XL-XB ST. STEEL LEFT HINGE	1	PZ																																										
GN1320A1	DOOR GLASS GASKET	2	PZ																																										
GN1330A0	FERRITIC PLATE GASKET XL40	1	PZ																																										
IP1385A1	CORNER POLYSTYREN E PACKING 110X80X2000	1.400	M																																										
IP1508A1	POLYSTYREN E U SHAPED PROFILE 2000X60X60	0.300	M																																										
MG1015B0	L.MISS/L.MICR O/CHEFTOP HANDLE END	2	PZ																																										

COMPONENT			SPARE PART																																																		
Code	Description	Image	Code	Description	Components list																																																
GN1330A	FERRITIC PLATE		KVT1076BL	XLT135/XLT133 LEFT COMPLETE DOOR KIT	<table border="1"> <thead> <tr> <th>Code</th> <th>Description</th> <th>Qty</th> <th>UOM</th> </tr> </thead> <tbody> <tr> <td>TB1077A0</td> <td>XLT135/XLT19 5 Ø18X1 HANDLE TUBE</td> <td>1</td> <td>PZ</td> </tr> <tr> <td>VI1685A0</td> <td>M6X6 STAINLESS STEEL SCREW</td> <td>4</td> <td>PZ</td> </tr> <tr> <td>VI1930A0</td> <td>5X25 ST. STEEL SCREW CHIP</td> <td>2</td> <td>PZ</td> </tr> <tr> <td>VM1059A1</td> <td>HEAT SHRINK FILM H800</td> <td>1.500</td> <td>M</td> </tr> <tr> <td>VM1720A0</td> <td>XL405 DOOR WASKER</td> <td>1</td> <td>PZ</td> </tr> <tr> <td>VT1076B0</td> <td>XLT135/XLT13 3 BLACK DOOR GLASS 299X661</td> <td>1</td> <td>PZ</td> </tr> <tr> <td>VT1076B0</td> <td>XLT135/XLT13 3 BLACK DOOR GLASS 299X661</td> <td>1</td> <td>PZ</td> </tr> </tbody> </table>	Code	Description	Qty	UOM	TB1077A0	XLT135/XLT19 5 Ø18X1 HANDLE TUBE	1	PZ	VI1685A0	M6X6 STAINLESS STEEL SCREW	4	PZ	VI1930A0	5X25 ST. STEEL SCREW CHIP	2	PZ	VM1059A1	HEAT SHRINK FILM H800	1.500	M	VM1720A0	XL405 DOOR WASKER	1	PZ	VT1076B0	XLT135/XLT13 3 BLACK DOOR GLASS 299X661	1	PZ	VT1076B0	XLT135/XLT13 3 BLACK DOOR GLASS 299X661	1	PZ																
	Code		Description	Qty	UOM																																																
TB1077A0	XLT135/XLT19 5 Ø18X1 HANDLE TUBE	1	PZ																																																		
VI1685A0	M6X6 STAINLESS STEEL SCREW	4	PZ																																																		
VI1930A0	5X25 ST. STEEL SCREW CHIP	2	PZ																																																		
VM1059A1	HEAT SHRINK FILM H800	1.500	M																																																		
VM1720A0	XL405 DOOR WASKER	1	PZ																																																		
VT1076B0	XLT135/XLT13 3 BLACK DOOR GLASS 299X661	1	PZ																																																		
VT1076B0	XLT135/XLT13 3 BLACK DOOR GLASS 299X661	1	PZ																																																		
	GASKET XL405		KDR1210AR	XL405 COMPLETE RIGHT DOOR	<table border="1"> <thead> <tr> <th>Code</th> <th>Description</th> <th>Qty</th> <th>UOM</th> </tr> </thead> <tbody> <tr> <td>0H4530C0</td> <td>RIGHT DOOR DRIPPING TRAY XL415</td> <td>1</td> <td>PZ</td> </tr> <tr> <td>0H4540A0</td> <td>DOOR PLATES MAGNET XL40</td> <td>1</td> <td>PZ</td> </tr> <tr> <td>CR1080A0</td> <td>XV-XL-XB ST. STEEL RIGHT HINGE</td> <td>1</td> <td>PZ</td> </tr> <tr> <td>CR1081A0</td> <td>XV-XL-XB ST. STEEL LEFT HINGE</td> <td>1</td> <td>PZ</td> </tr> <tr> <td>GN1320A1</td> <td>DOOR GLASS GASKET</td> <td>2</td> <td>PZ</td> </tr> <tr> <td>GN1330A0</td> <td>FERRITIC PLATE GASKET XL40</td> <td>1</td> <td>PZ</td> </tr> <tr> <td>IP1385A1</td> <td>CORNER POLYSTYREN E PACKING 110X80X2000</td> <td>1.300</td> <td>M</td> </tr> <tr> <td>IP1508A1</td> <td>POLYSTYREN E U SHAPED PROFILE 2000X60X60</td> <td>0.570</td> <td>M</td> </tr> <tr> <td>MG1015B0</td> <td>L.MISS/L.MICR O/CHEFTOP HANDLE END</td> <td>2</td> <td>PZ</td> </tr> <tr> <td>TB1730A0</td> <td>XL405-413-415 HANDLE TUBE</td> <td>1</td> <td>PZ</td> </tr> <tr> <td>VI1685A0</td> <td>M6X6 STAINLESS STEEL SCREW</td> <td>4</td> <td>PZ</td> </tr> </tbody> </table>	Code	Description	Qty	UOM	0H4530C0	RIGHT DOOR DRIPPING TRAY XL415	1	PZ	0H4540A0	DOOR PLATES MAGNET XL40	1	PZ	CR1080A0	XV-XL-XB ST. STEEL RIGHT HINGE	1	PZ	CR1081A0	XV-XL-XB ST. STEEL LEFT HINGE	1	PZ	GN1320A1	DOOR GLASS GASKET	2	PZ	GN1330A0	FERRITIC PLATE GASKET XL40	1	PZ	IP1385A1	CORNER POLYSTYREN E PACKING 110X80X2000	1.300	M	IP1508A1	POLYSTYREN E U SHAPED PROFILE 2000X60X60	0.570	M	MG1015B0	L.MISS/L.MICR O/CHEFTOP HANDLE END	2	PZ	TB1730A0	XL405-413-415 HANDLE TUBE	1	PZ	VI1685A0	M6X6 STAINLESS STEEL SCREW	4	PZ
Code	Description	Qty	UOM																																																		
0H4530C0	RIGHT DOOR DRIPPING TRAY XL415	1	PZ																																																		
0H4540A0	DOOR PLATES MAGNET XL40	1	PZ																																																		
CR1080A0	XV-XL-XB ST. STEEL RIGHT HINGE	1	PZ																																																		
CR1081A0	XV-XL-XB ST. STEEL LEFT HINGE	1	PZ																																																		
GN1320A1	DOOR GLASS GASKET	2	PZ																																																		
GN1330A0	FERRITIC PLATE GASKET XL40	1	PZ																																																		
IP1385A1	CORNER POLYSTYREN E PACKING 110X80X2000	1.300	M																																																		
IP1508A1	POLYSTYREN E U SHAPED PROFILE 2000X60X60	0.570	M																																																		
MG1015B0	L.MISS/L.MICR O/CHEFTOP HANDLE END	2	PZ																																																		
TB1730A0	XL405-413-415 HANDLE TUBE	1	PZ																																																		
VI1685A0	M6X6 STAINLESS STEEL SCREW	4	PZ																																																		

COMPONENT			SPARE PART																																																															
Code	Description	Image	Code	Description	Components list																																																													
GN1330A	FERRITIC PLATE GASKET XL405		KDR1210AR	XL405 COMPLETE RIGHT DOOR	<table border="1"> <thead> <tr> <th>Code</th> <th>Description</th> <th>Qty</th> <th>UOM</th> </tr> </thead> <tbody> <tr> <td>VI1930A0</td> <td>5X25 ST. STEEL SCREW CHIP</td> <td>2</td> <td>PZ</td> </tr> <tr> <td>VM1059A1</td> <td>HEAT SHRINK FILM H800</td> <td>1.300</td> <td>M</td> </tr> <tr> <td>VM1720A0</td> <td>XL405 DOOR WASKER</td> <td>1</td> <td>PZ</td> </tr> <tr> <td>VM1790A0</td> <td>HINGE BUSH 12X6.5 DI5.3</td> <td>2</td> <td>PZ</td> </tr> <tr> <td>VT1210A0</td> <td>XL405-413-415 DOOR GLASS</td> <td>1</td> <td>PZ</td> </tr> <tr> <td>VT1210A0</td> <td>XL405-413-415 DOOR GLASS</td> <td>1</td> <td>PZ</td> </tr> </tbody> </table>	Code	Description	Qty	UOM	VI1930A0	5X25 ST. STEEL SCREW CHIP	2	PZ	VM1059A1	HEAT SHRINK FILM H800	1.300	M	VM1720A0	XL405 DOOR WASKER	1	PZ	VM1790A0	HINGE BUSH 12X6.5 DI5.3	2	PZ	VT1210A0	XL405-413-415 DOOR GLASS	1	PZ	VT1210A0	XL405-413-415 DOOR GLASS	1	PZ																																	
			Code	Description	Qty	UOM																																																												
VI1930A0	5X25 ST. STEEL SCREW CHIP	2	PZ																																																															
VM1059A1	HEAT SHRINK FILM H800	1.300	M																																																															
VM1720A0	XL405 DOOR WASKER	1	PZ																																																															
VM1790A0	HINGE BUSH 12X6.5 DI5.3	2	PZ																																																															
VT1210A0	XL405-413-415 DOOR GLASS	1	PZ																																																															
VT1210A0	XL405-413-415 DOOR GLASS	1	PZ																																																															
KDR1210AL	XL405 COMPLETE LEFT DOOR	<table border="1"> <thead> <tr> <th>Code</th> <th>Description</th> <th>Qty</th> <th>UOM</th> </tr> </thead> <tbody> <tr> <td>0H4535C0</td> <td>LEFT DOOR DRIPPING TRAY XL415</td> <td>1</td> <td>PZ</td> </tr> <tr> <td>0H4540A0</td> <td>DOOR PLATES MAGNET XL40</td> <td>1</td> <td>PZ</td> </tr> <tr> <td>CR1080A0</td> <td>XV-XL-XB ST. STEEL RIGHT HINGE</td> <td>1</td> <td>PZ</td> </tr> <tr> <td>CR1081A0</td> <td>XV-XL-XB ST. STEEL LEFT HINGE</td> <td>1</td> <td>PZ</td> </tr> <tr> <td>GN1320A1</td> <td>DOOR GLASS GASKET</td> <td>2</td> <td>PZ</td> </tr> <tr> <td>GN1330A0</td> <td>FERRITIC PLATE GASKET XL40</td> <td>1</td> <td>PZ</td> </tr> <tr> <td>IP1385A1</td> <td>CORNER POLYSTYREN E PACKING 110X80X2000</td> <td>1.300</td> <td>M</td> </tr> <tr> <td>IP1508A1</td> <td>POLYSTYREN E U SHAPED PROFILE 2000X60X60</td> <td>0.570</td> <td>M</td> </tr> <tr> <td>MG1015B0</td> <td>L.MISS/L.MICR O/CHEFTOP HANDLE END</td> <td>2</td> <td>PZ</td> </tr> <tr> <td>TB1730A0</td> <td>XL405-413-415 HANDLE TUBE</td> <td>1</td> <td>PZ</td> </tr> <tr> <td>VI1685A0</td> <td>M6X6 STAINLESS STEEL SCREW</td> <td>4</td> <td>PZ</td> </tr> <tr> <td>VI1930A0</td> <td>5X25 ST. STEEL SCREW CHIP</td> <td>2</td> <td>PZ</td> </tr> <tr> <td>VM1059A1</td> <td>HEAT SHRINK FILM H800</td> <td>1.300</td> <td>M</td> </tr> <tr> <td>VM1720A0</td> <td>XL405 DOOR WASKER</td> <td>1</td> <td>PZ</td> </tr> <tr> <td>VM1790A0</td> <td>HINGE BUSH 12X6.5 DI5.3</td> <td>2</td> <td>PZ</td> </tr> </tbody> </table>	Code	Description	Qty	UOM	0H4535C0	LEFT DOOR DRIPPING TRAY XL415	1	PZ	0H4540A0	DOOR PLATES MAGNET XL40	1	PZ	CR1080A0	XV-XL-XB ST. STEEL RIGHT HINGE	1	PZ	CR1081A0	XV-XL-XB ST. STEEL LEFT HINGE	1	PZ	GN1320A1	DOOR GLASS GASKET	2	PZ	GN1330A0	FERRITIC PLATE GASKET XL40	1	PZ	IP1385A1	CORNER POLYSTYREN E PACKING 110X80X2000	1.300	M	IP1508A1	POLYSTYREN E U SHAPED PROFILE 2000X60X60	0.570	M	MG1015B0	L.MISS/L.MICR O/CHEFTOP HANDLE END	2	PZ	TB1730A0	XL405-413-415 HANDLE TUBE	1	PZ	VI1685A0	M6X6 STAINLESS STEEL SCREW	4	PZ	VI1930A0	5X25 ST. STEEL SCREW CHIP	2	PZ	VM1059A1	HEAT SHRINK FILM H800	1.300	M	VM1720A0	XL405 DOOR WASKER	1	PZ	VM1790A0	HINGE BUSH 12X6.5 DI5.3	2	PZ
Code	Description	Qty	UOM																																																															
0H4535C0	LEFT DOOR DRIPPING TRAY XL415	1	PZ																																																															
0H4540A0	DOOR PLATES MAGNET XL40	1	PZ																																																															
CR1080A0	XV-XL-XB ST. STEEL RIGHT HINGE	1	PZ																																																															
CR1081A0	XV-XL-XB ST. STEEL LEFT HINGE	1	PZ																																																															
GN1320A1	DOOR GLASS GASKET	2	PZ																																																															
GN1330A0	FERRITIC PLATE GASKET XL40	1	PZ																																																															
IP1385A1	CORNER POLYSTYREN E PACKING 110X80X2000	1.300	M																																																															
IP1508A1	POLYSTYREN E U SHAPED PROFILE 2000X60X60	0.570	M																																																															
MG1015B0	L.MISS/L.MICR O/CHEFTOP HANDLE END	2	PZ																																																															
TB1730A0	XL405-413-415 HANDLE TUBE	1	PZ																																																															
VI1685A0	M6X6 STAINLESS STEEL SCREW	4	PZ																																																															
VI1930A0	5X25 ST. STEEL SCREW CHIP	2	PZ																																																															
VM1059A1	HEAT SHRINK FILM H800	1.300	M																																																															
VM1720A0	XL405 DOOR WASKER	1	PZ																																																															
VM1790A0	HINGE BUSH 12X6.5 DI5.3	2	PZ																																																															

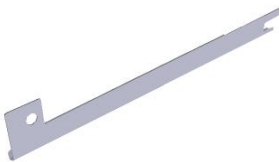
COMPONENT			SPARE PART																														
Code	Description	Image	Code	Description	Components list																												
GN1330A	FERRITIC PLATE GASKET XL405		KDR1210AL	XL405 COMPLETE LEFT DOOR	<table border="1"> <thead> <tr> <th>Code</th> <th>Description</th> <th>Qty</th> <th>UOM</th> </tr> </thead> <tbody> <tr> <td>VT1210A0</td> <td>XL405-413-415 DOOR GLASS</td> <td>1</td> <td>PZ</td> </tr> <tr> <td>VT1210A0</td> <td>XL405-413-415 DOOR GLASS</td> <td>1</td> <td>PZ</td> </tr> </tbody> </table>	Code	Description	Qty	UOM	VT1210A0	XL405-413-415 DOOR GLASS	1	PZ	VT1210A0	XL405-413-415 DOOR GLASS	1	PZ																
Code	Description	Qty	UOM																														
VT1210A0	XL405-413-415 DOOR GLASS	1	PZ																														
VT1210A0	XL405-413-415 DOOR GLASS	1	PZ																														
CR1081A	XV-XL-XB ST. STEEL LEFT HINGE		KCR1080A	RIGHT/LEFT HINGES KIT CR1080A+CR1081A	<table border="1"> <thead> <tr> <th>Code</th> <th>Description</th> <th>Qty</th> <th>UOM</th> </tr> </thead> <tbody> <tr> <td>CR1080A0</td> <td>XV-XL-XB ST. STEEL RIGHT HINGE</td> <td>1</td> <td>PZ</td> </tr> <tr> <td>CR1081A0</td> <td>XV-XL-XB ST. STEEL LEFT HINGE</td> <td>1</td> <td>PZ</td> </tr> <tr> <td>GN1320A1</td> <td>DOOR GLASS GASKET</td> <td>2</td> <td>PZ</td> </tr> <tr> <td>VI1685A0</td> <td>M6X6 STAINLESS STEEL SCREW</td> <td>4</td> <td>PZ</td> </tr> <tr> <td>VM1224A0</td> <td></td> <td>0.200</td> <td>M</td> </tr> <tr> <td>VM1790A0</td> <td>HINGE BUSH 12X6.5 DI5.3</td> <td>2</td> <td>PZ</td> </tr> </tbody> </table>	Code	Description	Qty	UOM	CR1080A0	XV-XL-XB ST. STEEL RIGHT HINGE	1	PZ	CR1081A0	XV-XL-XB ST. STEEL LEFT HINGE	1	PZ	GN1320A1	DOOR GLASS GASKET	2	PZ	VI1685A0	M6X6 STAINLESS STEEL SCREW	4	PZ	VM1224A0		0.200	M	VM1790A0	HINGE BUSH 12X6.5 DI5.3	2	PZ
Code	Description	Qty	UOM																														
CR1080A0	XV-XL-XB ST. STEEL RIGHT HINGE	1	PZ																														
CR1081A0	XV-XL-XB ST. STEEL LEFT HINGE	1	PZ																														
GN1320A1	DOOR GLASS GASKET	2	PZ																														
VI1685A0	M6X6 STAINLESS STEEL SCREW	4	PZ																														
VM1224A0		0.200	M																														
VM1790A0	HINGE BUSH 12X6.5 DI5.3	2	PZ																														
CR1080A	XV-XL-XB ST. STEEL RIGHT HINGE		KCR1080A	RIGHT/LEFT HINGES KIT CR1080A+CR1081A	<table border="1"> <thead> <tr> <th>Code</th> <th>Description</th> <th>Qty</th> <th>UOM</th> </tr> </thead> <tbody> <tr> <td>CR1080A0</td> <td>XV-XL-XB ST. STEEL RIGHT HINGE</td> <td>1</td> <td>PZ</td> </tr> <tr> <td>CR1081A0</td> <td>XV-XL-XB ST. STEEL LEFT HINGE</td> <td>1</td> <td>PZ</td> </tr> <tr> <td>GN1320A1</td> <td>DOOR GLASS GASKET</td> <td>2</td> <td>PZ</td> </tr> <tr> <td>VI1685A0</td> <td>M6X6 STAINLESS STEEL SCREW</td> <td>4</td> <td>PZ</td> </tr> <tr> <td>VM1224A0</td> <td></td> <td>0.200</td> <td>M</td> </tr> <tr> <td>VM1790A0</td> <td>HINGE BUSH 12X6.5 DI5.3</td> <td>2</td> <td>PZ</td> </tr> </tbody> </table>	Code	Description	Qty	UOM	CR1080A0	XV-XL-XB ST. STEEL RIGHT HINGE	1	PZ	CR1081A0	XV-XL-XB ST. STEEL LEFT HINGE	1	PZ	GN1320A1	DOOR GLASS GASKET	2	PZ	VI1685A0	M6X6 STAINLESS STEEL SCREW	4	PZ	VM1224A0		0.200	M	VM1790A0	HINGE BUSH 12X6.5 DI5.3	2	PZ
Code	Description	Qty	UOM																														
CR1080A0	XV-XL-XB ST. STEEL RIGHT HINGE	1	PZ																														
CR1081A0	XV-XL-XB ST. STEEL LEFT HINGE	1	PZ																														
GN1320A1	DOOR GLASS GASKET	2	PZ																														
VI1685A0	M6X6 STAINLESS STEEL SCREW	4	PZ																														
VM1224A0		0.200	M																														
VM1790A0	HINGE BUSH 12X6.5 DI5.3	2	PZ																														
MG1082A	HANDLE END PROFILE 20X20		MG1082A0	HANDLE END PROFILE 20X20																													



COMPONENT			SPARE PART																						
Code	Description	Image	Code	Description	Components list																				
GN1554A	PROOFER HANDLE GASKET		GN1554A0	PROOFER HANDLE GASKET																					
0H7217A	BAKERTOP PROOFER RIGHT DRIP TRAY		0H7217A0	BAKERTOP PROOFER RIGHT DRIP TRAY																					
0H7325A	600X400 8TRAY PROOFER DOOR BAND		0H7325A0	600X400 8TRAY PROOFER DOOR BAND																					
TB2969A	8TRAY PROOFER HANDLE PROFILE 20X20		TB2969A0	8TRAY PROOFER HANDLE PROFILE 20X20																					
VT1308A	LOW PROVER DOOR GLASS		KVT1308AR	8 TRAYS PROVER RIGHT DOOR GLASS KIT	<table border="1"> <thead> <tr> <th>Code</th> <th>Description</th> <th>Qty</th> <th>UOM</th> </tr> </thead> <tbody> <tr> <td>0H4540A0</td> <td>DOOR PLATES MAGNET XL40</td> <td>1</td> <td>PZ</td> </tr> <tr> <td>0H7217A0</td> <td>BAKERTOP PROOFER RIGHT DRIP TRAY</td> <td>1</td> <td>PZ</td> </tr> <tr> <td>0H7325A0</td> <td>600X400 8TRAY PROOFER DOOR BAND</td> <td>1</td> <td>PZ</td> </tr> <tr> <td>CR1080A0</td> <td>XV-XL-XB ST. STEEL RIGHT HINGE</td> <td>1</td> <td>PZ</td> </tr> </tbody> </table>	Code	Description	Qty	UOM	0H4540A0	DOOR PLATES MAGNET XL40	1	PZ	0H7217A0	BAKERTOP PROOFER RIGHT DRIP TRAY	1	PZ	0H7325A0	600X400 8TRAY PROOFER DOOR BAND	1	PZ	CR1080A0	XV-XL-XB ST. STEEL RIGHT HINGE	1	PZ
Code	Description	Qty	UOM																						
0H4540A0	DOOR PLATES MAGNET XL40	1	PZ																						
0H7217A0	BAKERTOP PROOFER RIGHT DRIP TRAY	1	PZ																						
0H7325A0	600X400 8TRAY PROOFER DOOR BAND	1	PZ																						
CR1080A0	XV-XL-XB ST. STEEL RIGHT HINGE	1	PZ																						



COMPONENT			SPARE PART																																																																																							
Code	Description	Image	Code	Description	Components list																																																																																					
VT1308A	LOW PROVER DOOR GLASS		KVT1308AR	8 TRAYS PROVER RIGHT DOOR GLASS KIT	<table border="1"> <thead> <tr> <th>Code</th> <th>Description</th> <th>Qty</th> <th>UOM</th> </tr> </thead> <tbody> <tr> <td>CR1081A0</td> <td>XV-XL-XB ST. STEEL LEFT HINGE</td> <td>1</td> <td>PZ</td> </tr> <tr> <td>GN1330A0</td> <td>FERRITIC PLATE GASKET XL40</td> <td>1</td> <td>PZ</td> </tr> <tr> <td>GN1554A0</td> <td>PROOFER HANDLE GASKET</td> <td>1</td> <td>PZ</td> </tr> <tr> <td>GN1577A1</td> <td>PROOFER HINGE GASKE</td> <td>2</td> <td>PZ</td> </tr> <tr> <td>IP1508A1</td> <td>POLYSTYREN E U SHAPED PROFILE 2000X60X60</td> <td>1.500</td> <td>M</td> </tr> <tr> <td>MG1082A0</td> <td>HANDLE END PROFILE 20X2</td> <td>2</td> <td>PZ</td> </tr> <tr> <td>TB2969A0</td> <td>8TRAY PROOFER HANDLE PROFILE 20X2</td> <td>1</td> <td>PZ</td> </tr> <tr> <td>VI1685A0</td> <td>M6X6 STAINLESS STEEL SCREW</td> <td>4</td> <td>PZ</td> </tr> <tr> <td>VI1930A0</td> <td>5X25 ST. STEEL SCREW CHIP</td> <td>2</td> <td>PZ</td> </tr> <tr> <td>VM1059A1</td> <td>HEAT SHRINK FILM H800</td> <td>1</td> <td>M</td> </tr> <tr> <td>VM1720A0</td> <td>XL405 DOOR WASKER</td> <td>1</td> <td>PZ</td> </tr> <tr> <td>VM2000A0</td> <td>M4 SOCKET HEAD SCREW COVER</td> <td>4</td> <td>PZ</td> </tr> <tr> <td>VT1308A0</td> <td>LOW PROVER DOOR GLASS</td> <td></td> <td></td> <td></td> </tr> <tr> <td>VT1308A0</td> <td>LOW PROVER DOOR GLASS</td> <td></td> <td></td> <td></td> </tr> </tbody> </table>	Code	Description	Qty	UOM	CR1081A0	XV-XL-XB ST. STEEL LEFT HINGE	1	PZ	GN1330A0	FERRITIC PLATE GASKET XL40	1	PZ	GN1554A0	PROOFER HANDLE GASKET	1	PZ	GN1577A1	PROOFER HINGE GASKE	2	PZ	IP1508A1	POLYSTYREN E U SHAPED PROFILE 2000X60X60	1.500	M	MG1082A0	HANDLE END PROFILE 20X2	2	PZ	TB2969A0	8TRAY PROOFER HANDLE PROFILE 20X2	1	PZ	VI1685A0	M6X6 STAINLESS STEEL SCREW	4	PZ	VI1930A0	5X25 ST. STEEL SCREW CHIP	2	PZ	VM1059A1	HEAT SHRINK FILM H800	1	M	VM1720A0	XL405 DOOR WASKER	1	PZ	VM2000A0	M4 SOCKET HEAD SCREW COVER	4	PZ	VT1308A0	LOW PROVER DOOR GLASS				VT1308A0	LOW PROVER DOOR GLASS				KVT1308AL	8 TRAYS PROVER LEFT DOOR GLASS KIT	<table border="1"> <thead> <tr> <th>Code</th> <th>Description</th> <th>Qty</th> <th>UOM</th> </tr> </thead> <tbody> <tr> <td>0H4540A0</td> <td>DOOR PLATES MAGNET XL40</td> <td>1</td> <td>PZ</td> </tr> <tr> <td>0H7216A0</td> <td>BAKERTOP PROOFER LEFT DRIP TRAY</td> <td>1</td> <td>PZ</td> </tr> <tr> <td>0H7325A0</td> <td>600X400 8TRAY PROOFER DOOR BAND</td> <td>1</td> <td>PZ</td> </tr> <tr> <td>CR1080A0</td> <td>XV-XL-XB ST. STEEL RIGHT HINGE</td> <td>1</td> <td>PZ</td> </tr> </tbody> </table>	Code	Description	Qty	UOM	0H4540A0	DOOR PLATES MAGNET XL40	1	PZ	0H7216A0	BAKERTOP PROOFER LEFT DRIP TRAY	1	PZ	0H7325A0	600X400 8TRAY PROOFER DOOR BAND	1	PZ	CR1080A0	XV-XL-XB ST. STEEL RIGHT HINGE	1	PZ
			Code	Description	Qty	UOM																																																																																				
CR1081A0	XV-XL-XB ST. STEEL LEFT HINGE	1	PZ																																																																																							
GN1330A0	FERRITIC PLATE GASKET XL40	1	PZ																																																																																							
GN1554A0	PROOFER HANDLE GASKET	1	PZ																																																																																							
GN1577A1	PROOFER HINGE GASKE	2	PZ																																																																																							
IP1508A1	POLYSTYREN E U SHAPED PROFILE 2000X60X60	1.500	M																																																																																							
MG1082A0	HANDLE END PROFILE 20X2	2	PZ																																																																																							
TB2969A0	8TRAY PROOFER HANDLE PROFILE 20X2	1	PZ																																																																																							
VI1685A0	M6X6 STAINLESS STEEL SCREW	4	PZ																																																																																							
VI1930A0	5X25 ST. STEEL SCREW CHIP	2	PZ																																																																																							
VM1059A1	HEAT SHRINK FILM H800	1	M																																																																																							
VM1720A0	XL405 DOOR WASKER	1	PZ																																																																																							
VM2000A0	M4 SOCKET HEAD SCREW COVER	4	PZ																																																																																							
VT1308A0	LOW PROVER DOOR GLASS																																																																																									
VT1308A0	LOW PROVER DOOR GLASS																																																																																									
Code	Description	Qty	UOM																																																																																							
0H4540A0	DOOR PLATES MAGNET XL40	1	PZ																																																																																							
0H7216A0	BAKERTOP PROOFER LEFT DRIP TRAY	1	PZ																																																																																							
0H7325A0	600X400 8TRAY PROOFER DOOR BAND	1	PZ																																																																																							
CR1080A0	XV-XL-XB ST. STEEL RIGHT HINGE	1	PZ																																																																																							



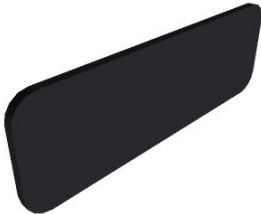

COMPONENT			SPARE PART																																																														
Code	Description	Image	Code	Description	Components list																																																												
VT1308A	LOW PROVER DOOR GLASS		KVT1308AL	8 TRAYS PROVER LEFT DOOR GLASS KIT	<table border="1"> <thead> <tr> <th>Code</th> <th>Description</th> <th>Qty</th> <th>UOM</th> </tr> </thead> <tbody> <tr> <td>CR1081A0</td> <td>XV-XL-XB ST. STEEL LEFT HINGE</td> <td>1</td> <td>PZ</td> </tr> <tr> <td>GN1330A0</td> <td>FERRITIC PLATE GASKET XL40</td> <td>1</td> <td>PZ</td> </tr> <tr> <td>GN1554A0</td> <td>PROOFER HANDLE GASKET</td> <td>1</td> <td>PZ</td> </tr> <tr> <td>GN1577A1</td> <td>PROOFER HINGE GASKE</td> <td>2</td> <td>PZ</td> </tr> <tr> <td>IP1508A1</td> <td>POLYSTYREN E U SHAPED PROFILE 2000X60X60</td> <td>1.500</td> <td>M</td> </tr> <tr> <td>MG1082A0</td> <td>HANDLE END PROFILE 20X2</td> <td>2</td> <td>PZ</td> </tr> <tr> <td>TB2969A0</td> <td>8TRAY PROOFER HANDLE PROFILE 20X2</td> <td>1</td> <td>PZ</td> </tr> <tr> <td>VI1685A0</td> <td>M6X6 STAINLESS STEEL SCREW</td> <td>4</td> <td>PZ</td> </tr> <tr> <td>VI1930A0</td> <td>5X25 ST. STEEL SCREW CHIP</td> <td>2</td> <td>PZ</td> </tr> <tr> <td>VM1059A1</td> <td>HEAT SHRINK FILM H800</td> <td>1</td> <td>M</td> </tr> <tr> <td>VM1720A0</td> <td>XL405 DOOR WASKER</td> <td>1</td> <td>PZ</td> </tr> <tr> <td>VM2000A0</td> <td>M4 SOCKET HEAD SCREW COVER</td> <td>4</td> <td>PZ</td> </tr> <tr> <td>VT1308A0</td> <td>LOW PROVER DOOR GLASS</td> <td>1</td> <td>PZ</td> </tr> <tr> <td>VT1308A0</td> <td>LOW PROVER DOOR GLASS</td> <td>1</td> <td>PZ</td> </tr> </tbody> </table>	Code	Description	Qty	UOM	CR1081A0	XV-XL-XB ST. STEEL LEFT HINGE	1	PZ	GN1330A0	FERRITIC PLATE GASKET XL40	1	PZ	GN1554A0	PROOFER HANDLE GASKET	1	PZ	GN1577A1	PROOFER HINGE GASKE	2	PZ	IP1508A1	POLYSTYREN E U SHAPED PROFILE 2000X60X60	1.500	M	MG1082A0	HANDLE END PROFILE 20X2	2	PZ	TB2969A0	8TRAY PROOFER HANDLE PROFILE 20X2	1	PZ	VI1685A0	M6X6 STAINLESS STEEL SCREW	4	PZ	VI1930A0	5X25 ST. STEEL SCREW CHIP	2	PZ	VM1059A1	HEAT SHRINK FILM H800	1	M	VM1720A0	XL405 DOOR WASKER	1	PZ	VM2000A0	M4 SOCKET HEAD SCREW COVER	4	PZ	VT1308A0	LOW PROVER DOOR GLASS	1	PZ	VT1308A0	LOW PROVER DOOR GLASS	1	PZ
					Code	Description	Qty	UOM																																																									
					CR1081A0	XV-XL-XB ST. STEEL LEFT HINGE	1	PZ																																																									
					GN1330A0	FERRITIC PLATE GASKET XL40	1	PZ																																																									
					GN1554A0	PROOFER HANDLE GASKET	1	PZ																																																									
					GN1577A1	PROOFER HINGE GASKE	2	PZ																																																									
					IP1508A1	POLYSTYREN E U SHAPED PROFILE 2000X60X60	1.500	M																																																									
					MG1082A0	HANDLE END PROFILE 20X2	2	PZ																																																									
					TB2969A0	8TRAY PROOFER HANDLE PROFILE 20X2	1	PZ																																																									
					VI1685A0	M6X6 STAINLESS STEEL SCREW	4	PZ																																																									
					VI1930A0	5X25 ST. STEEL SCREW CHIP	2	PZ																																																									
					VM1059A1	HEAT SHRINK FILM H800	1	M																																																									
					VM1720A0	XL405 DOOR WASKER	1	PZ																																																									
					VM2000A0	M4 SOCKET HEAD SCREW COVER	4	PZ																																																									
VT1308A0	LOW PROVER DOOR GLASS	1	PZ																																																														
VT1308A0	LOW PROVER DOOR GLASS	1	PZ																																																														
GN1577A	PROOFER HINGE GASKET		GN1577A1	PROOFER HINGE GASKET																																																													



**ASM3046B/0.D00 - General overview**

**FRONT**

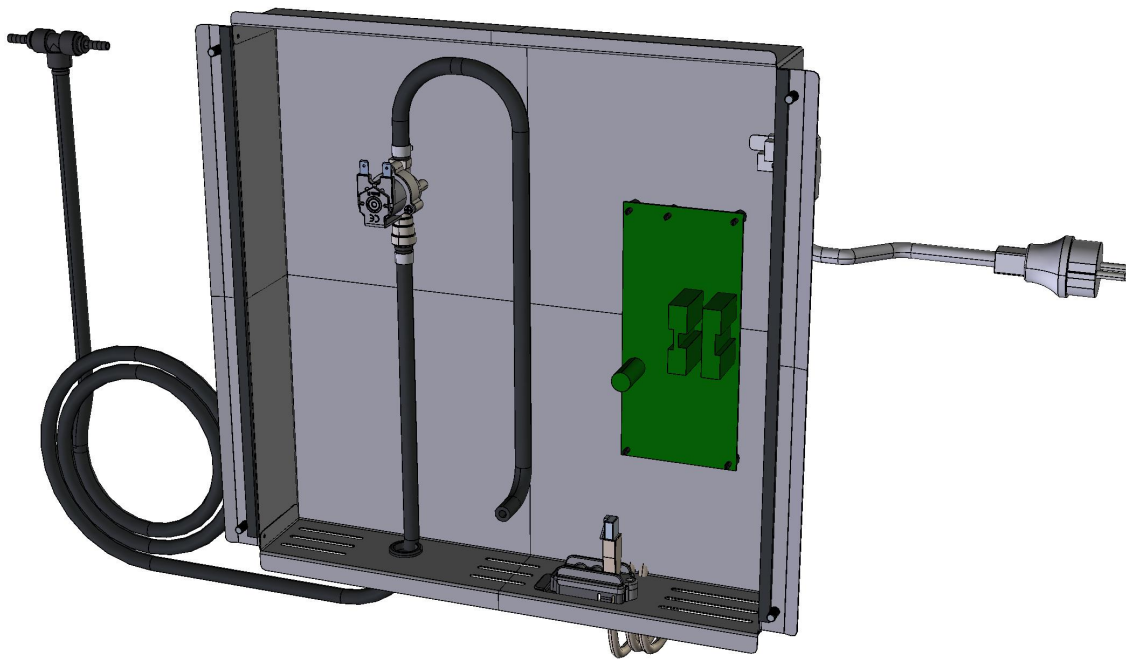



**ASM3046B/0.D00 - General overview**



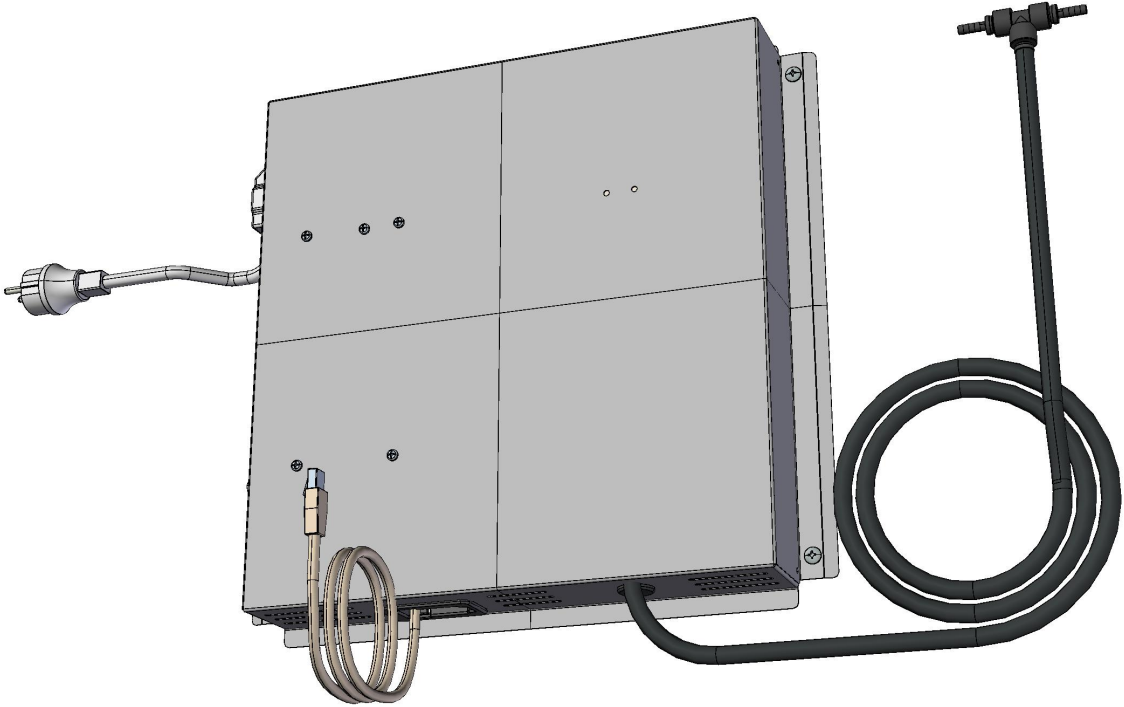

**REAR**



COMPONENT			SPARE PART																		
Code	Description	Image	Code	Description	Components list																
VM1745A	CARD SUPPORT		KVM1745A	BOARD SUPPORT 10 PCS KIT	<table border="1"> <thead> <tr> <th>Code</th> <th>Description</th> <th>Qty</th> <th>UOM</th> </tr> </thead> <tbody> <tr> <td>VM1224A0</td> <td></td> <td>0.200</td> <td>M</td> </tr> <tr> <td>VM1745A0</td> <td>CARD SUPPORT</td> <td>10</td> <td>PZ</td> </tr> </tbody> </table>	Code	Description	Qty	UOM	VM1224A0		0.200	M	VM1745A0	CARD SUPPORT	10	PZ				
Code	Description	Qty	UOM																		
VM1224A0		0.200	M																		
VM1745A0	CARD SUPPORT	10	PZ																		
VM1750A	BRASS COMB CLAM		KVM1750A	COMB TERMINAL BLOCK KIT	<table border="1"> <thead> <tr> <th>Code</th> <th>Description</th> <th>Qty</th> <th>UOM</th> </tr> </thead> <tbody> <tr> <td>VM1224A0</td> <td></td> <td>0.150</td> <td>M</td> </tr> <tr> <td>VM1750A0</td> <td>BRASS COMB CLAMP</td> <td>1</td> <td>PZ</td> </tr> </tbody> </table>	Code	Description	Qty	UOM	VM1224A0		0.150	M	VM1750A0	BRASS COMB CLAMP	1	PZ				
Code	Description	Qty	UOM																		
VM1224A0		0.150	M																		
VM1750A0	BRASS COMB CLAMP	1	PZ																		
CE1305A	L=2MT RJ45 - RJ45 CABLE		KCE1305A	RJ45 - RJ45 L=2MT CABLE KIT	<table border="1"> <thead> <tr> <th>Code</th> <th>Description</th> <th>Qty</th> <th>UOM</th> </tr> </thead> <tbody> <tr> <td>CE1305A0</td> <td>L=2MT RJ45 - RJ45 CABLE</td> <td>1</td> <td>PZ</td> </tr> <tr> <td>VM1224A0</td> <td></td> <td>0.250</td> <td>M</td> </tr> </tbody> </table>	Code	Description	Qty	UOM	CE1305A0	L=2MT RJ45 - RJ45 CABLE	1	PZ	VM1224A0		0.250	M				
Code	Description	Qty	UOM																		
CE1305A0	L=2MT RJ45 - RJ45 CABLE	1	PZ																		
VM1224A0		0.250	M																		
MR1000A	CABLE 3X1,5 H07RN-F MT1,5+K2/3+SCHUK		KMR1000A	KIT CABLE 3X1,5 H07RN-F +K2/3+SCHUKO	<table border="1"> <thead> <tr> <th>Code</th> <th>Description</th> <th>Qty</th> <th>UOM</th> </tr> </thead> <tbody> <tr> <td>MR1000A0</td> <td>CABLE 3X1,5 H07RN-F MT1,5+K2/3+SCHUKO</td> <td>1</td> <td>PZ</td> </tr> <tr> <td>VM1224A0</td> <td></td> <td>0.350</td> <td>M</td> </tr> </tbody> </table>	Code	Description	Qty	UOM	MR1000A0	CABLE 3X1,5 H07RN-F MT1,5+K2/3+SCHUKO	1	PZ	VM1224A0		0.350	M				
Code	Description	Qty	UOM																		
MR1000A0	CABLE 3X1,5 H07RN-F MT1,5+K2/3+SCHUKO	1	PZ																		
VM1224A0		0.350	M																		
VL1047A	D6 PIPE HOLDER - D8 J.G. TERMINAL		KVL1047A	Ø6 PIPE HOLDER+Ø8 JG TERMINAL 10 PCS KIT	<table border="1"> <thead> <tr> <th>Code</th> <th>Description</th> <th>Qty</th> <th>UOM</th> </tr> </thead> <tbody> <tr> <td>VL1047A1</td> <td>D6 PIPE HOLDER - D8 J.G. TERMINAL</td> <td>10</td> <td>PZ</td> </tr> <tr> <td>VM1224A0</td> <td></td> <td>0.200</td> <td>M</td> </tr> </tbody> </table>	Code	Description	Qty	UOM	VL1047A1	D6 PIPE HOLDER - D8 J.G. TERMINAL	10	PZ	VM1224A0		0.200	M				
Code	Description	Qty	UOM																		
VL1047A1	D6 PIPE HOLDER - D8 J.G. TERMINAL	10	PZ																		
VM1224A0		0.200	M																		
			KVL0016A	BRITA ADAPTOR KIT FOR MM CLEANING SYSTEM	<table border="1"> <thead> <tr> <th>Code</th> <th>Description</th> <th>Qty</th> <th>UOM</th> </tr> </thead> <tbody> <tr> <td>EL1185A0</td> <td>Ø8F - Ø8F ELBOW CONNECTION</td> <td>260</td> <td>PZ</td> </tr> <tr> <td>RC1018A0</td> <td>ZINC PLATED D12 ELASTIC CLAMP</td> <td>520</td> <td>PZ</td> </tr> <tr> <td>VL1047A1</td> <td>D6 PIPE HOLDER - D8 J.G. TERMINAL</td> <td>520</td> <td>PZ</td> </tr> </tbody> </table>	Code	Description	Qty	UOM	EL1185A0	Ø8F - Ø8F ELBOW CONNECTION	260	PZ	RC1018A0	ZINC PLATED D12 ELASTIC CLAMP	520	PZ	VL1047A1	D6 PIPE HOLDER - D8 J.G. TERMINAL	520	PZ
Code	Description	Qty	UOM																		
EL1185A0	Ø8F - Ø8F ELBOW CONNECTION	260	PZ																		
RC1018A0	ZINC PLATED D12 ELASTIC CLAMP	520	PZ																		
VL1047A1	D6 PIPE HOLDER - D8 J.G. TERMINAL	520	PZ																		

COMPONENT			SPARE PART																										
Code	Description	Image	Code	Description	Components list																								
EL1424A	D8 CONNECTION WATER SOLENOID VALVE		KEL1424B	EG1 JG D8-D6 SOLENOID VALVE KI	<table border="1"> <thead> <tr> <th>Code</th> <th>Description</th> <th>Qty</th> <th>UOM</th> </tr> </thead> <tbody> <tr> <td>EL1424B0</td> <td></td> <td>1</td> <td>PZ</td> </tr> <tr> <td>V11095A0</td> <td>3,9X9,5 SELF-THREADING SCREW</td> <td>2</td> <td>PZ</td> </tr> <tr> <td>V11095B0</td> <td></td> <td>2</td> <td>PZ</td> </tr> <tr> <td>VM1224A0</td> <td></td> <td>0.250</td> <td>M</td> </tr> </tbody> </table>	Code	Description	Qty	UOM	EL1424B0		1	PZ	V11095A0	3,9X9,5 SELF-THREADING SCREW	2	PZ	V11095B0		2	PZ	VM1224A0		0.250	M				
Code	Description	Qty	UOM																										
EL1424B0		1	PZ																										
V11095A0	3,9X9,5 SELF-THREADING SCREW	2	PZ																										
V11095B0		2	PZ																										
VM1224A0		0.250	M																										
EL1020A	D8 INTERMEDIATE T-SHAPED FITTING		KEL1020A	Ø8 T-SHAPED FITTING 10 PCS KIT	<table border="1"> <thead> <tr> <th>Code</th> <th>Description</th> <th>Qty</th> <th>UOM</th> </tr> </thead> <tbody> <tr> <td>EL1020A1</td> <td>D8 INTERMEDIATE T-SHAPED FITTING</td> <td>10</td> <td>PZ</td> </tr> <tr> <td>VM1224A0</td> <td></td> <td>0.200</td> <td>M</td> </tr> </tbody> </table>	Code	Description	Qty	UOM	EL1020A1	D8 INTERMEDIATE T-SHAPED FITTING	10	PZ	VM1224A0		0.200	M												
Code	Description	Qty	UOM																										
EL1020A1	D8 INTERMEDIATE T-SHAPED FITTING	10	PZ																										
VM1224A0		0.200	M																										
VM1505A	WALL PASSING WITH DIAPHRAGM		KVM1505A	THROUGH-WALL CONNECTION+DIAPHRAGM KIT	<table border="1"> <thead> <tr> <th>Code</th> <th>Description</th> <th>Qty</th> <th>UOM</th> </tr> </thead> <tbody> <tr> <td>V11220A1</td> <td>4,2X12 TCB SELF-TAPPING SCREW</td> <td>1</td> <td>PZ</td> </tr> <tr> <td>VM1224A0</td> <td></td> <td>0.200</td> <td>M</td> </tr> <tr> <td>VM1505A0</td> <td>WALL PASSING WITH DIAPHRAGM</td> <td>3</td> <td>PZ</td> </tr> <tr> <td>VM2055A0</td> <td>UPPER WALL PASSING ACCESSORY CABLES</td> <td>1</td> <td>PZ</td> </tr> <tr> <td>VM2056A0</td> <td>LOWER WALL PASSING ACCESSORY CABLES</td> <td>1</td> <td>PZ</td> </tr> </tbody> </table>	Code	Description	Qty	UOM	V11220A1	4,2X12 TCB SELF-TAPPING SCREW	1	PZ	VM1224A0		0.200	M	VM1505A0	WALL PASSING WITH DIAPHRAGM	3	PZ	VM2055A0	UPPER WALL PASSING ACCESSORY CABLES	1	PZ	VM2056A0	LOWER WALL PASSING ACCESSORY CABLES	1	PZ
Code	Description	Qty	UOM																										
V11220A1	4,2X12 TCB SELF-TAPPING SCREW	1	PZ																										
VM1224A0		0.200	M																										
VM1505A0	WALL PASSING WITH DIAPHRAGM	3	PZ																										
VM2055A0	UPPER WALL PASSING ACCESSORY CABLES	1	PZ																										
VM2056A0	LOWER WALL PASSING ACCESSORY CABLES	1	PZ																										
PE1969A	BAKERTOP PROVER POWER CARD		KPE2130A	PROOFER POWER BOARD KIT	<table border="1"> <thead> <tr> <th>Code</th> <th>Description</th> <th>Qty</th> <th>UOM</th> </tr> </thead> <tbody> <tr> <td>CE1093A0</td> <td></td> <td>2</td> <td>PZ</td> </tr> <tr> <td>PE2130A0</td> <td>PROOFER POWER BOARD KIT</td> <td>1</td> <td>PZ</td> </tr> <tr> <td>V11850A0</td> <td>M4X6 NICKEL PLATED FIXING SCREW</td> <td>4</td> <td>PZ</td> </tr> <tr> <td>VM1745A0</td> <td>CARD SUPPORT</td> <td>4</td> <td>PZ</td> </tr> <tr> <td>VM2147A0</td> <td>410X343X15 MM PINK SMOOTH ESD SPONGE</td> <td>1</td> <td>PZ</td> </tr> </tbody> </table>	Code	Description	Qty	UOM	CE1093A0		2	PZ	PE2130A0	PROOFER POWER BOARD KIT	1	PZ	V11850A0	M4X6 NICKEL PLATED FIXING SCREW	4	PZ	VM1745A0	CARD SUPPORT	4	PZ	VM2147A0	410X343X15 MM PINK SMOOTH ESD SPONGE	1	PZ
Code	Description	Qty	UOM																										
CE1093A0		2	PZ																										
PE2130A0	PROOFER POWER BOARD KIT	1	PZ																										
V11850A0	M4X6 NICKEL PLATED FIXING SCREW	4	PZ																										
VM1745A0	CARD SUPPORT	4	PZ																										
VM2147A0	410X343X15 MM PINK SMOOTH ESD SPONGE	1	PZ																										



COMPONENT			SPARE PART																										
Code	Description	Image	Code	Description	Components list																								
EL1426A	D8 CONNECTION WATER SOLENOID VALVE		KEL1424B	EG1 JG D8-D6 SOLENOID VALVE KI	<table border="1"> <thead> <tr> <th>Code</th> <th>Description</th> <th>Qty</th> <th>UOM</th> </tr> </thead> <tbody> <tr> <td>EL1424B0</td> <td></td> <td>1</td> <td>PZ</td> </tr> <tr> <td>V11095A0</td> <td>3,9X9,5 SELF-THREADING SCREW</td> <td>2</td> <td>PZ</td> </tr> <tr> <td>V11095B0</td> <td></td> <td>2</td> <td>PZ</td> </tr> <tr> <td>VM1224A0</td> <td></td> <td>0.250</td> <td>M</td> </tr> </tbody> </table>	Code	Description	Qty	UOM	EL1424B0		1	PZ	V11095A0	3,9X9,5 SELF-THREADING SCREW	2	PZ	V11095B0		2	PZ	VM1224A0		0.250	M				
Code	Description	Qty	UOM																										
EL1424B0		1	PZ																										
V11095A0	3,9X9,5 SELF-THREADING SCREW	2	PZ																										
V11095B0		2	PZ																										
VM1224A0		0.250	M																										
VM2061A	ACCESSORIES CABLES WALL PASSING		KVM1505A	THROUGH-WALL CONNECTION+DIAPHRAGM KIT	<table border="1"> <thead> <tr> <th>Code</th> <th>Description</th> <th>Qty</th> <th>UOM</th> </tr> </thead> <tbody> <tr> <td>V11220A1</td> <td>4,2X12 TCB SELF-TAPPING SCREW</td> <td>1</td> <td>PZ</td> </tr> <tr> <td>VM1224A0</td> <td></td> <td>0.200</td> <td>M</td> </tr> <tr> <td>VM1505A0</td> <td>WALL PASSING WITH DIAPHRAGM</td> <td>3</td> <td>PZ</td> </tr> <tr> <td>VM2055A0</td> <td>UPPER WALL PASSING ACCESSORY CABLES</td> <td>1</td> <td>PZ</td> </tr> <tr> <td>VM2056A0</td> <td>LOWER WALL PASSING ACCESSORY CABLES</td> <td>1</td> <td>PZ</td> </tr> </tbody> </table>	Code	Description	Qty	UOM	V11220A1	4,2X12 TCB SELF-TAPPING SCREW	1	PZ	VM1224A0		0.200	M	VM1505A0	WALL PASSING WITH DIAPHRAGM	3	PZ	VM2055A0	UPPER WALL PASSING ACCESSORY CABLES	1	PZ	VM2056A0	LOWER WALL PASSING ACCESSORY CABLES	1	PZ
Code	Description	Qty	UOM																										
V11220A1	4,2X12 TCB SELF-TAPPING SCREW	1	PZ																										
VM1224A0		0.200	M																										
VM1505A0	WALL PASSING WITH DIAPHRAGM	3	PZ																										
VM2055A0	UPPER WALL PASSING ACCESSORY CABLES	1	PZ																										
VM2056A0	LOWER WALL PASSING ACCESSORY CABLES	1	PZ																										
0H7326B	EUROPEAN ELECT 8TRAY PROOFER COMP HOLDER		0H7326B0	EUROPEAN ELECT 8TRAY PROOFER COMP HOLDER																									
GN0032A			GN0032A0																										



COMPONENT			SPARE PART														
Code	Description	Image	Code	Description	Components list												
TB3250A	PROOFER CONNECTING WHITE-BLACK EPDM PIPE		KTB3131A	WHITE-BLACK 6X12 REINFORCED PIPE 3M KIT	<table border="1"> <thead> <tr> <th>Code</th> <th>Description</th> <th>Qty</th> <th>UOM</th> </tr> </thead> <tbody> <tr> <td>TB3131A0</td> <td>WHITE-BLACK EPDM TEXTILE BRAID HOSE 6X12</td> <td>3</td> <td>M</td> </tr> <tr> <td>VM1794A0</td> <td>250X4.8 PA66 BLACK CLAMP</td> <td>1</td> <td>PZ</td> </tr> </tbody> </table>	Code	Description	Qty	UOM	TB3131A0	WHITE-BLACK EPDM TEXTILE BRAID HOSE 6X12	3	M	VM1794A0	250X4.8 PA66 BLACK CLAMP	1	PZ
					Code	Description	Qty	UOM									
TB3131A0	WHITE-BLACK EPDM TEXTILE BRAID HOSE 6X12	3	M														
VM1794A0	250X4.8 PA66 BLACK CLAMP	1	PZ														