







Assembly code	Assembly description	Assembly image
ASM2911B/0.D05	Cooking chamber	
ASM2916C/0.D01	External cover	
ASM2921B/0.D04	Door	
ASM2926A/0.D03	Electrical system	



ASM2911B/0.D05 - Cooking chamber

FRONT

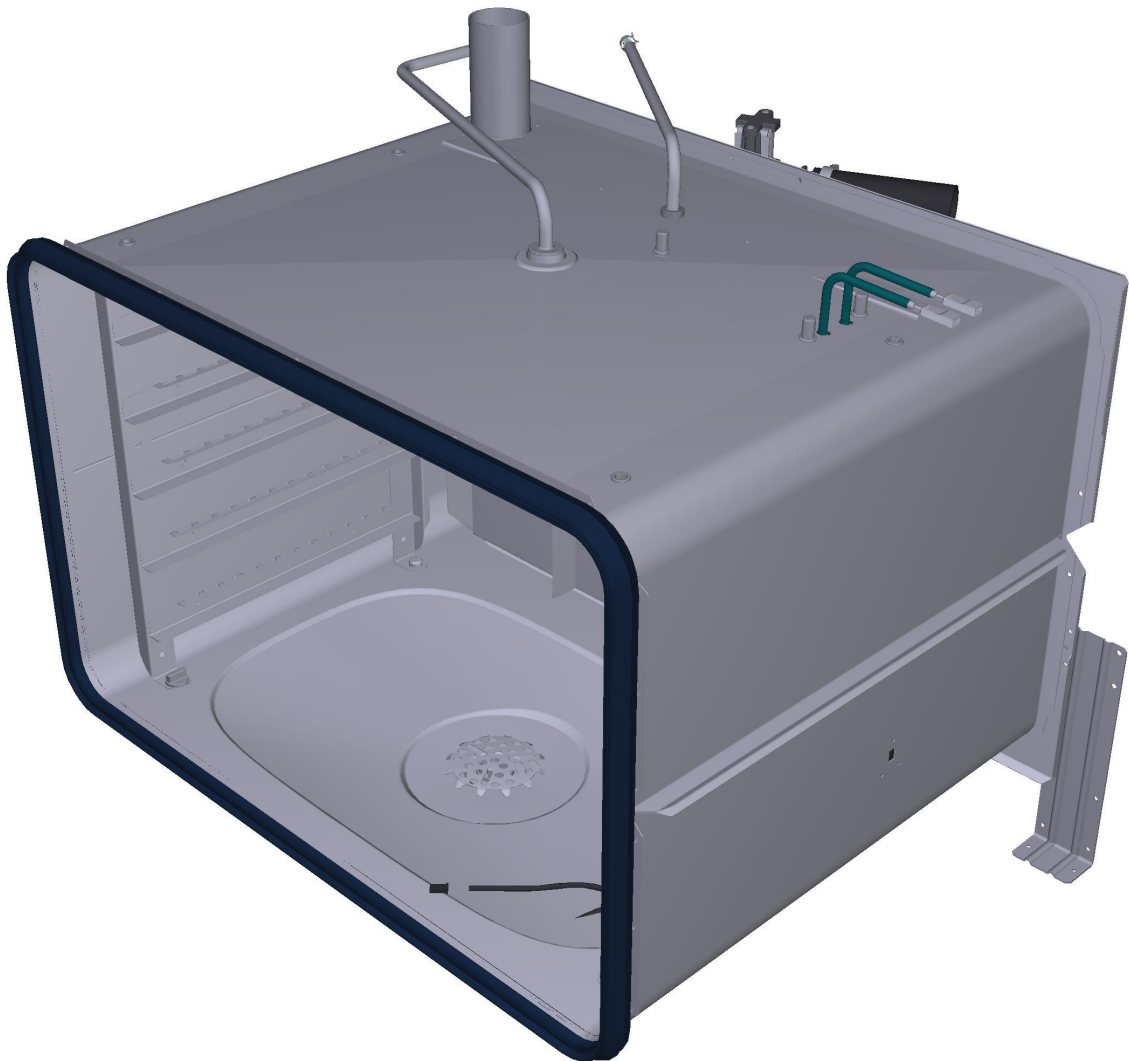





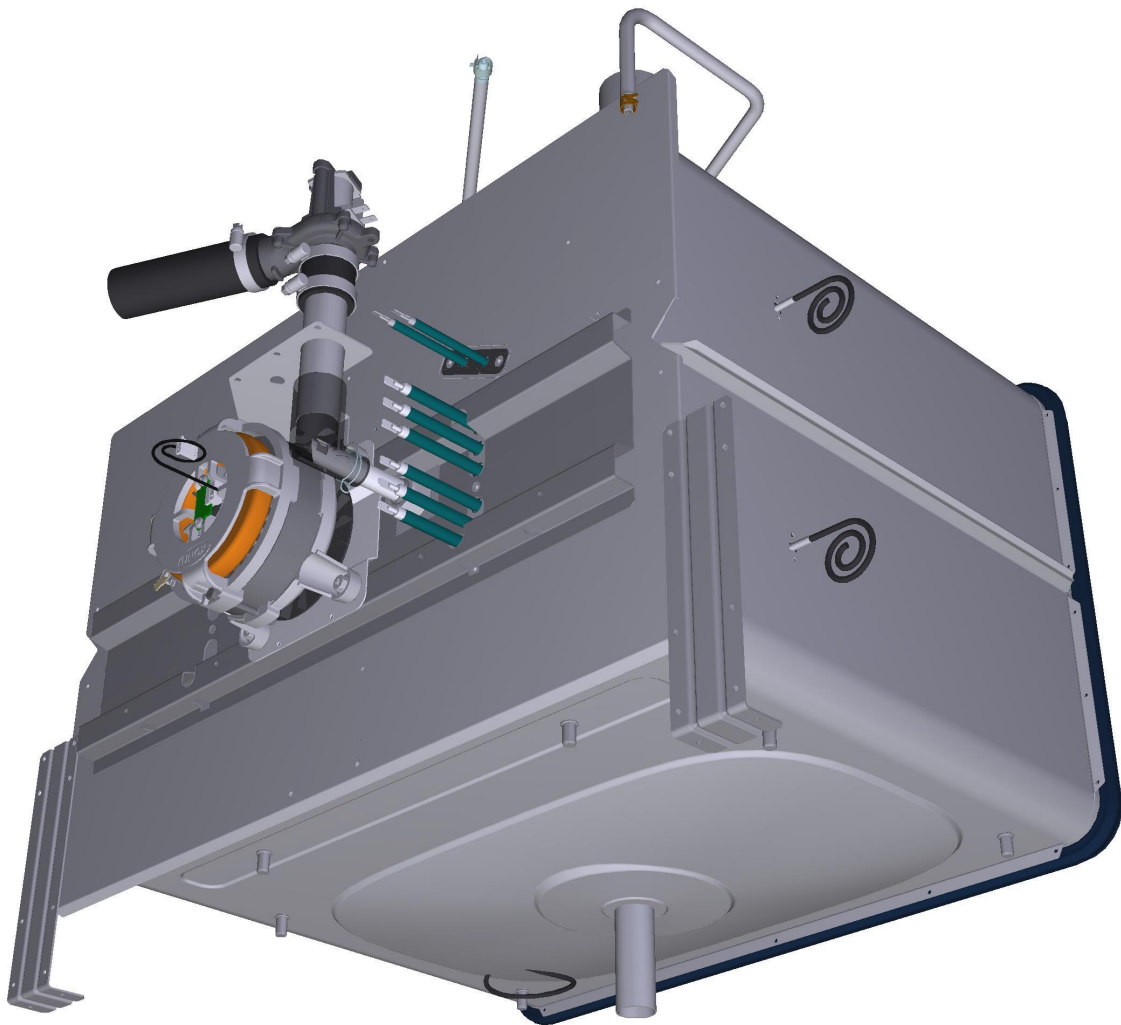

ASM2911B/0.D05 - Cooking chamber

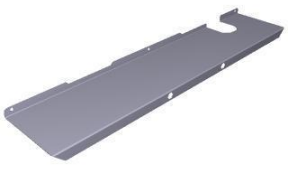
REAR



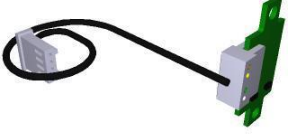

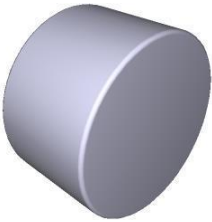

COMPONENT			SPARE PART																										
Code	Description	Image	Code	Description	Kit components																								
0G1558A	FAN GUARD SPACE		K0G1558A	SPACER FAN GUARD KIT	<table border="1"> <thead> <tr> <th>Code</th> <th>Description</th> <th>Qty</th> <th>UOM</th> </tr> </thead> <tbody> <tr> <td>0G1558A0</td> <td>FAN GUARD SPACER</td> <td>1.000</td> <td>PC</td> </tr> </tbody> </table>	Code	Description	Qty	UOM	0G1558A0	FAN GUARD SPACER	1.000	PC																
Code	Description	Qty	UOM																										
0G1558A0	FAN GUARD SPACER	1.000	PC																										
0H2551A	XBC/XVC ST.STEEL DRAIN COVER		K0H2551A	DRAIN COVER KIT	<table border="1"> <thead> <tr> <th>Code</th> <th>Description</th> <th>Qty</th> <th>UOM</th> </tr> </thead> <tbody> <tr> <td>0H2551A0</td> <td>XBC/XVC ST.STEEL DRAIN COVER</td> <td>1.000</td> <td>PC</td> </tr> </tbody> </table>	Code	Description	Qty	UOM	0H2551A0	XBC/XVC ST.STEEL DRAIN COVER	1.000	PC																
Code	Description	Qty	UOM																										
0H2551A0	XBC/XVC ST.STEEL DRAIN COVER	1.000	PC																										
0H2730A	ZINC PLATED MUFFLE SUPPORT BRACKET		0H2730A1	ZINC PLATED MUFFLE SUPPORT BRACKET																									
0H7320A	6 S. VENTURI PIPE SUPPORT		0H7320A0	6 S. VENTURI PIPE SUPPORT																									
PE1710B	MOTOR REVOLUTION AND DIRECTION SENSO		KPE1710B	MOTOR REVOLUTIONS SENSOR KIT	<table border="1"> <thead> <tr> <th>Code</th> <th>Description</th> <th>Qty</th> <th>UOM</th> </tr> </thead> <tbody> <tr> <td>CE1119A0</td> <td>AMP MODU2 4P 4XAWG22 L1500 RAST 4P CABLE</td> <td>1.000</td> <td>PC</td> </tr> <tr> <td>PE1040A0</td> <td>RAST MOTOR SENSOR</td> <td>1.000</td> <td>PC</td> </tr> <tr> <td>VE1550A0</td> <td>5X3 MM NEODYMIUM MAGNET</td> <td>1.000</td> <td>PC</td> </tr> <tr> <td>VI1966A0</td> <td>M4X14 FLATHEAD SCREW</td> <td>1.000</td> <td>PC</td> </tr> <tr> <td>VM1635A0</td> <td>MAGNET HOLDING DIS</td> <td>1.000</td> <td>PC</td> </tr> </tbody> </table>	Code	Description	Qty	UOM	CE1119A0	AMP MODU2 4P 4XAWG22 L1500 RAST 4P CABLE	1.000	PC	PE1040A0	RAST MOTOR SENSOR	1.000	PC	VE1550A0	5X3 MM NEODYMIUM MAGNET	1.000	PC	VI1966A0	M4X14 FLATHEAD SCREW	1.000	PC	VM1635A0	MAGNET HOLDING DIS	1.000	PC
Code	Description	Qty	UOM																										
CE1119A0	AMP MODU2 4P 4XAWG22 L1500 RAST 4P CABLE	1.000	PC																										
PE1040A0	RAST MOTOR SENSOR	1.000	PC																										
VE1550A0	5X3 MM NEODYMIUM MAGNET	1.000	PC																										
VI1966A0	M4X14 FLATHEAD SCREW	1.000	PC																										
VM1635A0	MAGNET HOLDING DIS	1.000	PC																										

COMPONENT			SPARE PART																																		
Code	Description	Image	Code	Description	Kit components																																
VE1550A	5X3 MM NEODYMIUM MAGNET		KPE1710B	MOTOR REVOLUTIONS SENSOR KIT	<table border="1"> <thead> <tr> <th>Code</th> <th>Description</th> <th>Qty</th> <th>UOM</th> </tr> </thead> <tbody> <tr> <td>CE1119A0</td> <td>AMPMODU2 4P 4XAWG22 L1500 RAST 4P CABLE</td> <td>1.000</td> <td>PC</td> </tr> <tr> <td>PE1040A0</td> <td>RAST MOTOR SENSOR</td> <td>1.000</td> <td>PC</td> </tr> <tr> <td>VE1550A0</td> <td>5X3 MM NEODYMIUM MAGNET</td> <td>1.000</td> <td>PC</td> </tr> <tr> <td>VI1966A0</td> <td>M4X14 FLATHEAD SCREW</td> <td>1.000</td> <td>PC</td> </tr> <tr> <td>VM1635A0</td> <td>MAGNET HOLDING DIS</td> <td>1.000</td> <td>PC</td> </tr> </tbody> </table>	Code	Description	Qty	UOM	CE1119A0	AMPMODU2 4P 4XAWG22 L1500 RAST 4P CABLE	1.000	PC	PE1040A0	RAST MOTOR SENSOR	1.000	PC	VE1550A0	5X3 MM NEODYMIUM MAGNET	1.000	PC	VI1966A0	M4X14 FLATHEAD SCREW	1.000	PC	VM1635A0	MAGNET HOLDING DIS	1.000	PC								
Code	Description	Qty	UOM																																		
CE1119A0	AMPMODU2 4P 4XAWG22 L1500 RAST 4P CABLE	1.000	PC																																		
PE1040A0	RAST MOTOR SENSOR	1.000	PC																																		
VE1550A0	5X3 MM NEODYMIUM MAGNET	1.000	PC																																		
VI1966A0	M4X14 FLATHEAD SCREW	1.000	PC																																		
VM1635A0	MAGNET HOLDING DIS	1.000	PC																																		
RS1180A	9 KW 230V 6 TURNS CIRC. HEATING ELEMENT		KRS1180A	9kW 6 TURNS CIRC. HEATING ELEMENT KIT	<table border="1"> <thead> <tr> <th>Code</th> <th>Description</th> <th>Qty</th> <th>UOM</th> </tr> </thead> <tbody> <tr> <td>GN1671A0</td> <td>141X22 G8.5 ELEMENT ARMED GASKET</td> <td>1.000</td> <td>PC</td> </tr> <tr> <td>RS1180A1</td> <td>9 KW 230V 6 TURNS CIRC. HEATING ELEMENT</td> <td>1.000</td> <td>PC</td> </tr> <tr> <td>SL1045A0</td> <td>S57 BLACK SILICONE - 80ml CARTRIDGE</td> <td>1.000</td> <td>PC</td> </tr> <tr> <td>VI1032A0</td> <td>M4x16 TCB+ ST.STEEL SCREW</td> <td>1.000</td> <td>PC</td> </tr> <tr> <td>VI1075A0</td> <td>NUT M4 H=4 UNI5587 INOX</td> <td>1.000</td> <td>PC</td> </tr> <tr> <td>VI1220A1</td> <td>4,2x12 TCB SELF-TAPPIN G SCREW</td> <td>6.000</td> <td>PC</td> </tr> <tr> <td>VI1511A0</td> <td>STAINLESS STEEL WASHER 4.2X12X1</td> <td>1.000</td> <td>PC</td> </tr> </tbody> </table>	Code	Description	Qty	UOM	GN1671A0	141X22 G8.5 ELEMENT ARMED GASKET	1.000	PC	RS1180A1	9 KW 230V 6 TURNS CIRC. HEATING ELEMENT	1.000	PC	SL1045A0	S57 BLACK SILICONE - 80ml CARTRIDGE	1.000	PC	VI1032A0	M4x16 TCB+ ST.STEEL SCREW	1.000	PC	VI1075A0	NUT M4 H=4 UNI5587 INOX	1.000	PC	VI1220A1	4,2x12 TCB SELF-TAPPIN G SCREW	6.000	PC	VI1511A0	STAINLESS STEEL WASHER 4.2X12X1	1.000	PC
Code	Description	Qty	UOM																																		
GN1671A0	141X22 G8.5 ELEMENT ARMED GASKET	1.000	PC																																		
RS1180A1	9 KW 230V 6 TURNS CIRC. HEATING ELEMENT	1.000	PC																																		
SL1045A0	S57 BLACK SILICONE - 80ml CARTRIDGE	1.000	PC																																		
VI1032A0	M4x16 TCB+ ST.STEEL SCREW	1.000	PC																																		
VI1075A0	NUT M4 H=4 UNI5587 INOX	1.000	PC																																		
VI1220A1	4,2x12 TCB SELF-TAPPIN G SCREW	6.000	PC																																		
VI1511A0	STAINLESS STEEL WASHER 4.2X12X1	1.000	PC																																		
GN1672A	BREAKING ELEMENT GASKET		KGN1672A	71x19 HEATING ELEMENT GASKET 5 PCS KIT	<table border="1"> <thead> <tr> <th>Code</th> <th>Description</th> <th>Qty</th> <th>UOM</th> </tr> </thead> <tbody> <tr> <td>GN1672A1</td> <td>BREAKING ELEMENT GASKET</td> <td>5.000</td> <td>PC</td> </tr> </tbody> </table>	Code	Description	Qty	UOM	GN1672A1	BREAKING ELEMENT GASKET	5.000	PC																								
Code	Description	Qty	UOM																																		
GN1672A1	BREAKING ELEMENT GASKET	5.000	PC																																		

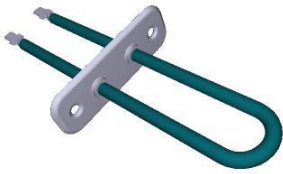



COMPONENT			SPARE PART																														
Code	Description	Image	Code	Description	Kit components																												
RS1215B	1 TURN 147W 105V FLAT ELEMENT		KRS1034A	MM 147W MOTOR BRAKING ELEMENT KIT	<table border="1"> <thead> <tr> <th>Code</th> <th>Description</th> <th>Qty</th> <th>UOM</th> </tr> </thead> <tbody> <tr> <td>GN1672A1</td> <td>BREAKING ELEMENT GASKET</td> <td>1.000</td> <td>PC</td> </tr> <tr> <td>RS1034A0</td> <td>1 TURN 147W 105V FLAT ELEMENT</td> <td>1.000</td> <td>PC</td> </tr> <tr> <td>SL1045A0</td> <td>S57 BLACK SILICONE - 80ml CARTRIDGE</td> <td>1.000</td> <td>PC</td> </tr> <tr> <td>VI1220A1</td> <td>4,2x12 TCB SELF-TAPPIN G SCREW</td> <td>2.000</td> <td>PC</td> </tr> </tbody> </table>	Code	Description	Qty	UOM	GN1672A1	BREAKING ELEMENT GASKET	1.000	PC	RS1034A0	1 TURN 147W 105V FLAT ELEMENT	1.000	PC	SL1045A0	S57 BLACK SILICONE - 80ml CARTRIDGE	1.000	PC	VI1220A1	4,2x12 TCB SELF-TAPPIN G SCREW	2.000	PC								
					Code	Description	Qty	UOM																									
					GN1672A1	BREAKING ELEMENT GASKET	1.000	PC																									
					RS1034A0	1 TURN 147W 105V FLAT ELEMENT	1.000	PC																									
SL1045A0	S57 BLACK SILICONE - 80ml CARTRIDGE	1.000	PC																														
VI1220A1	4,2x12 TCB SELF-TAPPIN G SCREW	2.000	PC																														
GN1285A	NTC TEMPERATURE PROBE SEALING		KTR1106B	MIND.Maps L2000 CHAMBER TEMP. PROBE KIT	<table border="1"> <thead> <tr> <th>Code</th> <th>Description</th> <th>Qty</th> <th>UOM</th> </tr> </thead> <tbody> <tr> <td>GN1285A0</td> <td>NTC TEMPERATUR E PROBE SEALING</td> <td>1.000</td> <td>PC</td> </tr> <tr> <td>SL1045A0</td> <td>S57 BLACK SILICONE - 80ml CARTRIDGE</td> <td>1.000</td> <td>PC</td> </tr> <tr> <td>TR1106B0</td> <td>PT100 L=2000 TEMPERATUR E PROBE</td> <td>1.000</td> <td>PC</td> </tr> <tr> <td>VI1220A1</td> <td>4,2x12 TCB SELF-TAPPIN G SCREW</td> <td>2.000</td> <td>PC</td> </tr> <tr> <td>VM1464A1</td> <td>CT BT TEMPERATUR E PROBE COVER</td> <td>1.000</td> <td>PC</td> </tr> <tr> <td>VM1465A1</td> <td>CT BT TEMPERATUR E PROBE COVER</td> <td>1.000</td> <td>PC</td> </tr> </tbody> </table>	Code	Description	Qty	UOM	GN1285A0	NTC TEMPERATUR E PROBE SEALING	1.000	PC	SL1045A0	S57 BLACK SILICONE - 80ml CARTRIDGE	1.000	PC	TR1106B0	PT100 L=2000 TEMPERATUR E PROBE	1.000	PC	VI1220A1	4,2x12 TCB SELF-TAPPIN G SCREW	2.000	PC	VM1464A1	CT BT TEMPERATUR E PROBE COVER	1.000	PC	VM1465A1	CT BT TEMPERATUR E PROBE COVER	1.000	PC
Code	Description	Qty	UOM																														
GN1285A0	NTC TEMPERATUR E PROBE SEALING	1.000	PC																														
SL1045A0	S57 BLACK SILICONE - 80ml CARTRIDGE	1.000	PC																														
TR1106B0	PT100 L=2000 TEMPERATUR E PROBE	1.000	PC																														
VI1220A1	4,2x12 TCB SELF-TAPPIN G SCREW	2.000	PC																														
VM1464A1	CT BT TEMPERATUR E PROBE COVER	1.000	PC																														
VM1465A1	CT BT TEMPERATUR E PROBE COVER	1.000	PC																														
			KTR1106A	5-5E S. L2000 CHAMBER TEMP. PROBE KIT	<table border="1"> <thead> <tr> <th>Code</th> <th>Description</th> <th>Qty</th> <th>UOM</th> </tr> </thead> <tbody> <tr> <td>GN1285A0</td> <td>NTC TEMPERATUR E PROBE SEALING</td> <td>1.000</td> <td>PC</td> </tr> <tr> <td>SL1045A0</td> <td>S57 BLACK SILICONE - 80ml CARTRIDGE</td> <td>1.000</td> <td>PC</td> </tr> <tr> <td>TR1106A3</td> <td>PT100 L=2000 TEMPERATUR E PROBE</td> <td>1.000</td> <td>PC</td> </tr> <tr> <td>VI1220A1</td> <td>4,2x12 TCB SELF-TAPPIN G SCREW</td> <td>2.000</td> <td>PC</td> </tr> <tr> <td>VM1465A1</td> <td>CT BT TEMPERATUR E PROBE COVER</td> <td>1.000</td> <td>PC</td> </tr> </tbody> </table>	Code	Description	Qty	UOM	GN1285A0	NTC TEMPERATUR E PROBE SEALING	1.000	PC	SL1045A0	S57 BLACK SILICONE - 80ml CARTRIDGE	1.000	PC	TR1106A3	PT100 L=2000 TEMPERATUR E PROBE	1.000	PC	VI1220A1	4,2x12 TCB SELF-TAPPIN G SCREW	2.000	PC	VM1465A1	CT BT TEMPERATUR E PROBE COVER	1.000	PC				
Code	Description	Qty	UOM																														
GN1285A0	NTC TEMPERATUR E PROBE SEALING	1.000	PC																														
SL1045A0	S57 BLACK SILICONE - 80ml CARTRIDGE	1.000	PC																														
TR1106A3	PT100 L=2000 TEMPERATUR E PROBE	1.000	PC																														
VI1220A1	4,2x12 TCB SELF-TAPPIN G SCREW	2.000	PC																														
VM1465A1	CT BT TEMPERATUR E PROBE COVER	1.000	PC																														









COMPONENT			SPARE PART																																						
Code	Description	Image	Code	Description	Kit components																																				
GN1285A	NTC TEMPERATURE PROBE SEALING		KTR1105A	PT100 L1000 TEMPERATURE PROBE KIT	<table border="1"> <thead> <tr> <th>Code</th> <th>Description</th> <th>Qty</th> <th>UOM</th> </tr> </thead> <tbody> <tr> <td>GN1120A1</td> <td>NTC TEMPERATUR E PROBE SEAL</td> <td>1.000</td> <td>PC</td> </tr> <tr> <td>GN1285A0</td> <td>NTC TEMPERATUR E PROBE SEALING</td> <td>1.000</td> <td>PC</td> </tr> <tr> <td>SL1045A0</td> <td>S57 BLACK SILICONE - 80ml CARTRIDGE</td> <td>1.000</td> <td>PC</td> </tr> <tr> <td>TR1105A4</td> <td>L1000 PT100 TEMPERATUR E PROBE</td> <td>1.000</td> <td>PC</td> </tr> <tr> <td>VI1220A1</td> <td>4,2x12 TCB SELF-TAPPIN G SCREW</td> <td>2.000</td> <td>PC</td> </tr> <tr> <td>VM1464A1</td> <td>CT BT TEMPERATUR E PROBE COVER</td> <td>1.000</td> <td>PC</td> </tr> <tr> <td>VM1465A1</td> <td>CT BT TEMPERATUR E PROBE COVER</td> <td>1.000</td> <td>PC</td> </tr> <tr> <td>VM2052A0</td> <td>LM CORE PROBE COVE</td> <td>1.000</td> <td>PC</td> </tr> </tbody> </table>	Code	Description	Qty	UOM	GN1120A1	NTC TEMPERATUR E PROBE SEAL	1.000	PC	GN1285A0	NTC TEMPERATUR E PROBE SEALING	1.000	PC	SL1045A0	S57 BLACK SILICONE - 80ml CARTRIDGE	1.000	PC	TR1105A4	L1000 PT100 TEMPERATUR E PROBE	1.000	PC	VI1220A1	4,2x12 TCB SELF-TAPPIN G SCREW	2.000	PC	VM1464A1	CT BT TEMPERATUR E PROBE COVER	1.000	PC	VM1465A1	CT BT TEMPERATUR E PROBE COVER	1.000	PC	VM2052A0	LM CORE PROBE COVE	1.000	PC
			Code	Description	Qty	UOM																																			
GN1120A1	NTC TEMPERATUR E PROBE SEAL	1.000	PC																																						
GN1285A0	NTC TEMPERATUR E PROBE SEALING	1.000	PC																																						
SL1045A0	S57 BLACK SILICONE - 80ml CARTRIDGE	1.000	PC																																						
TR1105A4	L1000 PT100 TEMPERATUR E PROBE	1.000	PC																																						
VI1220A1	4,2x12 TCB SELF-TAPPIN G SCREW	2.000	PC																																						
VM1464A1	CT BT TEMPERATUR E PROBE COVER	1.000	PC																																						
VM1465A1	CT BT TEMPERATUR E PROBE COVER	1.000	PC																																						
VM2052A0	LM CORE PROBE COVE	1.000	PC																																						
KTR1096A	NTC 150 L=1500 TEMPERATURE PROBE KIT	<table border="1"> <thead> <tr> <th>Code</th> <th>Description</th> <th>Qty</th> <th>UOM</th> </tr> </thead> <tbody> <tr> <td>GN1120A1</td> <td>NTC TEMPERATUR E PROBE SEAL</td> <td>1.000</td> <td>PC</td> </tr> <tr> <td>GN1285A0</td> <td>NTC TEMPERATUR E PROBE SEALING</td> <td>2.000</td> <td>PC</td> </tr> <tr> <td>SL1045A0</td> <td>S57 BLACK SILICONE - 80ml CARTRIDGE</td> <td>1.000</td> <td>PC</td> </tr> <tr> <td>TR1096A0</td> <td>TEMPERATUR E PROBE NTC 150 L=1500</td> <td>1.000</td> <td>PC</td> </tr> <tr> <td>VI1220A1</td> <td>4,2x12 TCB SELF-TAPPIN G SCREW</td> <td>2.000</td> <td>PC</td> </tr> <tr> <td>VM1465A1</td> <td>CT BT TEMPERATUR E PROBE COVER</td> <td>1.000</td> <td>PC</td> </tr> </tbody> </table>	Code	Description	Qty	UOM	GN1120A1	NTC TEMPERATUR E PROBE SEAL	1.000	PC	GN1285A0	NTC TEMPERATUR E PROBE SEALING	2.000	PC	SL1045A0	S57 BLACK SILICONE - 80ml CARTRIDGE	1.000	PC	TR1096A0	TEMPERATUR E PROBE NTC 150 L=1500	1.000	PC	VI1220A1	4,2x12 TCB SELF-TAPPIN G SCREW	2.000	PC	VM1465A1	CT BT TEMPERATUR E PROBE COVER	1.000	PC											
Code	Description	Qty	UOM																																						
GN1120A1	NTC TEMPERATUR E PROBE SEAL	1.000	PC																																						
GN1285A0	NTC TEMPERATUR E PROBE SEALING	2.000	PC																																						
SL1045A0	S57 BLACK SILICONE - 80ml CARTRIDGE	1.000	PC																																						
TR1096A0	TEMPERATUR E PROBE NTC 150 L=1500	1.000	PC																																						
VI1220A1	4,2x12 TCB SELF-TAPPIN G SCREW	2.000	PC																																						
VM1465A1	CT BT TEMPERATUR E PROBE COVER	1.000	PC																																						



COMPONENT			SPARE PART																														
Code	Description	Image	Code	Description	Kit components																												
GN1285A	NTC TEMPERATURE PROBE SEALING		KTR1095A	NTC 150 L=1050 TEMPERATURE PROBE KIT	<table border="1"> <thead> <tr> <th>Code</th> <th>Description</th> <th>Qty</th> <th>UOM</th> </tr> </thead> <tbody> <tr> <td>GN1120A1</td> <td>NTC TEMPERATUR E PROBE SEAL</td> <td>1.000</td> <td>PC</td> </tr> <tr> <td>GN1285A0</td> <td>NTC TEMPERATUR E PROBE SEALING</td> <td>1.000</td> <td>PC</td> </tr> <tr> <td>SL1045A0</td> <td>S57 BLACK SILICONE - 80ml CARTRIDGE</td> <td>1.000</td> <td>PC</td> </tr> <tr> <td>TR1095A0</td> <td>TEMPERATUR E PROBE NTC 150 L=1050</td> <td>1.000</td> <td>PC</td> </tr> <tr> <td>VI1220A1</td> <td>4,2x12 TCB SELF-TAPPIN G SCREW</td> <td>2.000</td> <td>PC</td> </tr> <tr> <td>VM1465A1</td> <td>CT BT TEMPERATUR E PROBE COVER</td> <td>1.000</td> <td>PC</td> </tr> </tbody> </table>	Code	Description	Qty	UOM	GN1120A1	NTC TEMPERATUR E PROBE SEAL	1.000	PC	GN1285A0	NTC TEMPERATUR E PROBE SEALING	1.000	PC	SL1045A0	S57 BLACK SILICONE - 80ml CARTRIDGE	1.000	PC	TR1095A0	TEMPERATUR E PROBE NTC 150 L=1050	1.000	PC	VI1220A1	4,2x12 TCB SELF-TAPPIN G SCREW	2.000	PC	VM1465A1	CT BT TEMPERATUR E PROBE COVER	1.000	PC
			Code	Description	Qty	UOM																											
GN1120A1	NTC TEMPERATUR E PROBE SEAL	1.000	PC																														
GN1285A0	NTC TEMPERATUR E PROBE SEALING	1.000	PC																														
SL1045A0	S57 BLACK SILICONE - 80ml CARTRIDGE	1.000	PC																														
TR1095A0	TEMPERATUR E PROBE NTC 150 L=1050	1.000	PC																														
VI1220A1	4,2x12 TCB SELF-TAPPIN G SCREW	2.000	PC																														
VM1465A1	CT BT TEMPERATUR E PROBE COVER	1.000	PC																														
KTR1002A	PT100 L1000 UL TEMPERATURE PROBE KIT	<table border="1"> <thead> <tr> <th>Code</th> <th>Description</th> <th>Qty</th> <th>UOM</th> </tr> </thead> <tbody> <tr> <td>GN1285A0</td> <td>NTC TEMPERATUR E PROBE SEALING</td> <td>2.000</td> <td>PC</td> </tr> <tr> <td>SL1045A0</td> <td>S57 BLACK SILICONE - 80ml CARTRIDGE</td> <td>1.000</td> <td>PC</td> </tr> <tr> <td>TR1002A1</td> <td></td> <td>1.000</td> <td>PC</td> </tr> <tr> <td>VI1220A1</td> <td>4,2x12 TCB SELF-TAPPIN G SCREW</td> <td>2.000</td> <td>PC</td> </tr> <tr> <td>VM1465A1</td> <td>CT BT TEMPERATUR E PROBE COVER</td> <td>1.000</td> <td>PC</td> </tr> </tbody> </table>	Code	Description	Qty	UOM	GN1285A0	NTC TEMPERATUR E PROBE SEALING	2.000	PC	SL1045A0	S57 BLACK SILICONE - 80ml CARTRIDGE	1.000	PC	TR1002A1		1.000	PC	VI1220A1	4,2x12 TCB SELF-TAPPIN G SCREW	2.000	PC	VM1465A1	CT BT TEMPERATUR E PROBE COVER	1.000	PC							
Code	Description	Qty	UOM																														
GN1285A0	NTC TEMPERATUR E PROBE SEALING	2.000	PC																														
SL1045A0	S57 BLACK SILICONE - 80ml CARTRIDGE	1.000	PC																														
TR1002A1		1.000	PC																														
VI1220A1	4,2x12 TCB SELF-TAPPIN G SCREW	2.000	PC																														
VM1465A1	CT BT TEMPERATUR E PROBE COVER	1.000	PC																														
TR1106B	PT100 L=2000 TEMPERATURE PROBE		KTR1106B	MIND.Maps L2000 CHAMBER TEMP. PROBE KIT	<table border="1"> <thead> <tr> <th>Code</th> <th>Description</th> <th>Qty</th> <th>UOM</th> </tr> </thead> <tbody> <tr> <td>GN1285A0</td> <td>NTC TEMPERATUR E PROBE SEALING</td> <td>1.000</td> <td>PC</td> </tr> <tr> <td>SL1045A0</td> <td>S57 BLACK SILICONE - 80ml CARTRIDGE</td> <td>1.000</td> <td>PC</td> </tr> <tr> <td>TR1106B0</td> <td>PT100 L=2000 TEMPERATUR E PROBE</td> <td>1.000</td> <td>PC</td> </tr> <tr> <td>VI1220A1</td> <td>4,2x12 TCB SELF-TAPPIN G SCREW</td> <td>2.000</td> <td>PC</td> </tr> </tbody> </table>	Code	Description	Qty	UOM	GN1285A0	NTC TEMPERATUR E PROBE SEALING	1.000	PC	SL1045A0	S57 BLACK SILICONE - 80ml CARTRIDGE	1.000	PC	TR1106B0	PT100 L=2000 TEMPERATUR E PROBE	1.000	PC	VI1220A1	4,2x12 TCB SELF-TAPPIN G SCREW	2.000	PC								
Code	Description	Qty	UOM																														
GN1285A0	NTC TEMPERATUR E PROBE SEALING	1.000	PC																														
SL1045A0	S57 BLACK SILICONE - 80ml CARTRIDGE	1.000	PC																														
TR1106B0	PT100 L=2000 TEMPERATUR E PROBE	1.000	PC																														
VI1220A1	4,2x12 TCB SELF-TAPPIN G SCREW	2.000	PC																														



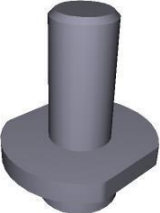



COMPONENT			SPARE PART																										
Code	Description	Image	Code	Description	Kit components																								
TR1106B	PT100 L=2000 TEMPERATURE PROBE		KTR1106B	MIND.Maps L2000 CHAMBER TEMP. PROBE KIT	<table border="1"> <thead> <tr> <th>Code</th> <th>Description</th> <th>Qty</th> <th>UOM</th> </tr> </thead> <tbody> <tr> <td>VM1464A1</td> <td>CT BT TEMPERATUR E PROBE COVER</td> <td>1.000</td> <td>PC</td> </tr> <tr> <td>VM1465A1</td> <td>CT BT TEMPERATUR E PROBE COVER</td> <td>1.000</td> <td>PC</td> </tr> </tbody> </table>	Code	Description	Qty	UOM	VM1464A1	CT BT TEMPERATUR E PROBE COVER	1.000	PC	VM1465A1	CT BT TEMPERATUR E PROBE COVER	1.000	PC												
Code	Description	Qty	UOM																										
VM1464A1	CT BT TEMPERATUR E PROBE COVER	1.000	PC																										
VM1465A1	CT BT TEMPERATUR E PROBE COVER	1.000	PC																										
VM1464A	CT BT TEMPERATURE PROBE COVER		KVM1464A	CT BT TEMPERATURE PROBE COVER KIT	<table border="1"> <thead> <tr> <th>Code</th> <th>Description</th> <th>Qty</th> <th>UOM</th> </tr> </thead> <tbody> <tr> <td>VM1464A1</td> <td>CT BT TEMPERATUR E PROBE COVER</td> <td>1.000</td> <td>PC</td> </tr> </tbody> </table>	Code	Description	Qty	UOM	VM1464A1	CT BT TEMPERATUR E PROBE COVER	1.000	PC																
Code	Description	Qty	UOM																										
VM1464A1	CT BT TEMPERATUR E PROBE COVER	1.000	PC																										
0H7030A	THERMOSTAT BULB INLET COVER		K0H7030A	THERMOSTAT BULB INLET COVER KIT	<table border="1"> <thead> <tr> <th>Code</th> <th>Description</th> <th>Qty</th> <th>UOM</th> </tr> </thead> <tbody> <tr> <td>0H7030A0</td> <td>THERMOSTAT BULB INLET COVER</td> <td>1.000</td> <td>PC</td> </tr> </tbody> </table>	Code	Description	Qty	UOM	0H7030A0	THERMOSTAT BULB INLET COVER	1.000	PC																
Code	Description	Qty	UOM																										
0H7030A0	THERMOSTAT BULB INLET COVER	1.000	PC																										
GN1531A	THERMOSTAT BULB INLET SEALING		KTR1136A	318°C -0/+24 SAFETY THERMOSTAT KIT	<table border="1"> <thead> <tr> <th>Code</th> <th>Description</th> <th>Qty</th> <th>UOM</th> </tr> </thead> <tbody> <tr> <td>0H7030A0</td> <td>THERMOSTAT BULB INLET COVER</td> <td>1.000</td> <td>PC</td> </tr> <tr> <td>GN1531A0</td> <td>THERMOSTAT BULB INLET SEALING</td> <td>1.000</td> <td>PC</td> </tr> <tr> <td>SL1045A0</td> <td>S57 BLACK SILICONE - 80ml CARTRIDGE</td> <td>1.000</td> <td>PC</td> </tr> <tr> <td>TR1136A0</td> <td>318°C -0/+24 1 POLE SAFETY THERMOSTAT</td> <td>1.000</td> <td>PC</td> </tr> <tr> <td>VI1220A1</td> <td>4,2x12 TCB SELF-TAPPIN G SCREW</td> <td>3.000</td> <td>PC</td> </tr> </tbody> </table>	Code	Description	Qty	UOM	0H7030A0	THERMOSTAT BULB INLET COVER	1.000	PC	GN1531A0	THERMOSTAT BULB INLET SEALING	1.000	PC	SL1045A0	S57 BLACK SILICONE - 80ml CARTRIDGE	1.000	PC	TR1136A0	318°C -0/+24 1 POLE SAFETY THERMOSTAT	1.000	PC	VI1220A1	4,2x12 TCB SELF-TAPPIN G SCREW	3.000	PC
Code	Description	Qty	UOM																										
0H7030A0	THERMOSTAT BULB INLET COVER	1.000	PC																										
GN1531A0	THERMOSTAT BULB INLET SEALING	1.000	PC																										
SL1045A0	S57 BLACK SILICONE - 80ml CARTRIDGE	1.000	PC																										
TR1136A0	318°C -0/+24 1 POLE SAFETY THERMOSTAT	1.000	PC																										
VI1220A1	4,2x12 TCB SELF-TAPPIN G SCREW	3.000	PC																										



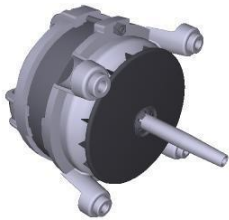
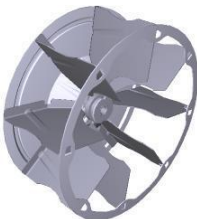

COMPONENT			SPARE PART																						
Code	Description	Image	Code	Description	Kit components																				
GN1588A	78x28 G6.25 HEATING ELEMENT GASKET		KG1588A	T - SHAPED FIT-D6-D10 HOLD-2 MAGNETS KIT	<table border="1"> <thead> <tr> <th>Code</th> <th>Description</th> <th>Qty</th> <th>UOM</th> </tr> </thead> <tbody> <tr> <td>GN1588A0</td> <td>78x28 G6.25 HEATING ELEMENT GASKET</td> <td>2.000</td> <td>PC</td> </tr> </tbody> </table>	Code	Description	Qty	UOM	GN1588A0	78x28 G6.25 HEATING ELEMENT GASKET	2.000	PC												
Code	Description	Qty	UOM																						
GN1588A0	78x28 G6.25 HEATING ELEMENT GASKET	2.000	PC																						
VM2416A	SMOKER LOCKING GUIDE PIN		VM2416A0	SMOKER LOCKING GUIDE PIN																					
0H4305A	ST. STEEL MOTOR SHAFT SEALING DIS		K0H4305A	SEALING DISC FOR MOTOR SHAFT KIT	<table border="1"> <thead> <tr> <th>Code</th> <th>Description</th> <th>Qty</th> <th>UOM</th> </tr> </thead> <tbody> <tr> <td>0H4305A1</td> <td>ST. STEEL MOTOR SHAFT SEALING DISC</td> <td>1.000</td> <td>PC</td> </tr> <tr> <td>GN1140A3</td> <td>MOLDED MOTOR HOLDER GASKET</td> <td>1.000</td> <td>PC</td> </tr> <tr> <td>SL1045A0</td> <td>S57 BLACK SILICONE - 80ml CARTRIDGE</td> <td>1.000</td> <td>PC</td> </tr> <tr> <td>VI1220A1</td> <td>4,2x12 TCB SELF-TAPPIN G SCREW</td> <td>3.000</td> <td>PC</td> </tr> </tbody> </table>	Code	Description	Qty	UOM	0H4305A1	ST. STEEL MOTOR SHAFT SEALING DISC	1.000	PC	GN1140A3	MOLDED MOTOR HOLDER GASKET	1.000	PC	SL1045A0	S57 BLACK SILICONE - 80ml CARTRIDGE	1.000	PC	VI1220A1	4,2x12 TCB SELF-TAPPIN G SCREW	3.000	PC
Code	Description	Qty	UOM																						
0H4305A1	ST. STEEL MOTOR SHAFT SEALING DISC	1.000	PC																						
GN1140A3	MOLDED MOTOR HOLDER GASKET	1.000	PC																						
SL1045A0	S57 BLACK SILICONE - 80ml CARTRIDGE	1.000	PC																						
VI1220A1	4,2x12 TCB SELF-TAPPIN G SCREW	3.000	PC																						
0H7170A	MM MOTOR GLASS WOOL PLATE		0H7170A0	MM MOTOR GLASS WOOL PLATE																					



COMPONENT			SPARE PART																																		
Code	Description	Image	Code	Description	Kit components																																
GN1140A	MOLDED MOTOR HOLDER GASKET		KGN1140A	5 PCS. MOTOR HOLDER GASKET KI	<table border="1"> <thead> <tr> <th>Code</th> <th>Description</th> <th>Qty</th> <th>UOM</th> </tr> </thead> <tbody> <tr> <td>GN1140A3</td> <td>MOLDED MOTOR HOLDER GASKET</td> <td>5.000</td> <td>PC</td> </tr> </tbody> </table>	Code	Description	Qty	UOM	GN1140A3	MOLDED MOTOR HOLDER GASKET	5.000	PC																								
Code	Description	Qty	UOM																																		
GN1140A3	MOLDED MOTOR HOLDER GASKET	5.000	PC																																		
MT1012A	330W 230V MOTOR		KVN1130A	LUX ≤08.2017/L.MISS/S.5/ 5E MOTOR KIT	<table border="1"> <thead> <tr> <th>Code</th> <th>Description</th> <th>Qty</th> <th>UOM</th> </tr> </thead> <tbody> <tr> <td>0H4305A1</td> <td>ST. STEEL MOTOR SHAFT SEALING DISC</td> <td>1.000</td> <td>PC</td> </tr> <tr> <td>GN1140A3</td> <td>MOLDED MOTOR HOLDER GASKET</td> <td>1.000</td> <td>PC</td> </tr> <tr> <td>VI1034A0</td> <td>STAINLESS STEEL WASHER 8.4x16x1</td> <td>1.000</td> <td>PC</td> </tr> <tr> <td>VI1256A0</td> <td>M8 DIN 980M ST. STEEL SELF LOCKING NUT</td> <td>1.000</td> <td>PC</td> </tr> <tr> <td>VM2196A0</td> <td>MOTOR NUT FASTENING BUSHING</td> <td>1.000</td> <td>PC</td> </tr> <tr> <td>VN1130A1</td> <td>330W 230V 50/60HZ MOTO</td> <td>1.000</td> <td>PC</td> </tr> </tbody> </table>	Code	Description	Qty	UOM	0H4305A1	ST. STEEL MOTOR SHAFT SEALING DISC	1.000	PC	GN1140A3	MOLDED MOTOR HOLDER GASKET	1.000	PC	VI1034A0	STAINLESS STEEL WASHER 8.4x16x1	1.000	PC	VI1256A0	M8 DIN 980M ST. STEEL SELF LOCKING NUT	1.000	PC	VM2196A0	MOTOR NUT FASTENING BUSHING	1.000	PC	VN1130A1	330W 230V 50/60HZ MOTO	1.000	PC				
Code	Description	Qty	UOM																																		
0H4305A1	ST. STEEL MOTOR SHAFT SEALING DISC	1.000	PC																																		
GN1140A3	MOLDED MOTOR HOLDER GASKET	1.000	PC																																		
VI1034A0	STAINLESS STEEL WASHER 8.4x16x1	1.000	PC																																		
VI1256A0	M8 DIN 980M ST. STEEL SELF LOCKING NUT	1.000	PC																																		
VM2196A0	MOTOR NUT FASTENING BUSHING	1.000	PC																																		
VN1130A1	330W 230V 50/60HZ MOTO	1.000	PC																																		
			KMT1012A	MIND.MAPS / LUX >08.2017 330W MOTOR KIT	<table border="1"> <thead> <tr> <th>Code</th> <th>Description</th> <th>Qty</th> <th>UOM</th> </tr> </thead> <tbody> <tr> <td>0H2842A0</td> <td>MT1012 CENTERING JI</td> <td>1.000</td> <td>PC</td> </tr> <tr> <td>0H4305A1</td> <td>ST. STEEL MOTOR SHAFT SEALING DISC</td> <td>1.000</td> <td>PC</td> </tr> <tr> <td>GN1140A3</td> <td>MOLDED MOTOR HOLDER GASKET</td> <td>1.000</td> <td>PC</td> </tr> <tr> <td>MT1012A0</td> <td>330W 230V MOTOR</td> <td>1.000</td> <td>PC</td> </tr> <tr> <td>VE1550A0</td> <td>5X3 MM NEODYMIUM MAGNET</td> <td>1.000</td> <td>PC</td> </tr> <tr> <td>VI1077A1</td> <td>SCREW M6x12 TE INOX</td> <td>1.000</td> <td>PC</td> </tr> <tr> <td>VI1521A0</td> <td>STAINLESS STEEL WASHER D=6 6592</td> <td>1.000</td> <td>PC</td> </tr> </tbody> </table>	Code	Description	Qty	UOM	0H2842A0	MT1012 CENTERING JI	1.000	PC	0H4305A1	ST. STEEL MOTOR SHAFT SEALING DISC	1.000	PC	GN1140A3	MOLDED MOTOR HOLDER GASKET	1.000	PC	MT1012A0	330W 230V MOTOR	1.000	PC	VE1550A0	5X3 MM NEODYMIUM MAGNET	1.000	PC	VI1077A1	SCREW M6x12 TE INOX	1.000	PC	VI1521A0	STAINLESS STEEL WASHER D=6 6592	1.000	PC
Code	Description	Qty	UOM																																		
0H2842A0	MT1012 CENTERING JI	1.000	PC																																		
0H4305A1	ST. STEEL MOTOR SHAFT SEALING DISC	1.000	PC																																		
GN1140A3	MOLDED MOTOR HOLDER GASKET	1.000	PC																																		
MT1012A0	330W 230V MOTOR	1.000	PC																																		
VE1550A0	5X3 MM NEODYMIUM MAGNET	1.000	PC																																		
VI1077A1	SCREW M6x12 TE INOX	1.000	PC																																		
VI1521A0	STAINLESS STEEL WASHER D=6 6592	1.000	PC																																		

COMPONENT			SPARE PART																		
Code	Description	Image	Code	Description	Kit components																
MT1012A	330W 230V MOTOR		KMT1012A	MIND.MAPS / LUX >08.2017 330W MOTOR KIT	<table border="1"> <thead> <tr> <th>Code</th> <th>Description</th> <th>Qty</th> <th>UOM</th> </tr> </thead> <tbody> <tr> <td>VI1966A0</td> <td>M4X14 FLATHEAD SCREW</td> <td>1.000</td> <td>PC</td> </tr> <tr> <td>VM1635A0</td> <td>MAGNET HOLDING DIS</td> <td>1.000</td> <td>PC</td> </tr> </tbody> </table>	Code	Description	Qty	UOM	VI1966A0	M4X14 FLATHEAD SCREW	1.000	PC	VM1635A0	MAGNET HOLDING DIS	1.000	PC				
Code	Description	Qty	UOM																		
VI1966A0	M4X14 FLATHEAD SCREW	1.000	PC																		
VM1635A0	MAGNET HOLDING DIS	1.000	PC																		
VN1170B	D195 H80 8 BLADES FAN+RING		KVN1184A	D195 H80 8 CONCAVE BLADES FAN KIT	<table border="1"> <thead> <tr> <th>Code</th> <th>Description</th> <th>Qty</th> <th>UOM</th> </tr> </thead> <tbody> <tr> <td>V1122A0</td> <td>A4 316 M6X12 SCREW</td> <td>1.000</td> <td>PC</td> </tr> <tr> <td>V1123A0</td> <td>A4 ST. STEEL FLAT WASHER FOR M6</td> <td>1.000</td> <td>PC</td> </tr> <tr> <td>VN1184A0</td> <td>D195 H80 8 CONCAVE BLADES FAN</td> <td>1.000</td> <td>PC</td> </tr> </tbody> </table>	Code	Description	Qty	UOM	V1122A0	A4 316 M6X12 SCREW	1.000	PC	V1123A0	A4 ST. STEEL FLAT WASHER FOR M6	1.000	PC	VN1184A0	D195 H80 8 CONCAVE BLADES FAN	1.000	PC
Code	Description	Qty	UOM																		
V1122A0	A4 316 M6X12 SCREW	1.000	PC																		
V1123A0	A4 ST. STEEL FLAT WASHER FOR M6	1.000	PC																		
VN1184A0	D195 H80 8 CONCAVE BLADES FAN	1.000	PC																		
0G1549C	XEVC-0511-E COMPLETE FAN GUARD WITH FLAP		K0G1549C	XEVC-0511-E COMPLETE FAN GUARD KIT	<table border="1"> <thead> <tr> <th>Code</th> <th>Description</th> <th>Qty</th> <th>UOM</th> </tr> </thead> <tbody> <tr> <td>0G1549C0</td> <td>XEVC-0511-E COMPLETE FAN GUARD WITH FLAP</td> <td>1.000</td> <td>PC</td> </tr> <tr> <td>TB2951B0</td> <td>XEVC-0511-E INTERNAL WATER PIPE</td> <td>1.000</td> <td>PC</td> </tr> <tr> <td>V11220A1</td> <td>4,2x12 TCB SELF-TAPPIN G SCREW</td> <td>2.000</td> <td>PC</td> </tr> </tbody> </table>	Code	Description	Qty	UOM	0G1549C0	XEVC-0511-E COMPLETE FAN GUARD WITH FLAP	1.000	PC	TB2951B0	XEVC-0511-E INTERNAL WATER PIPE	1.000	PC	V11220A1	4,2x12 TCB SELF-TAPPIN G SCREW	2.000	PC
Code	Description	Qty	UOM																		
0G1549C0	XEVC-0511-E COMPLETE FAN GUARD WITH FLAP	1.000	PC																		
TB2951B0	XEVC-0511-E INTERNAL WATER PIPE	1.000	PC																		
V11220A1	4,2x12 TCB SELF-TAPPIN G SCREW	2.000	PC																		
TB2951B	XEVC-0511-E INTERNAL WATER PIPE		TB2951B0	XEVC-0511-E INTERNAL WATER PIPE																	
SN1030A	L1550 SinglePoint CORE PROBE WITHOUT NUT		KSN1030A	SINGLE POINT CORE PROBE KIT L1550	<table border="1"> <thead> <tr> <th>Code</th> <th>Description</th> <th>Qty</th> <th>UOM</th> </tr> </thead> <tbody> <tr> <td>0H7030A0</td> <td>THERMOSTAT BULB INLET COVER</td> <td>1.000</td> <td>PC</td> </tr> <tr> <td>GN1632A0</td> <td>CORE PROBE INLET GASKET</td> <td>1.000</td> <td>PC</td> </tr> <tr> <td>SL1045A0</td> <td>S57 BLACK SILICONE - 80ml CARTRIDGE</td> <td>1.000</td> <td>PC</td> </tr> </tbody> </table>	Code	Description	Qty	UOM	0H7030A0	THERMOSTAT BULB INLET COVER	1.000	PC	GN1632A0	CORE PROBE INLET GASKET	1.000	PC	SL1045A0	S57 BLACK SILICONE - 80ml CARTRIDGE	1.000	PC
Code	Description	Qty	UOM																		
0H7030A0	THERMOSTAT BULB INLET COVER	1.000	PC																		
GN1632A0	CORE PROBE INLET GASKET	1.000	PC																		
SL1045A0	S57 BLACK SILICONE - 80ml CARTRIDGE	1.000	PC																		

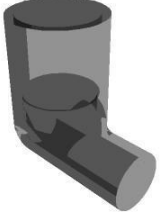



COMPONENT			SPARE PART																						
Code	Description	Image	Code	Description	Kit components																				
SN1030A	L1550 SinglePoint CORE PROBE WITHOUT NUT		KSN1030A	SINGLE POINT CORE PROBE KIT L1550	<table border="1"> <thead> <tr> <th>Code</th> <th>Description</th> <th>Qty</th> <th>UOM</th> </tr> </thead> <tbody> <tr> <td>SN1030A1</td> <td>L1550 MONOPOINT CORE PROBE WITHOUT NUT</td> <td>1.000</td> <td>PC</td> </tr> <tr> <td>V1220A1</td> <td>4,2x12 TCB SELF-TAPPIN G SCREW</td> <td>3.000</td> <td>PC</td> </tr> </tbody> </table>	Code	Description	Qty	UOM	SN1030A1	L1550 MONOPOINT CORE PROBE WITHOUT NUT	1.000	PC	V1220A1	4,2x12 TCB SELF-TAPPIN G SCREW	3.000	PC								
Code	Description	Qty	UOM																						
SN1030A1	L1550 MONOPOINT CORE PROBE WITHOUT NUT	1.000	PC																						
V1220A1	4,2x12 TCB SELF-TAPPIN G SCREW	3.000	PC																						
GRL1389A	GRL1389A1		KGRL1390A	MIND.Maps 5 GN1/1 LATERAL SUPPORTS KIT	<table border="1"> <thead> <tr> <th>Code</th> <th>Description</th> <th>Qty</th> <th>UOM</th> </tr> </thead> <tbody> <tr> <td>0H7300B0</td> <td>0H7308 0H7309 SUPPORT PROFILE</td> <td>1.000</td> <td>PC</td> </tr> <tr> <td>0H7301B0</td> <td>0H7310 0H7311 SUPPORT PROFILE</td> <td>1.000</td> <td>PC</td> </tr> <tr> <td>GRL1389A2</td> <td></td> <td>1.000</td> <td>PC</td> </tr> <tr> <td>GRL1390A2</td> <td></td> <td>1.000</td> <td>PC</td> </tr> </tbody> </table>	Code	Description	Qty	UOM	0H7300B0	0H7308 0H7309 SUPPORT PROFILE	1.000	PC	0H7301B0	0H7310 0H7311 SUPPORT PROFILE	1.000	PC	GRL1389A2		1.000	PC	GRL1390A2		1.000	PC
Code	Description	Qty	UOM																						
0H7300B0	0H7308 0H7309 SUPPORT PROFILE	1.000	PC																						
0H7301B0	0H7310 0H7311 SUPPORT PROFILE	1.000	PC																						
GRL1389A2		1.000	PC																						
GRL1390A2		1.000	PC																						
GRL1390A	GRL1390A1		KGRL1390A	MIND.Maps 5 GN1/1 LATERAL SUPPORTS KIT	<table border="1"> <thead> <tr> <th>Code</th> <th>Description</th> <th>Qty</th> <th>UOM</th> </tr> </thead> <tbody> <tr> <td>0H7300B0</td> <td>0H7308 0H7309 SUPPORT PROFILE</td> <td>1.000</td> <td>PC</td> </tr> <tr> <td>0H7301B0</td> <td>0H7310 0H7311 SUPPORT PROFILE</td> <td>1.000</td> <td>PC</td> </tr> <tr> <td>GRL1389A2</td> <td></td> <td>1.000</td> <td>PC</td> </tr> <tr> <td>GRL1390A2</td> <td></td> <td>1.000</td> <td>PC</td> </tr> </tbody> </table>	Code	Description	Qty	UOM	0H7300B0	0H7308 0H7309 SUPPORT PROFILE	1.000	PC	0H7301B0	0H7310 0H7311 SUPPORT PROFILE	1.000	PC	GRL1389A2		1.000	PC	GRL1390A2		1.000	PC
Code	Description	Qty	UOM																						
0H7300B0	0H7308 0H7309 SUPPORT PROFILE	1.000	PC																						
0H7301B0	0H7310 0H7311 SUPPORT PROFILE	1.000	PC																						
GRL1389A2		1.000	PC																						
GRL1390A2		1.000	PC																						
GN1584A	CORNER FITTING D30-D16		KG1584A	D30-D16 CORNER FITTING KIT	<table border="1"> <thead> <tr> <th>Code</th> <th>Description</th> <th>Qty</th> <th>UOM</th> </tr> </thead> <tbody> <tr> <td>GN1584A0</td> <td>CORNER FITTING D30-D16</td> <td>1.000</td> <td>PC</td> </tr> </tbody> </table>	Code	Description	Qty	UOM	GN1584A0	CORNER FITTING D30-D16	1.000	PC												
Code	Description	Qty	UOM																						
GN1584A0	CORNER FITTING D30-D16	1.000	PC																						
RC1042A	DOUBLE WIRE SPRING CLAMP D21.5-22.6		KTB3074B	XEVC-0711-G VENTURI COLLECTOR PIPE KI	<table border="1"> <thead> <tr> <th>Code</th> <th>Description</th> <th>Qty</th> <th>UOM</th> </tr> </thead> <tbody> <tr> <td>GN1544A0</td> <td>AIR INLET GASKET</td> <td>1.000</td> <td>PC</td> </tr> <tr> <td>GN1584A0</td> <td>CORNER FITTING D30-D16</td> <td>1.000</td> <td>PC</td> </tr> <tr> <td>RC1042A0</td> <td>DOUBLE WIRE SPRING CLAMP D21.5-22.6</td> <td>1.000</td> <td>PC</td> </tr> </tbody> </table>	Code	Description	Qty	UOM	GN1544A0	AIR INLET GASKET	1.000	PC	GN1584A0	CORNER FITTING D30-D16	1.000	PC	RC1042A0	DOUBLE WIRE SPRING CLAMP D21.5-22.6	1.000	PC				
Code	Description	Qty	UOM																						
GN1544A0	AIR INLET GASKET	1.000	PC																						
GN1584A0	CORNER FITTING D30-D16	1.000	PC																						
RC1042A0	DOUBLE WIRE SPRING CLAMP D21.5-22.6	1.000	PC																						





COMPONENT			SPARE PART																										
Code	Description	Image	Code	Description	Kit components																								
RC1042A	DOUBLE WIRE SPRING CLAMP D21.5-22.6		KTB3074B	XEVC-0711-G VENTURI COLLECTOR PIPE KI	<table border="1"> <thead> <tr> <th>Code</th> <th>Description</th> <th>Qty</th> <th>UOM</th> </tr> </thead> <tbody> <tr> <td>TB3074B0</td> <td>XEVC-07EU-G VENTURI COLLECTOR PIPE D30</td> <td>1.000</td> <td>PC</td> </tr> <tr> <td>VM1794A0</td> <td>250x4.8 PA66 BLACK CLAMP</td> <td>1.000</td> <td>PC</td> </tr> </tbody> </table>	Code	Description	Qty	UOM	TB3074B0	XEVC-07EU-G VENTURI COLLECTOR PIPE D30	1.000	PC	VM1794A0	250x4.8 PA66 BLACK CLAMP	1.000	PC												
			Code	Description	Qty	UOM																							
			TB3074B0	XEVC-07EU-G VENTURI COLLECTOR PIPE D30	1.000	PC																							
			VM1794A0	250x4.8 PA66 BLACK CLAMP	1.000	PC																							
			KTB3068B	10FS/EU/2-G VENTURI COLLECTOR PIPE KI	<table border="1"> <thead> <tr> <th>Code</th> <th>Description</th> <th>Qty</th> <th>UOM</th> </tr> </thead> <tbody> <tr> <td>GN1544A0</td> <td>AIR INLET GASKET</td> <td>2.000</td> <td>PC</td> </tr> <tr> <td>GN1584A0</td> <td>CORNER FITTING D30-D16</td> <td>1.000</td> <td>PC</td> </tr> <tr> <td>RC1042A0</td> <td>DOUBLE WIRE SPRING CLAMP D21.5-22.6</td> <td>1.000</td> <td>PC</td> </tr> <tr> <td>TB3068B0</td> <td>XEBC-10 VENTURI AIR COLLECTOR PIPE D30</td> <td>1.000</td> <td>PC</td> </tr> <tr> <td>VM1794A0</td> <td>250x4.8 PA66 BLACK CLAMP</td> <td>1.000</td> <td>PC</td> </tr> </tbody> </table>	Code	Description	Qty	UOM	GN1544A0	AIR INLET GASKET	2.000	PC	GN1584A0	CORNER FITTING D30-D16	1.000	PC	RC1042A0	DOUBLE WIRE SPRING CLAMP D21.5-22.6	1.000	PC	TB3068B0	XEBC-10 VENTURI AIR COLLECTOR PIPE D30	1.000	PC	VM1794A0	250x4.8 PA66 BLACK CLAMP	1.000	PC
			Code	Description	Qty	UOM																							
			GN1544A0	AIR INLET GASKET	2.000	PC																							
			GN1584A0	CORNER FITTING D30-D16	1.000	PC																							
			RC1042A0	DOUBLE WIRE SPRING CLAMP D21.5-22.6	1.000	PC																							
			TB3068B0	XEBC-10 VENTURI AIR COLLECTOR PIPE D30	1.000	PC																							
			VM1794A0	250x4.8 PA66 BLACK CLAMP	1.000	PC																							
			KTB3019A	20XX/16XX UPPER VENTURI COLLECT PIPE KIT	<table border="1"> <thead> <tr> <th>Code</th> <th>Description</th> <th>Qty</th> <th>UOM</th> </tr> </thead> <tbody> <tr> <td>GN1544A0</td> <td>AIR INLET GASKET</td> <td>1.000</td> <td>PC</td> </tr> <tr> <td>GN1584A0</td> <td>CORNER FITTING D30-D16</td> <td>1.000</td> <td>PC</td> </tr> <tr> <td>RC1042A0</td> <td>DOUBLE WIRE SPRING CLAMP D21.5-22.6</td> <td>1.000</td> <td>PC</td> </tr> <tr> <td>TB3019A1</td> <td>XEVC-2011 UPPER AIR INLET PIPE D3</td> <td>1.000</td> <td>PC</td> </tr> <tr> <td>VM1794A0</td> <td>250x4.8 PA66 BLACK CLAMP</td> <td>1.000</td> <td>PC</td> </tr> </tbody> </table>	Code	Description	Qty	UOM	GN1544A0	AIR INLET GASKET	1.000	PC	GN1584A0	CORNER FITTING D30-D16	1.000	PC	RC1042A0	DOUBLE WIRE SPRING CLAMP D21.5-22.6	1.000	PC	TB3019A1	XEVC-2011 UPPER AIR INLET PIPE D3	1.000	PC	VM1794A0	250x4.8 PA66 BLACK CLAMP	1.000	PC
Code	Description	Qty	UOM																										
GN1544A0	AIR INLET GASKET	1.000	PC																										
GN1584A0	CORNER FITTING D30-D16	1.000	PC																										
RC1042A0	DOUBLE WIRE SPRING CLAMP D21.5-22.6	1.000	PC																										
TB3019A1	XEVC-2011 UPPER AIR INLET PIPE D3	1.000	PC																										
VM1794A0	250x4.8 PA66 BLACK CLAMP	1.000	PC																										
KTB2979C	XEBC-10XX-E VENTURI COLLECTOR PIPE KI	<table border="1"> <thead> <tr> <th>Code</th> <th>Description</th> <th>Qty</th> <th>UOM</th> </tr> </thead> <tbody> <tr> <td>GN1544A0</td> <td>AIR INLET GASKET</td> <td>2.000</td> <td>PC</td> </tr> <tr> <td>GN1584A0</td> <td>CORNER FITTING D30-D16</td> <td>1.000</td> <td>PC</td> </tr> <tr> <td>RC1042A0</td> <td>DOUBLE WIRE SPRING CLAMP D21.5-22.6</td> <td>1.000</td> <td>PC</td> </tr> <tr> <td>TB2979C0</td> <td>XEBC-10 VENTURI AIR COLLECTOR PIPE D30</td> <td>1.000</td> <td>PC</td> </tr> <tr> <td>VM1794A0</td> <td>250x4.8 PA66 BLACK CLAMP</td> <td>1.000</td> <td>PC</td> </tr> </tbody> </table>	Code	Description	Qty	UOM	GN1544A0	AIR INLET GASKET	2.000	PC	GN1584A0	CORNER FITTING D30-D16	1.000	PC	RC1042A0	DOUBLE WIRE SPRING CLAMP D21.5-22.6	1.000	PC	TB2979C0	XEBC-10 VENTURI AIR COLLECTOR PIPE D30	1.000	PC	VM1794A0	250x4.8 PA66 BLACK CLAMP	1.000	PC			
Code	Description	Qty	UOM																										
GN1544A0	AIR INLET GASKET	2.000	PC																										
GN1584A0	CORNER FITTING D30-D16	1.000	PC																										
RC1042A0	DOUBLE WIRE SPRING CLAMP D21.5-22.6	1.000	PC																										
TB2979C0	XEBC-10 VENTURI AIR COLLECTOR PIPE D30	1.000	PC																										
VM1794A0	250x4.8 PA66 BLACK CLAMP	1.000	PC																										







COMPONENT			SPARE PART																										
Code	Description	Image	Code	Description	Kit components																								
RC1042A	DOUBLE WIRE SPRING CLAMP D21.5-22.6		KTB2978B	XEBC-06 VENTURI COLLECTOR PIPE KI	<table border="1"> <thead> <tr> <th>Code</th> <th>Description</th> <th>Qty</th> <th>UOM</th> </tr> </thead> <tbody> <tr> <td>GN1544A0</td> <td>AIR INLET GASKET</td> <td>1.000</td> <td>PC</td> </tr> <tr> <td>GN1584A0</td> <td>CORNER FITTING D30-D16</td> <td>1.000</td> <td>PC</td> </tr> <tr> <td>RC1042A0</td> <td>DOUBLE WIRE SPRING CLAMP D21.5-22.6</td> <td>1.000</td> <td>PC</td> </tr> <tr> <td>TB2978B0</td> <td>XEBC-06 VENTURI AIR COLLECTOR PIPE D30</td> <td>1.000</td> <td>PC</td> </tr> <tr> <td>VM1794A0</td> <td>250x4.8 PA66 BLACK CLAMP</td> <td>1.000</td> <td>PC</td> </tr> </tbody> </table>	Code	Description	Qty	UOM	GN1544A0	AIR INLET GASKET	1.000	PC	GN1584A0	CORNER FITTING D30-D16	1.000	PC	RC1042A0	DOUBLE WIRE SPRING CLAMP D21.5-22.6	1.000	PC	TB2978B0	XEBC-06 VENTURI AIR COLLECTOR PIPE D30	1.000	PC	VM1794A0	250x4.8 PA66 BLACK CLAMP	1.000	PC
					Code	Description	Qty	UOM																					
					GN1544A0	AIR INLET GASKET	1.000	PC																					
					GN1584A0	CORNER FITTING D30-D16	1.000	PC																					
			RC1042A0	DOUBLE WIRE SPRING CLAMP D21.5-22.6	1.000	PC																							
			TB2978B0	XEBC-06 VENTURI AIR COLLECTOR PIPE D30	1.000	PC																							
			VM1794A0	250x4.8 PA66 BLACK CLAMP	1.000	PC																							
			KTB2959B	XEVC-1011-E VENTURI COLLECTOR PIPE KI	<table border="1"> <thead> <tr> <th>Code</th> <th>Description</th> <th>Qty</th> <th>UOM</th> </tr> </thead> <tbody> <tr> <td>GN1544A0</td> <td>AIR INLET GASKET</td> <td>2.000</td> <td>PC</td> </tr> <tr> <td>GN1584A0</td> <td>CORNER FITTING D30-D16</td> <td>1.000</td> <td>PC</td> </tr> <tr> <td>RC1042A0</td> <td>DOUBLE WIRE SPRING CLAMP D21.5-22.6</td> <td>1.000</td> <td>PC</td> </tr> <tr> <td>TB2959B0</td> <td>XEVC-1011-E VENTURI PIPE</td> <td>1.000</td> <td>PC</td> </tr> <tr> <td>VM1794A0</td> <td>250x4.8 PA66 BLACK CLAMP</td> <td>1.000</td> <td>PC</td> </tr> </tbody> </table>	Code	Description	Qty	UOM	GN1544A0	AIR INLET GASKET	2.000	PC	GN1584A0	CORNER FITTING D30-D16	1.000	PC	RC1042A0	DOUBLE WIRE SPRING CLAMP D21.5-22.6	1.000	PC	TB2959B0	XEVC-1011-E VENTURI PIPE	1.000	PC	VM1794A0	250x4.8 PA66 BLACK CLAMP	1.000	PC
					Code	Description	Qty	UOM																					
					GN1544A0	AIR INLET GASKET	2.000	PC																					
					GN1584A0	CORNER FITTING D30-D16	1.000	PC																					
			RC1042A0	DOUBLE WIRE SPRING CLAMP D21.5-22.6	1.000	PC																							
TB2959B0	XEVC-1011-E VENTURI PIPE	1.000	PC																										
VM1794A0	250x4.8 PA66 BLACK CLAMP	1.000	PC																										
KTB2958B	XEVC-0711-E VENTURI COLLECTOR PIPE KI	<table border="1"> <thead> <tr> <th>Code</th> <th>Description</th> <th>Qty</th> <th>UOM</th> </tr> </thead> <tbody> <tr> <td>GN1544A0</td> <td>AIR INLET GASKET</td> <td>1.000</td> <td>PC</td> </tr> <tr> <td>GN1584A0</td> <td>CORNER FITTING D30-D16</td> <td>1.000</td> <td>PC</td> </tr> <tr> <td>RC1042A0</td> <td>DOUBLE WIRE SPRING CLAMP D21.5-22.6</td> <td>1.000</td> <td>PC</td> </tr> <tr> <td>TB2958B0</td> <td>XEVC-0711-E VENTURI PIPE</td> <td>1.000</td> <td>PC</td> </tr> <tr> <td>VM1794A0</td> <td>250x4.8 PA66 BLACK CLAMP</td> <td>1.000</td> <td>PC</td> </tr> </tbody> </table>	Code	Description	Qty	UOM	GN1544A0	AIR INLET GASKET	1.000	PC	GN1584A0	CORNER FITTING D30-D16	1.000	PC	RC1042A0	DOUBLE WIRE SPRING CLAMP D21.5-22.6	1.000	PC	TB2958B0	XEVC-0711-E VENTURI PIPE	1.000	PC	VM1794A0	250x4.8 PA66 BLACK CLAMP	1.000	PC			
		Code	Description	Qty	UOM																								
		GN1544A0	AIR INLET GASKET	1.000	PC																								
		GN1584A0	CORNER FITTING D30-D16	1.000	PC																								
RC1042A0	DOUBLE WIRE SPRING CLAMP D21.5-22.6	1.000	PC																										
TB2958B0	XEVC-0711-E VENTURI PIPE	1.000	PC																										
VM1794A0	250x4.8 PA66 BLACK CLAMP	1.000	PC																										
KTB2957B	0511/04EU-E VENTURI COLLECTOR PIPE KI	<table border="1"> <thead> <tr> <th>Code</th> <th>Description</th> <th>Qty</th> <th>UOM</th> </tr> </thead> <tbody> <tr> <td>GN1544A0</td> <td>AIR INLET GASKET</td> <td>1.000</td> <td>PC</td> </tr> <tr> <td>GN1584A0</td> <td>CORNER FITTING D30-D16</td> <td>1.000</td> <td>PC</td> </tr> </tbody> </table>	Code	Description	Qty	UOM	GN1544A0	AIR INLET GASKET	1.000	PC	GN1584A0	CORNER FITTING D30-D16	1.000	PC															
		Code	Description	Qty	UOM																								
GN1544A0	AIR INLET GASKET	1.000	PC																										
GN1584A0	CORNER FITTING D30-D16	1.000	PC																										

COMPONENT			SPARE PART																							
Code	Description	Image	Code	Description	Kit components																					
RC1042A	DOUBLE WIRE SPRING CLAMP D21.5-22.6		KTB2957B	0511/04EU-E VENTURI COLLECTOR PIPE KI	<table border="1"> <thead> <tr> <th>Code</th> <th>Description</th> <th>Qty</th> <th>UOM</th> </tr> </thead> <tbody> <tr> <td>RC1042A0</td> <td>DOUBLE WIRE SPRING CLAMP D21.5-22.6</td> <td>1.000</td> <td>PC</td> </tr> <tr> <td>TB2957B0</td> <td>XEVC-0511-E VENTURI PIPE</td> <td>1.000</td> <td>PC</td> </tr> <tr> <td>VM1794A0</td> <td>250x4.8 PA66 BLACK CLAMP</td> <td>1.000</td> <td>PC</td> </tr> </tbody> </table>	Code	Description	Qty	UOM	RC1042A0	DOUBLE WIRE SPRING CLAMP D21.5-22.6	1.000	PC	TB2957B0	XEVC-0511-E VENTURI PIPE	1.000	PC	VM1794A0	250x4.8 PA66 BLACK CLAMP	1.000	PC					
			Code	Description	Qty	UOM																				
			RC1042A0	DOUBLE WIRE SPRING CLAMP D21.5-22.6	1.000	PC																				
TB2957B0	XEVC-0511-E VENTURI PIPE	1.000	PC																							
VM1794A0	250x4.8 PA66 BLACK CLAMP	1.000	PC																							
KTB2956A	XEVC-0311-E VENTURI COLLECTOR PIPE KI	<table border="1"> <thead> <tr> <th>Code</th> <th>Description</th> <th>Qty</th> <th>UOM</th> </tr> </thead> <tbody> <tr> <td>GN1544A0</td> <td>AIR INLET GASKET</td> <td>1.000</td> <td>PC</td> </tr> <tr> <td>RC1042A0</td> <td>DOUBLE WIRE SPRING CLAMP D21.5-22.6</td> <td>1.000</td> <td>PC</td> </tr> <tr> <td>TB2956A0</td> <td>XEVC-0311-E VENTURI PIPE</td> <td>1.000</td> <td>PC</td> </tr> </tbody> </table>	Code	Description	Qty	UOM	GN1544A0	AIR INLET GASKET	1.000	PC	RC1042A0	DOUBLE WIRE SPRING CLAMP D21.5-22.6	1.000	PC	TB2956A0	XEVC-0311-E VENTURI PIPE	1.000	PC								
Code	Description	Qty	UOM																							
GN1544A0	AIR INLET GASKET	1.000	PC																							
RC1042A0	DOUBLE WIRE SPRING CLAMP D21.5-22.6	1.000	PC																							
TB2956A0	XEVC-0311-E VENTURI PIPE	1.000	PC																							
KTB2944A	20XX/16XX LOWER VENTURI COLLECT PIPE KIT	<table border="1"> <thead> <tr> <th>Code</th> <th>Description</th> <th>Qty</th> <th>UOM</th> </tr> </thead> <tbody> <tr> <td>GN1544A0</td> <td>AIR INLET GASKET</td> <td>2.000</td> <td>PC</td> </tr> <tr> <td>GN1584A0</td> <td>CORNER FITTING D30-D16</td> <td>1.000</td> <td>PC</td> </tr> <tr> <td>RC1042A0</td> <td>DOUBLE WIRE SPRING CLAMP D21.5-22.6</td> <td>1.000</td> <td>PC</td> </tr> <tr> <td>TB2944A1</td> <td>XEVC-2011 AIR INLET PIPE D3</td> <td>1.000</td> <td>PC</td> </tr> <tr> <td>VM1794A0</td> <td>250x4.8 PA66 BLACK CLAMP</td> <td>1.000</td> <td>PC</td> </tr> </tbody> </table>	Code	Description	Qty	UOM	GN1544A0	AIR INLET GASKET	2.000	PC	GN1584A0	CORNER FITTING D30-D16	1.000	PC	RC1042A0	DOUBLE WIRE SPRING CLAMP D21.5-22.6	1.000	PC	TB2944A1	XEVC-2011 AIR INLET PIPE D3	1.000	PC	VM1794A0	250x4.8 PA66 BLACK CLAMP	1.000	PC
Code	Description	Qty	UOM																							
GN1544A0	AIR INLET GASKET	2.000	PC																							
GN1584A0	CORNER FITTING D30-D16	1.000	PC																							
RC1042A0	DOUBLE WIRE SPRING CLAMP D21.5-22.6	1.000	PC																							
TB2944A1	XEVC-2011 AIR INLET PIPE D3	1.000	PC																							
VM1794A0	250x4.8 PA66 BLACK CLAMP	1.000	PC																							
KRC1042A	10PCS CLAMP BIFIL SPRING D21.5-22.6 KIT	<table border="1"> <thead> <tr> <th>Code</th> <th>Description</th> <th>Qty</th> <th>UOM</th> </tr> </thead> <tbody> <tr> <td>RC1042A0</td> <td>DOUBLE WIRE SPRING CLAMP D21.5-22.6</td> <td>10.000</td> <td>PC</td> </tr> </tbody> </table>	Code	Description	Qty	UOM	RC1042A0	DOUBLE WIRE SPRING CLAMP D21.5-22.6	10.000	PC																
Code	Description	Qty	UOM																							
RC1042A0	DOUBLE WIRE SPRING CLAMP D21.5-22.6	10.000	PC																							
RC1378A	HOSE CLAMP		KVM2379A	MM 200V VENTURI ACTUATOR SYSTEM KIT	<table border="1"> <thead> <tr> <th>Code</th> <th>Description</th> <th>Qty</th> <th>UOM</th> </tr> </thead> <tbody> <tr> <td>RC1378A0</td> <td>HOSE CLAMP</td> <td>3.000</td> <td>PC</td> </tr> <tr> <td>TB1520A0</td> <td>Int. Ø=38 TH=4 DRAIN BLACK RUBBER PIPE</td> <td>0.120</td> <td>M</td> </tr> <tr> <td>VM2379A1</td> <td></td> <td>1.000</td> <td>PC</td> </tr> </tbody> </table>	Code	Description	Qty	UOM	RC1378A0	HOSE CLAMP	3.000	PC	TB1520A0	Int. Ø=38 TH=4 DRAIN BLACK RUBBER PIPE	0.120	M	VM2379A1		1.000	PC					
			Code	Description	Qty	UOM																				
			RC1378A0	HOSE CLAMP	3.000	PC																				
TB1520A0	Int. Ø=38 TH=4 DRAIN BLACK RUBBER PIPE	0.120	M																							
VM2379A1		1.000	PC																							
KVM2378A	MM 240V VENTURI ACTUATOR SYSTEM KIT	<table border="1"> <thead> <tr> <th>Code</th> <th>Description</th> <th>Qty</th> <th>UOM</th> </tr> </thead> <tbody> <tr> <td>RC1378A0</td> <td>HOSE CLAMP</td> <td>3.000</td> <td>PC</td> </tr> <tr> <td>TB1520A0</td> <td>Int. Ø=38 TH=4 DRAIN BLACK RUBBER PIPE</td> <td>0.120</td> <td>M</td> </tr> <tr> <td>VM2378A1</td> <td></td> <td>1.000</td> <td>PC</td> </tr> </tbody> </table>	Code	Description	Qty	UOM	RC1378A0	HOSE CLAMP	3.000	PC	TB1520A0	Int. Ø=38 TH=4 DRAIN BLACK RUBBER PIPE	0.120	M	VM2378A1		1.000	PC								
Code	Description	Qty	UOM																							
RC1378A0	HOSE CLAMP	3.000	PC																							
TB1520A0	Int. Ø=38 TH=4 DRAIN BLACK RUBBER PIPE	0.120	M																							
VM2378A1		1.000	PC																							

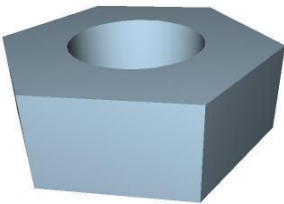

COMPONENT			SPARE PART																			
Code	Description	Image	Code	Description	Kit components																	
RC1378A	HOSE CLAMP		KVM2377A	MM 220 V VENTURI ACTUATOR SYSTEM KIT	<table border="1"> <thead> <tr> <th>Code</th> <th>Description</th> <th>Qty</th> <th>UOM</th> </tr> </thead> <tbody> <tr> <td>RC1378A0</td> <td>HOSE CLAMP</td> <td>3.000</td> <td>PC</td> </tr> <tr> <td>TB1520A0</td> <td>Int. Ø=38 TH=4 DRAIN BLACK RUBBER PIPE</td> <td>0.120</td> <td>M</td> </tr> <tr> <td>VM2377A1</td> <td>220 V 50/60 HZ EUR VENTURI SET</td> <td>1.000</td> <td>PC</td> </tr> </tbody> </table>	Code	Description	Qty	UOM	RC1378A0	HOSE CLAMP	3.000	PC	TB1520A0	Int. Ø=38 TH=4 DRAIN BLACK RUBBER PIPE	0.120	M	VM2377A1	220 V 50/60 HZ EUR VENTURI SET	1.000	PC	
			Code	Description	Qty	UOM																
			RC1378A0	HOSE CLAMP	3.000	PC																
TB1520A0	Int. Ø=38 TH=4 DRAIN BLACK RUBBER PIPE	0.120	M																			
VM2377A1	220 V 50/60 HZ EUR VENTURI SET	1.000	PC																			
KVE1140A	S.5/5E JAPAN VERSION VENTURI COIL KIT	<table border="1"> <thead> <tr> <th>Code</th> <th>Description</th> <th>Qty</th> <th>UOM</th> </tr> </thead> <tbody> <tr> <td>RC1378A0</td> <td>HOSE CLAMP</td> <td>2.000</td> <td>PC</td> </tr> <tr> <td>TB1520A0</td> <td>Int. Ø=38 TH=4 DRAIN BLACK RUBBER PIPE</td> <td>0.050</td> <td>M</td> </tr> <tr> <td>VI1220A1</td> <td>4,2x12 TCB SELF-TAPPIN G SCREW</td> <td>1.000</td> <td>PC</td> </tr> <tr> <td>VM2632A0</td> <td></td> <td>1.000</td> <td>PC</td> </tr> </tbody> </table>	Code	Description	Qty	UOM	RC1378A0	HOSE CLAMP	2.000	PC	TB1520A0	Int. Ø=38 TH=4 DRAIN BLACK RUBBER PIPE	0.050	M	VI1220A1	4,2x12 TCB SELF-TAPPIN G SCREW	1.000	PC	VM2632A0		1.000	PC
Code	Description	Qty	UOM																			
RC1378A0	HOSE CLAMP	2.000	PC																			
TB1520A0	Int. Ø=38 TH=4 DRAIN BLACK RUBBER PIPE	0.050	M																			
VI1220A1	4,2x12 TCB SELF-TAPPIN G SCREW	1.000	PC																			
VM2632A0		1.000	PC																			
KVE1014A	US VERSION SERIES 5 VENTURI COIL KIT	<table border="1"> <thead> <tr> <th>Code</th> <th>Description</th> <th>Qty</th> <th>UOM</th> </tr> </thead> <tbody> <tr> <td>RC1378A0</td> <td>HOSE CLAMP</td> <td>2.000</td> <td>PC</td> </tr> <tr> <td>TB1520A0</td> <td>Int. Ø=38 TH=4 DRAIN BLACK RUBBER PIPE</td> <td>0.050</td> <td>M</td> </tr> <tr> <td>VM2633A0</td> <td></td> <td>1.000</td> <td>PC</td> </tr> </tbody> </table>	Code	Description	Qty	UOM	RC1378A0	HOSE CLAMP	2.000	PC	TB1520A0	Int. Ø=38 TH=4 DRAIN BLACK RUBBER PIPE	0.050	M	VM2633A0		1.000	PC				
Code	Description	Qty	UOM																			
RC1378A0	HOSE CLAMP	2.000	PC																			
TB1520A0	Int. Ø=38 TH=4 DRAIN BLACK RUBBER PIPE	0.050	M																			
VM2633A0		1.000	PC																			
TB1956A	TB1520A-GREY SILICONE PIPE L=0,04M		KRC1378A	HOSE CLAMP 10 PCS KIT	<table border="1"> <thead> <tr> <th>Code</th> <th>Description</th> <th>Qty</th> <th>UOM</th> </tr> </thead> <tbody> <tr> <td>RC1378A0</td> <td>HOSE CLAMP</td> <td>10.000</td> <td>PC</td> </tr> </tbody> </table>	Code	Description	Qty	UOM	RC1378A0	HOSE CLAMP	10.000	PC									
			Code	Description	Qty	UOM																
			RC1378A0	HOSE CLAMP	10.000	PC																
KTB1002A	BLACK TUBE KIT EPDM 60MT TB1520	<table border="1"> <thead> <tr> <th>Code</th> <th>Description</th> <th>Qty</th> <th>UOM</th> </tr> </thead> <tbody> <tr> <td>TB1520A0</td> <td>Int. Ø=38 TH=4 DRAIN BLACK RUBBER PIPE</td> <td>60.000</td> <td>M</td> </tr> </tbody> </table>	Code	Description	Qty	UOM	TB1520A0	Int. Ø=38 TH=4 DRAIN BLACK RUBBER PIPE	60.000	M												
Code	Description	Qty	UOM																			
TB1520A0	Int. Ø=38 TH=4 DRAIN BLACK RUBBER PIPE	60.000	M																			
KTB1001A	BLACK TUBE KIT EPDM 10MT TB1520	<table border="1"> <thead> <tr> <th>Code</th> <th>Description</th> <th>Qty</th> <th>UOM</th> </tr> </thead> <tbody> <tr> <td>TB1520A0</td> <td>Int. Ø=38 TH=4 DRAIN BLACK RUBBER PIPE</td> <td>10.000</td> <td>M</td> </tr> <tr> <td>VM1794A0</td> <td>250x4.8 PA66 BLACK CLAMP</td> <td>3.000</td> <td>PC</td> </tr> </tbody> </table>	Code	Description	Qty	UOM	TB1520A0	Int. Ø=38 TH=4 DRAIN BLACK RUBBER PIPE	10.000	M	VM1794A0	250x4.8 PA66 BLACK CLAMP	3.000	PC								
Code	Description	Qty	UOM																			
TB1520A0	Int. Ø=38 TH=4 DRAIN BLACK RUBBER PIPE	10.000	M																			
VM1794A0	250x4.8 PA66 BLACK CLAMP	3.000	PC																			
KTB1000A	EPDM BLACK TUBE TB1520A 2MT KIT			<table border="1"> <thead> <tr> <th>Code</th> <th>Description</th> <th>Qty</th> <th>UOM</th> </tr> </thead> <tbody> <tr> <td>RC1055A0</td> <td>Ø25-40 H12 STAINLESS STEEL PIPE CLIP</td> <td>2.000</td> <td>PC</td> </tr> </tbody> </table>	Code	Description	Qty	UOM	RC1055A0	Ø25-40 H12 STAINLESS STEEL PIPE CLIP	2.000	PC										
			Code	Description	Qty	UOM																
RC1055A0	Ø25-40 H12 STAINLESS STEEL PIPE CLIP	2.000	PC																			
	<table border="1"> <thead> <tr> <th>Code</th> <th>Description</th> <th>Qty</th> <th>UOM</th> </tr> </thead> <tbody> <tr> <td>TB1520A0</td> <td>Int. Ø=38 TH=4 DRAIN BLACK RUBBER PIPE</td> <td>2.000</td> <td>M</td> </tr> </tbody> </table>	Code	Description	Qty	UOM	TB1520A0	Int. Ø=38 TH=4 DRAIN BLACK RUBBER PIPE	2.000	M													
Code	Description	Qty	UOM																			
TB1520A0	Int. Ø=38 TH=4 DRAIN BLACK RUBBER PIPE	2.000	M																			

COMPONENT			SPARE PART																										
Code	Description	Image	Code	Description	Kit components																								
TB2603A	TB1520A0- VENTURI FAN 0,12M		KTB2603A	VENTURI-COOLING FAN CONNECT. KIT TB1520A	<table border="1"> <thead> <tr> <th>Code</th> <th>Description</th> <th>Qty</th> <th>UOM</th> </tr> </thead> <tbody> <tr> <td>TB1520A0</td> <td>Int. Ø=38 TH=4</td> <td>0.120</td> <td>M</td> </tr> <tr> <td></td> <td>DRAIN BLACK</td> <td></td> <td></td> </tr> <tr> <td></td> <td>RUBBER PIPE</td> <td></td> <td></td> </tr> </tbody> </table>	Code	Description	Qty	UOM	TB1520A0	Int. Ø=38 TH=4	0.120	M		DRAIN BLACK				RUBBER PIPE										
Code	Description	Qty	UOM																										
TB1520A0	Int. Ø=38 TH=4	0.120	M																										
	DRAIN BLACK																												
	RUBBER PIPE																												
TB2957B	XEVC-0511-E VENTURI PIPE		KTB2957B	0511/04EU-E VENTURI COLLECTOR PIPE KI	<table border="1"> <thead> <tr> <th>Code</th> <th>Description</th> <th>Qty</th> <th>UOM</th> </tr> </thead> <tbody> <tr> <td>GN1544A0</td> <td>AIR INLET GASKET</td> <td>1.000</td> <td>PC</td> </tr> <tr> <td>GN1584A0</td> <td>CORNER FITTING D30-D16</td> <td>1.000</td> <td>PC</td> </tr> <tr> <td>RC1042A0</td> <td>DOUBLE WIRE SPRING CLAMP D21.5-22.6</td> <td>1.000</td> <td>PC</td> </tr> <tr> <td>TB2957B0</td> <td>XEVC-0511-E VENTURI PIPE</td> <td>1.000</td> <td>PC</td> </tr> <tr> <td>VM1794A0</td> <td>250x4.8 PA66 BLACK CLAMP</td> <td>1.000</td> <td>PC</td> </tr> </tbody> </table>	Code	Description	Qty	UOM	GN1544A0	AIR INLET GASKET	1.000	PC	GN1584A0	CORNER FITTING D30-D16	1.000	PC	RC1042A0	DOUBLE WIRE SPRING CLAMP D21.5-22.6	1.000	PC	TB2957B0	XEVC-0511-E VENTURI PIPE	1.000	PC	VM1794A0	250x4.8 PA66 BLACK CLAMP	1.000	PC
Code	Description	Qty	UOM																										
GN1544A0	AIR INLET GASKET	1.000	PC																										
GN1584A0	CORNER FITTING D30-D16	1.000	PC																										
RC1042A0	DOUBLE WIRE SPRING CLAMP D21.5-22.6	1.000	PC																										
TB2957B0	XEVC-0511-E VENTURI PIPE	1.000	PC																										
VM1794A0	250x4.8 PA66 BLACK CLAMP	1.000	PC																										
VM2377A	220 V 50/60 HZ VENTURI SET		KVM2377A	MM 220 V VENTURI ACTUATOR SYSTEM KIT	<table border="1"> <thead> <tr> <th>Code</th> <th>Description</th> <th>Qty</th> <th>UOM</th> </tr> </thead> <tbody> <tr> <td>RC1378A0</td> <td>HOSE CLAMP</td> <td>3.000</td> <td>PC</td> </tr> <tr> <td>TB1520A0</td> <td>Int. Ø=38 TH=4</td> <td>0.120</td> <td>M</td> </tr> <tr> <td></td> <td>DRAIN BLACK</td> <td></td> <td></td> </tr> <tr> <td></td> <td>RUBBER PIPE</td> <td></td> <td></td> </tr> <tr> <td>VM2377A1</td> <td>220 V 50/60 HZ EUR VENTURI SET</td> <td>1.000</td> <td>PC</td> </tr> </tbody> </table>	Code	Description	Qty	UOM	RC1378A0	HOSE CLAMP	3.000	PC	TB1520A0	Int. Ø=38 TH=4	0.120	M		DRAIN BLACK				RUBBER PIPE			VM2377A1	220 V 50/60 HZ EUR VENTURI SET	1.000	PC
Code	Description	Qty	UOM																										
RC1378A0	HOSE CLAMP	3.000	PC																										
TB1520A0	Int. Ø=38 TH=4	0.120	M																										
	DRAIN BLACK																												
	RUBBER PIPE																												
VM2377A1	220 V 50/60 HZ EUR VENTURI SET	1.000	PC																										
RC1019A	D=10 ELASTIC CLAM		KRC1019A	Ø10 ZINC PLATED ELASTIC CLAMP 15 PCS KIT	<table border="1"> <thead> <tr> <th>Code</th> <th>Description</th> <th>Qty</th> <th>UOM</th> </tr> </thead> <tbody> <tr> <td>RC1019A0</td> <td>D=10 ELASTIC CLAMP</td> <td>15.000</td> <td>PC</td> </tr> </tbody> </table>	Code	Description	Qty	UOM	RC1019A0	D=10 ELASTIC CLAMP	15.000	PC																
Code	Description	Qty	UOM																										
RC1019A0	D=10 ELASTIC CLAMP	15.000	PC																										
VL1037A	WASHING SYSTEM ROTOR ARM		KVL1037A	WASHING SYSTEM ROTOR ARM KIT	<table border="1"> <thead> <tr> <th>Code</th> <th>Description</th> <th>Qty</th> <th>UOM</th> </tr> </thead> <tbody> <tr> <td>VL1037A3</td> <td>WASHING SYSTEM ROTOR ARM</td> <td>1.000</td> <td>PC</td> </tr> </tbody> </table>	Code	Description	Qty	UOM	VL1037A3	WASHING SYSTEM ROTOR ARM	1.000	PC																
Code	Description	Qty	UOM																										
VL1037A3	WASHING SYSTEM ROTOR ARM	1.000	PC																										

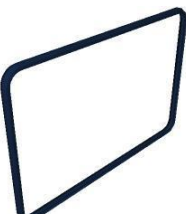

COMPONENT			SPARE PART																		
Code	Description	Image	Code	Description	Kit components																
RC1170A	M14 H=7 CH=22 STAINLESS STEEL NUT		KRC1170A	M14 H8 CH22 NUT - 10 PCS. KIT	<table border="1"> <thead> <tr> <th>Code</th> <th>Description</th> <th>Qty</th> <th>UOM</th> </tr> </thead> <tbody> <tr> <td>RC1170A1</td> <td>M14 H=7 CH=22 STAINLESS STEEL NUT</td> <td>10.000</td> <td>PC</td> </tr> </tbody> </table>	Code	Description	Qty	UOM	RC1170A1	M14 H=7 CH=22 STAINLESS STEEL NUT	10.000	PC								
Code	Description	Qty	UOM																		
RC1170A1	M14 H=7 CH=22 STAINLESS STEEL NUT	10.000	PC																		
TB2937B	XEBC EXTERNAL WATER PIPE D10+CONNECTION		TB2937B0	XEBC EXTERNAL WATER PIPE D10+CONNECTION																	
OH7030A	THERMOSTAT BULB INLET COVER		KOH7030A	THERMOSTAT BULB INLET COVER KIT	<table border="1"> <thead> <tr> <th>Code</th> <th>Description</th> <th>Qty</th> <th>UOM</th> </tr> </thead> <tbody> <tr> <td>OH7030A0</td> <td>THERMOSTAT BULB INLET COVER</td> <td>1.000</td> <td>PC</td> </tr> </tbody> </table>	Code	Description	Qty	UOM	OH7030A0	THERMOSTAT BULB INLET COVER	1.000	PC								
Code	Description	Qty	UOM																		
OH7030A0	THERMOSTAT BULB INLET COVER	1.000	PC																		
GN1632A	CORE PROBE INLET GASKET		GN1632A0	CORE PROBE INLET GASKET																	
GN1629A	GN1626A-0511 DOOR GASKET		KGN1629A	0511 DOOR GASKET KIT	<table border="1"> <thead> <tr> <th>Code</th> <th>Description</th> <th>Qty</th> <th>UOM</th> </tr> </thead> <tbody> <tr> <td>GN1626A0</td> <td>DOUBLE LIP-TYPE FRONT GASKE</td> <td>1.990</td> <td>M</td> </tr> <tr> <td>SL1025A0</td> <td>CLEAR SILICON DOW CORNING 734</td> <td>0.012</td> <td>PC</td> </tr> <tr> <td>VM2277A0</td> <td>DOOR SEAL KIT INTERNAL CONNECTION</td> <td>1.000</td> <td>PC</td> </tr> </tbody> </table>	Code	Description	Qty	UOM	GN1626A0	DOUBLE LIP-TYPE FRONT GASKE	1.990	M	SL1025A0	CLEAR SILICON DOW CORNING 734	0.012	PC	VM2277A0	DOOR SEAL KIT INTERNAL CONNECTION	1.000	PC
Code	Description	Qty	UOM																		
GN1626A0	DOUBLE LIP-TYPE FRONT GASKE	1.990	M																		
SL1025A0	CLEAR SILICON DOW CORNING 734	0.012	PC																		
VM2277A0	DOOR SEAL KIT INTERNAL CONNECTION	1.000	PC																		

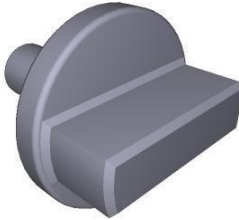

COMPONENT			SPARE PART										
Code	Description	Image	Code	Description	Kit components								
VM1820A	LATERAL SUPPORTS M6 FIXING BOLT		KVM1820A	THUMB SCREW 10PCS KIT	<table border="1"> <thead> <tr> <th>Code</th> <th>Description</th> <th>Qty</th> <th>UOM</th> </tr> </thead> <tbody> <tr> <td>VM1820A0</td> <td>LATERAL SUPPORTS M6 FIXING BOLT</td> <td>10.000</td> <td>PC</td> </tr> </tbody> </table>	Code	Description	Qty	UOM	VM1820A0	LATERAL SUPPORTS M6 FIXING BOLT	10.000	PC
Code	Description	Qty	UOM										
VM1820A0	LATERAL SUPPORTS M6 FIXING BOLT	10.000	PC										
VM2331A	FAN GUARD-TRAYS HOLDER PIN		KVM2331A	FAN GUARD-TRAYS HOLDER PIN 4 PCS KIT	<table border="1"> <thead> <tr> <th>Code</th> <th>Description</th> <th>Qty</th> <th>UOM</th> </tr> </thead> <tbody> <tr> <td>VM2331A0</td> <td>FAN GUARD-TRAY S HOLDER PIN</td> <td>4.000</td> <td>PC</td> </tr> </tbody> </table>	Code	Description	Qty	UOM	VM2331A0	FAN GUARD-TRAY S HOLDER PIN	4.000	PC
Code	Description	Qty	UOM										
VM2331A0	FAN GUARD-TRAY S HOLDER PIN	4.000	PC										



ASM2916C/0.D01 - External cover

FRONT





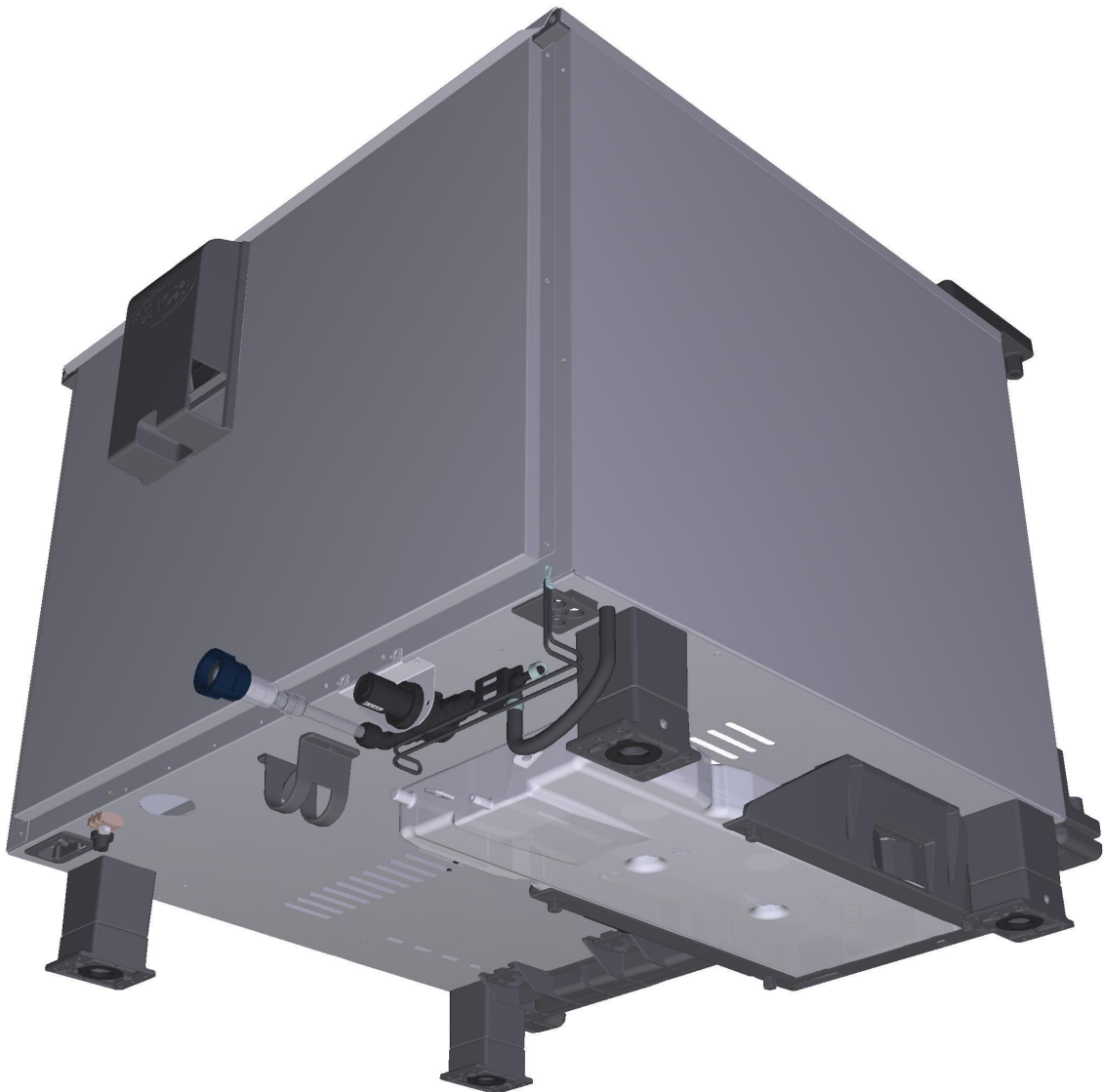

ASM2916C/0.D01 - External cover



REAR





COMPONENT			SPARE PART		
Code	Description	Image	Code	Description	Kit components
0D2295A	GN1-1 XEVC EXTERNAL COVER		0D2295A0	GN1-1 XEVC EXTERNAL COVER	
0D2298A	XEVC-0511 LEFT SIDE PANEL		0D2298A3	XEVC-0511 EXTERNAL LEFT SID	
0D2299A	XEVC-0511 EXTERNAL RIGHT SIDE		0D2299A3	XEVC-0511 EXTERNAL RIGHT SIDE	
0E1350C	GN1-1 XEVC EXTERNAL BOTTOM PANEL		0E1350C0	GN1-1 XEVC EXTERNAL BOTTOM PANEL	
0F1496A	XEVC-0511-E BACK PANEL		0F1496A0	XEVC-0511-E BACK PANEL	

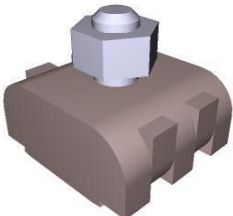



COMPONENT			SPARE PART																						
Code	Description	Image	Code	Description	Kit components																				
0H7291A	CHIMNEY HOLDING DISC		KVP1168A	CHIMNEY SEALING RING KIT	<table border="1"> <thead> <tr> <th>Code</th> <th>Description</th> <th>Qty</th> <th>UOM</th> </tr> </thead> <tbody> <tr> <td>VI1220A1</td> <td>4,2x12 TCB SELF-TAPPIN G SCREW</td> <td>3.000</td> <td>PC</td> </tr> <tr> <td>VP1168A0</td> <td></td> <td>1.000</td> <td>PC</td> </tr> </tbody> </table>	Code	Description	Qty	UOM	VI1220A1	4,2x12 TCB SELF-TAPPIN G SCREW	3.000	PC	VP1168A0		1.000	PC								
					Code	Description	Qty	UOM																	
VI1220A1	4,2x12 TCB SELF-TAPPIN G SCREW	3.000	PC																						
VP1168A0		1.000	PC																						
<table border="1"> <thead> <tr> <th>Code</th> <th>Description</th> <th>Qty</th> <th>UOM</th> </tr> </thead> <tbody> <tr> <td>VI1040A0</td> <td>INDENTED INTERNAL WASHER D=6 ZN</td> <td>2.000</td> <td>PC</td> </tr> <tr> <td>VM1750A0</td> <td>BRASS COMB CLAMP</td> <td>1.000</td> <td>PC</td> </tr> </tbody> </table>	Code	Description	Qty	UOM	VI1040A0	INDENTED INTERNAL WASHER D=6 ZN	2.000	PC	VM1750A0	BRASS COMB CLAMP	1.000	PC													
Code	Description	Qty	UOM																						
VI1040A0	INDENTED INTERNAL WASHER D=6 ZN	2.000	PC																						
VM1750A0	BRASS COMB CLAMP	1.000	PC																						
VM1750A	BRASS COMB CLAM		KVM1750A	COMB TERMINAL BLOCK KIT	<table border="1"> <thead> <tr> <th>Code</th> <th>Description</th> <th>Qty</th> <th>UOM</th> </tr> </thead> <tbody> <tr> <td>VI0239A1</td> <td>SELF-TAPPIN G SCREW 4.2X25 TCB+ INOX</td> <td>2.000</td> <td>PC</td> </tr> <tr> <td>VI1220A1</td> <td>4,2x12 TCB SELF-TAPPIN G SCREW</td> <td>2.000</td> <td>PC</td> </tr> <tr> <td>VM1460A0</td> <td>XBC/XVC RIGHT DOOR LATCH CAP</td> <td>1.000</td> <td>PC</td> </tr> <tr> <td>VP1530A0</td> <td></td> <td>1.000</td> <td>PC</td> </tr> </tbody> </table>	Code	Description	Qty	UOM	VI0239A1	SELF-TAPPIN G SCREW 4.2X25 TCB+ INOX	2.000	PC	VI1220A1	4,2x12 TCB SELF-TAPPIN G SCREW	2.000	PC	VM1460A0	XBC/XVC RIGHT DOOR LATCH CAP	1.000	PC	VP1530A0		1.000	PC
					Code	Description	Qty	UOM																	
VI0239A1	SELF-TAPPIN G SCREW 4.2X25 TCB+ INOX	2.000	PC																						
VI1220A1	4,2x12 TCB SELF-TAPPIN G SCREW	2.000	PC																						
VM1460A0	XBC/XVC RIGHT DOOR LATCH CAP	1.000	PC																						
VP1530A0		1.000	PC																						
<table border="1"> <thead> <tr> <th>Code</th> <th>Description</th> <th>Qty</th> <th>UOM</th> </tr> </thead> <tbody> <tr> <td>VI0239A1</td> <td>SELF-TAPPIN G SCREW 4.2X25 TCB+ INOX</td> <td>2.000</td> <td>PC</td> </tr> <tr> <td>VI1220A1</td> <td>4,2x12 TCB SELF-TAPPIN G SCREW</td> <td>2.000</td> <td>PC</td> </tr> <tr> <td>VM1460A0</td> <td>XBC/XVC RIGHT DOOR LATCH CAP</td> <td>1.000</td> <td>PC</td> </tr> <tr> <td>VP1531A0</td> <td></td> <td>1.000</td> <td>PC</td> </tr> </tbody> </table>	Code	Description	Qty	UOM	VI0239A1	SELF-TAPPIN G SCREW 4.2X25 TCB+ INOX	2.000	PC	VI1220A1	4,2x12 TCB SELF-TAPPIN G SCREW	2.000	PC	VM1460A0	XBC/XVC RIGHT DOOR LATCH CAP	1.000	PC	VP1531A0		1.000	PC					
Code	Description	Qty	UOM																						
VI0239A1	SELF-TAPPIN G SCREW 4.2X25 TCB+ INOX	2.000	PC																						
VI1220A1	4,2x12 TCB SELF-TAPPIN G SCREW	2.000	PC																						
VM1460A0	XBC/XVC RIGHT DOOR LATCH CAP	1.000	PC																						
VP1531A0		1.000	PC																						
VM1190A	CT BT RIGHT DOOR SPRING LATCH		KVM1190A	CHEFTOP/BAKERTO P DOOR RIGHT LATCH KIT	<table border="1"> <thead> <tr> <th>Code</th> <th>Description</th> <th>Qty</th> <th>UOM</th> </tr> </thead> <tbody> <tr> <td>VI0239A1</td> <td>SELF-TAPPIN G SCREW 4.2X25 TCB+ INOX</td> <td>2.000</td> <td>PC</td> </tr> <tr> <td>VI1220A1</td> <td>4,2x12 TCB SELF-TAPPIN G SCREW</td> <td>2.000</td> <td>PC</td> </tr> <tr> <td>VM1460A0</td> <td>XBC/XVC RIGHT DOOR LATCH CAP</td> <td>1.000</td> <td>PC</td> </tr> <tr> <td>VP1530A0</td> <td></td> <td>1.000</td> <td>PC</td> </tr> </tbody> </table>	Code	Description	Qty	UOM	VI0239A1	SELF-TAPPIN G SCREW 4.2X25 TCB+ INOX	2.000	PC	VI1220A1	4,2x12 TCB SELF-TAPPIN G SCREW	2.000	PC	VM1460A0	XBC/XVC RIGHT DOOR LATCH CAP	1.000	PC	VP1530A0		1.000	PC
					Code	Description	Qty	UOM																	
VI0239A1	SELF-TAPPIN G SCREW 4.2X25 TCB+ INOX	2.000	PC																						
VI1220A1	4,2x12 TCB SELF-TAPPIN G SCREW	2.000	PC																						
VM1460A0	XBC/XVC RIGHT DOOR LATCH CAP	1.000	PC																						
VP1530A0		1.000	PC																						
<table border="1"> <thead> <tr> <th>Code</th> <th>Description</th> <th>Qty</th> <th>UOM</th> </tr> </thead> <tbody> <tr> <td>VI0239A1</td> <td>SELF-TAPPIN G SCREW 4.2X25 TCB+ INOX</td> <td>2.000</td> <td>PC</td> </tr> <tr> <td>VI1220A1</td> <td>4,2x12 TCB SELF-TAPPIN G SCREW</td> <td>2.000</td> <td>PC</td> </tr> <tr> <td>VM1460A0</td> <td>XBC/XVC RIGHT DOOR LATCH CAP</td> <td>1.000</td> <td>PC</td> </tr> <tr> <td>VP1531A0</td> <td></td> <td>1.000</td> <td>PC</td> </tr> </tbody> </table>	Code	Description	Qty	UOM	VI0239A1	SELF-TAPPIN G SCREW 4.2X25 TCB+ INOX	2.000	PC	VI1220A1	4,2x12 TCB SELF-TAPPIN G SCREW	2.000	PC	VM1460A0	XBC/XVC RIGHT DOOR LATCH CAP	1.000	PC	VP1531A0		1.000	PC					
Code	Description	Qty	UOM																						
VI0239A1	SELF-TAPPIN G SCREW 4.2X25 TCB+ INOX	2.000	PC																						
VI1220A1	4,2x12 TCB SELF-TAPPIN G SCREW	2.000	PC																						
VM1460A0	XBC/XVC RIGHT DOOR LATCH CAP	1.000	PC																						
VP1531A0		1.000	PC																						
VM1192A	CT BT DOOR SPRING LATCH BACK COVER		KVM1191A	CHEFTOP/BAKERTO P DOOR LEFT LATCH KIT	<table border="1"> <thead> <tr> <th>Code</th> <th>Description</th> <th>Qty</th> <th>UOM</th> </tr> </thead> <tbody> <tr> <td>VI0239A1</td> <td>SELF-TAPPIN G SCREW 4.2X25 TCB+ INOX</td> <td>2.000</td> <td>PC</td> </tr> <tr> <td>VI1220A1</td> <td>4,2x12 TCB SELF-TAPPIN G SCREW</td> <td>2.000</td> <td>PC</td> </tr> <tr> <td>VM1460A0</td> <td>XBC/XVC RIGHT DOOR LATCH CAP</td> <td>1.000</td> <td>PC</td> </tr> <tr> <td>VP1531A0</td> <td></td> <td>1.000</td> <td>PC</td> </tr> </tbody> </table>	Code	Description	Qty	UOM	VI0239A1	SELF-TAPPIN G SCREW 4.2X25 TCB+ INOX	2.000	PC	VI1220A1	4,2x12 TCB SELF-TAPPIN G SCREW	2.000	PC	VM1460A0	XBC/XVC RIGHT DOOR LATCH CAP	1.000	PC	VP1531A0		1.000	PC
					Code	Description	Qty	UOM																	
VI0239A1	SELF-TAPPIN G SCREW 4.2X25 TCB+ INOX	2.000	PC																						
VI1220A1	4,2x12 TCB SELF-TAPPIN G SCREW	2.000	PC																						
VM1460A0	XBC/XVC RIGHT DOOR LATCH CAP	1.000	PC																						
VP1531A0		1.000	PC																						
<table border="1"> <thead> <tr> <th>Code</th> <th>Description</th> <th>Qty</th> <th>UOM</th> </tr> </thead> <tbody> <tr> <td>VI0239A1</td> <td>SELF-TAPPIN G SCREW 4.2X25 TCB+ INOX</td> <td>2.000</td> <td>PC</td> </tr> <tr> <td>VI1220A1</td> <td>4,2x12 TCB SELF-TAPPIN G SCREW</td> <td>2.000</td> <td>PC</td> </tr> </tbody> </table>	Code	Description	Qty	UOM	VI0239A1	SELF-TAPPIN G SCREW 4.2X25 TCB+ INOX	2.000	PC	VI1220A1	4,2x12 TCB SELF-TAPPIN G SCREW	2.000	PC													
Code	Description	Qty	UOM																						
VI0239A1	SELF-TAPPIN G SCREW 4.2X25 TCB+ INOX	2.000	PC																						
VI1220A1	4,2x12 TCB SELF-TAPPIN G SCREW	2.000	PC																						
VM1192A	CT BT DOOR SPRING LATCH BACK COVER		KVM1190A	CHEFTOP/BAKERTO P DOOR RIGHT LATCH KIT	<table border="1"> <thead> <tr> <th>Code</th> <th>Description</th> <th>Qty</th> <th>UOM</th> </tr> </thead> <tbody> <tr> <td>VI0239A1</td> <td>SELF-TAPPIN G SCREW 4.2X25 TCB+ INOX</td> <td>2.000</td> <td>PC</td> </tr> <tr> <td>VI1220A1</td> <td>4,2x12 TCB SELF-TAPPIN G SCREW</td> <td>2.000</td> <td>PC</td> </tr> </tbody> </table>	Code	Description	Qty	UOM	VI0239A1	SELF-TAPPIN G SCREW 4.2X25 TCB+ INOX	2.000	PC	VI1220A1	4,2x12 TCB SELF-TAPPIN G SCREW	2.000	PC								
					Code	Description	Qty	UOM																	
VI0239A1	SELF-TAPPIN G SCREW 4.2X25 TCB+ INOX	2.000	PC																						
VI1220A1	4,2x12 TCB SELF-TAPPIN G SCREW	2.000	PC																						
<table border="1"> <thead> <tr> <th>Code</th> <th>Description</th> <th>Qty</th> <th>UOM</th> </tr> </thead> <tbody> <tr> <td>VI0239A1</td> <td>SELF-TAPPIN G SCREW 4.2X25 TCB+ INOX</td> <td>2.000</td> <td>PC</td> </tr> <tr> <td>VI1220A1</td> <td>4,2x12 TCB SELF-TAPPIN G SCREW</td> <td>2.000</td> <td>PC</td> </tr> </tbody> </table>	Code	Description	Qty	UOM	VI0239A1	SELF-TAPPIN G SCREW 4.2X25 TCB+ INOX	2.000	PC	VI1220A1	4,2x12 TCB SELF-TAPPIN G SCREW	2.000	PC													
Code	Description	Qty	UOM																						
VI0239A1	SELF-TAPPIN G SCREW 4.2X25 TCB+ INOX	2.000	PC																						
VI1220A1	4,2x12 TCB SELF-TAPPIN G SCREW	2.000	PC																						



COMPONENT			SPARE PART																						
Code	Description	Image	Code	Description	Kit components																				
VM1192A	CT BT DOOR SPRING LATCH BACK COVER		KVM1190A	CHEFTOP/BAKERTO P DOOR RIGHT LATCH KIT	<table border="1"> <thead> <tr> <th>Code</th> <th>Description</th> <th>Qty</th> <th>UOM</th> </tr> </thead> <tbody> <tr> <td>VM1460A0</td> <td>XBC/XVC RIGHT DOOR LATCH CAP</td> <td>1.000</td> <td>PC</td> </tr> <tr> <td>VP1530A0</td> <td></td> <td>1.000</td> <td>PC</td> </tr> </tbody> </table>	Code	Description	Qty	UOM	VM1460A0	XBC/XVC RIGHT DOOR LATCH CAP	1.000	PC	VP1530A0		1.000	PC								
Code	Description	Qty	UOM																						
VM1460A0	XBC/XVC RIGHT DOOR LATCH CAP	1.000	PC																						
VP1530A0		1.000	PC																						
VM1630A	INTERNAL GLASS PUSHING CAP		KVM1630A	CAP FOR INTERNAL GLASS 10 PCS KIT	<table border="1"> <thead> <tr> <th>Code</th> <th>Description</th> <th>Qty</th> <th>UOM</th> </tr> </thead> <tbody> <tr> <td>VM1630A1</td> <td>INTERNAL GLASS PUSHING CAP</td> <td>10.000</td> <td>PC</td> </tr> </tbody> </table>	Code	Description	Qty	UOM	VM1630A1	INTERNAL GLASS PUSHING CAP	10.000	PC												
Code	Description	Qty	UOM																						
VM1630A1	INTERNAL GLASS PUSHING CAP	10.000	PC																						
VM2280B	HANDLE LATCH PLATE COVER		KVM2280B	VM2280B -M HANDLE LATCH PLATE COVER KIT	<table border="1"> <thead> <tr> <th>Code</th> <th>Description</th> <th>Qty</th> <th>UOM</th> </tr> </thead> <tbody> <tr> <td>VI1074A0</td> <td>4X16 SCREW FOR PLASTIC</td> <td>2.000</td> <td>PC</td> </tr> <tr> <td>VM1630A1</td> <td>INTERNAL GLASS PUSHING CAP</td> <td>2.000</td> <td>PC</td> </tr> <tr> <td>VM2280B0</td> <td>HANDLE LATCH PLATE COVER</td> <td>1.000</td> <td>PC</td> </tr> </tbody> </table>	Code	Description	Qty	UOM	VI1074A0	4X16 SCREW FOR PLASTIC	2.000	PC	VM1630A1	INTERNAL GLASS PUSHING CAP	2.000	PC	VM2280B0	HANDLE LATCH PLATE COVER	1.000	PC				
Code	Description	Qty	UOM																						
VI1074A0	4X16 SCREW FOR PLASTIC	2.000	PC																						
VM1630A1	INTERNAL GLASS PUSHING CAP	2.000	PC																						
VM2280B0	HANDLE LATCH PLATE COVER	1.000	PC																						
VM1191A	CT BT LEFT DOOR SPRING LATCH		KVM1191A	CHEFTOP/BAKERTO P DOOR LEFT LATCH KIT	<table border="1"> <thead> <tr> <th>Code</th> <th>Description</th> <th>Qty</th> <th>UOM</th> </tr> </thead> <tbody> <tr> <td>VI0239A1</td> <td>SELF-TAPPIN G SCREW 4.2X25 TCB+ INOX</td> <td>2.000</td> <td>PC</td> </tr> <tr> <td>VI1220A1</td> <td>4,2x12 TCB SELF-TAPPIN G SCREW</td> <td>2.000</td> <td>PC</td> </tr> <tr> <td>VM1460A0</td> <td>XBC/XVC RIGHT DOOR LATCH CAP</td> <td>1.000</td> <td>PC</td> </tr> <tr> <td>VP1531A0</td> <td></td> <td>1.000</td> <td>PC</td> </tr> </tbody> </table>	Code	Description	Qty	UOM	VI0239A1	SELF-TAPPIN G SCREW 4.2X25 TCB+ INOX	2.000	PC	VI1220A1	4,2x12 TCB SELF-TAPPIN G SCREW	2.000	PC	VM1460A0	XBC/XVC RIGHT DOOR LATCH CAP	1.000	PC	VP1531A0		1.000	PC
Code	Description	Qty	UOM																						
VI0239A1	SELF-TAPPIN G SCREW 4.2X25 TCB+ INOX	2.000	PC																						
VI1220A1	4,2x12 TCB SELF-TAPPIN G SCREW	2.000	PC																						
VM1460A0	XBC/XVC RIGHT DOOR LATCH CAP	1.000	PC																						
VP1531A0		1.000	PC																						
VM1192A	CT BT DOOR SPRING LATCH BACK COVER		KVM1191A	CHEFTOP/BAKERTO P DOOR LEFT LATCH KIT	<table border="1"> <thead> <tr> <th>Code</th> <th>Description</th> <th>Qty</th> <th>UOM</th> </tr> </thead> <tbody> <tr> <td>VI0239A1</td> <td>SELF-TAPPIN G SCREW 4.2X25 TCB+ INOX</td> <td>2.000</td> <td>PC</td> </tr> <tr> <td>VI1220A1</td> <td>4,2x12 TCB SELF-TAPPIN G SCREW</td> <td>2.000</td> <td>PC</td> </tr> <tr> <td>VM1460A0</td> <td>XBC/XVC RIGHT DOOR LATCH CAP</td> <td>1.000</td> <td>PC</td> </tr> <tr> <td>VP1531A0</td> <td></td> <td>1.000</td> <td>PC</td> </tr> </tbody> </table>	Code	Description	Qty	UOM	VI0239A1	SELF-TAPPIN G SCREW 4.2X25 TCB+ INOX	2.000	PC	VI1220A1	4,2x12 TCB SELF-TAPPIN G SCREW	2.000	PC	VM1460A0	XBC/XVC RIGHT DOOR LATCH CAP	1.000	PC	VP1531A0		1.000	PC
Code	Description	Qty	UOM																						
VI0239A1	SELF-TAPPIN G SCREW 4.2X25 TCB+ INOX	2.000	PC																						
VI1220A1	4,2x12 TCB SELF-TAPPIN G SCREW	2.000	PC																						
VM1460A0	XBC/XVC RIGHT DOOR LATCH CAP	1.000	PC																						
VP1531A0		1.000	PC																						



COMPONENT			SPARE PART																						
Code	Description	Image	Code	Description	Kit components																				
VM1192A	CT BT DOOR SPRING LATCH BACK COVER		KVM1190A	CHEFTOP/BAKERTO P DOOR RIGHT LATCH KIT	<table border="1"> <thead> <tr> <th>Code</th> <th>Description</th> <th>Qty</th> <th>UOM</th> </tr> </thead> <tbody> <tr> <td>VI0239A1</td> <td>SELF-TAPPIN G SCREW 4.2X25 TCB+ INOX</td> <td>2.000</td> <td>PC</td> </tr> <tr> <td>VI1220A1</td> <td>4.2x12 TCB SELF-TAPPIN G SCREW</td> <td>2.000</td> <td>PC</td> </tr> <tr> <td>VM1460A0</td> <td>XBC/XVC RIGHT DOOR LATCH CAP</td> <td>1.000</td> <td>PC</td> </tr> <tr> <td>VP1530A0</td> <td></td> <td>1.000</td> <td>PC</td> </tr> </tbody> </table>	Code	Description	Qty	UOM	VI0239A1	SELF-TAPPIN G SCREW 4.2X25 TCB+ INOX	2.000	PC	VI1220A1	4.2x12 TCB SELF-TAPPIN G SCREW	2.000	PC	VM1460A0	XBC/XVC RIGHT DOOR LATCH CAP	1.000	PC	VP1530A0		1.000	PC
					Code	Description	Qty	UOM																	
					VI0239A1	SELF-TAPPIN G SCREW 4.2X25 TCB+ INOX	2.000	PC																	
					VI1220A1	4.2x12 TCB SELF-TAPPIN G SCREW	2.000	PC																	
VM1460A0	XBC/XVC RIGHT DOOR LATCH CAP	1.000	PC																						
VP1530A0		1.000	PC																						
VM2281A	DOOR LATCH HOLES COVER		KVM2281A	HOLE PLATE COVER KIT	<table border="1"> <thead> <tr> <th>Code</th> <th>Description</th> <th>Qty</th> <th>UOM</th> </tr> </thead> <tbody> <tr> <td>VM2281A0</td> <td>DOOR LATCH HOLES COVER</td> <td>1.000</td> <td>PC</td> </tr> </tbody> </table>	Code	Description	Qty	UOM	VM2281A0	DOOR LATCH HOLES COVER	1.000	PC												
					Code	Description	Qty	UOM																	
VM2281A0	DOOR LATCH HOLES COVER	1.000	PC																						
SB1015A	4L DETERGENT TAN		KSB1015A	4L DETERGENT TANK KIT	<table border="1"> <thead> <tr> <th>Code</th> <th>Description</th> <th>Qty</th> <th>UOM</th> </tr> </thead> <tbody> <tr> <td>SB1015A2</td> <td>4L DETERGENT TANK</td> <td>1.000</td> <td>PC</td> </tr> </tbody> </table>	Code	Description	Qty	UOM	SB1015A2	4L DETERGENT TANK	1.000	PC												
					Code	Description	Qty	UOM																	
SB1015A2	4L DETERGENT TANK	1.000	PC																						
VM1118A	DET&Rinse PLUS TANK LEFT GUIDE		KVM1118A	DET&RINSE TANK LEFT GUIDE KIT FOR MM	<table border="1"> <thead> <tr> <th>Code</th> <th>Description</th> <th>Qty</th> <th>UOM</th> </tr> </thead> <tbody> <tr> <td>VI1220A1</td> <td>4.2x12 TCB SELF-TAPPIN G SCREW</td> <td>2.000</td> <td>PC</td> </tr> <tr> <td>VM1118A0</td> <td>DET&Rinse PLUS TANK LEFT GUIDE</td> <td>1.000</td> <td>PC</td> </tr> </tbody> </table>	Code	Description	Qty	UOM	VI1220A1	4.2x12 TCB SELF-TAPPIN G SCREW	2.000	PC	VM1118A0	DET&Rinse PLUS TANK LEFT GUIDE	1.000	PC								
					Code	Description	Qty	UOM																	
VI1220A1	4.2x12 TCB SELF-TAPPIN G SCREW	2.000	PC																						
VM1118A0	DET&Rinse PLUS TANK LEFT GUIDE	1.000	PC																						
VM1119A	DET&Rinse PLUS TANK RIGHT GUIDE		KVM1119A	DET&RINSE TANK RIGHT GUIDE KIT FOR MM	<table border="1"> <thead> <tr> <th>Code</th> <th>Description</th> <th>Qty</th> <th>UOM</th> </tr> </thead> <tbody> <tr> <td>VI1220A1</td> <td>4.2x12 TCB SELF-TAPPIN G SCREW</td> <td>2.000</td> <td>PC</td> </tr> <tr> <td>VM1119A0</td> <td>DET&Rinse PLUS TANK RIGHT GUIDE</td> <td>1.000</td> <td>PC</td> </tr> </tbody> </table>	Code	Description	Qty	UOM	VI1220A1	4.2x12 TCB SELF-TAPPIN G SCREW	2.000	PC	VM1119A0	DET&Rinse PLUS TANK RIGHT GUIDE	1.000	PC								
					Code	Description	Qty	UOM																	
VI1220A1	4.2x12 TCB SELF-TAPPIN G SCREW	2.000	PC																						
VM1119A0	DET&Rinse PLUS TANK RIGHT GUIDE	1.000	PC																						





COMPONENT			SPARE PART																																							
Code	Description	Image	Code	Description	Kit components																																					
VL1014B	PRESSURE REDUCER WITH DISTRIBUTOR		KVL0014A	MM ≤2016 / LUX<2019 PRESSURE REDUCER KIT	<table border="1"> <thead> <tr> <th>Code</th> <th>Description</th> <th>Qty</th> <th>UOM</th> </tr> </thead> <tbody> <tr> <td>RC1372A0</td> <td>Ø10M-1/4 M CIL. STRAIGHT FITTING</td> <td>2.000</td> <td>PC</td> </tr> <tr> <td>VL1014B2</td> <td>PRESSURE REDUCER WITH DISTRIBUTOR</td> <td>1.000</td> <td>PC</td> </tr> <tr> <td>VM1054A0</td> <td>H7.8 PRESSURE REDUCER RING NUT</td> <td>1.000</td> <td>PC</td> </tr> </tbody> </table>	Code	Description	Qty	UOM	RC1372A0	Ø10M-1/4 M CIL. STRAIGHT FITTING	2.000	PC	VL1014B2	PRESSURE REDUCER WITH DISTRIBUTOR	1.000	PC	VM1054A0	H7.8 PRESSURE REDUCER RING NUT	1.000	PC																					
			Code	Description	Qty	UOM																																				
RC1372A0	Ø10M-1/4 M CIL. STRAIGHT FITTING	2.000	PC																																							
VL1014B2	PRESSURE REDUCER WITH DISTRIBUTOR	1.000	PC																																							
VM1054A0	H7.8 PRESSURE REDUCER RING NUT	1.000	PC																																							
KVL0010A	S.4 - 5 WATER PRESSURE REDUCER KIT	<table border="1"> <thead> <tr> <th>Code</th> <th>Description</th> <th>Qty</th> <th>UOM</th> </tr> </thead> <tbody> <tr> <td>EL1210A0</td> <td>D8-BSP1/4 JG STRAIGHT END CONNECTION</td> <td>2.000</td> <td>PC</td> </tr> <tr> <td>VL1014B2</td> <td>PRESSURE REDUCER WITH DISTRIBUTOR</td> <td>1.000</td> <td>PC</td> </tr> </tbody> </table>	Code	Description	Qty	UOM	EL1210A0	D8-BSP1/4 JG STRAIGHT END CONNECTION	2.000	PC	VL1014B2	PRESSURE REDUCER WITH DISTRIBUTOR	1.000	PC																												
Code	Description	Qty	UOM																																							
EL1210A0	D8-BSP1/4 JG STRAIGHT END CONNECTION	2.000	PC																																							
VL1014B2	PRESSURE REDUCER WITH DISTRIBUTOR	1.000	PC																																							
VM1054A	H7.8 PRESSURE REDUCER RING NUT		KVM1054A	H7.8 PRESSURE REDUCER DIAL KIT	<table border="1"> <thead> <tr> <th>Code</th> <th>Description</th> <th>Qty</th> <th>UOM</th> </tr> </thead> <tbody> <tr> <td>VM1054A0</td> <td>H7.8 PRESSURE REDUCER RING NUT</td> <td>1.000</td> <td>PC</td> </tr> </tbody> </table>	Code	Description	Qty	UOM	VM1054A0	H7.8 PRESSURE REDUCER RING NUT	1.000	PC																													
			Code	Description	Qty	UOM																																				
VM1054A0	H7.8 PRESSURE REDUCER RING NUT	1.000	PC																																							
KVL1117A	EUR MM 2016+LMT FILTER+PRESS. RED. KIT	<table border="1"> <thead> <tr> <th>Code</th> <th>Description</th> <th>Qty</th> <th>UOM</th> </tr> </thead> <tbody> <tr> <td>0H7472A1</td> <td>DISTRIBUTOR SUPPORT PLATE</td> <td>1.000</td> <td>PC</td> </tr> <tr> <td>RC1004A0</td> <td>Ø10-Ø8.8 Y CONNECTION</td> <td>1.000</td> <td>PC</td> </tr> <tr> <td>RC1243A0</td> <td>Ø10F-Ø10M ELBOW CONNECTION + JG END KIT</td> <td>1.000</td> <td>PC</td> </tr> <tr> <td>RC1372A0</td> <td>Ø10M-1/4 M CIL. STRAIGHT FITTING</td> <td>2.000</td> <td>PC</td> </tr> <tr> <td>VI1220A1</td> <td>4,2x12 TCB SELF-TAPPING SCREW</td> <td>4.000</td> <td>PC</td> </tr> <tr> <td>VL1014B2</td> <td>PRESSURE REDUCER WITH DISTRIBUTOR</td> <td>1.000</td> <td>PC</td> </tr> <tr> <td>VL1034C0</td> <td>MESH WATER FILTER D10</td> <td>1.000</td> <td>PC</td> </tr> <tr> <td>VL1062C0</td> <td>PRESSURE REDUCER-FILTER LOCKING FORK</td> <td>1.000</td> <td>PC</td> </tr> <tr> <td>VM1054A0</td> <td>H7.8 PRESSURE REDUCER RING NUT</td> <td>1.000</td> <td>PC</td> </tr> </tbody> </table>	Code	Description	Qty	UOM	0H7472A1	DISTRIBUTOR SUPPORT PLATE	1.000	PC	RC1004A0	Ø10-Ø8.8 Y CONNECTION	1.000	PC	RC1243A0	Ø10F-Ø10M ELBOW CONNECTION + JG END KIT	1.000	PC	RC1372A0	Ø10M-1/4 M CIL. STRAIGHT FITTING	2.000	PC	VI1220A1	4,2x12 TCB SELF-TAPPING SCREW	4.000	PC	VL1014B2	PRESSURE REDUCER WITH DISTRIBUTOR	1.000	PC	VL1034C0	MESH WATER FILTER D10	1.000	PC	VL1062C0	PRESSURE REDUCER-FILTER LOCKING FORK	1.000	PC	VM1054A0	H7.8 PRESSURE REDUCER RING NUT	1.000	PC
Code	Description	Qty	UOM																																							
0H7472A1	DISTRIBUTOR SUPPORT PLATE	1.000	PC																																							
RC1004A0	Ø10-Ø8.8 Y CONNECTION	1.000	PC																																							
RC1243A0	Ø10F-Ø10M ELBOW CONNECTION + JG END KIT	1.000	PC																																							
RC1372A0	Ø10M-1/4 M CIL. STRAIGHT FITTING	2.000	PC																																							
VI1220A1	4,2x12 TCB SELF-TAPPING SCREW	4.000	PC																																							
VL1014B2	PRESSURE REDUCER WITH DISTRIBUTOR	1.000	PC																																							
VL1034C0	MESH WATER FILTER D10	1.000	PC																																							
VL1062C0	PRESSURE REDUCER-FILTER LOCKING FORK	1.000	PC																																							
VM1054A0	H7.8 PRESSURE REDUCER RING NUT	1.000	PC																																							

COMPONENT			SPARE PART																																										
Code	Description	Image	Code	Description	Kit components																																								
RC1243A	Ø10F-Ø10M ELBOW CONNECTION + JG END KIT		KVL1117A	EUR MM 2016+LMT FILTER+PRESS. RED. KIT	<table border="1"> <thead> <tr> <th>Code</th> <th>Description</th> <th>Qty</th> <th>UOM</th> </tr> </thead> <tbody> <tr> <td>0H7472A1</td> <td>DISTRIBUTOR SUPPORT PLATE</td> <td>1.000</td> <td>PC</td> </tr> <tr> <td>RC1004A0</td> <td>Ø10-Ø8-8 Y CONNECTION</td> <td>1.000</td> <td>PC</td> </tr> <tr> <td>RC1243A0</td> <td>Ø10F-Ø10M ELBOW CONNECTION + JG END KIT</td> <td>1.000</td> <td>PC</td> </tr> <tr> <td>RC1372A0</td> <td>Ø10M-1/4 M CIL. STRAIGHT FITTING</td> <td>2.000</td> <td>PC</td> </tr> <tr> <td>VI1220A1</td> <td>4,2x12 TCB SELF-TAPPIN G SCREW</td> <td>4.000</td> <td>PC</td> </tr> <tr> <td>VL1014B2</td> <td>PRESSURE REDUCER WITH DISTRIBUTOR</td> <td>1.000</td> <td>PC</td> </tr> <tr> <td>VL1034C0</td> <td>MESH WATER FILTER D10</td> <td>1.000</td> <td>PC</td> </tr> <tr> <td>VL1062C0</td> <td>PRESSURE REDUCER-FILTER LOCKING FORK</td> <td>1.000</td> <td>PC</td> </tr> <tr> <td>VM1054A0</td> <td>H7.8 PRESSURE REDUCER RING NUT</td> <td>1.000</td> <td>PC</td> </tr> </tbody> </table>	Code	Description	Qty	UOM	0H7472A1	DISTRIBUTOR SUPPORT PLATE	1.000	PC	RC1004A0	Ø10-Ø8-8 Y CONNECTION	1.000	PC	RC1243A0	Ø10F-Ø10M ELBOW CONNECTION + JG END KIT	1.000	PC	RC1372A0	Ø10M-1/4 M CIL. STRAIGHT FITTING	2.000	PC	VI1220A1	4,2x12 TCB SELF-TAPPIN G SCREW	4.000	PC	VL1014B2	PRESSURE REDUCER WITH DISTRIBUTOR	1.000	PC	VL1034C0	MESH WATER FILTER D10	1.000	PC	VL1062C0	PRESSURE REDUCER-FILTER LOCKING FORK	1.000	PC	VM1054A0	H7.8 PRESSURE REDUCER RING NUT	1.000	PC
			Code	Description	Qty	UOM																																							
0H7472A1	DISTRIBUTOR SUPPORT PLATE	1.000	PC																																										
RC1004A0	Ø10-Ø8-8 Y CONNECTION	1.000	PC																																										
RC1243A0	Ø10F-Ø10M ELBOW CONNECTION + JG END KIT	1.000	PC																																										
RC1372A0	Ø10M-1/4 M CIL. STRAIGHT FITTING	2.000	PC																																										
VI1220A1	4,2x12 TCB SELF-TAPPIN G SCREW	4.000	PC																																										
VL1014B2	PRESSURE REDUCER WITH DISTRIBUTOR	1.000	PC																																										
VL1034C0	MESH WATER FILTER D10	1.000	PC																																										
VL1062C0	PRESSURE REDUCER-FILTER LOCKING FORK	1.000	PC																																										
VM1054A0	H7.8 PRESSURE REDUCER RING NUT	1.000	PC																																										
KRC1243A	Ø10F-Ø10M ELBOW CONN + JG END 10 PCS KIT	<table border="1"> <thead> <tr> <th>Code</th> <th>Description</th> <th>Qty</th> <th>UOM</th> </tr> </thead> <tbody> <tr> <td>RC1243A0</td> <td>Ø10F-Ø10M ELBOW CONNECTION + JG END KIT</td> <td>10.000</td> <td>PC</td> </tr> </tbody> </table>	Code	Description	Qty	UOM	RC1243A0	Ø10F-Ø10M ELBOW CONNECTION + JG END KIT	10.000	PC																																			
Code	Description	Qty	UOM																																										
RC1243A0	Ø10F-Ø10M ELBOW CONNECTION + JG END KIT	10.000	PC																																										
TB1099A	TB3130A-D10 WATER CONNECTING PIPE		KTB2599A	Ø10 PET WATER PIPE TB2243A0 100M KIT	<table border="1"> <thead> <tr> <th>Code</th> <th>Description</th> <th>Qty</th> <th>UOM</th> </tr> </thead> <tbody> <tr> <td>TB2243A0</td> <td>D10 PE TRANSPARENT PIPE</td> <td>100.000</td> <td>M</td> </tr> </tbody> </table>	Code	Description	Qty	UOM	TB2243A0	D10 PE TRANSPARENT PIPE	100.000	M																																
			Code	Description	Qty	UOM																																							
TB2243A0	D10 PE TRANSPARENT PIPE	100.000	M																																										
KTB2598A	D10 PET HUMIDITY PIPE TB2243A0 3 M KIT	<table border="1"> <thead> <tr> <th>Code</th> <th>Description</th> <th>Qty</th> <th>UOM</th> </tr> </thead> <tbody> <tr> <td>TB2243A0</td> <td>D10 PE TRANSPARENT PIPE</td> <td>3.000</td> <td>M</td> </tr> </tbody> </table>	Code	Description	Qty	UOM	TB2243A0	D10 PE TRANSPARENT PIPE	3.000	M																																			
Code	Description	Qty	UOM																																										
TB2243A0	D10 PE TRANSPARENT PIPE	3.000	M																																										



COMPONENT			SPARE PART																		
Code	Description	Image	Code	Description	Kit components																
VL1135A	3/4-JG10 CONNECTOR + FILTER AND NRV		KVL1135A	3/4-JG10 FITTING WITH FILTER AND VNR KIT	<table border="1"> <thead> <tr> <th>Code</th> <th>Description</th> <th>Qty</th> <th>UOM</th> </tr> </thead> <tbody> <tr> <td>RC1360A0</td> <td>10 - 10 JG ELBOW FITTING</td> <td>1.000</td> <td>PC</td> </tr> <tr> <td>VL1135A1</td> <td>3/4-JG10 CONNECTOR + FILTER AND NRV</td> <td>1.000</td> <td>PC</td> </tr> </tbody> </table>	Code	Description	Qty	UOM	RC1360A0	10 - 10 JG ELBOW FITTING	1.000	PC	VL1135A1	3/4-JG10 CONNECTOR + FILTER AND NRV	1.000	PC				
Code	Description	Qty	UOM																		
RC1360A0	10 - 10 JG ELBOW FITTING	1.000	PC																		
VL1135A1	3/4-JG10 CONNECTOR + FILTER AND NRV	1.000	PC																		
TB3251A	TB3131A-H2O STEAM INLET PIPE		KTB3131A	WHITE-BLACK 6X12 STEAM PIPE 3M KIT	<table border="1"> <thead> <tr> <th>Code</th> <th>Description</th> <th>Qty</th> <th>UOM</th> </tr> </thead> <tbody> <tr> <td>TB3131A0</td> <td>WHITE-BLACK EPDM TEXTILE BRAID HOSE 6x12</td> <td>3.000</td> <td>M</td> </tr> <tr> <td>VM1794A0</td> <td>250x4.8 PA66 BLACK CLAMP</td> <td>1.000</td> <td>PC</td> </tr> </tbody> </table>	Code	Description	Qty	UOM	TB3131A0	WHITE-BLACK EPDM TEXTILE BRAID HOSE 6x12	3.000	M	VM1794A0	250x4.8 PA66 BLACK CLAMP	1.000	PC				
Code	Description	Qty	UOM																		
TB3131A0	WHITE-BLACK EPDM TEXTILE BRAID HOSE 6x12	3.000	M																		
VM1794A0	250x4.8 PA66 BLACK CLAMP	1.000	PC																		
VL1086A	LIMESCALE REMOVER NEODYMIUM MAGNET		KVL1086A	NEODYMIUM MAGNET ANTI-LIMESCALE KI	<table border="1"> <thead> <tr> <th>Code</th> <th>Description</th> <th>Qty</th> <th>UOM</th> </tr> </thead> <tbody> <tr> <td>VL1086A0</td> <td>LIMESCALE REMOVER NEODYMIUM MAGNET</td> <td>2.000</td> <td>PC</td> </tr> </tbody> </table>	Code	Description	Qty	UOM	VL1086A0	LIMESCALE REMOVER NEODYMIUM MAGNET	2.000	PC								
Code	Description	Qty	UOM																		
VL1086A0	LIMESCALE REMOVER NEODYMIUM MAGNET	2.000	PC																		
VL1096A	2PCS T-SHAPED FIT-D6-D10 HOLD-MAGNET		KVL1096A	T - SHAPED FIT-D6-D10 HOLD-2 MAGNETS KIT	<table border="1"> <thead> <tr> <th>Code</th> <th>Description</th> <th>Qty</th> <th>UOM</th> </tr> </thead> <tbody> <tr> <td>RC1018A0</td> <td>ZINC PLATED D12 ELASTIC CLAMP</td> <td>2.000</td> <td>PC</td> </tr> <tr> <td>VL1086A0</td> <td>LIMESCALE REMOVER NEODYMIUM MAGNET</td> <td>2.000</td> <td>PC</td> </tr> <tr> <td>VL1096A1</td> <td>2PCS T-SHAPED FIT-D6-D10 HOLD-MAGNE</td> <td>1.000</td> <td>PC</td> </tr> </tbody> </table>	Code	Description	Qty	UOM	RC1018A0	ZINC PLATED D12 ELASTIC CLAMP	2.000	PC	VL1086A0	LIMESCALE REMOVER NEODYMIUM MAGNET	2.000	PC	VL1096A1	2PCS T-SHAPED FIT-D6-D10 HOLD-MAGNE	1.000	PC
Code	Description	Qty	UOM																		
RC1018A0	ZINC PLATED D12 ELASTIC CLAMP	2.000	PC																		
VL1086A0	LIMESCALE REMOVER NEODYMIUM MAGNET	2.000	PC																		
VL1096A1	2PCS T-SHAPED FIT-D6-D10 HOLD-MAGNE	1.000	PC																		
VL1026A	BEND FOR DRAIN PIPE		KVL1026A	DRAIN PIPE BEND KI	<table border="1"> <thead> <tr> <th>Code</th> <th>Description</th> <th>Qty</th> <th>UOM</th> </tr> </thead> <tbody> <tr> <td>GN1400A0</td> <td>U-TRAP SEAL</td> <td>1.000</td> <td>PC</td> </tr> <tr> <td>VL1026A0</td> <td>BEND FOR DRAIN PIPE</td> <td>1.000</td> <td>PC</td> </tr> <tr> <td>VM2039A0</td> <td>DRAIN BEND FIXING RING</td> <td>1.000</td> <td>PC</td> </tr> </tbody> </table>	Code	Description	Qty	UOM	GN1400A0	U-TRAP SEAL	1.000	PC	VL1026A0	BEND FOR DRAIN PIPE	1.000	PC	VM2039A0	DRAIN BEND FIXING RING	1.000	PC
Code	Description	Qty	UOM																		
GN1400A0	U-TRAP SEAL	1.000	PC																		
VL1026A0	BEND FOR DRAIN PIPE	1.000	PC																		
VM2039A0	DRAIN BEND FIXING RING	1.000	PC																		





COMPONENT			SPARE PART																		
Code	Description	Image	Code	Description	Kit components																
VM2039A	DRAIN BEND FIXING RING		KVL1026A	DRAIN PIPE BEND KI	<table border="1"> <thead> <tr> <th>Code</th> <th>Description</th> <th>Qty</th> <th>UOM</th> </tr> </thead> <tbody> <tr> <td>GN1400A0</td> <td>U-TRAP SEAL</td> <td>1.000</td> <td>PC</td> </tr> <tr> <td>VL1026A0</td> <td>BEND FOR DRAIN PIPE</td> <td>1.000</td> <td>PC</td> </tr> <tr> <td>VM2039A0</td> <td>DRAIN BEND FIXING RING</td> <td>1.000</td> <td>PC</td> </tr> </tbody> </table>	Code	Description	Qty	UOM	GN1400A0	U-TRAP SEAL	1.000	PC	VL1026A0	BEND FOR DRAIN PIPE	1.000	PC	VM2039A0	DRAIN BEND FIXING RING	1.000	PC
					Code	Description	Qty	UOM													
GN1400A0	U-TRAP SEAL	1.000	PC																		
VL1026A0	BEND FOR DRAIN PIPE	1.000	PC																		
VM2039A0	DRAIN BEND FIXING RING	1.000	PC																		
<table border="1"> <thead> <tr> <th>Code</th> <th>Description</th> <th>Qty</th> <th>UOM</th> </tr> </thead> <tbody> <tr> <td>VI1099A0</td> <td>SELF-DRILLIN G SCREW 4.8X13 TCB+ Z</td> <td>4.000</td> <td>PC</td> </tr> <tr> <td>VM1555A2</td> <td>CT BT COOLING FAN SUPPORT</td> <td>1.000</td> <td>PC</td> </tr> <tr> <td>VN1165A0</td> <td>230Vac 50/60Hz COOLING DOWN FAN</td> <td>1.000</td> <td>PC</td> </tr> </tbody> </table>	Code	Description	Qty	UOM	VI1099A0	SELF-DRILLIN G SCREW 4.8X13 TCB+ Z	4.000	PC	VM1555A2	CT BT COOLING FAN SUPPORT	1.000	PC	VN1165A0	230Vac 50/60Hz COOLING DOWN FAN	1.000	PC					
Code	Description	Qty	UOM																		
VI1099A0	SELF-DRILLIN G SCREW 4.8X13 TCB+ Z	4.000	PC																		
VM1555A2	CT BT COOLING FAN SUPPORT	1.000	PC																		
VN1165A0	230Vac 50/60Hz COOLING DOWN FAN	1.000	PC																		
VM1555A	CT BT COOLING FAN SUPPORT		KVN1165A	S.5E ADVANCE/MM 230V COOLING FAN KIT	<table border="1"> <thead> <tr> <th>Code</th> <th>Description</th> <th>Qty</th> <th>UOM</th> </tr> </thead> <tbody> <tr> <td>VI1099A0</td> <td>SELF-DRILLIN G SCREW 4.8X13 TCB+ Z</td> <td>4.000</td> <td>PC</td> </tr> <tr> <td>VM1555A2</td> <td>CT BT COOLING FAN SUPPORT</td> <td>1.000</td> <td>PC</td> </tr> <tr> <td>VN1165A0</td> <td>230Vac 50/60Hz COOLING DOWN FAN</td> <td>1.000</td> <td>PC</td> </tr> </tbody> </table>	Code	Description	Qty	UOM	VI1099A0	SELF-DRILLIN G SCREW 4.8X13 TCB+ Z	4.000	PC	VM1555A2	CT BT COOLING FAN SUPPORT	1.000	PC	VN1165A0	230Vac 50/60Hz COOLING DOWN FAN	1.000	PC
			Code	Description	Qty	UOM															
VI1099A0	SELF-DRILLIN G SCREW 4.8X13 TCB+ Z	4.000	PC																		
VM1555A2	CT BT COOLING FAN SUPPORT	1.000	PC																		
VN1165A0	230Vac 50/60Hz COOLING DOWN FAN	1.000	PC																		
KVN1164A	S.5/5E 12VDC COOLING DOWN FAN KIT	<table border="1"> <thead> <tr> <th>Code</th> <th>Description</th> <th>Qty</th> <th>UOM</th> </tr> </thead> <tbody> <tr> <td>VI1099A0</td> <td>SELF-DRILLIN G SCREW 4.8X13 TCB+ Z</td> <td>4.000</td> <td>PC</td> </tr> <tr> <td>VM1555A2</td> <td>CT BT COOLING FAN SUPPORT</td> <td>1.000</td> <td>PC</td> </tr> <tr> <td>VN1164A0</td> <td>12VDC COOLING DONW FAN</td> <td>1.000</td> <td>PC</td> </tr> </tbody> </table>	Code	Description	Qty	UOM	VI1099A0	SELF-DRILLIN G SCREW 4.8X13 TCB+ Z	4.000	PC	VM1555A2	CT BT COOLING FAN SUPPORT	1.000	PC	VN1164A0	12VDC COOLING DONW FAN	1.000	PC			
Code	Description	Qty	UOM																		
VI1099A0	SELF-DRILLIN G SCREW 4.8X13 TCB+ Z	4.000	PC																		
VM1555A2	CT BT COOLING FAN SUPPORT	1.000	PC																		
VN1164A0	12VDC COOLING DONW FAN	1.000	PC																		
VM1556A	XBC-XVC COOLING FAN GUARD		KVM1556A	XBC-XVC COOLING FAN GUARD KIT	<table border="1"> <thead> <tr> <th>Code</th> <th>Description</th> <th>Qty</th> <th>UOM</th> </tr> </thead> <tbody> <tr> <td>VM1556A0</td> <td>XBC-XVC COOLING FAN GUARD</td> <td>1.000</td> <td>PC</td> </tr> </tbody> </table>	Code	Description	Qty	UOM	VM1556A0	XBC-XVC COOLING FAN GUARD	1.000	PC								
Code	Description	Qty	UOM																		
VM1556A0	XBC-XVC COOLING FAN GUARD	1.000	PC																		
VN1165A	230Vac 50/60Hz COOLING DOWN FA		KVN1165A	S.5E ADVANCE/MM 230V COOLING FAN KIT	<table border="1"> <thead> <tr> <th>Code</th> <th>Description</th> <th>Qty</th> <th>UOM</th> </tr> </thead> <tbody> <tr> <td>VI1099A0</td> <td>SELF-DRILLIN G SCREW 4.8X13 TCB+ Z</td> <td>4.000</td> <td>PC</td> </tr> <tr> <td>VM1555A2</td> <td>CT BT COOLING FAN SUPPORT</td> <td>1.000</td> <td>PC</td> </tr> <tr> <td>VN1165A0</td> <td>230Vac 50/60Hz COOLING DOWN FAN</td> <td>1.000</td> <td>PC</td> </tr> </tbody> </table>	Code	Description	Qty	UOM	VI1099A0	SELF-DRILLIN G SCREW 4.8X13 TCB+ Z	4.000	PC	VM1555A2	CT BT COOLING FAN SUPPORT	1.000	PC	VN1165A0	230Vac 50/60Hz COOLING DOWN FAN	1.000	PC
Code	Description	Qty	UOM																		
VI1099A0	SELF-DRILLIN G SCREW 4.8X13 TCB+ Z	4.000	PC																		
VM1555A2	CT BT COOLING FAN SUPPORT	1.000	PC																		
VN1165A0	230Vac 50/60Hz COOLING DOWN FAN	1.000	PC																		

COMPONENT			SPARE PART																	
Code	Description	Image	Code	Description	Kit components															
EL1438A	BARBED STEAM SOLENOID VALVE 5+9		KEL1438A	5+9 BARBED 6 STEAM SOLENOID VALVE KIT	<table border="1"> <thead> <tr> <th>Code</th> <th>Description</th> <th>Qty</th> <th>UOM</th> </tr> </thead> <tbody> <tr> <td>EL1438A0</td> <td>BARBED STEAM SOLENOID VALVE 5+9</td> <td>1.000</td> <td>PC</td> </tr> <tr> <td>RC1018A0</td> <td>ZINC PLATED D12 ELASTIC CLAMP</td> <td>2.000</td> <td>PC</td> </tr> </tbody> </table>	Code	Description	Qty	UOM	EL1438A0	BARBED STEAM SOLENOID VALVE 5+9	1.000	PC	RC1018A0	ZINC PLATED D12 ELASTIC CLAMP	2.000	PC			
					Code	Description	Qty	UOM												
EL1438A0	BARBED STEAM SOLENOID VALVE 5+9	1.000	PC																	
RC1018A0	ZINC PLATED D12 ELASTIC CLAMP	2.000	PC																	
RC1414A	D12 HOSE CLAMP		KRC1414A	D11-12 HOSE SNAP CLAMP 10 PCS KIT	<table border="1"> <thead> <tr> <th>Code</th> <th>Description</th> <th>Qty</th> <th>UOM</th> </tr> </thead> <tbody> <tr> <td>RC1414A0</td> <td>D12 HOSE CLAMP</td> <td>50.000</td> <td>PC</td> </tr> </tbody> </table>	Code	Description	Qty	UOM	RC1414A0	D12 HOSE CLAMP	50.000	PC							
Code	Description	Qty	UOM																	
RC1414A0	D12 HOSE CLAMP	50.000	PC																	
TB2869A	TB2869A0		KVL0011A	WHITE-BLACK 6x12 REINF PIPE 100M KI	<table border="1"> <thead> <tr> <th>Code</th> <th>Description</th> <th>Qty</th> <th>UOM</th> </tr> </thead> <tbody> <tr> <td>TB3131A0</td> <td>WHITE-BLACK EPDM TEXTILE BRAID HOSE 6x12</td> <td>100.000</td> <td>M</td> </tr> </tbody> </table>	Code	Description	Qty	UOM	TB3131A0	WHITE-BLACK EPDM TEXTILE BRAID HOSE 6x12	100.000	M							
					Code	Description	Qty	UOM												
					TB3131A0	WHITE-BLACK EPDM TEXTILE BRAID HOSE 6x12	100.000	M												
KTB3131A	WHITE-BLACK 6X12 STEAM PIPE 3M KIT	<table border="1"> <thead> <tr> <th>Code</th> <th>Description</th> <th>Qty</th> <th>UOM</th> </tr> </thead> <tbody> <tr> <td>TB3131A0</td> <td>WHITE-BLACK EPDM TEXTILE BRAID HOSE 6x12</td> <td>3.000</td> <td>M</td> </tr> <tr> <td>VM1794A0</td> <td>250x4.8 PA66 BLACK CLAMP</td> <td>1.000</td> <td>PC</td> </tr> </tbody> </table>	Code	Description	Qty	UOM	TB3131A0	WHITE-BLACK EPDM TEXTILE BRAID HOSE 6x12	3.000	M	VM1794A0	250x4.8 PA66 BLACK CLAMP	1.000	PC						
Code	Description	Qty	UOM																	
TB3131A0	WHITE-BLACK EPDM TEXTILE BRAID HOSE 6x12	3.000	M																	
VM1794A0	250x4.8 PA66 BLACK CLAMP	1.000	PC																	
VL1182A	ONE SINGLE ROTOR ARM WASHING CIRCUIT		KVL1182A	ONE 1ROT CLEANING SYSTEM KIT (0311 EXC.)	<table border="1"> <thead> <tr> <th>Code</th> <th>Description</th> <th>Qty</th> <th>UOM</th> </tr> </thead> <tbody> <tr> <td>0H2202A1</td> <td>ONE WASHING WITH STEAM VALVE SUPPORT</td> <td>1.000</td> <td>PC</td> </tr> <tr> <td>EL1440A0</td> <td>WATER SELF CLEANING VALVE</td> <td>1.000</td> <td>PC</td> </tr> <tr> <td>GN1526A0</td>INT. D.=6.9 TH=1.8 O-RIN</tr></tbody></table>	Code	Description	Qty	UOM	0H2202A1	ONE WASHING WITH STEAM VALVE SUPPORT	1.000	PC	EL1440A0	WATER SELF CLEANING VALVE	1.000	PC	GN1526A0	3.000	PC
Code	Description	Qty	UOM																	
0H2202A1	ONE WASHING WITH STEAM VALVE SUPPORT	1.000	PC																	
EL1440A0	WATER SELF CLEANING VALVE	1.000	PC																	
GN1526A0																				
RC1018A0	ZINC PLATED D12 ELASTIC CLAMP	1.000	PC																	
RC1019A0	D=10 ELASTIC CLAMP	14.000	PC																	
RC1130A0	130x2.6 CLAM	2.000	PC																	
RC1242A0	D=10 CLOSED CAP	2.000	PC																	
TB2821A0	EPDM 6X10 L=40MM PIPE	6.000	PC																	



COMPONENT			SPARE PART																																																															
Code	Description	Image	Code	Description	Kit components																																																													
VL1182A	ONE SINGLE ROTOR ARM WASHING CIRCUIT		KVL1182A	ONE 1ROT CLEANING SYSTEM KIT (0311 EXC.)	<table border="1"> <thead> <tr> <th>Code</th> <th>Description</th> <th>Qty</th> <th>UOM</th> </tr> </thead> <tbody> <tr> <td>TB3004A0</td> <td>TB2820A L=550mm EPDM BLACK PIPE</td> <td>1.000</td> <td>PC</td> </tr> <tr> <td>TB3009B0</td> <td>TB3132A-ONE OVEN WASHING INLET</td> <td>1.000</td> <td>PC</td> </tr> <tr> <td>TB3225B0</td> <td>TB2820A-TAN K-WASHYNG SYS CONNECTION</td> <td>1.000</td> <td>PC</td> </tr> <tr> <td>VI1220A1</td> <td>4,2x12 TCB SELF-TAPPIN G SCREW</td> <td>1.000</td> <td>PC</td> </tr> <tr> <td>VL1019A0</td> <td>VIBRATION DETERGENT PUMP</td> <td>1.000</td> <td>PC</td> </tr> <tr> <td>VL1047A1</td> <td>D6 PIPE HOLDER - D6 J.G. TERMINAL</td> <td>1.000</td> <td>PC</td> </tr> <tr> <td>VL1054B0</td> <td>ONE WASHING SYS INLET DISTRIBUTOR</td> <td>1.000</td> <td>PC</td> </tr> <tr> <td>VL1102A1</td> <td>DETERGENT LINE FILTER + BARBED VNR 6 MM</td> <td>1.000</td> <td>PC</td> </tr> <tr> <td>VL1128A1</td> <td>D6 BARBED CHECK VALVE</td> <td>2.000</td> <td>PC</td> </tr> <tr> <td>VL1166A0</td> <td>BB6-AR6 L FITTING</td> <td>1.000</td> <td>PC</td> </tr> <tr> <td>VL1174C0</td> <td>D1.2 MM CALIBRATED D1.2 MM</td> <td>1.000</td> <td>PC</td> </tr> <tr> <td>VL1191A0</td> <td>ONE WASHING DISTRIBUTOR OUTLETS KIT</td> <td>1.000</td> <td>PC</td> </tr> <tr> <td>VL1214A0</td> <td>BAYONET - 6mm BARBED NRV VALVE</td> <td>1.000</td> <td>PC</td> </tr> <tr> <td>VM2172A0</td> <td>LOCKING CLIP FOR PUMP WITH CIRCUIT</td> <td>2.000</td> <td>PC</td> </tr> </tbody> </table>	Code	Description	Qty	UOM	TB3004A0	TB2820A L=550mm EPDM BLACK PIPE	1.000	PC	TB3009B0	TB3132A-ONE OVEN WASHING INLET	1.000	PC	TB3225B0	TB2820A-TAN K-WASHYNG SYS CONNECTION	1.000	PC	VI1220A1	4,2x12 TCB SELF-TAPPIN G SCREW	1.000	PC	VL1019A0	VIBRATION DETERGENT PUMP	1.000	PC	VL1047A1	D6 PIPE HOLDER - D6 J.G. TERMINAL	1.000	PC	VL1054B0	ONE WASHING SYS INLET DISTRIBUTOR	1.000	PC	VL1102A1	DETERGENT LINE FILTER + BARBED VNR 6 MM	1.000	PC	VL1128A1	D6 BARBED CHECK VALVE	2.000	PC	VL1166A0	BB6-AR6 L FITTING	1.000	PC	VL1174C0	D1.2 MM CALIBRATED D1.2 MM	1.000	PC	VL1191A0	ONE WASHING DISTRIBUTOR OUTLETS KIT	1.000	PC	VL1214A0	BAYONET - 6mm BARBED NRV VALVE	1.000	PC	VM2172A0	LOCKING CLIP FOR PUMP WITH CIRCUIT	2.000	PC	
Code	Description	Qty	UOM																																																															
TB3004A0	TB2820A L=550mm EPDM BLACK PIPE	1.000	PC																																																															
TB3009B0	TB3132A-ONE OVEN WASHING INLET	1.000	PC																																																															
TB3225B0	TB2820A-TAN K-WASHYNG SYS CONNECTION	1.000	PC																																																															
VI1220A1	4,2x12 TCB SELF-TAPPIN G SCREW	1.000	PC																																																															
VL1019A0	VIBRATION DETERGENT PUMP	1.000	PC																																																															
VL1047A1	D6 PIPE HOLDER - D6 J.G. TERMINAL	1.000	PC																																																															
VL1054B0	ONE WASHING SYS INLET DISTRIBUTOR	1.000	PC																																																															
VL1102A1	DETERGENT LINE FILTER + BARBED VNR 6 MM	1.000	PC																																																															
VL1128A1	D6 BARBED CHECK VALVE	2.000	PC																																																															
VL1166A0	BB6-AR6 L FITTING	1.000	PC																																																															
VL1174C0	D1.2 MM CALIBRATED D1.2 MM	1.000	PC																																																															
VL1191A0	ONE WASHING DISTRIBUTOR OUTLETS KIT	1.000	PC																																																															
VL1214A0	BAYONET - 6mm BARBED NRV VALVE	1.000	PC																																																															
VM2172A0	LOCKING CLIP FOR PUMP WITH CIRCUIT	2.000	PC																																																															

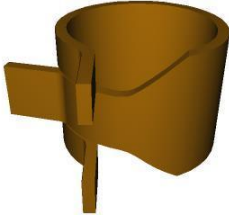

COMPONENT			SPARE PART																						
Code	Description	Image	Code	Description	Kit components																				
0H2202A	ONE WASHING WITH STEAM VALVE SUPPORT		0H2202A1	ONE WASHING WITH STEAM VALVE SUPPORT																					
GN1526A	INT. D.=6.9 TH=1.8 O-RING		KG1526A	O-RING INT D6.9 THICK1.8 10PCS KIT	<table border="1"> <thead> <tr> <th>Code</th> <th>Description</th> <th>Qty</th> <th>UOM</th> </tr> </thead> <tbody> <tr> <td>GN1526A0</td> <td>INT. D.=6.9 TH=1.8 O-RIN</td> <td>10.000</td> <td>PC</td> </tr> </tbody> </table>	Code	Description	Qty	UOM	GN1526A0	INT. D.=6.9 TH=1.8 O-RIN	10.000	PC												
Code	Description	Qty	UOM																						
GN1526A0	INT. D.=6.9 TH=1.8 O-RIN	10.000	PC																						
RC1019A	D=10 ELASTIC CLAM		KRC1019A	Ø10 ZINC PLATED ELASTIC CLAMP 15 PCS KIT	<table border="1"> <thead> <tr> <th>Code</th> <th>Description</th> <th>Qty</th> <th>UOM</th> </tr> </thead> <tbody> <tr> <td>RC1019A0</td> <td>D=10 ELASTIC CLAMP</td> <td>15.000</td> <td>PC</td> </tr> </tbody> </table>	Code	Description	Qty	UOM	RC1019A0	D=10 ELASTIC CLAMP	15.000	PC												
Code	Description	Qty	UOM																						
RC1019A0	D=10 ELASTIC CLAMP	15.000	PC																						
RC1242A	D=10 CLOSED CAP		KRC1242A	Ø10 CLOSED CONNECTION 20PCS KIT	<table border="1"> <thead> <tr> <th>Code</th> <th>Description</th> <th>Qty</th> <th>UOM</th> </tr> </thead> <tbody> <tr> <td>RC1242A0</td> <td>D=10 CLOSED CAP</td> <td>20.000</td> <td>PC</td> </tr> </tbody> </table>	Code	Description	Qty	UOM	RC1242A0	D=10 CLOSED CAP	20.000	PC												
Code	Description	Qty	UOM																						
RC1242A0	D=10 CLOSED CAP	20.000	PC																						
VL1019A	VIBRATION DETERGENT PUMP		KVL2618A	2 ROTOR ARMS ONE CLEANING SYSTEM KIT	<table border="1"> <thead> <tr> <th>Code</th> <th>Description</th> <th>Qty</th> <th>UOM</th> </tr> </thead> <tbody> <tr> <td>0H2202A1</td> <td>ONE WASHING WITH STEAM VALVE SUPPORT</td> <td>2.000</td> <td>PC</td> </tr> <tr> <td>CE1030A0</td> <td>FEMALE FASTON COVER 6.3X0.8 0,5-1mmq</td> <td>4.000</td> <td>PC</td> </tr> <tr> <td>CE1395A0</td> <td>6,3 X 0,8 MALE FASTO</td> <td>2.000</td> <td>PC</td> </tr> <tr> <td>CE1545A0</td> <td>BLUE UNIP AWG18 ST.3135 WIRE</td> <td>2.000</td> <td>M</td> </tr> </tbody> </table>	Code	Description	Qty	UOM	0H2202A1	ONE WASHING WITH STEAM VALVE SUPPORT	2.000	PC	CE1030A0	FEMALE FASTON COVER 6.3X0.8 0,5-1mmq	4.000	PC	CE1395A0	6,3 X 0,8 MALE FASTO	2.000	PC	CE1545A0	BLUE UNIP AWG18 ST.3135 WIRE	2.000	M
Code	Description	Qty	UOM																						
0H2202A1	ONE WASHING WITH STEAM VALVE SUPPORT	2.000	PC																						
CE1030A0	FEMALE FASTON COVER 6.3X0.8 0,5-1mmq	4.000	PC																						
CE1395A0	6,3 X 0,8 MALE FASTO	2.000	PC																						
CE1545A0	BLUE UNIP AWG18 ST.3135 WIRE	2.000	M																						

COMPONENT			SPARE PART																																																																																	
Code	Description	Image	Code	Description	Kit components																																																																															
VL1019A	VIBRATION DETERGENT PUMP		KVL2618A	2 ROTOR ARMS ONE CLEANING SYSTEM KIT	<table border="1"> <thead> <tr> <th>Code</th> <th>Description</th> <th>Qty</th> <th>UOM</th> </tr> </thead> <tbody> <tr> <td>CE1570A0</td> <td>WHITE UNIP AWG18 ST.3135 WIRE</td> <td>2.000</td> <td>M</td> </tr> <tr> <td>CE1660A0</td> <td>6,3x0,8 FEMALE FASTON COVE</td> <td>4.000</td> <td>PC</td> </tr> <tr> <td>CE1661A0</td> <td>MALE FASTON COVER 6,3x0,8</td> <td>2.000</td> <td>PC</td> </tr> <tr> <td>EL1020A1</td> <td>D8 INTERMEDIAT E T-SHAPED FITTING</td> <td>1.000</td> <td>PC</td> </tr> <tr> <td>EL1440A0</td> <td>WATER SELF CLEANING VALVE</td> <td>2.000</td> <td>PC</td> </tr> <tr> <td>GN1526A0</td> <td>INT. D.=6.9 TH=1.8 O-RIN</td> <td>6.000</td> <td>PC</td> </tr> <tr> <td>RC1018A0</td> <td>ZINC PLATED D12 ELASTIC CLAMP</td> <td>2.000</td> <td>PC</td> </tr> <tr> <td>RC1019A0</td> <td>D=10 ELASTIC CLAMP</td> <td>28.000</td> <td>PC</td> </tr> <tr> <td>RC1130A0</td> <td>130x2,6 CLAM</td> <td>4.000</td> <td>PC</td> </tr> <tr> <td>RC1242A0</td> <td>D=10 CLOSED CAP</td> <td>4.000</td> <td>PC</td> </tr> <tr> <td>TB2821A0</td> <td>EPDM 6X10 L=40MM PIPE</td> <td>12.000</td> <td>PC</td> </tr> <tr> <td>TB3004A0</td> <td>TB2820A L=550mm EPDM BLACK PIPE</td> <td>2.000</td> <td>PC</td> </tr> <tr> <td>TB3009B0</td> <td>TB3132A-ONE OVEN WASHING INLET</td> <td>2.000</td> <td>PC</td> </tr> <tr> <td>TB3225B0</td> <td>TB2820A-TAN K-WASHYNG SYS CONNECTION</td> <td>2.000</td> <td>PC</td> </tr> <tr> <td>VI1220A1</td> <td>4,2x12 TCB SELF-TAPPIN G SCREW</td> <td>2.000</td> <td>PC</td> </tr> <tr> <td>VL1019A0</td> <td>VIBRATION DETERGENT PUMP</td> <td></td> <td>2.000</td> <td>PC</td> </tr> <tr> <td>VL1047A1</td> <td>D6 PIPE HOLDER - D8 J.G. TERMINAL</td> <td></td> <td>2.000</td> <td>PC</td> </tr> <tr> <td>VL1054B0</td> <td>ONE WASHING SYS INLET DISTRIBUTOR</td> <td></td> <td>2.000</td> <td>PC</td> </tr> </tbody> </table>	Code	Description	Qty	UOM	CE1570A0	WHITE UNIP AWG18 ST.3135 WIRE	2.000	M	CE1660A0	6,3x0,8 FEMALE FASTON COVE	4.000	PC	CE1661A0	MALE FASTON COVER 6,3x0,8	2.000	PC	EL1020A1	D8 INTERMEDIAT E T-SHAPED FITTING	1.000	PC	EL1440A0	WATER SELF CLEANING VALVE	2.000	PC	GN1526A0	INT. D.=6.9 TH=1.8 O-RIN	6.000	PC	RC1018A0	ZINC PLATED D12 ELASTIC CLAMP	2.000	PC	RC1019A0	D=10 ELASTIC CLAMP	28.000	PC	RC1130A0	130x2,6 CLAM	4.000	PC	RC1242A0	D=10 CLOSED CAP	4.000	PC	TB2821A0	EPDM 6X10 L=40MM PIPE	12.000	PC	TB3004A0	TB2820A L=550mm EPDM BLACK PIPE	2.000	PC	TB3009B0	TB3132A-ONE OVEN WASHING INLET	2.000	PC	TB3225B0	TB2820A-TAN K-WASHYNG SYS CONNECTION	2.000	PC	VI1220A1	4,2x12 TCB SELF-TAPPIN G SCREW	2.000	PC	VL1019A0	VIBRATION DETERGENT PUMP		2.000	PC	VL1047A1	D6 PIPE HOLDER - D8 J.G. TERMINAL		2.000	PC	VL1054B0	ONE WASHING SYS INLET DISTRIBUTOR		2.000	PC
Code	Description	Qty	UOM																																																																																	
CE1570A0	WHITE UNIP AWG18 ST.3135 WIRE	2.000	M																																																																																	
CE1660A0	6,3x0,8 FEMALE FASTON COVE	4.000	PC																																																																																	
CE1661A0	MALE FASTON COVER 6,3x0,8	2.000	PC																																																																																	
EL1020A1	D8 INTERMEDIAT E T-SHAPED FITTING	1.000	PC																																																																																	
EL1440A0	WATER SELF CLEANING VALVE	2.000	PC																																																																																	
GN1526A0	INT. D.=6.9 TH=1.8 O-RIN	6.000	PC																																																																																	
RC1018A0	ZINC PLATED D12 ELASTIC CLAMP	2.000	PC																																																																																	
RC1019A0	D=10 ELASTIC CLAMP	28.000	PC																																																																																	
RC1130A0	130x2,6 CLAM	4.000	PC																																																																																	
RC1242A0	D=10 CLOSED CAP	4.000	PC																																																																																	
TB2821A0	EPDM 6X10 L=40MM PIPE	12.000	PC																																																																																	
TB3004A0	TB2820A L=550mm EPDM BLACK PIPE	2.000	PC																																																																																	
TB3009B0	TB3132A-ONE OVEN WASHING INLET	2.000	PC																																																																																	
TB3225B0	TB2820A-TAN K-WASHYNG SYS CONNECTION	2.000	PC																																																																																	
VI1220A1	4,2x12 TCB SELF-TAPPIN G SCREW	2.000	PC																																																																																	
VL1019A0	VIBRATION DETERGENT PUMP		2.000	PC																																																																																
VL1047A1	D6 PIPE HOLDER - D8 J.G. TERMINAL		2.000	PC																																																																																
VL1054B0	ONE WASHING SYS INLET DISTRIBUTOR		2.000	PC																																																																																



COMPONENT			SPARE PART																																																			
Code	Description	Image	Code	Description	Kit components																																																	
VL1019A	VIBRATION DETERGENT PUMP		KVL2618A	2 ROTOR ARMS ONE CLEANING SYSTEM KIT	<table border="1"> <thead> <tr> <th>Code</th> <th>Description</th> <th>Qty</th> <th>UOM</th> </tr> </thead> <tbody> <tr> <td>VL1102A1</td> <td>DETERGENT LINE FILTER + BARBED VNR 6 MM</td> <td>2.000</td> <td>PC</td> </tr> <tr> <td>VL1127A1</td> <td>6mm BARBED T-SHAPED FITTING</td> <td>1.000</td> <td>PC</td> </tr> <tr> <td>VL1128A1</td> <td>D6 BARBED CHECK VALVE</td> <td>4.000</td> <td>PC</td> </tr> <tr> <td>VL1166A0</td> <td>BB6-AR6 L FITTING</td> <td>2.000</td> <td>PC</td> </tr> <tr> <td>VL1174C0</td> <td>D1.2 MM CALIBRATED D1.2 MM</td> <td>2.000</td> <td>PC</td> </tr> <tr> <td>VL1191A0</td> <td>ONE WASHING DISTRIBUTOR OUTLETS KIT</td> <td>2.000</td> <td>PC</td> </tr> <tr> <td>VL1214A0</td> <td>BAYONET - 6mm BARBED NRV VALVE</td> <td>2.000</td> <td>PC</td> </tr> <tr> <td>VM2172A0</td> <td>LOCKING CLIP FOR PUMP WITH CIRCUIT</td> <td>4.000</td> <td>PC</td> </tr> </tbody> </table>	Code	Description	Qty	UOM	VL1102A1	DETERGENT LINE FILTER + BARBED VNR 6 MM	2.000	PC	VL1127A1	6mm BARBED T-SHAPED FITTING	1.000	PC	VL1128A1	D6 BARBED CHECK VALVE	4.000	PC	VL1166A0	BB6-AR6 L FITTING	2.000	PC	VL1174C0	D1.2 MM CALIBRATED D1.2 MM	2.000	PC	VL1191A0	ONE WASHING DISTRIBUTOR OUTLETS KIT	2.000	PC	VL1214A0	BAYONET - 6mm BARBED NRV VALVE	2.000	PC	VM2172A0	LOCKING CLIP FOR PUMP WITH CIRCUIT	4.000	PC													
			Code	Description	Qty	UOM																																																
VL1102A1	DETERGENT LINE FILTER + BARBED VNR 6 MM	2.000	PC																																																			
VL1127A1	6mm BARBED T-SHAPED FITTING	1.000	PC																																																			
VL1128A1	D6 BARBED CHECK VALVE	4.000	PC																																																			
VL1166A0	BB6-AR6 L FITTING	2.000	PC																																																			
VL1174C0	D1.2 MM CALIBRATED D1.2 MM	2.000	PC																																																			
VL1191A0	ONE WASHING DISTRIBUTOR OUTLETS KIT	2.000	PC																																																			
VL1214A0	BAYONET - 6mm BARBED NRV VALVE	2.000	PC																																																			
VM2172A0	LOCKING CLIP FOR PUMP WITH CIRCUIT	4.000	PC																																																			
KVL1225A	US HOOD WASHING SYSTEM KIT	<table border="1"> <thead> <tr> <th>Code</th> <th>Description</th> <th>Qty</th> <th>UOM</th> </tr> </thead> <tbody> <tr> <td>0H2213A1</td> <td>HOOD WATER CIRCUIT PLAT</td> <td>1.000</td> <td>PC</td> </tr> <tr> <td>EL1450A0</td> <td>US SELF-CLEANIN G WATER SOLENOID</td> <td>2.000</td> <td>PC</td> </tr> <tr> <td>GN1526A0</td> <td>INT. D.=6.9 TH=1.8 O-RIN</td> <td>5.000</td> <td>PC</td> </tr> <tr> <td>RC1018A0</td> <td>ZINC PLATED D12 ELASTIC CLAMP</td> <td>4.000</td> <td>PC</td> </tr> <tr> <td>RC1019A0</td> <td>D=10 ELASTIC CLAMP</td> <td>16.000</td> <td>PC</td> </tr> <tr> <td>RC1131A0</td> <td>200x2.6 BLACK CLAMP</td> <td>1.000</td> <td>PC</td> </tr> <tr> <td>RC1242A0</td> <td>D=10 CLOSED CAP</td> <td>2.000</td> <td>PC</td> </tr> <tr> <td>TB2821A0</td> <td>EPDM 6X10 L=40MM PIPE</td> <td>6.000</td> <td>PC</td> </tr> <tr> <td>TB2994A0</td> <td>HOOD DETERGENT PIPE</td> <td>2.000</td> <td>PC</td> </tr> <tr> <td>TB3252A0</td> <td></td> <td>2.000</td> <td>PC</td> </tr> <tr> <td>V11220A1</td> <td>4,2x12 TCB SELF-TAPPIN G SCREW</td> <td>3.000</td> <td>PC</td> </tr> <tr> <td>VL1019A0</td> <td>VIBRATION DETERGENT PUMP</td> <td>1.000</td> <td>PC</td> </tr> </tbody> </table>	Code	Description	Qty	UOM	0H2213A1	HOOD WATER CIRCUIT PLAT	1.000	PC	EL1450A0	US SELF-CLEANIN G WATER SOLENOID	2.000	PC	GN1526A0	INT. D.=6.9 TH=1.8 O-RIN	5.000	PC	RC1018A0	ZINC PLATED D12 ELASTIC CLAMP	4.000	PC	RC1019A0	D=10 ELASTIC CLAMP	16.000	PC	RC1131A0	200x2.6 BLACK CLAMP	1.000	PC	RC1242A0	D=10 CLOSED CAP	2.000	PC	TB2821A0	EPDM 6X10 L=40MM PIPE	6.000	PC	TB2994A0	HOOD DETERGENT PIPE	2.000	PC	TB3252A0		2.000	PC	V11220A1	4,2x12 TCB SELF-TAPPIN G SCREW	3.000	PC	VL1019A0	VIBRATION DETERGENT PUMP	1.000	PC
Code	Description	Qty	UOM																																																			
0H2213A1	HOOD WATER CIRCUIT PLAT	1.000	PC																																																			
EL1450A0	US SELF-CLEANIN G WATER SOLENOID	2.000	PC																																																			
GN1526A0	INT. D.=6.9 TH=1.8 O-RIN	5.000	PC																																																			
RC1018A0	ZINC PLATED D12 ELASTIC CLAMP	4.000	PC																																																			
RC1019A0	D=10 ELASTIC CLAMP	16.000	PC																																																			
RC1131A0	200x2.6 BLACK CLAMP	1.000	PC																																																			
RC1242A0	D=10 CLOSED CAP	2.000	PC																																																			
TB2821A0	EPDM 6X10 L=40MM PIPE	6.000	PC																																																			
TB2994A0	HOOD DETERGENT PIPE	2.000	PC																																																			
TB3252A0		2.000	PC																																																			
V11220A1	4,2x12 TCB SELF-TAPPIN G SCREW	3.000	PC																																																			
VL1019A0	VIBRATION DETERGENT PUMP	1.000	PC																																																			



COMPONENT			SPARE PART																																																																																					
Code	Description	Image	Code	Description	Kit components																																																																																			
VL1019A	VIBRATION DETERGENT PUMP		KVL1225A	US HOOD WASHING SYSTEM KIT	<table border="1"> <thead> <tr> <th>Code</th> <th>Description</th> <th>Qty</th> <th>UOM</th> </tr> </thead> <tbody> <tr> <td>VL1047A1</td> <td>D6 PIPE HOLDER - D8 J.G. TERMINAL</td> <td>1.000</td> <td>PC</td> </tr> <tr> <td>VL1054B0</td> <td>ONE WASHING SYS INLET DISTRIBUTOR</td> <td>1.000</td> <td>PC</td> </tr> <tr> <td>VL1102A1</td> <td>DETERGENT LINE FILTER + BARBED VNR 6 MM</td> <td>1.000</td> <td>PC</td> </tr> <tr> <td>VL1127A1</td> <td>6mm BARBED T-SHAPED FITTING</td> <td>1.000</td> <td>PC</td> </tr> <tr> <td>VL1128A1</td> <td>D6 BARBED CHECK VALVE</td> <td>2.000</td> <td>PC</td> </tr> <tr> <td>VL1165A0</td> <td>BAM-BB6 STRAIGHT FITTING</td> <td>1.000</td> <td>PC</td> </tr> <tr> <td>VL1166A0</td> <td>BB6-AR6 L FITTING</td> <td>2.000</td> <td>PC</td> </tr> <tr> <td>VL1174C0</td> <td>D1.2 MM CALIBRATED D1.2 MM</td> <td>1.000</td> <td>PC</td> </tr> <tr> <td>VL1191A0</td> <td>ONE WASHING DISTRIBUTOR OUTLETS KIT</td> <td>1.000</td> <td>PC</td> </tr> <tr> <td>VL1214A0</td> <td>BAYONET - 6mm BARBED NRV VALVE</td> <td>1.000</td> <td>PC</td> </tr> <tr> <td>VM1605A0</td> <td>CLIP TWIST LOCK DIAM. 10,2-12,7 MM</td> <td>2.000</td> <td>PC</td> </tr> <tr> <td>VM2172A0</td> <td>LOCKING CLIP FOR PUMP WITH CIRCUIT</td> <td>3.000</td> <td>PC</td> </tr> </tbody> </table>	Code	Description	Qty	UOM	VL1047A1	D6 PIPE HOLDER - D8 J.G. TERMINAL	1.000	PC	VL1054B0	ONE WASHING SYS INLET DISTRIBUTOR	1.000	PC	VL1102A1	DETERGENT LINE FILTER + BARBED VNR 6 MM	1.000	PC	VL1127A1	6mm BARBED T-SHAPED FITTING	1.000	PC	VL1128A1	D6 BARBED CHECK VALVE	2.000	PC	VL1165A0	BAM-BB6 STRAIGHT FITTING	1.000	PC	VL1166A0	BB6-AR6 L FITTING	2.000	PC	VL1174C0	D1.2 MM CALIBRATED D1.2 MM	1.000	PC	VL1191A0	ONE WASHING DISTRIBUTOR OUTLETS KIT	1.000	PC	VL1214A0	BAYONET - 6mm BARBED NRV VALVE	1.000	PC	VM1605A0	CLIP TWIST LOCK DIAM. 10,2-12,7 MM	2.000	PC	VM2172A0	LOCKING CLIP FOR PUMP WITH CIRCUIT	3.000	PC	KVL1222A	EUR 0311 ONE PLUS CLEANING SYSTEM KIT	<table border="1"> <thead> <tr> <th>Code</th> <th>Description</th> <th>Qty</th> <th>UOM</th> </tr> </thead> <tbody> <tr> <td>0H2486A0</td> <td>0311 WASHING CIRCUIT PLAT</td> <td>1.000</td> <td>PC</td> </tr> <tr> <td>EL1440A0</td> <td>WATER SELF CLEANING VALVE</td> <td>1.000</td> <td>PC</td> </tr> <tr> <td>GN1526A0</td> <td>INT. D.=6.9 TH=1.8 O-RIN</td> <td>3.000</td> <td>PC</td> </tr> <tr> <td>RC1018A0</td> <td>ZINC PLATED D12 ELASTIC CLAMP</td> <td>1.000</td> <td>PC</td> </tr> <tr> <td>RC1019A0</td> <td>D=10 ELASTIC CLAMP</td> <td>14.000</td> <td>PC</td> </tr> <tr> <td>RC1242A0</td> <td>D=10 CLOSED CAP</td> <td>2.000</td> <td>PC</td> </tr> </tbody> </table>	Code	Description	Qty	UOM	0H2486A0	0311 WASHING CIRCUIT PLAT	1.000	PC	EL1440A0	WATER SELF CLEANING VALVE	1.000	PC	GN1526A0	INT. D.=6.9 TH=1.8 O-RIN	3.000	PC	RC1018A0	ZINC PLATED D12 ELASTIC CLAMP	1.000	PC	RC1019A0	D=10 ELASTIC CLAMP	14.000	PC	RC1242A0	D=10 CLOSED CAP	2.000	PC
			Code	Description	Qty	UOM																																																																																		
VL1047A1	D6 PIPE HOLDER - D8 J.G. TERMINAL	1.000	PC																																																																																					
VL1054B0	ONE WASHING SYS INLET DISTRIBUTOR	1.000	PC																																																																																					
VL1102A1	DETERGENT LINE FILTER + BARBED VNR 6 MM	1.000	PC																																																																																					
VL1127A1	6mm BARBED T-SHAPED FITTING	1.000	PC																																																																																					
VL1128A1	D6 BARBED CHECK VALVE	2.000	PC																																																																																					
VL1165A0	BAM-BB6 STRAIGHT FITTING	1.000	PC																																																																																					
VL1166A0	BB6-AR6 L FITTING	2.000	PC																																																																																					
VL1174C0	D1.2 MM CALIBRATED D1.2 MM	1.000	PC																																																																																					
VL1191A0	ONE WASHING DISTRIBUTOR OUTLETS KIT	1.000	PC																																																																																					
VL1214A0	BAYONET - 6mm BARBED NRV VALVE	1.000	PC																																																																																					
VM1605A0	CLIP TWIST LOCK DIAM. 10,2-12,7 MM	2.000	PC																																																																																					
VM2172A0	LOCKING CLIP FOR PUMP WITH CIRCUIT	3.000	PC																																																																																					
Code	Description	Qty	UOM																																																																																					
0H2486A0	0311 WASHING CIRCUIT PLAT	1.000	PC																																																																																					
EL1440A0	WATER SELF CLEANING VALVE	1.000	PC																																																																																					
GN1526A0	INT. D.=6.9 TH=1.8 O-RIN	3.000	PC																																																																																					
RC1018A0	ZINC PLATED D12 ELASTIC CLAMP	1.000	PC																																																																																					
RC1019A0	D=10 ELASTIC CLAMP	14.000	PC																																																																																					
RC1242A0	D=10 CLOSED CAP	2.000	PC																																																																																					

COMPONENT			SPARE PART																																																																			
Code	Description	Image	Code	Description	Kit components																																																																	
VL1019A	VIBRATION DETERGENT PUMP		KVL1222A	EUR 0311 ONE PLUS CLEANING SYSTEM KIT	<table border="1"> <thead> <tr> <th>Code</th> <th>Description</th> <th>Qty</th> <th>UOM</th> </tr> </thead> <tbody> <tr> <td>TB2821A0</td> <td>EPDM 6X10 L=40MM PIPE</td> <td>6.000</td> <td>PC</td> </tr> <tr> <td>TB3004A0</td> <td>TB2820A L=550mm EPDM BLACK PIPE</td> <td>1.000</td> <td>PC</td> </tr> <tr> <td>TB3009B0</td> <td>TB3132A-ONE OVEN WASHING INLET</td> <td>1.000</td> <td>PC</td> </tr> <tr> <td>TB3225B0</td> <td>TB2820A-TAN K-WASHYNG SYS CONNECTION</td> <td>1.000</td> <td>PC</td> </tr> <tr> <td>VI1220A1</td> <td>4,2x12 TCB SELF-TAPPIN G SCREW</td> <td>4.000</td> <td>PC</td> </tr> <tr> <td>VL1019A0</td> <td>VIBRATION DETERGENT PUMP</td> <td>1.000</td> <td>PC</td> </tr> <tr> <td>VL1047A1</td> <td>D6 PIPE HOLDER - D6 J.G. TERMINAL</td> <td>1.000</td> <td>PC</td> </tr> <tr> <td>VL1054B0</td> <td>ONE WASHING SYS INLET DISTRIBUTOR</td> <td>1.000</td> <td>PC</td> </tr> <tr> <td>VL1102A1</td> <td>DETERGENT LINE FILTER + BARBED VNR 6 MM</td> <td>1.000</td> <td>PC</td> </tr> <tr> <td>VL1128A1</td> <td>D6 BARBED CHECK VALVE</td> <td>2.000</td> <td>PC</td> </tr> <tr> <td>VL1166A0</td> <td>BB6-AR6 L FITTING</td> <td>1.000</td> <td>PC</td> </tr> <tr> <td>VL1174C0</td> <td>D1.2 MM CALIBRATED D1.2 MM</td> <td>1.000</td> <td>PC</td> </tr> <tr> <td>VL1191A0</td> <td>ONE WASHING DISTRIBUTOR OUTLETS KIT</td> <td>1.000</td> <td>PC</td> </tr> <tr> <td>VL1214A0</td> <td>BAYONET - 6mm BARBED NRV VALVE</td> <td>1.000</td> <td>PC</td> </tr> <tr> <td>VM2172A0</td> <td>LOCKING CLIP FOR PUMP WITH CIRCUIT</td> <td>2.000</td> <td>PC</td> </tr> </tbody> </table>	Code	Description	Qty	UOM	TB2821A0	EPDM 6X10 L=40MM PIPE	6.000	PC	TB3004A0	TB2820A L=550mm EPDM BLACK PIPE	1.000	PC	TB3009B0	TB3132A-ONE OVEN WASHING INLET	1.000	PC	TB3225B0	TB2820A-TAN K-WASHYNG SYS CONNECTION	1.000	PC	VI1220A1	4,2x12 TCB SELF-TAPPIN G SCREW	4.000	PC	VL1019A0	VIBRATION DETERGENT PUMP	1.000	PC	VL1047A1	D6 PIPE HOLDER - D6 J.G. TERMINAL	1.000	PC	VL1054B0	ONE WASHING SYS INLET DISTRIBUTOR	1.000	PC	VL1102A1	DETERGENT LINE FILTER + BARBED VNR 6 MM	1.000	PC	VL1128A1	D6 BARBED CHECK VALVE	2.000	PC	VL1166A0	BB6-AR6 L FITTING	1.000	PC	VL1174C0	D1.2 MM CALIBRATED D1.2 MM	1.000	PC	VL1191A0	ONE WASHING DISTRIBUTOR OUTLETS KIT	1.000	PC	VL1214A0	BAYONET - 6mm BARBED NRV VALVE	1.000	PC	VM2172A0	LOCKING CLIP FOR PUMP WITH CIRCUIT	2.000	PC	
			Code		Description	Qty	UOM																																																															
TB2821A0	EPDM 6X10 L=40MM PIPE	6.000	PC																																																																			
TB3004A0	TB2820A L=550mm EPDM BLACK PIPE	1.000	PC																																																																			
TB3009B0	TB3132A-ONE OVEN WASHING INLET	1.000	PC																																																																			
TB3225B0	TB2820A-TAN K-WASHYNG SYS CONNECTION	1.000	PC																																																																			
VI1220A1	4,2x12 TCB SELF-TAPPIN G SCREW	4.000	PC																																																																			
VL1019A0	VIBRATION DETERGENT PUMP	1.000	PC																																																																			
VL1047A1	D6 PIPE HOLDER - D6 J.G. TERMINAL	1.000	PC																																																																			
VL1054B0	ONE WASHING SYS INLET DISTRIBUTOR	1.000	PC																																																																			
VL1102A1	DETERGENT LINE FILTER + BARBED VNR 6 MM	1.000	PC																																																																			
VL1128A1	D6 BARBED CHECK VALVE	2.000	PC																																																																			
VL1166A0	BB6-AR6 L FITTING	1.000	PC																																																																			
VL1174C0	D1.2 MM CALIBRATED D1.2 MM	1.000	PC																																																																			
VL1191A0	ONE WASHING DISTRIBUTOR OUTLETS KIT	1.000	PC																																																																			
VL1214A0	BAYONET - 6mm BARBED NRV VALVE	1.000	PC																																																																			
VM2172A0	LOCKING CLIP FOR PUMP WITH CIRCUIT	2.000	PC																																																																			
			KVL1213A	US PLUS COMPACT WASHING SYSTEM KIT	<table border="1"> <thead> <tr> <th>Code</th> <th>Description</th> <th>Qty</th> <th>UOM</th> </tr> </thead> <tbody> <tr> <td>0H2428A2</td> <td>XECC PLUS WASHING CIRCUIT PLAT</td> <td>1.000</td> <td>PC</td> </tr> </tbody> </table>	Code	Description	Qty	UOM	0H2428A2	XECC PLUS WASHING CIRCUIT PLAT	1.000	PC																																																									
Code	Description	Qty	UOM																																																																			
0H2428A2	XECC PLUS WASHING CIRCUIT PLAT	1.000	PC																																																																			



COMPONENT			SPARE PART																																																																																								
Code	Description	Image	Code	Description	Kit components																																																																																						
VL1019A	VIBRATION DETERGENT PUMP		KVL1213A	US PLUS COMPACT WASHING SYSTEM KIT	<table border="1"> <thead> <tr> <th>Code</th> <th>Description</th> <th>Qty</th> <th>UOM</th> </tr> </thead> <tbody> <tr> <td>EL1450A0</td> <td>US SELF-CLEANING WATER SOLENOID</td> <td>3.000</td> <td>PC</td> </tr> <tr> <td>GN1312A0</td> <td>RUBBER CABLE-PASSING NG DE=26 DI=15 SP=10</td> <td>1.000</td> <td>PC</td> </tr> <tr> <td>GN1526A0</td> <td>INT. D.=6.9 TH=1.8 O-RING</td> <td>7.000</td> <td>PC</td> </tr> <tr> <td>RC1018A0</td> <td>ZINC PLATED D12 ELASTIC CLAMP</td> <td>2.000</td> <td>PC</td> </tr> <tr> <td>RC1019A0</td> <td>D=10 ELASTIC CLAMP</td> <td>14.000</td> <td>PC</td> </tr> <tr> <td>RC1130A0</td> <td>130x2.6 CLAMP</td> <td>1.000</td> <td>PC</td> </tr> <tr> <td>RC1131A0</td> <td>200x2.6 BLACK CLAMP</td> <td>1.000</td> <td>PC</td> </tr> <tr> <td>RC1242A0</td> <td>D=10 CLOSED CAP</td> <td>2.000</td> <td>PC</td> </tr> <tr> <td>RC1356A0</td> <td>"STRAIGHT THREADED FEMALE END 8x1/4" BS</td> <td>1.000</td> <td>PC</td> </tr> <tr> <td>TB2821A0</td> <td>EPDM 6X10 L=40MM PIPE</td> <td>6.000</td> <td>PC</td> </tr> <tr> <td>TB3004A0</td> <td>TB2820A L=550mm EPDM BLACK PIPE</td> <td>1.000</td> <td>PC</td> </tr> <tr> <td>TB3005B0</td> <td>TB3132A L=550mm EPDM WHITE-BLUE PIPE</td> <td>1.000</td> <td>PC</td> </tr> <tr> <td>TB3469A0</td> <td></td> <td>1.000</td> <td>PC</td> </tr> <tr> <td>VL1019A0</td> <td>VIBRATION DETERGENT PUMP</td> <td></td> <td>1.000</td> <td>PC</td> </tr> <tr> <td>VL1047A1</td> <td>D6 PIPE HOLDER - D8 J.G. TERMINAL</td> <td></td> <td>1.000</td> <td>PC</td> </tr> <tr> <td>VL1054B0</td> <td>ONE WASHING SYSTEM INLET DISTRIBUTOR</td> <td></td> <td>1.000</td> <td>PC</td> </tr> <tr> <td>VL1102A1</td> <td>DETERGENT LINE FILTER + BARBED VNR 6 MM</td> <td></td> <td>1.000</td> <td>PC</td> </tr> <tr> <td>VL1128A1</td> <td>D6 BARBED CHECK VALVE</td> <td></td> <td>2.000</td> <td>PC</td> </tr> <tr> <td>VL1165A0</td> <td>BAM-BB6 STRAIGHT FITTING</td> <td></td> <td>1.000</td> <td>PC</td> </tr> </tbody> </table>	Code	Description	Qty	UOM	EL1450A0	US SELF-CLEANING WATER SOLENOID	3.000	PC	GN1312A0	RUBBER CABLE-PASSING NG DE=26 DI=15 SP=10	1.000	PC	GN1526A0	INT. D.=6.9 TH=1.8 O-RING	7.000	PC	RC1018A0	ZINC PLATED D12 ELASTIC CLAMP	2.000	PC	RC1019A0	D=10 ELASTIC CLAMP	14.000	PC	RC1130A0	130x2.6 CLAMP	1.000	PC	RC1131A0	200x2.6 BLACK CLAMP	1.000	PC	RC1242A0	D=10 CLOSED CAP	2.000	PC	RC1356A0	"STRAIGHT THREADED FEMALE END 8x1/4" BS	1.000	PC	TB2821A0	EPDM 6X10 L=40MM PIPE	6.000	PC	TB3004A0	TB2820A L=550mm EPDM BLACK PIPE	1.000	PC	TB3005B0	TB3132A L=550mm EPDM WHITE-BLUE PIPE	1.000	PC	TB3469A0		1.000	PC	VL1019A0	VIBRATION DETERGENT PUMP		1.000	PC	VL1047A1	D6 PIPE HOLDER - D8 J.G. TERMINAL		1.000	PC	VL1054B0	ONE WASHING SYSTEM INLET DISTRIBUTOR		1.000	PC	VL1102A1	DETERGENT LINE FILTER + BARBED VNR 6 MM		1.000	PC	VL1128A1	D6 BARBED CHECK VALVE		2.000	PC	VL1165A0	BAM-BB6 STRAIGHT FITTING		1.000	PC
Code	Description	Qty	UOM																																																																																								
EL1450A0	US SELF-CLEANING WATER SOLENOID	3.000	PC																																																																																								
GN1312A0	RUBBER CABLE-PASSING NG DE=26 DI=15 SP=10	1.000	PC																																																																																								
GN1526A0	INT. D.=6.9 TH=1.8 O-RING	7.000	PC																																																																																								
RC1018A0	ZINC PLATED D12 ELASTIC CLAMP	2.000	PC																																																																																								
RC1019A0	D=10 ELASTIC CLAMP	14.000	PC																																																																																								
RC1130A0	130x2.6 CLAMP	1.000	PC																																																																																								
RC1131A0	200x2.6 BLACK CLAMP	1.000	PC																																																																																								
RC1242A0	D=10 CLOSED CAP	2.000	PC																																																																																								
RC1356A0	"STRAIGHT THREADED FEMALE END 8x1/4" BS	1.000	PC																																																																																								
TB2821A0	EPDM 6X10 L=40MM PIPE	6.000	PC																																																																																								
TB3004A0	TB2820A L=550mm EPDM BLACK PIPE	1.000	PC																																																																																								
TB3005B0	TB3132A L=550mm EPDM WHITE-BLUE PIPE	1.000	PC																																																																																								
TB3469A0		1.000	PC																																																																																								
VL1019A0	VIBRATION DETERGENT PUMP		1.000	PC																																																																																							
VL1047A1	D6 PIPE HOLDER - D8 J.G. TERMINAL		1.000	PC																																																																																							
VL1054B0	ONE WASHING SYSTEM INLET DISTRIBUTOR		1.000	PC																																																																																							
VL1102A1	DETERGENT LINE FILTER + BARBED VNR 6 MM		1.000	PC																																																																																							
VL1128A1	D6 BARBED CHECK VALVE		2.000	PC																																																																																							
VL1165A0	BAM-BB6 STRAIGHT FITTING		1.000	PC																																																																																							

COMPONENT			SPARE PART																																																												
Code	Description	Image	Code	Description	Kit components																																																										
VL1019A	VIBRATION DETERGENT PUMP		KVL1213A	US PLUS COMPACT WASHING SYSTEM KIT	<table border="1"> <thead> <tr> <th>Code</th> <th>Description</th> <th>Qty</th> <th>UOM</th> </tr> </thead> <tbody> <tr> <td>VL1166A0</td> <td>BB6-AR6 L FITTING</td> <td>3.000</td> <td>PC</td> </tr> <tr> <td>VL1174C0</td> <td>D1.2 MM CALIBRATED D1.2 MM</td> <td>1.000</td> <td>PC</td> </tr> <tr> <td>VL1185A0</td> <td>2 WAYS PLUS WASHING DISTRIBUTOR</td> <td>1.000</td> <td>PC</td> </tr> <tr> <td>VL1398A0</td> <td>1/4 M N.O. CIL PRESSURE SWITCH</td> <td>1.000</td> <td>PC</td> </tr> <tr> <td>VM2172A0</td> <td>LOCKING CLIP FOR PUMP WITH CIRCUIT</td> <td>6.000</td> <td>PC</td> </tr> </tbody> </table>	Code	Description	Qty	UOM	VL1166A0	BB6-AR6 L FITTING	3.000	PC	VL1174C0	D1.2 MM CALIBRATED D1.2 MM	1.000	PC	VL1185A0	2 WAYS PLUS WASHING DISTRIBUTOR	1.000	PC	VL1398A0	1/4 M N.O. CIL PRESSURE SWITCH	1.000	PC	VM2172A0	LOCKING CLIP FOR PUMP WITH CIRCUIT	6.000	PC																																		
			Code		Description	Qty	UOM																																																								
VL1166A0	BB6-AR6 L FITTING	3.000	PC																																																												
VL1174C0	D1.2 MM CALIBRATED D1.2 MM	1.000	PC																																																												
VL1185A0	2 WAYS PLUS WASHING DISTRIBUTOR	1.000	PC																																																												
VL1398A0	1/4 M N.O. CIL PRESSURE SWITCH	1.000	PC																																																												
VM2172A0	LOCKING CLIP FOR PUMP WITH CIRCUIT	6.000	PC																																																												
KVL1212A	EUR COMPACT PLUS CLEANING SYSTEM KIT	<table border="1"> <thead> <tr> <th>Code</th> <th>Description</th> <th>Qty</th> <th>UOM</th> </tr> </thead> <tbody> <tr> <td>0H2428A2</td> <td>XECC PLUS WASHING CIRCUIT PLAT</td> <td>1.000</td> <td>PC</td> </tr> <tr> <td>EL1440A0</td> <td>WATER SELF CLEANING VALVE</td> <td>3.000</td> <td>PC</td> </tr> <tr> <td>GN1312A0</td> <td>RUBBER CABLE-PASSI NG DE=26 DI=15 SP=10</td> <td>1.000</td> <td>PC</td> </tr> <tr> <td>GN1526A0</td> <td>INT. D.=6.9 TH=1.8 O-RIN</td> <td>7.000</td> <td>PC</td> </tr> <tr> <td>RC1018A0</td> <td>ZINC PLATED D12 ELASTIC CLAMP</td> <td>2.000</td> <td>PC</td> </tr> <tr> <td>RC1019A0</td> <td>D=10 ELASTIC CLAMP</td> <td>14.000</td> <td>PC</td> </tr> <tr> <td>RC1130A0</td> <td>130x2.6 CLAM</td> <td>1.000</td> <td>PC</td> </tr> <tr> <td>RC1131A0</td> <td>200x2.6 BLACK CLAMP</td> <td>1.000</td> <td>PC</td> </tr> <tr> <td>RC1242A0</td> <td>D=10 CLOSED CAP</td> <td>2.000</td> <td>PC</td> </tr> <tr> <td>RC1356A0</td> <td>*STRAIGHT THREADED FEMALE END 8x1/4" BS</td> <td>1.000</td> <td>PC</td> </tr> <tr> <td>TB2821A0</td> <td>EPDM 6X10 L=40MM PIPE</td> <td>6.000</td> <td>PC</td> </tr> <tr> <td>TB3004A0</td> <td>TB2820A L=550mm EPDM BLACK PIPE</td> <td>2.000</td> <td>PC</td> </tr> <tr> <td>TB3005B0</td> <td>TB3132A L=550mm EPDM WHITE-BLUE PIPE</td> <td>1.000</td> <td>PC</td> </tr> <tr> <td>TB3469A0</td> <td></td> <td>1.000</td> <td>PC</td> </tr> </tbody> </table>	Code		Description	Qty	UOM	0H2428A2	XECC PLUS WASHING CIRCUIT PLAT	1.000	PC	EL1440A0	WATER SELF CLEANING VALVE	3.000	PC	GN1312A0	RUBBER CABLE-PASSI NG DE=26 DI=15 SP=10	1.000	PC	GN1526A0	INT. D.=6.9 TH=1.8 O-RIN	7.000	PC	RC1018A0	ZINC PLATED D12 ELASTIC CLAMP	2.000	PC	RC1019A0	D=10 ELASTIC CLAMP	14.000	PC	RC1130A0	130x2.6 CLAM	1.000	PC	RC1131A0	200x2.6 BLACK CLAMP	1.000	PC	RC1242A0	D=10 CLOSED CAP	2.000	PC	RC1356A0	*STRAIGHT THREADED FEMALE END 8x1/4" BS	1.000	PC	TB2821A0	EPDM 6X10 L=40MM PIPE	6.000	PC	TB3004A0	TB2820A L=550mm EPDM BLACK PIPE	2.000	PC	TB3005B0	TB3132A L=550mm EPDM WHITE-BLUE PIPE	1.000	PC	TB3469A0		1.000	PC
Code		Description	Qty		UOM																																																										
0H2428A2		XECC PLUS WASHING CIRCUIT PLAT	1.000		PC																																																										
EL1440A0		WATER SELF CLEANING VALVE	3.000		PC																																																										
GN1312A0		RUBBER CABLE-PASSI NG DE=26 DI=15 SP=10	1.000		PC																																																										
GN1526A0		INT. D.=6.9 TH=1.8 O-RIN	7.000		PC																																																										
RC1018A0		ZINC PLATED D12 ELASTIC CLAMP	2.000	PC																																																											
RC1019A0		D=10 ELASTIC CLAMP	14.000	PC																																																											
RC1130A0		130x2.6 CLAM	1.000	PC																																																											
RC1131A0		200x2.6 BLACK CLAMP	1.000	PC																																																											
RC1242A0		D=10 CLOSED CAP	2.000	PC																																																											
RC1356A0		*STRAIGHT THREADED FEMALE END 8x1/4" BS	1.000	PC																																																											
TB2821A0	EPDM 6X10 L=40MM PIPE	6.000	PC																																																												
TB3004A0	TB2820A L=550mm EPDM BLACK PIPE	2.000	PC																																																												
TB3005B0	TB3132A L=550mm EPDM WHITE-BLUE PIPE	1.000	PC																																																												
TB3469A0		1.000	PC																																																												



COMPONENT			SPARE PART																																																		
Code	Description	Image	Code	Description	Kit components																																																
VL1019A	VIBRATION DETERGENT PUMP		KVL1212A	EUR COMPACT PLUS CLEANING SYSTEM KIT	<table border="1"> <thead> <tr> <th>Code</th> <th>Description</th> <th>Qty</th> <th>UOM</th> </tr> </thead> <tbody> <tr> <td>VL1019A0</td> <td>VIBRATION DETERGENT PUMP</td> <td>1.000</td> <td>PC</td> </tr> <tr> <td>VL1047A1</td> <td>D6 PIPE HOLDER - D8 J.G. TERMINAL</td> <td>1.000</td> <td>PC</td> </tr> <tr> <td>VL1054B0</td> <td>ONE WASHING SYS INLET DISTRIBUTOR</td> <td>1.000</td> <td>PC</td> </tr> <tr> <td>VL1102A1</td> <td>DETERGENT LINE FILTER + BARBED VNR 6 MM</td> <td>1.000</td> <td>PC</td> </tr> <tr> <td>VL1128A1</td> <td>D6 BARBED CHECK VALVE</td> <td>2.000</td> <td>PC</td> </tr> <tr> <td>VL1165A0</td> <td>BAM-BB6 STRAIGHT FITTING</td> <td>1.000</td> <td>PC</td> </tr> <tr> <td>VL1166A0</td> <td>BB6-AR6 L FITTING</td> <td>3.000</td> <td>PC</td> </tr> <tr> <td>VL1174C0</td> <td>D1.2 MM CALIBRATED D1.2 MM</td> <td>1.000</td> <td>PC</td> </tr> <tr> <td>VL1185A0</td> <td>2 WAYS PLUS WASHING DISTRIBUTOR</td> <td>1.000</td> <td>PC</td> </tr> <tr> <td>VL1398A0</td> <td>1/4 M N.O. CIL PRESSURE SWITCH</td> <td>1.000</td> <td>PC</td> </tr> <tr> <td>VM2172A0</td> <td>LOCKING CLIP FOR PUMP WITH CIRCUIT</td> <td>6.000</td> <td>PC</td> </tr> </tbody> </table>	Code	Description	Qty	UOM	VL1019A0	VIBRATION DETERGENT PUMP	1.000	PC	VL1047A1	D6 PIPE HOLDER - D8 J.G. TERMINAL	1.000	PC	VL1054B0	ONE WASHING SYS INLET DISTRIBUTOR	1.000	PC	VL1102A1	DETERGENT LINE FILTER + BARBED VNR 6 MM	1.000	PC	VL1128A1	D6 BARBED CHECK VALVE	2.000	PC	VL1165A0	BAM-BB6 STRAIGHT FITTING	1.000	PC	VL1166A0	BB6-AR6 L FITTING	3.000	PC	VL1174C0	D1.2 MM CALIBRATED D1.2 MM	1.000	PC	VL1185A0	2 WAYS PLUS WASHING DISTRIBUTOR	1.000	PC	VL1398A0	1/4 M N.O. CIL PRESSURE SWITCH	1.000	PC	VM2172A0	LOCKING CLIP FOR PUMP WITH CIRCUIT	6.000	PC
			Code	Description	Qty	UOM																																															
VL1019A0	VIBRATION DETERGENT PUMP	1.000	PC																																																		
VL1047A1	D6 PIPE HOLDER - D8 J.G. TERMINAL	1.000	PC																																																		
VL1054B0	ONE WASHING SYS INLET DISTRIBUTOR	1.000	PC																																																		
VL1102A1	DETERGENT LINE FILTER + BARBED VNR 6 MM	1.000	PC																																																		
VL1128A1	D6 BARBED CHECK VALVE	2.000	PC																																																		
VL1165A0	BAM-BB6 STRAIGHT FITTING	1.000	PC																																																		
VL1166A0	BB6-AR6 L FITTING	3.000	PC																																																		
VL1174C0	D1.2 MM CALIBRATED D1.2 MM	1.000	PC																																																		
VL1185A0	2 WAYS PLUS WASHING DISTRIBUTOR	1.000	PC																																																		
VL1398A0	1/4 M N.O. CIL PRESSURE SWITCH	1.000	PC																																																		
VM2172A0	LOCKING CLIP FOR PUMP WITH CIRCUIT	6.000	PC																																																		
KVL1211A	ONE COMPACT AND 0523-EP WASH. SYSTEM KIT	<table border="1"> <thead> <tr> <th>Code</th> <th>Description</th> <th>Qty</th> <th>UOM</th> </tr> </thead> <tbody> <tr> <td>0H2427A0</td> <td>XECC WASHING CIRCUIT HOLDING PLATE</td> <td>1.000</td> <td>PC</td> </tr> <tr> <td>EL1440A0</td> <td>WATER SELF CLEANING VALVE</td> <td>1.000</td> <td>PC</td> </tr> <tr> <td>GN1526A0</td> <td>INT. D.=6.9 TH=1.8 O-RIN</td> <td>3.000</td> <td>PC</td> </tr> <tr> <td>RC1018A0</td> <td>ZINC PLATED D12 ELASTIC CLAMP</td> <td>1.000</td> <td>PC</td> </tr> <tr> <td>RC1019A0</td> <td>D=10 ELASTIC CLAMP</td> <td>14.000</td> <td>PC</td> </tr> <tr> <td>RC1130A0</td> <td>130x2,6 CLAM</td> <td>1.000</td> <td>PC</td> </tr> <tr> <td>RC1242A0</td> <td>D=10 CLOSED CAP</td> <td>2.000</td> <td>PC</td> </tr> </tbody> </table>	Code	Description	Qty	UOM	0H2427A0	XECC WASHING CIRCUIT HOLDING PLATE	1.000	PC	EL1440A0	WATER SELF CLEANING VALVE	1.000	PC	GN1526A0	INT. D.=6.9 TH=1.8 O-RIN	3.000	PC	RC1018A0	ZINC PLATED D12 ELASTIC CLAMP	1.000	PC	RC1019A0	D=10 ELASTIC CLAMP	14.000	PC	RC1130A0	130x2,6 CLAM	1.000	PC	RC1242A0	D=10 CLOSED CAP	2.000	PC																			
Code	Description	Qty	UOM																																																		
0H2427A0	XECC WASHING CIRCUIT HOLDING PLATE	1.000	PC																																																		
EL1440A0	WATER SELF CLEANING VALVE	1.000	PC																																																		
GN1526A0	INT. D.=6.9 TH=1.8 O-RIN	3.000	PC																																																		
RC1018A0	ZINC PLATED D12 ELASTIC CLAMP	1.000	PC																																																		
RC1019A0	D=10 ELASTIC CLAMP	14.000	PC																																																		
RC1130A0	130x2,6 CLAM	1.000	PC																																																		
RC1242A0	D=10 CLOSED CAP	2.000	PC																																																		



COMPONENT			SPARE PART																																																																																	
Code	Description	Image	Code	Description	Kit components																																																																															
VL1019A	VIBRATION DETERGENT PUMP		KVL1211A	ONE COMPACT AND 0523-EP WASH. SYSTEM KIT	<table border="1"> <thead> <tr> <th>Code</th> <th>Description</th> <th>Qty</th> <th>UOM</th> </tr> </thead> <tbody> <tr> <td>TB1402A0</td> <td>TB2820A-DETE RGENT CIRCUIT-FILTE R PIPE</td> <td>1.000</td> <td>PC</td> </tr> <tr> <td>TB2821A0</td> <td>EPDM 6X10 L=40MM PIPE</td> <td>6.000</td> <td>PC</td> </tr> <tr> <td>TB3004A0</td> <td>TB2820A L=550mm EPDM BLACK PIPE</td> <td>1.000</td> <td>PC</td> </tr> <tr> <td>TB3469A0</td> <td></td> <td>1.000</td> <td>PC</td> </tr> <tr> <td>VI1220A1</td> <td>4,2x12 TCB SELF-TAPPIN G SCREW</td> <td>4.000</td> <td>PC</td> </tr> <tr> <td>VL1019A0</td> <td>VIBRATION DETERGENT PUMP</td> <td>1.000</td> <td>PC</td> </tr> <tr> <td>VL1047A1</td> <td>D6 PIPE HOLDER - D8 J.G. TERMINAL</td> <td>1.000</td> <td>PC</td> </tr> <tr> <td>VL1054B0</td> <td>ONE WASHING SYS INLET DISTRIBUTOR</td> <td>1.000</td> <td>PC</td> </tr> <tr> <td>VL1102A1</td> <td>DETERGENT LINE FILTER + BARBED VNR 6 MM</td> <td>1.000</td> <td>PC</td> </tr> <tr> <td>VL1128A1</td> <td>D6 BARBED CHECK VALVE</td> <td>2.000</td> <td>PC</td> </tr> <tr> <td>VL1165A0</td> <td>BAM-BB6 STRAIGHT FITTING</td> <td>1.000</td> <td>PC</td> </tr> <tr> <td>VL1166A0</td> <td>BB6-AR6 L FITTING</td> <td>1.000</td> <td>PC</td> </tr> <tr> <td>VL1174C0</td> <td>D1.2 MM CALIBRATED D1.2 MM</td> <td>1.000</td> <td>PC</td> </tr> <tr> <td>VL1191A0</td> <td>ONE WASHING DISTRIBUTOR OUTLETS KIT</td> <td>1.000</td> <td>PC</td> </tr> <tr> <td>VM2172A0</td> <td>LOCKING CLIP FOR PUMP WITH CIRCUIT</td> <td>2.000</td> <td>PC</td> </tr> </tbody> </table>	Code	Description	Qty	UOM	TB1402A0	TB2820A-DETE RGENT CIRCUIT-FILTE R PIPE	1.000	PC	TB2821A0	EPDM 6X10 L=40MM PIPE	6.000	PC	TB3004A0	TB2820A L=550mm EPDM BLACK PIPE	1.000	PC	TB3469A0		1.000	PC	VI1220A1	4,2x12 TCB SELF-TAPPIN G SCREW	4.000	PC	VL1019A0	VIBRATION DETERGENT PUMP	1.000	PC	VL1047A1	D6 PIPE HOLDER - D8 J.G. TERMINAL	1.000	PC	VL1054B0	ONE WASHING SYS INLET DISTRIBUTOR	1.000	PC	VL1102A1	DETERGENT LINE FILTER + BARBED VNR 6 MM	1.000	PC	VL1128A1	D6 BARBED CHECK VALVE	2.000	PC	VL1165A0	BAM-BB6 STRAIGHT FITTING	1.000	PC	VL1166A0	BB6-AR6 L FITTING	1.000	PC	VL1174C0	D1.2 MM CALIBRATED D1.2 MM	1.000	PC	VL1191A0	ONE WASHING DISTRIBUTOR OUTLETS KIT	1.000	PC	VM2172A0	LOCKING CLIP FOR PUMP WITH CIRCUIT	2.000	PC	KVL1208A	US PLUS 2 ROTOR ARMS WASHING SYSTEM KIT	<table border="1"> <thead> <tr> <th>Code</th> <th>Description</th> <th>Qty</th> <th>UOM</th> </tr> </thead> <tbody> <tr> <td>0H2354A1</td> <td>XEVC-XEVL PLUS WASHING CIRCUIT PLAT</td> <td>1.000</td> <td>PC</td> </tr> <tr> <td>EL1450A0</td> <td>US SELF-CLEANIN G WATER SOLENOID</td> <td>4.000</td> <td>PC</td> </tr> </tbody> </table>	Code	Description	Qty	UOM	0H2354A1	XEVC-XEVL PLUS WASHING CIRCUIT PLAT	1.000	PC	EL1450A0	US SELF-CLEANIN G WATER SOLENOID	4.000	PC
			Code		Description	Qty	UOM																																																																													
TB1402A0	TB2820A-DETE RGENT CIRCUIT-FILTE R PIPE	1.000	PC																																																																																	
TB2821A0	EPDM 6X10 L=40MM PIPE	6.000	PC																																																																																	
TB3004A0	TB2820A L=550mm EPDM BLACK PIPE	1.000	PC																																																																																	
TB3469A0		1.000	PC																																																																																	
VI1220A1	4,2x12 TCB SELF-TAPPIN G SCREW	4.000	PC																																																																																	
VL1019A0	VIBRATION DETERGENT PUMP	1.000	PC																																																																																	
VL1047A1	D6 PIPE HOLDER - D8 J.G. TERMINAL	1.000	PC																																																																																	
VL1054B0	ONE WASHING SYS INLET DISTRIBUTOR	1.000	PC																																																																																	
VL1102A1	DETERGENT LINE FILTER + BARBED VNR 6 MM	1.000	PC																																																																																	
VL1128A1	D6 BARBED CHECK VALVE	2.000	PC																																																																																	
VL1165A0	BAM-BB6 STRAIGHT FITTING	1.000	PC																																																																																	
VL1166A0	BB6-AR6 L FITTING	1.000	PC																																																																																	
VL1174C0	D1.2 MM CALIBRATED D1.2 MM	1.000	PC																																																																																	
VL1191A0	ONE WASHING DISTRIBUTOR OUTLETS KIT	1.000	PC																																																																																	
VM2172A0	LOCKING CLIP FOR PUMP WITH CIRCUIT	2.000	PC																																																																																	
Code	Description	Qty	UOM																																																																																	
0H2354A1	XEVC-XEVL PLUS WASHING CIRCUIT PLAT	1.000	PC																																																																																	
EL1450A0	US SELF-CLEANIN G WATER SOLENOID	4.000	PC																																																																																	





COMPONENT			SPARE PART					
Code	Description	Image	Code	Description	Kit components			
VL1019A	VIBRATION DETERGENT PUMP		KVL1208A	US PLUS 2 ROTOR ARMS WASHING SYSTEM KIT	Code	Description	Qty	UOM
					GN1526A0	INT. D.=6.9 TH=1.8 O-RIN	9.000	PC
					RC1018A0	ZINC PLATED D12 ELASTIC CLAMP	3.000	PC
					RC1019A0	D=10 ELASTIC CLAMP	2.000	PC
					RC1130A0	130x2.6 CLAM	1.000	PC
					RC1131A0	200x2.6 BLACK CLAMP	3.000	PC
					RC1242A0	D=10 CLOSED CAP	2.000	PC
					RC1356A0	"STRAIGHT THREADED FEMALE END 8x1/4" BS	1.000	PC
					TB2821A0	EPDM 6X10 L=40MM PIPE	6.000	PC
					TB2994A0	HOOD DETERGENT PIPE	1.000	PC
					TB3004A0	TB2820A L=550mm EPDM BLACK PIPE	1.000	PC
					TB3005B0	TB3132A L=550mm EPDM WHITE-BLUE PIPE	1.000	PC
					TB3440A0	TB3132A L=1050mm EPDM WHITE-BLUE PIPE	1.000	PC
					VL1019A0	VIBRATION DETERGENT PUMP	1.000	PC
					VL1047A1	D6 PIPE HOLDER - D8 J.G. TERMINAL	1.000	PC
					VL1102A1	DETERGENT LINE FILTER + BARBED VNR 6 MM	1.000	PC
					VL1128A1	D6 BARBED CHECK VALVE	2.000	PC
					VL1141A1	BB6-BB6 STRAIGHT CONNECTION	1.000	PC
					VL1166A0	BB6-AR6 L FITTING	4.000	PC
					VL1174C0	D1.2 MM CALIBRATED D1.2 MM	1.000	PC





COMPONENT			SPARE PART																																															
Code	Description	Image	Code	Description	Kit components																																													
VL1019A	VIBRATION DETERGENT PUMP		KVL1208A	US PLUS 2 ROTOR ARMS WASHING SYSTEM KIT	<table border="1"> <thead> <tr> <th>Code</th> <th>Description</th> <th>Qty</th> <th>UOM</th> </tr> </thead> <tbody> <tr> <td>VL1186A0</td> <td>3 WAYS PLUS WASHING DISTRIBUTOR</td> <td>1.000</td> <td>PC</td> </tr> <tr> <td>VL1190A0</td> <td>PLUS WASHING SYSTEM INLET DISTRIBUTOR</td> <td>1.000</td> <td>PC</td> </tr> <tr> <td>VL1214A0</td> <td>BAYONET - 6mm BARBED NRV VALVE</td> <td>1.000</td> <td>PC</td> </tr> <tr> <td>VL1398A0</td> <td>1/4 M N.O. CIL PRESSURE SWITCH</td> <td>1.000</td> <td>PC</td> </tr> <tr> <td>VM1605A0</td> <td>CLIP TWIST LOCK DIAM. 10,2-12,7 MM</td> <td>3.000</td> <td>PC</td> </tr> <tr> <td>VM2172A0</td> <td>LOCKING CLIP FOR PUMP WITH CIRCUIT</td> <td>5.000</td> <td>PC</td> </tr> </tbody> </table>	Code	Description	Qty	UOM	VL1186A0	3 WAYS PLUS WASHING DISTRIBUTOR	1.000	PC	VL1190A0	PLUS WASHING SYSTEM INLET DISTRIBUTOR	1.000	PC	VL1214A0	BAYONET - 6mm BARBED NRV VALVE	1.000	PC	VL1398A0	1/4 M N.O. CIL PRESSURE SWITCH	1.000	PC	VM1605A0	CLIP TWIST LOCK DIAM. 10,2-12,7 MM	3.000	PC	VM2172A0	LOCKING CLIP FOR PUMP WITH CIRCUIT	5.000	PC																	
			Code	Description	Qty	UOM																																												
VL1186A0	3 WAYS PLUS WASHING DISTRIBUTOR	1.000	PC																																															
VL1190A0	PLUS WASHING SYSTEM INLET DISTRIBUTOR	1.000	PC																																															
VL1214A0	BAYONET - 6mm BARBED NRV VALVE	1.000	PC																																															
VL1398A0	1/4 M N.O. CIL PRESSURE SWITCH	1.000	PC																																															
VM1605A0	CLIP TWIST LOCK DIAM. 10,2-12,7 MM	3.000	PC																																															
VM2172A0	LOCKING CLIP FOR PUMP WITH CIRCUIT	5.000	PC																																															
KVL1207A	US PLUS 1 ROTOR ARM WASHING SYSTEM KIT	<table border="1"> <thead> <tr> <th>Code</th> <th>Description</th> <th>Qty</th> <th>UOM</th> </tr> </thead> <tbody> <tr> <td>0H2354A1</td> <td>XEVC-XEVL PLUS WASHING CIRCUIT PLAT</td> <td>1.000</td> <td>PC</td> </tr> <tr> <td>EL1450A0</td> <td>US SELF-CLEANIN G WATER SOLENOID</td> <td>3.000</td> <td>PC</td> </tr> <tr> <td>GN1526A0</td> <td>INT. D.=6.9 TH=1.8 O-RIN</td> <td>7.000</td> <td>PC</td> </tr> <tr> <td>RC1018A0</td> <td>ZINC PLATED D12 ELASTIC CLAMP</td> <td>2.000</td> <td>PC</td> </tr> <tr> <td>RC1019A0</td> <td>D=10 ELASTIC CLAMP</td> <td>14.000</td> <td>PC</td> </tr> <tr> <td>RC1130A0</td> <td>130x2,6 CLAM</td> <td>1.000</td> <td>PC</td> </tr> <tr> <td>RC1131A0</td> <td>200x2,6 BLACK CLAMP</td> <td>2.000</td> <td>PC</td> </tr> <tr> <td>RC1242A0</td> <td>D=10 CLOSED CAP</td> <td>2.000</td> <td>PC</td> </tr> <tr> <td>RC1356A0</td> <td>"STRAIGHT THREADED FEMALE END 8x1/4" BS</td> <td>1.000</td> <td>PC</td> </tr> <tr> <td>TB2821A0</td> <td>EPDM 6X10 L=40MM PIPE</td> <td>6.000</td> <td>PC</td> </tr> <tr> <td>TB3004A0</td> <td>TB2820A L=550mm EPDM BLACK PIPE</td> <td>1.000</td> <td>PC</td> </tr> </tbody> </table>	Code	Description	Qty	UOM	0H2354A1	XEVC-XEVL PLUS WASHING CIRCUIT PLAT	1.000	PC	EL1450A0	US SELF-CLEANIN G WATER SOLENOID	3.000	PC	GN1526A0	INT. D.=6.9 TH=1.8 O-RIN	7.000	PC	RC1018A0	ZINC PLATED D12 ELASTIC CLAMP	2.000	PC	RC1019A0	D=10 ELASTIC CLAMP	14.000	PC	RC1130A0	130x2,6 CLAM	1.000	PC	RC1131A0	200x2,6 BLACK CLAMP	2.000	PC	RC1242A0	D=10 CLOSED CAP	2.000	PC	RC1356A0	"STRAIGHT THREADED FEMALE END 8x1/4" BS	1.000	PC	TB2821A0	EPDM 6X10 L=40MM PIPE	6.000	PC	TB3004A0	TB2820A L=550mm EPDM BLACK PIPE	1.000	PC
Code	Description	Qty	UOM																																															
0H2354A1	XEVC-XEVL PLUS WASHING CIRCUIT PLAT	1.000	PC																																															
EL1450A0	US SELF-CLEANIN G WATER SOLENOID	3.000	PC																																															
GN1526A0	INT. D.=6.9 TH=1.8 O-RIN	7.000	PC																																															
RC1018A0	ZINC PLATED D12 ELASTIC CLAMP	2.000	PC																																															
RC1019A0	D=10 ELASTIC CLAMP	14.000	PC																																															
RC1130A0	130x2,6 CLAM	1.000	PC																																															
RC1131A0	200x2,6 BLACK CLAMP	2.000	PC																																															
RC1242A0	D=10 CLOSED CAP	2.000	PC																																															
RC1356A0	"STRAIGHT THREADED FEMALE END 8x1/4" BS	1.000	PC																																															
TB2821A0	EPDM 6X10 L=40MM PIPE	6.000	PC																																															
TB3004A0	TB2820A L=550mm EPDM BLACK PIPE	1.000	PC																																															





COMPONENT			SPARE PART																																																																																	
Code	Description	Image	Code	Description	Kit components																																																																															
VL1019A	VIBRATION DETERGENT PUMP		KVL1207A	US PLUS 1 ROTOR ARM WASHING SYSTEM KIT	<table border="1"> <thead> <tr> <th>Code</th> <th>Description</th> <th>Qty</th> <th>UOM</th> </tr> </thead> <tbody> <tr> <td>TB3005B0</td> <td>TB3132A L=550mm EPDM WHITE-BLUE PIPE</td> <td>1.000</td> <td>PC</td> </tr> <tr> <td>TB3225B0</td> <td>TB2820A-TAN K-WASHYNG SYS CONNECTION</td> <td>1.000</td> <td>PC</td> </tr> <tr> <td>TB3252A0</td> <td></td> <td>1.000</td> <td>PC</td> </tr> <tr> <td>VL1019A0</td> <td>VIBRATION DETERGENT PUMP</td> <td>1.000</td> <td>PC</td> </tr> <tr> <td>VL1047A1</td> <td>D6 PIPE HOLDER - D8 J.G. TERMINAL</td> <td>1.000</td> <td>PC</td> </tr> <tr> <td>VL1102A1</td> <td>DETERGENT LINE FILTER + BARBED VNR 6 MM</td> <td>1.000</td> <td>PC</td> </tr> <tr> <td>VL1128A1</td> <td>D6 BARBED CHECK VALVE</td> <td>2.000</td> <td>PC</td> </tr> <tr> <td>VL1166A0</td> <td>BB6-AR6 L FITTING</td> <td>3.000</td> <td>PC</td> </tr> <tr> <td>VL1174C0</td> <td>D1.2 MM CALIBRATED D1.2 MM</td> <td>1.000</td> <td>PC</td> </tr> <tr> <td>VL1185A0</td> <td>2 WAYS PLUS WASHING DISTRIBUTOR</td> <td>1.000</td> <td>PC</td> </tr> <tr> <td>VL1190A0</td> <td>PLUS WASHING SYSTEM INLET DISTRIBUTOR</td> <td>1.000</td> <td>PC</td> </tr> <tr> <td>VL1214A0</td> <td>BAYONET - 6mm BARBED NRV VALVE</td> <td>1.000</td> <td>PC</td> </tr> <tr> <td>VL1398A0</td> <td>1/4 M N.O. CIL PRESSURE SWITCH</td> <td>1.000</td> <td>PC</td> </tr> <tr> <td>VM1605A0</td> <td>CLIP TWIST LOCK DIAM. 10,2-12,7 MM</td> <td>3.000</td> <td>PC</td> </tr> <tr> <td>VM2172A0</td> <td>LOCKING CLIP FOR PUMP WITH CIRCUIT</td> <td>3.000</td> <td>PC</td> </tr> </tbody> </table>	Code	Description	Qty	UOM	TB3005B0	TB3132A L=550mm EPDM WHITE-BLUE PIPE	1.000	PC	TB3225B0	TB2820A-TAN K-WASHYNG SYS CONNECTION	1.000	PC	TB3252A0		1.000	PC	VL1019A0	VIBRATION DETERGENT PUMP	1.000	PC	VL1047A1	D6 PIPE HOLDER - D8 J.G. TERMINAL	1.000	PC	VL1102A1	DETERGENT LINE FILTER + BARBED VNR 6 MM	1.000	PC	VL1128A1	D6 BARBED CHECK VALVE	2.000	PC	VL1166A0	BB6-AR6 L FITTING	3.000	PC	VL1174C0	D1.2 MM CALIBRATED D1.2 MM	1.000	PC	VL1185A0	2 WAYS PLUS WASHING DISTRIBUTOR	1.000	PC	VL1190A0	PLUS WASHING SYSTEM INLET DISTRIBUTOR	1.000	PC	VL1214A0	BAYONET - 6mm BARBED NRV VALVE	1.000	PC	VL1398A0	1/4 M N.O. CIL PRESSURE SWITCH	1.000	PC	VM1605A0	CLIP TWIST LOCK DIAM. 10,2-12,7 MM	3.000	PC	VM2172A0	LOCKING CLIP FOR PUMP WITH CIRCUIT	3.000	PC	KVL1198A	MM EU HOOD CLEANING SYSTEM KIT	<table border="1"> <thead> <tr> <th>Code</th> <th>Description</th> <th>Qty</th> <th>UOM</th> </tr> </thead> <tbody> <tr> <td>0H2213A1</td> <td>HOOD WATER CIRCUIT PLAT</td> <td>1.000</td> <td>PC</td> </tr> <tr> <td>EL1440A0</td> <td>WATER SELF CLEANING VALVE</td> <td>2.000</td> <td>PC</td> </tr> </tbody> </table>	Code	Description	Qty	UOM	0H2213A1	HOOD WATER CIRCUIT PLAT	1.000	PC	EL1440A0	WATER SELF CLEANING VALVE	2.000	PC
			Code	Description	Qty	UOM																																																																														
TB3005B0	TB3132A L=550mm EPDM WHITE-BLUE PIPE	1.000	PC																																																																																	
TB3225B0	TB2820A-TAN K-WASHYNG SYS CONNECTION	1.000	PC																																																																																	
TB3252A0		1.000	PC																																																																																	
VL1019A0	VIBRATION DETERGENT PUMP	1.000	PC																																																																																	
VL1047A1	D6 PIPE HOLDER - D8 J.G. TERMINAL	1.000	PC																																																																																	
VL1102A1	DETERGENT LINE FILTER + BARBED VNR 6 MM	1.000	PC																																																																																	
VL1128A1	D6 BARBED CHECK VALVE	2.000	PC																																																																																	
VL1166A0	BB6-AR6 L FITTING	3.000	PC																																																																																	
VL1174C0	D1.2 MM CALIBRATED D1.2 MM	1.000	PC																																																																																	
VL1185A0	2 WAYS PLUS WASHING DISTRIBUTOR	1.000	PC																																																																																	
VL1190A0	PLUS WASHING SYSTEM INLET DISTRIBUTOR	1.000	PC																																																																																	
VL1214A0	BAYONET - 6mm BARBED NRV VALVE	1.000	PC																																																																																	
VL1398A0	1/4 M N.O. CIL PRESSURE SWITCH	1.000	PC																																																																																	
VM1605A0	CLIP TWIST LOCK DIAM. 10,2-12,7 MM	3.000	PC																																																																																	
VM2172A0	LOCKING CLIP FOR PUMP WITH CIRCUIT	3.000	PC																																																																																	
Code	Description	Qty	UOM																																																																																	
0H2213A1	HOOD WATER CIRCUIT PLAT	1.000	PC																																																																																	
EL1440A0	WATER SELF CLEANING VALVE	2.000	PC																																																																																	

COMPONENT			SPARE PART																																																																																						
Code	Description	Image	Code	Description	Kit components																																																																																				
VL1019A	VIBRATION DETERGENT PUMP		KVL1198A	MM EU HOOD CLEANING SYSTEM KIT	<table border="1"> <thead> <tr> <th>Code</th> <th>Description</th> <th>Qty</th> <th>UOM</th> </tr> </thead> <tbody> <tr> <td>GN1526A0</td> <td>INT. D.=6.9 TH=1.8 O-RIN</td> <td>5.000</td> <td>PC</td> </tr> <tr> <td>RC1018A0</td> <td>ZINC PLATED D12 ELASTIC CLAMP</td> <td>4.000</td> <td>PC</td> </tr> <tr> <td>RC1019A0</td> <td>D=10 ELASTIC CLAMP</td> <td>16.000</td> <td>PC</td> </tr> <tr> <td>RC1131A0</td> <td>200x2.6 BLACK CLAMP</td> <td>1.000</td> <td>PC</td> </tr> <tr> <td>RC1242A0</td> <td>D=10 CLOSED CAP</td> <td>2.000</td> <td>PC</td> </tr> <tr> <td>TB2821A0</td> <td>EPDM 6X10 L=40MM PIPE</td> <td>6.000</td> <td>PC</td> </tr> <tr> <td>TB2994A0</td> <td>HOOD DETERGENT PIPE</td> <td>2.000</td> <td>PC</td> </tr> <tr> <td>TB3252A0</td> <td></td> <td>2.000</td> <td>PC</td> </tr> <tr> <td>VI1220A1</td> <td>4,2x12 TCB SELF-TAPPIN G SCREW</td> <td>3.000</td> <td>PC</td> </tr> <tr> <td>VL1019A0</td> <td>VIBRATION DETERGENT PUMP</td> <td>1.000</td> <td>PC</td> </tr> <tr> <td>VL1047A1</td> <td>D6 PIPE HOLDER - D8 J.G. TERMINAL</td> <td>2.000</td> <td>PC</td> </tr> <tr> <td>VL1054B0</td> <td>ONE WASHING SYS INLET DISTRIBUTOR</td> <td>1.000</td> <td>PC</td> </tr> <tr> <td>VL1102A1</td> <td>DETERGENT LINE FILTER + BARBED VNR 6 MM</td> <td>1.000</td> <td>PC</td> </tr> <tr> <td>VL1127A1</td> <td>6mm BARBED T-SHAPED FITTING</td> <td>1.000</td> <td>PC</td> </tr> <tr> <td>VL1128A1</td> <td>D6 BARBED CHECK VALVE</td> <td>2.000</td> <td>PC</td> </tr> <tr> <td>VL1165A0</td> <td>BAM-BB6 STRAIGHT FITTING</td> <td>1.000</td> <td>PC</td> </tr> <tr> <td>VL1166A0</td> <td>BB6-AR6 L FITTING</td> <td>2.000</td> <td>PC</td> </tr> <tr> <td>VL1174C0</td> <td>D1.2 MM CALIBRATED D1.2 MM</td> <td>1.000</td> <td>PC</td> </tr> <tr> <td>VL1191A0</td> <td>ONE WASHING DISTRIBUTOR OUTLETS KIT</td> <td>1.000</td> <td>PC</td> </tr> <tr> <td>VL1214A0</td> <td>BAYONET - 6mm BARBED NRV VALVE</td> <td>1.000</td> <td>PC</td> </tr> </tbody> </table>	Code	Description	Qty	UOM	GN1526A0	INT. D.=6.9 TH=1.8 O-RIN	5.000	PC	RC1018A0	ZINC PLATED D12 ELASTIC CLAMP	4.000	PC	RC1019A0	D=10 ELASTIC CLAMP	16.000	PC	RC1131A0	200x2.6 BLACK CLAMP	1.000	PC	RC1242A0	D=10 CLOSED CAP	2.000	PC	TB2821A0	EPDM 6X10 L=40MM PIPE	6.000	PC	TB2994A0	HOOD DETERGENT PIPE	2.000	PC	TB3252A0		2.000	PC	VI1220A1	4,2x12 TCB SELF-TAPPIN G SCREW	3.000	PC	VL1019A0	VIBRATION DETERGENT PUMP	1.000	PC	VL1047A1	D6 PIPE HOLDER - D8 J.G. TERMINAL	2.000	PC	VL1054B0	ONE WASHING SYS INLET DISTRIBUTOR	1.000	PC	VL1102A1	DETERGENT LINE FILTER + BARBED VNR 6 MM	1.000	PC	VL1127A1	6mm BARBED T-SHAPED FITTING	1.000	PC	VL1128A1	D6 BARBED CHECK VALVE	2.000	PC	VL1165A0	BAM-BB6 STRAIGHT FITTING	1.000	PC	VL1166A0	BB6-AR6 L FITTING	2.000	PC	VL1174C0	D1.2 MM CALIBRATED D1.2 MM	1.000	PC	VL1191A0	ONE WASHING DISTRIBUTOR OUTLETS KIT	1.000	PC	VL1214A0	BAYONET - 6mm BARBED NRV VALVE	1.000	PC
Code	Description	Qty	UOM																																																																																						
GN1526A0	INT. D.=6.9 TH=1.8 O-RIN	5.000	PC																																																																																						
RC1018A0	ZINC PLATED D12 ELASTIC CLAMP	4.000	PC																																																																																						
RC1019A0	D=10 ELASTIC CLAMP	16.000	PC																																																																																						
RC1131A0	200x2.6 BLACK CLAMP	1.000	PC																																																																																						
RC1242A0	D=10 CLOSED CAP	2.000	PC																																																																																						
TB2821A0	EPDM 6X10 L=40MM PIPE	6.000	PC																																																																																						
TB2994A0	HOOD DETERGENT PIPE	2.000	PC																																																																																						
TB3252A0		2.000	PC																																																																																						
VI1220A1	4,2x12 TCB SELF-TAPPIN G SCREW	3.000	PC																																																																																						
VL1019A0	VIBRATION DETERGENT PUMP	1.000	PC																																																																																						
VL1047A1	D6 PIPE HOLDER - D8 J.G. TERMINAL	2.000	PC																																																																																						
VL1054B0	ONE WASHING SYS INLET DISTRIBUTOR	1.000	PC																																																																																						
VL1102A1	DETERGENT LINE FILTER + BARBED VNR 6 MM	1.000	PC																																																																																						
VL1127A1	6mm BARBED T-SHAPED FITTING	1.000	PC																																																																																						
VL1128A1	D6 BARBED CHECK VALVE	2.000	PC																																																																																						
VL1165A0	BAM-BB6 STRAIGHT FITTING	1.000	PC																																																																																						
VL1166A0	BB6-AR6 L FITTING	2.000	PC																																																																																						
VL1174C0	D1.2 MM CALIBRATED D1.2 MM	1.000	PC																																																																																						
VL1191A0	ONE WASHING DISTRIBUTOR OUTLETS KIT	1.000	PC																																																																																						
VL1214A0	BAYONET - 6mm BARBED NRV VALVE	1.000	PC																																																																																						

COMPONENT			SPARE PART																																																																															
Code	Description	Image	Code	Description	Kit components																																																																													
VL1019A	VIBRATION DETERGENT PUMP		KVL1198A	MM EU HOOD CLEANING SYSTEM KIT	<table border="1"> <thead> <tr> <th>Code</th> <th>Description</th> <th>Qty</th> <th>UOM</th> </tr> </thead> <tbody> <tr> <td>VM1605A0</td> <td>CLIP TWIST LOCK DIAM. 10,2-12,7 MM</td> <td>2.000</td> <td>PC</td> </tr> <tr> <td>VM2172A0</td> <td>LOCKING CLIP FOR PUMP WITH CIRCUIT</td> <td>5.000</td> <td>PC</td> </tr> </tbody> </table>	Code	Description	Qty	UOM	VM1605A0	CLIP TWIST LOCK DIAM. 10,2-12,7 MM	2.000	PC	VM2172A0	LOCKING CLIP FOR PUMP WITH CIRCUIT	5.000	PC																																																																	
			Code	Description	Qty	UOM																																																																												
VM1605A0	CLIP TWIST LOCK DIAM. 10,2-12,7 MM	2.000	PC																																																																															
VM2172A0	LOCKING CLIP FOR PUMP WITH CIRCUIT	5.000	PC																																																																															
KVL1187A	3 ROTOR ARMS PLUS EU CLEANING SYSTEM KIT	<table border="1"> <thead> <tr> <th>Code</th> <th>Description</th> <th>Qty</th> <th>UOM</th> </tr> </thead> <tbody> <tr> <td>0H2354A1</td> <td>XEVC-XEVL PLUS WASHING CIRCUIT PLAT</td> <td>1.000</td> <td>PC</td> </tr> <tr> <td>EL1440A0</td> <td>WATER SELF CLEANING VALVE</td> <td>4.000</td> <td>PC</td> </tr> <tr> <td>GN1526A0</td> <td>INT. D.=6.9 TH=1.8 O-RIN</td> <td>9.000</td> <td>PC</td> </tr> <tr> <td>RC1018A0</td> <td>ZINC PLATED D12 ELASTIC CLAMP</td> <td>11.000</td> <td>PC</td> </tr> <tr> <td>RC1019A0</td> <td>D=10 ELASTIC CLAMP</td> <td>16.000</td> <td>PC</td> </tr> <tr> <td>RC1130A0</td> <td>130x2,6 CLAM</td> <td>1.000</td> <td>PC</td> </tr> <tr> <td>RC1131A0</td> <td>200x2,6 BLACK CLAMP</td> <td>3.000</td> <td>PC</td> </tr> <tr> <td>RC1242A0</td> <td>D=10 CLOSED CAP</td> <td>2.000</td> <td>PC</td> </tr> <tr> <td>RC1356A0</td> <td>"STRAIGHT THREADED FEMALE END 8x1/4" BS</td> <td>1.000</td> <td>PC</td> </tr> <tr> <td>TB2652A0</td> <td></td> <td>1.000</td> <td>PC</td> </tr> <tr> <td>TB2677A0</td> <td></td> <td>1.000</td> <td>PC</td> </tr> <tr> <td>TB2821A0</td> <td>EPDM 6X10 L=40MM PIPE</td> <td>6.000</td> <td>PC</td> </tr> <tr> <td>TB3004A0</td> <td>TB2820A L=550mm EPDM BLACK PIPE</td> <td>2.000</td> <td>PC</td> </tr> <tr> <td>TB3024C0</td> <td></td> <td>3.000</td> <td>PC</td> </tr> <tr> <td>TB3226A0</td> <td></td> <td>1.000</td> <td>PC</td> </tr> <tr> <td>TB3440A0</td> <td>TB3132A L=1050mm EPDM WHITE-BLUE PIPE</td> <td>1.000</td> <td>PC</td> </tr> <tr> <td>VL1019A0</td> <td>VIBRATION DETERGENT PUMP</td> <td>1.000</td> <td>PC</td> </tr> <tr> <td>VL1047A1</td> <td>D6 PIPE HOLDER - D6 J.G. TERMINAL</td> <td>1.000</td> <td>PC</td> </tr> <tr> <td>VL1102A1</td> <td>DETERGENT LINE FILTER + BARBED VNR 6 MM</td> <td>1.000</td> <td>PC</td> </tr> </tbody> </table>	Code	Description	Qty	UOM	0H2354A1	XEVC-XEVL PLUS WASHING CIRCUIT PLAT	1.000	PC	EL1440A0	WATER SELF CLEANING VALVE	4.000	PC	GN1526A0	INT. D.=6.9 TH=1.8 O-RIN	9.000	PC	RC1018A0	ZINC PLATED D12 ELASTIC CLAMP	11.000	PC	RC1019A0	D=10 ELASTIC CLAMP	16.000	PC	RC1130A0	130x2,6 CLAM	1.000	PC	RC1131A0	200x2,6 BLACK CLAMP	3.000	PC	RC1242A0	D=10 CLOSED CAP	2.000	PC	RC1356A0	"STRAIGHT THREADED FEMALE END 8x1/4" BS	1.000	PC	TB2652A0		1.000	PC	TB2677A0		1.000	PC	TB2821A0	EPDM 6X10 L=40MM PIPE	6.000	PC	TB3004A0	TB2820A L=550mm EPDM BLACK PIPE	2.000	PC	TB3024C0		3.000	PC	TB3226A0		1.000	PC	TB3440A0	TB3132A L=1050mm EPDM WHITE-BLUE PIPE	1.000	PC	VL1019A0	VIBRATION DETERGENT PUMP	1.000	PC	VL1047A1	D6 PIPE HOLDER - D6 J.G. TERMINAL	1.000	PC	VL1102A1	DETERGENT LINE FILTER + BARBED VNR 6 MM	1.000	PC
Code	Description	Qty	UOM																																																																															
0H2354A1	XEVC-XEVL PLUS WASHING CIRCUIT PLAT	1.000	PC																																																																															
EL1440A0	WATER SELF CLEANING VALVE	4.000	PC																																																																															
GN1526A0	INT. D.=6.9 TH=1.8 O-RIN	9.000	PC																																																																															
RC1018A0	ZINC PLATED D12 ELASTIC CLAMP	11.000	PC																																																																															
RC1019A0	D=10 ELASTIC CLAMP	16.000	PC																																																																															
RC1130A0	130x2,6 CLAM	1.000	PC																																																																															
RC1131A0	200x2,6 BLACK CLAMP	3.000	PC																																																																															
RC1242A0	D=10 CLOSED CAP	2.000	PC																																																																															
RC1356A0	"STRAIGHT THREADED FEMALE END 8x1/4" BS	1.000	PC																																																																															
TB2652A0		1.000	PC																																																																															
TB2677A0		1.000	PC																																																																															
TB2821A0	EPDM 6X10 L=40MM PIPE	6.000	PC																																																																															
TB3004A0	TB2820A L=550mm EPDM BLACK PIPE	2.000	PC																																																																															
TB3024C0		3.000	PC																																																																															
TB3226A0		1.000	PC																																																																															
TB3440A0	TB3132A L=1050mm EPDM WHITE-BLUE PIPE	1.000	PC																																																																															
VL1019A0	VIBRATION DETERGENT PUMP	1.000	PC																																																																															
VL1047A1	D6 PIPE HOLDER - D6 J.G. TERMINAL	1.000	PC																																																																															
VL1102A1	DETERGENT LINE FILTER + BARBED VNR 6 MM	1.000	PC																																																																															

COMPONENT			SPARE PART																																																		
Code	Description	Image	Code	Description	Kit components																																																
VL1019A	VIBRATION DETERGENT PUMP		KVL1187A	3 ROTOR ARMS PLUS EU CLEANING SYSTEM KIT	<table border="1"> <thead> <tr> <th>Code</th> <th>Description</th> <th>Qty</th> <th>UOM</th> </tr> </thead> <tbody> <tr> <td>VL1127A1</td> <td>6mm BARBED T-SHAPED FITTING</td> <td>2.000</td> <td>PC</td> </tr> <tr> <td>VL1128A1</td> <td>D6 BARBED CHECK VALVE</td> <td>3.000</td> <td>PC</td> </tr> <tr> <td>VL1166A0</td> <td>BB6-AR6 L FITTING</td> <td>4.000</td> <td>PC</td> </tr> <tr> <td>VL1167A2</td> <td>GN21 3 ROTOR ARMS B-B FLOW RESTRICTOR</td> <td>1.000</td> <td>PC</td> </tr> <tr> <td>VL1174C0</td> <td>D1.2 MM CALIBRATED D1.2 MM</td> <td>1.000</td> <td>PC</td> </tr> <tr> <td>VL1186A0</td> <td>3 WAYS PLUS WASHING DISTRIBUTOR</td> <td>1.000</td> <td>PC</td> </tr> <tr> <td>VL1190A0</td> <td>PLUS WASHING SYSTEM INLET DISTRIBUTOR</td> <td>1.000</td> <td>PC</td> </tr> <tr> <td>VL1214A0</td> <td>BAYONET - 6mm BARBED NRV VALVE</td> <td>1.000</td> <td>PC</td> </tr> <tr> <td>VL1398A0</td> <td>1/4 M N.O. CIL PRESSURE SWITCH</td> <td>1.000</td> <td>PC</td> </tr> <tr> <td>VM1605A0</td> <td>CLIP TWIST LOCK DIAM. 10.2-12.7 MM</td> <td>3.000</td> <td>PC</td> </tr> <tr> <td>VM2172A0</td> <td>LOCKING CLIP FOR PUMP WITH CIRCUIT</td> <td>5.000</td> <td>PC</td> </tr> </tbody> </table>	Code	Description	Qty	UOM	VL1127A1	6mm BARBED T-SHAPED FITTING	2.000	PC	VL1128A1	D6 BARBED CHECK VALVE	3.000	PC	VL1166A0	BB6-AR6 L FITTING	4.000	PC	VL1167A2	GN21 3 ROTOR ARMS B-B FLOW RESTRICTOR	1.000	PC	VL1174C0	D1.2 MM CALIBRATED D1.2 MM	1.000	PC	VL1186A0	3 WAYS PLUS WASHING DISTRIBUTOR	1.000	PC	VL1190A0	PLUS WASHING SYSTEM INLET DISTRIBUTOR	1.000	PC	VL1214A0	BAYONET - 6mm BARBED NRV VALVE	1.000	PC	VL1398A0	1/4 M N.O. CIL PRESSURE SWITCH	1.000	PC	VM1605A0	CLIP TWIST LOCK DIAM. 10.2-12.7 MM	3.000	PC	VM2172A0	LOCKING CLIP FOR PUMP WITH CIRCUIT	5.000	PC
			Code	Description	Qty	UOM																																															
VL1127A1	6mm BARBED T-SHAPED FITTING	2.000	PC																																																		
VL1128A1	D6 BARBED CHECK VALVE	3.000	PC																																																		
VL1166A0	BB6-AR6 L FITTING	4.000	PC																																																		
VL1167A2	GN21 3 ROTOR ARMS B-B FLOW RESTRICTOR	1.000	PC																																																		
VL1174C0	D1.2 MM CALIBRATED D1.2 MM	1.000	PC																																																		
VL1186A0	3 WAYS PLUS WASHING DISTRIBUTOR	1.000	PC																																																		
VL1190A0	PLUS WASHING SYSTEM INLET DISTRIBUTOR	1.000	PC																																																		
VL1214A0	BAYONET - 6mm BARBED NRV VALVE	1.000	PC																																																		
VL1398A0	1/4 M N.O. CIL PRESSURE SWITCH	1.000	PC																																																		
VM1605A0	CLIP TWIST LOCK DIAM. 10.2-12.7 MM	3.000	PC																																																		
VM2172A0	LOCKING CLIP FOR PUMP WITH CIRCUIT	5.000	PC																																																		
KVL1184A	2 ROTOR ARMS PLUS EU CLEANING SYSTEM KIT	<table border="1"> <thead> <tr> <th>Code</th> <th>Description</th> <th>Qty</th> <th>UOM</th> </tr> </thead> <tbody> <tr> <td>0H2354A1</td> <td>XEVC-XEVL PLUS WASHING CIRCUIT PLAT</td> <td>1.000</td> <td>PC</td> </tr> <tr> <td>EL1440A0</td> <td>WATER SELF CLEANING VALVE</td> <td>4.000</td> <td>PC</td> </tr> <tr> <td>GN1526A0</td> <td>INT. D.=6.9 TH=1.8 O-RIN</td> <td>9.000</td> <td>PC</td> </tr> <tr> <td>RC1018A0</td> <td>ZINC PLATED D12 ELASTIC CLAMP</td> <td>3.000</td> <td>PC</td> </tr> <tr> <td>RC1019A0</td> <td>D=10 ELASTIC CLAMP</td> <td>15.000</td> <td>PC</td> </tr> <tr> <td>RC1130A0</td> <td>130x2.6 CLAM</td> <td>1.000</td> <td>PC</td> </tr> <tr> <td>RC1131A0</td> <td>200x2.6 BLACK CLAMP</td> <td>3.000</td> <td>PC</td> </tr> <tr> <td>RC1242A0</td> <td>D=10 CLOSED CAP</td> <td>2.000</td> <td>PC</td> </tr> </tbody> </table>	Code	Description	Qty	UOM	0H2354A1	XEVC-XEVL PLUS WASHING CIRCUIT PLAT	1.000	PC	EL1440A0	WATER SELF CLEANING VALVE	4.000	PC	GN1526A0	INT. D.=6.9 TH=1.8 O-RIN	9.000	PC	RC1018A0	ZINC PLATED D12 ELASTIC CLAMP	3.000	PC	RC1019A0	D=10 ELASTIC CLAMP	15.000	PC	RC1130A0	130x2.6 CLAM	1.000	PC	RC1131A0	200x2.6 BLACK CLAMP	3.000	PC	RC1242A0	D=10 CLOSED CAP	2.000	PC															
Code	Description	Qty	UOM																																																		
0H2354A1	XEVC-XEVL PLUS WASHING CIRCUIT PLAT	1.000	PC																																																		
EL1440A0	WATER SELF CLEANING VALVE	4.000	PC																																																		
GN1526A0	INT. D.=6.9 TH=1.8 O-RIN	9.000	PC																																																		
RC1018A0	ZINC PLATED D12 ELASTIC CLAMP	3.000	PC																																																		
RC1019A0	D=10 ELASTIC CLAMP	15.000	PC																																																		
RC1130A0	130x2.6 CLAM	1.000	PC																																																		
RC1131A0	200x2.6 BLACK CLAMP	3.000	PC																																																		
RC1242A0	D=10 CLOSED CAP	2.000	PC																																																		

COMPONENT			SPARE PART																																																																						
Code	Description	Image	Code	Description	Kit components																																																																				
VL1019A	VIBRATION DETERGENT PUMP		KVL1184A	2 ROTOR ARMS PLUS EU CLEANING SYSTEM KIT	<table border="1"> <thead> <tr> <th>Code</th> <th>Description</th> <th>Qty</th> <th>UOM</th> </tr> </thead> <tbody> <tr> <td>RC1356A0</td> <td>"STRAIGHT THREADED FEMALE END 8x1/4" BS</td> <td>1.000</td> <td>PC</td> </tr> <tr> <td>TB2821A0</td> <td>EPDM 6X10 L=40MM PIPE</td> <td>6.000</td> <td>PC</td> </tr> <tr> <td>TB2994A0</td> <td>HOOD DETERGENT PIPE</td> <td>1.000</td> <td>PC</td> </tr> <tr> <td>TB3004A0</td> <td>TB2820A L=550mm EPDM BLACK PIPE</td> <td>2.000</td> <td>PC</td> </tr> <tr> <td>TB3005B0</td> <td>TB3132A L=550mm EPDM WHITE-BLUE PIPE</td> <td>1.000</td> <td>PC</td> </tr> <tr> <td>TB3440A0</td> <td>TB3132A L=1050mm EPDM WHITE-BLUE PIPE</td> <td>1.000</td> <td>PC</td> </tr> <tr> <td>VL1019A0</td> <td>VIBRATION DETERGENT PUMP</td> <td>1.000</td> <td>PC</td> </tr> <tr> <td>VL1047A1</td> <td>D6 PIPE HOLDER - D8 J.G. TERMINAL</td> <td>1.000</td> <td>PC</td> </tr> <tr> <td>VL1102A1</td> <td>DETERGENT LINE FILTER + BARBED VNR 6 MM</td> <td>1.000</td> <td>PC</td> </tr> <tr> <td>VL1128A1</td> <td>D6 BARBED CHECK VALVE</td> <td>2.000</td> <td>PC</td> </tr> <tr> <td>VL1141A1</td> <td>BB6-BB6 STRAIGHT CONNECTION</td> <td>1.000</td> <td>PC</td> </tr> <tr> <td>VL1166A0</td> <td>BB6-AR6 L FITTING</td> <td>4.000</td> <td>PC</td> </tr> <tr> <td>VL1174C0</td> <td>D1.2 MM CALIBRATED D1.2 MM</td> <td>1.000</td> <td>PC</td> </tr> <tr> <td>VL1186A0</td> <td>3 WAYS PLUS WASHING DISTRIBUTOR</td> <td>1.000</td> <td>PC</td> </tr> <tr> <td>VL1190A0</td> <td>PLUS WASHING SYSTEM INLET DISTRIBUTOR</td> <td>1.000</td> <td>PC</td> </tr> <tr> <td>VL1214A0</td> <td>BAYONET - 6mm BARBED NRV VALVE</td> <td>1.000</td> <td>PC</td> </tr> </tbody> </table>	Code	Description	Qty	UOM	RC1356A0	"STRAIGHT THREADED FEMALE END 8x1/4" BS	1.000	PC	TB2821A0	EPDM 6X10 L=40MM PIPE	6.000	PC	TB2994A0	HOOD DETERGENT PIPE	1.000	PC	TB3004A0	TB2820A L=550mm EPDM BLACK PIPE	2.000	PC	TB3005B0	TB3132A L=550mm EPDM WHITE-BLUE PIPE	1.000	PC	TB3440A0	TB3132A L=1050mm EPDM WHITE-BLUE PIPE	1.000	PC	VL1019A0	VIBRATION DETERGENT PUMP	1.000	PC	VL1047A1	D6 PIPE HOLDER - D8 J.G. TERMINAL	1.000	PC	VL1102A1	DETERGENT LINE FILTER + BARBED VNR 6 MM	1.000	PC	VL1128A1	D6 BARBED CHECK VALVE	2.000	PC	VL1141A1	BB6-BB6 STRAIGHT CONNECTION	1.000	PC	VL1166A0	BB6-AR6 L FITTING	4.000	PC	VL1174C0	D1.2 MM CALIBRATED D1.2 MM	1.000	PC	VL1186A0	3 WAYS PLUS WASHING DISTRIBUTOR	1.000	PC	VL1190A0	PLUS WASHING SYSTEM INLET DISTRIBUTOR	1.000	PC	VL1214A0	BAYONET - 6mm BARBED NRV VALVE	1.000	PC
Code	Description	Qty	UOM																																																																						
RC1356A0	"STRAIGHT THREADED FEMALE END 8x1/4" BS	1.000	PC																																																																						
TB2821A0	EPDM 6X10 L=40MM PIPE	6.000	PC																																																																						
TB2994A0	HOOD DETERGENT PIPE	1.000	PC																																																																						
TB3004A0	TB2820A L=550mm EPDM BLACK PIPE	2.000	PC																																																																						
TB3005B0	TB3132A L=550mm EPDM WHITE-BLUE PIPE	1.000	PC																																																																						
TB3440A0	TB3132A L=1050mm EPDM WHITE-BLUE PIPE	1.000	PC																																																																						
VL1019A0	VIBRATION DETERGENT PUMP	1.000	PC																																																																						
VL1047A1	D6 PIPE HOLDER - D8 J.G. TERMINAL	1.000	PC																																																																						
VL1102A1	DETERGENT LINE FILTER + BARBED VNR 6 MM	1.000	PC																																																																						
VL1128A1	D6 BARBED CHECK VALVE	2.000	PC																																																																						
VL1141A1	BB6-BB6 STRAIGHT CONNECTION	1.000	PC																																																																						
VL1166A0	BB6-AR6 L FITTING	4.000	PC																																																																						
VL1174C0	D1.2 MM CALIBRATED D1.2 MM	1.000	PC																																																																						
VL1186A0	3 WAYS PLUS WASHING DISTRIBUTOR	1.000	PC																																																																						
VL1190A0	PLUS WASHING SYSTEM INLET DISTRIBUTOR	1.000	PC																																																																						
VL1214A0	BAYONET - 6mm BARBED NRV VALVE	1.000	PC																																																																						

COMPONENT			SPARE PART																																																																			
Code	Description	Image	Code	Description	Kit components																																																																	
VL1019A	VIBRATION DETERGENT PUMP		KVL1184A	2 ROTOR ARMS PLUS EU CLEANING SYSTEM KIT	<table border="1"> <thead> <tr> <th>Code</th> <th>Description</th> <th>Qty</th> <th>UOM</th> </tr> </thead> <tbody> <tr> <td>VL1398A0</td> <td>1/4 M N.O. CIL PRESSURE SWITCH</td> <td>1.000</td> <td>PC</td> </tr> <tr> <td>VM1605A0</td> <td>CLIP TWIST LOCK DIAM. 10,2-12,7 MM</td> <td>3.000</td> <td>PC</td> </tr> <tr> <td>VM2172A0</td> <td>LOCKING CLIP FOR PUMP WITH CIRCUIT</td> <td>5.000</td> <td>PC</td> </tr> </tbody> </table>	Code	Description	Qty	UOM	VL1398A0	1/4 M N.O. CIL PRESSURE SWITCH	1.000	PC	VM1605A0	CLIP TWIST LOCK DIAM. 10,2-12,7 MM	3.000	PC	VM2172A0	LOCKING CLIP FOR PUMP WITH CIRCUIT	5.000	PC																																																	
			Code	Description	Qty	UOM																																																																
VL1398A0	1/4 M N.O. CIL PRESSURE SWITCH	1.000	PC																																																																			
VM1605A0	CLIP TWIST LOCK DIAM. 10,2-12,7 MM	3.000	PC																																																																			
VM2172A0	LOCKING CLIP FOR PUMP WITH CIRCUIT	5.000	PC																																																																			
KVL1183A	1 ROTOR ARM PLUS CLEANING SYSTEM KIT	<table border="1"> <thead> <tr> <th>Code</th> <th>Description</th> <th>Qty</th> <th>UOM</th> </tr> </thead> <tbody> <tr> <td>0H2354A1</td> <td>XEVC-XEVL PLUS WASHING CIRCUIT PLAT</td> <td>1.000</td> <td>PC</td> </tr> <tr> <td>EL1440A0</td> <td>WATER SELF CLEANING VALVE</td> <td>3.000</td> <td>PC</td> </tr> <tr> <td>GN1526A0</td> <td>INT. D.=6.9 TH=1.8 O-RIN</td> <td>7.000</td> <td>PC</td> </tr> <tr> <td>RC1018A0</td> <td>ZINC PLATED D12 ELASTIC CLAMP</td> <td>2.000</td> <td>PC</td> </tr> <tr> <td>RC1019A0</td> <td>D=10 ELASTIC CLAMP</td> <td>14.000</td> <td>PC</td> </tr> <tr> <td>RC1130A0</td> <td>130x2,6 CLAM</td> <td>1.000</td> <td>PC</td> </tr> <tr> <td>RC1131A0</td> <td>200x2,6 BLACK CLAMP</td> <td>2.000</td> <td>PC</td> </tr> <tr> <td>RC1242A0</td> <td>D=10 CLOSED CAP</td> <td>2.000</td> <td>PC</td> </tr> <tr> <td>RC1356A0</td> <td>"STRAIGHT THREADED FEMALE END 8x1/4" BS</td> <td>1.000</td> <td>PC</td> </tr> <tr> <td>TB2821A0</td> <td>EPDM 6X10 L=40MM PIPE</td> <td>6.000</td> <td>PC</td> </tr> <tr> <td>TB3004A0</td> <td>TB2820A L=550mm EPDM BLACK PIPE</td> <td>1.000</td> <td>PC</td> </tr> <tr> <td>TB3005B0</td> <td>TB3132A L=550mm EPDM WHITE-BLUE PIPE</td> <td>1.000</td> <td>PC</td> </tr> <tr> <td>TB3225B0</td> <td>TB2820A-TAN K-WASHYNG SYS CONNECTION</td> <td>1.000</td> <td>PC</td> </tr> <tr> <td>TB3252A0</td> <td></td> <td>1.000</td> <td>PC</td> </tr> <tr> <td>VL1019A0</td> <td>VIBRATION DETERGENT PUMP</td> <td>1.000</td> <td>PC</td> </tr> <tr> <td>VL1047A1</td> <td>D6 PIPE HOLDER - D8 J.G. TERMINAL</td> <td>1.000</td> <td>PC</td> </tr> </tbody> </table>	Code	Description	Qty	UOM	0H2354A1	XEVC-XEVL PLUS WASHING CIRCUIT PLAT	1.000	PC	EL1440A0	WATER SELF CLEANING VALVE	3.000	PC	GN1526A0	INT. D.=6.9 TH=1.8 O-RIN	7.000	PC	RC1018A0	ZINC PLATED D12 ELASTIC CLAMP	2.000	PC	RC1019A0	D=10 ELASTIC CLAMP	14.000	PC	RC1130A0	130x2,6 CLAM	1.000	PC	RC1131A0	200x2,6 BLACK CLAMP	2.000	PC	RC1242A0	D=10 CLOSED CAP	2.000	PC	RC1356A0	"STRAIGHT THREADED FEMALE END 8x1/4" BS	1.000	PC	TB2821A0	EPDM 6X10 L=40MM PIPE	6.000	PC	TB3004A0	TB2820A L=550mm EPDM BLACK PIPE	1.000	PC	TB3005B0	TB3132A L=550mm EPDM WHITE-BLUE PIPE	1.000	PC	TB3225B0	TB2820A-TAN K-WASHYNG SYS CONNECTION	1.000	PC	TB3252A0		1.000	PC	VL1019A0	VIBRATION DETERGENT PUMP	1.000	PC	VL1047A1	D6 PIPE HOLDER - D8 J.G. TERMINAL	1.000	PC
Code	Description	Qty	UOM																																																																			
0H2354A1	XEVC-XEVL PLUS WASHING CIRCUIT PLAT	1.000	PC																																																																			
EL1440A0	WATER SELF CLEANING VALVE	3.000	PC																																																																			
GN1526A0	INT. D.=6.9 TH=1.8 O-RIN	7.000	PC																																																																			
RC1018A0	ZINC PLATED D12 ELASTIC CLAMP	2.000	PC																																																																			
RC1019A0	D=10 ELASTIC CLAMP	14.000	PC																																																																			
RC1130A0	130x2,6 CLAM	1.000	PC																																																																			
RC1131A0	200x2,6 BLACK CLAMP	2.000	PC																																																																			
RC1242A0	D=10 CLOSED CAP	2.000	PC																																																																			
RC1356A0	"STRAIGHT THREADED FEMALE END 8x1/4" BS	1.000	PC																																																																			
TB2821A0	EPDM 6X10 L=40MM PIPE	6.000	PC																																																																			
TB3004A0	TB2820A L=550mm EPDM BLACK PIPE	1.000	PC																																																																			
TB3005B0	TB3132A L=550mm EPDM WHITE-BLUE PIPE	1.000	PC																																																																			
TB3225B0	TB2820A-TAN K-WASHYNG SYS CONNECTION	1.000	PC																																																																			
TB3252A0		1.000	PC																																																																			
VL1019A0	VIBRATION DETERGENT PUMP	1.000	PC																																																																			
VL1047A1	D6 PIPE HOLDER - D8 J.G. TERMINAL	1.000	PC																																																																			



COMPONENT			SPARE PART																																														
Code	Description	Image	Code	Description	Kit components																																												
VL1019A	VIBRATION DETERGENT PUMP		KVL1183A	1 ROTOR ARM PLUS CLEANING SYSTEM KIT	<table border="1"> <thead> <tr> <th>Code</th> <th>Description</th> <th>Qty</th> <th>UOM</th> </tr> </thead> <tbody> <tr> <td>VL1102A1</td> <td>DETERGENT LINE FILTER + BARBED VNR 6 MM</td> <td>1.000</td> <td>PC</td> </tr> <tr> <td>VL1128A1</td> <td>D6 BARBED CHECK VALVE</td> <td>2.000</td> <td>PC</td> </tr> <tr> <td>VL1166A0</td> <td>BB6-AR6 L FITTING</td> <td>3.000</td> <td>PC</td> </tr> <tr> <td>VL1174C0</td> <td>D1.2 MM CALIBRATED D1.2 MM</td> <td>1.000</td> <td>PC</td> </tr> <tr> <td>VL1185A0</td> <td>2 WAYS PLUS WASHING DISTRIBUTOR</td> <td>1.000</td> <td>PC</td> </tr> <tr> <td>VL1190A0</td> <td>PLUS WASHING SYSTEM INLET DISTRIBUTOR</td> <td>1.000</td> <td>PC</td> </tr> <tr> <td>VL1214A0</td> <td>BAYONET - 6mm BARBED NRV VALVE</td> <td>1.000</td> <td>PC</td> </tr> <tr> <td>VL1398A0</td> <td>1/4 M N.O. CIL PRESSURE SWITCH</td> <td>1.000</td> <td>PC</td> </tr> <tr> <td>VM1605A0</td> <td>CLIP TWIST LOCK DIAM. 10,2-12,7 MM</td> <td>3.000</td> <td>PC</td> </tr> <tr> <td>VM2172A0</td> <td>LOCKING CLIP FOR PUMP WITH CIRCUIT</td> <td>4.000</td> <td>PC</td> </tr> </tbody> </table>	Code	Description	Qty	UOM	VL1102A1	DETERGENT LINE FILTER + BARBED VNR 6 MM	1.000	PC	VL1128A1	D6 BARBED CHECK VALVE	2.000	PC	VL1166A0	BB6-AR6 L FITTING	3.000	PC	VL1174C0	D1.2 MM CALIBRATED D1.2 MM	1.000	PC	VL1185A0	2 WAYS PLUS WASHING DISTRIBUTOR	1.000	PC	VL1190A0	PLUS WASHING SYSTEM INLET DISTRIBUTOR	1.000	PC	VL1214A0	BAYONET - 6mm BARBED NRV VALVE	1.000	PC	VL1398A0	1/4 M N.O. CIL PRESSURE SWITCH	1.000	PC	VM1605A0	CLIP TWIST LOCK DIAM. 10,2-12,7 MM	3.000	PC	VM2172A0	LOCKING CLIP FOR PUMP WITH CIRCUIT	4.000	PC
			Code	Description	Qty	UOM																																											
VL1102A1	DETERGENT LINE FILTER + BARBED VNR 6 MM	1.000	PC																																														
VL1128A1	D6 BARBED CHECK VALVE	2.000	PC																																														
VL1166A0	BB6-AR6 L FITTING	3.000	PC																																														
VL1174C0	D1.2 MM CALIBRATED D1.2 MM	1.000	PC																																														
VL1185A0	2 WAYS PLUS WASHING DISTRIBUTOR	1.000	PC																																														
VL1190A0	PLUS WASHING SYSTEM INLET DISTRIBUTOR	1.000	PC																																														
VL1214A0	BAYONET - 6mm BARBED NRV VALVE	1.000	PC																																														
VL1398A0	1/4 M N.O. CIL PRESSURE SWITCH	1.000	PC																																														
VM1605A0	CLIP TWIST LOCK DIAM. 10,2-12,7 MM	3.000	PC																																														
VM2172A0	LOCKING CLIP FOR PUMP WITH CIRCUIT	4.000	PC																																														
KVL1182A	ONE 1ROT CLEANING SYSTEM KIT (0311 EXC.)	<table border="1"> <thead> <tr> <th>Code</th> <th>Description</th> <th>Qty</th> <th>UOM</th> </tr> </thead> <tbody> <tr> <td>0H2202A1</td> <td>ONE WASHING WITH STEAM VALVE SUPPORT</td> <td>1.000</td> <td>PC</td> </tr> <tr> <td>EL1440A0</td> <td>WATER SELF CLEANING VALVE</td> <td>1.000</td> <td>PC</td> </tr> <tr> <td>GN1526A0</td> <td>INT. D.=6.9 TH=1.8 O-RIN</td> <td>3.000</td> <td>PC</td> </tr> <tr> <td>RC1018A0</td> <td>ZINC PLATED D12 ELASTIC CLAMP</td> <td>1.000</td> <td>PC</td> </tr> <tr> <td>RC1019A0</td> <td>D=10 ELASTIC CLAMP</td> <td>14.000</td> <td>PC</td> </tr> <tr> <td>RC1130A0</td> <td>130x2,6 CLAM</td> <td>2.000</td> <td>PC</td> </tr> <tr> <td>RC1242A0</td> <td>D=10 CLOSED CAP</td> <td>2.000</td> <td>PC</td> </tr> <tr> <td>TB2821A0</td> <td>EPDM 6X10 L=40MM PIPE</td> <td>6.000</td> <td>PC</td> </tr> </tbody> </table>	Code	Description	Qty	UOM	0H2202A1	ONE WASHING WITH STEAM VALVE SUPPORT	1.000	PC	EL1440A0	WATER SELF CLEANING VALVE	1.000	PC	GN1526A0	INT. D.=6.9 TH=1.8 O-RIN	3.000	PC	RC1018A0	ZINC PLATED D12 ELASTIC CLAMP	1.000	PC	RC1019A0	D=10 ELASTIC CLAMP	14.000	PC	RC1130A0	130x2,6 CLAM	2.000	PC	RC1242A0	D=10 CLOSED CAP	2.000	PC	TB2821A0	EPDM 6X10 L=40MM PIPE	6.000	PC											
Code	Description	Qty	UOM																																														
0H2202A1	ONE WASHING WITH STEAM VALVE SUPPORT	1.000	PC																																														
EL1440A0	WATER SELF CLEANING VALVE	1.000	PC																																														
GN1526A0	INT. D.=6.9 TH=1.8 O-RIN	3.000	PC																																														
RC1018A0	ZINC PLATED D12 ELASTIC CLAMP	1.000	PC																																														
RC1019A0	D=10 ELASTIC CLAMP	14.000	PC																																														
RC1130A0	130x2,6 CLAM	2.000	PC																																														
RC1242A0	D=10 CLOSED CAP	2.000	PC																																														
TB2821A0	EPDM 6X10 L=40MM PIPE	6.000	PC																																														



COMPONENT			SPARE PART																																																														
Code	Description	Image	Code	Description	Kit components																																																												
VL1019A	VIBRATION DETERGENT PUMP		KVL1182A	ONE 1ROT CLEANING SYSTEM KIT (0311 EXC.)	<table border="1"> <thead> <tr> <th>Code</th> <th>Description</th> <th>Qty</th> <th>UOM</th> </tr> </thead> <tbody> <tr> <td>TB3004A0</td> <td>TB2820A L=550mm EPDM BLACK PIPE</td> <td>1.000</td> <td>PC</td> </tr> <tr> <td>TB3009B0</td> <td>TB3132A-ONE OVEN WASHING INLET</td> <td>1.000</td> <td>PC</td> </tr> <tr> <td>TB3225B0</td> <td>TB2820A-TAN K-WASHYNG SYS CONNECTION</td> <td>1.000</td> <td>PC</td> </tr> <tr> <td>VI1220A1</td> <td>4,2x12 TCB SELF-TAPPIN G SCREW</td> <td>1.000</td> <td>PC</td> </tr> <tr> <td>VL1019A0</td> <td>VIBRATION DETERGENT PUMP</td> <td>1.000</td> <td>PC</td> </tr> <tr> <td>VL1047A1</td> <td>D6 PIPE HOLDER - D6 J.G. TERMINAL</td> <td>1.000</td> <td>PC</td> </tr> <tr> <td>VL1054B0</td> <td>ONE WASHING SYS INLET DISTRIBUTOR</td> <td>1.000</td> <td>PC</td> </tr> <tr> <td>VL1102A1</td> <td>DETERGENT LINE FILTER + BARBED VNR 6 MM</td> <td>1.000</td> <td>PC</td> </tr> <tr> <td>VL1128A1</td> <td>D6 BARBED CHECK VALVE</td> <td>2.000</td> <td>PC</td> </tr> <tr> <td>VL1166A0</td> <td>BB6-AR6 L FITTING</td> <td>1.000</td> <td>PC</td> </tr> <tr> <td>VL1174C0</td> <td>D1.2 MM CALIBRATED D1.2 MM</td> <td>1.000</td> <td>PC</td> </tr> <tr> <td>VL1191A0</td> <td>ONE WASHING DISTRIBUTOR OUTLETS KIT</td> <td>1.000</td> <td>PC</td> </tr> <tr> <td>VL1214A0</td> <td>BAYONET - 6mm BARBED NRV VALVE</td> <td>1.000</td> <td>PC</td> </tr> <tr> <td>VM2172A0</td> <td>LOCKING CLIP FOR PUMP WITH CIRCUIT</td> <td>2.000</td> <td>PC</td> </tr> </tbody> </table>	Code	Description	Qty	UOM	TB3004A0	TB2820A L=550mm EPDM BLACK PIPE	1.000	PC	TB3009B0	TB3132A-ONE OVEN WASHING INLET	1.000	PC	TB3225B0	TB2820A-TAN K-WASHYNG SYS CONNECTION	1.000	PC	VI1220A1	4,2x12 TCB SELF-TAPPIN G SCREW	1.000	PC	VL1019A0	VIBRATION DETERGENT PUMP	1.000	PC	VL1047A1	D6 PIPE HOLDER - D6 J.G. TERMINAL	1.000	PC	VL1054B0	ONE WASHING SYS INLET DISTRIBUTOR	1.000	PC	VL1102A1	DETERGENT LINE FILTER + BARBED VNR 6 MM	1.000	PC	VL1128A1	D6 BARBED CHECK VALVE	2.000	PC	VL1166A0	BB6-AR6 L FITTING	1.000	PC	VL1174C0	D1.2 MM CALIBRATED D1.2 MM	1.000	PC	VL1191A0	ONE WASHING DISTRIBUTOR OUTLETS KIT	1.000	PC	VL1214A0	BAYONET - 6mm BARBED NRV VALVE	1.000	PC	VM2172A0	LOCKING CLIP FOR PUMP WITH CIRCUIT	2.000	PC
Code	Description	Qty	UOM																																																														
TB3004A0	TB2820A L=550mm EPDM BLACK PIPE	1.000	PC																																																														
TB3009B0	TB3132A-ONE OVEN WASHING INLET	1.000	PC																																																														
TB3225B0	TB2820A-TAN K-WASHYNG SYS CONNECTION	1.000	PC																																																														
VI1220A1	4,2x12 TCB SELF-TAPPIN G SCREW	1.000	PC																																																														
VL1019A0	VIBRATION DETERGENT PUMP	1.000	PC																																																														
VL1047A1	D6 PIPE HOLDER - D6 J.G. TERMINAL	1.000	PC																																																														
VL1054B0	ONE WASHING SYS INLET DISTRIBUTOR	1.000	PC																																																														
VL1102A1	DETERGENT LINE FILTER + BARBED VNR 6 MM	1.000	PC																																																														
VL1128A1	D6 BARBED CHECK VALVE	2.000	PC																																																														
VL1166A0	BB6-AR6 L FITTING	1.000	PC																																																														
VL1174C0	D1.2 MM CALIBRATED D1.2 MM	1.000	PC																																																														
VL1191A0	ONE WASHING DISTRIBUTOR OUTLETS KIT	1.000	PC																																																														
VL1214A0	BAYONET - 6mm BARBED NRV VALVE	1.000	PC																																																														
VM2172A0	LOCKING CLIP FOR PUMP WITH CIRCUIT	2.000	PC																																																														
			KVL0684A	>12/2019 2-3ROTOR ARM PLUS WASH PUMP KIT	<table border="1"> <thead> <tr> <th>Code</th> <th>Description</th> <th>Qty</th> <th>UOM</th> </tr> </thead> <tbody> <tr> <td>GN1526A0</td> <td>INT. D.=6.9 TH=1.8 O-RIN</td> <td>3.000</td> <td>PC</td> </tr> <tr> <td>RC1019A0</td> <td>D=10 ELASTIC CLAMP</td> <td>4.000</td> <td>PC</td> </tr> <tr> <td>RC1130A0</td> <td>130x2,6 CLAM</td> <td>1.000</td> <td>PC</td> </tr> <tr> <td>RC1131A0</td> <td>200x2,6 BLACK CLAMP</td> <td>3.000</td> <td>PC</td> </tr> </tbody> </table>	Code	Description	Qty	UOM	GN1526A0	INT. D.=6.9 TH=1.8 O-RIN	3.000	PC	RC1019A0	D=10 ELASTIC CLAMP	4.000	PC	RC1130A0	130x2,6 CLAM	1.000	PC	RC1131A0	200x2,6 BLACK CLAMP	3.000	PC																																								
Code	Description	Qty	UOM																																																														
GN1526A0	INT. D.=6.9 TH=1.8 O-RIN	3.000	PC																																																														
RC1019A0	D=10 ELASTIC CLAMP	4.000	PC																																																														
RC1130A0	130x2,6 CLAM	1.000	PC																																																														
RC1131A0	200x2,6 BLACK CLAMP	3.000	PC																																																														





COMPONENT			SPARE PART																																																			
Code	Description	Image	Code	Description	Kit components																																																	
VL1019A	VIBRATION DETERGENT PUMP		KVL0684A	>12/2019 2-3ROTOR ARM PLUS WASH PUMP KIT	<table border="1"> <thead> <tr> <th>Code</th> <th>Description</th> <th>Qty</th> <th>UOM</th> </tr> </thead> <tbody> <tr> <td>RC1242A0</td> <td>D=10 CLOSED CAP</td> <td>2.000</td> <td>PC</td> </tr> <tr> <td>TB2821A0</td> <td>EPDM 6X10 L=40MM PIPE</td> <td>3.000</td> <td>PC</td> </tr> <tr> <td>VL1019A0</td> <td>VIBRATION DETERGENT PUMP</td> <td>1.000</td> <td>PC</td> </tr> <tr> <td>VL1128A1</td> <td>D6 BARBED CHECK VALVE</td> <td>1.000</td> <td>PC</td> </tr> <tr> <td>VL1174C0</td> <td>D1.2 MM CALIBRATED D1.2 MM</td> <td>1.000</td> <td>PC</td> </tr> <tr> <td>VL1186A0</td> <td>3 WAYS PLUS WASHING DISTRIBUTOR</td> <td>1.000</td> <td>PC</td> </tr> <tr> <td>VL1190A0</td> <td>PLUS WASHING SYSTEM INLET DISTRIBUTOR</td> <td>1.000</td> <td>PC</td> </tr> <tr> <td>VM2172A0</td> <td>LOCKING CLIP FOR PUMP WITH CIRCUIT</td> <td>1.000</td> <td>PC</td> </tr> </tbody> </table>	Code	Description	Qty	UOM	RC1242A0	D=10 CLOSED CAP	2.000	PC	TB2821A0	EPDM 6X10 L=40MM PIPE	3.000	PC	VL1019A0	VIBRATION DETERGENT PUMP	1.000	PC	VL1128A1	D6 BARBED CHECK VALVE	1.000	PC	VL1174C0	D1.2 MM CALIBRATED D1.2 MM	1.000	PC	VL1186A0	3 WAYS PLUS WASHING DISTRIBUTOR	1.000	PC	VL1190A0	PLUS WASHING SYSTEM INLET DISTRIBUTOR	1.000	PC	VM2172A0	LOCKING CLIP FOR PUMP WITH CIRCUIT	1.000	PC													
			Code	Description	Qty	UOM																																																
RC1242A0	D=10 CLOSED CAP	2.000	PC																																																			
TB2821A0	EPDM 6X10 L=40MM PIPE	3.000	PC																																																			
VL1019A0	VIBRATION DETERGENT PUMP	1.000	PC																																																			
VL1128A1	D6 BARBED CHECK VALVE	1.000	PC																																																			
VL1174C0	D1.2 MM CALIBRATED D1.2 MM	1.000	PC																																																			
VL1186A0	3 WAYS PLUS WASHING DISTRIBUTOR	1.000	PC																																																			
VL1190A0	PLUS WASHING SYSTEM INLET DISTRIBUTOR	1.000	PC																																																			
VM2172A0	LOCKING CLIP FOR PUMP WITH CIRCUIT	1.000	PC																																																			
KVL0683A	>12/2019 1 ROTOR ARM PLUS WASH PUMP KIT	<table border="1"> <thead> <tr> <th>Code</th> <th>Description</th> <th>Qty</th> <th>UOM</th> </tr> </thead> <tbody> <tr> <td>GN1526A0</td> <td>INT. D.=6.9 TH=1.8 O-RIN</td> <td>2.000</td> <td>PC</td> </tr> <tr> <td>RC1019A0</td> <td>D=10 ELASTIC CLAMP</td> <td>4.000</td> <td>PC</td> </tr> <tr> <td>RC1130A0</td> <td>130x2.6 CLAM</td> <td>1.000</td> <td>PC</td> </tr> <tr> <td>RC1131A0</td> <td>200x2.6 BLACK CLAMP</td> <td>2.000</td> <td>PC</td> </tr> <tr> <td>RC1242A0</td> <td>D=10 CLOSED CAP</td> <td>2.000</td> <td>PC</td> </tr> <tr> <td>TB2821A0</td> <td>EPDM 6X10 L=40MM PIPE</td> <td>3.000</td> <td>PC</td> </tr> <tr> <td>VL1019A0</td> <td>VIBRATION DETERGENT PUMP</td> <td>1.000</td> <td>PC</td> </tr> <tr> <td>VL1128A1</td> <td>D6 BARBED CHECK VALVE</td> <td>1.000</td> <td>PC</td> </tr> <tr> <td>VL1174C0</td> <td>D1.2 MM CALIBRATED D1.2 MM</td> <td>1.000</td> <td>PC</td> </tr> <tr> <td>VL1185A0</td> <td>2 WAYS PLUS WASHING DISTRIBUTOR</td> <td>1.000</td> <td>PC</td> </tr> <tr> <td>VL1190A0</td> <td>PLUS WASHING SYSTEM INLET DISTRIBUTOR</td> <td>1.000</td> <td>PC</td> </tr> <tr> <td>VM2172A0</td> <td>LOCKING CLIP FOR PUMP WITH CIRCUIT</td> <td>1.000</td> <td>PC</td> </tr> </tbody> </table>	Code	Description	Qty	UOM	GN1526A0	INT. D.=6.9 TH=1.8 O-RIN	2.000	PC	RC1019A0	D=10 ELASTIC CLAMP	4.000	PC	RC1130A0	130x2.6 CLAM	1.000	PC	RC1131A0	200x2.6 BLACK CLAMP	2.000	PC	RC1242A0	D=10 CLOSED CAP	2.000	PC	TB2821A0	EPDM 6X10 L=40MM PIPE	3.000	PC	VL1019A0	VIBRATION DETERGENT PUMP	1.000	PC	VL1128A1	D6 BARBED CHECK VALVE	1.000	PC	VL1174C0	D1.2 MM CALIBRATED D1.2 MM	1.000	PC	VL1185A0	2 WAYS PLUS WASHING DISTRIBUTOR	1.000	PC	VL1190A0	PLUS WASHING SYSTEM INLET DISTRIBUTOR	1.000	PC	VM2172A0	LOCKING CLIP FOR PUMP WITH CIRCUIT	1.000	PC
Code	Description	Qty	UOM																																																			
GN1526A0	INT. D.=6.9 TH=1.8 O-RIN	2.000	PC																																																			
RC1019A0	D=10 ELASTIC CLAMP	4.000	PC																																																			
RC1130A0	130x2.6 CLAM	1.000	PC																																																			
RC1131A0	200x2.6 BLACK CLAMP	2.000	PC																																																			
RC1242A0	D=10 CLOSED CAP	2.000	PC																																																			
TB2821A0	EPDM 6X10 L=40MM PIPE	3.000	PC																																																			
VL1019A0	VIBRATION DETERGENT PUMP	1.000	PC																																																			
VL1128A1	D6 BARBED CHECK VALVE	1.000	PC																																																			
VL1174C0	D1.2 MM CALIBRATED D1.2 MM	1.000	PC																																																			
VL1185A0	2 WAYS PLUS WASHING DISTRIBUTOR	1.000	PC																																																			
VL1190A0	PLUS WASHING SYSTEM INLET DISTRIBUTOR	1.000	PC																																																			
VM2172A0	LOCKING CLIP FOR PUMP WITH CIRCUIT	1.000	PC																																																			



COMPONENT			SPARE PART																																														
Code	Description	Image	Code	Description	Kit components																																												
VL1019A	VIBRATION DETERGENT PUMP		KVL0682A	>12/2019 ONE/HOODS WASHING SYST PUMP KIT	<table border="1"> <thead> <tr> <th>Code</th> <th>Description</th> <th>Qty</th> <th>UOM</th> </tr> </thead> <tbody> <tr> <td>GN1526A0</td> <td>INT. D.=6.9 TH=1.8 O-RIN</td> <td>1.000</td> <td>PC</td> </tr> <tr> <td>RC1019A0</td> <td>D=10 ELASTIC CLAMP</td> <td>6.000</td> <td>PC</td> </tr> <tr> <td>RC1242A0</td> <td>D=10 CLOSED CAP</td> <td>2.000</td> <td>PC</td> </tr> <tr> <td>TB2821A0</td> <td>EPDM 6X10 L=40MM PIPE</td> <td>3.000</td> <td>PC</td> </tr> <tr> <td>VL1019A0</td> <td>VIBRATION DETERGENT PUMP</td> <td>1.000</td> <td>PC</td> </tr> <tr> <td>VL1054B0</td> <td>ONE WASHING SYS INLET DISTRIBUTOR</td> <td>1.000</td> <td>PC</td> </tr> <tr> <td>VL1128A1</td> <td>D6 BARBED CHECK VALVE</td> <td>1.000</td> <td>PC</td> </tr> <tr> <td>VL1174C0</td> <td>D1.2 MM CALIBRATED D1.2 MM</td> <td>1.000</td> <td>PC</td> </tr> <tr> <td>VL1191A0</td> <td>ONE WASHING DISTRIBUTOR OUTLETS KIT</td> <td>1.000</td> <td>PC</td> </tr> <tr> <td>VM2172A0</td> <td>LOCKING CLIP FOR PUMP WITH CIRCUIT</td> <td>1.000</td> <td>PC</td> </tr> </tbody> </table>	Code	Description	Qty	UOM	GN1526A0	INT. D.=6.9 TH=1.8 O-RIN	1.000	PC	RC1019A0	D=10 ELASTIC CLAMP	6.000	PC	RC1242A0	D=10 CLOSED CAP	2.000	PC	TB2821A0	EPDM 6X10 L=40MM PIPE	3.000	PC	VL1019A0	VIBRATION DETERGENT PUMP	1.000	PC	VL1054B0	ONE WASHING SYS INLET DISTRIBUTOR	1.000	PC	VL1128A1	D6 BARBED CHECK VALVE	1.000	PC	VL1174C0	D1.2 MM CALIBRATED D1.2 MM	1.000	PC	VL1191A0	ONE WASHING DISTRIBUTOR OUTLETS KIT	1.000	PC	VM2172A0	LOCKING CLIP FOR PUMP WITH CIRCUIT	1.000	PC
			Code	Description	Qty	UOM																																											
GN1526A0	INT. D.=6.9 TH=1.8 O-RIN	1.000	PC																																														
RC1019A0	D=10 ELASTIC CLAMP	6.000	PC																																														
RC1242A0	D=10 CLOSED CAP	2.000	PC																																														
TB2821A0	EPDM 6X10 L=40MM PIPE	3.000	PC																																														
VL1019A0	VIBRATION DETERGENT PUMP	1.000	PC																																														
VL1054B0	ONE WASHING SYS INLET DISTRIBUTOR	1.000	PC																																														
VL1128A1	D6 BARBED CHECK VALVE	1.000	PC																																														
VL1174C0	D1.2 MM CALIBRATED D1.2 MM	1.000	PC																																														
VL1191A0	ONE WASHING DISTRIBUTOR OUTLETS KIT	1.000	PC																																														
VM2172A0	LOCKING CLIP FOR PUMP WITH CIRCUIT	1.000	PC																																														
KVL0001A	LM TOP CLEANING SYSTEM KIT	<table border="1"> <thead> <tr> <th>Code</th> <th>Description</th> <th>Qty</th> <th>UOM</th> </tr> </thead> <tbody> <tr> <td>0H1226B0</td> <td>LineMissTop WASHING SYTEM CIRCUIT COVE</td> <td>1.000</td> <td>PC</td> </tr> <tr> <td>EL1436B0</td> <td>JG D8-BARBED D6 NRV WATER SOLENOID</td> <td>1.000</td> <td>PC</td> </tr> <tr> <td>GN1312A0</td> <td>RUBBER CABLE-PASSI NG DE=26 DI=15 SP=10</td> <td>1.000</td> <td>PC</td> </tr> <tr> <td>GN1526A0</td> <td>INT. D.=6.9 TH=1.8 O-RIN</td> <td>1.000</td> <td>PC</td> </tr> <tr> <td>RC1019A0</td> <td>D=10 ELASTIC CLAMP</td> <td>5.000</td> <td>PC</td> </tr> <tr> <td>RC1242A0</td> <td>D=10 CLOSED CAP</td> <td>2.000</td> <td>PC</td> </tr> <tr> <td>RC1381A0</td> <td>BIFILAR PIPE CLIP D10.7</td> <td>3.000</td> <td>PC</td> </tr> <tr> <td>TB1114A1</td> <td>TB2820A-LM TOP DETERGENT PIPE COIL ROTOR</td> <td>1.000</td> <td>PC</td> </tr> </tbody> </table>	Code	Description	Qty	UOM	0H1226B0	LineMissTop WASHING SYTEM CIRCUIT COVE	1.000	PC	EL1436B0	JG D8-BARBED D6 NRV WATER SOLENOID	1.000	PC	GN1312A0	RUBBER CABLE-PASSI NG DE=26 DI=15 SP=10	1.000	PC	GN1526A0	INT. D.=6.9 TH=1.8 O-RIN	1.000	PC	RC1019A0	D=10 ELASTIC CLAMP	5.000	PC	RC1242A0	D=10 CLOSED CAP	2.000	PC	RC1381A0	BIFILAR PIPE CLIP D10.7	3.000	PC	TB1114A1	TB2820A-LM TOP DETERGENT PIPE COIL ROTOR	1.000	PC											
Code	Description	Qty	UOM																																														
0H1226B0	LineMissTop WASHING SYTEM CIRCUIT COVE	1.000	PC																																														
EL1436B0	JG D8-BARBED D6 NRV WATER SOLENOID	1.000	PC																																														
GN1312A0	RUBBER CABLE-PASSI NG DE=26 DI=15 SP=10	1.000	PC																																														
GN1526A0	INT. D.=6.9 TH=1.8 O-RIN	1.000	PC																																														
RC1019A0	D=10 ELASTIC CLAMP	5.000	PC																																														
RC1242A0	D=10 CLOSED CAP	2.000	PC																																														
RC1381A0	BIFILAR PIPE CLIP D10.7	3.000	PC																																														
TB1114A1	TB2820A-LM TOP DETERGENT PIPE COIL ROTOR	1.000	PC																																														



COMPONENT			SPARE PART																																																														
Code	Description	Image	Code	Description	Kit components																																																												
VL1019A	VIBRATION DETERGENT PUMP		KVL0001A	LM TOP CLEANING SYSTEM KIT	<table border="1"> <thead> <tr> <th>Code</th> <th>Description</th> <th>Qty</th> <th>UOM</th> </tr> </thead> <tbody> <tr> <td>TB1116A0</td> <td>TB2343A-DETE RGENT HOLD DOWN WEIGHT PIPE</td> <td>1.000</td> <td>PC</td> </tr> <tr> <td>TB2821A0</td> <td>EPDM 6X10 L=40MM PIPE</td> <td>1.000</td> <td>PC</td> </tr> <tr> <td>VI1220A1</td> <td>4,2x12 TCB SELF-TAPPIN G SCREW</td> <td>1.000</td> <td>PC</td> </tr> <tr> <td>VL1019A0</td> <td>VIBRATION PUMP</td> <td>1.000</td> <td>PC</td> </tr> <tr> <td>VL1047A1</td> <td>D6 PIPE HOLDER - D6 J.G. TERMINAL</td> <td>1.000</td> <td>PC</td> </tr> <tr> <td>VL1053B0</td> <td>ONE WASHING SYS EXT DISTRIBUTOR</td> <td>1.000</td> <td>PC</td> </tr> <tr> <td>VL1054B0</td> <td>ONE WASHING SYS INLET DISTRIBUTOR</td> <td>1.000</td> <td>PC</td> </tr> <tr> <td>VL1061A0</td> <td>HOLD DOWN WEIGHT+NET FILTER+NON- RET. V.</td> <td>1.000</td> <td>PC</td> </tr> <tr> <td>VL1090A0</td> <td>1LT TANK UNOX.DET&RI NSE CAP</td> <td>1.000</td> <td>PC</td> </tr> <tr> <td>VL1128A1</td> <td>D6 BARBED CHECK VALVE</td> <td>2.000</td> <td>PC</td> </tr> <tr> <td>VM1066A0</td> <td>SADDLE CLIP FOR CABLES PASSING</td> <td>3.000</td> <td>PC</td> </tr> <tr> <td>VM1088A0</td> <td>NYLON CLICK CLAMP D7.9-D9.2</td> <td>1.000</td> <td>PC</td> </tr> <tr> <td>VM1605A0</td> <td>CLIP TWIST LOCK DIAM. 10,2-12,7 MM</td> <td>1.000</td> <td>PC</td> </tr> <tr> <td>VM2172A0</td> <td>LOCKING CLIP FOR PUMP WITH CIRCUIT</td> <td>1.000</td> <td>PC</td> </tr> </tbody> </table>	Code	Description	Qty	UOM	TB1116A0	TB2343A-DETE RGENT HOLD DOWN WEIGHT PIPE	1.000	PC	TB2821A0	EPDM 6X10 L=40MM PIPE	1.000	PC	VI1220A1	4,2x12 TCB SELF-TAPPIN G SCREW	1.000	PC	VL1019A0	VIBRATION PUMP	1.000	PC	VL1047A1	D6 PIPE HOLDER - D6 J.G. TERMINAL	1.000	PC	VL1053B0	ONE WASHING SYS EXT DISTRIBUTOR	1.000	PC	VL1054B0	ONE WASHING SYS INLET DISTRIBUTOR	1.000	PC	VL1061A0	HOLD DOWN WEIGHT+NET FILTER+NON- RET. V.	1.000	PC	VL1090A0	1LT TANK UNOX.DET&RI NSE CAP	1.000	PC	VL1128A1	D6 BARBED CHECK VALVE	2.000	PC	VM1066A0	SADDLE CLIP FOR CABLES PASSING	3.000	PC	VM1088A0	NYLON CLICK CLAMP D7.9-D9.2	1.000	PC	VM1605A0	CLIP TWIST LOCK DIAM. 10,2-12,7 MM	1.000	PC	VM2172A0	LOCKING CLIP FOR PUMP WITH CIRCUIT	1.000	PC
					Code	Description	Qty	UOM																																																									
					TB1116A0	TB2343A-DETE RGENT HOLD DOWN WEIGHT PIPE	1.000	PC																																																									
					TB2821A0	EPDM 6X10 L=40MM PIPE	1.000	PC																																																									
					VI1220A1	4,2x12 TCB SELF-TAPPIN G SCREW	1.000	PC																																																									
					VL1019A0	VIBRATION PUMP	1.000	PC																																																									
					VL1047A1	D6 PIPE HOLDER - D6 J.G. TERMINAL	1.000	PC																																																									
					VL1053B0	ONE WASHING SYS EXT DISTRIBUTOR	1.000	PC																																																									
					VL1054B0	ONE WASHING SYS INLET DISTRIBUTOR	1.000	PC																																																									
					VL1061A0	HOLD DOWN WEIGHT+NET FILTER+NON- RET. V.	1.000	PC																																																									
					VL1090A0	1LT TANK UNOX.DET&RI NSE CAP	1.000	PC																																																									
					VL1128A1	D6 BARBED CHECK VALVE	2.000	PC																																																									
					VM1066A0	SADDLE CLIP FOR CABLES PASSING	3.000	PC																																																									
					VM1088A0	NYLON CLICK CLAMP D7.9-D9.2	1.000	PC																																																									
					VM1605A0	CLIP TWIST LOCK DIAM. 10,2-12,7 MM	1.000	PC																																																									
VM2172A0	LOCKING CLIP FOR PUMP WITH CIRCUIT	1.000	PC																																																														
VL1054B	ONE WASHING SYS INLET DISTRIBUTOR		KVL2618A	2 ROTOR ARMS ONE CLEANING SYSTEM KIT	<table border="1"> <thead> <tr> <th>Code</th> <th>Description</th> <th>Qty</th> <th>UOM</th> </tr> </thead> <tbody> <tr> <td>0H2202A1</td> <td>ONE WASHING WITH STEAM VALVE SUPPORT</td> <td>2.000</td> <td>PC</td> </tr> <tr> <td>CE1030A0</td> <td>FEMALE FASTON COVER 6.3X0.8 0,5-1mmq</td> <td>4.000</td> <td>PC</td> </tr> </tbody> </table>	Code	Description	Qty	UOM	0H2202A1	ONE WASHING WITH STEAM VALVE SUPPORT	2.000	PC	CE1030A0	FEMALE FASTON COVER 6.3X0.8 0,5-1mmq	4.000	PC																																																
					Code	Description	Qty	UOM																																																									
0H2202A1	ONE WASHING WITH STEAM VALVE SUPPORT	2.000	PC																																																														
CE1030A0	FEMALE FASTON COVER 6.3X0.8 0,5-1mmq	4.000	PC																																																														

COMPONENT			SPARE PART																																																																																		
Code	Description	Image	Code	Description	Kit components																																																																																
VL1054B	ONE WASHING SYS INLET DISTRIBUTOR		KVL2618A	2 ROTOR ARMS ONE CLEANING SYSTEM KIT	<table border="1"> <thead> <tr> <th>Code</th> <th>Description</th> <th>Qty</th> <th>UOM</th> </tr> </thead> <tbody> <tr> <td>CE1395A0</td> <td>6,3 X 0,8 MALE FASTO</td> <td>2.000</td> <td>PC</td> </tr> <tr> <td>CE1545A0</td> <td>BLUE UNIP AWG18 ST.3135 WIRE</td> <td>2.000</td> <td>M</td> </tr> <tr> <td>CE1570A0</td> <td>WHITE UNIP AWG18 ST.3135 WIRE</td> <td>2.000</td> <td>M</td> </tr> <tr> <td>CE1660A0</td> <td>6,3x0,8 FEMALE FASTON COVE</td> <td>4.000</td> <td>PC</td> </tr> <tr> <td>CE1661A0</td> <td>MALE FASTON COVER 6,3x0,8</td> <td>2.000</td> <td>PC</td> </tr> <tr> <td>EL1020A1</td> <td>D8 INTERMEDIAT E T-SHAPED FITTING</td> <td>1.000</td> <td>PC</td> </tr> <tr> <td>EL1440A0</td> <td>WATER SELF CLEANING VALVE</td> <td>2.000</td> <td>PC</td> </tr> <tr> <td>GN1526A0</td> <td>INT. D.=6.9 TH=1.8 O-RIN</td> <td>6.000</td> <td>PC</td> </tr> <tr> <td>RC1018A0</td> <td>ZINC PLATED D12 ELASTIC CLAMP</td> <td>2.000</td> <td>PC</td> </tr> <tr> <td>RC1019A0</td> <td>D=10 ELASTIC CLAMP</td> <td>28.000</td> <td>PC</td> </tr> <tr> <td>RC1130A0</td> <td>130x2,6 CLAM</td> <td>4.000</td> <td>PC</td> </tr> <tr> <td>RC1242A0</td> <td>D=10 CLOSED CAP</td> <td>4.000</td> <td>PC</td> </tr> <tr> <td>TB2821A0</td> <td>EPDM 6X10 L=40MM PIPE</td> <td>12.000</td> <td>PC</td> </tr> <tr> <td>TB3004A0</td> <td>TB2820A L=550mm EPDM BLACK PIPE</td> <td>2.000</td> <td>PC</td> </tr> <tr> <td>TB3009B0</td> <td>TB3132A-ONE OVEN WASHING INLET</td> <td>2.000</td> <td>PC</td> </tr> <tr> <td>TB3225B0</td> <td>TB2820A-TAN K-WASHYNG SYS CONNECTION</td> <td>2.000</td> <td>PC</td> </tr> <tr> <td>VI1220A1</td> <td>4,2x12 TCB SELF-TAPPIN G SCREW</td> <td>2.000</td> <td>PC</td> </tr> <tr> <td>VL1019A0</td> <td>VIBRATION DETERGENT PUMP</td> <td>2.000</td> <td>PC</td> </tr> <tr> <td>VL1047A1</td> <td>D6 PIPE HOLDER - D8 J.G. TERMINAL</td> <td>2.000</td> <td>PC</td> </tr> </tbody> </table>	Code	Description	Qty	UOM	CE1395A0	6,3 X 0,8 MALE FASTO	2.000	PC	CE1545A0	BLUE UNIP AWG18 ST.3135 WIRE	2.000	M	CE1570A0	WHITE UNIP AWG18 ST.3135 WIRE	2.000	M	CE1660A0	6,3x0,8 FEMALE FASTON COVE	4.000	PC	CE1661A0	MALE FASTON COVER 6,3x0,8	2.000	PC	EL1020A1	D8 INTERMEDIAT E T-SHAPED FITTING	1.000	PC	EL1440A0	WATER SELF CLEANING VALVE	2.000	PC	GN1526A0	INT. D.=6.9 TH=1.8 O-RIN	6.000	PC	RC1018A0	ZINC PLATED D12 ELASTIC CLAMP	2.000	PC	RC1019A0	D=10 ELASTIC CLAMP	28.000	PC	RC1130A0	130x2,6 CLAM	4.000	PC	RC1242A0	D=10 CLOSED CAP	4.000	PC	TB2821A0	EPDM 6X10 L=40MM PIPE	12.000	PC	TB3004A0	TB2820A L=550mm EPDM BLACK PIPE	2.000	PC	TB3009B0	TB3132A-ONE OVEN WASHING INLET	2.000	PC	TB3225B0	TB2820A-TAN K-WASHYNG SYS CONNECTION	2.000	PC	VI1220A1	4,2x12 TCB SELF-TAPPIN G SCREW	2.000	PC	VL1019A0	VIBRATION DETERGENT PUMP	2.000	PC	VL1047A1	D6 PIPE HOLDER - D8 J.G. TERMINAL	2.000	PC
Code	Description	Qty	UOM																																																																																		
CE1395A0	6,3 X 0,8 MALE FASTO	2.000	PC																																																																																		
CE1545A0	BLUE UNIP AWG18 ST.3135 WIRE	2.000	M																																																																																		
CE1570A0	WHITE UNIP AWG18 ST.3135 WIRE	2.000	M																																																																																		
CE1660A0	6,3x0,8 FEMALE FASTON COVE	4.000	PC																																																																																		
CE1661A0	MALE FASTON COVER 6,3x0,8	2.000	PC																																																																																		
EL1020A1	D8 INTERMEDIAT E T-SHAPED FITTING	1.000	PC																																																																																		
EL1440A0	WATER SELF CLEANING VALVE	2.000	PC																																																																																		
GN1526A0	INT. D.=6.9 TH=1.8 O-RIN	6.000	PC																																																																																		
RC1018A0	ZINC PLATED D12 ELASTIC CLAMP	2.000	PC																																																																																		
RC1019A0	D=10 ELASTIC CLAMP	28.000	PC																																																																																		
RC1130A0	130x2,6 CLAM	4.000	PC																																																																																		
RC1242A0	D=10 CLOSED CAP	4.000	PC																																																																																		
TB2821A0	EPDM 6X10 L=40MM PIPE	12.000	PC																																																																																		
TB3004A0	TB2820A L=550mm EPDM BLACK PIPE	2.000	PC																																																																																		
TB3009B0	TB3132A-ONE OVEN WASHING INLET	2.000	PC																																																																																		
TB3225B0	TB2820A-TAN K-WASHYNG SYS CONNECTION	2.000	PC																																																																																		
VI1220A1	4,2x12 TCB SELF-TAPPIN G SCREW	2.000	PC																																																																																		
VL1019A0	VIBRATION DETERGENT PUMP	2.000	PC																																																																																		
VL1047A1	D6 PIPE HOLDER - D8 J.G. TERMINAL	2.000	PC																																																																																		



COMPONENT			SPARE PART																																															
Code	Description	Image	Code	Description	Kit components																																													
VL1054B	ONE WASHING SYS INLET DISTRIBUTOR		KVL2618A	2 ROTOR ARMS ONE CLEANING SYSTEM KIT	<table border="1"> <thead> <tr> <th>Code</th> <th>Description</th> <th>Qty</th> <th>UOM</th> </tr> </thead> <tbody> <tr> <td>VL1054B0</td> <td>ONE WASHING SYS INLET DISTRIBUTOR</td> <td>2.000</td> <td>PC</td> </tr> <tr> <td>VL1102A1</td> <td>DETERGENT LINE FILTER + BARBED VNR 6 MM</td> <td>2.000</td> <td>PC</td> </tr> <tr> <td>VL1127A1</td> <td>6mm BARBED T-SHAPED FITTING</td> <td>1.000</td> <td>PC</td> </tr> <tr> <td>VL1128A1</td> <td>D6 BARBED CHECK VALVE</td> <td>4.000</td> <td>PC</td> </tr> <tr> <td>VL1166A0</td> <td>BB6-AR6 L FITTING</td> <td>2.000</td> <td>PC</td> </tr> <tr> <td>VL1174C0</td> <td>D1.2 MM CALIBRATED D1.2 MM</td> <td>2.000</td> <td>PC</td> </tr> <tr> <td>VL1191A0</td> <td>ONE WASHING DISTRIBUTOR OUTLETS KIT</td> <td>2.000</td> <td>PC</td> </tr> <tr> <td>VL1214A0</td> <td>BAYONET - 6mm BARBED NRV VALVE</td> <td>2.000</td> <td>PC</td> </tr> <tr> <td>VM2172A0</td> <td>LOCKING CLIP FOR PUMP WITH CIRCUIT</td> <td>4.000</td> <td>PC</td> </tr> </tbody> </table>	Code	Description	Qty	UOM	VL1054B0	ONE WASHING SYS INLET DISTRIBUTOR	2.000	PC	VL1102A1	DETERGENT LINE FILTER + BARBED VNR 6 MM	2.000	PC	VL1127A1	6mm BARBED T-SHAPED FITTING	1.000	PC	VL1128A1	D6 BARBED CHECK VALVE	4.000	PC	VL1166A0	BB6-AR6 L FITTING	2.000	PC	VL1174C0	D1.2 MM CALIBRATED D1.2 MM	2.000	PC	VL1191A0	ONE WASHING DISTRIBUTOR OUTLETS KIT	2.000	PC	VL1214A0	BAYONET - 6mm BARBED NRV VALVE	2.000	PC	VM2172A0	LOCKING CLIP FOR PUMP WITH CIRCUIT	4.000	PC					
			Code	Description	Qty	UOM																																												
VL1054B0	ONE WASHING SYS INLET DISTRIBUTOR	2.000	PC																																															
VL1102A1	DETERGENT LINE FILTER + BARBED VNR 6 MM	2.000	PC																																															
VL1127A1	6mm BARBED T-SHAPED FITTING	1.000	PC																																															
VL1128A1	D6 BARBED CHECK VALVE	4.000	PC																																															
VL1166A0	BB6-AR6 L FITTING	2.000	PC																																															
VL1174C0	D1.2 MM CALIBRATED D1.2 MM	2.000	PC																																															
VL1191A0	ONE WASHING DISTRIBUTOR OUTLETS KIT	2.000	PC																																															
VL1214A0	BAYONET - 6mm BARBED NRV VALVE	2.000	PC																																															
VM2172A0	LOCKING CLIP FOR PUMP WITH CIRCUIT	4.000	PC																																															
KVL1225A	US HOOD WASHING SYSTEM KIT	<table border="1"> <thead> <tr> <th>Code</th> <th>Description</th> <th>Qty</th> <th>UOM</th> </tr> </thead> <tbody> <tr> <td>0H2213A1</td> <td>HOOD WATER CIRCUIT PLAT</td> <td>1.000</td> <td>PC</td> </tr> <tr> <td>EL1450A0</td> <td>US SELF-CLEANIN G WATER SOLENOID</td> <td>2.000</td> <td>PC</td> </tr> <tr> <td>GN1526A0</td> <td>INT. D.=6.9 TH=1.8 O-RIN</td> <td>5.000</td> <td>PC</td> </tr> <tr> <td>RC1018A0</td> <td>ZINC PLATED D12 ELASTIC CLAMP</td> <td>4.000</td> <td>PC</td> </tr> <tr> <td>RC1019A0</td> <td>D=10 ELASTIC CLAMP</td> <td>16.000</td> <td>PC</td> </tr> <tr> <td>RC1131A0</td> <td>200x2.6 BLACK CLAMP</td> <td>1.000</td> <td>PC</td> </tr> <tr> <td>RC1242A0</td> <td>D=10 CLOSED CAP</td> <td>2.000</td> <td>PC</td> </tr> <tr> <td>TB2821A0</td> <td>EPDM 6X10 L=40MM PIPE</td> <td>6.000</td> <td>PC</td> </tr> <tr> <td>TB2994A0</td> <td>HOOD DETERGENT PIPE</td> <td>2.000</td> <td>PC</td> </tr> <tr> <td>TB3252A0</td> <td></td> <td>2.000</td> <td>PC</td> </tr> <tr> <td>VI1220A1</td> <td>4,2x12 TCB SELF-TAPPIN G SCREW</td> <td>3.000</td> <td>PC</td> </tr> </tbody> </table>	Code	Description	Qty	UOM	0H2213A1	HOOD WATER CIRCUIT PLAT	1.000	PC	EL1450A0	US SELF-CLEANIN G WATER SOLENOID	2.000	PC	GN1526A0	INT. D.=6.9 TH=1.8 O-RIN	5.000	PC	RC1018A0	ZINC PLATED D12 ELASTIC CLAMP	4.000	PC	RC1019A0	D=10 ELASTIC CLAMP	16.000	PC	RC1131A0	200x2.6 BLACK CLAMP	1.000	PC	RC1242A0	D=10 CLOSED CAP	2.000	PC	TB2821A0	EPDM 6X10 L=40MM PIPE	6.000	PC	TB2994A0	HOOD DETERGENT PIPE	2.000	PC	TB3252A0		2.000	PC	VI1220A1	4,2x12 TCB SELF-TAPPIN G SCREW	3.000	PC
Code	Description	Qty	UOM																																															
0H2213A1	HOOD WATER CIRCUIT PLAT	1.000	PC																																															
EL1450A0	US SELF-CLEANIN G WATER SOLENOID	2.000	PC																																															
GN1526A0	INT. D.=6.9 TH=1.8 O-RIN	5.000	PC																																															
RC1018A0	ZINC PLATED D12 ELASTIC CLAMP	4.000	PC																																															
RC1019A0	D=10 ELASTIC CLAMP	16.000	PC																																															
RC1131A0	200x2.6 BLACK CLAMP	1.000	PC																																															
RC1242A0	D=10 CLOSED CAP	2.000	PC																																															
TB2821A0	EPDM 6X10 L=40MM PIPE	6.000	PC																																															
TB2994A0	HOOD DETERGENT PIPE	2.000	PC																																															
TB3252A0		2.000	PC																																															
VI1220A1	4,2x12 TCB SELF-TAPPIN G SCREW	3.000	PC																																															



COMPONENT			SPARE PART																																																																																					
Code	Description	Image	Code	Description	Kit components																																																																																			
VL1054B	ONE WASHING SYS INLET DISTRIBUTOR		KVL1225A	US HOOD WASHING SYSTEM KIT	<table border="1"> <thead> <tr> <th>Code</th> <th>Description</th> <th>Qty</th> <th>UOM</th> </tr> </thead> <tbody> <tr> <td>VL1019A0</td> <td>VIBRATION DETERGENT PUMP</td> <td>1.000</td> <td>PC</td> </tr> <tr> <td>VL1047A1</td> <td>D6 PIPE HOLDER - D8 J.G. TERMINAL</td> <td>1.000</td> <td>PC</td> </tr> <tr> <td>VL1054B0</td> <td>ONE WASHING SYS INLET DISTRIBUTOR</td> <td>1.000</td> <td>PC</td> </tr> <tr> <td>VL1102A1</td> <td>DETERGENT LINE FILTER + BARBED VNR 6 MM</td> <td>1.000</td> <td>PC</td> </tr> <tr> <td>VL1127A1</td> <td>6mm BARBED T-SHAPED FITTING</td> <td>1.000</td> <td>PC</td> </tr> <tr> <td>VL1128A1</td> <td>D6 BARBED CHECK VALVE</td> <td>2.000</td> <td>PC</td> </tr> <tr> <td>VL1165A0</td> <td>BAM-BB6 STRAIGHT FITTING</td> <td>1.000</td> <td>PC</td> </tr> <tr> <td>VL1166A0</td> <td>BB6-AR6 L FITTING</td> <td>2.000</td> <td>PC</td> </tr> <tr> <td>VL1174C0</td> <td>D1.2 MM CALIBRATED D1.2 MM</td> <td>1.000</td> <td>PC</td> </tr> <tr> <td>VL1191A0</td> <td>ONE WASHING DISTRIBUTOR OUTLETS KIT</td> <td>1.000</td> <td>PC</td> </tr> <tr> <td>VL1214A0</td> <td>BAYONET - 6mm BARBED NRV VALVE</td> <td>1.000</td> <td>PC</td> </tr> <tr> <td>VM1605A0</td> <td>CLIP TWIST LOCK DIAM. 10,2-12,7 MM</td> <td>2.000</td> <td>PC</td> </tr> <tr> <td>VM2172A0</td> <td>LOCKING CLIP FOR PUMP WITH CIRCUIT</td> <td>3.000</td> <td>PC</td> </tr> </tbody> </table>	Code	Description	Qty	UOM	VL1019A0	VIBRATION DETERGENT PUMP	1.000	PC	VL1047A1	D6 PIPE HOLDER - D8 J.G. TERMINAL	1.000	PC	VL1054B0	ONE WASHING SYS INLET DISTRIBUTOR	1.000	PC	VL1102A1	DETERGENT LINE FILTER + BARBED VNR 6 MM	1.000	PC	VL1127A1	6mm BARBED T-SHAPED FITTING	1.000	PC	VL1128A1	D6 BARBED CHECK VALVE	2.000	PC	VL1165A0	BAM-BB6 STRAIGHT FITTING	1.000	PC	VL1166A0	BB6-AR6 L FITTING	2.000	PC	VL1174C0	D1.2 MM CALIBRATED D1.2 MM	1.000	PC	VL1191A0	ONE WASHING DISTRIBUTOR OUTLETS KIT	1.000	PC	VL1214A0	BAYONET - 6mm BARBED NRV VALVE	1.000	PC	VM1605A0	CLIP TWIST LOCK DIAM. 10,2-12,7 MM	2.000	PC	VM2172A0	LOCKING CLIP FOR PUMP WITH CIRCUIT	3.000	PC	KVL1222A	EUR 0311 ONE PLUS CLEANING SYSTEM KIT	<table border="1"> <thead> <tr> <th>Code</th> <th>Description</th> <th>Qty</th> <th>UOM</th> </tr> </thead> <tbody> <tr> <td>0H2486A0</td> <td>0311 WASHING CIRCUIT PLAT</td> <td>1.000</td> <td>PC</td> </tr> <tr> <td>EL1440A0</td> <td>WATER SELF CLEANING VALVE</td> <td>1.000</td> <td>PC</td> </tr> <tr> <td>GN1526A0</td> <td>INT. D.=6.9 TH=1.8 O-RIN</td> <td>3.000</td> <td>PC</td> </tr> <tr> <td>RC1018A0</td> <td>ZINC PLATED D12 ELASTIC CLAMP</td> <td>1.000</td> <td>PC</td> </tr> <tr> <td>RC1019A0</td> <td>D=10 ELASTIC CLAMP</td> <td>14.000</td> <td>PC</td> </tr> </tbody> </table>	Code	Description	Qty	UOM	0H2486A0	0311 WASHING CIRCUIT PLAT	1.000	PC	EL1440A0	WATER SELF CLEANING VALVE	1.000	PC	GN1526A0	INT. D.=6.9 TH=1.8 O-RIN	3.000	PC	RC1018A0	ZINC PLATED D12 ELASTIC CLAMP	1.000	PC	RC1019A0	D=10 ELASTIC CLAMP	14.000	PC
			Code	Description	Qty	UOM																																																																																		
VL1019A0	VIBRATION DETERGENT PUMP	1.000	PC																																																																																					
VL1047A1	D6 PIPE HOLDER - D8 J.G. TERMINAL	1.000	PC																																																																																					
VL1054B0	ONE WASHING SYS INLET DISTRIBUTOR	1.000	PC																																																																																					
VL1102A1	DETERGENT LINE FILTER + BARBED VNR 6 MM	1.000	PC																																																																																					
VL1127A1	6mm BARBED T-SHAPED FITTING	1.000	PC																																																																																					
VL1128A1	D6 BARBED CHECK VALVE	2.000	PC																																																																																					
VL1165A0	BAM-BB6 STRAIGHT FITTING	1.000	PC																																																																																					
VL1166A0	BB6-AR6 L FITTING	2.000	PC																																																																																					
VL1174C0	D1.2 MM CALIBRATED D1.2 MM	1.000	PC																																																																																					
VL1191A0	ONE WASHING DISTRIBUTOR OUTLETS KIT	1.000	PC																																																																																					
VL1214A0	BAYONET - 6mm BARBED NRV VALVE	1.000	PC																																																																																					
VM1605A0	CLIP TWIST LOCK DIAM. 10,2-12,7 MM	2.000	PC																																																																																					
VM2172A0	LOCKING CLIP FOR PUMP WITH CIRCUIT	3.000	PC																																																																																					
Code	Description	Qty	UOM																																																																																					
0H2486A0	0311 WASHING CIRCUIT PLAT	1.000	PC																																																																																					
EL1440A0	WATER SELF CLEANING VALVE	1.000	PC																																																																																					
GN1526A0	INT. D.=6.9 TH=1.8 O-RIN	3.000	PC																																																																																					
RC1018A0	ZINC PLATED D12 ELASTIC CLAMP	1.000	PC																																																																																					
RC1019A0	D=10 ELASTIC CLAMP	14.000	PC																																																																																					

COMPONENT			SPARE PART																																																																						
Code	Description	Image	Code	Description	Kit components																																																																				
VL1054B	ONE WASHING SYS INLET DISTRIBUTOR		KVL1222A	EUR 0311 ONE PLUS CLEANING SYSTEM KIT	<table border="1"> <thead> <tr> <th>Code</th> <th>Description</th> <th>Qty</th> <th>UOM</th> </tr> </thead> <tbody> <tr> <td>RC1242A0</td> <td>D=10 CLOSED CAP</td> <td>2.000</td> <td>PC</td> </tr> <tr> <td>TB2821A0</td> <td>EPDM 6X10 L=40MM PIPE</td> <td>6.000</td> <td>PC</td> </tr> <tr> <td>TB3004A0</td> <td>TB2820A L=550mm EPDM BLACK PIPE</td> <td>1.000</td> <td>PC</td> </tr> <tr> <td>TB3009B0</td> <td>TB3132A-ONE OVEN WASHING INLET</td> <td>1.000</td> <td>PC</td> </tr> <tr> <td>TB3225B0</td> <td>TB2820A-TAN K-WASHYNG SYS CONNECTION</td> <td>1.000</td> <td>PC</td> </tr> <tr> <td>VI1220A1</td> <td>4,2x12 TCB SELF-TAPPIN G SCREW</td> <td>4.000</td> <td>PC</td> </tr> <tr> <td>VL1019A0</td> <td>VIBRATION DETERGENT PUMP</td> <td>1.000</td> <td>PC</td> </tr> <tr> <td>VL1047A1</td> <td>D6 PIPE HOLDER - D8 J.G. TERMINAL</td> <td>1.000</td> <td>PC</td> </tr> <tr> <td>VL1054B0</td> <td>ONE WASHING SYS INLET DISTRIBUTOR</td> <td>1.000</td> <td>PC</td> </tr> <tr> <td>VL1102A1</td> <td>DETERGENT LINE FILTER + BARBED VNR 6 MM</td> <td>1.000</td> <td>PC</td> </tr> <tr> <td>VL1128A1</td> <td>D6 BARBED CHECK VALVE</td> <td>2.000</td> <td>PC</td> </tr> <tr> <td>VL1166A0</td> <td>BB6-AR6 L FITTING</td> <td>1.000</td> <td>PC</td> </tr> <tr> <td>VL1174C0</td> <td>D1.2 MM CALIBRATED D1.2 MM</td> <td>1.000</td> <td>PC</td> </tr> <tr> <td>VL1191A0</td> <td>ONE WASHING DISTRIBUTOR OUTLETS KIT</td> <td>1.000</td> <td>PC</td> </tr> <tr> <td>VL1214A0</td> <td>BAYONET - 6mm BARBED NRV VALVE</td> <td>1.000</td> <td>PC</td> </tr> <tr> <td>VM2172A0</td> <td>LOCKING CLIP FOR PUMP WITH CIRCUIT</td> <td>2.000</td> <td>PC</td> </tr> </tbody> </table>	Code	Description	Qty	UOM	RC1242A0	D=10 CLOSED CAP	2.000	PC	TB2821A0	EPDM 6X10 L=40MM PIPE	6.000	PC	TB3004A0	TB2820A L=550mm EPDM BLACK PIPE	1.000	PC	TB3009B0	TB3132A-ONE OVEN WASHING INLET	1.000	PC	TB3225B0	TB2820A-TAN K-WASHYNG SYS CONNECTION	1.000	PC	VI1220A1	4,2x12 TCB SELF-TAPPIN G SCREW	4.000	PC	VL1019A0	VIBRATION DETERGENT PUMP	1.000	PC	VL1047A1	D6 PIPE HOLDER - D8 J.G. TERMINAL	1.000	PC	VL1054B0	ONE WASHING SYS INLET DISTRIBUTOR	1.000	PC	VL1102A1	DETERGENT LINE FILTER + BARBED VNR 6 MM	1.000	PC	VL1128A1	D6 BARBED CHECK VALVE	2.000	PC	VL1166A0	BB6-AR6 L FITTING	1.000	PC	VL1174C0	D1.2 MM CALIBRATED D1.2 MM	1.000	PC	VL1191A0	ONE WASHING DISTRIBUTOR OUTLETS KIT	1.000	PC	VL1214A0	BAYONET - 6mm BARBED NRV VALVE	1.000	PC	VM2172A0	LOCKING CLIP FOR PUMP WITH CIRCUIT	2.000	PC
					Code	Description	Qty	UOM																																																																	
					RC1242A0	D=10 CLOSED CAP	2.000	PC																																																																	
					TB2821A0	EPDM 6X10 L=40MM PIPE	6.000	PC																																																																	
					TB3004A0	TB2820A L=550mm EPDM BLACK PIPE	1.000	PC																																																																	
					TB3009B0	TB3132A-ONE OVEN WASHING INLET	1.000	PC																																																																	
					TB3225B0	TB2820A-TAN K-WASHYNG SYS CONNECTION	1.000	PC																																																																	
					VI1220A1	4,2x12 TCB SELF-TAPPIN G SCREW	4.000	PC																																																																	
					VL1019A0	VIBRATION DETERGENT PUMP	1.000	PC																																																																	
					VL1047A1	D6 PIPE HOLDER - D8 J.G. TERMINAL	1.000	PC																																																																	
					VL1054B0	ONE WASHING SYS INLET DISTRIBUTOR	1.000	PC																																																																	
					VL1102A1	DETERGENT LINE FILTER + BARBED VNR 6 MM	1.000	PC																																																																	
					VL1128A1	D6 BARBED CHECK VALVE	2.000	PC																																																																	
					VL1166A0	BB6-AR6 L FITTING	1.000	PC																																																																	
					VL1174C0	D1.2 MM CALIBRATED D1.2 MM	1.000	PC																																																																	
					VL1191A0	ONE WASHING DISTRIBUTOR OUTLETS KIT	1.000	PC																																																																	
					VL1214A0	BAYONET - 6mm BARBED NRV VALVE	1.000	PC																																																																	
VM2172A0	LOCKING CLIP FOR PUMP WITH CIRCUIT	2.000	PC																																																																						



COMPONENT			SPARE PART																																																																																		
Code	Description	Image	Code	Description	Kit components																																																																																
VL1054B	ONE WASHING SYS INLET DISTRIBUTOR		KVL1213A	US PLUS COMPACT WASHING SYSTEM KIT	<table border="1"> <thead> <tr> <th>Code</th> <th>Description</th> <th>Qty</th> <th>UOM</th> </tr> </thead> <tbody> <tr> <td>0H2428A2</td> <td>XECC PLUS WASHING CIRCUIT PLAT</td> <td>1.000</td> <td>PC</td> </tr> <tr> <td>EL1450A0</td> <td>US SELF-CLEANIN G WATER SOLENOID</td> <td>3.000</td> <td>PC</td> </tr> <tr> <td>GN1312A0</td> <td>RUBBER CABLE-PASSI NG DE=26 DI=15 SP=10</td> <td>1.000</td> <td>PC</td> </tr> <tr> <td>GN1526A0</td> <td>INT. D.=6.9 TH=1.8 O-RIN</td> <td>7.000</td> <td>PC</td> </tr> <tr> <td>RC1018A0</td> <td>ZINC PLATED D12 ELASTIC CLAMP</td> <td>2.000</td> <td>PC</td> </tr> <tr> <td>RC1019A0</td> <td>D=10 ELASTIC CLAMP</td> <td>14.000</td> <td>PC</td> </tr> <tr> <td>RC1130A0</td> <td>130x2.6 CLAM</td> <td>1.000</td> <td>PC</td> </tr> <tr> <td>RC1131A0</td> <td>200x2.6 BLACK CLAMP</td> <td>1.000</td> <td>PC</td> </tr> <tr> <td>RC1242A0</td> <td>D=10 CLOSED CAP</td> <td>2.000</td> <td>PC</td> </tr> <tr> <td>RC1356A0</td> <td>*STRAIGHT THREADED FEMALE END 8x1/4" BS</td> <td>1.000</td> <td>PC</td> </tr> <tr> <td>TB2821A0</td> <td>EPDM 6X10 L=40MM PIPE</td> <td>6.000</td> <td>PC</td> </tr> <tr> <td>TB3004A0</td> <td>TB2820A L=550mm EPDM BLACK PIPE</td> <td>1.000</td> <td>PC</td> </tr> <tr> <td>TB3005B0</td> <td>TB3132A L=550mm EPDM WHITE-BLUE PIPE</td> <td>1.000</td> <td>PC</td> </tr> <tr> <td>TB3469A0</td> <td></td> <td>1.000</td> <td>PC</td> </tr> <tr> <td>VL1019A0</td> <td>VIBRATION DETERGENT PUMP</td> <td>1.000</td> <td>PC</td> </tr> <tr> <td>VL1047A1</td> <td>D6 PIPE HOLDER - D8 J.G. TERMINAL</td> <td>1.000</td> <td>PC</td> </tr> <tr> <td>VL1054B0</td> <td>ONE WASHING SYS INLET DISTRIBUTOR</td> <td>1.000</td> <td>PC</td> </tr> <tr> <td>VL1102A1</td> <td>DETERGENT LINE FILTER + BARBED VNR 6 MM</td> <td>1.000</td> <td>PC</td> </tr> <tr> <td>VL1128A1</td> <td>D6 BARBED CHECK VALVE</td> <td>2.000</td> <td>PC</td> </tr> </tbody> </table>	Code	Description	Qty	UOM	0H2428A2	XECC PLUS WASHING CIRCUIT PLAT	1.000	PC	EL1450A0	US SELF-CLEANIN G WATER SOLENOID	3.000	PC	GN1312A0	RUBBER CABLE-PASSI NG DE=26 DI=15 SP=10	1.000	PC	GN1526A0	INT. D.=6.9 TH=1.8 O-RIN	7.000	PC	RC1018A0	ZINC PLATED D12 ELASTIC CLAMP	2.000	PC	RC1019A0	D=10 ELASTIC CLAMP	14.000	PC	RC1130A0	130x2.6 CLAM	1.000	PC	RC1131A0	200x2.6 BLACK CLAMP	1.000	PC	RC1242A0	D=10 CLOSED CAP	2.000	PC	RC1356A0	*STRAIGHT THREADED FEMALE END 8x1/4" BS	1.000	PC	TB2821A0	EPDM 6X10 L=40MM PIPE	6.000	PC	TB3004A0	TB2820A L=550mm EPDM BLACK PIPE	1.000	PC	TB3005B0	TB3132A L=550mm EPDM WHITE-BLUE PIPE	1.000	PC	TB3469A0		1.000	PC	VL1019A0	VIBRATION DETERGENT PUMP	1.000	PC	VL1047A1	D6 PIPE HOLDER - D8 J.G. TERMINAL	1.000	PC	VL1054B0	ONE WASHING SYS INLET DISTRIBUTOR	1.000	PC	VL1102A1	DETERGENT LINE FILTER + BARBED VNR 6 MM	1.000	PC	VL1128A1	D6 BARBED CHECK VALVE	2.000	PC
					Code	Description	Qty	UOM																																																																													
0H2428A2	XECC PLUS WASHING CIRCUIT PLAT	1.000	PC																																																																																		
EL1450A0	US SELF-CLEANIN G WATER SOLENOID	3.000	PC																																																																																		
GN1312A0	RUBBER CABLE-PASSI NG DE=26 DI=15 SP=10	1.000	PC																																																																																		
GN1526A0	INT. D.=6.9 TH=1.8 O-RIN	7.000	PC																																																																																		
RC1018A0	ZINC PLATED D12 ELASTIC CLAMP	2.000	PC																																																																																		
RC1019A0	D=10 ELASTIC CLAMP	14.000	PC																																																																																		
RC1130A0	130x2.6 CLAM	1.000	PC																																																																																		
RC1131A0	200x2.6 BLACK CLAMP	1.000	PC																																																																																		
RC1242A0	D=10 CLOSED CAP	2.000	PC																																																																																		
RC1356A0	*STRAIGHT THREADED FEMALE END 8x1/4" BS	1.000	PC																																																																																		
TB2821A0	EPDM 6X10 L=40MM PIPE	6.000	PC																																																																																		
TB3004A0	TB2820A L=550mm EPDM BLACK PIPE	1.000	PC																																																																																		
TB3005B0	TB3132A L=550mm EPDM WHITE-BLUE PIPE	1.000	PC																																																																																		
TB3469A0		1.000	PC																																																																																		
VL1019A0	VIBRATION DETERGENT PUMP	1.000	PC																																																																																		
VL1047A1	D6 PIPE HOLDER - D8 J.G. TERMINAL	1.000	PC																																																																																		
VL1054B0	ONE WASHING SYS INLET DISTRIBUTOR	1.000	PC																																																																																		
VL1102A1	DETERGENT LINE FILTER + BARBED VNR 6 MM	1.000	PC																																																																																		
VL1128A1	D6 BARBED CHECK VALVE	2.000	PC																																																																																		

COMPONENT			SPARE PART																																																							
Code	Description	Image	Code	Description	Kit components																																																					
VL1054B	ONE WASHING SYS INLET DISTRIBUTOR		KVL1213A	US PLUS COMPACT WASHING SYSTEM KIT	<table border="1"> <thead> <tr> <th>Code</th> <th>Description</th> <th>Qty</th> <th>UOM</th> </tr> </thead> <tbody> <tr> <td>VL1165A0</td> <td>BAM-BB6 STRAIGHT FITTING</td> <td>1.000</td> <td>PC</td> </tr> <tr> <td>VL1166A0</td> <td>BB6-AR6 L FITTING</td> <td>3.000</td> <td>PC</td> </tr> <tr> <td>VL1174C0</td> <td>D1.2 MM CALIBRATED D1.2 MM</td> <td>1.000</td> <td>PC</td> </tr> <tr> <td>VL1185A0</td> <td>2 WAYS PLUS WASHING DISTRIBUTOR</td> <td>1.000</td> <td>PC</td> </tr> <tr> <td>VL1398A0</td> <td>1/4 M N.O. CIL PRESSURE SWITCH</td> <td>1.000</td> <td>PC</td> </tr> <tr> <td>VM2172A0</td> <td>LOCKING CLIP FOR PUMP WITH CIRCUIT</td> <td>6.000</td> <td>PC</td> </tr> </tbody> </table>	Code	Description	Qty	UOM	VL1165A0	BAM-BB6 STRAIGHT FITTING	1.000	PC	VL1166A0	BB6-AR6 L FITTING	3.000	PC	VL1174C0	D1.2 MM CALIBRATED D1.2 MM	1.000	PC	VL1185A0	2 WAYS PLUS WASHING DISTRIBUTOR	1.000	PC	VL1398A0	1/4 M N.O. CIL PRESSURE SWITCH	1.000	PC	VM2172A0	LOCKING CLIP FOR PUMP WITH CIRCUIT	6.000	PC																									
			Code	Description	Qty	UOM																																																				
VL1165A0	BAM-BB6 STRAIGHT FITTING	1.000	PC																																																							
VL1166A0	BB6-AR6 L FITTING	3.000	PC																																																							
VL1174C0	D1.2 MM CALIBRATED D1.2 MM	1.000	PC																																																							
VL1185A0	2 WAYS PLUS WASHING DISTRIBUTOR	1.000	PC																																																							
VL1398A0	1/4 M N.O. CIL PRESSURE SWITCH	1.000	PC																																																							
VM2172A0	LOCKING CLIP FOR PUMP WITH CIRCUIT	6.000	PC																																																							
KVL1212A	EUR COMPACT PLUS CLEANING SYSTEM KIT	<table border="1"> <thead> <tr> <th>Code</th> <th>Description</th> <th>Qty</th> <th>UOM</th> </tr> </thead> <tbody> <tr> <td>0H2428A2</td> <td>XECC PLUS WASHING CIRCUIT PLAT</td> <td>1.000</td> <td>PC</td> </tr> <tr> <td>EL1440A0</td> <td>WATER SELF CLEANING VALVE</td> <td>3.000</td> <td>PC</td> </tr> <tr> <td>GN1312A0</td> <td>RUBBER CABLE-PASSI NG DE=26 DI=15 SP=10</td> <td>1.000</td> <td>PC</td> </tr> <tr> <td>GN1526A0</td> <td>INT. D.=6.9 TH=1.8 O-RIN</td> <td>7.000</td> <td>PC</td> </tr> <tr> <td>RC1018A0</td> <td>ZINC PLATED D12 ELASTIC CLAMP</td> <td>2.000</td> <td>PC</td> </tr> <tr> <td>RC1019A0</td> <td>D=10 ELASTIC CLAMP</td> <td>14.000</td> <td>PC</td> </tr> <tr> <td>RC1130A0</td> <td>130x2.6 CLAM</td> <td>1.000</td> <td>PC</td> </tr> <tr> <td>RC1131A0</td> <td>200x2.6 BLACK CLAMP</td> <td>1.000</td> <td>PC</td> </tr> <tr> <td>RC1242A0</td> <td>D=10 CLOSED CAP</td> <td>2.000</td> <td>PC</td> </tr> <tr> <td>RC1356A0</td> <td>"STRAIGHT THREADED FEMALE END 8x1/4" BS</td> <td>1.000</td> <td>PC</td> </tr> <tr> <td>TB2821A0</td> <td>EPDM 6X10 L=40MM PIPE</td> <td>6.000</td> <td>PC</td> </tr> <tr> <td>TB3004A0</td> <td>TB2820A L=550mm EPDM BLACK PIPE</td> <td>2.000</td> <td>PC</td> </tr> <tr> <td>TB3005B0</td> <td>TB3132A L=550mm EPDM WHITE-BLUE PIPE</td> <td>1.000</td> <td>PC</td> </tr> </tbody> </table>	Code	Description	Qty	UOM	0H2428A2	XECC PLUS WASHING CIRCUIT PLAT	1.000	PC	EL1440A0	WATER SELF CLEANING VALVE	3.000	PC	GN1312A0	RUBBER CABLE-PASSI NG DE=26 DI=15 SP=10	1.000	PC	GN1526A0	INT. D.=6.9 TH=1.8 O-RIN	7.000	PC	RC1018A0	ZINC PLATED D12 ELASTIC CLAMP	2.000	PC	RC1019A0	D=10 ELASTIC CLAMP	14.000	PC	RC1130A0	130x2.6 CLAM	1.000	PC	RC1131A0	200x2.6 BLACK CLAMP	1.000	PC	RC1242A0	D=10 CLOSED CAP	2.000	PC	RC1356A0	"STRAIGHT THREADED FEMALE END 8x1/4" BS	1.000	PC	TB2821A0	EPDM 6X10 L=40MM PIPE	6.000	PC	TB3004A0	TB2820A L=550mm EPDM BLACK PIPE	2.000	PC	TB3005B0	TB3132A L=550mm EPDM WHITE-BLUE PIPE	1.000	PC
Code	Description	Qty	UOM																																																							
0H2428A2	XECC PLUS WASHING CIRCUIT PLAT	1.000	PC																																																							
EL1440A0	WATER SELF CLEANING VALVE	3.000	PC																																																							
GN1312A0	RUBBER CABLE-PASSI NG DE=26 DI=15 SP=10	1.000	PC																																																							
GN1526A0	INT. D.=6.9 TH=1.8 O-RIN	7.000	PC																																																							
RC1018A0	ZINC PLATED D12 ELASTIC CLAMP	2.000	PC																																																							
RC1019A0	D=10 ELASTIC CLAMP	14.000	PC																																																							
RC1130A0	130x2.6 CLAM	1.000	PC																																																							
RC1131A0	200x2.6 BLACK CLAMP	1.000	PC																																																							
RC1242A0	D=10 CLOSED CAP	2.000	PC																																																							
RC1356A0	"STRAIGHT THREADED FEMALE END 8x1/4" BS	1.000	PC																																																							
TB2821A0	EPDM 6X10 L=40MM PIPE	6.000	PC																																																							
TB3004A0	TB2820A L=550mm EPDM BLACK PIPE	2.000	PC																																																							
TB3005B0	TB3132A L=550mm EPDM WHITE-BLUE PIPE	1.000	PC																																																							



COMPONENT			SPARE PART																																																																																									
Code	Description	Image	Code	Description	Kit components																																																																																							
VL1054B	ONE WASHING SYS INLET DISTRIBUTOR		KVL1212A	EUR COMPACT PLUS CLEANING SYSTEM KIT	<table border="1"> <thead> <tr> <th>Code</th> <th>Description</th> <th>Qty</th> <th>UOM</th> </tr> </thead> <tbody> <tr> <td>TB3469A0</td> <td></td> <td>1.000</td> <td>PC</td> </tr> <tr> <td>VL1019A0</td> <td>VIBRATION DETERGENT PUMP</td> <td>1.000</td> <td>PC</td> </tr> <tr> <td>VL1047A1</td> <td>D6 PIPE HOLDER - D8 J.G. TERMINAL</td> <td>1.000</td> <td>PC</td> </tr> <tr> <td>VL1054B0</td> <td>ONE WASHING SYS INLET DISTRIBUTOR</td> <td>1.000</td> <td>PC</td> </tr> <tr> <td>VL1102A1</td> <td>DETERGENT LINE FILTER + BARBED VNR 6 MM</td> <td>1.000</td> <td>PC</td> </tr> <tr> <td>VL1128A1</td> <td>D6 BARBED CHECK VALVE</td> <td>2.000</td> <td>PC</td> </tr> <tr> <td>VL1165A0</td> <td>BAM-BB6 STRAIGHT FITTING</td> <td>1.000</td> <td>PC</td> </tr> <tr> <td>VL1166A0</td> <td>BB6-AR6 L FITTING</td> <td>3.000</td> <td>PC</td> </tr> <tr> <td>VL1174C0</td> <td>D1.2 MM CALIBRATED D1.2 MM</td> <td>1.000</td> <td>PC</td> </tr> <tr> <td>VL1185A0</td> <td>2 WAYS PLUS WASHING DISTRIBUTOR</td> <td>1.000</td> <td>PC</td> </tr> <tr> <td>VL1398A0</td> <td>1/4 M N.O. CIL PRESSURE SWITCH</td> <td>1.000</td> <td>PC</td> </tr> <tr> <td>VM2172A0</td> <td>LOCKING CLIP FOR PUMP WITH CIRCUIT</td> <td>6.000</td> <td>PC</td> </tr> </tbody> </table>	Code	Description	Qty	UOM	TB3469A0		1.000	PC	VL1019A0	VIBRATION DETERGENT PUMP	1.000	PC	VL1047A1	D6 PIPE HOLDER - D8 J.G. TERMINAL	1.000	PC	VL1054B0	ONE WASHING SYS INLET DISTRIBUTOR	1.000	PC	VL1102A1	DETERGENT LINE FILTER + BARBED VNR 6 MM	1.000	PC	VL1128A1	D6 BARBED CHECK VALVE	2.000	PC	VL1165A0	BAM-BB6 STRAIGHT FITTING	1.000	PC	VL1166A0	BB6-AR6 L FITTING	3.000	PC	VL1174C0	D1.2 MM CALIBRATED D1.2 MM	1.000	PC	VL1185A0	2 WAYS PLUS WASHING DISTRIBUTOR	1.000	PC	VL1398A0	1/4 M N.O. CIL PRESSURE SWITCH	1.000	PC	VM2172A0	LOCKING CLIP FOR PUMP WITH CIRCUIT	6.000	PC	KVL1211A	ONE COMPACT AND 0523-EP WASH. SYSTEM KIT	<table border="1"> <thead> <tr> <th>Code</th> <th>Description</th> <th>Qty</th> <th>UOM</th> </tr> </thead> <tbody> <tr> <td>0H2427A0</td> <td>XECC WASHING CIRCUIT HOLDING PLATE</td> <td>1.000</td> <td>PC</td> </tr> <tr> <td>EL1440A0</td> <td>WATER SELF CLEANING VALVE</td> <td>1.000</td> <td>PC</td> </tr> <tr> <td>GN1526A0</td> <td>INT. D.=6.9 TH=1.8 O-RIN</td> <td>3.000</td> <td>PC</td> </tr> <tr> <td>RC1018A0</td> <td>ZINC PLATED D12 ELASTIC CLAMP</td> <td>1.000</td> <td>PC</td> </tr> <tr> <td>RC1019A0</td> <td>D=10 ELASTIC CLAMP</td> <td>14.000</td> <td>PC</td> </tr> <tr> <td>RC1130A0</td> <td>130x2,6 CLAM</td> <td>1.000</td> <td>PC</td> </tr> <tr> <td>RC1242A0</td> <td>D=10 CLOSED CAP</td> <td>2.000</td> <td>PC</td> </tr> </tbody> </table>	Code	Description	Qty	UOM	0H2427A0	XECC WASHING CIRCUIT HOLDING PLATE	1.000	PC	EL1440A0	WATER SELF CLEANING VALVE	1.000	PC	GN1526A0	INT. D.=6.9 TH=1.8 O-RIN	3.000	PC	RC1018A0	ZINC PLATED D12 ELASTIC CLAMP	1.000	PC	RC1019A0	D=10 ELASTIC CLAMP	14.000	PC	RC1130A0	130x2,6 CLAM	1.000	PC	RC1242A0	D=10 CLOSED CAP	2.000	PC
			Code	Description	Qty	UOM																																																																																						
TB3469A0		1.000	PC																																																																																									
VL1019A0	VIBRATION DETERGENT PUMP	1.000	PC																																																																																									
VL1047A1	D6 PIPE HOLDER - D8 J.G. TERMINAL	1.000	PC																																																																																									
VL1054B0	ONE WASHING SYS INLET DISTRIBUTOR	1.000	PC																																																																																									
VL1102A1	DETERGENT LINE FILTER + BARBED VNR 6 MM	1.000	PC																																																																																									
VL1128A1	D6 BARBED CHECK VALVE	2.000	PC																																																																																									
VL1165A0	BAM-BB6 STRAIGHT FITTING	1.000	PC																																																																																									
VL1166A0	BB6-AR6 L FITTING	3.000	PC																																																																																									
VL1174C0	D1.2 MM CALIBRATED D1.2 MM	1.000	PC																																																																																									
VL1185A0	2 WAYS PLUS WASHING DISTRIBUTOR	1.000	PC																																																																																									
VL1398A0	1/4 M N.O. CIL PRESSURE SWITCH	1.000	PC																																																																																									
VM2172A0	LOCKING CLIP FOR PUMP WITH CIRCUIT	6.000	PC																																																																																									
Code	Description	Qty	UOM																																																																																									
0H2427A0	XECC WASHING CIRCUIT HOLDING PLATE	1.000	PC																																																																																									
EL1440A0	WATER SELF CLEANING VALVE	1.000	PC																																																																																									
GN1526A0	INT. D.=6.9 TH=1.8 O-RIN	3.000	PC																																																																																									
RC1018A0	ZINC PLATED D12 ELASTIC CLAMP	1.000	PC																																																																																									
RC1019A0	D=10 ELASTIC CLAMP	14.000	PC																																																																																									
RC1130A0	130x2,6 CLAM	1.000	PC																																																																																									
RC1242A0	D=10 CLOSED CAP	2.000	PC																																																																																									



COMPONENT			SPARE PART																																																																																					
Code	Description	Image	Code	Description	Kit components																																																																																			
VL1054B	ONE WASHING SYS INLET DISTRIBUTOR		KVL1211A	ONE COMPACT AND 0523-EP WASH. SYSTEM KIT	<table border="1"> <thead> <tr> <th>Code</th> <th>Description</th> <th>Qty</th> <th>UOM</th> </tr> </thead> <tbody> <tr> <td>TB1402A0</td> <td>TB2820A-DETE RGENT CIRCUIT-FILTE R PIPE</td> <td>1.000</td> <td>PC</td> </tr> <tr> <td>TB2821A0</td> <td>EPDM 6X10 L=40MM PIPE</td> <td>6.000</td> <td>PC</td> </tr> <tr> <td>TB3004A0</td> <td>TB2820A L=550mm EPDM BLACK PIPE</td> <td>1.000</td> <td>PC</td> </tr> <tr> <td>TB3469A0</td> <td></td> <td>1.000</td> <td>PC</td> </tr> <tr> <td>VI1220A1</td> <td>4,2x12 TCB SELF-TAPPIN G SCREW</td> <td>4.000</td> <td>PC</td> </tr> <tr> <td>VL1019A0</td> <td>VIBRATION DETERGENT PUMP</td> <td>1.000</td> <td>PC</td> </tr> <tr> <td>VL1047A1</td> <td>D6 PIPE HOLDER - D6 J.G. TERMINAL</td> <td>1.000</td> <td>PC</td> </tr> <tr> <td>VL1054B0</td> <td>ONE WASHING SYS INLET DISTRIBUTOR</td> <td>1.000</td> <td>PC</td> </tr> <tr> <td>VL1102A1</td> <td>DETERGENT LINE FILTER + BARBED VNR 6 MM</td> <td>1.000</td> <td>PC</td> </tr> <tr> <td>VL1128A1</td> <td>D6 BARBED CHECK VALVE</td> <td>2.000</td> <td>PC</td> </tr> <tr> <td>VL1165A0</td> <td>BAM-BB6 STRAIGHT FITTING</td> <td>1.000</td> <td>PC</td> </tr> <tr> <td>VL1166A0</td> <td>BB6-AR6 L FITTING</td> <td>1.000</td> <td>PC</td> </tr> <tr> <td>VL1174C0</td> <td>D1.2 MM CALIBRATED D1.2 MM</td> <td>1.000</td> <td>PC</td> </tr> <tr> <td>VL1191A0</td> <td>ONE WASHING DISTRIBUTOR OUTLETS KIT</td> <td>1.000</td> <td>PC</td> </tr> <tr> <td>VM2172A0</td> <td>LOCKING CLIP FOR PUMP WITH CIRCUIT</td> <td>2.000</td> <td>PC</td> </tr> </tbody> </table>	Code	Description	Qty	UOM	TB1402A0	TB2820A-DETE RGENT CIRCUIT-FILTE R PIPE	1.000	PC	TB2821A0	EPDM 6X10 L=40MM PIPE	6.000	PC	TB3004A0	TB2820A L=550mm EPDM BLACK PIPE	1.000	PC	TB3469A0		1.000	PC	VI1220A1	4,2x12 TCB SELF-TAPPIN G SCREW	4.000	PC	VL1019A0	VIBRATION DETERGENT PUMP	1.000	PC	VL1047A1	D6 PIPE HOLDER - D6 J.G. TERMINAL	1.000	PC	VL1054B0	ONE WASHING SYS INLET DISTRIBUTOR	1.000	PC	VL1102A1	DETERGENT LINE FILTER + BARBED VNR 6 MM	1.000	PC	VL1128A1	D6 BARBED CHECK VALVE	2.000	PC	VL1165A0	BAM-BB6 STRAIGHT FITTING	1.000	PC	VL1166A0	BB6-AR6 L FITTING	1.000	PC	VL1174C0	D1.2 MM CALIBRATED D1.2 MM	1.000	PC	VL1191A0	ONE WASHING DISTRIBUTOR OUTLETS KIT	1.000	PC	VM2172A0	LOCKING CLIP FOR PUMP WITH CIRCUIT	2.000	PC	KVL1198A	MM EU HOOD CLEANING SYSTEM KIT	<table border="1"> <thead> <tr> <th>Code</th> <th>Description</th> <th>Qty</th> <th>UOM</th> </tr> </thead> <tbody> <tr> <td>0H2213A1</td> <td>HOOD WATER CIRCUIT PLAT</td> <td>1.000</td> <td>PC</td> </tr> <tr> <td>EL1440A0</td> <td>WATER SELF CLEANING VALVE</td> <td>2.000</td> <td>PC</td> </tr> <tr> <td>GN1526A0</td> <td>INT. D.=6.9 TH=1.8 O-RIN</td> <td>5.000</td> <td>PC</td> </tr> </tbody> </table>	Code	Description	Qty	UOM	0H2213A1	HOOD WATER CIRCUIT PLAT	1.000	PC	EL1440A0	WATER SELF CLEANING VALVE	2.000	PC	GN1526A0	INT. D.=6.9 TH=1.8 O-RIN	5.000	PC
			Code	Description	Qty	UOM																																																																																		
TB1402A0	TB2820A-DETE RGENT CIRCUIT-FILTE R PIPE	1.000	PC																																																																																					
TB2821A0	EPDM 6X10 L=40MM PIPE	6.000	PC																																																																																					
TB3004A0	TB2820A L=550mm EPDM BLACK PIPE	1.000	PC																																																																																					
TB3469A0		1.000	PC																																																																																					
VI1220A1	4,2x12 TCB SELF-TAPPIN G SCREW	4.000	PC																																																																																					
VL1019A0	VIBRATION DETERGENT PUMP	1.000	PC																																																																																					
VL1047A1	D6 PIPE HOLDER - D6 J.G. TERMINAL	1.000	PC																																																																																					
VL1054B0	ONE WASHING SYS INLET DISTRIBUTOR	1.000	PC																																																																																					
VL1102A1	DETERGENT LINE FILTER + BARBED VNR 6 MM	1.000	PC																																																																																					
VL1128A1	D6 BARBED CHECK VALVE	2.000	PC																																																																																					
VL1165A0	BAM-BB6 STRAIGHT FITTING	1.000	PC																																																																																					
VL1166A0	BB6-AR6 L FITTING	1.000	PC																																																																																					
VL1174C0	D1.2 MM CALIBRATED D1.2 MM	1.000	PC																																																																																					
VL1191A0	ONE WASHING DISTRIBUTOR OUTLETS KIT	1.000	PC																																																																																					
VM2172A0	LOCKING CLIP FOR PUMP WITH CIRCUIT	2.000	PC																																																																																					
Code	Description	Qty	UOM																																																																																					
0H2213A1	HOOD WATER CIRCUIT PLAT	1.000	PC																																																																																					
EL1440A0	WATER SELF CLEANING VALVE	2.000	PC																																																																																					
GN1526A0	INT. D.=6.9 TH=1.8 O-RIN	5.000	PC																																																																																					

COMPONENT			SPARE PART																																																																																										
Code	Description	Image	Code	Description	Kit components																																																																																								
VL1054B	ONE WASHING SYS INLET DISTRIBUTOR		KVL1198A	MM EU HOOD CLEANING SYSTEM KIT	<table border="1"> <thead> <tr> <th>Code</th> <th>Description</th> <th>Qty</th> <th>UOM</th> </tr> </thead> <tbody> <tr> <td>RC1018A0</td> <td>ZINC PLATED D12 ELASTIC CLAMP</td> <td>4.000</td> <td>PC</td> </tr> <tr> <td>RC1019A0</td> <td>D=10 ELASTIC CLAMP</td> <td>16.000</td> <td>PC</td> </tr> <tr> <td>RC1131A0</td> <td>200x2.6 BLACK CLAMP</td> <td>1.000</td> <td>PC</td> </tr> <tr> <td>RC1242A0</td> <td>D=10 CLOSED CAP</td> <td>2.000</td> <td>PC</td> </tr> <tr> <td>TB2821A0</td> <td>EPDM 6X10 L=40MM PIPE</td> <td>6.000</td> <td>PC</td> </tr> <tr> <td>TB2994A0</td> <td>HOOD DETERGENT PIPE</td> <td>2.000</td> <td>PC</td> </tr> <tr> <td>TB3252A0</td> <td></td> <td>2.000</td> <td>PC</td> </tr> <tr> <td>VI1220A1</td> <td>4,2x12 TCB SELF-TAPPIN G SCREW</td> <td>3.000</td> <td>PC</td> </tr> <tr> <td>VL1019A0</td> <td>VIBRATION DETERGENT PUMP</td> <td>1.000</td> <td>PC</td> </tr> <tr> <td>VL1047A1</td> <td>D6 PIPE HOLDER - D8 J.G. TERMINAL</td> <td>2.000</td> <td>PC</td> </tr> <tr> <td>VL1054B0</td> <td>ONE WASHING SYS INLET DISTRIBUTOR</td> <td>1.000</td> <td>PC</td> </tr> <tr> <td>VL1102A1</td> <td>DETERGENT LINE FILTER + BARBED VNR 6 MM</td> <td>1.000</td> <td>PC</td> </tr> <tr> <td>VL1127A1</td> <td>6mm BARBED T-SHAPED FITTING</td> <td>1.000</td> <td>PC</td> </tr> <tr> <td>VL1128A1</td> <td>D6 BARBED CHECK VALVE</td> <td>2.000</td> <td>PC</td> </tr> <tr> <td>VL1165A0</td> <td>BAM-BB6 STRAIGHT FITTING</td> <td>1.000</td> <td>PC</td> </tr> <tr> <td>VL1166A0</td> <td>BB6-AR6 L FITTING</td> <td>2.000</td> <td>PC</td> </tr> <tr> <td>VL1174C0</td> <td>D1.2 MM CALIBRATED D1.2 MM</td> <td>1.000</td> <td>PC</td> </tr> <tr> <td>VL1191A0</td> <td>ONE WASHING DISTRIBUTOR OUTLETS KIT</td> <td>1.000</td> <td>PC</td> </tr> <tr> <td>VL1214A0</td> <td>BAYONET - 6mm BARBED NRV VALVE</td> <td>1.000</td> <td>PC</td> </tr> <tr> <td>VM1605A0</td> <td>CLIP TWIST LOCK DIAM. 10,2-12,7 MM</td> <td>2.000</td> <td>PC</td> </tr> <tr> <td>VM2172A0</td> <td>LOCKING CLIP FOR PUMP WITH CIRCUIT</td> <td>5.000</td> <td>PC</td> </tr> </tbody> </table>	Code	Description	Qty	UOM	RC1018A0	ZINC PLATED D12 ELASTIC CLAMP	4.000	PC	RC1019A0	D=10 ELASTIC CLAMP	16.000	PC	RC1131A0	200x2.6 BLACK CLAMP	1.000	PC	RC1242A0	D=10 CLOSED CAP	2.000	PC	TB2821A0	EPDM 6X10 L=40MM PIPE	6.000	PC	TB2994A0	HOOD DETERGENT PIPE	2.000	PC	TB3252A0		2.000	PC	VI1220A1	4,2x12 TCB SELF-TAPPIN G SCREW	3.000	PC	VL1019A0	VIBRATION DETERGENT PUMP	1.000	PC	VL1047A1	D6 PIPE HOLDER - D8 J.G. TERMINAL	2.000	PC	VL1054B0	ONE WASHING SYS INLET DISTRIBUTOR	1.000	PC	VL1102A1	DETERGENT LINE FILTER + BARBED VNR 6 MM	1.000	PC	VL1127A1	6mm BARBED T-SHAPED FITTING	1.000	PC	VL1128A1	D6 BARBED CHECK VALVE	2.000	PC	VL1165A0	BAM-BB6 STRAIGHT FITTING	1.000	PC	VL1166A0	BB6-AR6 L FITTING	2.000	PC	VL1174C0	D1.2 MM CALIBRATED D1.2 MM	1.000	PC	VL1191A0	ONE WASHING DISTRIBUTOR OUTLETS KIT	1.000	PC	VL1214A0	BAYONET - 6mm BARBED NRV VALVE	1.000	PC	VM1605A0	CLIP TWIST LOCK DIAM. 10,2-12,7 MM	2.000	PC	VM2172A0	LOCKING CLIP FOR PUMP WITH CIRCUIT	5.000	PC
Code	Description	Qty	UOM																																																																																										
RC1018A0	ZINC PLATED D12 ELASTIC CLAMP	4.000	PC																																																																																										
RC1019A0	D=10 ELASTIC CLAMP	16.000	PC																																																																																										
RC1131A0	200x2.6 BLACK CLAMP	1.000	PC																																																																																										
RC1242A0	D=10 CLOSED CAP	2.000	PC																																																																																										
TB2821A0	EPDM 6X10 L=40MM PIPE	6.000	PC																																																																																										
TB2994A0	HOOD DETERGENT PIPE	2.000	PC																																																																																										
TB3252A0		2.000	PC																																																																																										
VI1220A1	4,2x12 TCB SELF-TAPPIN G SCREW	3.000	PC																																																																																										
VL1019A0	VIBRATION DETERGENT PUMP	1.000	PC																																																																																										
VL1047A1	D6 PIPE HOLDER - D8 J.G. TERMINAL	2.000	PC																																																																																										
VL1054B0	ONE WASHING SYS INLET DISTRIBUTOR	1.000	PC																																																																																										
VL1102A1	DETERGENT LINE FILTER + BARBED VNR 6 MM	1.000	PC																																																																																										
VL1127A1	6mm BARBED T-SHAPED FITTING	1.000	PC																																																																																										
VL1128A1	D6 BARBED CHECK VALVE	2.000	PC																																																																																										
VL1165A0	BAM-BB6 STRAIGHT FITTING	1.000	PC																																																																																										
VL1166A0	BB6-AR6 L FITTING	2.000	PC																																																																																										
VL1174C0	D1.2 MM CALIBRATED D1.2 MM	1.000	PC																																																																																										
VL1191A0	ONE WASHING DISTRIBUTOR OUTLETS KIT	1.000	PC																																																																																										
VL1214A0	BAYONET - 6mm BARBED NRV VALVE	1.000	PC																																																																																										
VM1605A0	CLIP TWIST LOCK DIAM. 10,2-12,7 MM	2.000	PC																																																																																										
VM2172A0	LOCKING CLIP FOR PUMP WITH CIRCUIT	5.000	PC																																																																																										



COMPONENT			SPARE PART					
Code	Description	Image	Code	Description	Kit components			
VL1054B	ONE WASHING SYS INLET DISTRIBUTOR		KVL1182A	ONE 1ROT CLEANING SYSTEM KIT (0311 EXC.)	Code	Description	Qty	UOM
					0H2202A1	ONE WASHING WITH STEAM VALVE SUPPORT	1.000	PC
					EL1440A0	WATER SELF CLEANING VALVE	1.000	PC
					GN1526A0	INT. D.=6.9 TH=1.8 O-RIN	3.000	PC
					RC1018A0	ZINC PLATED D12 ELASTIC CLAMP	1.000	PC
					RC1019A0	D=10 ELASTIC CLAMP	14.000	PC
					RC1130A0	130x2,6 CLAM	2.000	PC
					RC1242A0	D=10 CLOSED CAP	2.000	PC
					TB2821A0	EPDM 6X10 L=40MM PIPE	6.000	PC
					TB3004A0	TB2820A L=550mm EPDM BLACK PIPE	1.000	PC
					TB3009B0	TB3132A-ONE OVEN WASHING INLET	1.000	PC
					TB3225B0	TB2820A-TAN K-WASHYNG SYS CONNECTION	1.000	PC
					VI1220A1	4,2x12 TCB SELF-TAPPIN G SCREW	1.000	PC
					VL1019A0	VIBRATION DETERGENT PUMP	1.000	PC
					VL1047A1	D6 PIPE HOLDER - D8 J.G. TERMINAL	1.000	PC
					VL1054B0	ONE WASHING SYS INLET DISTRIBUTOR	1.000	PC
					VL1102A1	DETERGENT LINE FILTER + BARBED VNR 6 MM	1.000	PC
					VL1128A1	D6 BARBED CHECK VALVE	2.000	PC
					VL1166A0	BB6-AR6 L FITTING	1.000	PC







COMPONENT			SPARE PART																																											
Code	Description	Image	Code	Description	Kit components																																									
VL1054B	ONE WASHING SYS INLET DISTRIBUTOR		KVL1182A	ONE 1ROT CLEANING SYSTEM KIT (0311 EXC.)	<table border="1"> <thead> <tr> <th>Code</th> <th>Description</th> <th>Qty</th> <th>UOM</th> </tr> </thead> <tbody> <tr> <td>VL1174C0</td> <td>D1.2 MM CALIBRATED D1.2 MM</td> <td>1.000</td> <td>PC</td> </tr> <tr> <td>VL1191A0</td> <td>ONE WASHING DISTRIBUTOR OUTLETS KIT</td> <td>1.000</td> <td>PC</td> </tr> <tr> <td>VL1214A0</td> <td>BAYONET - 6mm BARBED NRV VALVE</td> <td>1.000</td> <td>PC</td> </tr> <tr> <td>VM2172A0</td> <td>LOCKING CLIP FOR PUMP WITH CIRCUIT</td> <td>2.000</td> <td>PC</td> </tr> </tbody> </table>	Code	Description	Qty	UOM	VL1174C0	D1.2 MM CALIBRATED D1.2 MM	1.000	PC	VL1191A0	ONE WASHING DISTRIBUTOR OUTLETS KIT	1.000	PC	VL1214A0	BAYONET - 6mm BARBED NRV VALVE	1.000	PC	VM2172A0	LOCKING CLIP FOR PUMP WITH CIRCUIT	2.000	PC																					
			Code	Description	Qty	UOM																																								
			VL1174C0	D1.2 MM CALIBRATED D1.2 MM	1.000	PC																																								
VL1191A0	ONE WASHING DISTRIBUTOR OUTLETS KIT	1.000	PC																																											
VL1214A0	BAYONET - 6mm BARBED NRV VALVE	1.000	PC																																											
VM2172A0	LOCKING CLIP FOR PUMP WITH CIRCUIT	2.000	PC																																											
KVL0682A	>12/2019 ONE/HOODS WASHING SYST PUMP KIT	<table border="1"> <thead> <tr> <th>Code</th> <th>Description</th> <th>Qty</th> <th>UOM</th> </tr> </thead> <tbody> <tr> <td>GN1526A0</td> <td>INT. D.=6.9 TH=1.8 O-RIN</td> <td>1.000</td> <td>PC</td> </tr> <tr> <td>RC1019A0</td> <td>D=10 ELASTIC CLAMP</td> <td>6.000</td> <td>PC</td> </tr> <tr> <td>RC1242A0</td> <td>D=10 CLOSED CAP</td> <td>2.000</td> <td>PC</td> </tr> <tr> <td>TB2821A0</td> <td>EPDM 6X10 L=40MM PIPE</td> <td>3.000</td> <td>PC</td> </tr> <tr> <td>VL1019A0</td> <td>VIBRATION DETERGENT PUMP</td> <td>1.000</td> <td>PC</td> </tr> <tr> <td>VL1054B0</td> <td>ONE WASHING SYS INLET DISTRIBUTOR</td> <td>1.000</td> <td>PC</td> </tr> <tr> <td>VL1128A1</td> <td>D6 BARBED CHECK VALVE</td> <td>1.000</td> <td>PC</td> </tr> <tr> <td>VL1174C0</td> <td>D1.2 MM CALIBRATED D1.2 MM</td> <td>1.000</td> <td>PC</td> </tr> <tr> <td>VL1191A0</td> <td>ONE WASHING DISTRIBUTOR OUTLETS KIT</td> <td>1.000</td> <td>PC</td> </tr> <tr> <td>VM2172A0</td> <td>LOCKING CLIP FOR PUMP WITH CIRCUIT</td> <td>1.000</td> <td>PC</td> </tr> </tbody> </table>	Code	Description	Qty	UOM	GN1526A0	INT. D.=6.9 TH=1.8 O-RIN	1.000	PC	RC1019A0	D=10 ELASTIC CLAMP	6.000	PC	RC1242A0	D=10 CLOSED CAP	2.000	PC	TB2821A0	EPDM 6X10 L=40MM PIPE	3.000	PC	VL1019A0	VIBRATION DETERGENT PUMP	1.000	PC	VL1054B0	ONE WASHING SYS INLET DISTRIBUTOR	1.000	PC	VL1128A1	D6 BARBED CHECK VALVE	1.000	PC	VL1174C0	D1.2 MM CALIBRATED D1.2 MM	1.000	PC	VL1191A0	ONE WASHING DISTRIBUTOR OUTLETS KIT	1.000	PC	VM2172A0	LOCKING CLIP FOR PUMP WITH CIRCUIT	1.000	PC
Code	Description	Qty	UOM																																											
GN1526A0	INT. D.=6.9 TH=1.8 O-RIN	1.000	PC																																											
RC1019A0	D=10 ELASTIC CLAMP	6.000	PC																																											
RC1242A0	D=10 CLOSED CAP	2.000	PC																																											
TB2821A0	EPDM 6X10 L=40MM PIPE	3.000	PC																																											
VL1019A0	VIBRATION DETERGENT PUMP	1.000	PC																																											
VL1054B0	ONE WASHING SYS INLET DISTRIBUTOR	1.000	PC																																											
VL1128A1	D6 BARBED CHECK VALVE	1.000	PC																																											
VL1174C0	D1.2 MM CALIBRATED D1.2 MM	1.000	PC																																											
VL1191A0	ONE WASHING DISTRIBUTOR OUTLETS KIT	1.000	PC																																											
VM2172A0	LOCKING CLIP FOR PUMP WITH CIRCUIT	1.000	PC																																											
KVL0001A	LM TOP CLEANING SYSTEM KIT	<table border="1"> <thead> <tr> <th>Code</th> <th>Description</th> <th>Qty</th> <th>UOM</th> </tr> </thead> <tbody> <tr> <td>0H1226B0</td> <td>LineMissTop WASHING SYTEM CIRCUIT COVE</td> <td>1.000</td> <td>PC</td> </tr> <tr> <td>EL1436B0</td> <td>JG D8-BARBED D6 NRV WATER SOLENOID</td> <td>1.000</td> <td>PC</td> </tr> </tbody> </table>	Code	Description	Qty	UOM	0H1226B0	LineMissTop WASHING SYTEM CIRCUIT COVE	1.000	PC	EL1436B0	JG D8-BARBED D6 NRV WATER SOLENOID	1.000	PC																																
Code	Description	Qty	UOM																																											
0H1226B0	LineMissTop WASHING SYTEM CIRCUIT COVE	1.000	PC																																											
EL1436B0	JG D8-BARBED D6 NRV WATER SOLENOID	1.000	PC																																											



COMPONENT			SPARE PART																																																																														
Code	Description	Image	Code	Description	Kit components																																																																												
VL1054B	ONE WASHING SYS INLET DISTRIBUTOR		KVL0001A	LM TOP CLEANING SYSTEM KIT	<table border="1"> <thead> <tr> <th>Code</th> <th>Description</th> <th>Qty</th> <th>UOM</th> </tr> </thead> <tbody> <tr> <td>GN1312A0</td> <td>RUBBER CABLE-PASSI NG DE=26 DI=15 SP=10</td> <td>1.000</td> <td>PC</td> </tr> <tr> <td>GN1526A0</td> <td>INT. D.=6.9 TH=1.8 O-RIN</td> <td>1.000</td> <td>PC</td> </tr> <tr> <td>RC1019A0</td> <td>D=10 ELASTIC CLAMP</td> <td>5.000</td> <td>PC</td> </tr> <tr> <td>RC1242A0</td> <td>D=10 CLOSED CAP</td> <td>2.000</td> <td>PC</td> </tr> <tr> <td>RC1381A0</td> <td>BIFILAR PIPE CLIP D10.7</td> <td>3.000</td> <td>PC</td> </tr> <tr> <td>TB1114A1</td> <td>TB2820A-LM TOP DETERGENT PIPE COIL ROTOR</td> <td>1.000</td> <td>PC</td> </tr> <tr> <td>TB1116A0</td> <td>TB2343A-DETE RGENT HOLD DOWN WEIGHT PIPE</td> <td>1.000</td> <td>PC</td> </tr> <tr> <td>TB2821A0</td> <td>EPDM 6X10 L=40MM PIPE</td> <td>1.000</td> <td>PC</td> </tr> <tr> <td>VI1220A1</td> <td>4,2x12 TCB SELF-TAPPIN G SCREW</td> <td>1.000</td> <td>PC</td> </tr> <tr> <td>VL1019A0</td> <td>VIBRATION DETERGENT PUMP</td> <td>1.000</td> <td>PC</td> </tr> <tr> <td>VL1047A1</td> <td>D6 PIPE HOLDER - D6 J.G. TERMINAL</td> <td>1.000</td> <td>PC</td> </tr> <tr> <td>VL1053B0</td> <td>ONE WASHING SYS EXT DISTRIBUTOR</td> <td>1.000</td> <td>PC</td> </tr> <tr> <td>VL1054B0</td> <td>ONE WASHING SYS INLET DISTRIBUTOR</td> <td>1.000</td> <td>PC</td> </tr> <tr> <td>VL1061A0</td> <td>HOLD DOWN WEIGHT+NET FILTER+NON- RET. V.</td> <td>1.000</td> <td>PC</td> </tr> <tr> <td>VL1090A0</td> <td>1LT TANK UNOX.DET&RI NSE CAP</td> <td>1.000</td> <td>PC</td> </tr> <tr> <td>VL1128A1</td> <td>D6 BARBED CHECK VALVE</td> <td>2.000</td> <td>PC</td> </tr> <tr> <td>VM1066A0</td> <td>SADDLE CLIP FOR CABLES PASSING</td> <td>3.000</td> <td>PC</td> </tr> <tr> <td>VM1088A0</td> <td>NYLON CLICK CLAMP D7.9-D9.2</td> <td>1.000</td> <td>PC</td> </tr> </tbody> </table>	Code	Description	Qty	UOM	GN1312A0	RUBBER CABLE-PASSI NG DE=26 DI=15 SP=10	1.000	PC	GN1526A0	INT. D.=6.9 TH=1.8 O-RIN	1.000	PC	RC1019A0	D=10 ELASTIC CLAMP	5.000	PC	RC1242A0	D=10 CLOSED CAP	2.000	PC	RC1381A0	BIFILAR PIPE CLIP D10.7	3.000	PC	TB1114A1	TB2820A-LM TOP DETERGENT PIPE COIL ROTOR	1.000	PC	TB1116A0	TB2343A-DETE RGENT HOLD DOWN WEIGHT PIPE	1.000	PC	TB2821A0	EPDM 6X10 L=40MM PIPE	1.000	PC	VI1220A1	4,2x12 TCB SELF-TAPPIN G SCREW	1.000	PC	VL1019A0	VIBRATION DETERGENT PUMP	1.000	PC	VL1047A1	D6 PIPE HOLDER - D6 J.G. TERMINAL	1.000	PC	VL1053B0	ONE WASHING SYS EXT DISTRIBUTOR	1.000	PC	VL1054B0	ONE WASHING SYS INLET DISTRIBUTOR	1.000	PC	VL1061A0	HOLD DOWN WEIGHT+NET FILTER+NON- RET. V.	1.000	PC	VL1090A0	1LT TANK UNOX.DET&RI NSE CAP	1.000	PC	VL1128A1	D6 BARBED CHECK VALVE	2.000	PC	VM1066A0	SADDLE CLIP FOR CABLES PASSING	3.000	PC	VM1088A0	NYLON CLICK CLAMP D7.9-D9.2	1.000	PC
					Code	Description	Qty	UOM																																																																									
GN1312A0	RUBBER CABLE-PASSI NG DE=26 DI=15 SP=10	1.000	PC																																																																														
GN1526A0	INT. D.=6.9 TH=1.8 O-RIN	1.000	PC																																																																														
RC1019A0	D=10 ELASTIC CLAMP	5.000	PC																																																																														
RC1242A0	D=10 CLOSED CAP	2.000	PC																																																																														
RC1381A0	BIFILAR PIPE CLIP D10.7	3.000	PC																																																																														
TB1114A1	TB2820A-LM TOP DETERGENT PIPE COIL ROTOR	1.000	PC																																																																														
TB1116A0	TB2343A-DETE RGENT HOLD DOWN WEIGHT PIPE	1.000	PC																																																																														
TB2821A0	EPDM 6X10 L=40MM PIPE	1.000	PC																																																																														
VI1220A1	4,2x12 TCB SELF-TAPPIN G SCREW	1.000	PC																																																																														
VL1019A0	VIBRATION DETERGENT PUMP	1.000	PC																																																																														
VL1047A1	D6 PIPE HOLDER - D6 J.G. TERMINAL	1.000	PC																																																																														
VL1053B0	ONE WASHING SYS EXT DISTRIBUTOR	1.000	PC																																																																														
VL1054B0	ONE WASHING SYS INLET DISTRIBUTOR	1.000	PC																																																																														
VL1061A0	HOLD DOWN WEIGHT+NET FILTER+NON- RET. V.	1.000	PC																																																																														
VL1090A0	1LT TANK UNOX.DET&RI NSE CAP	1.000	PC																																																																														
VL1128A1	D6 BARBED CHECK VALVE	2.000	PC																																																																														
VM1066A0	SADDLE CLIP FOR CABLES PASSING	3.000	PC																																																																														
VM1088A0	NYLON CLICK CLAMP D7.9-D9.2	1.000	PC																																																																														

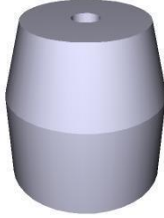



COMPONENT			SPARE PART																																		
Code	Description	Image	Code	Description	Kit components																																
VL1054B	ONE WASHING SYS INLET DISTRIBUTOR		KVL0001A	LM TOP CLEANING SYSTEM KIT	<table border="1"> <thead> <tr> <th>Code</th> <th>Description</th> <th>Qty</th> <th>UOM</th> </tr> </thead> <tbody> <tr> <td>VM1605A0</td> <td>CLIP TWIST LOCK DIAM. 10,2-12,7 MM</td> <td>1.000</td> <td>PC</td> </tr> <tr> <td>VM2172A0</td> <td>LOCKING CLIP FOR PUMP WITH CIRCUIT</td> <td>1.000</td> <td>PC</td> </tr> </tbody> </table>	Code	Description	Qty	UOM	VM1605A0	CLIP TWIST LOCK DIAM. 10,2-12,7 MM	1.000	PC	VM2172A0	LOCKING CLIP FOR PUMP WITH CIRCUIT	1.000	PC																				
Code	Description	Qty	UOM																																		
VM1605A0	CLIP TWIST LOCK DIAM. 10,2-12,7 MM	1.000	PC																																		
VM2172A0	LOCKING CLIP FOR PUMP WITH CIRCUIT	1.000	PC																																		
VL1128A	D6 BARBED CHECK VALVE		KVL1128A	D6 VNR BARBED VALVE KIT	<table border="1"> <thead> <tr> <th>Code</th> <th>Description</th> <th>Qty</th> <th>UOM</th> </tr> </thead> <tbody> <tr> <td>RC1019A0</td> <td>D=10 ELASTIC CLAMP</td> <td>4.000</td> <td>PC</td> </tr> <tr> <td>TB2820A0</td> <td>6X10 EPDM PIPE FOR WASHING SYSTEM</td> <td>0.080</td> <td>M</td> </tr> <tr> <td>VL1128A1</td> <td>D6 BARBED CHECK VALVE</td> <td>1.000</td> <td>PC</td> </tr> </tbody> </table>	Code	Description	Qty	UOM	RC1019A0	D=10 ELASTIC CLAMP	4.000	PC	TB2820A0	6X10 EPDM PIPE FOR WASHING SYSTEM	0.080	M	VL1128A1	D6 BARBED CHECK VALVE	1.000	PC																
Code	Description	Qty	UOM																																		
RC1019A0	D=10 ELASTIC CLAMP	4.000	PC																																		
TB2820A0	6X10 EPDM PIPE FOR WASHING SYSTEM	0.080	M																																		
VL1128A1	D6 BARBED CHECK VALVE	1.000	PC																																		
VL1174C	D1.2 MM CALIBRATED D1.2 M		VL1174C0	D1.2 MM CALIBRATED D1.2 M																																	
VL1191A	ONE WASHING DISTRIBUTOR OUTLETS KIT		KVL2618A	2 ROTOR ARMS ONE CLEANING SYSTEM KIT	<table border="1"> <thead> <tr> <th>Code</th> <th>Description</th> <th>Qty</th> <th>UOM</th> </tr> </thead> <tbody> <tr> <td>0H2202A1</td> <td>ONE WASHING WITH STEAM VALVE SUPPORT</td> <td>2.000</td> <td>PC</td> </tr> <tr> <td>CE1030A0</td> <td>FEMALE FASTON COVER 6.3X0.8 0,5-1mmg</td> <td>4.000</td> <td>PC</td> </tr> <tr> <td>CE1395A0</td> <td>6,3 X 0,8 iMALE FASTO</td> <td>2.000</td> <td>PC</td> </tr> <tr> <td>CE1545A0</td> <td>BLUE UNIP AWG18 ST.3135 WIRE</td> <td>2.000</td> <td>M</td> </tr> <tr> <td>CE1570A0</td> <td>WHITE UNIP AWG18 ST.3135 WIRE</td> <td>2.000</td> <td>M</td> </tr> <tr> <td>CE1660A0</td> <td>6,3x0,8 FEMALE FASTON COVE</td> <td>4.000</td> <td>PC</td> </tr> <tr> <td>CE1661A0</td> <td>MALE FASTON COVER 6,3x0,8</td> <td>2.000</td> <td>PC</td> </tr> </tbody> </table>	Code	Description	Qty	UOM	0H2202A1	ONE WASHING WITH STEAM VALVE SUPPORT	2.000	PC	CE1030A0	FEMALE FASTON COVER 6.3X0.8 0,5-1mmg	4.000	PC	CE1395A0	6,3 X 0,8 iMALE FASTO	2.000	PC	CE1545A0	BLUE UNIP AWG18 ST.3135 WIRE	2.000	M	CE1570A0	WHITE UNIP AWG18 ST.3135 WIRE	2.000	M	CE1660A0	6,3x0,8 FEMALE FASTON COVE	4.000	PC	CE1661A0	MALE FASTON COVER 6,3x0,8	2.000	PC
Code	Description	Qty	UOM																																		
0H2202A1	ONE WASHING WITH STEAM VALVE SUPPORT	2.000	PC																																		
CE1030A0	FEMALE FASTON COVER 6.3X0.8 0,5-1mmg	4.000	PC																																		
CE1395A0	6,3 X 0,8 iMALE FASTO	2.000	PC																																		
CE1545A0	BLUE UNIP AWG18 ST.3135 WIRE	2.000	M																																		
CE1570A0	WHITE UNIP AWG18 ST.3135 WIRE	2.000	M																																		
CE1660A0	6,3x0,8 FEMALE FASTON COVE	4.000	PC																																		
CE1661A0	MALE FASTON COVER 6,3x0,8	2.000	PC																																		



COMPONENT			SPARE PART																																																																																		
Code	Description	Image	Code	Description	Kit components																																																																																
VL1191A	ONE WASHING DISTRIBUTOR OUTLETS KIT		KVL2618A	2 ROTOR ARMS ONE CLEANING SYSTEM KIT	<table border="1"> <thead> <tr> <th>Code</th> <th>Description</th> <th>Qty</th> <th>UOM</th> </tr> </thead> <tbody> <tr> <td>EL1020A1</td> <td>D8 INTERMEDIAT E T-SHAPED FITTING</td> <td>1.000</td> <td>PC</td> </tr> <tr> <td>EL1440A0</td> <td>WATER SELF CLEANING VALVE</td> <td>2.000</td> <td>PC</td> </tr> <tr> <td>GN1526A0</td> <td>INT. D.=6.9 TH=1.8 O-RIN</td> <td>6.000</td> <td>PC</td> </tr> <tr> <td>RC1018A0</td> <td>ZINC PLATED D12 ELASTIC CLAMP</td> <td>2.000</td> <td>PC</td> </tr> <tr> <td>RC1019A0</td> <td>D=10 ELASTIC CLAMP</td> <td>28.000</td> <td>PC</td> </tr> <tr> <td>RC1130A0</td> <td>130x2,6 CLAM</td> <td>4.000</td> <td>PC</td> </tr> <tr> <td>RC1242A0</td> <td>D=10 CLOSED CAP</td> <td>4.000</td> <td>PC</td> </tr> <tr> <td>TB2821A0</td> <td>EPDM 6X10 L=40MM PIPE</td> <td>12.000</td> <td>PC</td> </tr> <tr> <td>TB3004A0</td> <td>TB2820A L=550mm EPDM BLACK PIPE</td> <td>2.000</td> <td>PC</td> </tr> <tr> <td>TB3009B0</td> <td>TB3132A-ONE OVEN WASHING INLET</td> <td>2.000</td> <td>PC</td> </tr> <tr> <td>TB3225B0</td> <td>TB2820A-TAN K-WASHYNG SYS CONNECTION</td> <td>2.000</td> <td>PC</td> </tr> <tr> <td>VH1220A1</td> <td>4,2x12 TCB SELF-TAPPIN G SCREW</td> <td>2.000</td> <td>PC</td> </tr> <tr> <td>VL1019A0</td> <td>VIBRATION DETERGENT PUMP</td> <td>2.000</td> <td>PC</td> </tr> <tr> <td>VL1047A1</td> <td>D6 PIPE HOLDER - D8 J.G. TERMINAL</td> <td>2.000</td> <td>PC</td> </tr> <tr> <td>VL1054B0</td> <td>ONE WASHING SYS INLET DISTRIBUTOR</td> <td>2.000</td> <td>PC</td> </tr> <tr> <td>VL1102A1</td> <td>DETERGENT LINE FILTER + BARBED VNR 6 MM</td> <td>2.000</td> <td>PC</td> </tr> <tr> <td>VL1127A1</td> <td>6mm BARBED T-SHAPED FITTING</td> <td>1.000</td> <td>PC</td> </tr> <tr> <td>VL1128A1</td> <td>D6 BARBED CHECK VALVE</td> <td>4.000</td> <td>PC</td> </tr> <tr> <td>VL1166A0</td> <td>BB6-AR6 L FITTING</td> <td>2.000</td> <td>PC</td> </tr> </tbody> </table>	Code	Description	Qty	UOM	EL1020A1	D8 INTERMEDIAT E T-SHAPED FITTING	1.000	PC	EL1440A0	WATER SELF CLEANING VALVE	2.000	PC	GN1526A0	INT. D.=6.9 TH=1.8 O-RIN	6.000	PC	RC1018A0	ZINC PLATED D12 ELASTIC CLAMP	2.000	PC	RC1019A0	D=10 ELASTIC CLAMP	28.000	PC	RC1130A0	130x2,6 CLAM	4.000	PC	RC1242A0	D=10 CLOSED CAP	4.000	PC	TB2821A0	EPDM 6X10 L=40MM PIPE	12.000	PC	TB3004A0	TB2820A L=550mm EPDM BLACK PIPE	2.000	PC	TB3009B0	TB3132A-ONE OVEN WASHING INLET	2.000	PC	TB3225B0	TB2820A-TAN K-WASHYNG SYS CONNECTION	2.000	PC	VH1220A1	4,2x12 TCB SELF-TAPPIN G SCREW	2.000	PC	VL1019A0	VIBRATION DETERGENT PUMP	2.000	PC	VL1047A1	D6 PIPE HOLDER - D8 J.G. TERMINAL	2.000	PC	VL1054B0	ONE WASHING SYS INLET DISTRIBUTOR	2.000	PC	VL1102A1	DETERGENT LINE FILTER + BARBED VNR 6 MM	2.000	PC	VL1127A1	6mm BARBED T-SHAPED FITTING	1.000	PC	VL1128A1	D6 BARBED CHECK VALVE	4.000	PC	VL1166A0	BB6-AR6 L FITTING	2.000	PC
Code	Description	Qty	UOM																																																																																		
EL1020A1	D8 INTERMEDIAT E T-SHAPED FITTING	1.000	PC																																																																																		
EL1440A0	WATER SELF CLEANING VALVE	2.000	PC																																																																																		
GN1526A0	INT. D.=6.9 TH=1.8 O-RIN	6.000	PC																																																																																		
RC1018A0	ZINC PLATED D12 ELASTIC CLAMP	2.000	PC																																																																																		
RC1019A0	D=10 ELASTIC CLAMP	28.000	PC																																																																																		
RC1130A0	130x2,6 CLAM	4.000	PC																																																																																		
RC1242A0	D=10 CLOSED CAP	4.000	PC																																																																																		
TB2821A0	EPDM 6X10 L=40MM PIPE	12.000	PC																																																																																		
TB3004A0	TB2820A L=550mm EPDM BLACK PIPE	2.000	PC																																																																																		
TB3009B0	TB3132A-ONE OVEN WASHING INLET	2.000	PC																																																																																		
TB3225B0	TB2820A-TAN K-WASHYNG SYS CONNECTION	2.000	PC																																																																																		
VH1220A1	4,2x12 TCB SELF-TAPPIN G SCREW	2.000	PC																																																																																		
VL1019A0	VIBRATION DETERGENT PUMP	2.000	PC																																																																																		
VL1047A1	D6 PIPE HOLDER - D8 J.G. TERMINAL	2.000	PC																																																																																		
VL1054B0	ONE WASHING SYS INLET DISTRIBUTOR	2.000	PC																																																																																		
VL1102A1	DETERGENT LINE FILTER + BARBED VNR 6 MM	2.000	PC																																																																																		
VL1127A1	6mm BARBED T-SHAPED FITTING	1.000	PC																																																																																		
VL1128A1	D6 BARBED CHECK VALVE	4.000	PC																																																																																		
VL1166A0	BB6-AR6 L FITTING	2.000	PC																																																																																		



COMPONENT			SPARE PART																																																															
Code	Description	Image	Code	Description	Kit components																																																													
VL1191A	ONE WASHING DISTRIBUTOR OUTLETS KIT		KVL2618A	2 ROTOR ARMS ONE CLEANING SYSTEM KIT	<table border="1"> <thead> <tr> <th>Code</th> <th>Description</th> <th>Qty</th> <th>UOM</th> </tr> </thead> <tbody> <tr> <td>VL1174C0</td> <td>D1.2 MM CALIBRATED D1.2 MM</td> <td>2.000</td> <td>PC</td> </tr> <tr> <td>VL1191A0</td> <td>ONE WASHING DISTRIBUTOR OUTLETS KIT</td> <td>2.000</td> <td>PC</td> </tr> <tr> <td>VL1214A0</td> <td>BAYONET - 6mm BARBED NRV VALVE</td> <td>2.000</td> <td>PC</td> </tr> <tr> <td>VM2172A0</td> <td>LOCKING CLIP FOR PUMP WITH CIRCUIT</td> <td>4.000</td> <td>PC</td> </tr> </tbody> </table>	Code	Description	Qty	UOM	VL1174C0	D1.2 MM CALIBRATED D1.2 MM	2.000	PC	VL1191A0	ONE WASHING DISTRIBUTOR OUTLETS KIT	2.000	PC	VL1214A0	BAYONET - 6mm BARBED NRV VALVE	2.000	PC	VM2172A0	LOCKING CLIP FOR PUMP WITH CIRCUIT	4.000	PC																																									
			Code	Description	Qty	UOM																																																												
VL1174C0	D1.2 MM CALIBRATED D1.2 MM	2.000	PC																																																															
VL1191A0	ONE WASHING DISTRIBUTOR OUTLETS KIT	2.000	PC																																																															
VL1214A0	BAYONET - 6mm BARBED NRV VALVE	2.000	PC																																																															
VM2172A0	LOCKING CLIP FOR PUMP WITH CIRCUIT	4.000	PC																																																															
KVL1225A	US HOOD WASHING SYSTEM KIT	<table border="1"> <thead> <tr> <th>Code</th> <th>Description</th> <th>Qty</th> <th>UOM</th> </tr> </thead> <tbody> <tr> <td>0H2213A1</td> <td>HOOD WATER CIRCUIT PLAT</td> <td>1.000</td> <td>PC</td> </tr> <tr> <td>EL1450A0</td> <td>US SELF-CLEANIN G WATER SOLENOID</td> <td>2.000</td> <td>PC</td> </tr> <tr> <td>GN1526A0</td> <td>INT. D.=6.9 TH=1.8 O-RIN</td> <td>5.000</td> <td>PC</td> </tr> <tr> <td>RC1018A0</td> <td>ZINC PLATED D12 ELASTIC CLAMP</td> <td>4.000</td> <td>PC</td> </tr> <tr> <td>RC1019A0</td> <td>D=10 ELASTIC CLAMP</td> <td>16.000</td> <td>PC</td> </tr> <tr> <td>RC1131A0</td> <td>200x2.6 BLACK CLAMP</td> <td>1.000</td> <td>PC</td> </tr> <tr> <td>RC1242A0</td> <td>D=10 CLOSED CAP</td> <td>2.000</td> <td>PC</td> </tr> <tr> <td>TB2821A0</td> <td>EPDM 6X10 L=40MM PIPE</td> <td>6.000</td> <td>PC</td> </tr> <tr> <td>TB2994A0</td> <td>HOOD DETERGENT PIPE</td> <td>2.000</td> <td>PC</td> </tr> <tr> <td>TB3252A0</td> <td></td> <td>2.000</td> <td>PC</td> </tr> <tr> <td>VI1220A1</td> <td>4,2x12 TCB SELF-TAPPIN G SCREW</td> <td>3.000</td> <td>PC</td> </tr> <tr> <td>VL1019A0</td> <td>VIBRATION DETERGENT PUMP</td> <td>1.000</td> <td>PC</td> </tr> <tr> <td>VL1047A1</td> <td>D6 PIPE HOLDER - D8 J.G. TERMINAL</td> <td>1.000</td> <td>PC</td> </tr> <tr> <td>VL1054B0</td> <td>ONE WASHING SYS INLET DISTRIBUTOR</td> <td>1.000</td> <td>PC</td> </tr> <tr> <td>VL1102A1</td> <td>DETERGENT LINE FILTER + BARBED VNR 6 MM</td> <td>1.000</td> <td>PC</td> </tr> </tbody> </table>	Code	Description	Qty	UOM	0H2213A1	HOOD WATER CIRCUIT PLAT	1.000	PC	EL1450A0	US SELF-CLEANIN G WATER SOLENOID	2.000	PC	GN1526A0	INT. D.=6.9 TH=1.8 O-RIN	5.000	PC	RC1018A0	ZINC PLATED D12 ELASTIC CLAMP	4.000	PC	RC1019A0	D=10 ELASTIC CLAMP	16.000	PC	RC1131A0	200x2.6 BLACK CLAMP	1.000	PC	RC1242A0	D=10 CLOSED CAP	2.000	PC	TB2821A0	EPDM 6X10 L=40MM PIPE	6.000	PC	TB2994A0	HOOD DETERGENT PIPE	2.000	PC	TB3252A0		2.000	PC	VI1220A1	4,2x12 TCB SELF-TAPPIN G SCREW	3.000	PC	VL1019A0	VIBRATION DETERGENT PUMP	1.000	PC	VL1047A1	D6 PIPE HOLDER - D8 J.G. TERMINAL	1.000	PC	VL1054B0	ONE WASHING SYS INLET DISTRIBUTOR	1.000	PC	VL1102A1	DETERGENT LINE FILTER + BARBED VNR 6 MM	1.000	PC
Code	Description	Qty	UOM																																																															
0H2213A1	HOOD WATER CIRCUIT PLAT	1.000	PC																																																															
EL1450A0	US SELF-CLEANIN G WATER SOLENOID	2.000	PC																																																															
GN1526A0	INT. D.=6.9 TH=1.8 O-RIN	5.000	PC																																																															
RC1018A0	ZINC PLATED D12 ELASTIC CLAMP	4.000	PC																																																															
RC1019A0	D=10 ELASTIC CLAMP	16.000	PC																																																															
RC1131A0	200x2.6 BLACK CLAMP	1.000	PC																																																															
RC1242A0	D=10 CLOSED CAP	2.000	PC																																																															
TB2821A0	EPDM 6X10 L=40MM PIPE	6.000	PC																																																															
TB2994A0	HOOD DETERGENT PIPE	2.000	PC																																																															
TB3252A0		2.000	PC																																																															
VI1220A1	4,2x12 TCB SELF-TAPPIN G SCREW	3.000	PC																																																															
VL1019A0	VIBRATION DETERGENT PUMP	1.000	PC																																																															
VL1047A1	D6 PIPE HOLDER - D8 J.G. TERMINAL	1.000	PC																																																															
VL1054B0	ONE WASHING SYS INLET DISTRIBUTOR	1.000	PC																																																															
VL1102A1	DETERGENT LINE FILTER + BARBED VNR 6 MM	1.000	PC																																																															

COMPONENT			SPARE PART																																										
Code	Description	Image	Code	Description	Kit components																																								
VL1191A	ONE WASHING DISTRIBUTOR OUTLETS KIT		KVL1225A	US HOOD WASHING SYSTEM KIT	<table border="1"> <thead> <tr> <th>Code</th> <th>Description</th> <th>Qty</th> <th>UOM</th> </tr> </thead> <tbody> <tr> <td>VL1127A1</td> <td>6mm BARBED T-SHAPED FITTING</td> <td>1.000</td> <td>PC</td> </tr> <tr> <td>VL1128A1</td> <td>D6 BARBED CHECK VALVE</td> <td>2.000</td> <td>PC</td> </tr> <tr> <td>VL1165A0</td> <td>BAM-BB6 STRAIGHT FITTING</td> <td>1.000</td> <td>PC</td> </tr> <tr> <td>VL1166A0</td> <td>BB6-AR6 L FITTING</td> <td>2.000</td> <td>PC</td> </tr> <tr> <td>VL1174C0</td> <td>D1.2 MM CALIBRATED D1.2 MM</td> <td>1.000</td> <td>PC</td> </tr> <tr> <td>VL1191A0</td> <td>ONE WASHING DISTRIBUTOR OUTLETS KIT</td> <td>1.000</td> <td>PC</td> </tr> <tr> <td>VL1214A0</td> <td>BAYONET - 6mm BARBED NRV VALVE</td> <td>1.000</td> <td>PC</td> </tr> <tr> <td>VM1605A0</td> <td>CLIP TWIST LOCK DIAM. 10,2-12,7 MM</td> <td>2.000</td> <td>PC</td> </tr> <tr> <td>VM2172A0</td> <td>LOCKING CLIP FOR PUMP WITH CIRCUIT</td> <td>3.000</td> <td>PC</td> </tr> </tbody> </table>	Code	Description	Qty	UOM	VL1127A1	6mm BARBED T-SHAPED FITTING	1.000	PC	VL1128A1	D6 BARBED CHECK VALVE	2.000	PC	VL1165A0	BAM-BB6 STRAIGHT FITTING	1.000	PC	VL1166A0	BB6-AR6 L FITTING	2.000	PC	VL1174C0	D1.2 MM CALIBRATED D1.2 MM	1.000	PC	VL1191A0	ONE WASHING DISTRIBUTOR OUTLETS KIT	1.000	PC	VL1214A0	BAYONET - 6mm BARBED NRV VALVE	1.000	PC	VM1605A0	CLIP TWIST LOCK DIAM. 10,2-12,7 MM	2.000	PC	VM2172A0	LOCKING CLIP FOR PUMP WITH CIRCUIT	3.000	PC
			Code	Description	Qty	UOM																																							
VL1127A1	6mm BARBED T-SHAPED FITTING	1.000	PC																																										
VL1128A1	D6 BARBED CHECK VALVE	2.000	PC																																										
VL1165A0	BAM-BB6 STRAIGHT FITTING	1.000	PC																																										
VL1166A0	BB6-AR6 L FITTING	2.000	PC																																										
VL1174C0	D1.2 MM CALIBRATED D1.2 MM	1.000	PC																																										
VL1191A0	ONE WASHING DISTRIBUTOR OUTLETS KIT	1.000	PC																																										
VL1214A0	BAYONET - 6mm BARBED NRV VALVE	1.000	PC																																										
VM1605A0	CLIP TWIST LOCK DIAM. 10,2-12,7 MM	2.000	PC																																										
VM2172A0	LOCKING CLIP FOR PUMP WITH CIRCUIT	3.000	PC																																										
KVL1222A	EUR 0311 ONE PLUS CLEANING SYSTEM KIT	<table border="1"> <thead> <tr> <th>Code</th> <th>Description</th> <th>Qty</th> <th>UOM</th> </tr> </thead> <tbody> <tr> <td>0H2486A0</td> <td>0311 WASHING CIRCUIT PLAT</td> <td>1.000</td> <td>PC</td> </tr> <tr> <td>EL1440A0</td> <td>WATER SELF CLEANING VALVE</td> <td>1.000</td> <td>PC</td> </tr> <tr> <td>GN1526A0</td> <td>INT. D.=6.9 TH=1.8 O-RIN</td> <td>3.000</td> <td>PC</td> </tr> <tr> <td>RC1018A0</td> <td>ZINC PLATED D12 ELASTIC CLAMP</td> <td>1.000</td> <td>PC</td> </tr> <tr> <td>RC1019A0</td> <td>D=10 ELASTIC CLAMP</td> <td>14.000</td> <td>PC</td> </tr> <tr> <td>RC1242A0</td> <td>D=10 CLOSED CAP</td> <td>2.000</td> <td>PC</td> </tr> <tr> <td>TB2821A0</td> <td>EPDM 6X10 L=40MM PIPE</td> <td>6.000</td> <td>PC</td> </tr> <tr> <td>TB3004A0</td> <td>TB2820A L=550mm EPDM BLACK PIPE</td> <td>1.000</td> <td>PC</td> </tr> <tr> <td>TB3009B0</td> <td>TB3132A-ONE OVEN WASHING INLET</td> <td>1.000</td> <td>PC</td> </tr> </tbody> </table>	Code	Description	Qty	UOM	0H2486A0	0311 WASHING CIRCUIT PLAT	1.000	PC	EL1440A0	WATER SELF CLEANING VALVE	1.000	PC	GN1526A0	INT. D.=6.9 TH=1.8 O-RIN	3.000	PC	RC1018A0	ZINC PLATED D12 ELASTIC CLAMP	1.000	PC	RC1019A0	D=10 ELASTIC CLAMP	14.000	PC	RC1242A0	D=10 CLOSED CAP	2.000	PC	TB2821A0	EPDM 6X10 L=40MM PIPE	6.000	PC	TB3004A0	TB2820A L=550mm EPDM BLACK PIPE	1.000	PC	TB3009B0	TB3132A-ONE OVEN WASHING INLET	1.000	PC			
Code	Description	Qty	UOM																																										
0H2486A0	0311 WASHING CIRCUIT PLAT	1.000	PC																																										
EL1440A0	WATER SELF CLEANING VALVE	1.000	PC																																										
GN1526A0	INT. D.=6.9 TH=1.8 O-RIN	3.000	PC																																										
RC1018A0	ZINC PLATED D12 ELASTIC CLAMP	1.000	PC																																										
RC1019A0	D=10 ELASTIC CLAMP	14.000	PC																																										
RC1242A0	D=10 CLOSED CAP	2.000	PC																																										
TB2821A0	EPDM 6X10 L=40MM PIPE	6.000	PC																																										
TB3004A0	TB2820A L=550mm EPDM BLACK PIPE	1.000	PC																																										
TB3009B0	TB3132A-ONE OVEN WASHING INLET	1.000	PC																																										



COMPONENT			SPARE PART																																																																																	
Code	Description	Image	Code	Description	Kit components																																																																															
VL1191A	ONE WASHING DISTRIBUTOR OUTLETS KIT		KVL1222A	EUR 0311 ONE PLUS CLEANING SYSTEM KIT	<table border="1"> <thead> <tr> <th>Code</th> <th>Description</th> <th>Qty</th> <th>UOM</th> </tr> </thead> <tbody> <tr> <td>TB3225B0</td> <td>TB2820A-TAN K-WASHYNG SYS CONNECTION</td> <td>1.000</td> <td>PC</td> </tr> <tr> <td>V11220A1</td> <td>4,2x12 TCB SELF-TAPPIN G SCREW</td> <td>4.000</td> <td>PC</td> </tr> <tr> <td>VL1019A0</td> <td>VIBRATION DETERGENT PUMP</td> <td>1.000</td> <td>PC</td> </tr> <tr> <td>VL1047A1</td> <td>D6 PIPE HOLDER - D8 J.G. TERMINAL</td> <td>1.000</td> <td>PC</td> </tr> <tr> <td>VL1054B0</td> <td>ONE WASHING SYS INLET DISTRIBUTOR</td> <td>1.000</td> <td>PC</td> </tr> <tr> <td>VL1102A1</td> <td>DETERGENT LINE FILTER + BARBED VNR 6 MM</td> <td>1.000</td> <td>PC</td> </tr> <tr> <td>VL1128A1</td> <td>D6 BARBED CHECK VALVE</td> <td>2.000</td> <td>PC</td> </tr> <tr> <td>VL1166A0</td> <td>BB6-AR6 L FITTING</td> <td>1.000</td> <td>PC</td> </tr> <tr> <td>VL1174C0</td> <td>D1.2 MM CALIBRATED D1.2 MM</td> <td>1.000</td> <td>PC</td> </tr> <tr> <td>VL1191A0</td> <td>ONE WASHING DISTRIBUTOR OUTLETS KIT</td> <td>1.000</td> <td>PC</td> </tr> <tr> <td>VL1214A0</td> <td>BAYONET - 6mm BARBED NRV VALVE</td> <td>1.000</td> <td>PC</td> </tr> <tr> <td>VM2172A0</td> <td>LOCKING CLIP FOR PUMP WITH CIRCUIT</td> <td>2.000</td> <td>PC</td> </tr> </tbody> </table>	Code	Description	Qty	UOM	TB3225B0	TB2820A-TAN K-WASHYNG SYS CONNECTION	1.000	PC	V11220A1	4,2x12 TCB SELF-TAPPIN G SCREW	4.000	PC	VL1019A0	VIBRATION DETERGENT PUMP	1.000	PC	VL1047A1	D6 PIPE HOLDER - D8 J.G. TERMINAL	1.000	PC	VL1054B0	ONE WASHING SYS INLET DISTRIBUTOR	1.000	PC	VL1102A1	DETERGENT LINE FILTER + BARBED VNR 6 MM	1.000	PC	VL1128A1	D6 BARBED CHECK VALVE	2.000	PC	VL1166A0	BB6-AR6 L FITTING	1.000	PC	VL1174C0	D1.2 MM CALIBRATED D1.2 MM	1.000	PC	VL1191A0	ONE WASHING DISTRIBUTOR OUTLETS KIT	1.000	PC	VL1214A0	BAYONET - 6mm BARBED NRV VALVE	1.000	PC	VM2172A0	LOCKING CLIP FOR PUMP WITH CIRCUIT	2.000	PC	KVL1211A	ONE COMPACT AND 0523-EP WASH. SYSTEM KIT	<table border="1"> <thead> <tr> <th>Code</th> <th>Description</th> <th>Qty</th> <th>UOM</th> </tr> </thead> <tbody> <tr> <td>0H2427A0</td> <td>XECC WASHING CIRCUIT HOLDING PLATE</td> <td>1.000</td> <td>PC</td> </tr> <tr> <td>EL1440A0</td> <td>WATER SELF CLEANING VALVE</td> <td>1.000</td> <td>PC</td> </tr> <tr> <td>GN1526A0</td> <td>INT. D.=6.9 TH=1.8 O-RIN</td> <td>3.000</td> <td>PC</td> </tr> <tr> <td>RC1018A0</td> <td>ZINC PLATED D12 ELASTIC CLAMP</td> <td>1.000</td> <td>PC</td> </tr> <tr> <td>RC1019A0</td> <td>D=10 ELASTIC CLAMP</td> <td>14.000</td> <td>PC</td> </tr> </tbody> </table>	Code	Description	Qty	UOM	0H2427A0	XECC WASHING CIRCUIT HOLDING PLATE	1.000	PC	EL1440A0	WATER SELF CLEANING VALVE	1.000	PC	GN1526A0	INT. D.=6.9 TH=1.8 O-RIN	3.000	PC	RC1018A0	ZINC PLATED D12 ELASTIC CLAMP	1.000	PC	RC1019A0	D=10 ELASTIC CLAMP	14.000	PC
			Code	Description	Qty	UOM																																																																														
TB3225B0	TB2820A-TAN K-WASHYNG SYS CONNECTION	1.000	PC																																																																																	
V11220A1	4,2x12 TCB SELF-TAPPIN G SCREW	4.000	PC																																																																																	
VL1019A0	VIBRATION DETERGENT PUMP	1.000	PC																																																																																	
VL1047A1	D6 PIPE HOLDER - D8 J.G. TERMINAL	1.000	PC																																																																																	
VL1054B0	ONE WASHING SYS INLET DISTRIBUTOR	1.000	PC																																																																																	
VL1102A1	DETERGENT LINE FILTER + BARBED VNR 6 MM	1.000	PC																																																																																	
VL1128A1	D6 BARBED CHECK VALVE	2.000	PC																																																																																	
VL1166A0	BB6-AR6 L FITTING	1.000	PC																																																																																	
VL1174C0	D1.2 MM CALIBRATED D1.2 MM	1.000	PC																																																																																	
VL1191A0	ONE WASHING DISTRIBUTOR OUTLETS KIT	1.000	PC																																																																																	
VL1214A0	BAYONET - 6mm BARBED NRV VALVE	1.000	PC																																																																																	
VM2172A0	LOCKING CLIP FOR PUMP WITH CIRCUIT	2.000	PC																																																																																	
Code	Description	Qty	UOM																																																																																	
0H2427A0	XECC WASHING CIRCUIT HOLDING PLATE	1.000	PC																																																																																	
EL1440A0	WATER SELF CLEANING VALVE	1.000	PC																																																																																	
GN1526A0	INT. D.=6.9 TH=1.8 O-RIN	3.000	PC																																																																																	
RC1018A0	ZINC PLATED D12 ELASTIC CLAMP	1.000	PC																																																																																	
RC1019A0	D=10 ELASTIC CLAMP	14.000	PC																																																																																	



COMPONENT			SPARE PART																																																																																									
Code	Description	Image	Code	Description	Kit components																																																																																							
VL1191A	ONE WASHING DISTRIBUTOR OUTLETS KIT		KVL1211A	ONE COMPACT AND 0523-EP WASH. SYSTEM KIT	<table border="1"> <thead> <tr> <th>Code</th> <th>Description</th> <th>Qty</th> <th>UOM</th> </tr> </thead> <tbody> <tr> <td>RC1130A0</td> <td>130x2,6 CLAM</td> <td>1.000</td> <td>PC</td> </tr> <tr> <td>RC1242A0</td> <td>D=10 CLOSED CAP</td> <td>2.000</td> <td>PC</td> </tr> <tr> <td>TB1402A0</td> <td>TB2820A-DETE R GENT CIRCUIT-FILTE R PIPE</td> <td>1.000</td> <td>PC</td> </tr> <tr> <td>TB2821A0</td> <td>EPDM 6X10 L=40MM PIPE</td> <td>6.000</td> <td>PC</td> </tr> <tr> <td>TB3004A0</td> <td>TB2820A L=550mm EPDM BLACK PIPE</td> <td>1.000</td> <td>PC</td> </tr> <tr> <td>TB3469A0</td> <td></td> <td>1.000</td> <td>PC</td> </tr> <tr> <td>VI1220A1</td> <td>4,2x12 TCB SELF-TAPPIN G SCREW</td> <td>4.000</td> <td>PC</td> </tr> <tr> <td>VL1019A0</td> <td>VIBRATION DETERGENT PUMP</td> <td>1.000</td> <td>PC</td> </tr> <tr> <td>VL1047A1</td> <td>D6 PIPE HOLDER - D6 J.G. TERMINAL</td> <td>1.000</td> <td>PC</td> </tr> <tr> <td>VL1054B0</td> <td>ONE WASHING SYS INLET DISTRIBUTOR</td> <td>1.000</td> <td>PC</td> </tr> <tr> <td>VL1102A1</td> <td>DETERGENT LINE FILTER + BARBED VNR 6 MM</td> <td>1.000</td> <td>PC</td> </tr> <tr> <td>VL1128A1</td> <td>D6 BARBED CHECK VALVE</td> <td>2.000</td> <td>PC</td> </tr> <tr> <td>VL1165A0</td> <td>BAM-BB6 STRAIGHT FITTING</td> <td>1.000</td> <td>PC</td> </tr> <tr> <td>VL1166A0</td> <td>BB6-AR6 L FITTING</td> <td>1.000</td> <td>PC</td> </tr> <tr> <td>VL1174C0</td> <td>D1.2 MM CALIBRATED D1.2 MM</td> <td>1.000</td> <td>PC</td> </tr> <tr> <td>VL1191A0</td> <td>ONE WASHING DISTRIBUTOR OUTLETS KIT</td> <td>1.000</td> <td>PC</td> </tr> <tr> <td>VM2172A0</td> <td>LOCKING CLIP FOR PUMP WITH CIRCUIT</td> <td>2.000</td> <td>PC</td> </tr> </tbody> </table>	Code	Description	Qty	UOM	RC1130A0	130x2,6 CLAM	1.000	PC	RC1242A0	D=10 CLOSED CAP	2.000	PC	TB1402A0	TB2820A-DETE R GENT CIRCUIT-FILTE R PIPE	1.000	PC	TB2821A0	EPDM 6X10 L=40MM PIPE	6.000	PC	TB3004A0	TB2820A L=550mm EPDM BLACK PIPE	1.000	PC	TB3469A0		1.000	PC	VI1220A1	4,2x12 TCB SELF-TAPPIN G SCREW	4.000	PC	VL1019A0	VIBRATION DETERGENT PUMP	1.000	PC	VL1047A1	D6 PIPE HOLDER - D6 J.G. TERMINAL	1.000	PC	VL1054B0	ONE WASHING SYS INLET DISTRIBUTOR	1.000	PC	VL1102A1	DETERGENT LINE FILTER + BARBED VNR 6 MM	1.000	PC	VL1128A1	D6 BARBED CHECK VALVE	2.000	PC	VL1165A0	BAM-BB6 STRAIGHT FITTING	1.000	PC	VL1166A0	BB6-AR6 L FITTING	1.000	PC	VL1174C0	D1.2 MM CALIBRATED D1.2 MM	1.000	PC	VL1191A0	ONE WASHING DISTRIBUTOR OUTLETS KIT	1.000	PC	VM2172A0	LOCKING CLIP FOR PUMP WITH CIRCUIT	2.000	PC	KVL1198A	MM EU HOOD CLEANING SYSTEM KIT	<table border="1"> <thead> <tr> <th>Code</th> <th>Description</th> <th>Qty</th> <th>UOM</th> </tr> </thead> <tbody> <tr> <td>0H2213A1</td> <td>HOOD WATER CIRCUIT PLAT</td> <td>1.000</td> <td>PC</td> </tr> <tr> <td>EL1440A0</td> <td>WATER SELF CLEANING VALVE</td> <td>2.000</td> <td>PC</td> </tr> </tbody> </table>	Code	Description	Qty	UOM	0H2213A1	HOOD WATER CIRCUIT PLAT	1.000	PC	EL1440A0	WATER SELF CLEANING VALVE	2.000	PC
			Code	Description	Qty	UOM																																																																																						
RC1130A0	130x2,6 CLAM	1.000	PC																																																																																									
RC1242A0	D=10 CLOSED CAP	2.000	PC																																																																																									
TB1402A0	TB2820A-DETE R GENT CIRCUIT-FILTE R PIPE	1.000	PC																																																																																									
TB2821A0	EPDM 6X10 L=40MM PIPE	6.000	PC																																																																																									
TB3004A0	TB2820A L=550mm EPDM BLACK PIPE	1.000	PC																																																																																									
TB3469A0		1.000	PC																																																																																									
VI1220A1	4,2x12 TCB SELF-TAPPIN G SCREW	4.000	PC																																																																																									
VL1019A0	VIBRATION DETERGENT PUMP	1.000	PC																																																																																									
VL1047A1	D6 PIPE HOLDER - D6 J.G. TERMINAL	1.000	PC																																																																																									
VL1054B0	ONE WASHING SYS INLET DISTRIBUTOR	1.000	PC																																																																																									
VL1102A1	DETERGENT LINE FILTER + BARBED VNR 6 MM	1.000	PC																																																																																									
VL1128A1	D6 BARBED CHECK VALVE	2.000	PC																																																																																									
VL1165A0	BAM-BB6 STRAIGHT FITTING	1.000	PC																																																																																									
VL1166A0	BB6-AR6 L FITTING	1.000	PC																																																																																									
VL1174C0	D1.2 MM CALIBRATED D1.2 MM	1.000	PC																																																																																									
VL1191A0	ONE WASHING DISTRIBUTOR OUTLETS KIT	1.000	PC																																																																																									
VM2172A0	LOCKING CLIP FOR PUMP WITH CIRCUIT	2.000	PC																																																																																									
Code	Description	Qty	UOM																																																																																									
0H2213A1	HOOD WATER CIRCUIT PLAT	1.000	PC																																																																																									
EL1440A0	WATER SELF CLEANING VALVE	2.000	PC																																																																																									



COMPONENT			SPARE PART																																																																																						
Code	Description	Image	Code	Description	Kit components																																																																																				
VL1191A	ONE WASHING DISTRIBUTOR OUTLETS KIT		KVL1198A	MM EU HOOD CLEANING SYSTEM KIT	<table border="1"> <thead> <tr> <th>Code</th> <th>Description</th> <th>Qty</th> <th>UOM</th> </tr> </thead> <tbody> <tr> <td>GN1526A0</td> <td>INT. D.=6.9 TH=1.8 O-RING</td> <td>5.000</td> <td>PC</td> </tr> <tr> <td>RC1018A0</td> <td>ZINC PLATED D12 ELASTIC CLAMP</td> <td>4.000</td> <td>PC</td> </tr> <tr> <td>RC1019A0</td> <td>D=10 ELASTIC CLAMP</td> <td>16.000</td> <td>PC</td> </tr> <tr> <td>RC1131A0</td> <td>200x2.6 BLACK CLAMP</td> <td>1.000</td> <td>PC</td> </tr> <tr> <td>RC1242A0</td> <td>D=10 CLOSED CAP</td> <td>2.000</td> <td>PC</td> </tr> <tr> <td>TB2821A0</td> <td>EPDM 6X10 L=40MM PIPE</td> <td>6.000</td> <td>PC</td> </tr> <tr> <td>TB2994A0</td> <td>HOOD DETERGENT PIPE</td> <td>2.000</td> <td>PC</td> </tr> <tr> <td>TB3252A0</td> <td></td> <td>2.000</td> <td>PC</td> </tr> <tr> <td>VI1220A1</td> <td>4,2x12 TCB SELF-TAPPING SCREW</td> <td>3.000</td> <td>PC</td> </tr> <tr> <td>VL1019A0</td> <td>VIBRATION DETERGENT PUMP</td> <td>1.000</td> <td>PC</td> </tr> <tr> <td>VL1047A1</td> <td>D6 PIPE HOLDER - D8 J.G. TERMINAL</td> <td>2.000</td> <td>PC</td> </tr> <tr> <td>VL1054B0</td> <td>ONE WASHING SYS INLET DISTRIBUTOR</td> <td>1.000</td> <td>PC</td> </tr> <tr> <td>VL1102A1</td> <td>DETERGENT LINE FILTER + BARBED VNR 6 MM</td> <td>1.000</td> <td>PC</td> </tr> <tr> <td>VL1127A1</td> <td>6mm BARBED T-SHAPED FITTING</td> <td>1.000</td> <td>PC</td> </tr> <tr> <td>VL1128A1</td> <td>D6 BARBED CHECK VALVE</td> <td>2.000</td> <td>PC</td> </tr> <tr> <td>VL1165A0</td> <td>BAM-BB6 STRAIGHT FITTING</td> <td>1.000</td> <td>PC</td> </tr> <tr> <td>VL1166A0</td> <td>BB6-AR6 L FITTING</td> <td>2.000</td> <td>PC</td> </tr> <tr> <td>VL1174C0</td> <td>D1.2 MM CALIBRATED D1.2 MM</td> <td>1.000</td> <td>PC</td> </tr> <tr> <td>VL1191A0</td> <td>ONE WASHING DISTRIBUTOR OUTLETS KIT</td> <td>1.000</td> <td>PC</td> </tr> <tr> <td>VL1214A0</td> <td>BAYONET - 6mm BARBED NRV VALVE</td> <td>1.000</td> <td>PC</td> </tr> </tbody> </table>	Code	Description	Qty	UOM	GN1526A0	INT. D.=6.9 TH=1.8 O-RING	5.000	PC	RC1018A0	ZINC PLATED D12 ELASTIC CLAMP	4.000	PC	RC1019A0	D=10 ELASTIC CLAMP	16.000	PC	RC1131A0	200x2.6 BLACK CLAMP	1.000	PC	RC1242A0	D=10 CLOSED CAP	2.000	PC	TB2821A0	EPDM 6X10 L=40MM PIPE	6.000	PC	TB2994A0	HOOD DETERGENT PIPE	2.000	PC	TB3252A0		2.000	PC	VI1220A1	4,2x12 TCB SELF-TAPPING SCREW	3.000	PC	VL1019A0	VIBRATION DETERGENT PUMP	1.000	PC	VL1047A1	D6 PIPE HOLDER - D8 J.G. TERMINAL	2.000	PC	VL1054B0	ONE WASHING SYS INLET DISTRIBUTOR	1.000	PC	VL1102A1	DETERGENT LINE FILTER + BARBED VNR 6 MM	1.000	PC	VL1127A1	6mm BARBED T-SHAPED FITTING	1.000	PC	VL1128A1	D6 BARBED CHECK VALVE	2.000	PC	VL1165A0	BAM-BB6 STRAIGHT FITTING	1.000	PC	VL1166A0	BB6-AR6 L FITTING	2.000	PC	VL1174C0	D1.2 MM CALIBRATED D1.2 MM	1.000	PC	VL1191A0	ONE WASHING DISTRIBUTOR OUTLETS KIT	1.000	PC	VL1214A0	BAYONET - 6mm BARBED NRV VALVE	1.000	PC
Code	Description	Qty	UOM																																																																																						
GN1526A0	INT. D.=6.9 TH=1.8 O-RING	5.000	PC																																																																																						
RC1018A0	ZINC PLATED D12 ELASTIC CLAMP	4.000	PC																																																																																						
RC1019A0	D=10 ELASTIC CLAMP	16.000	PC																																																																																						
RC1131A0	200x2.6 BLACK CLAMP	1.000	PC																																																																																						
RC1242A0	D=10 CLOSED CAP	2.000	PC																																																																																						
TB2821A0	EPDM 6X10 L=40MM PIPE	6.000	PC																																																																																						
TB2994A0	HOOD DETERGENT PIPE	2.000	PC																																																																																						
TB3252A0		2.000	PC																																																																																						
VI1220A1	4,2x12 TCB SELF-TAPPING SCREW	3.000	PC																																																																																						
VL1019A0	VIBRATION DETERGENT PUMP	1.000	PC																																																																																						
VL1047A1	D6 PIPE HOLDER - D8 J.G. TERMINAL	2.000	PC																																																																																						
VL1054B0	ONE WASHING SYS INLET DISTRIBUTOR	1.000	PC																																																																																						
VL1102A1	DETERGENT LINE FILTER + BARBED VNR 6 MM	1.000	PC																																																																																						
VL1127A1	6mm BARBED T-SHAPED FITTING	1.000	PC																																																																																						
VL1128A1	D6 BARBED CHECK VALVE	2.000	PC																																																																																						
VL1165A0	BAM-BB6 STRAIGHT FITTING	1.000	PC																																																																																						
VL1166A0	BB6-AR6 L FITTING	2.000	PC																																																																																						
VL1174C0	D1.2 MM CALIBRATED D1.2 MM	1.000	PC																																																																																						
VL1191A0	ONE WASHING DISTRIBUTOR OUTLETS KIT	1.000	PC																																																																																						
VL1214A0	BAYONET - 6mm BARBED NRV VALVE	1.000	PC																																																																																						



COMPONENT			SPARE PART																																																															
Code	Description	Image	Code	Description	Kit components																																																													
VL1191A	ONE WASHING DISTRIBUTOR OUTLETS KIT		KVL1198A	MM EU HOOD CLEANING SYSTEM KIT	<table border="1"> <thead> <tr> <th>Code</th> <th>Description</th> <th>Qty</th> <th>UOM</th> </tr> </thead> <tbody> <tr> <td>VM1605A0</td> <td>CLIP TWIST LOCK DIAM. 10,2-12,7 MM</td> <td>2.000</td> <td>PC</td> </tr> <tr> <td>VM2172A0</td> <td>LOCKING CLIP FOR PUMP WITH CIRCUIT</td> <td>5.000</td> <td>PC</td> </tr> </tbody> </table>	Code	Description	Qty	UOM	VM1605A0	CLIP TWIST LOCK DIAM. 10,2-12,7 MM	2.000	PC	VM2172A0	LOCKING CLIP FOR PUMP WITH CIRCUIT	5.000	PC																																																	
			Code	Description	Qty	UOM																																																												
VM1605A0	CLIP TWIST LOCK DIAM. 10,2-12,7 MM	2.000	PC																																																															
VM2172A0	LOCKING CLIP FOR PUMP WITH CIRCUIT	5.000	PC																																																															
KVL1182A	ONE 1ROT CLEANING SYSTEM KIT (0311 EXC.)	<table border="1"> <thead> <tr> <th>Code</th> <th>Description</th> <th>Qty</th> <th>UOM</th> </tr> </thead> <tbody> <tr> <td>0H2202A1</td> <td>ONE WASHING WITH STEAM VALVE SUPPORT</td> <td>1.000</td> <td>PC</td> </tr> <tr> <td>EL1440A0</td> <td>WATER SELF CLEANING VALVE</td> <td>1.000</td> <td>PC</td> </tr> <tr> <td>GN1526A0</td> <td>INT. D.=6.9 TH=1.8 O-RIN</td> <td>3.000</td> <td>PC</td> </tr> <tr> <td>RC1018A0</td> <td>ZINC PLATED D12 ELASTIC CLAMP</td> <td>1.000</td> <td>PC</td> </tr> <tr> <td>RC1019A0</td> <td>D=10 ELASTIC CLAMP</td> <td>14.000</td> <td>PC</td> </tr> <tr> <td>RC1130A0</td> <td>130x2,6 CLAM</td> <td>2.000</td> <td>PC</td> </tr> <tr> <td>RC1242A0</td> <td>D=10 CLOSED CAP</td> <td>2.000</td> <td>PC</td> </tr> <tr> <td>TB2821A0</td> <td>EPDM 6X10 L=40MM PIPE</td> <td>6.000</td> <td>PC</td> </tr> <tr> <td>TB3004A0</td> <td>TB2820A L=550mm EPDM BLACK PIPE</td> <td>1.000</td> <td>PC</td> </tr> <tr> <td>TB3009B0</td> <td>TB3132A-ONE OVEN WASHING INLET</td> <td>1.000</td> <td>PC</td> </tr> <tr> <td>TB3225B0</td> <td>TB2820A-TAN K-WASHYNG SYS CONNECTION</td> <td>1.000</td> <td>PC</td> </tr> <tr> <td>V11220A1</td> <td>4,2x12 TCB SELF-TAPPIN G SCREW</td> <td>1.000</td> <td>PC</td> </tr> <tr> <td>VL1019A0</td> <td>VIBRATION DETERGENT PUMP</td> <td>1.000</td> <td>PC</td> </tr> <tr> <td>VL1047A1</td> <td>D6 PIPE HOLDER - D8 J.G. TERMINAL</td> <td>1.000</td> <td>PC</td> </tr> <tr> <td>VL1054B0</td> <td>ONE WASHING SYS INLET DISTRIBUTOR</td> <td>1.000</td> <td>PC</td> </tr> </tbody> </table>	Code	Description	Qty	UOM	0H2202A1	ONE WASHING WITH STEAM VALVE SUPPORT	1.000	PC	EL1440A0	WATER SELF CLEANING VALVE	1.000	PC	GN1526A0	INT. D.=6.9 TH=1.8 O-RIN	3.000	PC	RC1018A0	ZINC PLATED D12 ELASTIC CLAMP	1.000	PC	RC1019A0	D=10 ELASTIC CLAMP	14.000	PC	RC1130A0	130x2,6 CLAM	2.000	PC	RC1242A0	D=10 CLOSED CAP	2.000	PC	TB2821A0	EPDM 6X10 L=40MM PIPE	6.000	PC	TB3004A0	TB2820A L=550mm EPDM BLACK PIPE	1.000	PC	TB3009B0	TB3132A-ONE OVEN WASHING INLET	1.000	PC	TB3225B0	TB2820A-TAN K-WASHYNG SYS CONNECTION	1.000	PC	V11220A1	4,2x12 TCB SELF-TAPPIN G SCREW	1.000	PC	VL1019A0	VIBRATION DETERGENT PUMP	1.000	PC	VL1047A1	D6 PIPE HOLDER - D8 J.G. TERMINAL	1.000	PC	VL1054B0	ONE WASHING SYS INLET DISTRIBUTOR	1.000	PC
Code	Description	Qty	UOM																																																															
0H2202A1	ONE WASHING WITH STEAM VALVE SUPPORT	1.000	PC																																																															
EL1440A0	WATER SELF CLEANING VALVE	1.000	PC																																																															
GN1526A0	INT. D.=6.9 TH=1.8 O-RIN	3.000	PC																																																															
RC1018A0	ZINC PLATED D12 ELASTIC CLAMP	1.000	PC																																																															
RC1019A0	D=10 ELASTIC CLAMP	14.000	PC																																																															
RC1130A0	130x2,6 CLAM	2.000	PC																																																															
RC1242A0	D=10 CLOSED CAP	2.000	PC																																																															
TB2821A0	EPDM 6X10 L=40MM PIPE	6.000	PC																																																															
TB3004A0	TB2820A L=550mm EPDM BLACK PIPE	1.000	PC																																																															
TB3009B0	TB3132A-ONE OVEN WASHING INLET	1.000	PC																																																															
TB3225B0	TB2820A-TAN K-WASHYNG SYS CONNECTION	1.000	PC																																																															
V11220A1	4,2x12 TCB SELF-TAPPIN G SCREW	1.000	PC																																																															
VL1019A0	VIBRATION DETERGENT PUMP	1.000	PC																																																															
VL1047A1	D6 PIPE HOLDER - D8 J.G. TERMINAL	1.000	PC																																																															
VL1054B0	ONE WASHING SYS INLET DISTRIBUTOR	1.000	PC																																																															



COMPONENT			SPARE PART																																														
Code	Description	Image	Code	Description	Kit components																																												
VL1191A	ONE WASHING DISTRIBUTOR OUTLETS KIT		KVL1182A	ONE 1ROT CLEANING SYSTEM KIT (0311 EXC.)	<table border="1"> <thead> <tr> <th>Code</th> <th>Description</th> <th>Qty</th> <th>UOM</th> </tr> </thead> <tbody> <tr> <td>VL1102A1</td> <td>DETERGENT LINE FILTER + BARBED VNR 6 MM</td> <td>1.000</td> <td>PC</td> </tr> <tr> <td>VL1128A1</td> <td>D6 BARBED CHECK VALVE</td> <td>2.000</td> <td>PC</td> </tr> <tr> <td>VL1166A0</td> <td>BB6-AR6 L FITTING</td> <td>1.000</td> <td>PC</td> </tr> <tr> <td>VL1174C0</td> <td>D1.2 MM CALIBRATED D1.2 MM</td> <td>1.000</td> <td>PC</td> </tr> <tr> <td>VL1191A0</td> <td>ONE WASHING DISTRIBUTOR OUTLETS KIT</td> <td>1.000</td> <td>PC</td> </tr> <tr> <td>VL1214A0</td> <td>BAYONET - 6mm BARBED NRV VALVE</td> <td>1.000</td> <td>PC</td> </tr> <tr> <td>VM2172A0</td> <td>LOCKING CLIP FOR PUMP WITH CIRCUIT</td> <td>2.000</td> <td>PC</td> </tr> </tbody> </table>	Code	Description	Qty	UOM	VL1102A1	DETERGENT LINE FILTER + BARBED VNR 6 MM	1.000	PC	VL1128A1	D6 BARBED CHECK VALVE	2.000	PC	VL1166A0	BB6-AR6 L FITTING	1.000	PC	VL1174C0	D1.2 MM CALIBRATED D1.2 MM	1.000	PC	VL1191A0	ONE WASHING DISTRIBUTOR OUTLETS KIT	1.000	PC	VL1214A0	BAYONET - 6mm BARBED NRV VALVE	1.000	PC	VM2172A0	LOCKING CLIP FOR PUMP WITH CIRCUIT	2.000	PC												
Code	Description	Qty	UOM																																														
VL1102A1	DETERGENT LINE FILTER + BARBED VNR 6 MM	1.000	PC																																														
VL1128A1	D6 BARBED CHECK VALVE	2.000	PC																																														
VL1166A0	BB6-AR6 L FITTING	1.000	PC																																														
VL1174C0	D1.2 MM CALIBRATED D1.2 MM	1.000	PC																																														
VL1191A0	ONE WASHING DISTRIBUTOR OUTLETS KIT	1.000	PC																																														
VL1214A0	BAYONET - 6mm BARBED NRV VALVE	1.000	PC																																														
VM2172A0	LOCKING CLIP FOR PUMP WITH CIRCUIT	2.000	PC																																														
			KVL0682A	>12/2019 ONE/HOODS WASHING SYST PUMP KIT	<table border="1"> <thead> <tr> <th>Code</th> <th>Description</th> <th>Qty</th> <th>UOM</th> </tr> </thead> <tbody> <tr> <td>GN1526A0</td> <td>INT. D.=6.9 TH=1.8 O-RIN</td> <td>1.000</td> <td>PC</td> </tr> <tr> <td>RC1019A0</td> <td>D=10 ELASTIC CLAMP</td> <td>6.000</td> <td>PC</td> </tr> <tr> <td>RC1242A0</td> <td>D=10 CLOSED CAP</td> <td>2.000</td> <td>PC</td> </tr> <tr> <td>TB2821A0</td> <td>EPDM 6X10 L=40MM PIPE</td> <td>3.000</td> <td>PC</td> </tr> <tr> <td>VL1019A0</td> <td>VIBRATION DETERGENT PUMP</td> <td>1.000</td> <td>PC</td> </tr> <tr> <td>VL1054B0</td> <td>ONE WASHING SYS INLET DISTRIBUTOR</td> <td>1.000</td> <td>PC</td> </tr> <tr> <td>VL1128A1</td> <td>D6 BARBED CHECK VALVE</td> <td>1.000</td> <td>PC</td> </tr> <tr> <td>VL1174C0</td> <td>D1.2 MM CALIBRATED D1.2 MM</td> <td>1.000</td> <td>PC</td> </tr> <tr> <td>VL1191A0</td> <td>ONE WASHING DISTRIBUTOR OUTLETS KIT</td> <td>1.000</td> <td>PC</td> </tr> <tr> <td>VM2172A0</td> <td>LOCKING CLIP FOR PUMP WITH CIRCUIT</td> <td>1.000</td> <td>PC</td> </tr> </tbody> </table>	Code	Description	Qty	UOM	GN1526A0	INT. D.=6.9 TH=1.8 O-RIN	1.000	PC	RC1019A0	D=10 ELASTIC CLAMP	6.000	PC	RC1242A0	D=10 CLOSED CAP	2.000	PC	TB2821A0	EPDM 6X10 L=40MM PIPE	3.000	PC	VL1019A0	VIBRATION DETERGENT PUMP	1.000	PC	VL1054B0	ONE WASHING SYS INLET DISTRIBUTOR	1.000	PC	VL1128A1	D6 BARBED CHECK VALVE	1.000	PC	VL1174C0	D1.2 MM CALIBRATED D1.2 MM	1.000	PC	VL1191A0	ONE WASHING DISTRIBUTOR OUTLETS KIT	1.000	PC	VM2172A0	LOCKING CLIP FOR PUMP WITH CIRCUIT	1.000	PC
Code	Description	Qty	UOM																																														
GN1526A0	INT. D.=6.9 TH=1.8 O-RIN	1.000	PC																																														
RC1019A0	D=10 ELASTIC CLAMP	6.000	PC																																														
RC1242A0	D=10 CLOSED CAP	2.000	PC																																														
TB2821A0	EPDM 6X10 L=40MM PIPE	3.000	PC																																														
VL1019A0	VIBRATION DETERGENT PUMP	1.000	PC																																														
VL1054B0	ONE WASHING SYS INLET DISTRIBUTOR	1.000	PC																																														
VL1128A1	D6 BARBED CHECK VALVE	1.000	PC																																														
VL1174C0	D1.2 MM CALIBRATED D1.2 MM	1.000	PC																																														
VL1191A0	ONE WASHING DISTRIBUTOR OUTLETS KIT	1.000	PC																																														
VM2172A0	LOCKING CLIP FOR PUMP WITH CIRCUIT	1.000	PC																																														

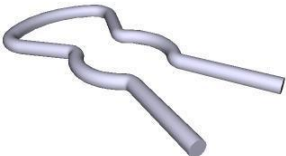
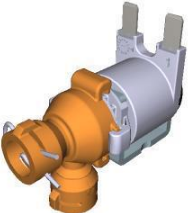

COMPONENT			SPARE PART																																																		
Code	Description	Image	Code	Description	Kit components																																																
VL1214A	BAYONET - 6mm BARBED NRV VALVE		VL1214A0	BAYONET - 6mm BARBED NRV VALVE																																																	
VM2172A	LOCKING CLIP FOR PUMP WITH CIRCUI		VM2172A0	LOCKING CLIP FOR PUMP WITH CIRCUI																																																	
EL1440A	WATER SELF CLEANING VALVE		KVL2618A	2 ROTOR ARMS ONE CLEANING SYSTEM KIT	<table border="1"> <thead> <tr> <th>Code</th> <th>Description</th> <th>Qty</th> <th>UOM</th> </tr> </thead> <tbody> <tr> <td>0H2202A1</td> <td>ONE WASHING WITH STEAM VALVE SUPPORT</td> <td>2.000</td> <td>PC</td> </tr> <tr> <td>CE1030A0</td> <td>FEMALE FASTON COVER 6.3X0.8 0.5-1mmg</td> <td>4.000</td> <td>PC</td> </tr> <tr> <td>CE1395A0</td> <td>6,3 X 0,8 iMALE FASTO</td> <td>2.000</td> <td>PC</td> </tr> <tr> <td>CE1545A0</td> <td>BLUE UNIP AWG18 ST.3135 WIRE</td> <td>2.000</td> <td>M</td> </tr> <tr> <td>CE1570A0</td> <td>WHITE UNIP AWG18 ST.3135 WIRE</td> <td>2.000</td> <td>M</td> </tr> <tr> <td>CE1660A0</td> <td>6,3x0,8 FEMALE FASTON COVE</td> <td>4.000</td> <td>PC</td> </tr> <tr> <td>CE1661A0</td> <td>MALE FASTON COVER 6,3x0,8</td> <td>2.000</td> <td>PC</td> </tr> <tr> <td>EL1020A1</td> <td>D8 INTERMEDIAT E T-SHAPED FITTING</td> <td>1.000</td> <td>PC</td> </tr> <tr> <td>EL1440A0</td> <td>WATER SELF CLEANING VALVE</td> <td>2.000</td> <td>PC</td> </tr> <tr> <td>GN1526A0</td> <td>INT. D.=6.9 TH=1.8 O-RIN</td> <td>6.000</td> <td>PC</td> </tr> <tr> <td>RC1018A0</td> <td>ZINC PLATED D12 ELASTIC CLAMP</td> <td>2.000</td> <td>PC</td> </tr> </tbody> </table>	Code	Description	Qty	UOM	0H2202A1	ONE WASHING WITH STEAM VALVE SUPPORT	2.000	PC	CE1030A0	FEMALE FASTON COVER 6.3X0.8 0.5-1mmg	4.000	PC	CE1395A0	6,3 X 0,8 iMALE FASTO	2.000	PC	CE1545A0	BLUE UNIP AWG18 ST.3135 WIRE	2.000	M	CE1570A0	WHITE UNIP AWG18 ST.3135 WIRE	2.000	M	CE1660A0	6,3x0,8 FEMALE FASTON COVE	4.000	PC	CE1661A0	MALE FASTON COVER 6,3x0,8	2.000	PC	EL1020A1	D8 INTERMEDIAT E T-SHAPED FITTING	1.000	PC	EL1440A0	WATER SELF CLEANING VALVE	2.000	PC	GN1526A0	INT. D.=6.9 TH=1.8 O-RIN	6.000	PC	RC1018A0	ZINC PLATED D12 ELASTIC CLAMP	2.000	PC
Code	Description	Qty	UOM																																																		
0H2202A1	ONE WASHING WITH STEAM VALVE SUPPORT	2.000	PC																																																		
CE1030A0	FEMALE FASTON COVER 6.3X0.8 0.5-1mmg	4.000	PC																																																		
CE1395A0	6,3 X 0,8 iMALE FASTO	2.000	PC																																																		
CE1545A0	BLUE UNIP AWG18 ST.3135 WIRE	2.000	M																																																		
CE1570A0	WHITE UNIP AWG18 ST.3135 WIRE	2.000	M																																																		
CE1660A0	6,3x0,8 FEMALE FASTON COVE	4.000	PC																																																		
CE1661A0	MALE FASTON COVER 6,3x0,8	2.000	PC																																																		
EL1020A1	D8 INTERMEDIAT E T-SHAPED FITTING	1.000	PC																																																		
EL1440A0	WATER SELF CLEANING VALVE	2.000	PC																																																		
GN1526A0	INT. D.=6.9 TH=1.8 O-RIN	6.000	PC																																																		
RC1018A0	ZINC PLATED D12 ELASTIC CLAMP	2.000	PC																																																		

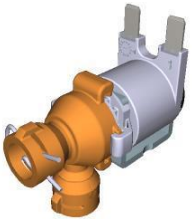

COMPONENT			SPARE PART																																																																																		
Code	Description	Image	Code	Description	Kit components																																																																																
EL1440A	WATER SELF CLEANING VALVE		KVL2618A	2 ROTOR ARMS ONE CLEANING SYSTEM KIT	<table border="1"> <thead> <tr> <th>Code</th> <th>Description</th> <th>Qty</th> <th>UOM</th> </tr> </thead> <tbody> <tr> <td>RC1019A0</td> <td>D=10 ELASTIC CLAMP</td> <td>28.000</td> <td>PC</td> </tr> <tr> <td>RC1130A0</td> <td>130x2,6 CLAM</td> <td>4.000</td> <td>PC</td> </tr> <tr> <td>RC1242A0</td> <td>D=10 CLOSED CAP</td> <td>4.000</td> <td>PC</td> </tr> <tr> <td>TB2821A0</td> <td>EPDM 6X10 L=40MM PIPE</td> <td>12.000</td> <td>PC</td> </tr> <tr> <td>TB3004A0</td> <td>TB2820A L=550mm EPDM BLACK PIPE</td> <td>2.000</td> <td>PC</td> </tr> <tr> <td>TB3009B0</td> <td>TB3132A-ONE OVEN WASHING INLET</td> <td>2.000</td> <td>PC</td> </tr> <tr> <td>TB3225B0</td> <td>TB2820A-TAN K-WASHYNG SYS CONNECTION</td> <td>2.000</td> <td>PC</td> </tr> <tr> <td>VH1220A1</td> <td>4,2x12 TCB SELF-TAPPIN G SCREW</td> <td>2.000</td> <td>PC</td> </tr> <tr> <td>VL1019A0</td> <td>VIBRATION DETERGENT PUMP</td> <td>2.000</td> <td>PC</td> </tr> <tr> <td>VL1047A1</td> <td>D6 PIPE HOLDER - D8 J.G. TERMINAL</td> <td>2.000</td> <td>PC</td> </tr> <tr> <td>VL1054B0</td> <td>ONE WASHING SYS INLET DISTRIBUTOR</td> <td>2.000</td> <td>PC</td> </tr> <tr> <td>VL1102A1</td> <td>DETERGENT LINE FILTER + BARBED VNR 6 MM</td> <td>2.000</td> <td>PC</td> </tr> <tr> <td>VL1127A1</td> <td>6mm BARBED T-SHAPED FITTING</td> <td>1.000</td> <td>PC</td> </tr> <tr> <td>VL1128A1</td> <td>D6 BARBED CHECK VALVE</td> <td>4.000</td> <td>PC</td> </tr> <tr> <td>VL1166A0</td> <td>BB6-AR6 L FITTING</td> <td>2.000</td> <td>PC</td> </tr> <tr> <td>VL1174C0</td> <td>D1.2 MM CALIBRATED D1.2 MM</td> <td>2.000</td> <td>PC</td> </tr> <tr> <td>VL1191A0</td> <td>ONE WASHING DISTRIBUTOR OUTLETS KIT</td> <td>2.000</td> <td>PC</td> </tr> <tr> <td>VL1214A0</td> <td>BAYONET - 6mm BARBED NRV VALVE</td> <td>2.000</td> <td>PC</td> </tr> <tr> <td>VM2172A0</td> <td>LOCKING CLIP FOR PUMP WITH CIRCUIT</td> <td>4.000</td> <td>PC</td> </tr> </tbody> </table>	Code	Description	Qty	UOM	RC1019A0	D=10 ELASTIC CLAMP	28.000	PC	RC1130A0	130x2,6 CLAM	4.000	PC	RC1242A0	D=10 CLOSED CAP	4.000	PC	TB2821A0	EPDM 6X10 L=40MM PIPE	12.000	PC	TB3004A0	TB2820A L=550mm EPDM BLACK PIPE	2.000	PC	TB3009B0	TB3132A-ONE OVEN WASHING INLET	2.000	PC	TB3225B0	TB2820A-TAN K-WASHYNG SYS CONNECTION	2.000	PC	VH1220A1	4,2x12 TCB SELF-TAPPIN G SCREW	2.000	PC	VL1019A0	VIBRATION DETERGENT PUMP	2.000	PC	VL1047A1	D6 PIPE HOLDER - D8 J.G. TERMINAL	2.000	PC	VL1054B0	ONE WASHING SYS INLET DISTRIBUTOR	2.000	PC	VL1102A1	DETERGENT LINE FILTER + BARBED VNR 6 MM	2.000	PC	VL1127A1	6mm BARBED T-SHAPED FITTING	1.000	PC	VL1128A1	D6 BARBED CHECK VALVE	4.000	PC	VL1166A0	BB6-AR6 L FITTING	2.000	PC	VL1174C0	D1.2 MM CALIBRATED D1.2 MM	2.000	PC	VL1191A0	ONE WASHING DISTRIBUTOR OUTLETS KIT	2.000	PC	VL1214A0	BAYONET - 6mm BARBED NRV VALVE	2.000	PC	VM2172A0	LOCKING CLIP FOR PUMP WITH CIRCUIT	4.000	PC
Code	Description	Qty	UOM																																																																																		
RC1019A0	D=10 ELASTIC CLAMP	28.000	PC																																																																																		
RC1130A0	130x2,6 CLAM	4.000	PC																																																																																		
RC1242A0	D=10 CLOSED CAP	4.000	PC																																																																																		
TB2821A0	EPDM 6X10 L=40MM PIPE	12.000	PC																																																																																		
TB3004A0	TB2820A L=550mm EPDM BLACK PIPE	2.000	PC																																																																																		
TB3009B0	TB3132A-ONE OVEN WASHING INLET	2.000	PC																																																																																		
TB3225B0	TB2820A-TAN K-WASHYNG SYS CONNECTION	2.000	PC																																																																																		
VH1220A1	4,2x12 TCB SELF-TAPPIN G SCREW	2.000	PC																																																																																		
VL1019A0	VIBRATION DETERGENT PUMP	2.000	PC																																																																																		
VL1047A1	D6 PIPE HOLDER - D8 J.G. TERMINAL	2.000	PC																																																																																		
VL1054B0	ONE WASHING SYS INLET DISTRIBUTOR	2.000	PC																																																																																		
VL1102A1	DETERGENT LINE FILTER + BARBED VNR 6 MM	2.000	PC																																																																																		
VL1127A1	6mm BARBED T-SHAPED FITTING	1.000	PC																																																																																		
VL1128A1	D6 BARBED CHECK VALVE	4.000	PC																																																																																		
VL1166A0	BB6-AR6 L FITTING	2.000	PC																																																																																		
VL1174C0	D1.2 MM CALIBRATED D1.2 MM	2.000	PC																																																																																		
VL1191A0	ONE WASHING DISTRIBUTOR OUTLETS KIT	2.000	PC																																																																																		
VL1214A0	BAYONET - 6mm BARBED NRV VALVE	2.000	PC																																																																																		
VM2172A0	LOCKING CLIP FOR PUMP WITH CIRCUIT	4.000	PC																																																																																		

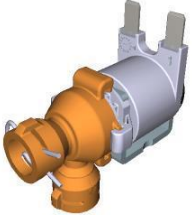
COMPONENT			SPARE PART																																																																														
Code	Description	Image	Code	Description	Kit components																																																																												
EL1440A	WATER SELF CLEANING VALVE		KVL1222A	EUR 0311 ONE PLUS CLEANING SYSTEM KIT	<table border="1"> <thead> <tr> <th>Code</th> <th>Description</th> <th>Qty</th> <th>UOM</th> </tr> </thead> <tbody> <tr> <td>0H2486A0</td> <td>0311 WASHING CIRCUIT PLAT</td> <td>1.000</td> <td>PC</td> </tr> <tr> <td>EL1440A0</td> <td>WATER SELF CLEANING VALVE</td> <td>1.000</td> <td>PC</td> </tr> <tr> <td>GN1526A0</td> <td>INT. D.=6.9 TH=1.8 O-RIN</td> <td>3.000</td> <td>PC</td> </tr> <tr> <td>RC1018A0</td> <td>ZINC PLATED D12 ELASTIC CLAMP</td> <td>1.000</td> <td>PC</td> </tr> <tr> <td>RC1019A0</td> <td>D=10 ELASTIC CLAMP</td> <td>14.000</td> <td>PC</td> </tr> <tr> <td>RC1242A0</td> <td>D=10 CLOSED CAP</td> <td>2.000</td> <td>PC</td> </tr> <tr> <td>TB2821A0</td> <td>EPDM 6X10 L=40MM PIPE</td> <td>6.000</td> <td>PC</td> </tr> <tr> <td>TB3004A0</td> <td>TB2820A L=550mm EPDM BLACK PIPE</td> <td>1.000</td> <td>PC</td> </tr> <tr> <td>TB3009B0</td> <td>TB3132A-ONE OVEN WASHING INLET</td> <td>1.000</td> <td>PC</td> </tr> <tr> <td>TB3225B0</td> <td>TB2820A-TAN K-WASHYNG SYS CONNECTION</td> <td>1.000</td> <td>PC</td> </tr> <tr> <td>VI1220A1</td> <td>4,2x12 TCB SELF-TAPPIN G SCREW</td> <td>4.000</td> <td>PC</td> </tr> <tr> <td>VL1019A0</td> <td>VIBRATION DETERGENT PUMP</td> <td>1.000</td> <td>PC</td> </tr> <tr> <td>VL1047A1</td> <td>D6 PIPE HOLDER - D6 J.G. TERMINAL</td> <td>1.000</td> <td>PC</td> </tr> <tr> <td>VL1054B0</td> <td>ONE WASHING SYS INLET DISTRIBUTOR</td> <td>1.000</td> <td>PC</td> </tr> <tr> <td>VL1102A1</td> <td>DETERGENT LINE FILTER + BARBED VNR 6 MM</td> <td>1.000</td> <td>PC</td> </tr> <tr> <td>VL1128A1</td> <td>D6 BARBED CHECK VALVE</td> <td>2.000</td> <td>PC</td> </tr> <tr> <td>VL1166A0</td> <td>BB6-AR6 L FITTING</td> <td>1.000</td> <td>PC</td> </tr> <tr> <td>VL1174C0</td> <td>D1.2 MM CALIBRATED D1.2 MM</td> <td>1.000</td> <td>PC</td> </tr> </tbody> </table>	Code	Description	Qty	UOM	0H2486A0	0311 WASHING CIRCUIT PLAT	1.000	PC	EL1440A0	WATER SELF CLEANING VALVE	1.000	PC	GN1526A0	INT. D.=6.9 TH=1.8 O-RIN	3.000	PC	RC1018A0	ZINC PLATED D12 ELASTIC CLAMP	1.000	PC	RC1019A0	D=10 ELASTIC CLAMP	14.000	PC	RC1242A0	D=10 CLOSED CAP	2.000	PC	TB2821A0	EPDM 6X10 L=40MM PIPE	6.000	PC	TB3004A0	TB2820A L=550mm EPDM BLACK PIPE	1.000	PC	TB3009B0	TB3132A-ONE OVEN WASHING INLET	1.000	PC	TB3225B0	TB2820A-TAN K-WASHYNG SYS CONNECTION	1.000	PC	VI1220A1	4,2x12 TCB SELF-TAPPIN G SCREW	4.000	PC	VL1019A0	VIBRATION DETERGENT PUMP	1.000	PC	VL1047A1	D6 PIPE HOLDER - D6 J.G. TERMINAL	1.000	PC	VL1054B0	ONE WASHING SYS INLET DISTRIBUTOR	1.000	PC	VL1102A1	DETERGENT LINE FILTER + BARBED VNR 6 MM	1.000	PC	VL1128A1	D6 BARBED CHECK VALVE	2.000	PC	VL1166A0	BB6-AR6 L FITTING	1.000	PC	VL1174C0	D1.2 MM CALIBRATED D1.2 MM	1.000	PC
Code	Description	Qty	UOM																																																																														
0H2486A0	0311 WASHING CIRCUIT PLAT	1.000	PC																																																																														
EL1440A0	WATER SELF CLEANING VALVE	1.000	PC																																																																														
GN1526A0	INT. D.=6.9 TH=1.8 O-RIN	3.000	PC																																																																														
RC1018A0	ZINC PLATED D12 ELASTIC CLAMP	1.000	PC																																																																														
RC1019A0	D=10 ELASTIC CLAMP	14.000	PC																																																																														
RC1242A0	D=10 CLOSED CAP	2.000	PC																																																																														
TB2821A0	EPDM 6X10 L=40MM PIPE	6.000	PC																																																																														
TB3004A0	TB2820A L=550mm EPDM BLACK PIPE	1.000	PC																																																																														
TB3009B0	TB3132A-ONE OVEN WASHING INLET	1.000	PC																																																																														
TB3225B0	TB2820A-TAN K-WASHYNG SYS CONNECTION	1.000	PC																																																																														
VI1220A1	4,2x12 TCB SELF-TAPPIN G SCREW	4.000	PC																																																																														
VL1019A0	VIBRATION DETERGENT PUMP	1.000	PC																																																																														
VL1047A1	D6 PIPE HOLDER - D6 J.G. TERMINAL	1.000	PC																																																																														
VL1054B0	ONE WASHING SYS INLET DISTRIBUTOR	1.000	PC																																																																														
VL1102A1	DETERGENT LINE FILTER + BARBED VNR 6 MM	1.000	PC																																																																														
VL1128A1	D6 BARBED CHECK VALVE	2.000	PC																																																																														
VL1166A0	BB6-AR6 L FITTING	1.000	PC																																																																														
VL1174C0	D1.2 MM CALIBRATED D1.2 MM	1.000	PC																																																																														

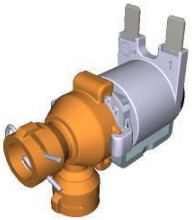
COMPONENT			SPARE PART																																																																			
Code	Description	Image	Code	Description	Kit components																																																																	
EL1440A	WATER SELF CLEANING VALVE		KVL1222A	EUR 0311 ONE PLUS CLEANING SYSTEM KIT	<table border="1"> <thead> <tr> <th>Code</th> <th>Description</th> <th>Qty</th> <th>UOM</th> </tr> </thead> <tbody> <tr> <td>VL1191A0</td> <td>ONE WASHING DISTRIBUTOR OUTLETS KIT</td> <td>1.000</td> <td>PC</td> </tr> <tr> <td>VL1214A0</td> <td>BAYONET - 6mm BARBED NRV VALVE</td> <td>1.000</td> <td>PC</td> </tr> <tr> <td>VM2172A0</td> <td>LOCKING CLIP FOR PUMP WITH CIRCUIT</td> <td>2.000</td> <td>PC</td> </tr> </tbody> </table>	Code	Description	Qty	UOM	VL1191A0	ONE WASHING DISTRIBUTOR OUTLETS KIT	1.000	PC	VL1214A0	BAYONET - 6mm BARBED NRV VALVE	1.000	PC	VM2172A0	LOCKING CLIP FOR PUMP WITH CIRCUIT	2.000	PC																																																	
			Code	Description	Qty	UOM																																																																
VL1191A0	ONE WASHING DISTRIBUTOR OUTLETS KIT	1.000	PC																																																																			
VL1214A0	BAYONET - 6mm BARBED NRV VALVE	1.000	PC																																																																			
VM2172A0	LOCKING CLIP FOR PUMP WITH CIRCUIT	2.000	PC																																																																			
KVL1212A	EUR COMPACT PLUS CLEANING SYSTEM KIT	<table border="1"> <thead> <tr> <th>Code</th> <th>Description</th> <th>Qty</th> <th>UOM</th> </tr> </thead> <tbody> <tr> <td>0H2428A2</td> <td>XECC PLUS WASHING CIRCUIT PLAT</td> <td>1.000</td> <td>PC</td> </tr> <tr> <td>EL1440A0</td> <td>WATER SELF CLEANING VALVE</td> <td>3.000</td> <td>PC</td> </tr> <tr> <td>GN1312A0</td> <td>RUBBER CABLE-PASSI NG DE=26 DI=15 SP=10</td> <td>1.000</td> <td>PC</td> </tr> <tr> <td>GN1526A0</td> <td>INT. D.=6.9 TH=1.8 O-RIN</td> <td>7.000</td> <td>PC</td> </tr> <tr> <td>RC1018A0</td> <td>ZINC PLATED D12 ELASTIC CLAMP</td> <td>2.000</td> <td>PC</td> </tr> <tr> <td>RC1019A0</td> <td>D=10 ELASTIC CLAMP</td> <td>14.000</td> <td>PC</td> </tr> <tr> <td>RC1130A0</td> <td>130x2.6 CLAM</td> <td>1.000</td> <td>PC</td> </tr> <tr> <td>RC1131A0</td> <td>200x2.6 BLACK CLAMP</td> <td>1.000</td> <td>PC</td> </tr> <tr> <td>RC1242A0</td> <td>D=10 CLOSED CAP</td> <td>2.000</td> <td>PC</td> </tr> <tr> <td>RC1356A0</td> <td>"STRAIGHT THREADED FEMALE END 8x1/4" BS</td> <td>1.000</td> <td>PC</td> </tr> <tr> <td>TB2821A0</td> <td>EPDM 6X10 L=40MM PIPE</td> <td>6.000</td> <td>PC</td> </tr> <tr> <td>TB3004A0</td> <td>TB2820A L=550mm EPDM BLACK PIPE</td> <td>2.000</td> <td>PC</td> </tr> <tr> <td>TB3005B0</td> <td>TB3132A L=550mm EPDM WHITE-BLUE PIPE</td> <td>1.000</td> <td>PC</td> </tr> <tr> <td>TB3469A0</td> <td></td> <td>1.000</td> <td>PC</td> </tr> <tr> <td>VL1019A0</td> <td>VIBRATION DETERGENT PUMP</td> <td>1.000</td> <td>PC</td> </tr> <tr> <td>VL1047A1</td> <td>D6 PIPE HOLDER - D8 J.G. TERMINAL</td> <td>1.000</td> <td>PC</td> </tr> </tbody> </table>	Code	Description	Qty	UOM	0H2428A2	XECC PLUS WASHING CIRCUIT PLAT	1.000	PC	EL1440A0	WATER SELF CLEANING VALVE	3.000	PC	GN1312A0	RUBBER CABLE-PASSI NG DE=26 DI=15 SP=10	1.000	PC	GN1526A0	INT. D.=6.9 TH=1.8 O-RIN	7.000	PC	RC1018A0	ZINC PLATED D12 ELASTIC CLAMP	2.000	PC	RC1019A0	D=10 ELASTIC CLAMP	14.000	PC	RC1130A0	130x2.6 CLAM	1.000	PC	RC1131A0	200x2.6 BLACK CLAMP	1.000	PC	RC1242A0	D=10 CLOSED CAP	2.000	PC	RC1356A0	"STRAIGHT THREADED FEMALE END 8x1/4" BS	1.000	PC	TB2821A0	EPDM 6X10 L=40MM PIPE	6.000	PC	TB3004A0	TB2820A L=550mm EPDM BLACK PIPE	2.000	PC	TB3005B0	TB3132A L=550mm EPDM WHITE-BLUE PIPE	1.000	PC	TB3469A0		1.000	PC	VL1019A0	VIBRATION DETERGENT PUMP	1.000	PC	VL1047A1	D6 PIPE HOLDER - D8 J.G. TERMINAL	1.000	PC
Code	Description	Qty	UOM																																																																			
0H2428A2	XECC PLUS WASHING CIRCUIT PLAT	1.000	PC																																																																			
EL1440A0	WATER SELF CLEANING VALVE	3.000	PC																																																																			
GN1312A0	RUBBER CABLE-PASSI NG DE=26 DI=15 SP=10	1.000	PC																																																																			
GN1526A0	INT. D.=6.9 TH=1.8 O-RIN	7.000	PC																																																																			
RC1018A0	ZINC PLATED D12 ELASTIC CLAMP	2.000	PC																																																																			
RC1019A0	D=10 ELASTIC CLAMP	14.000	PC																																																																			
RC1130A0	130x2.6 CLAM	1.000	PC																																																																			
RC1131A0	200x2.6 BLACK CLAMP	1.000	PC																																																																			
RC1242A0	D=10 CLOSED CAP	2.000	PC																																																																			
RC1356A0	"STRAIGHT THREADED FEMALE END 8x1/4" BS	1.000	PC																																																																			
TB2821A0	EPDM 6X10 L=40MM PIPE	6.000	PC																																																																			
TB3004A0	TB2820A L=550mm EPDM BLACK PIPE	2.000	PC																																																																			
TB3005B0	TB3132A L=550mm EPDM WHITE-BLUE PIPE	1.000	PC																																																																			
TB3469A0		1.000	PC																																																																			
VL1019A0	VIBRATION DETERGENT PUMP	1.000	PC																																																																			
VL1047A1	D6 PIPE HOLDER - D8 J.G. TERMINAL	1.000	PC																																																																			

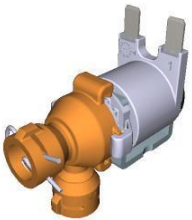
COMPONENT			SPARE PART																																										
Code	Description	Image	Code	Description	Kit components																																								
EL1440A	WATER SELF CLEANING VALVE		KVL1212A	EUR COMPACT PLUS CLEANING SYSTEM KIT	<table border="1"> <thead> <tr> <th>Code</th> <th>Description</th> <th>Qty</th> <th>UOM</th> </tr> </thead> <tbody> <tr> <td>VL1054B0</td> <td>ONE WASHING SYS INLET DISTRIBUTOR</td> <td>1.000</td> <td>PC</td> </tr> <tr> <td>VL1102A1</td> <td>DETERGENT LINE FILTER + BARBED VNR 6 MM</td> <td>1.000</td> <td>PC</td> </tr> <tr> <td>VL1128A1</td> <td>D6 BARBED CHECK VALVE</td> <td>2.000</td> <td>PC</td> </tr> <tr> <td>VL1165A0</td> <td>BAM-BB6 STRAIGHT FITTING</td> <td>1.000</td> <td>PC</td> </tr> <tr> <td>VL1166A0</td> <td>BB6-AR6 L FITTING</td> <td>3.000</td> <td>PC</td> </tr> <tr> <td>VL1174C0</td> <td>D1.2 MM CALIBRATED D1.2 MM</td> <td>1.000</td> <td>PC</td> </tr> <tr> <td>VL1185A0</td> <td>2 WAYS PLUS WASHING DISTRIBUTOR</td> <td>1.000</td> <td>PC</td> </tr> <tr> <td>VL1398A0</td> <td>1/4 M N.O. CIL PRESSURE SWITCH</td> <td>1.000</td> <td>PC</td> </tr> <tr> <td>VM2172A0</td> <td>LOCKING CLIP FOR PUMP WITH CIRCUIT</td> <td>6.000</td> <td>PC</td> </tr> </tbody> </table>	Code	Description	Qty	UOM	VL1054B0	ONE WASHING SYS INLET DISTRIBUTOR	1.000	PC	VL1102A1	DETERGENT LINE FILTER + BARBED VNR 6 MM	1.000	PC	VL1128A1	D6 BARBED CHECK VALVE	2.000	PC	VL1165A0	BAM-BB6 STRAIGHT FITTING	1.000	PC	VL1166A0	BB6-AR6 L FITTING	3.000	PC	VL1174C0	D1.2 MM CALIBRATED D1.2 MM	1.000	PC	VL1185A0	2 WAYS PLUS WASHING DISTRIBUTOR	1.000	PC	VL1398A0	1/4 M N.O. CIL PRESSURE SWITCH	1.000	PC	VM2172A0	LOCKING CLIP FOR PUMP WITH CIRCUIT	6.000	PC
			Code	Description	Qty	UOM																																							
VL1054B0	ONE WASHING SYS INLET DISTRIBUTOR	1.000	PC																																										
VL1102A1	DETERGENT LINE FILTER + BARBED VNR 6 MM	1.000	PC																																										
VL1128A1	D6 BARBED CHECK VALVE	2.000	PC																																										
VL1165A0	BAM-BB6 STRAIGHT FITTING	1.000	PC																																										
VL1166A0	BB6-AR6 L FITTING	3.000	PC																																										
VL1174C0	D1.2 MM CALIBRATED D1.2 MM	1.000	PC																																										
VL1185A0	2 WAYS PLUS WASHING DISTRIBUTOR	1.000	PC																																										
VL1398A0	1/4 M N.O. CIL PRESSURE SWITCH	1.000	PC																																										
VM2172A0	LOCKING CLIP FOR PUMP WITH CIRCUIT	6.000	PC																																										
KVL1211A	ONE COMPACT AND 0523-EP WASH. SYSTEM KIT	<table border="1"> <thead> <tr> <th>Code</th> <th>Description</th> <th>Qty</th> <th>UOM</th> </tr> </thead> <tbody> <tr> <td>0H2427A0</td> <td>XECC WASHING CIRCUIT HOLDING PLATE</td> <td>1.000</td> <td>PC</td> </tr> <tr> <td>EL1440A0</td> <td>WATER SELF CLEANING VALVE</td> <td>1.000</td> <td>PC</td> </tr> <tr> <td>GN1526A0</td> <td>INT. D.=6.9 TH=1.8 O-RING</td> <td>3.000</td> <td>PC</td> </tr> <tr> <td>RC1018A0</td> <td>ZINC PLATED D12 ELASTIC CLAMP</td> <td>1.000</td> <td>PC</td> </tr> <tr> <td>RC1019A0</td> <td>D=10 ELASTIC CLAMP</td> <td>14.000</td> <td>PC</td> </tr> <tr> <td>RC1130A0</td> <td>130x2,6 CLAM</td> <td>1.000</td> <td>PC</td> </tr> <tr> <td>RC1242A0</td> <td>D=10 CLOSED CAP</td> <td>2.000</td> <td>PC</td> </tr> <tr> <td>TB1402A0</td> <td>TB2820A-DETE RGENT CIRCUIT-FILTE R PIPE</td> <td>1.000</td> <td>PC</td> </tr> <tr> <td>TB2821A0</td> <td>EPDM 6X10 L=40MM PIPE</td> <td>6.000</td> <td>PC</td> </tr> </tbody> </table>	Code	Description	Qty	UOM	0H2427A0	XECC WASHING CIRCUIT HOLDING PLATE	1.000	PC	EL1440A0	WATER SELF CLEANING VALVE	1.000	PC	GN1526A0	INT. D.=6.9 TH=1.8 O-RING	3.000	PC	RC1018A0	ZINC PLATED D12 ELASTIC CLAMP	1.000	PC	RC1019A0	D=10 ELASTIC CLAMP	14.000	PC	RC1130A0	130x2,6 CLAM	1.000	PC	RC1242A0	D=10 CLOSED CAP	2.000	PC	TB1402A0	TB2820A-DETE RGENT CIRCUIT-FILTE R PIPE	1.000	PC	TB2821A0	EPDM 6X10 L=40MM PIPE	6.000	PC			
Code	Description	Qty	UOM																																										
0H2427A0	XECC WASHING CIRCUIT HOLDING PLATE	1.000	PC																																										
EL1440A0	WATER SELF CLEANING VALVE	1.000	PC																																										
GN1526A0	INT. D.=6.9 TH=1.8 O-RING	3.000	PC																																										
RC1018A0	ZINC PLATED D12 ELASTIC CLAMP	1.000	PC																																										
RC1019A0	D=10 ELASTIC CLAMP	14.000	PC																																										
RC1130A0	130x2,6 CLAM	1.000	PC																																										
RC1242A0	D=10 CLOSED CAP	2.000	PC																																										
TB1402A0	TB2820A-DETE RGENT CIRCUIT-FILTE R PIPE	1.000	PC																																										
TB2821A0	EPDM 6X10 L=40MM PIPE	6.000	PC																																										

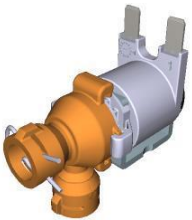

COMPONENT			SPARE PART																																																																																									
Code	Description	Image	Code	Description	Kit components																																																																																							
EL1440A	WATER SELF CLEANING VALVE		KVL1211A	ONE COMPACT AND 0523-EP WASH. SYSTEM KIT	<table border="1"> <thead> <tr> <th>Code</th> <th>Description</th> <th>Qty</th> <th>UOM</th> </tr> </thead> <tbody> <tr> <td>TB3004A0</td> <td>TB2820A L=550mm EPDM BLACK PIPE</td> <td>1.000</td> <td>PC</td> </tr> <tr> <td>TB3469A0</td> <td></td> <td>1.000</td> <td>PC</td> </tr> <tr> <td>VI1220A1</td> <td>4,2x12 TCB SELF-TAPPIN G SCREW</td> <td>4.000</td> <td>PC</td> </tr> <tr> <td>VL1019A0</td> <td>VIBRATION DETERGENT PUMP</td> <td>1.000</td> <td>PC</td> </tr> <tr> <td>VL1047A1</td> <td>D6 PIPE HOLDER - D8 J.G. TERMINAL</td> <td>1.000</td> <td>PC</td> </tr> <tr> <td>VL1054B0</td> <td>ONE WASHING SYS INLET DISTRIBUTOR</td> <td>1.000</td> <td>PC</td> </tr> <tr> <td>VL1102A1</td> <td>DETERGENT LINE FILTER + BARBED VNR 6 MM</td> <td>1.000</td> <td>PC</td> </tr> <tr> <td>VL1128A1</td> <td>D6 BARBED CHECK VALVE</td> <td>2.000</td> <td>PC</td> </tr> <tr> <td>VL1165A0</td> <td>BAM-BB6 STRAIGHT FITTING</td> <td>1.000</td> <td>PC</td> </tr> <tr> <td>VL1166A0</td> <td>BB6-AR6 L FITTING</td> <td>1.000</td> <td>PC</td> </tr> <tr> <td>VL1174C0</td> <td>D1.2 MM CALIBRATED D1.2 MM</td> <td>1.000</td> <td>PC</td> </tr> <tr> <td>VL1191A0</td> <td>ONE WASHING DISTRIBUTOR OUTLETS KIT</td> <td>1.000</td> <td>PC</td> </tr> <tr> <td>VM2172A0</td> <td>LOCKING CLIP FOR PUMP WITH CIRCUIT</td> <td>2.000</td> <td>PC</td> </tr> </tbody> </table>	Code	Description	Qty	UOM	TB3004A0	TB2820A L=550mm EPDM BLACK PIPE	1.000	PC	TB3469A0		1.000	PC	VI1220A1	4,2x12 TCB SELF-TAPPIN G SCREW	4.000	PC	VL1019A0	VIBRATION DETERGENT PUMP	1.000	PC	VL1047A1	D6 PIPE HOLDER - D8 J.G. TERMINAL	1.000	PC	VL1054B0	ONE WASHING SYS INLET DISTRIBUTOR	1.000	PC	VL1102A1	DETERGENT LINE FILTER + BARBED VNR 6 MM	1.000	PC	VL1128A1	D6 BARBED CHECK VALVE	2.000	PC	VL1165A0	BAM-BB6 STRAIGHT FITTING	1.000	PC	VL1166A0	BB6-AR6 L FITTING	1.000	PC	VL1174C0	D1.2 MM CALIBRATED D1.2 MM	1.000	PC	VL1191A0	ONE WASHING DISTRIBUTOR OUTLETS KIT	1.000	PC	VM2172A0	LOCKING CLIP FOR PUMP WITH CIRCUIT	2.000	PC	KVL1198A	MM EU HOOD CLEANING SYSTEM KIT	<table border="1"> <thead> <tr> <th>Code</th> <th>Description</th> <th>Qty</th> <th>UOM</th> </tr> </thead> <tbody> <tr> <td>0H2213A1</td> <td>HOOD WATER CIRCUIT PLAT</td> <td>1.000</td> <td>PC</td> </tr> <tr> <td>EL1440A0</td> <td>WATER SELF CLEANING VALVE</td> <td>2.000</td> <td>PC</td> </tr> <tr> <td>GN1526A0</td> <td>INT. D.=6.9 TH=1.8 O-RIN</td> <td>5.000</td> <td>PC</td> </tr> <tr> <td>RC1018A0</td> <td>ZINC PLATED D12 ELASTIC CLAMP</td> <td>4.000</td> <td>PC</td> </tr> <tr> <td>RC1019A0</td> <td>D=10 ELASTIC CLAMP</td> <td>16.000</td> <td>PC</td> </tr> <tr> <td>RC1131A0</td> <td>200x2.6 BLACK CLAMP</td> <td>1.000</td> <td>PC</td> </tr> </tbody> </table>	Code	Description	Qty	UOM	0H2213A1	HOOD WATER CIRCUIT PLAT	1.000	PC	EL1440A0	WATER SELF CLEANING VALVE	2.000	PC	GN1526A0	INT. D.=6.9 TH=1.8 O-RIN	5.000	PC	RC1018A0	ZINC PLATED D12 ELASTIC CLAMP	4.000	PC	RC1019A0	D=10 ELASTIC CLAMP	16.000	PC	RC1131A0	200x2.6 BLACK CLAMP	1.000	PC
			Code	Description	Qty	UOM																																																																																						
TB3004A0	TB2820A L=550mm EPDM BLACK PIPE	1.000	PC																																																																																									
TB3469A0		1.000	PC																																																																																									
VI1220A1	4,2x12 TCB SELF-TAPPIN G SCREW	4.000	PC																																																																																									
VL1019A0	VIBRATION DETERGENT PUMP	1.000	PC																																																																																									
VL1047A1	D6 PIPE HOLDER - D8 J.G. TERMINAL	1.000	PC																																																																																									
VL1054B0	ONE WASHING SYS INLET DISTRIBUTOR	1.000	PC																																																																																									
VL1102A1	DETERGENT LINE FILTER + BARBED VNR 6 MM	1.000	PC																																																																																									
VL1128A1	D6 BARBED CHECK VALVE	2.000	PC																																																																																									
VL1165A0	BAM-BB6 STRAIGHT FITTING	1.000	PC																																																																																									
VL1166A0	BB6-AR6 L FITTING	1.000	PC																																																																																									
VL1174C0	D1.2 MM CALIBRATED D1.2 MM	1.000	PC																																																																																									
VL1191A0	ONE WASHING DISTRIBUTOR OUTLETS KIT	1.000	PC																																																																																									
VM2172A0	LOCKING CLIP FOR PUMP WITH CIRCUIT	2.000	PC																																																																																									
Code	Description	Qty	UOM																																																																																									
0H2213A1	HOOD WATER CIRCUIT PLAT	1.000	PC																																																																																									
EL1440A0	WATER SELF CLEANING VALVE	2.000	PC																																																																																									
GN1526A0	INT. D.=6.9 TH=1.8 O-RIN	5.000	PC																																																																																									
RC1018A0	ZINC PLATED D12 ELASTIC CLAMP	4.000	PC																																																																																									
RC1019A0	D=10 ELASTIC CLAMP	16.000	PC																																																																																									
RC1131A0	200x2.6 BLACK CLAMP	1.000	PC																																																																																									

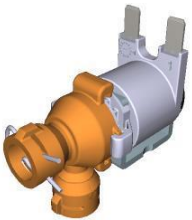
COMPONENT			SPARE PART																																																																														
Code	Description	Image	Code	Description	Kit components																																																																												
EL1440A	WATER SELF CLEANING VALVE		KVL1198A	MM EU HOOD CLEANING SYSTEM KIT	<table border="1"> <thead> <tr> <th>Code</th> <th>Description</th> <th>Qty</th> <th>UOM</th> </tr> </thead> <tbody> <tr> <td>RC1242A0</td> <td>D=10 CLOSED CAP</td> <td>2.000</td> <td>PC</td> </tr> <tr> <td>TB2821A0</td> <td>EPDM 6X10 L=40MM PIPE</td> <td>6.000</td> <td>PC</td> </tr> <tr> <td>TB2994A0</td> <td>HOOD DETERGENT PIPE</td> <td>2.000</td> <td>PC</td> </tr> <tr> <td>TB3252A0</td> <td></td> <td>2.000</td> <td>PC</td> </tr> <tr> <td>VI1220A1</td> <td>4,2x12 TCB SELF-TAPPIN G SCREW</td> <td>3.000</td> <td>PC</td> </tr> <tr> <td>VL1019A0</td> <td>VIBRATION DETERGENT PUMP</td> <td>1.000</td> <td>PC</td> </tr> <tr> <td>VL1047A1</td> <td>D6 PIPE HOLDER - D8 J.G. TERMINAL</td> <td>2.000</td> <td>PC</td> </tr> <tr> <td>VL1054B0</td> <td>ONE WASHING SYS INLET DISTRIBUTOR</td> <td>1.000</td> <td>PC</td> </tr> <tr> <td>VL1102A1</td> <td>DETERGENT LINE FILTER + BARBED VNR 6 MM</td> <td>1.000</td> <td>PC</td> </tr> <tr> <td>VL1127A1</td> <td>6mm BARBED T-SHAPED FITTING</td> <td>1.000</td> <td>PC</td> </tr> <tr> <td>VL1128A1</td> <td>D6 BARBED CHECK VALVE</td> <td>2.000</td> <td>PC</td> </tr> <tr> <td>VL1165A0</td> <td>BAM-BB6 STRAIGHT FITTING</td> <td>1.000</td> <td>PC</td> </tr> <tr> <td>VL1166A0</td> <td>BB6-AR6 L FITTING</td> <td>2.000</td> <td>PC</td> </tr> <tr> <td>VL1174C0</td> <td>D1.2 MM CALIBRATED D1.2 MM</td> <td>1.000</td> <td>PC</td> </tr> <tr> <td>VL1191A0</td> <td>ONE WASHING DISTRIBUTOR OUTLETS KIT</td> <td>1.000</td> <td>PC</td> </tr> <tr> <td>VL1214A0</td> <td>BAYONET - 6mm BARBED NRV VALVE</td> <td>1.000</td> <td>PC</td> </tr> <tr> <td>VM1605A0</td> <td>CLIP TWIST LOCK DIAM. 10,2-12,7 MM</td> <td>2.000</td> <td>PC</td> </tr> <tr> <td>VM2172A0</td> <td>LOCKING CLIP FOR PUMP WITH CIRCUIT</td> <td>5.000</td> <td>PC</td> </tr> </tbody> </table>	Code	Description	Qty	UOM	RC1242A0	D=10 CLOSED CAP	2.000	PC	TB2821A0	EPDM 6X10 L=40MM PIPE	6.000	PC	TB2994A0	HOOD DETERGENT PIPE	2.000	PC	TB3252A0		2.000	PC	VI1220A1	4,2x12 TCB SELF-TAPPIN G SCREW	3.000	PC	VL1019A0	VIBRATION DETERGENT PUMP	1.000	PC	VL1047A1	D6 PIPE HOLDER - D8 J.G. TERMINAL	2.000	PC	VL1054B0	ONE WASHING SYS INLET DISTRIBUTOR	1.000	PC	VL1102A1	DETERGENT LINE FILTER + BARBED VNR 6 MM	1.000	PC	VL1127A1	6mm BARBED T-SHAPED FITTING	1.000	PC	VL1128A1	D6 BARBED CHECK VALVE	2.000	PC	VL1165A0	BAM-BB6 STRAIGHT FITTING	1.000	PC	VL1166A0	BB6-AR6 L FITTING	2.000	PC	VL1174C0	D1.2 MM CALIBRATED D1.2 MM	1.000	PC	VL1191A0	ONE WASHING DISTRIBUTOR OUTLETS KIT	1.000	PC	VL1214A0	BAYONET - 6mm BARBED NRV VALVE	1.000	PC	VM1605A0	CLIP TWIST LOCK DIAM. 10,2-12,7 MM	2.000	PC	VM2172A0	LOCKING CLIP FOR PUMP WITH CIRCUIT	5.000	PC
Code	Description	Qty	UOM																																																																														
RC1242A0	D=10 CLOSED CAP	2.000	PC																																																																														
TB2821A0	EPDM 6X10 L=40MM PIPE	6.000	PC																																																																														
TB2994A0	HOOD DETERGENT PIPE	2.000	PC																																																																														
TB3252A0		2.000	PC																																																																														
VI1220A1	4,2x12 TCB SELF-TAPPIN G SCREW	3.000	PC																																																																														
VL1019A0	VIBRATION DETERGENT PUMP	1.000	PC																																																																														
VL1047A1	D6 PIPE HOLDER - D8 J.G. TERMINAL	2.000	PC																																																																														
VL1054B0	ONE WASHING SYS INLET DISTRIBUTOR	1.000	PC																																																																														
VL1102A1	DETERGENT LINE FILTER + BARBED VNR 6 MM	1.000	PC																																																																														
VL1127A1	6mm BARBED T-SHAPED FITTING	1.000	PC																																																																														
VL1128A1	D6 BARBED CHECK VALVE	2.000	PC																																																																														
VL1165A0	BAM-BB6 STRAIGHT FITTING	1.000	PC																																																																														
VL1166A0	BB6-AR6 L FITTING	2.000	PC																																																																														
VL1174C0	D1.2 MM CALIBRATED D1.2 MM	1.000	PC																																																																														
VL1191A0	ONE WASHING DISTRIBUTOR OUTLETS KIT	1.000	PC																																																																														
VL1214A0	BAYONET - 6mm BARBED NRV VALVE	1.000	PC																																																																														
VM1605A0	CLIP TWIST LOCK DIAM. 10,2-12,7 MM	2.000	PC																																																																														
VM2172A0	LOCKING CLIP FOR PUMP WITH CIRCUIT	5.000	PC																																																																														

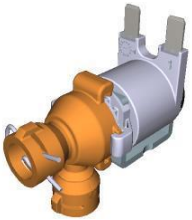
COMPONENT			SPARE PART																																																																																														
Code	Description	Image	Code	Description	Kit components																																																																																												
EL1440A	WATER SELF CLEANING VALVE		KVL1187A	3 ROTOR ARMS PLUS EU CLEANING SYSTEM KIT	<table border="1"> <thead> <tr> <th>Code</th> <th>Description</th> <th>Qty</th> <th>UOM</th> </tr> </thead> <tbody> <tr> <td>0H2354A1</td> <td>XEVC-XEVL PLUS WASHING CIRCUIT PLAT</td> <td>1.000</td> <td>PC</td> </tr> <tr> <td>EL1440A0</td> <td>WATER SELF CLEANING VALVE</td> <td>4.000</td> <td>PC</td> </tr> <tr> <td>GN1526A0</td> <td>INT. D.=6.9 TH=1.8 O-RIN</td> <td>9.000</td> <td>PC</td> </tr> <tr> <td>RC1018A0</td> <td>ZINC PLATED D12 ELASTIC CLAMP</td> <td>11.000</td> <td>PC</td> </tr> <tr> <td>RC1019A0</td> <td>D=10 ELASTIC CLAMP</td> <td>16.000</td> <td>PC</td> </tr> <tr> <td>RC1130A0</td> <td>130x2.6 CLAM</td> <td>1.000</td> <td>PC</td> </tr> <tr> <td>RC1131A0</td> <td>200x2.6 BLACK CLAMP</td> <td>3.000</td> <td>PC</td> </tr> <tr> <td>RC1242A0</td> <td>D=10 CLOSED CAP</td> <td>2.000</td> <td>PC</td> </tr> <tr> <td>RC1356A0</td> <td>"STRAIGHT THREADED FEMALE END 8x1/4" BS</td> <td>1.000</td> <td>PC</td> </tr> <tr> <td>TB2652A0</td> <td></td> <td>1.000</td> <td>PC</td> </tr> <tr> <td>TB2677A0</td> <td></td> <td>1.000</td> <td>PC</td> </tr> <tr> <td>TB2821A0</td> <td>EPDM 6X10 L=40MM PIPE</td> <td>6.000</td> <td>PC</td> </tr> <tr> <td>TB3004A0</td> <td>TB2820A L=550mm EPDM BLACK PIPE</td> <td>2.000</td> <td>PC</td> </tr> <tr> <td>TB3024C0</td> <td></td> <td>3.000</td> <td>PC</td> </tr> <tr> <td>TB3226A0</td> <td></td> <td>1.000</td> <td>PC</td> </tr> <tr> <td>TB3440A0</td> <td>TB3132A L=1050mm EPDM WHITE-BLUE PIPE</td> <td>1.000</td> <td>PC</td> </tr> <tr> <td>VL1019A0</td> <td>VIBRATION DETERGENT PUMP</td> <td>1.000</td> <td>PC</td> </tr> <tr> <td>VL1047A1</td> <td>D6 PIPE HOLDER - D8 J.G. TERMINAL</td> <td>1.000</td> <td>PC</td> </tr> <tr> <td>VL1102A1</td> <td>DETERGENT + BARBED VNR 6 MM</td> <td>1.000</td> <td>PC</td> </tr> <tr> <td>VL1127A1</td> <td>6mm BARBED T-SHAPED FITTING</td> <td>2.000</td> <td>PC</td> </tr> <tr> <td>VL1128A1</td> <td>D6 BARBED CHECK VALVE</td> <td>3.000</td> <td>PC</td> </tr> <tr> <td>VL1166A0</td> <td>BB6-AR6 L FITTING</td> <td>4.000</td> <td>PC</td> </tr> </tbody> </table>	Code	Description	Qty	UOM	0H2354A1	XEVC-XEVL PLUS WASHING CIRCUIT PLAT	1.000	PC	EL1440A0	WATER SELF CLEANING VALVE	4.000	PC	GN1526A0	INT. D.=6.9 TH=1.8 O-RIN	9.000	PC	RC1018A0	ZINC PLATED D12 ELASTIC CLAMP	11.000	PC	RC1019A0	D=10 ELASTIC CLAMP	16.000	PC	RC1130A0	130x2.6 CLAM	1.000	PC	RC1131A0	200x2.6 BLACK CLAMP	3.000	PC	RC1242A0	D=10 CLOSED CAP	2.000	PC	RC1356A0	"STRAIGHT THREADED FEMALE END 8x1/4" BS	1.000	PC	TB2652A0		1.000	PC	TB2677A0		1.000	PC	TB2821A0	EPDM 6X10 L=40MM PIPE	6.000	PC	TB3004A0	TB2820A L=550mm EPDM BLACK PIPE	2.000	PC	TB3024C0		3.000	PC	TB3226A0		1.000	PC	TB3440A0	TB3132A L=1050mm EPDM WHITE-BLUE PIPE	1.000	PC	VL1019A0	VIBRATION DETERGENT PUMP	1.000	PC	VL1047A1	D6 PIPE HOLDER - D8 J.G. TERMINAL	1.000	PC	VL1102A1	DETERGENT + BARBED VNR 6 MM	1.000	PC	VL1127A1	6mm BARBED T-SHAPED FITTING	2.000	PC	VL1128A1	D6 BARBED CHECK VALVE	3.000	PC	VL1166A0	BB6-AR6 L FITTING	4.000	PC
Code	Description	Qty	UOM																																																																																														
0H2354A1	XEVC-XEVL PLUS WASHING CIRCUIT PLAT	1.000	PC																																																																																														
EL1440A0	WATER SELF CLEANING VALVE	4.000	PC																																																																																														
GN1526A0	INT. D.=6.9 TH=1.8 O-RIN	9.000	PC																																																																																														
RC1018A0	ZINC PLATED D12 ELASTIC CLAMP	11.000	PC																																																																																														
RC1019A0	D=10 ELASTIC CLAMP	16.000	PC																																																																																														
RC1130A0	130x2.6 CLAM	1.000	PC																																																																																														
RC1131A0	200x2.6 BLACK CLAMP	3.000	PC																																																																																														
RC1242A0	D=10 CLOSED CAP	2.000	PC																																																																																														
RC1356A0	"STRAIGHT THREADED FEMALE END 8x1/4" BS	1.000	PC																																																																																														
TB2652A0		1.000	PC																																																																																														
TB2677A0		1.000	PC																																																																																														
TB2821A0	EPDM 6X10 L=40MM PIPE	6.000	PC																																																																																														
TB3004A0	TB2820A L=550mm EPDM BLACK PIPE	2.000	PC																																																																																														
TB3024C0		3.000	PC																																																																																														
TB3226A0		1.000	PC																																																																																														
TB3440A0	TB3132A L=1050mm EPDM WHITE-BLUE PIPE	1.000	PC																																																																																														
VL1019A0	VIBRATION DETERGENT PUMP	1.000	PC																																																																																														
VL1047A1	D6 PIPE HOLDER - D8 J.G. TERMINAL	1.000	PC																																																																																														
VL1102A1	DETERGENT + BARBED VNR 6 MM	1.000	PC																																																																																														
VL1127A1	6mm BARBED T-SHAPED FITTING	2.000	PC																																																																																														
VL1128A1	D6 BARBED CHECK VALVE	3.000	PC																																																																																														
VL1166A0	BB6-AR6 L FITTING	4.000	PC																																																																																														

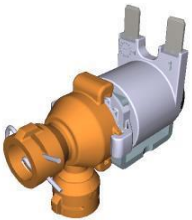
COMPONENT			SPARE PART																																											
Code	Description	Image	Code	Description	Kit components																																									
EL1440A	WATER SELF CLEANING VALVE		KVL1187A	3 ROTOR ARMS PLUS EU CLEANING SYSTEM KIT	<table border="1"> <thead> <tr> <th>Code</th> <th>Description</th> <th>Qty</th> <th>UOM</th> </tr> </thead> <tbody> <tr> <td>VL1167A2</td> <td>GN21 3 ROTOR ARMS B-B FLOW RESTRICTOR</td> <td>1.000</td> <td>PC</td> </tr> <tr> <td>VL1174C0</td> <td>D1.2 MM CALIBRATED D1.2 MM</td> <td>1.000</td> <td>PC</td> </tr> <tr> <td>VL1186A0</td> <td>3 WAYS PLUS WASHING DISTRIBUTOR</td> <td>1.000</td> <td>PC</td> </tr> <tr> <td>VL1190A0</td> <td>PLUS WASHING SYSTEM INLET DISTRIBUTOR</td> <td>1.000</td> <td>PC</td> </tr> <tr> <td>VL1214A0</td> <td>BAYONET - 6mm BARBED NRV VALVE</td> <td>1.000</td> <td>PC</td> </tr> <tr> <td>VL1398A0</td> <td>1/4 M N.O. CIL PRESSURE SWITCH</td> <td>1.000</td> <td>PC</td> </tr> <tr> <td>VM1605A0</td> <td>CLIP TWIST LOCK DIAM. 10,2-12,7 MM</td> <td>3.000</td> <td>PC</td> </tr> <tr> <td>VM2172A0</td> <td>LOCKING CLIP FOR PUMP WITH CIRCUIT</td> <td>5.000</td> <td>PC</td> </tr> </tbody> </table>	Code	Description	Qty	UOM	VL1167A2	GN21 3 ROTOR ARMS B-B FLOW RESTRICTOR	1.000	PC	VL1174C0	D1.2 MM CALIBRATED D1.2 MM	1.000	PC	VL1186A0	3 WAYS PLUS WASHING DISTRIBUTOR	1.000	PC	VL1190A0	PLUS WASHING SYSTEM INLET DISTRIBUTOR	1.000	PC	VL1214A0	BAYONET - 6mm BARBED NRV VALVE	1.000	PC	VL1398A0	1/4 M N.O. CIL PRESSURE SWITCH	1.000	PC	VM1605A0	CLIP TWIST LOCK DIAM. 10,2-12,7 MM	3.000	PC	VM2172A0	LOCKING CLIP FOR PUMP WITH CIRCUIT	5.000	PC					
			Code	Description	Qty	UOM																																								
VL1167A2	GN21 3 ROTOR ARMS B-B FLOW RESTRICTOR	1.000	PC																																											
VL1174C0	D1.2 MM CALIBRATED D1.2 MM	1.000	PC																																											
VL1186A0	3 WAYS PLUS WASHING DISTRIBUTOR	1.000	PC																																											
VL1190A0	PLUS WASHING SYSTEM INLET DISTRIBUTOR	1.000	PC																																											
VL1214A0	BAYONET - 6mm BARBED NRV VALVE	1.000	PC																																											
VL1398A0	1/4 M N.O. CIL PRESSURE SWITCH	1.000	PC																																											
VM1605A0	CLIP TWIST LOCK DIAM. 10,2-12,7 MM	3.000	PC																																											
VM2172A0	LOCKING CLIP FOR PUMP WITH CIRCUIT	5.000	PC																																											
KVL1184A	2 ROTOR ARMS PLUS EU CLEANING SYSTEM KIT	<table border="1"> <thead> <tr> <th>Code</th> <th>Description</th> <th>Qty</th> <th>UOM</th> </tr> </thead> <tbody> <tr> <td>0H2354A1</td> <td>XEVC-XEVL PLUS WASHING CIRCUIT PLAT</td> <td>1.000</td> <td>PC</td> </tr> <tr> <td>EL1440A0</td> <td>WATER SELF CLEANING VALVE</td> <td>4.000</td> <td>PC</td> </tr> <tr> <td>GN1526A0</td> <td>INT. D.=6.9 TH=1.8 O-RIN</td> <td>9.000</td> <td>PC</td> </tr> <tr> <td>RC1018A0</td> <td>ZINC PLATED D12 ELASTIC CLAMP</td> <td>3.000</td> <td>PC</td> </tr> <tr> <td>RC1019A0</td> <td>D=10 ELASTIC CLAMP</td> <td>15.000</td> <td>PC</td> </tr> <tr> <td>RC1130A0</td> <td>130x2,6 CLAM</td> <td>1.000</td> <td>PC</td> </tr> <tr> <td>RC1131A0</td> <td>200x2,6 BLACK CLAMP</td> <td>3.000</td> <td>PC</td> </tr> <tr> <td>RC1242A0</td> <td>D=10 CLOSED CAP</td> <td>2.000</td> <td>PC</td> </tr> <tr> <td>RC1356A0</td> <td>"STRAIGHT THREADED FEMALE END 8x1/4" BS</td> <td>1.000</td> <td>PC</td> </tr> <tr> <td>TB2821A0</td> <td>EPDM 6X10 L=40MM PIPE</td> <td>6.000</td> <td>PC</td> </tr> </tbody> </table>	Code	Description	Qty	UOM	0H2354A1	XEVC-XEVL PLUS WASHING CIRCUIT PLAT	1.000	PC	EL1440A0	WATER SELF CLEANING VALVE	4.000	PC	GN1526A0	INT. D.=6.9 TH=1.8 O-RIN	9.000	PC	RC1018A0	ZINC PLATED D12 ELASTIC CLAMP	3.000	PC	RC1019A0	D=10 ELASTIC CLAMP	15.000	PC	RC1130A0	130x2,6 CLAM	1.000	PC	RC1131A0	200x2,6 BLACK CLAMP	3.000	PC	RC1242A0	D=10 CLOSED CAP	2.000	PC	RC1356A0	"STRAIGHT THREADED FEMALE END 8x1/4" BS	1.000	PC	TB2821A0	EPDM 6X10 L=40MM PIPE	6.000	PC
Code	Description	Qty	UOM																																											
0H2354A1	XEVC-XEVL PLUS WASHING CIRCUIT PLAT	1.000	PC																																											
EL1440A0	WATER SELF CLEANING VALVE	4.000	PC																																											
GN1526A0	INT. D.=6.9 TH=1.8 O-RIN	9.000	PC																																											
RC1018A0	ZINC PLATED D12 ELASTIC CLAMP	3.000	PC																																											
RC1019A0	D=10 ELASTIC CLAMP	15.000	PC																																											
RC1130A0	130x2,6 CLAM	1.000	PC																																											
RC1131A0	200x2,6 BLACK CLAMP	3.000	PC																																											
RC1242A0	D=10 CLOSED CAP	2.000	PC																																											
RC1356A0	"STRAIGHT THREADED FEMALE END 8x1/4" BS	1.000	PC																																											
TB2821A0	EPDM 6X10 L=40MM PIPE	6.000	PC																																											

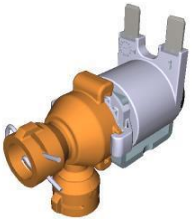
COMPONENT			SPARE PART																																																																											
Code	Description	Image	Code	Description	Kit components																																																																									
EL1440A	WATER SELF CLEANING VALVE		KVL1184A	2 ROTOR ARMS PLUS EU CLEANING SYSTEM KIT	<table border="1"> <thead> <tr> <th>Code</th> <th>Description</th> <th>Qty</th> <th>UOM</th> </tr> </thead> <tbody> <tr> <td>TB2994A0</td> <td>HOOD DETERGENT PIPE</td> <td>1.000</td> <td>PC</td> </tr> <tr> <td>TB3004A0</td> <td>TB2820A L=550mm EPDM BLACK PIPE</td> <td>2.000</td> <td>PC</td> </tr> <tr> <td>TB3005B0</td> <td>TB3132A L=550mm EPDM WHITE-BLUE PIPE</td> <td>1.000</td> <td>PC</td> </tr> <tr> <td>TB3440A0</td> <td>TB3132A L=1050mm EPDM WHITE-BLUE PIPE</td> <td>1.000</td> <td>PC</td> </tr> <tr> <td>VL1019A0</td> <td>VIBRATION DETERGENT PUMP</td> <td>1.000</td> <td>PC</td> </tr> <tr> <td>VL1047A1</td> <td>D6 PIPE HOLDER - D6 J.G. TERMINAL</td> <td>1.000</td> <td>PC</td> </tr> <tr> <td>VL1102A1</td> <td>DETERGENT LINE FILTER + BARBED VNR 6 MM</td> <td>1.000</td> <td>PC</td> </tr> <tr> <td>VL1128A1</td> <td>D6 BARBED CHECK VALVE</td> <td>2.000</td> <td>PC</td> </tr> <tr> <td>VL1141A1</td> <td>BB6-BB6 STRAIGHT CONNECTION</td> <td>1.000</td> <td>PC</td> </tr> <tr> <td>VL1166A0</td> <td>BB6-AR6 L FITTING</td> <td>4.000</td> <td>PC</td> </tr> <tr> <td>VL1174C0</td> <td>D1.2 MM CALIBRATED D1.2 MM</td> <td>1.000</td> <td>PC</td> </tr> <tr> <td>VL1186A0</td> <td>3 WAYS PLUS WASHING DISTRIBUTOR</td> <td>1.000</td> <td>PC</td> </tr> <tr> <td>VL1190A0</td> <td>PLUS WASHING SYSTEM INLET DISTRIBUTOR</td> <td>1.000</td> <td>PC</td> </tr> <tr> <td>VL1214A0</td> <td>BAYONET - 6mm BARBED NRV VALVE</td> <td>1.000</td> <td>PC</td> </tr> <tr> <td>VL1398A0</td> <td>1/4 M N.O. CIL PRESSURE SWITCH</td> <td>1.000</td> <td>PC</td> </tr> <tr> <td>VM1605A0</td> <td>CLIP TWIST LOCK DIAM. 10,2-12,7 MM</td> <td>3.000</td> <td>PC</td> </tr> <tr> <td>VM2172A0</td> <td>LOCKING CLIP FOR PUMP WITH CIRCUIT</td> <td>5.000</td> <td>PC</td> </tr> </tbody> </table>	Code	Description	Qty	UOM	TB2994A0	HOOD DETERGENT PIPE	1.000	PC	TB3004A0	TB2820A L=550mm EPDM BLACK PIPE	2.000	PC	TB3005B0	TB3132A L=550mm EPDM WHITE-BLUE PIPE	1.000	PC	TB3440A0	TB3132A L=1050mm EPDM WHITE-BLUE PIPE	1.000	PC	VL1019A0	VIBRATION DETERGENT PUMP	1.000	PC	VL1047A1	D6 PIPE HOLDER - D6 J.G. TERMINAL	1.000	PC	VL1102A1	DETERGENT LINE FILTER + BARBED VNR 6 MM	1.000	PC	VL1128A1	D6 BARBED CHECK VALVE	2.000	PC	VL1141A1	BB6-BB6 STRAIGHT CONNECTION	1.000	PC	VL1166A0	BB6-AR6 L FITTING	4.000	PC	VL1174C0	D1.2 MM CALIBRATED D1.2 MM	1.000	PC	VL1186A0	3 WAYS PLUS WASHING DISTRIBUTOR	1.000	PC	VL1190A0	PLUS WASHING SYSTEM INLET DISTRIBUTOR	1.000	PC	VL1214A0	BAYONET - 6mm BARBED NRV VALVE	1.000	PC	VL1398A0	1/4 M N.O. CIL PRESSURE SWITCH	1.000	PC	VM1605A0	CLIP TWIST LOCK DIAM. 10,2-12,7 MM	3.000	PC	VM2172A0	LOCKING CLIP FOR PUMP WITH CIRCUIT	5.000	PC	
Code	Description	Qty	UOM																																																																											
TB2994A0	HOOD DETERGENT PIPE	1.000	PC																																																																											
TB3004A0	TB2820A L=550mm EPDM BLACK PIPE	2.000	PC																																																																											
TB3005B0	TB3132A L=550mm EPDM WHITE-BLUE PIPE	1.000	PC																																																																											
TB3440A0	TB3132A L=1050mm EPDM WHITE-BLUE PIPE	1.000	PC																																																																											
VL1019A0	VIBRATION DETERGENT PUMP	1.000	PC																																																																											
VL1047A1	D6 PIPE HOLDER - D6 J.G. TERMINAL	1.000	PC																																																																											
VL1102A1	DETERGENT LINE FILTER + BARBED VNR 6 MM	1.000	PC																																																																											
VL1128A1	D6 BARBED CHECK VALVE	2.000	PC																																																																											
VL1141A1	BB6-BB6 STRAIGHT CONNECTION	1.000	PC																																																																											
VL1166A0	BB6-AR6 L FITTING	4.000	PC																																																																											
VL1174C0	D1.2 MM CALIBRATED D1.2 MM	1.000	PC																																																																											
VL1186A0	3 WAYS PLUS WASHING DISTRIBUTOR	1.000	PC																																																																											
VL1190A0	PLUS WASHING SYSTEM INLET DISTRIBUTOR	1.000	PC																																																																											
VL1214A0	BAYONET - 6mm BARBED NRV VALVE	1.000	PC																																																																											
VL1398A0	1/4 M N.O. CIL PRESSURE SWITCH	1.000	PC																																																																											
VM1605A0	CLIP TWIST LOCK DIAM. 10,2-12,7 MM	3.000	PC																																																																											
VM2172A0	LOCKING CLIP FOR PUMP WITH CIRCUIT	5.000	PC																																																																											

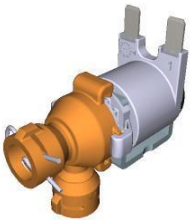

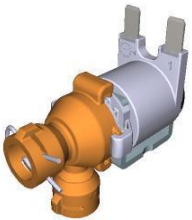

COMPONENT			SPARE PART																																																																																		
Code	Description	Image	Code	Description	Kit components																																																																																
EL1440A	WATER SELF CLEANING VALVE		KVL1183A	1 ROTOR ARM PLUS CLEANING SYSTEM KIT	<table border="1"> <thead> <tr> <th>Code</th> <th>Description</th> <th>Qty</th> <th>UOM</th> </tr> </thead> <tbody> <tr> <td>0H2354A1</td> <td>XEVC-XEVL PLUS WASHING CIRCUIT PLAT</td> <td>1.000</td> <td>PC</td> </tr> <tr> <td>EL1440A0</td> <td>WATER SELF CLEANING VALVE</td> <td>3.000</td> <td>PC</td> </tr> <tr> <td>GN1526A0</td> <td>INT. D.=6.9 TH=1.8 O-RIN</td> <td>7.000</td> <td>PC</td> </tr> <tr> <td>RC1018A0</td> <td>ZINC PLATED D12 ELASTIC CLAMP</td> <td>2.000</td> <td>PC</td> </tr> <tr> <td>RC1019A0</td> <td>D=10 ELASTIC CLAMP</td> <td>14.000</td> <td>PC</td> </tr> <tr> <td>RC1130A0</td> <td>130x2.6 CLAM</td> <td>1.000</td> <td>PC</td> </tr> <tr> <td>RC1131A0</td> <td>200x2.6 BLACK CLAMP</td> <td>2.000</td> <td>PC</td> </tr> <tr> <td>RC1242A0</td> <td>D=10 CLOSED CAP</td> <td>2.000</td> <td>PC</td> </tr> <tr> <td>RC1356A0</td> <td>"STRAIGHT THREADED FEMALE END 8x1/4" BS</td> <td>1.000</td> <td>PC</td> </tr> <tr> <td>TB2821A0</td> <td>EPDM 6X10 L=40MM PIPE</td> <td>6.000</td> <td>PC</td> </tr> <tr> <td>TB3004A0</td> <td>TB2820A L=550mm EPDM BLACK PIPE</td> <td>1.000</td> <td>PC</td> </tr> <tr> <td>TB3005B0</td> <td>TB3132A L=550mm EPDM WHITE-BLUE PIPE</td> <td>1.000</td> <td>PC</td> </tr> <tr> <td>TB3225B0</td> <td>TB2820A-TAN K-WASHYNG SYS CONNECTION</td> <td>1.000</td> <td>PC</td> </tr> <tr> <td>TB3252A0</td> <td></td> <td>1.000</td> <td>PC</td> </tr> <tr> <td>VL1019A0</td> <td>VIBRATION DETERGENT PUMP</td> <td>1.000</td> <td>PC</td> </tr> <tr> <td>VL1047A1</td> <td>D6 PIPE HOLDER - D8 J.G. TERMINAL</td> <td>1.000</td> <td>PC</td> </tr> <tr> <td>VL1102A1</td> <td>DETERGENT LINE FILTER + BARBED VNR 6 MM</td> <td>1.000</td> <td>PC</td> </tr> <tr> <td>VL1128A1</td> <td>D6 BARBED CHECK VALVE</td> <td>2.000</td> <td>PC</td> </tr> <tr> <td>VL1166A0</td> <td>BB6-AR6 L FITTING</td> <td>3.000</td> <td>PC</td> </tr> </tbody> </table>	Code	Description	Qty	UOM	0H2354A1	XEVC-XEVL PLUS WASHING CIRCUIT PLAT	1.000	PC	EL1440A0	WATER SELF CLEANING VALVE	3.000	PC	GN1526A0	INT. D.=6.9 TH=1.8 O-RIN	7.000	PC	RC1018A0	ZINC PLATED D12 ELASTIC CLAMP	2.000	PC	RC1019A0	D=10 ELASTIC CLAMP	14.000	PC	RC1130A0	130x2.6 CLAM	1.000	PC	RC1131A0	200x2.6 BLACK CLAMP	2.000	PC	RC1242A0	D=10 CLOSED CAP	2.000	PC	RC1356A0	"STRAIGHT THREADED FEMALE END 8x1/4" BS	1.000	PC	TB2821A0	EPDM 6X10 L=40MM PIPE	6.000	PC	TB3004A0	TB2820A L=550mm EPDM BLACK PIPE	1.000	PC	TB3005B0	TB3132A L=550mm EPDM WHITE-BLUE PIPE	1.000	PC	TB3225B0	TB2820A-TAN K-WASHYNG SYS CONNECTION	1.000	PC	TB3252A0		1.000	PC	VL1019A0	VIBRATION DETERGENT PUMP	1.000	PC	VL1047A1	D6 PIPE HOLDER - D8 J.G. TERMINAL	1.000	PC	VL1102A1	DETERGENT LINE FILTER + BARBED VNR 6 MM	1.000	PC	VL1128A1	D6 BARBED CHECK VALVE	2.000	PC	VL1166A0	BB6-AR6 L FITTING	3.000	PC
Code	Description	Qty	UOM																																																																																		
0H2354A1	XEVC-XEVL PLUS WASHING CIRCUIT PLAT	1.000	PC																																																																																		
EL1440A0	WATER SELF CLEANING VALVE	3.000	PC																																																																																		
GN1526A0	INT. D.=6.9 TH=1.8 O-RIN	7.000	PC																																																																																		
RC1018A0	ZINC PLATED D12 ELASTIC CLAMP	2.000	PC																																																																																		
RC1019A0	D=10 ELASTIC CLAMP	14.000	PC																																																																																		
RC1130A0	130x2.6 CLAM	1.000	PC																																																																																		
RC1131A0	200x2.6 BLACK CLAMP	2.000	PC																																																																																		
RC1242A0	D=10 CLOSED CAP	2.000	PC																																																																																		
RC1356A0	"STRAIGHT THREADED FEMALE END 8x1/4" BS	1.000	PC																																																																																		
TB2821A0	EPDM 6X10 L=40MM PIPE	6.000	PC																																																																																		
TB3004A0	TB2820A L=550mm EPDM BLACK PIPE	1.000	PC																																																																																		
TB3005B0	TB3132A L=550mm EPDM WHITE-BLUE PIPE	1.000	PC																																																																																		
TB3225B0	TB2820A-TAN K-WASHYNG SYS CONNECTION	1.000	PC																																																																																		
TB3252A0		1.000	PC																																																																																		
VL1019A0	VIBRATION DETERGENT PUMP	1.000	PC																																																																																		
VL1047A1	D6 PIPE HOLDER - D8 J.G. TERMINAL	1.000	PC																																																																																		
VL1102A1	DETERGENT LINE FILTER + BARBED VNR 6 MM	1.000	PC																																																																																		
VL1128A1	D6 BARBED CHECK VALVE	2.000	PC																																																																																		
VL1166A0	BB6-AR6 L FITTING	3.000	PC																																																																																		

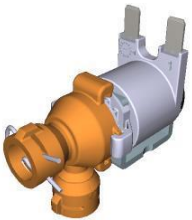
COMPONENT			SPARE PART																																											
Code	Description	Image	Code	Description	Kit components																																									
EL1440A	WATER SELF CLEANING VALVE		KVL1183A	1 ROTOR ARM PLUS CLEANING SYSTEM KIT	<table border="1"> <thead> <tr> <th>Code</th> <th>Description</th> <th>Qty</th> <th>UOM</th> </tr> </thead> <tbody> <tr> <td>VL1174C0</td> <td>D1.2 MM CALIBRATED D1.2 MM</td> <td>1.000</td> <td>PC</td> </tr> <tr> <td>VL1185A0</td> <td>2 WAYS PLUS WASHING DISTRIBUTOR</td> <td>1.000</td> <td>PC</td> </tr> <tr> <td>VL1190A0</td> <td>PLUS WASHING SYSTEM INLET DISTRIBUTOR</td> <td>1.000</td> <td>PC</td> </tr> <tr> <td>VL1214A0</td> <td>BAYONET - 6mm BARBED NRV VALVE</td> <td>1.000</td> <td>PC</td> </tr> <tr> <td>VL1398A0</td> <td>1/4 M N.O. CIL PRESSURE SWITCH</td> <td>1.000</td> <td>PC</td> </tr> <tr> <td>VM1605A0</td> <td>CLIP TWIST LOCK DIAM. 10,2-12,7 MM</td> <td>3.000</td> <td>PC</td> </tr> <tr> <td>VM2172A0</td> <td>LOCKING CLIP FOR PUMP WITH CIRCUIT</td> <td>4.000</td> <td>PC</td> </tr> </tbody> </table>	Code	Description	Qty	UOM	VL1174C0	D1.2 MM CALIBRATED D1.2 MM	1.000	PC	VL1185A0	2 WAYS PLUS WASHING DISTRIBUTOR	1.000	PC	VL1190A0	PLUS WASHING SYSTEM INLET DISTRIBUTOR	1.000	PC	VL1214A0	BAYONET - 6mm BARBED NRV VALVE	1.000	PC	VL1398A0	1/4 M N.O. CIL PRESSURE SWITCH	1.000	PC	VM1605A0	CLIP TWIST LOCK DIAM. 10,2-12,7 MM	3.000	PC	VM2172A0	LOCKING CLIP FOR PUMP WITH CIRCUIT	4.000	PC									
			Code	Description	Qty	UOM																																								
VL1174C0	D1.2 MM CALIBRATED D1.2 MM	1.000	PC																																											
VL1185A0	2 WAYS PLUS WASHING DISTRIBUTOR	1.000	PC																																											
VL1190A0	PLUS WASHING SYSTEM INLET DISTRIBUTOR	1.000	PC																																											
VL1214A0	BAYONET - 6mm BARBED NRV VALVE	1.000	PC																																											
VL1398A0	1/4 M N.O. CIL PRESSURE SWITCH	1.000	PC																																											
VM1605A0	CLIP TWIST LOCK DIAM. 10,2-12,7 MM	3.000	PC																																											
VM2172A0	LOCKING CLIP FOR PUMP WITH CIRCUIT	4.000	PC																																											
KVL1182A	ONE 1ROT CLEANING SYSTEM KIT (0311 EXC.)	<table border="1"> <thead> <tr> <th>Code</th> <th>Description</th> <th>Qty</th> <th>UOM</th> </tr> </thead> <tbody> <tr> <td>0H2202A1</td> <td>ONE WASHING WITH STEAM VALVE SUPPORT</td> <td>1.000</td> <td>PC</td> </tr> <tr> <td>EL1440A0</td> <td>WATER SELF CLEANING VALVE</td> <td>1.000</td> <td>PC</td> </tr> <tr> <td>GN1526A0</td> <td>INT. D.=6.9 TH=1.8 O-RIN</td> <td>3.000</td> <td>PC</td> </tr> <tr> <td>RC1018A0</td> <td>ZINC PLATED D12 ELASTIC CLAMP</td> <td>1.000</td> <td>PC</td> </tr> <tr> <td>RC1019A0</td> <td>D=10 ELASTIC CLAMP</td> <td>14.000</td> <td>PC</td> </tr> <tr> <td>RC1130A0</td> <td>130x2,6 CLAM</td> <td>2.000</td> <td>PC</td> </tr> <tr> <td>RC1242A0</td> <td>D=10 CLOSED CAP</td> <td>2.000</td> <td>PC</td> </tr> <tr> <td>TB2821A0</td> <td>EPDM 6X10 L=40MM PIPE</td> <td>6.000</td> <td>PC</td> </tr> <tr> <td>TB3004A0</td> <td>TB2820A L=550mm EPDM BLACK PIPE</td> <td>1.000</td> <td>PC</td> </tr> <tr> <td>TB3009B0</td> <td>TB3132A-ONE OVEN WASHING INLET</td> <td>1.000</td> <td>PC</td> </tr> </tbody> </table>	Code	Description	Qty	UOM	0H2202A1	ONE WASHING WITH STEAM VALVE SUPPORT	1.000	PC	EL1440A0	WATER SELF CLEANING VALVE	1.000	PC	GN1526A0	INT. D.=6.9 TH=1.8 O-RIN	3.000	PC	RC1018A0	ZINC PLATED D12 ELASTIC CLAMP	1.000	PC	RC1019A0	D=10 ELASTIC CLAMP	14.000	PC	RC1130A0	130x2,6 CLAM	2.000	PC	RC1242A0	D=10 CLOSED CAP	2.000	PC	TB2821A0	EPDM 6X10 L=40MM PIPE	6.000	PC	TB3004A0	TB2820A L=550mm EPDM BLACK PIPE	1.000	PC	TB3009B0	TB3132A-ONE OVEN WASHING INLET	1.000	PC
Code	Description	Qty	UOM																																											
0H2202A1	ONE WASHING WITH STEAM VALVE SUPPORT	1.000	PC																																											
EL1440A0	WATER SELF CLEANING VALVE	1.000	PC																																											
GN1526A0	INT. D.=6.9 TH=1.8 O-RIN	3.000	PC																																											
RC1018A0	ZINC PLATED D12 ELASTIC CLAMP	1.000	PC																																											
RC1019A0	D=10 ELASTIC CLAMP	14.000	PC																																											
RC1130A0	130x2,6 CLAM	2.000	PC																																											
RC1242A0	D=10 CLOSED CAP	2.000	PC																																											
TB2821A0	EPDM 6X10 L=40MM PIPE	6.000	PC																																											
TB3004A0	TB2820A L=550mm EPDM BLACK PIPE	1.000	PC																																											
TB3009B0	TB3132A-ONE OVEN WASHING INLET	1.000	PC																																											



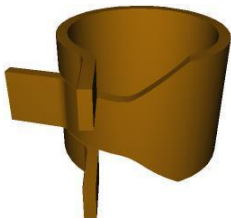

COMPONENT			SPARE PART																																																						
Code	Description	Image	Code	Description	Kit components																																																				
EL1440A	WATER SELF CLEANING VALVE		KVL1182A	ONE 1ROT CLEANING SYSTEM KIT (0311 EXC.)	<table border="1"> <thead> <tr> <th>Code</th> <th>Description</th> <th>Qty</th> <th>UOM</th> </tr> </thead> <tbody> <tr> <td>TB3225B0</td> <td>TB2820A-TAN K-WASHYNG SYS CONNECTION</td> <td>1.000</td> <td>PC</td> </tr> <tr> <td>V11220A1</td> <td>4,2x12 TCB SELF-TAPPIN G SCREW</td> <td>1.000</td> <td>PC</td> </tr> <tr> <td>VL1019A0</td> <td>VIBRATION DETERGENT PUMP</td> <td>1.000</td> <td>PC</td> </tr> <tr> <td>VL1047A1</td> <td>D6 PIPE HOLDER - D8 J.G. TERMINAL</td> <td>1.000</td> <td>PC</td> </tr> <tr> <td>VL1054B0</td> <td>ONE WASHING SYS INLET DISTRIBUTOR</td> <td>1.000</td> <td>PC</td> </tr> <tr> <td>VL1102A1</td> <td>DETERGENT LINE FILTER + BARBED VNR 6 MM</td> <td>1.000</td> <td>PC</td> </tr> <tr> <td>VL1128A1</td> <td>D6 BARBED CHECK VALVE</td> <td>2.000</td> <td>PC</td> </tr> <tr> <td>VL1166A0</td> <td>BB6-AR6 L FITTING</td> <td>1.000</td> <td>PC</td> </tr> <tr> <td>VL1174C0</td> <td>D1.2 MM CALIBRATED D1.2 MM</td> <td>1.000</td> <td>PC</td> </tr> <tr> <td>VL1191A0</td> <td>ONE WASHING DISTRIBUTOR OUTLETS KIT</td> <td>1.000</td> <td>PC</td> </tr> <tr> <td>VL1214A0</td> <td>BAYONET - 6mm BARBED NRV VALVE</td> <td>1.000</td> <td>PC</td> </tr> <tr> <td>VM2172A0</td> <td>LOCKING CLIP FOR PUMP WITH CIRCUIT</td> <td>2.000</td> <td>PC</td> </tr> </tbody> </table>	Code	Description	Qty	UOM	TB3225B0	TB2820A-TAN K-WASHYNG SYS CONNECTION	1.000	PC	V11220A1	4,2x12 TCB SELF-TAPPIN G SCREW	1.000	PC	VL1019A0	VIBRATION DETERGENT PUMP	1.000	PC	VL1047A1	D6 PIPE HOLDER - D8 J.G. TERMINAL	1.000	PC	VL1054B0	ONE WASHING SYS INLET DISTRIBUTOR	1.000	PC	VL1102A1	DETERGENT LINE FILTER + BARBED VNR 6 MM	1.000	PC	VL1128A1	D6 BARBED CHECK VALVE	2.000	PC	VL1166A0	BB6-AR6 L FITTING	1.000	PC	VL1174C0	D1.2 MM CALIBRATED D1.2 MM	1.000	PC	VL1191A0	ONE WASHING DISTRIBUTOR OUTLETS KIT	1.000	PC	VL1214A0	BAYONET - 6mm BARBED NRV VALVE	1.000	PC	VM2172A0	LOCKING CLIP FOR PUMP WITH CIRCUIT	2.000	PC
			Code	Description	Qty	UOM																																																			
TB3225B0	TB2820A-TAN K-WASHYNG SYS CONNECTION	1.000	PC																																																						
V11220A1	4,2x12 TCB SELF-TAPPIN G SCREW	1.000	PC																																																						
VL1019A0	VIBRATION DETERGENT PUMP	1.000	PC																																																						
VL1047A1	D6 PIPE HOLDER - D8 J.G. TERMINAL	1.000	PC																																																						
VL1054B0	ONE WASHING SYS INLET DISTRIBUTOR	1.000	PC																																																						
VL1102A1	DETERGENT LINE FILTER + BARBED VNR 6 MM	1.000	PC																																																						
VL1128A1	D6 BARBED CHECK VALVE	2.000	PC																																																						
VL1166A0	BB6-AR6 L FITTING	1.000	PC																																																						
VL1174C0	D1.2 MM CALIBRATED D1.2 MM	1.000	PC																																																						
VL1191A0	ONE WASHING DISTRIBUTOR OUTLETS KIT	1.000	PC																																																						
VL1214A0	BAYONET - 6mm BARBED NRV VALVE	1.000	PC																																																						
VM2172A0	LOCKING CLIP FOR PUMP WITH CIRCUIT	2.000	PC																																																						
KEL1440A	SELF CLEANING WATER VALVE KIT	<table border="1"> <thead> <tr> <th>Code</th> <th>Description</th> <th>Qty</th> <th>UOM</th> </tr> </thead> <tbody> <tr> <td>EL1440A0</td> <td>WATER SELF CLEANING VALVE</td> <td>1.000</td> <td>PC</td> </tr> <tr> <td>GN1526A0</td> <td>INT. D.=6.9 TH=1.8 O-RIN</td> <td>2.000</td> <td>PC</td> </tr> <tr> <td>RC1131A0</td> <td>200x2.6 BLACK CLAMP</td> <td>1.000</td> <td>PC</td> </tr> <tr> <td>VM2172A0</td> <td>LOCKING CLIP FOR PUMP WITH CIRCUIT</td> <td>1.000</td> <td>PC</td> </tr> </tbody> </table>	Code	Description	Qty	UOM	EL1440A0	WATER SELF CLEANING VALVE	1.000	PC	GN1526A0	INT. D.=6.9 TH=1.8 O-RIN	2.000	PC	RC1131A0	200x2.6 BLACK CLAMP	1.000	PC	VM2172A0	LOCKING CLIP FOR PUMP WITH CIRCUIT	1.000	PC																																			
Code	Description	Qty	UOM																																																						
EL1440A0	WATER SELF CLEANING VALVE	1.000	PC																																																						
GN1526A0	INT. D.=6.9 TH=1.8 O-RIN	2.000	PC																																																						
RC1131A0	200x2.6 BLACK CLAMP	1.000	PC																																																						
VM2172A0	LOCKING CLIP FOR PUMP WITH CIRCUIT	1.000	PC																																																						



COMPONENT			SPARE PART														
Code	Description	Image	Code	Description	Kit components												
GN1526A	INT. D.=6.9 TH=1.8 O-RING		KG1526A	O-RING INT D6.9 THICK1.8 10PCS KIT	<table border="1"> <thead> <tr> <th>Code</th> <th>Description</th> <th>Qty</th> <th>UOM</th> </tr> </thead> <tbody> <tr> <td>GN1526A0</td> <td>INT. D.=6.9 TH=1.8 O-RIN</td> <td>10.000</td> <td>PC</td> </tr> </tbody> </table>	Code	Description	Qty	UOM	GN1526A0	INT. D.=6.9 TH=1.8 O-RIN	10.000	PC				
Code	Description	Qty	UOM														
GN1526A0	INT. D.=6.9 TH=1.8 O-RIN	10.000	PC														
RC1019A	D=10 ELASTIC CLAM		KRC1019A	Ø10 ZINC PLATED ELASTIC CLAMP 15 PCS KIT	<table border="1"> <thead> <tr> <th>Code</th> <th>Description</th> <th>Qty</th> <th>UOM</th> </tr> </thead> <tbody> <tr> <td>RC1019A0</td> <td>D=10 ELASTIC CLAMP</td> <td>15.000</td> <td>PC</td> </tr> </tbody> </table>	Code	Description	Qty	UOM	RC1019A0	D=10 ELASTIC CLAMP	15.000	PC				
Code	Description	Qty	UOM														
RC1019A0	D=10 ELASTIC CLAMP	15.000	PC														
TB3004A	TB2820A L=550mm EPDM BLACK PIPE		KT1343A	TB2820A0 6x10 EPM DETERGENT PIPE 3M KIT	<table border="1"> <thead> <tr> <th>Code</th> <th>Description</th> <th>Qty</th> <th>UOM</th> </tr> </thead> <tbody> <tr> <td>TB2820A0</td> <td>6X10 EPDM PIPE FOR WASHING SYSTEM</td> <td>3.000</td> <td>M</td> </tr> </tbody> </table>	Code	Description	Qty	UOM	TB2820A0	6X10 EPDM PIPE FOR WASHING SYSTEM	3.000	M				
Code	Description	Qty	UOM														
TB2820A0	6X10 EPDM PIPE FOR WASHING SYSTEM	3.000	M														
TB3009B	TB3132A-ONE OVEN WASHING INLET		KT13132A	WHITE-BLU 6X12 REINFORCED PIPE 3M KIT	<table border="1"> <thead> <tr> <th>Code</th> <th>Description</th> <th>Qty</th> <th>UOM</th> </tr> </thead> <tbody> <tr> <td>TB3132A0</td> <td>WHITE-BLUE EPDM TEXTILE BRAID HOSE 6x12</td> <td>3.000</td> <td>M</td> </tr> <tr> <td>VM1794A0</td> <td>250x4.8 PA66 BLACK CLAMP</td> <td>1.000</td> <td>PC</td> </tr> </tbody> </table>	Code	Description	Qty	UOM	TB3132A0	WHITE-BLUE EPDM TEXTILE BRAID HOSE 6x12	3.000	M	VM1794A0	250x4.8 PA66 BLACK CLAMP	1.000	PC
Code	Description	Qty	UOM														
TB3132A0	WHITE-BLUE EPDM TEXTILE BRAID HOSE 6x12	3.000	M														
VM1794A0	250x4.8 PA66 BLACK CLAMP	1.000	PC														
TB3225B	TB2820A-TANK-WAS HYNG SYS CONNECTION		KT1343A	TB2820A0 6x10 EPM DETERGENT PIPE 3M KIT	<table border="1"> <thead> <tr> <th>Code</th> <th>Description</th> <th>Qty</th> <th>UOM</th> </tr> </thead> <tbody> <tr> <td>TB2820A0</td> <td>6X10 EPDM PIPE FOR WASHING SYSTEM</td> <td>3.000</td> <td>M</td> </tr> </tbody> </table>	Code	Description	Qty	UOM	TB2820A0	6X10 EPDM PIPE FOR WASHING SYSTEM	3.000	M				
Code	Description	Qty	UOM														
TB2820A0	6X10 EPDM PIPE FOR WASHING SYSTEM	3.000	M														





COMPONENT			SPARE PART																																																																		
Code	Description	Image	Code	Description	Kit components																																																																
VL1102A	DETERGENT LINE FILTER + BARBED VNR 6 MM		KVL1102A	DETERGENT FILTER + NRV KIT	<table border="1"> <thead> <tr> <th>Code</th> <th>Description</th> <th>Qty</th> <th>UOM</th> </tr> </thead> <tbody> <tr> <td>RC1019A0</td> <td>D=10 ELASTIC CLAMP</td> <td>5.000</td> <td>PC</td> </tr> <tr> <td>TB2820A0</td> <td>6X10 EPDM PIPE FOR WASHING SYSTEM</td> <td>0.040</td> <td>M</td> </tr> <tr> <td>VL1102A1</td> <td>DETERGENT LINE FILTER + BARBED VNR 6 MM</td> <td>1.000</td> <td>PC</td> </tr> </tbody> </table>	Code	Description	Qty	UOM	RC1019A0	D=10 ELASTIC CLAMP	5.000	PC	TB2820A0	6X10 EPDM PIPE FOR WASHING SYSTEM	0.040	M	VL1102A1	DETERGENT LINE FILTER + BARBED VNR 6 MM	1.000	PC																																																
Code	Description	Qty	UOM																																																																		
RC1019A0	D=10 ELASTIC CLAMP	5.000	PC																																																																		
TB2820A0	6X10 EPDM PIPE FOR WASHING SYSTEM	0.040	M																																																																		
VL1102A1	DETERGENT LINE FILTER + BARBED VNR 6 MM	1.000	PC																																																																		
VL1166A	BB6-AR6 L FITTING		KVL2618A	2 ROTOR ARMS ONE CLEANING SYSTEM KIT	<table border="1"> <thead> <tr> <th>Code</th> <th>Description</th> <th>Qty</th> <th>UOM</th> </tr> </thead> <tbody> <tr> <td>0H2202A1</td> <td>ONE WASHING WITH STEAM VALVE SUPPORT</td> <td>2.000</td> <td>PC</td> </tr> <tr> <td>CE1030A0</td> <td>FEMALE FASTON COVER 6.3X0.8 0,5-1mmq</td> <td>4.000</td> <td>PC</td> </tr> <tr> <td>CE1395A0</td> <td>6,3 X 0,8 MALE FASTO</td> <td>2.000</td> <td>PC</td> </tr> <tr> <td>CE1545A0</td> <td>BLUE UNIP AWG18 ST.3135 WIRE</td> <td>2.000</td> <td>M</td> </tr> <tr> <td>CE1570A0</td> <td>WHITE UNIP AWG18 ST.3135 WIRE</td> <td>2.000</td> <td>M</td> </tr> <tr> <td>CE1660A0</td> <td>6,3x0,8 FEMALE FASTON COVE</td> <td>4.000</td> <td>PC</td> </tr> <tr> <td>CE1661A0</td> <td>MALE FASTON COVER 6,3x0,8</td> <td>2.000</td> <td>PC</td> </tr> <tr> <td>EL1020A1</td> <td>D8 INTERMEDIAT E T-SHAPED FITTING</td> <td>1.000</td> <td>PC</td> </tr> <tr> <td>EL1440A0</td> <td>WATER SELF CLEANING VALVE</td> <td>2.000</td> <td>PC</td> </tr> <tr> <td>GN1526A0</td> <td>INT. D.=6.9 TH=1.8 O-RIN</td> <td>6.000</td> <td>PC</td> </tr> <tr> <td>RC1018A0</td> <td>ZINC PLATED D12 ELASTIC CLAMP</td> <td>2.000</td> <td>PC</td> </tr> <tr> <td>RC1019A0</td> <td>D=10 ELASTIC CLAMP</td> <td>28.000</td> <td>PC</td> </tr> <tr> <td>RC1130A0</td> <td>130x2,6 CLAM</td> <td>4.000</td> <td>PC</td> </tr> <tr> <td>RC1242A0</td> <td>D=10 CLOSED CAP</td> <td>4.000</td> <td>PC</td> </tr> <tr> <td>TB2821A0</td> <td>EPDM 6X10 L=40MM PIPE</td> <td>12.000</td> <td>PC</td> </tr> </tbody> </table>	Code	Description	Qty	UOM	0H2202A1	ONE WASHING WITH STEAM VALVE SUPPORT	2.000	PC	CE1030A0	FEMALE FASTON COVER 6.3X0.8 0,5-1mmq	4.000	PC	CE1395A0	6,3 X 0,8 MALE FASTO	2.000	PC	CE1545A0	BLUE UNIP AWG18 ST.3135 WIRE	2.000	M	CE1570A0	WHITE UNIP AWG18 ST.3135 WIRE	2.000	M	CE1660A0	6,3x0,8 FEMALE FASTON COVE	4.000	PC	CE1661A0	MALE FASTON COVER 6,3x0,8	2.000	PC	EL1020A1	D8 INTERMEDIAT E T-SHAPED FITTING	1.000	PC	EL1440A0	WATER SELF CLEANING VALVE	2.000	PC	GN1526A0	INT. D.=6.9 TH=1.8 O-RIN	6.000	PC	RC1018A0	ZINC PLATED D12 ELASTIC CLAMP	2.000	PC	RC1019A0	D=10 ELASTIC CLAMP	28.000	PC	RC1130A0	130x2,6 CLAM	4.000	PC	RC1242A0	D=10 CLOSED CAP	4.000	PC	TB2821A0	EPDM 6X10 L=40MM PIPE	12.000	PC
Code	Description	Qty	UOM																																																																		
0H2202A1	ONE WASHING WITH STEAM VALVE SUPPORT	2.000	PC																																																																		
CE1030A0	FEMALE FASTON COVER 6.3X0.8 0,5-1mmq	4.000	PC																																																																		
CE1395A0	6,3 X 0,8 MALE FASTO	2.000	PC																																																																		
CE1545A0	BLUE UNIP AWG18 ST.3135 WIRE	2.000	M																																																																		
CE1570A0	WHITE UNIP AWG18 ST.3135 WIRE	2.000	M																																																																		
CE1660A0	6,3x0,8 FEMALE FASTON COVE	4.000	PC																																																																		
CE1661A0	MALE FASTON COVER 6,3x0,8	2.000	PC																																																																		
EL1020A1	D8 INTERMEDIAT E T-SHAPED FITTING	1.000	PC																																																																		
EL1440A0	WATER SELF CLEANING VALVE	2.000	PC																																																																		
GN1526A0	INT. D.=6.9 TH=1.8 O-RIN	6.000	PC																																																																		
RC1018A0	ZINC PLATED D12 ELASTIC CLAMP	2.000	PC																																																																		
RC1019A0	D=10 ELASTIC CLAMP	28.000	PC																																																																		
RC1130A0	130x2,6 CLAM	4.000	PC																																																																		
RC1242A0	D=10 CLOSED CAP	4.000	PC																																																																		
TB2821A0	EPDM 6X10 L=40MM PIPE	12.000	PC																																																																		



COMPONENT			SPARE PART																																																																		
Code	Description	Image	Code	Description	Kit components																																																																
VL1166A	BB6-AR6 L FITTING		KVL2618A	2 ROTOR ARMS ONE CLEANING SYSTEM KIT	<table border="1"> <thead> <tr> <th>Code</th> <th>Description</th> <th>Qty</th> <th>UOM</th> </tr> </thead> <tbody> <tr> <td>TB3004A0</td> <td>TB2820A L=550mm EPDM BLACK PIPE</td> <td>2.000</td> <td>PC</td> </tr> <tr> <td>TB3009B0</td> <td>TB3132A-ONE OVEN WASHING INLET</td> <td>2.000</td> <td>PC</td> </tr> <tr> <td>TB3225B0</td> <td>TB2820A-TAN K-WASHYNG SYS CONNECTION</td> <td>2.000</td> <td>PC</td> </tr> <tr> <td>VI1220A1</td> <td>4,2x12 TCB SELF-TAPPIN G SCREW</td> <td>2.000</td> <td>PC</td> </tr> <tr> <td>VL1019A0</td> <td>VIBRATION DETERGENT PUMP</td> <td>2.000</td> <td>PC</td> </tr> <tr> <td>VL1047A1</td> <td>D6 PIPE HOLDER - D6 J.G. TERMINAL</td> <td>2.000</td> <td>PC</td> </tr> <tr> <td>VL1054B0</td> <td>ONE WASHING SYS INLET DISTRIBUTOR</td> <td>2.000</td> <td>PC</td> </tr> <tr> <td>VL1102A1</td> <td>DETERGENT LINE FILTER + BARBED VNR 6 MM</td> <td>2.000</td> <td>PC</td> </tr> <tr> <td>VL1127A1</td> <td>6mm BARBED T-SHAPED FITTING</td> <td>1.000</td> <td>PC</td> </tr> <tr> <td>VL1128A1</td> <td>D6 BARBED CHECK VALVE</td> <td>4.000</td> <td>PC</td> </tr> <tr> <td>VL1166A0</td> <td>BB6-AR6 L FITTING</td> <td>2.000</td> <td>PC</td> </tr> <tr> <td>VL1174C0</td> <td>D1.2 MM CALIBRATED D1.2 MM</td> <td>2.000</td> <td>PC</td> </tr> <tr> <td>VL1191A0</td> <td>ONE WASHING DISTRIBUTOR OUTLETS KIT</td> <td>2.000</td> <td>PC</td> </tr> <tr> <td>VL1214A0</td> <td>BAYONET - 6mm BARBED NRV VALVE</td> <td>2.000</td> <td>PC</td> </tr> <tr> <td>VM2172A0</td> <td>LOCKING CLIP FOR PUMP WITH CIRCUIT</td> <td>4.000</td> <td>PC</td> </tr> </tbody> </table>	Code	Description	Qty	UOM	TB3004A0	TB2820A L=550mm EPDM BLACK PIPE	2.000	PC	TB3009B0	TB3132A-ONE OVEN WASHING INLET	2.000	PC	TB3225B0	TB2820A-TAN K-WASHYNG SYS CONNECTION	2.000	PC	VI1220A1	4,2x12 TCB SELF-TAPPIN G SCREW	2.000	PC	VL1019A0	VIBRATION DETERGENT PUMP	2.000	PC	VL1047A1	D6 PIPE HOLDER - D6 J.G. TERMINAL	2.000	PC	VL1054B0	ONE WASHING SYS INLET DISTRIBUTOR	2.000	PC	VL1102A1	DETERGENT LINE FILTER + BARBED VNR 6 MM	2.000	PC	VL1127A1	6mm BARBED T-SHAPED FITTING	1.000	PC	VL1128A1	D6 BARBED CHECK VALVE	4.000	PC	VL1166A0	BB6-AR6 L FITTING	2.000	PC	VL1174C0	D1.2 MM CALIBRATED D1.2 MM	2.000	PC	VL1191A0	ONE WASHING DISTRIBUTOR OUTLETS KIT	2.000	PC	VL1214A0	BAYONET - 6mm BARBED NRV VALVE	2.000	PC	VM2172A0	LOCKING CLIP FOR PUMP WITH CIRCUIT	4.000	PC
Code	Description	Qty	UOM																																																																		
TB3004A0	TB2820A L=550mm EPDM BLACK PIPE	2.000	PC																																																																		
TB3009B0	TB3132A-ONE OVEN WASHING INLET	2.000	PC																																																																		
TB3225B0	TB2820A-TAN K-WASHYNG SYS CONNECTION	2.000	PC																																																																		
VI1220A1	4,2x12 TCB SELF-TAPPIN G SCREW	2.000	PC																																																																		
VL1019A0	VIBRATION DETERGENT PUMP	2.000	PC																																																																		
VL1047A1	D6 PIPE HOLDER - D6 J.G. TERMINAL	2.000	PC																																																																		
VL1054B0	ONE WASHING SYS INLET DISTRIBUTOR	2.000	PC																																																																		
VL1102A1	DETERGENT LINE FILTER + BARBED VNR 6 MM	2.000	PC																																																																		
VL1127A1	6mm BARBED T-SHAPED FITTING	1.000	PC																																																																		
VL1128A1	D6 BARBED CHECK VALVE	4.000	PC																																																																		
VL1166A0	BB6-AR6 L FITTING	2.000	PC																																																																		
VL1174C0	D1.2 MM CALIBRATED D1.2 MM	2.000	PC																																																																		
VL1191A0	ONE WASHING DISTRIBUTOR OUTLETS KIT	2.000	PC																																																																		
VL1214A0	BAYONET - 6mm BARBED NRV VALVE	2.000	PC																																																																		
VM2172A0	LOCKING CLIP FOR PUMP WITH CIRCUIT	4.000	PC																																																																		
			KVL1225A	US HOOD WASHING SYSTEM KIT	<table border="1"> <thead> <tr> <th>Code</th> <th>Description</th> <th>Qty</th> <th>UOM</th> </tr> </thead> <tbody> <tr> <td>0H2213A1</td> <td>HOOD WATER CIRCUIT PLAT</td> <td>1.000</td> <td>PC</td> </tr> </tbody> </table>	Code	Description	Qty	UOM	0H2213A1	HOOD WATER CIRCUIT PLAT	1.000	PC																																																								
Code	Description	Qty	UOM																																																																		
0H2213A1	HOOD WATER CIRCUIT PLAT	1.000	PC																																																																		



COMPONENT			SPARE PART																																																																																						
Code	Description	Image	Code	Description	Kit components																																																																																				
VL1166A	BB6-AR6 L FITTING		KVL1225A	US HOOD WASHING SYSTEM KIT	<table border="1"> <thead> <tr> <th>Code</th> <th>Description</th> <th>Qty</th> <th>UOM</th> </tr> </thead> <tbody> <tr> <td>EL1450A0</td> <td>US SELF-CLEANIN G WATER SOLENOID</td> <td>2.000</td> <td>PC</td> </tr> <tr> <td>GN1526A0</td> <td>INT. D.=6.9 TH=1.8 O-RIN</td> <td>5.000</td> <td>PC</td> </tr> <tr> <td>RC1018A0</td> <td>ZINC PLATED D12 ELASTIC CLAMP</td> <td>4.000</td> <td>PC</td> </tr> <tr> <td>RC1019A0</td> <td>D=10 ELASTIC CLAMP</td> <td>16.000</td> <td>PC</td> </tr> <tr> <td>RC1131A0</td> <td>200x2.6 BLACK CLAMP</td> <td>1.000</td> <td>PC</td> </tr> <tr> <td>RC1242A0</td> <td>D=10 CLOSED CAP</td> <td>2.000</td> <td>PC</td> </tr> <tr> <td>TB2821A0</td> <td>EPDM 6X10 L=40MM PIPE</td> <td>6.000</td> <td>PC</td> </tr> <tr> <td>TB2994A0</td> <td>HOOD DETERGENT PIPE</td> <td>2.000</td> <td>PC</td> </tr> <tr> <td>TB3252A0</td> <td></td> <td>2.000</td> <td>PC</td> </tr> <tr> <td>VI1220A1</td> <td>4,2x12 TCB SELF-TAPPIN G SCREW</td> <td>3.000</td> <td>PC</td> </tr> <tr> <td>VL1019A0</td> <td>VIBRATION DETERGENT PUMP</td> <td>1.000</td> <td>PC</td> </tr> <tr> <td>VL1047A1</td> <td>D6 PIPE HOLDER - D8 J.G. TERMINAL</td> <td>1.000</td> <td>PC</td> </tr> <tr> <td>VL1054B0</td> <td>ONE WASHING SYS INLET DISTRIBUTOR</td> <td>1.000</td> <td>PC</td> </tr> <tr> <td>VL1102A1</td> <td>DETERGENT LINE FILTER + BARBED VNR 6 MM</td> <td>1.000</td> <td>PC</td> </tr> <tr> <td>VL1127A1</td> <td>6mm BARBED T-SHAPED FITTING</td> <td>1.000</td> <td>PC</td> </tr> <tr> <td>VL1128A1</td> <td>D6 BARBED CHECK VALVE</td> <td>2.000</td> <td>PC</td> </tr> <tr> <td>VL1165A0</td> <td>BAM-BB6 STRAIGHT FITTING</td> <td>1.000</td> <td>PC</td> </tr> <tr> <td>VL1166A0</td> <td>BB6-AR6 L FITTING</td> <td>2.000</td> <td>PC</td> </tr> <tr> <td>VL1174C0</td> <td>D1.2 MM CALIBRATED D1.2 MM</td> <td>1.000</td> <td>PC</td> </tr> <tr> <td>VL1191A0</td> <td>ONE WASHING DISTRIBUTOR OUTLETS KIT</td> <td>1.000</td> <td>PC</td> </tr> </tbody> </table>	Code	Description	Qty	UOM	EL1450A0	US SELF-CLEANIN G WATER SOLENOID	2.000	PC	GN1526A0	INT. D.=6.9 TH=1.8 O-RIN	5.000	PC	RC1018A0	ZINC PLATED D12 ELASTIC CLAMP	4.000	PC	RC1019A0	D=10 ELASTIC CLAMP	16.000	PC	RC1131A0	200x2.6 BLACK CLAMP	1.000	PC	RC1242A0	D=10 CLOSED CAP	2.000	PC	TB2821A0	EPDM 6X10 L=40MM PIPE	6.000	PC	TB2994A0	HOOD DETERGENT PIPE	2.000	PC	TB3252A0		2.000	PC	VI1220A1	4,2x12 TCB SELF-TAPPIN G SCREW	3.000	PC	VL1019A0	VIBRATION DETERGENT PUMP	1.000	PC	VL1047A1	D6 PIPE HOLDER - D8 J.G. TERMINAL	1.000	PC	VL1054B0	ONE WASHING SYS INLET DISTRIBUTOR	1.000	PC	VL1102A1	DETERGENT LINE FILTER + BARBED VNR 6 MM	1.000	PC	VL1127A1	6mm BARBED T-SHAPED FITTING	1.000	PC	VL1128A1	D6 BARBED CHECK VALVE	2.000	PC	VL1165A0	BAM-BB6 STRAIGHT FITTING	1.000	PC	VL1166A0	BB6-AR6 L FITTING	2.000	PC	VL1174C0	D1.2 MM CALIBRATED D1.2 MM	1.000	PC	VL1191A0	ONE WASHING DISTRIBUTOR OUTLETS KIT	1.000	PC
Code	Description	Qty	UOM																																																																																						
EL1450A0	US SELF-CLEANIN G WATER SOLENOID	2.000	PC																																																																																						
GN1526A0	INT. D.=6.9 TH=1.8 O-RIN	5.000	PC																																																																																						
RC1018A0	ZINC PLATED D12 ELASTIC CLAMP	4.000	PC																																																																																						
RC1019A0	D=10 ELASTIC CLAMP	16.000	PC																																																																																						
RC1131A0	200x2.6 BLACK CLAMP	1.000	PC																																																																																						
RC1242A0	D=10 CLOSED CAP	2.000	PC																																																																																						
TB2821A0	EPDM 6X10 L=40MM PIPE	6.000	PC																																																																																						
TB2994A0	HOOD DETERGENT PIPE	2.000	PC																																																																																						
TB3252A0		2.000	PC																																																																																						
VI1220A1	4,2x12 TCB SELF-TAPPIN G SCREW	3.000	PC																																																																																						
VL1019A0	VIBRATION DETERGENT PUMP	1.000	PC																																																																																						
VL1047A1	D6 PIPE HOLDER - D8 J.G. TERMINAL	1.000	PC																																																																																						
VL1054B0	ONE WASHING SYS INLET DISTRIBUTOR	1.000	PC																																																																																						
VL1102A1	DETERGENT LINE FILTER + BARBED VNR 6 MM	1.000	PC																																																																																						
VL1127A1	6mm BARBED T-SHAPED FITTING	1.000	PC																																																																																						
VL1128A1	D6 BARBED CHECK VALVE	2.000	PC																																																																																						
VL1165A0	BAM-BB6 STRAIGHT FITTING	1.000	PC																																																																																						
VL1166A0	BB6-AR6 L FITTING	2.000	PC																																																																																						
VL1174C0	D1.2 MM CALIBRATED D1.2 MM	1.000	PC																																																																																						
VL1191A0	ONE WASHING DISTRIBUTOR OUTLETS KIT	1.000	PC																																																																																						

COMPONENT			SPARE PART																																																														
Code	Description	Image	Code	Description	Kit components																																																												
VL1166A	BB6-AR6 L FITTING		KVL1225A	US HOOD WASHING SYSTEM KIT	<table border="1"> <thead> <tr> <th>Code</th> <th>Description</th> <th>Qty</th> <th>UOM</th> </tr> </thead> <tbody> <tr> <td>VL1214A0</td> <td>BAYONET - 6mm BARBED NRV VALVE</td> <td>1.000</td> <td>PC</td> </tr> <tr> <td>VM1605A0</td> <td>CLIP TWIST LOCK DIAM. 10,2-12,7 MM</td> <td>2.000</td> <td>PC</td> </tr> <tr> <td>VM2172A0</td> <td>LOCKING CLIP FOR PUMP WITH CIRCUIT</td> <td>3.000</td> <td>PC</td> </tr> </tbody> </table>	Code	Description	Qty	UOM	VL1214A0	BAYONET - 6mm BARBED NRV VALVE	1.000	PC	VM1605A0	CLIP TWIST LOCK DIAM. 10,2-12,7 MM	2.000	PC	VM2172A0	LOCKING CLIP FOR PUMP WITH CIRCUIT	3.000	PC																																												
Code	Description	Qty	UOM																																																														
VL1214A0	BAYONET - 6mm BARBED NRV VALVE	1.000	PC																																																														
VM1605A0	CLIP TWIST LOCK DIAM. 10,2-12,7 MM	2.000	PC																																																														
VM2172A0	LOCKING CLIP FOR PUMP WITH CIRCUIT	3.000	PC																																																														
			KVL1222A	EUR 0311 ONE PLUS CLEANING SYSTEM KIT	<table border="1"> <thead> <tr> <th>Code</th> <th>Description</th> <th>Qty</th> <th>UOM</th> </tr> </thead> <tbody> <tr> <td>0H2486A0</td> <td>0311 WASHING CIRCUIT PLAT</td> <td>1.000</td> <td>PC</td> </tr> <tr> <td>EL1440A0</td> <td>WATER SELF CLEANING VALVE</td> <td>1.000</td> <td>PC</td> </tr> <tr> <td>GN1526A0</td> <td>INT. D.=6.9 TH=1.8 O-RIN</td> <td>3.000</td> <td>PC</td> </tr> <tr> <td>RC1018A0</td> <td>ZINC PLATED D12 ELASTIC CLAMP</td> <td>1.000</td> <td>PC</td> </tr> <tr> <td>RC1019A0</td> <td>D=10 ELASTIC CLAMP</td> <td>14.000</td> <td>PC</td> </tr> <tr> <td>RC1242A0</td> <td>D=10 CLOSED CAP</td> <td>2.000</td> <td>PC</td> </tr> <tr> <td>TB2821A0</td> <td>EPDM 6X10 L=40MM PIPE</td> <td>6.000</td> <td>PC</td> </tr> <tr> <td>TB3004A0</td> <td>TB2820A L=550mm EPDM BLACK PIPE</td> <td>1.000</td> <td>PC</td> </tr> <tr> <td>TB3009B0</td> <td>TB3132A-ONE OVEN WASHING INLET</td> <td>1.000</td> <td>PC</td> </tr> <tr> <td>TB3225B0</td> <td>TB2820A-TAN K-WASHYNG SYS CONNECTION</td> <td>1.000</td> <td>PC</td> </tr> <tr> <td>V11220A1</td> <td>4,2x12 TCB SELF-TAPPIN G SCREW</td> <td>4.000</td> <td>PC</td> </tr> <tr> <td>VL1019A0</td> <td>VIBRATION DETERGENT PUMP</td> <td>1.000</td> <td>PC</td> </tr> <tr> <td>VL1047A1</td> <td>D6 PIPE HOLDER - D8 J.G. TERMINAL</td> <td>1.000</td> <td>PC</td> </tr> <tr> <td>VL1054B0</td> <td>ONE WASHING SYS INLET DISTRIBUTOR</td> <td>1.000</td> <td>PC</td> </tr> </tbody> </table>	Code	Description	Qty	UOM	0H2486A0	0311 WASHING CIRCUIT PLAT	1.000	PC	EL1440A0	WATER SELF CLEANING VALVE	1.000	PC	GN1526A0	INT. D.=6.9 TH=1.8 O-RIN	3.000	PC	RC1018A0	ZINC PLATED D12 ELASTIC CLAMP	1.000	PC	RC1019A0	D=10 ELASTIC CLAMP	14.000	PC	RC1242A0	D=10 CLOSED CAP	2.000	PC	TB2821A0	EPDM 6X10 L=40MM PIPE	6.000	PC	TB3004A0	TB2820A L=550mm EPDM BLACK PIPE	1.000	PC	TB3009B0	TB3132A-ONE OVEN WASHING INLET	1.000	PC	TB3225B0	TB2820A-TAN K-WASHYNG SYS CONNECTION	1.000	PC	V11220A1	4,2x12 TCB SELF-TAPPIN G SCREW	4.000	PC	VL1019A0	VIBRATION DETERGENT PUMP	1.000	PC	VL1047A1	D6 PIPE HOLDER - D8 J.G. TERMINAL	1.000	PC	VL1054B0	ONE WASHING SYS INLET DISTRIBUTOR	1.000	PC
Code	Description	Qty	UOM																																																														
0H2486A0	0311 WASHING CIRCUIT PLAT	1.000	PC																																																														
EL1440A0	WATER SELF CLEANING VALVE	1.000	PC																																																														
GN1526A0	INT. D.=6.9 TH=1.8 O-RIN	3.000	PC																																																														
RC1018A0	ZINC PLATED D12 ELASTIC CLAMP	1.000	PC																																																														
RC1019A0	D=10 ELASTIC CLAMP	14.000	PC																																																														
RC1242A0	D=10 CLOSED CAP	2.000	PC																																																														
TB2821A0	EPDM 6X10 L=40MM PIPE	6.000	PC																																																														
TB3004A0	TB2820A L=550mm EPDM BLACK PIPE	1.000	PC																																																														
TB3009B0	TB3132A-ONE OVEN WASHING INLET	1.000	PC																																																														
TB3225B0	TB2820A-TAN K-WASHYNG SYS CONNECTION	1.000	PC																																																														
V11220A1	4,2x12 TCB SELF-TAPPIN G SCREW	4.000	PC																																																														
VL1019A0	VIBRATION DETERGENT PUMP	1.000	PC																																																														
VL1047A1	D6 PIPE HOLDER - D8 J.G. TERMINAL	1.000	PC																																																														
VL1054B0	ONE WASHING SYS INLET DISTRIBUTOR	1.000	PC																																																														





COMPONENT			SPARE PART																																																						
Code	Description	Image	Code	Description	Kit components																																																				
VL1166A	BB6-AR6 L FITTING		KVL1222A	EUR 0311 ONE PLUS CLEANING SYSTEM KIT	<table border="1"> <thead> <tr> <th>Code</th> <th>Description</th> <th>Qty</th> <th>UOM</th> </tr> </thead> <tbody> <tr> <td>VL1102A1</td> <td>DETERGENT LINE FILTER + BARBED VNR 6 MM</td> <td>1.000</td> <td>PC</td> </tr> <tr> <td>VL1128A1</td> <td>D6 BARBED CHECK VALVE</td> <td>2.000</td> <td>PC</td> </tr> <tr> <td>VL1166A0</td> <td>BB6-AR6 L FITTING</td> <td>1.000</td> <td>PC</td> </tr> <tr> <td>VL1174C0</td> <td>D1.2 MM CALIBRATED D1.2 MM</td> <td>1.000</td> <td>PC</td> </tr> <tr> <td>VL1191A0</td> <td>ONE WASHING DISTRIBUTOR OUTLETS KIT</td> <td>1.000</td> <td>PC</td> </tr> <tr> <td>VL1214A0</td> <td>BAYONET - 6mm BARBED NRV VALVE</td> <td>1.000</td> <td>PC</td> </tr> <tr> <td>VM2172A0</td> <td>LOCKING CLIP FOR PUMP WITH CIRCUIT</td> <td>2.000</td> <td>PC</td> </tr> </tbody> </table>	Code	Description	Qty	UOM	VL1102A1	DETERGENT LINE FILTER + BARBED VNR 6 MM	1.000	PC	VL1128A1	D6 BARBED CHECK VALVE	2.000	PC	VL1166A0	BB6-AR6 L FITTING	1.000	PC	VL1174C0	D1.2 MM CALIBRATED D1.2 MM	1.000	PC	VL1191A0	ONE WASHING DISTRIBUTOR OUTLETS KIT	1.000	PC	VL1214A0	BAYONET - 6mm BARBED NRV VALVE	1.000	PC	VM2172A0	LOCKING CLIP FOR PUMP WITH CIRCUIT	2.000	PC																				
Code	Description	Qty	UOM																																																						
VL1102A1	DETERGENT LINE FILTER + BARBED VNR 6 MM	1.000	PC																																																						
VL1128A1	D6 BARBED CHECK VALVE	2.000	PC																																																						
VL1166A0	BB6-AR6 L FITTING	1.000	PC																																																						
VL1174C0	D1.2 MM CALIBRATED D1.2 MM	1.000	PC																																																						
VL1191A0	ONE WASHING DISTRIBUTOR OUTLETS KIT	1.000	PC																																																						
VL1214A0	BAYONET - 6mm BARBED NRV VALVE	1.000	PC																																																						
VM2172A0	LOCKING CLIP FOR PUMP WITH CIRCUIT	2.000	PC																																																						
			KVL1213A	US PLUS COMPACT WASHING SYSTEM KIT	<table border="1"> <thead> <tr> <th>Code</th> <th>Description</th> <th>Qty</th> <th>UOM</th> </tr> </thead> <tbody> <tr> <td>0H2428A2</td> <td>XECC PLUS WASHING CIRCUIT PLAT</td> <td>1.000</td> <td>PC</td> </tr> <tr> <td>EL1450A0</td> <td>US SELF-CLEANING WATER SOLENOID</td> <td>3.000</td> <td>PC</td> </tr> <tr> <td>GN1312A0</td> <td>RUBBER CABLE-PASSING DE=26 DI=15 SP=10</td> <td>1.000</td> <td>PC</td> </tr> <tr> <td>GN1526A0</td> <td>INT. D.=6.9 TH=1.8 O-RING</td> <td>7.000</td> <td>PC</td> </tr> <tr> <td>RC1018A0</td> <td>ZINC PLATED D12 ELASTIC CLAMP</td> <td>2.000</td> <td>PC</td> </tr> <tr> <td>RC1019A0</td> <td>D=10 ELASTIC CLAMP</td> <td>14.000</td> <td>PC</td> </tr> <tr> <td>RC1130A0</td> <td>130x2.6 CLAMP</td> <td>1.000</td> <td>PC</td> </tr> <tr> <td>RC1131A0</td> <td>200x2.6 BLACK CLAMP</td> <td>1.000</td> <td>PC</td> </tr> <tr> <td>RC1242A0</td> <td>D=10 CLOSED CAP</td> <td>2.000</td> <td>PC</td> </tr> <tr> <td>RC1356A0</td> <td>"STRAIGHT THREADED FEMALE END 8x1/4" BS</td> <td>1.000</td> <td>PC</td> </tr> <tr> <td>TB2821A0</td> <td>EPDM 6X10 L=40MM PIPE</td> <td>6.000</td> <td>PC</td> </tr> <tr> <td>TB3004A0</td> <td>TB2820A L=550mm EPDM BLACK PIPE</td> <td>1.000</td> <td>PC</td> </tr> </tbody> </table>	Code	Description	Qty	UOM	0H2428A2	XECC PLUS WASHING CIRCUIT PLAT	1.000	PC	EL1450A0	US SELF-CLEANING WATER SOLENOID	3.000	PC	GN1312A0	RUBBER CABLE-PASSING DE=26 DI=15 SP=10	1.000	PC	GN1526A0	INT. D.=6.9 TH=1.8 O-RING	7.000	PC	RC1018A0	ZINC PLATED D12 ELASTIC CLAMP	2.000	PC	RC1019A0	D=10 ELASTIC CLAMP	14.000	PC	RC1130A0	130x2.6 CLAMP	1.000	PC	RC1131A0	200x2.6 BLACK CLAMP	1.000	PC	RC1242A0	D=10 CLOSED CAP	2.000	PC	RC1356A0	"STRAIGHT THREADED FEMALE END 8x1/4" BS	1.000	PC	TB2821A0	EPDM 6X10 L=40MM PIPE	6.000	PC	TB3004A0	TB2820A L=550mm EPDM BLACK PIPE	1.000	PC
Code	Description	Qty	UOM																																																						
0H2428A2	XECC PLUS WASHING CIRCUIT PLAT	1.000	PC																																																						
EL1450A0	US SELF-CLEANING WATER SOLENOID	3.000	PC																																																						
GN1312A0	RUBBER CABLE-PASSING DE=26 DI=15 SP=10	1.000	PC																																																						
GN1526A0	INT. D.=6.9 TH=1.8 O-RING	7.000	PC																																																						
RC1018A0	ZINC PLATED D12 ELASTIC CLAMP	2.000	PC																																																						
RC1019A0	D=10 ELASTIC CLAMP	14.000	PC																																																						
RC1130A0	130x2.6 CLAMP	1.000	PC																																																						
RC1131A0	200x2.6 BLACK CLAMP	1.000	PC																																																						
RC1242A0	D=10 CLOSED CAP	2.000	PC																																																						
RC1356A0	"STRAIGHT THREADED FEMALE END 8x1/4" BS	1.000	PC																																																						
TB2821A0	EPDM 6X10 L=40MM PIPE	6.000	PC																																																						
TB3004A0	TB2820A L=550mm EPDM BLACK PIPE	1.000	PC																																																						



COMPONENT			SPARE PART																																																										
Code	Description	Image	Code	Description	Kit components																																																								
VL1166A	BB6-AR6 L FITTING		KVL1213A	US PLUS COMPACT WASHING SYSTEM KIT	<table border="1"> <thead> <tr> <th>Code</th> <th>Description</th> <th>Qty</th> <th>UOM</th> </tr> </thead> <tbody> <tr> <td>TB3005B0</td> <td>TB3132A L=550mm EPDM WHITE-BLUE PIPE</td> <td>1.000</td> <td>PC</td> </tr> <tr> <td>TB3469A0</td> <td></td> <td>1.000</td> <td>PC</td> </tr> <tr> <td>VL1019A0</td> <td>VIBRATION DETERGENT PUMP</td> <td>1.000</td> <td>PC</td> </tr> <tr> <td>VL1047A1</td> <td>D6 PIPE HOLDER - D8 J.G. TERMINAL</td> <td>1.000</td> <td>PC</td> </tr> <tr> <td>VL1054B0</td> <td>ONE WASHING SYS INLET DISTRIBUTOR</td> <td>1.000</td> <td>PC</td> </tr> <tr> <td>VL1102A1</td> <td>DETERGENT LINE FILTER + BARBED VNR 6 MM</td> <td>1.000</td> <td>PC</td> </tr> <tr> <td>VL1128A1</td> <td>D6 BARBED CHECK VALVE</td> <td>2.000</td> <td>PC</td> </tr> <tr> <td>VL1165A0</td> <td>BAM-BB6 STRAIGHT FITTING</td> <td>1.000</td> <td>PC</td> </tr> <tr> <td>VL1166A0</td> <td>BB6-AR6 L FITTING</td> <td>3.000</td> <td>PC</td> </tr> <tr> <td>VL1174C0</td> <td>D1.2 MM CALIBRATED D1.2 MM</td> <td>1.000</td> <td>PC</td> </tr> <tr> <td>VL1185A0</td> <td>2 WAYS PLUS WASHING DISTRIBUTOR</td> <td>1.000</td> <td>PC</td> </tr> <tr> <td>VL1398A0</td> <td>1/4 M N.O. CIL PRESSURE SWITCH</td> <td>1.000</td> <td>PC</td> </tr> <tr> <td>VM2172A0</td> <td>LOCKING CLIP FOR PUMP WITH CIRCUIT</td> <td>6.000</td> <td>PC</td> </tr> </tbody> </table>	Code	Description	Qty	UOM	TB3005B0	TB3132A L=550mm EPDM WHITE-BLUE PIPE	1.000	PC	TB3469A0		1.000	PC	VL1019A0	VIBRATION DETERGENT PUMP	1.000	PC	VL1047A1	D6 PIPE HOLDER - D8 J.G. TERMINAL	1.000	PC	VL1054B0	ONE WASHING SYS INLET DISTRIBUTOR	1.000	PC	VL1102A1	DETERGENT LINE FILTER + BARBED VNR 6 MM	1.000	PC	VL1128A1	D6 BARBED CHECK VALVE	2.000	PC	VL1165A0	BAM-BB6 STRAIGHT FITTING	1.000	PC	VL1166A0	BB6-AR6 L FITTING	3.000	PC	VL1174C0	D1.2 MM CALIBRATED D1.2 MM	1.000	PC	VL1185A0	2 WAYS PLUS WASHING DISTRIBUTOR	1.000	PC	VL1398A0	1/4 M N.O. CIL PRESSURE SWITCH	1.000	PC	VM2172A0	LOCKING CLIP FOR PUMP WITH CIRCUIT	6.000	PC
Code	Description	Qty	UOM																																																										
TB3005B0	TB3132A L=550mm EPDM WHITE-BLUE PIPE	1.000	PC																																																										
TB3469A0		1.000	PC																																																										
VL1019A0	VIBRATION DETERGENT PUMP	1.000	PC																																																										
VL1047A1	D6 PIPE HOLDER - D8 J.G. TERMINAL	1.000	PC																																																										
VL1054B0	ONE WASHING SYS INLET DISTRIBUTOR	1.000	PC																																																										
VL1102A1	DETERGENT LINE FILTER + BARBED VNR 6 MM	1.000	PC																																																										
VL1128A1	D6 BARBED CHECK VALVE	2.000	PC																																																										
VL1165A0	BAM-BB6 STRAIGHT FITTING	1.000	PC																																																										
VL1166A0	BB6-AR6 L FITTING	3.000	PC																																																										
VL1174C0	D1.2 MM CALIBRATED D1.2 MM	1.000	PC																																																										
VL1185A0	2 WAYS PLUS WASHING DISTRIBUTOR	1.000	PC																																																										
VL1398A0	1/4 M N.O. CIL PRESSURE SWITCH	1.000	PC																																																										
VM2172A0	LOCKING CLIP FOR PUMP WITH CIRCUIT	6.000	PC																																																										
			KVL1212A	EUR COMPACT PLUS CLEANING SYSTEM KIT	<table border="1"> <thead> <tr> <th>Code</th> <th>Description</th> <th>Qty</th> <th>UOM</th> </tr> </thead> <tbody> <tr> <td>0H2428A2</td> <td>XECC PLUS WASHING CIRCUIT PLAT</td> <td>1.000</td> <td>PC</td> </tr> <tr> <td>EL1440A0</td> <td>WATER SELF CLEANING VALVE</td> <td>3.000</td> <td>PC</td> </tr> <tr> <td>GN1312A0</td> <td>RUBBER CABLE-PASSI NG DE=26 DI=15 SP=10</td> <td>1.000</td> <td>PC</td> </tr> <tr> <td>GN1526A0</td> <td>INT. D.=6.9 TH=1.8 O-RIN</td> <td>7.000</td> <td>PC</td> </tr> </tbody> </table>	Code	Description	Qty	UOM	0H2428A2	XECC PLUS WASHING CIRCUIT PLAT	1.000	PC	EL1440A0	WATER SELF CLEANING VALVE	3.000	PC	GN1312A0	RUBBER CABLE-PASSI NG DE=26 DI=15 SP=10	1.000	PC	GN1526A0	INT. D.=6.9 TH=1.8 O-RIN	7.000	PC																																				
Code	Description	Qty	UOM																																																										
0H2428A2	XECC PLUS WASHING CIRCUIT PLAT	1.000	PC																																																										
EL1440A0	WATER SELF CLEANING VALVE	3.000	PC																																																										
GN1312A0	RUBBER CABLE-PASSI NG DE=26 DI=15 SP=10	1.000	PC																																																										
GN1526A0	INT. D.=6.9 TH=1.8 O-RIN	7.000	PC																																																										



COMPONENT			SPARE PART																																																																																		
Code	Description	Image	Code	Description	Kit components																																																																																
VL1166A	BB6-AR6 L FITTING		KVL1212A	EUR COMPACT PLUS CLEANING SYSTEM KIT	<table border="1"> <thead> <tr> <th>Code</th> <th>Description</th> <th>Qty</th> <th>UOM</th> </tr> </thead> <tbody> <tr> <td>RC1018A0</td> <td>ZINC PLATED D12 ELASTIC CLAMP</td> <td>2.000</td> <td>PC</td> </tr> <tr> <td>RC1019A0</td> <td>D=10 ELASTIC CLAMP</td> <td>14.000</td> <td>PC</td> </tr> <tr> <td>RC1130A0</td> <td>130x2,6 CLAM</td> <td>1.000</td> <td>PC</td> </tr> <tr> <td>RC1131A0</td> <td>200x2,6 BLACK CLAMP</td> <td>1.000</td> <td>PC</td> </tr> <tr> <td>RC1242A0</td> <td>D=10 CLOSED CAP</td> <td>2.000</td> <td>PC</td> </tr> <tr> <td>RC1356A0</td> <td>"STRAIGHT THREADED FEMALE END 8x1/4" BS</td> <td>1.000</td> <td>PC</td> </tr> <tr> <td>TB2821A0</td> <td>EPDM 6X10 L=40MM PIPE</td> <td>6.000</td> <td>PC</td> </tr> <tr> <td>TB3004A0</td> <td>TB2820A L=550mm EPDM BLACK PIPE</td> <td>2.000</td> <td>PC</td> </tr> <tr> <td>TB3005B0</td> <td>TB3132A L=550mm EPDM WHITE-BLUE PIPE</td> <td>1.000</td> <td>PC</td> </tr> <tr> <td>TB3469A0</td> <td></td> <td>1.000</td> <td>PC</td> </tr> <tr> <td>VL1019A0</td> <td>VIBRATION DETERGENT PUMP</td> <td>1.000</td> <td>PC</td> </tr> <tr> <td>VL1047A1</td> <td>D6 PIPE HOLDER - D6 J.G. TERMINAL</td> <td>1.000</td> <td>PC</td> </tr> <tr> <td>VL1054B0</td> <td>ONE WASHING SYS INLET DISTRIBUTOR</td> <td>1.000</td> <td>PC</td> </tr> <tr> <td>VL1102A1</td> <td>DETERGENT LINE FILTER + BARBED VNR 6 MM</td> <td>1.000</td> <td>PC</td> </tr> <tr> <td>VL1128A1</td> <td>D6 BARBED CHECK VALVE</td> <td>2.000</td> <td>PC</td> </tr> <tr> <td>VL1165A0</td> <td>BAM-BB6 STRAIGHT FITTING</td> <td>1.000</td> <td>PC</td> </tr> <tr> <td>VL1166A0</td> <td>BB6-AR6 L FITTING</td> <td>3.000</td> <td>PC</td> </tr> <tr> <td>VL1174C0</td> <td>D1.2 MM CALIBRATED D1.2 MM</td> <td>1.000</td> <td>PC</td> </tr> <tr> <td>VL1185A0</td> <td>2 WAYS PLUS WASHING DISTRIBUTOR</td> <td>1.000</td> <td>PC</td> </tr> </tbody> </table>	Code	Description	Qty	UOM	RC1018A0	ZINC PLATED D12 ELASTIC CLAMP	2.000	PC	RC1019A0	D=10 ELASTIC CLAMP	14.000	PC	RC1130A0	130x2,6 CLAM	1.000	PC	RC1131A0	200x2,6 BLACK CLAMP	1.000	PC	RC1242A0	D=10 CLOSED CAP	2.000	PC	RC1356A0	"STRAIGHT THREADED FEMALE END 8x1/4" BS	1.000	PC	TB2821A0	EPDM 6X10 L=40MM PIPE	6.000	PC	TB3004A0	TB2820A L=550mm EPDM BLACK PIPE	2.000	PC	TB3005B0	TB3132A L=550mm EPDM WHITE-BLUE PIPE	1.000	PC	TB3469A0		1.000	PC	VL1019A0	VIBRATION DETERGENT PUMP	1.000	PC	VL1047A1	D6 PIPE HOLDER - D6 J.G. TERMINAL	1.000	PC	VL1054B0	ONE WASHING SYS INLET DISTRIBUTOR	1.000	PC	VL1102A1	DETERGENT LINE FILTER + BARBED VNR 6 MM	1.000	PC	VL1128A1	D6 BARBED CHECK VALVE	2.000	PC	VL1165A0	BAM-BB6 STRAIGHT FITTING	1.000	PC	VL1166A0	BB6-AR6 L FITTING	3.000	PC	VL1174C0	D1.2 MM CALIBRATED D1.2 MM	1.000	PC	VL1185A0	2 WAYS PLUS WASHING DISTRIBUTOR	1.000	PC
Code	Description	Qty	UOM																																																																																		
RC1018A0	ZINC PLATED D12 ELASTIC CLAMP	2.000	PC																																																																																		
RC1019A0	D=10 ELASTIC CLAMP	14.000	PC																																																																																		
RC1130A0	130x2,6 CLAM	1.000	PC																																																																																		
RC1131A0	200x2,6 BLACK CLAMP	1.000	PC																																																																																		
RC1242A0	D=10 CLOSED CAP	2.000	PC																																																																																		
RC1356A0	"STRAIGHT THREADED FEMALE END 8x1/4" BS	1.000	PC																																																																																		
TB2821A0	EPDM 6X10 L=40MM PIPE	6.000	PC																																																																																		
TB3004A0	TB2820A L=550mm EPDM BLACK PIPE	2.000	PC																																																																																		
TB3005B0	TB3132A L=550mm EPDM WHITE-BLUE PIPE	1.000	PC																																																																																		
TB3469A0		1.000	PC																																																																																		
VL1019A0	VIBRATION DETERGENT PUMP	1.000	PC																																																																																		
VL1047A1	D6 PIPE HOLDER - D6 J.G. TERMINAL	1.000	PC																																																																																		
VL1054B0	ONE WASHING SYS INLET DISTRIBUTOR	1.000	PC																																																																																		
VL1102A1	DETERGENT LINE FILTER + BARBED VNR 6 MM	1.000	PC																																																																																		
VL1128A1	D6 BARBED CHECK VALVE	2.000	PC																																																																																		
VL1165A0	BAM-BB6 STRAIGHT FITTING	1.000	PC																																																																																		
VL1166A0	BB6-AR6 L FITTING	3.000	PC																																																																																		
VL1174C0	D1.2 MM CALIBRATED D1.2 MM	1.000	PC																																																																																		
VL1185A0	2 WAYS PLUS WASHING DISTRIBUTOR	1.000	PC																																																																																		

COMPONENT			SPARE PART																																																																										
Code	Description	Image	Code	Description	Kit components																																																																								
VL1166A	BB6-AR6 L FITTING		KVL1212A	EUR COMPACT PLUS CLEANING SYSTEM KIT	<table border="1"> <thead> <tr> <th>Code</th> <th>Description</th> <th>Qty</th> <th>UOM</th> </tr> </thead> <tbody> <tr> <td>VL1398A0</td> <td>1/4 M N.O. CIL PRESSURE SWITCH</td> <td>1.000</td> <td>PC</td> </tr> <tr> <td>VM2172A0</td> <td>LOCKING CLIP FOR PUMP WITH CIRCUIT</td> <td>6.000</td> <td>PC</td> </tr> </tbody> </table>	Code	Description	Qty	UOM	VL1398A0	1/4 M N.O. CIL PRESSURE SWITCH	1.000	PC	VM2172A0	LOCKING CLIP FOR PUMP WITH CIRCUIT	6.000	PC																																																												
Code	Description	Qty	UOM																																																																										
VL1398A0	1/4 M N.O. CIL PRESSURE SWITCH	1.000	PC																																																																										
VM2172A0	LOCKING CLIP FOR PUMP WITH CIRCUIT	6.000	PC																																																																										
			KVL1211A	ONE COMPACT AND 0523-EP WASH. SYSTEM KIT	<table border="1"> <thead> <tr> <th>Code</th> <th>Description</th> <th>Qty</th> <th>UOM</th> </tr> </thead> <tbody> <tr> <td>0H2427A0</td> <td>XECC WASHING CIRCUIT HOLDING PLATE</td> <td>1.000</td> <td>PC</td> </tr> <tr> <td>EL1440A0</td> <td>WATER SELF CLEANING VALVE</td> <td>1.000</td> <td>PC</td> </tr> <tr> <td>GN1526A0</td> <td>INT. D.=6.9 TH=1.8 O-RING</td> <td>3.000</td> <td>PC</td> </tr> <tr> <td>RC1018A0</td> <td>ZINC PLATED D12 ELASTIC CLAMP</td> <td>1.000</td> <td>PC</td> </tr> <tr> <td>RC1019A0</td> <td>D=10 ELASTIC CLAMP</td> <td>14.000</td> <td>PC</td> </tr> <tr> <td>RC1130A0</td> <td>130x2.6 CLAM</td> <td>1.000</td> <td>PC</td> </tr> <tr> <td>RC1242A0</td> <td>D=10 CLOSED CAP</td> <td>2.000</td> <td>PC</td> </tr> <tr> <td>TB1402A0</td> <td>TB2820A-DETE RGENT CIRCUIT-FILTE R PIPE</td> <td>1.000</td> <td>PC</td> </tr> <tr> <td>TB2821A0</td> <td>EPDM 6X10 L=40MM PIPE</td> <td>6.000</td> <td>PC</td> </tr> <tr> <td>TB3004A0</td> <td>TB2820A L=550mm EPDM BLACK PIPE</td> <td>1.000</td> <td>PC</td> </tr> <tr> <td>TB3469A0</td> <td></td> <td>1.000</td> <td>PC</td> </tr> <tr> <td>VI1220A1</td> <td>4,2x12 TCB SELF-TAPPIN G SCREW</td> <td>4.000</td> <td>PC</td> </tr> <tr> <td>VL1019A0</td> <td>VIBRATION DETERGENT PUMP</td> <td>1.000</td> <td>PC</td> </tr> <tr> <td>VL1047A1</td> <td>D6 PIPE HOLDER - D8 J.G. TERMINAL</td> <td>1.000</td> <td>PC</td> </tr> <tr> <td>VL1054B0</td> <td>ONE WASHING SYS INLET DISTRIBUTOR</td> <td>1.000</td> <td>PC</td> </tr> <tr> <td>VL1102A1</td> <td>DETERGENT LINE FILTER + BARBED VNR 6 MM</td> <td>1.000</td> <td>PC</td> </tr> <tr> <td>VL1128A1</td> <td>D6 BARBED CHECK VALVE</td> <td>2.000</td> <td>PC</td> </tr> </tbody> </table>	Code	Description	Qty	UOM	0H2427A0	XECC WASHING CIRCUIT HOLDING PLATE	1.000	PC	EL1440A0	WATER SELF CLEANING VALVE	1.000	PC	GN1526A0	INT. D.=6.9 TH=1.8 O-RING	3.000	PC	RC1018A0	ZINC PLATED D12 ELASTIC CLAMP	1.000	PC	RC1019A0	D=10 ELASTIC CLAMP	14.000	PC	RC1130A0	130x2.6 CLAM	1.000	PC	RC1242A0	D=10 CLOSED CAP	2.000	PC	TB1402A0	TB2820A-DETE RGENT CIRCUIT-FILTE R PIPE	1.000	PC	TB2821A0	EPDM 6X10 L=40MM PIPE	6.000	PC	TB3004A0	TB2820A L=550mm EPDM BLACK PIPE	1.000	PC	TB3469A0		1.000	PC	VI1220A1	4,2x12 TCB SELF-TAPPIN G SCREW	4.000	PC	VL1019A0	VIBRATION DETERGENT PUMP	1.000	PC	VL1047A1	D6 PIPE HOLDER - D8 J.G. TERMINAL	1.000	PC	VL1054B0	ONE WASHING SYS INLET DISTRIBUTOR	1.000	PC	VL1102A1	DETERGENT LINE FILTER + BARBED VNR 6 MM	1.000	PC	VL1128A1	D6 BARBED CHECK VALVE	2.000	PC
Code	Description	Qty	UOM																																																																										
0H2427A0	XECC WASHING CIRCUIT HOLDING PLATE	1.000	PC																																																																										
EL1440A0	WATER SELF CLEANING VALVE	1.000	PC																																																																										
GN1526A0	INT. D.=6.9 TH=1.8 O-RING	3.000	PC																																																																										
RC1018A0	ZINC PLATED D12 ELASTIC CLAMP	1.000	PC																																																																										
RC1019A0	D=10 ELASTIC CLAMP	14.000	PC																																																																										
RC1130A0	130x2.6 CLAM	1.000	PC																																																																										
RC1242A0	D=10 CLOSED CAP	2.000	PC																																																																										
TB1402A0	TB2820A-DETE RGENT CIRCUIT-FILTE R PIPE	1.000	PC																																																																										
TB2821A0	EPDM 6X10 L=40MM PIPE	6.000	PC																																																																										
TB3004A0	TB2820A L=550mm EPDM BLACK PIPE	1.000	PC																																																																										
TB3469A0		1.000	PC																																																																										
VI1220A1	4,2x12 TCB SELF-TAPPIN G SCREW	4.000	PC																																																																										
VL1019A0	VIBRATION DETERGENT PUMP	1.000	PC																																																																										
VL1047A1	D6 PIPE HOLDER - D8 J.G. TERMINAL	1.000	PC																																																																										
VL1054B0	ONE WASHING SYS INLET DISTRIBUTOR	1.000	PC																																																																										
VL1102A1	DETERGENT LINE FILTER + BARBED VNR 6 MM	1.000	PC																																																																										
VL1128A1	D6 BARBED CHECK VALVE	2.000	PC																																																																										



COMPONENT			SPARE PART																																																																						
Code	Description	Image	Code	Description	Kit components																																																																				
VL1166A	BB6-AR6 L FITTING		KVL1211A	ONE COMPACT AND 0523-EP WASH. SYSTEM KIT	<table border="1"> <thead> <tr> <th>Code</th> <th>Description</th> <th>Qty</th> <th>UOM</th> </tr> </thead> <tbody> <tr> <td>VL1165A0</td> <td>BAM-BB6 STRAIGHT FITTING</td> <td>1.000</td> <td>PC</td> </tr> <tr> <td>VL1166A0</td> <td>BB6-AR6 L FITTING</td> <td>1.000</td> <td>PC</td> </tr> <tr> <td>VL1174C0</td> <td>D1.2 MM CALIBRATED D1.2 MM</td> <td>1.000</td> <td>PC</td> </tr> <tr> <td>VL1191A0</td> <td>ONE WASHING DISTRIBUTOR OUTLETS KIT</td> <td>1.000</td> <td>PC</td> </tr> <tr> <td>VM2172A0</td> <td>LOCKING CLIP FOR PUMP WITH CIRCUIT</td> <td>2.000</td> <td>PC</td> </tr> </tbody> </table>	Code	Description	Qty	UOM	VL1165A0	BAM-BB6 STRAIGHT FITTING	1.000	PC	VL1166A0	BB6-AR6 L FITTING	1.000	PC	VL1174C0	D1.2 MM CALIBRATED D1.2 MM	1.000	PC	VL1191A0	ONE WASHING DISTRIBUTOR OUTLETS KIT	1.000	PC	VM2172A0	LOCKING CLIP FOR PUMP WITH CIRCUIT	2.000	PC																																												
Code	Description	Qty	UOM																																																																						
VL1165A0	BAM-BB6 STRAIGHT FITTING	1.000	PC																																																																						
VL1166A0	BB6-AR6 L FITTING	1.000	PC																																																																						
VL1174C0	D1.2 MM CALIBRATED D1.2 MM	1.000	PC																																																																						
VL1191A0	ONE WASHING DISTRIBUTOR OUTLETS KIT	1.000	PC																																																																						
VM2172A0	LOCKING CLIP FOR PUMP WITH CIRCUIT	2.000	PC																																																																						
			KVL1209A	US PLUS 3 ROTOR ARMS WASHING SYSTEM KIT	<table border="1"> <thead> <tr> <th>Code</th> <th>Description</th> <th>Qty</th> <th>UOM</th> </tr> </thead> <tbody> <tr> <td>0H2354A1</td> <td>XEVC-XEVL PLUS WASHING CIRCUIT PLAT</td> <td>1.000</td> <td>PC</td> </tr> <tr> <td>EL1450A0</td> <td>US SELF-CLEANING WATER SOLENOID</td> <td>4.000</td> <td>PC</td> </tr> <tr> <td>GN1526A0</td> <td>INT. D.=6.9 TH=1.8 O-RING</td> <td>9.000</td> <td>PC</td> </tr> <tr> <td>RC1018A0</td> <td>ZINC PLATED D12 ELASTIC CLAMP</td> <td>12.000</td> <td>PC</td> </tr> <tr> <td>RC1019A0</td> <td>D=10 ELASTIC CLAMP</td> <td>15.000</td> <td>PC</td> </tr> <tr> <td>RC1130A0</td> <td>130x2.6 CLAMP</td> <td>1.000</td> <td>PC</td> </tr> <tr> <td>RC1131A0</td> <td>200x2.6 BLACK CLAMP</td> <td>3.000</td> <td>PC</td> </tr> <tr> <td>RC1242A0</td> <td>D=10 CLOSED CAP</td> <td>2.000</td> <td>PC</td> </tr> <tr> <td>RC1356A0</td> <td>"STRAIGHT THREADED FEMALE END 8x1/4" BS</td> <td>1.000</td> <td>PC</td> </tr> <tr> <td>TB2652A0</td> <td></td> <td>1.000</td> <td>PC</td> </tr> <tr> <td>TB2677A0</td> <td></td> <td>1.000</td> <td>PC</td> </tr> <tr> <td>TB2821A0</td> <td>EPDM 6X10 L=40MM PIPE</td> <td>6.000</td> <td>PC</td> </tr> <tr> <td>TB3004A0</td> <td>TB2820A L=550mm EPDM BLACK PIPE</td> <td>2.000</td> <td>PC</td> </tr> <tr> <td>TB3024C0</td> <td></td> <td>3.000</td> <td>PC</td> </tr> <tr> <td>TB3226A0</td> <td></td> <td>1.000</td> <td>PC</td> </tr> <tr> <td>TB3440A0</td> <td>TB3132A L=1050mm EPDM WHITE-BLUE PIPE</td> <td>1.000</td> <td>PC</td> </tr> </tbody> </table>	Code	Description	Qty	UOM	0H2354A1	XEVC-XEVL PLUS WASHING CIRCUIT PLAT	1.000	PC	EL1450A0	US SELF-CLEANING WATER SOLENOID	4.000	PC	GN1526A0	INT. D.=6.9 TH=1.8 O-RING	9.000	PC	RC1018A0	ZINC PLATED D12 ELASTIC CLAMP	12.000	PC	RC1019A0	D=10 ELASTIC CLAMP	15.000	PC	RC1130A0	130x2.6 CLAMP	1.000	PC	RC1131A0	200x2.6 BLACK CLAMP	3.000	PC	RC1242A0	D=10 CLOSED CAP	2.000	PC	RC1356A0	"STRAIGHT THREADED FEMALE END 8x1/4" BS	1.000	PC	TB2652A0		1.000	PC	TB2677A0		1.000	PC	TB2821A0	EPDM 6X10 L=40MM PIPE	6.000	PC	TB3004A0	TB2820A L=550mm EPDM BLACK PIPE	2.000	PC	TB3024C0		3.000	PC	TB3226A0		1.000	PC	TB3440A0	TB3132A L=1050mm EPDM WHITE-BLUE PIPE	1.000	PC
Code	Description	Qty	UOM																																																																						
0H2354A1	XEVC-XEVL PLUS WASHING CIRCUIT PLAT	1.000	PC																																																																						
EL1450A0	US SELF-CLEANING WATER SOLENOID	4.000	PC																																																																						
GN1526A0	INT. D.=6.9 TH=1.8 O-RING	9.000	PC																																																																						
RC1018A0	ZINC PLATED D12 ELASTIC CLAMP	12.000	PC																																																																						
RC1019A0	D=10 ELASTIC CLAMP	15.000	PC																																																																						
RC1130A0	130x2.6 CLAMP	1.000	PC																																																																						
RC1131A0	200x2.6 BLACK CLAMP	3.000	PC																																																																						
RC1242A0	D=10 CLOSED CAP	2.000	PC																																																																						
RC1356A0	"STRAIGHT THREADED FEMALE END 8x1/4" BS	1.000	PC																																																																						
TB2652A0		1.000	PC																																																																						
TB2677A0		1.000	PC																																																																						
TB2821A0	EPDM 6X10 L=40MM PIPE	6.000	PC																																																																						
TB3004A0	TB2820A L=550mm EPDM BLACK PIPE	2.000	PC																																																																						
TB3024C0		3.000	PC																																																																						
TB3226A0		1.000	PC																																																																						
TB3440A0	TB3132A L=1050mm EPDM WHITE-BLUE PIPE	1.000	PC																																																																						



COMPONENT			SPARE PART																																																																													
Code	Description	Image	Code	Description	Kit components																																																																											
VL1166A	BB6-AR6 L FITTING		KVL1209A	US PLUS 3 ROTOR ARMS WASHING SYSTEM KIT	<table border="1"> <thead> <tr> <th>Code</th> <th>Description</th> <th>Qty</th> <th>UOM</th> </tr> </thead> <tbody> <tr> <td>VL1019A0</td> <td>VIBRATION DETERGENT PUMP</td> <td>1.000</td> <td>PC</td> </tr> <tr> <td>VL1102A1</td> <td>DETERGENT LINE FILTER + BARBED VNR 6 MM</td> <td>1.000</td> <td>PC</td> </tr> <tr> <td>VL1127A1</td> <td>6mm BARBED T-SHAPED FITTING</td> <td>2.000</td> <td>PC</td> </tr> <tr> <td>VL1128A1</td> <td>D6 BARBED CHECK VALVE</td> <td>3.000</td> <td>PC</td> </tr> <tr> <td>VL1166A0</td> <td>BB6-AR6 L FITTING</td> <td>4.000</td> <td>PC</td> </tr> <tr> <td>VL1167A2</td> <td>GN21 3 ROTOR ARMS B-B FLOW RESTRICTOR</td> <td>1.000</td> <td>PC</td> </tr> <tr> <td>VL1174C0</td> <td>D1.2 MM CALIBRATED D1.2 MM</td> <td>1.000</td> <td>PC</td> </tr> <tr> <td>VL1185A0</td> <td>2 WAYS PLUS WASHING DISTRIBUTOR</td> <td>1.000</td> <td>PC</td> </tr> <tr> <td>VL1186A0</td> <td>3 WAYS PLUS WASHING DISTRIBUTOR</td> <td>1.000</td> <td>PC</td> </tr> <tr> <td>VL1190A0</td> <td>PLUS WASHING SYSTEM INLET DISTRIBUTOR</td> <td>1.000</td> <td>PC</td> </tr> <tr> <td>VL1214A0</td> <td>BAYONET - 6mm BARBED NRV VALVE</td> <td>1.000</td> <td>PC</td> </tr> <tr> <td>VL1398A0</td> <td>1/4 M N.O. CIL PRESSURE SWITCH</td> <td>1.000</td> <td>PC</td> </tr> <tr> <td>VM1605A0</td> <td>CLIP TWIST LOCK DIAM. 10,2-12,7 MM</td> <td>3.000</td> <td>PC</td> </tr> <tr> <td>VM2172A0</td> <td>LOCKING CLIP FOR PUMP WITH CIRCUIT</td> <td>9.000</td> <td>PC</td> </tr> </tbody> </table>	Code	Description	Qty	UOM	VL1019A0	VIBRATION DETERGENT PUMP	1.000	PC	VL1102A1	DETERGENT LINE FILTER + BARBED VNR 6 MM	1.000	PC	VL1127A1	6mm BARBED T-SHAPED FITTING	2.000	PC	VL1128A1	D6 BARBED CHECK VALVE	3.000	PC	VL1166A0	BB6-AR6 L FITTING	4.000	PC	VL1167A2	GN21 3 ROTOR ARMS B-B FLOW RESTRICTOR	1.000	PC	VL1174C0	D1.2 MM CALIBRATED D1.2 MM	1.000	PC	VL1185A0	2 WAYS PLUS WASHING DISTRIBUTOR	1.000	PC	VL1186A0	3 WAYS PLUS WASHING DISTRIBUTOR	1.000	PC	VL1190A0	PLUS WASHING SYSTEM INLET DISTRIBUTOR	1.000	PC	VL1214A0	BAYONET - 6mm BARBED NRV VALVE	1.000	PC	VL1398A0	1/4 M N.O. CIL PRESSURE SWITCH	1.000	PC	VM1605A0	CLIP TWIST LOCK DIAM. 10,2-12,7 MM	3.000	PC	VM2172A0	LOCKING CLIP FOR PUMP WITH CIRCUIT	9.000	PC	KVL1208A	US PLUS 2 ROTOR ARMS WASHING SYSTEM KIT	<table border="1"> <thead> <tr> <th>Code</th> <th>Description</th> <th>Qty</th> <th>UOM</th> </tr> </thead> <tbody> <tr> <td>0H2354A1</td> <td>XEVC-XEVL PLUS WASHING CIRCUIT PLAT</td> <td>1.000</td> <td>PC</td> </tr> <tr> <td>EL1450A0</td> <td>US SELF-CLEANING WATER SOLENOID</td> <td>4.000</td> <td>PC</td> </tr> </tbody> </table>	Code	Description	Qty	UOM	0H2354A1	XEVC-XEVL PLUS WASHING CIRCUIT PLAT	1.000	PC	EL1450A0	US SELF-CLEANING WATER SOLENOID	4.000	PC
			Code	Description	Qty	UOM																																																																										
VL1019A0	VIBRATION DETERGENT PUMP	1.000	PC																																																																													
VL1102A1	DETERGENT LINE FILTER + BARBED VNR 6 MM	1.000	PC																																																																													
VL1127A1	6mm BARBED T-SHAPED FITTING	2.000	PC																																																																													
VL1128A1	D6 BARBED CHECK VALVE	3.000	PC																																																																													
VL1166A0	BB6-AR6 L FITTING	4.000	PC																																																																													
VL1167A2	GN21 3 ROTOR ARMS B-B FLOW RESTRICTOR	1.000	PC																																																																													
VL1174C0	D1.2 MM CALIBRATED D1.2 MM	1.000	PC																																																																													
VL1185A0	2 WAYS PLUS WASHING DISTRIBUTOR	1.000	PC																																																																													
VL1186A0	3 WAYS PLUS WASHING DISTRIBUTOR	1.000	PC																																																																													
VL1190A0	PLUS WASHING SYSTEM INLET DISTRIBUTOR	1.000	PC																																																																													
VL1214A0	BAYONET - 6mm BARBED NRV VALVE	1.000	PC																																																																													
VL1398A0	1/4 M N.O. CIL PRESSURE SWITCH	1.000	PC																																																																													
VM1605A0	CLIP TWIST LOCK DIAM. 10,2-12,7 MM	3.000	PC																																																																													
VM2172A0	LOCKING CLIP FOR PUMP WITH CIRCUIT	9.000	PC																																																																													
Code	Description	Qty	UOM																																																																													
0H2354A1	XEVC-XEVL PLUS WASHING CIRCUIT PLAT	1.000	PC																																																																													
EL1450A0	US SELF-CLEANING WATER SOLENOID	4.000	PC																																																																													





COMPONENT			SPARE PART																																																																																		
Code	Description	Image	Code	Description	Kit components																																																																																
VL1166A	BB6-AR6 L FITTING		KVL1208A	US PLUS 2 ROTOR ARMS WASHING SYSTEM KIT	<table border="1"> <thead> <tr> <th>Code</th> <th>Description</th> <th>Qty</th> <th>UOM</th> </tr> </thead> <tbody> <tr> <td>GN1526A0</td> <td>INT. D.=6.9 TH=1.8 O-RIN</td> <td>9.000</td> <td>PC</td> </tr> <tr> <td>RC1018A0</td> <td>ZINC PLATED D12 ELASTIC CLAMP</td> <td>3.000</td> <td>PC</td> </tr> <tr> <td>RC1019A0</td> <td>D=10 ELASTIC CLAMP</td> <td>2.000</td> <td>PC</td> </tr> <tr> <td>RC1130A0</td> <td>130x2.6 CLAM</td> <td>1.000</td> <td>PC</td> </tr> <tr> <td>RC1131A0</td> <td>200x2.6 BLACK CLAMP</td> <td>3.000</td> <td>PC</td> </tr> <tr> <td>RC1242A0</td> <td>D=10 CLOSED CAP</td> <td>2.000</td> <td>PC</td> </tr> <tr> <td>RC1356A0</td> <td>"STRAIGHT THREADED FEMALE END 8x1/4" BS</td> <td>1.000</td> <td>PC</td> </tr> <tr> <td>TB2821A0</td> <td>EPDM 6X10 L=40MM PIPE</td> <td>6.000</td> <td>PC</td> </tr> <tr> <td>TB2994A0</td> <td>HOOD DETERGENT PIPE</td> <td>1.000</td> <td>PC</td> </tr> <tr> <td>TB3004A0</td> <td>TB2820A L=550mm EPDM BLACK PIPE</td> <td>1.000</td> <td>PC</td> </tr> <tr> <td>TB3005B0</td> <td>TB3132A L=550mm EPDM WHITE-BLUE PIPE</td> <td>1.000</td> <td>PC</td> </tr> <tr> <td>TB3440A0</td> <td>TB3132A L=1050mm EPDM WHITE-BLUE PIPE</td> <td>1.000</td> <td>PC</td> </tr> <tr> <td>VL1019A0</td> <td>VIBRATION DETERGENT PUMP</td> <td>1.000</td> <td>PC</td> </tr> <tr> <td>VL1047A1</td> <td>D6 PIPE HOLDER - D8 J.G. TERMINAL</td> <td>1.000</td> <td>PC</td> </tr> <tr> <td>VL1102A1</td> <td>DETERGENT LINE FILTER + BARBED VNR 6 MM</td> <td>1.000</td> <td>PC</td> </tr> <tr> <td>VL1128A1</td> <td>D6 BARBED CHECK VALVE</td> <td>2.000</td> <td>PC</td> </tr> <tr> <td>VL1141A1</td> <td>BB6-BB6 STRAIGHT CONNECTION</td> <td>1.000</td> <td>PC</td> </tr> <tr> <td>VL1166A0</td> <td>BB6-AR6 L FITTING</td> <td>4.000</td> <td>PC</td> </tr> <tr> <td>VL1174C0</td> <td>D1.2 MM CALIBRATED D1.2 MM</td> <td>1.000</td> <td>PC</td> </tr> </tbody> </table>	Code	Description	Qty	UOM	GN1526A0	INT. D.=6.9 TH=1.8 O-RIN	9.000	PC	RC1018A0	ZINC PLATED D12 ELASTIC CLAMP	3.000	PC	RC1019A0	D=10 ELASTIC CLAMP	2.000	PC	RC1130A0	130x2.6 CLAM	1.000	PC	RC1131A0	200x2.6 BLACK CLAMP	3.000	PC	RC1242A0	D=10 CLOSED CAP	2.000	PC	RC1356A0	"STRAIGHT THREADED FEMALE END 8x1/4" BS	1.000	PC	TB2821A0	EPDM 6X10 L=40MM PIPE	6.000	PC	TB2994A0	HOOD DETERGENT PIPE	1.000	PC	TB3004A0	TB2820A L=550mm EPDM BLACK PIPE	1.000	PC	TB3005B0	TB3132A L=550mm EPDM WHITE-BLUE PIPE	1.000	PC	TB3440A0	TB3132A L=1050mm EPDM WHITE-BLUE PIPE	1.000	PC	VL1019A0	VIBRATION DETERGENT PUMP	1.000	PC	VL1047A1	D6 PIPE HOLDER - D8 J.G. TERMINAL	1.000	PC	VL1102A1	DETERGENT LINE FILTER + BARBED VNR 6 MM	1.000	PC	VL1128A1	D6 BARBED CHECK VALVE	2.000	PC	VL1141A1	BB6-BB6 STRAIGHT CONNECTION	1.000	PC	VL1166A0	BB6-AR6 L FITTING	4.000	PC	VL1174C0	D1.2 MM CALIBRATED D1.2 MM	1.000	PC
Code	Description	Qty	UOM																																																																																		
GN1526A0	INT. D.=6.9 TH=1.8 O-RIN	9.000	PC																																																																																		
RC1018A0	ZINC PLATED D12 ELASTIC CLAMP	3.000	PC																																																																																		
RC1019A0	D=10 ELASTIC CLAMP	2.000	PC																																																																																		
RC1130A0	130x2.6 CLAM	1.000	PC																																																																																		
RC1131A0	200x2.6 BLACK CLAMP	3.000	PC																																																																																		
RC1242A0	D=10 CLOSED CAP	2.000	PC																																																																																		
RC1356A0	"STRAIGHT THREADED FEMALE END 8x1/4" BS	1.000	PC																																																																																		
TB2821A0	EPDM 6X10 L=40MM PIPE	6.000	PC																																																																																		
TB2994A0	HOOD DETERGENT PIPE	1.000	PC																																																																																		
TB3004A0	TB2820A L=550mm EPDM BLACK PIPE	1.000	PC																																																																																		
TB3005B0	TB3132A L=550mm EPDM WHITE-BLUE PIPE	1.000	PC																																																																																		
TB3440A0	TB3132A L=1050mm EPDM WHITE-BLUE PIPE	1.000	PC																																																																																		
VL1019A0	VIBRATION DETERGENT PUMP	1.000	PC																																																																																		
VL1047A1	D6 PIPE HOLDER - D8 J.G. TERMINAL	1.000	PC																																																																																		
VL1102A1	DETERGENT LINE FILTER + BARBED VNR 6 MM	1.000	PC																																																																																		
VL1128A1	D6 BARBED CHECK VALVE	2.000	PC																																																																																		
VL1141A1	BB6-BB6 STRAIGHT CONNECTION	1.000	PC																																																																																		
VL1166A0	BB6-AR6 L FITTING	4.000	PC																																																																																		
VL1174C0	D1.2 MM CALIBRATED D1.2 MM	1.000	PC																																																																																		





COMPONENT			SPARE PART																																															
Code	Description	Image	Code	Description	Kit components																																													
VL1166A	BB6-AR6 L FITTING		KVL1208A	US PLUS 2 ROTOR ARMS WASHING SYSTEM KIT	<table border="1"> <thead> <tr> <th>Code</th> <th>Description</th> <th>Qty</th> <th>UOM</th> </tr> </thead> <tbody> <tr> <td>VL1186A0</td> <td>3 WAYS PLUS WASHING DISTRIBUTOR</td> <td>1.000</td> <td>PC</td> </tr> <tr> <td>VL1190A0</td> <td>PLUS WASHING SYSTEM INLET DISTRIBUTOR</td> <td>1.000</td> <td>PC</td> </tr> <tr> <td>VL1214A0</td> <td>BAYONET - 6mm BARBED NRV VALVE</td> <td>1.000</td> <td>PC</td> </tr> <tr> <td>VL1398A0</td> <td>1/4 M N.O. CIL PRESSURE SWITCH</td> <td>1.000</td> <td>PC</td> </tr> <tr> <td>VM1605A0</td> <td>CLIP TWIST LOCK DIAM. 10,2-12,7 MM</td> <td>3.000</td> <td>PC</td> </tr> <tr> <td>VM2172A0</td> <td>LOCKING CLIP FOR PUMP WITH CIRCUIT</td> <td>5.000</td> <td>PC</td> </tr> </tbody> </table>	Code	Description	Qty	UOM	VL1186A0	3 WAYS PLUS WASHING DISTRIBUTOR	1.000	PC	VL1190A0	PLUS WASHING SYSTEM INLET DISTRIBUTOR	1.000	PC	VL1214A0	BAYONET - 6mm BARBED NRV VALVE	1.000	PC	VL1398A0	1/4 M N.O. CIL PRESSURE SWITCH	1.000	PC	VM1605A0	CLIP TWIST LOCK DIAM. 10,2-12,7 MM	3.000	PC	VM2172A0	LOCKING CLIP FOR PUMP WITH CIRCUIT	5.000	PC																	
			Code	Description	Qty	UOM																																												
VL1186A0	3 WAYS PLUS WASHING DISTRIBUTOR	1.000	PC																																															
VL1190A0	PLUS WASHING SYSTEM INLET DISTRIBUTOR	1.000	PC																																															
VL1214A0	BAYONET - 6mm BARBED NRV VALVE	1.000	PC																																															
VL1398A0	1/4 M N.O. CIL PRESSURE SWITCH	1.000	PC																																															
VM1605A0	CLIP TWIST LOCK DIAM. 10,2-12,7 MM	3.000	PC																																															
VM2172A0	LOCKING CLIP FOR PUMP WITH CIRCUIT	5.000	PC																																															
KVL1207A	US PLUS 1 ROTOR ARM WASHING SYSTEM KIT	<table border="1"> <thead> <tr> <th>Code</th> <th>Description</th> <th>Qty</th> <th>UOM</th> </tr> </thead> <tbody> <tr> <td>0H2354A1</td> <td>XEVC-XEVL PLUS WASHING CIRCUIT PLAT</td> <td>1.000</td> <td>PC</td> </tr> <tr> <td>EL1450A0</td> <td>US SELF-CLEANIN G WATER SOLENOID</td> <td>3.000</td> <td>PC</td> </tr> <tr> <td>GN1526A0</td> <td>INT. D.=6.9 TH=1.8 O-RIN</td> <td>7.000</td> <td>PC</td> </tr> <tr> <td>RC1018A0</td> <td>ZINC PLATED D12 ELASTIC CLAMP</td> <td>2.000</td> <td>PC</td> </tr> <tr> <td>RC1019A0</td> <td>D=10 ELASTIC CLAMP</td> <td>14.000</td> <td>PC</td> </tr> <tr> <td>RC1130A0</td> <td>130x2,6 CLAM</td> <td>1.000</td> <td>PC</td> </tr> <tr> <td>RC1131A0</td> <td>200x2,6 BLACK CLAMP</td> <td>2.000</td> <td>PC</td> </tr> <tr> <td>RC1242A0</td> <td>D=10 CLOSED CAP</td> <td>2.000</td> <td>PC</td> </tr> <tr> <td>RC1356A0</td> <td>"STRAIGHT THREADED FEMALE END 8x1/4" BS</td> <td>1.000</td> <td>PC</td> </tr> <tr> <td>TB2821A0</td> <td>EPDM 6X10 L=40MM PIPE</td> <td>6.000</td> <td>PC</td> </tr> <tr> <td>TB3004A0</td> <td>TB2820A L=550mm EPDM BLACK PIPE</td> <td>1.000</td> <td>PC</td> </tr> </tbody> </table>	Code	Description	Qty	UOM	0H2354A1	XEVC-XEVL PLUS WASHING CIRCUIT PLAT	1.000	PC	EL1450A0	US SELF-CLEANIN G WATER SOLENOID	3.000	PC	GN1526A0	INT. D.=6.9 TH=1.8 O-RIN	7.000	PC	RC1018A0	ZINC PLATED D12 ELASTIC CLAMP	2.000	PC	RC1019A0	D=10 ELASTIC CLAMP	14.000	PC	RC1130A0	130x2,6 CLAM	1.000	PC	RC1131A0	200x2,6 BLACK CLAMP	2.000	PC	RC1242A0	D=10 CLOSED CAP	2.000	PC	RC1356A0	"STRAIGHT THREADED FEMALE END 8x1/4" BS	1.000	PC	TB2821A0	EPDM 6X10 L=40MM PIPE	6.000	PC	TB3004A0	TB2820A L=550mm EPDM BLACK PIPE	1.000	PC
Code	Description	Qty	UOM																																															
0H2354A1	XEVC-XEVL PLUS WASHING CIRCUIT PLAT	1.000	PC																																															
EL1450A0	US SELF-CLEANIN G WATER SOLENOID	3.000	PC																																															
GN1526A0	INT. D.=6.9 TH=1.8 O-RIN	7.000	PC																																															
RC1018A0	ZINC PLATED D12 ELASTIC CLAMP	2.000	PC																																															
RC1019A0	D=10 ELASTIC CLAMP	14.000	PC																																															
RC1130A0	130x2,6 CLAM	1.000	PC																																															
RC1131A0	200x2,6 BLACK CLAMP	2.000	PC																																															
RC1242A0	D=10 CLOSED CAP	2.000	PC																																															
RC1356A0	"STRAIGHT THREADED FEMALE END 8x1/4" BS	1.000	PC																																															
TB2821A0	EPDM 6X10 L=40MM PIPE	6.000	PC																																															
TB3004A0	TB2820A L=550mm EPDM BLACK PIPE	1.000	PC																																															



COMPONENT			SPARE PART																																																																		
Code	Description	Image	Code	Description	Kit components																																																																
VL1166A	BB6-AR6 L FITTING		KVL1207A	US PLUS 1 ROTOR ARM WASHING SYSTEM KIT	<table border="1"> <thead> <tr> <th>Code</th> <th>Description</th> <th>Qty</th> <th>UOM</th> </tr> </thead> <tbody> <tr> <td>TB3005B0</td> <td>TB3132A L=550mm EPDM WHITE-BLUE PIPE</td> <td>1.000</td> <td>PC</td> </tr> <tr> <td>TB3225B0</td> <td>TB2820A-TAN K-WASHYNG SYS CONNECTION</td> <td>1.000</td> <td>PC</td> </tr> <tr> <td>TB3252A0</td> <td></td> <td>1.000</td> <td>PC</td> </tr> <tr> <td>VL1019A0</td> <td>VIBRATION DETERGENT PUMP</td> <td>1.000</td> <td>PC</td> </tr> <tr> <td>VL1047A1</td> <td>D6 PIPE HOLDER - D8 J.G. TERMINAL</td> <td>1.000</td> <td>PC</td> </tr> <tr> <td>VL1102A1</td> <td>DETERGENT LINE FILTER + BARBED VNR 6 MM</td> <td>1.000</td> <td>PC</td> </tr> <tr> <td>VL1128A1</td> <td>D6 BARBED CHECK VALVE</td> <td>2.000</td> <td>PC</td> </tr> <tr> <td>VL1166A0</td> <td>BB6-AR6 L FITTING</td> <td>3.000</td> <td>PC</td> </tr> <tr> <td>VL1174C0</td> <td>D1.2 MM CALIBRATED D1.2 MM</td> <td>1.000</td> <td>PC</td> </tr> <tr> <td>VL1185A0</td> <td>2 WAYS PLUS WASHING DISTRIBUTOR</td> <td>1.000</td> <td>PC</td> </tr> <tr> <td>VL1190A0</td> <td>PLUS WASHING SYSTEM INLET DISTRIBUTOR</td> <td>1.000</td> <td>PC</td> </tr> <tr> <td>VL1214A0</td> <td>BAYONET - 6mm BARBED NRV VALVE</td> <td>1.000</td> <td>PC</td> </tr> <tr> <td>VL1398A0</td> <td>1/4 M N.O. CIL PRESSURE SWITCH</td> <td>1.000</td> <td>PC</td> </tr> <tr> <td>VM1605A0</td> <td>CLIP TWIST LOCK DIAM. 10,2-12,7 MM</td> <td>3.000</td> <td>PC</td> </tr> <tr> <td>VM2172A0</td> <td>LOCKING CLIP FOR PUMP WITH CIRCUIT</td> <td>3.000</td> <td>PC</td> </tr> </tbody> </table>	Code	Description	Qty	UOM	TB3005B0	TB3132A L=550mm EPDM WHITE-BLUE PIPE	1.000	PC	TB3225B0	TB2820A-TAN K-WASHYNG SYS CONNECTION	1.000	PC	TB3252A0		1.000	PC	VL1019A0	VIBRATION DETERGENT PUMP	1.000	PC	VL1047A1	D6 PIPE HOLDER - D8 J.G. TERMINAL	1.000	PC	VL1102A1	DETERGENT LINE FILTER + BARBED VNR 6 MM	1.000	PC	VL1128A1	D6 BARBED CHECK VALVE	2.000	PC	VL1166A0	BB6-AR6 L FITTING	3.000	PC	VL1174C0	D1.2 MM CALIBRATED D1.2 MM	1.000	PC	VL1185A0	2 WAYS PLUS WASHING DISTRIBUTOR	1.000	PC	VL1190A0	PLUS WASHING SYSTEM INLET DISTRIBUTOR	1.000	PC	VL1214A0	BAYONET - 6mm BARBED NRV VALVE	1.000	PC	VL1398A0	1/4 M N.O. CIL PRESSURE SWITCH	1.000	PC	VM1605A0	CLIP TWIST LOCK DIAM. 10,2-12,7 MM	3.000	PC	VM2172A0	LOCKING CLIP FOR PUMP WITH CIRCUIT	3.000	PC
Code	Description	Qty	UOM																																																																		
TB3005B0	TB3132A L=550mm EPDM WHITE-BLUE PIPE	1.000	PC																																																																		
TB3225B0	TB2820A-TAN K-WASHYNG SYS CONNECTION	1.000	PC																																																																		
TB3252A0		1.000	PC																																																																		
VL1019A0	VIBRATION DETERGENT PUMP	1.000	PC																																																																		
VL1047A1	D6 PIPE HOLDER - D8 J.G. TERMINAL	1.000	PC																																																																		
VL1102A1	DETERGENT LINE FILTER + BARBED VNR 6 MM	1.000	PC																																																																		
VL1128A1	D6 BARBED CHECK VALVE	2.000	PC																																																																		
VL1166A0	BB6-AR6 L FITTING	3.000	PC																																																																		
VL1174C0	D1.2 MM CALIBRATED D1.2 MM	1.000	PC																																																																		
VL1185A0	2 WAYS PLUS WASHING DISTRIBUTOR	1.000	PC																																																																		
VL1190A0	PLUS WASHING SYSTEM INLET DISTRIBUTOR	1.000	PC																																																																		
VL1214A0	BAYONET - 6mm BARBED NRV VALVE	1.000	PC																																																																		
VL1398A0	1/4 M N.O. CIL PRESSURE SWITCH	1.000	PC																																																																		
VM1605A0	CLIP TWIST LOCK DIAM. 10,2-12,7 MM	3.000	PC																																																																		
VM2172A0	LOCKING CLIP FOR PUMP WITH CIRCUIT	3.000	PC																																																																		
			KVL1198A	MM EU HOOD CLEANING SYSTEM KIT	<table border="1"> <thead> <tr> <th>Code</th> <th>Description</th> <th>Qty</th> <th>UOM</th> </tr> </thead> <tbody> <tr> <td>0H2213A1</td> <td>HOOD WATER CIRCUIT PLAT</td> <td>1.000</td> <td>PC</td> </tr> <tr> <td>EL1440A0</td> <td>WATER SELF CLEANING VALVE</td> <td>2.000</td> <td>PC</td> </tr> </tbody> </table>	Code	Description	Qty	UOM	0H2213A1	HOOD WATER CIRCUIT PLAT	1.000	PC	EL1440A0	WATER SELF CLEANING VALVE	2.000	PC																																																				
Code	Description	Qty	UOM																																																																		
0H2213A1	HOOD WATER CIRCUIT PLAT	1.000	PC																																																																		
EL1440A0	WATER SELF CLEANING VALVE	2.000	PC																																																																		

COMPONENT			SPARE PART																																																																																						
Code	Description	Image	Code	Description	Kit components																																																																																				
VL1166A	BB6-AR6 L FITTING		KVL1198A	MM EU HOOD CLEANING SYSTEM KIT	<table border="1"> <thead> <tr> <th>Code</th> <th>Description</th> <th>Qty</th> <th>UOM</th> </tr> </thead> <tbody> <tr> <td>GN1526A0</td> <td>INT. D.=6.9 TH=1.8 O-RIN</td> <td>5.000</td> <td>PC</td> </tr> <tr> <td>RC1018A0</td> <td>ZINC PLATED D12 ELASTIC CLAMP</td> <td>4.000</td> <td>PC</td> </tr> <tr> <td>RC1019A0</td> <td>D=10 ELASTIC CLAMP</td> <td>16.000</td> <td>PC</td> </tr> <tr> <td>RC1131A0</td> <td>200x2.6 BLACK CLAMP</td> <td>1.000</td> <td>PC</td> </tr> <tr> <td>RC1242A0</td> <td>D=10 CLOSED CAP</td> <td>2.000</td> <td>PC</td> </tr> <tr> <td>TB2821A0</td> <td>EPDM 6X10 L=40MM PIPE</td> <td>6.000</td> <td>PC</td> </tr> <tr> <td>TB2994A0</td> <td>HOOD DETERGENT PIPE</td> <td>2.000</td> <td>PC</td> </tr> <tr> <td>TB3252A0</td> <td></td> <td>2.000</td> <td>PC</td> </tr> <tr> <td>VI1220A1</td> <td>4,2x12 TCB SELF-TAPPIN G SCREW</td> <td>3.000</td> <td>PC</td> </tr> <tr> <td>VL1019A0</td> <td>VIBRATION DETERGENT PUMP</td> <td>1.000</td> <td>PC</td> </tr> <tr> <td>VL1047A1</td> <td>D6 PIPE HOLDER - D8 J.G. TERMINAL</td> <td>2.000</td> <td>PC</td> </tr> <tr> <td>VL1054B0</td> <td>ONE WASHING SYS INLET DISTRIBUTOR</td> <td>1.000</td> <td>PC</td> </tr> <tr> <td>VL1102A1</td> <td>DETERGENT LINE FILTER + BARBED VNR 6 MM</td> <td>1.000</td> <td>PC</td> </tr> <tr> <td>VL1127A1</td> <td>6mm BARBED T-SHAPED FITTING</td> <td>1.000</td> <td>PC</td> </tr> <tr> <td>VL1128A1</td> <td>D6 BARBED CHECK VALVE</td> <td>2.000</td> <td>PC</td> </tr> <tr> <td>VL1165A0</td> <td>BAM-BB6 STRAIGHT FITTING</td> <td>1.000</td> <td>PC</td> </tr> <tr> <td>VL1166A0</td> <td>BB6-AR6 L FITTING</td> <td>2.000</td> <td>PC</td> </tr> <tr> <td>VL1174C0</td> <td>D1.2 MM CALIBRATED D1.2 MM</td> <td>1.000</td> <td>PC</td> </tr> <tr> <td>VL1191A0</td> <td>ONE WASHING DISTRIBUTOR OUTLETS KIT</td> <td>1.000</td> <td>PC</td> </tr> <tr> <td>VL1214A0</td> <td>BAYONET - 6mm BARBED NRV VALVE</td> <td>1.000</td> <td>PC</td> </tr> </tbody> </table>	Code	Description	Qty	UOM	GN1526A0	INT. D.=6.9 TH=1.8 O-RIN	5.000	PC	RC1018A0	ZINC PLATED D12 ELASTIC CLAMP	4.000	PC	RC1019A0	D=10 ELASTIC CLAMP	16.000	PC	RC1131A0	200x2.6 BLACK CLAMP	1.000	PC	RC1242A0	D=10 CLOSED CAP	2.000	PC	TB2821A0	EPDM 6X10 L=40MM PIPE	6.000	PC	TB2994A0	HOOD DETERGENT PIPE	2.000	PC	TB3252A0		2.000	PC	VI1220A1	4,2x12 TCB SELF-TAPPIN G SCREW	3.000	PC	VL1019A0	VIBRATION DETERGENT PUMP	1.000	PC	VL1047A1	D6 PIPE HOLDER - D8 J.G. TERMINAL	2.000	PC	VL1054B0	ONE WASHING SYS INLET DISTRIBUTOR	1.000	PC	VL1102A1	DETERGENT LINE FILTER + BARBED VNR 6 MM	1.000	PC	VL1127A1	6mm BARBED T-SHAPED FITTING	1.000	PC	VL1128A1	D6 BARBED CHECK VALVE	2.000	PC	VL1165A0	BAM-BB6 STRAIGHT FITTING	1.000	PC	VL1166A0	BB6-AR6 L FITTING	2.000	PC	VL1174C0	D1.2 MM CALIBRATED D1.2 MM	1.000	PC	VL1191A0	ONE WASHING DISTRIBUTOR OUTLETS KIT	1.000	PC	VL1214A0	BAYONET - 6mm BARBED NRV VALVE	1.000	PC
Code	Description	Qty	UOM																																																																																						
GN1526A0	INT. D.=6.9 TH=1.8 O-RIN	5.000	PC																																																																																						
RC1018A0	ZINC PLATED D12 ELASTIC CLAMP	4.000	PC																																																																																						
RC1019A0	D=10 ELASTIC CLAMP	16.000	PC																																																																																						
RC1131A0	200x2.6 BLACK CLAMP	1.000	PC																																																																																						
RC1242A0	D=10 CLOSED CAP	2.000	PC																																																																																						
TB2821A0	EPDM 6X10 L=40MM PIPE	6.000	PC																																																																																						
TB2994A0	HOOD DETERGENT PIPE	2.000	PC																																																																																						
TB3252A0		2.000	PC																																																																																						
VI1220A1	4,2x12 TCB SELF-TAPPIN G SCREW	3.000	PC																																																																																						
VL1019A0	VIBRATION DETERGENT PUMP	1.000	PC																																																																																						
VL1047A1	D6 PIPE HOLDER - D8 J.G. TERMINAL	2.000	PC																																																																																						
VL1054B0	ONE WASHING SYS INLET DISTRIBUTOR	1.000	PC																																																																																						
VL1102A1	DETERGENT LINE FILTER + BARBED VNR 6 MM	1.000	PC																																																																																						
VL1127A1	6mm BARBED T-SHAPED FITTING	1.000	PC																																																																																						
VL1128A1	D6 BARBED CHECK VALVE	2.000	PC																																																																																						
VL1165A0	BAM-BB6 STRAIGHT FITTING	1.000	PC																																																																																						
VL1166A0	BB6-AR6 L FITTING	2.000	PC																																																																																						
VL1174C0	D1.2 MM CALIBRATED D1.2 MM	1.000	PC																																																																																						
VL1191A0	ONE WASHING DISTRIBUTOR OUTLETS KIT	1.000	PC																																																																																						
VL1214A0	BAYONET - 6mm BARBED NRV VALVE	1.000	PC																																																																																						

COMPONENT			SPARE PART																																																																															
Code	Description	Image	Code	Description	Kit components																																																																													
VL1166A	BB6-AR6 L FITTING		KVL1198A	MM EU HOOD CLEANING SYSTEM KIT	<table border="1"> <thead> <tr> <th>Code</th> <th>Description</th> <th>Qty</th> <th>UOM</th> </tr> </thead> <tbody> <tr> <td>VM1605A0</td> <td>CLIP TWIST LOCK DIAM. 10,2-12,7 MM</td> <td>2.000</td> <td>PC</td> </tr> <tr> <td>VM2172A0</td> <td>LOCKING CLIP FOR PUMP WITH CIRCUIT</td> <td>5.000</td> <td>PC</td> </tr> </tbody> </table>	Code	Description	Qty	UOM	VM1605A0	CLIP TWIST LOCK DIAM. 10,2-12,7 MM	2.000	PC	VM2172A0	LOCKING CLIP FOR PUMP WITH CIRCUIT	5.000	PC																																																																	
			Code	Description	Qty	UOM																																																																												
VM1605A0	CLIP TWIST LOCK DIAM. 10,2-12,7 MM	2.000	PC																																																																															
VM2172A0	LOCKING CLIP FOR PUMP WITH CIRCUIT	5.000	PC																																																																															
KVL1187A	3 ROTOR ARMS PLUS EU CLEANING SYSTEM KIT	<table border="1"> <thead> <tr> <th>Code</th> <th>Description</th> <th>Qty</th> <th>UOM</th> </tr> </thead> <tbody> <tr> <td>0H2354A1</td> <td>XEVC-XEVL PLUS WASHING CIRCUIT PLAT</td> <td>1.000</td> <td>PC</td> </tr> <tr> <td>EL1440A0</td> <td>WATER SELF CLEANING VALVE</td> <td>4.000</td> <td>PC</td> </tr> <tr> <td>GN1526A0</td> <td>INT. D.=6.9 TH=1.8 O-RIN</td> <td>9.000</td> <td>PC</td> </tr> <tr> <td>RC1018A0</td> <td>ZINC PLATED D12 ELASTIC CLAMP</td> <td>11.000</td> <td>PC</td> </tr> <tr> <td>RC1019A0</td> <td>D=10 ELASTIC CLAMP</td> <td>16.000</td> <td>PC</td> </tr> <tr> <td>RC1130A0</td> <td>130x2,6 CLAM</td> <td>1.000</td> <td>PC</td> </tr> <tr> <td>RC1131A0</td> <td>200x2,6 BLACK CLAMP</td> <td>3.000</td> <td>PC</td> </tr> <tr> <td>RC1242A0</td> <td>D=10 CLOSED CAP</td> <td>2.000</td> <td>PC</td> </tr> <tr> <td>RC1356A0</td> <td>"STRAIGHT THREADED FEMALE END 8x1/4" BS</td> <td>1.000</td> <td>PC</td> </tr> <tr> <td>TB2652A0</td> <td></td> <td>1.000</td> <td>PC</td> </tr> <tr> <td>TB2677A0</td> <td></td> <td>1.000</td> <td>PC</td> </tr> <tr> <td>TB2821A0</td> <td>EPDM 6X10 L=40MM PIPE</td> <td>6.000</td> <td>PC</td> </tr> <tr> <td>TB3004A0</td> <td>TB2820A L=550mm EPDM BLACK PIPE</td> <td>2.000</td> <td>PC</td> </tr> <tr> <td>TB3024C0</td> <td></td> <td>3.000</td> <td>PC</td> </tr> <tr> <td>TB3226A0</td> <td></td> <td>1.000</td> <td>PC</td> </tr> <tr> <td>TB3440A0</td> <td>TB3132A L=1050mm EPDM WHITE-BLUE PIPE</td> <td>1.000</td> <td>PC</td> </tr> <tr> <td>VL1019A0</td> <td>VIBRATION DETERGENT PUMP</td> <td>1.000</td> <td>PC</td> </tr> <tr> <td>VL1047A1</td> <td>D6 PIPE HOLDER - D8 J.G. TERMINAL</td> <td>1.000</td> <td>PC</td> </tr> <tr> <td>VL1102A1</td> <td>DETERGENT LINE FILTER + BARBED VNR 6 MM</td> <td>1.000</td> <td>PC</td> </tr> </tbody> </table>	Code	Description	Qty	UOM	0H2354A1	XEVC-XEVL PLUS WASHING CIRCUIT PLAT	1.000	PC	EL1440A0	WATER SELF CLEANING VALVE	4.000	PC	GN1526A0	INT. D.=6.9 TH=1.8 O-RIN	9.000	PC	RC1018A0	ZINC PLATED D12 ELASTIC CLAMP	11.000	PC	RC1019A0	D=10 ELASTIC CLAMP	16.000	PC	RC1130A0	130x2,6 CLAM	1.000	PC	RC1131A0	200x2,6 BLACK CLAMP	3.000	PC	RC1242A0	D=10 CLOSED CAP	2.000	PC	RC1356A0	"STRAIGHT THREADED FEMALE END 8x1/4" BS	1.000	PC	TB2652A0		1.000	PC	TB2677A0		1.000	PC	TB2821A0	EPDM 6X10 L=40MM PIPE	6.000	PC	TB3004A0	TB2820A L=550mm EPDM BLACK PIPE	2.000	PC	TB3024C0		3.000	PC	TB3226A0		1.000	PC	TB3440A0	TB3132A L=1050mm EPDM WHITE-BLUE PIPE	1.000	PC	VL1019A0	VIBRATION DETERGENT PUMP	1.000	PC	VL1047A1	D6 PIPE HOLDER - D8 J.G. TERMINAL	1.000	PC	VL1102A1	DETERGENT LINE FILTER + BARBED VNR 6 MM	1.000	PC
Code	Description	Qty	UOM																																																																															
0H2354A1	XEVC-XEVL PLUS WASHING CIRCUIT PLAT	1.000	PC																																																																															
EL1440A0	WATER SELF CLEANING VALVE	4.000	PC																																																																															
GN1526A0	INT. D.=6.9 TH=1.8 O-RIN	9.000	PC																																																																															
RC1018A0	ZINC PLATED D12 ELASTIC CLAMP	11.000	PC																																																																															
RC1019A0	D=10 ELASTIC CLAMP	16.000	PC																																																																															
RC1130A0	130x2,6 CLAM	1.000	PC																																																																															
RC1131A0	200x2,6 BLACK CLAMP	3.000	PC																																																																															
RC1242A0	D=10 CLOSED CAP	2.000	PC																																																																															
RC1356A0	"STRAIGHT THREADED FEMALE END 8x1/4" BS	1.000	PC																																																																															
TB2652A0		1.000	PC																																																																															
TB2677A0		1.000	PC																																																																															
TB2821A0	EPDM 6X10 L=40MM PIPE	6.000	PC																																																																															
TB3004A0	TB2820A L=550mm EPDM BLACK PIPE	2.000	PC																																																																															
TB3024C0		3.000	PC																																																																															
TB3226A0		1.000	PC																																																																															
TB3440A0	TB3132A L=1050mm EPDM WHITE-BLUE PIPE	1.000	PC																																																																															
VL1019A0	VIBRATION DETERGENT PUMP	1.000	PC																																																																															
VL1047A1	D6 PIPE HOLDER - D8 J.G. TERMINAL	1.000	PC																																																																															
VL1102A1	DETERGENT LINE FILTER + BARBED VNR 6 MM	1.000	PC																																																																															

COMPONENT			SPARE PART																																																																																									
Code	Description	Image	Code	Description	Kit components																																																																																							
VL1166A	BB6-AR6 L FITTING		KVL1187A	3 ROTOR ARMS PLUS EU CLEANING SYSTEM KIT	<table border="1"> <thead> <tr> <th>Code</th> <th>Description</th> <th>Qty</th> <th>UOM</th> </tr> </thead> <tbody> <tr> <td>VL1127A1</td> <td>6mm BARBED T-SHAPED FITTING</td> <td>2.000</td> <td>PC</td> </tr> <tr> <td>VL1128A1</td> <td>D6 BARBED CHECK VALVE</td> <td>3.000</td> <td>PC</td> </tr> <tr> <td>VL1166A0</td> <td>BB6-AR6 L FITTING</td> <td>4.000</td> <td>PC</td> </tr> <tr> <td>VL1167A2</td> <td>GN21 3 ROTOR ARMS B-B FLOW RESTRICTOR</td> <td>1.000</td> <td>PC</td> </tr> <tr> <td>VL1174C0</td> <td>D1.2 MM CALIBRATED D1.2 MM</td> <td>1.000</td> <td>PC</td> </tr> <tr> <td>VL1186A0</td> <td>3 WAYS PLUS WASHING DISTRIBUTOR</td> <td>1.000</td> <td>PC</td> </tr> <tr> <td>VL1190A0</td> <td>PLUS WASHING SYSTEM INLET DISTRIBUTOR</td> <td>1.000</td> <td>PC</td> </tr> <tr> <td>VL1214A0</td> <td>BAYONET - 6mm BARBED NRV VALVE</td> <td>1.000</td> <td>PC</td> </tr> <tr> <td>VL1398A0</td> <td>1/4 M N.O. CIL PRESSURE SWITCH</td> <td>1.000</td> <td>PC</td> </tr> <tr> <td>VM1605A0</td> <td>CLIP TWIST LOCK DIAM. 10.2-12.7 MM</td> <td>3.000</td> <td>PC</td> </tr> <tr> <td>VM2172A0</td> <td>LOCKING CLIP FOR PUMP WITH CIRCUIT</td> <td>5.000</td> <td>PC</td> </tr> </tbody> </table>	Code	Description	Qty	UOM	VL1127A1	6mm BARBED T-SHAPED FITTING	2.000	PC	VL1128A1	D6 BARBED CHECK VALVE	3.000	PC	VL1166A0	BB6-AR6 L FITTING	4.000	PC	VL1167A2	GN21 3 ROTOR ARMS B-B FLOW RESTRICTOR	1.000	PC	VL1174C0	D1.2 MM CALIBRATED D1.2 MM	1.000	PC	VL1186A0	3 WAYS PLUS WASHING DISTRIBUTOR	1.000	PC	VL1190A0	PLUS WASHING SYSTEM INLET DISTRIBUTOR	1.000	PC	VL1214A0	BAYONET - 6mm BARBED NRV VALVE	1.000	PC	VL1398A0	1/4 M N.O. CIL PRESSURE SWITCH	1.000	PC	VM1605A0	CLIP TWIST LOCK DIAM. 10.2-12.7 MM	3.000	PC	VM2172A0	LOCKING CLIP FOR PUMP WITH CIRCUIT	5.000	PC	KVL1184A	2 ROTOR ARMS PLUS EU CLEANING SYSTEM KIT	<table border="1"> <thead> <tr> <th>Code</th> <th>Description</th> <th>Qty</th> <th>UOM</th> </tr> </thead> <tbody> <tr> <td>0H2354A1</td> <td>XEVC-XEVL PLUS WASHING CIRCUIT PLAT</td> <td>1.000</td> <td>PC</td> </tr> <tr> <td>EL1440A0</td> <td>WATER SELF CLEANING VALVE</td> <td>4.000</td> <td>PC</td> </tr> <tr> <td>GN1526A0</td> <td>INT. D.=6.9 TH=1.8 O-RIN</td> <td>9.000</td> <td>PC</td> </tr> <tr> <td>RC1018A0</td> <td>ZINC PLATED D12 ELASTIC CLAMP</td> <td>3.000</td> <td>PC</td> </tr> <tr> <td>RC1019A0</td> <td>D=10 ELASTIC CLAMP</td> <td>15.000</td> <td>PC</td> </tr> <tr> <td>RC1130A0</td> <td>130x2.6 CLAM</td> <td>1.000</td> <td>PC</td> </tr> <tr> <td>RC1131A0</td> <td>200x2.6 BLACK CLAMP</td> <td>3.000</td> <td>PC</td> </tr> <tr> <td>RC1242A0</td> <td>D=10 CLOSED CAP</td> <td>2.000</td> <td>PC</td> </tr> </tbody> </table>	Code	Description	Qty	UOM	0H2354A1	XEVC-XEVL PLUS WASHING CIRCUIT PLAT	1.000	PC	EL1440A0	WATER SELF CLEANING VALVE	4.000	PC	GN1526A0	INT. D.=6.9 TH=1.8 O-RIN	9.000	PC	RC1018A0	ZINC PLATED D12 ELASTIC CLAMP	3.000	PC	RC1019A0	D=10 ELASTIC CLAMP	15.000	PC	RC1130A0	130x2.6 CLAM	1.000	PC	RC1131A0	200x2.6 BLACK CLAMP	3.000	PC	RC1242A0	D=10 CLOSED CAP	2.000	PC
			Code	Description	Qty	UOM																																																																																						
VL1127A1	6mm BARBED T-SHAPED FITTING	2.000	PC																																																																																									
VL1128A1	D6 BARBED CHECK VALVE	3.000	PC																																																																																									
VL1166A0	BB6-AR6 L FITTING	4.000	PC																																																																																									
VL1167A2	GN21 3 ROTOR ARMS B-B FLOW RESTRICTOR	1.000	PC																																																																																									
VL1174C0	D1.2 MM CALIBRATED D1.2 MM	1.000	PC																																																																																									
VL1186A0	3 WAYS PLUS WASHING DISTRIBUTOR	1.000	PC																																																																																									
VL1190A0	PLUS WASHING SYSTEM INLET DISTRIBUTOR	1.000	PC																																																																																									
VL1214A0	BAYONET - 6mm BARBED NRV VALVE	1.000	PC																																																																																									
VL1398A0	1/4 M N.O. CIL PRESSURE SWITCH	1.000	PC																																																																																									
VM1605A0	CLIP TWIST LOCK DIAM. 10.2-12.7 MM	3.000	PC																																																																																									
VM2172A0	LOCKING CLIP FOR PUMP WITH CIRCUIT	5.000	PC																																																																																									
Code	Description	Qty	UOM																																																																																									
0H2354A1	XEVC-XEVL PLUS WASHING CIRCUIT PLAT	1.000	PC																																																																																									
EL1440A0	WATER SELF CLEANING VALVE	4.000	PC																																																																																									
GN1526A0	INT. D.=6.9 TH=1.8 O-RIN	9.000	PC																																																																																									
RC1018A0	ZINC PLATED D12 ELASTIC CLAMP	3.000	PC																																																																																									
RC1019A0	D=10 ELASTIC CLAMP	15.000	PC																																																																																									
RC1130A0	130x2.6 CLAM	1.000	PC																																																																																									
RC1131A0	200x2.6 BLACK CLAMP	3.000	PC																																																																																									
RC1242A0	D=10 CLOSED CAP	2.000	PC																																																																																									



COMPONENT			SPARE PART																																																																						
Code	Description	Image	Code	Description	Kit components																																																																				
VL1166A	BB6-AR6 L FITTING		KVL1184A	2 ROTOR ARMS PLUS EU CLEANING SYSTEM KIT	<table border="1"> <thead> <tr> <th>Code</th> <th>Description</th> <th>Qty</th> <th>UOM</th> </tr> </thead> <tbody> <tr> <td>RC1356A0</td> <td>"STRAIGHT THREADED FEMALE END 8x1/4" BS</td> <td>1.000</td> <td>PC</td> </tr> <tr> <td>TB2821A0</td> <td>EPDM 6X10 L=40MM PIPE</td> <td>6.000</td> <td>PC</td> </tr> <tr> <td>TB2994A0</td> <td>HOOD DETERGENT PIPE</td> <td>1.000</td> <td>PC</td> </tr> <tr> <td>TB3004A0</td> <td>TB2820A L=550mm EPDM BLACK PIPE</td> <td>2.000</td> <td>PC</td> </tr> <tr> <td>TB3005B0</td> <td>TB3132A L=550mm EPDM WHITE-BLUE PIPE</td> <td>1.000</td> <td>PC</td> </tr> <tr> <td>TB3440A0</td> <td>TB3132A L=1050mm EPDM WHITE-BLUE PIPE</td> <td>1.000</td> <td>PC</td> </tr> <tr> <td>VL1019A0</td> <td>VIBRATION DETERGENT PUMP</td> <td>1.000</td> <td>PC</td> </tr> <tr> <td>VL1047A1</td> <td>D6 PIPE HOLDER - D8 J.G. TERMINAL</td> <td>1.000</td> <td>PC</td> </tr> <tr> <td>VL1102A1</td> <td>DETERGENT LINE FILTER + BARBED VNR 6 MM</td> <td>1.000</td> <td>PC</td> </tr> <tr> <td>VL1128A1</td> <td>D6 BARBED CHECK VALVE</td> <td>2.000</td> <td>PC</td> </tr> <tr> <td>VL1141A1</td> <td>BB6-BB6 STRAIGHT CONNECTION</td> <td>1.000</td> <td>PC</td> </tr> <tr> <td>VL1166A0</td> <td>BB6-AR6 L FITTING</td> <td>4.000</td> <td>PC</td> </tr> <tr> <td>VL1174C0</td> <td>D1.2 MM CALIBRATED D1.2 MM</td> <td>1.000</td> <td>PC</td> </tr> <tr> <td>VL1186A0</td> <td>3 WAYS PLUS WASHING DISTRIBUTOR</td> <td>1.000</td> <td>PC</td> </tr> <tr> <td>VL1190A0</td> <td>PLUS WASHING SYSTEM INLET DISTRIBUTOR</td> <td>1.000</td> <td>PC</td> </tr> <tr> <td>VL1214A0</td> <td>BAYONET - 6mm BARBED NRV VALVE</td> <td>1.000</td> <td>PC</td> </tr> </tbody> </table>	Code	Description	Qty	UOM	RC1356A0	"STRAIGHT THREADED FEMALE END 8x1/4" BS	1.000	PC	TB2821A0	EPDM 6X10 L=40MM PIPE	6.000	PC	TB2994A0	HOOD DETERGENT PIPE	1.000	PC	TB3004A0	TB2820A L=550mm EPDM BLACK PIPE	2.000	PC	TB3005B0	TB3132A L=550mm EPDM WHITE-BLUE PIPE	1.000	PC	TB3440A0	TB3132A L=1050mm EPDM WHITE-BLUE PIPE	1.000	PC	VL1019A0	VIBRATION DETERGENT PUMP	1.000	PC	VL1047A1	D6 PIPE HOLDER - D8 J.G. TERMINAL	1.000	PC	VL1102A1	DETERGENT LINE FILTER + BARBED VNR 6 MM	1.000	PC	VL1128A1	D6 BARBED CHECK VALVE	2.000	PC	VL1141A1	BB6-BB6 STRAIGHT CONNECTION	1.000	PC	VL1166A0	BB6-AR6 L FITTING	4.000	PC	VL1174C0	D1.2 MM CALIBRATED D1.2 MM	1.000	PC	VL1186A0	3 WAYS PLUS WASHING DISTRIBUTOR	1.000	PC	VL1190A0	PLUS WASHING SYSTEM INLET DISTRIBUTOR	1.000	PC	VL1214A0	BAYONET - 6mm BARBED NRV VALVE	1.000	PC
Code	Description	Qty	UOM																																																																						
RC1356A0	"STRAIGHT THREADED FEMALE END 8x1/4" BS	1.000	PC																																																																						
TB2821A0	EPDM 6X10 L=40MM PIPE	6.000	PC																																																																						
TB2994A0	HOOD DETERGENT PIPE	1.000	PC																																																																						
TB3004A0	TB2820A L=550mm EPDM BLACK PIPE	2.000	PC																																																																						
TB3005B0	TB3132A L=550mm EPDM WHITE-BLUE PIPE	1.000	PC																																																																						
TB3440A0	TB3132A L=1050mm EPDM WHITE-BLUE PIPE	1.000	PC																																																																						
VL1019A0	VIBRATION DETERGENT PUMP	1.000	PC																																																																						
VL1047A1	D6 PIPE HOLDER - D8 J.G. TERMINAL	1.000	PC																																																																						
VL1102A1	DETERGENT LINE FILTER + BARBED VNR 6 MM	1.000	PC																																																																						
VL1128A1	D6 BARBED CHECK VALVE	2.000	PC																																																																						
VL1141A1	BB6-BB6 STRAIGHT CONNECTION	1.000	PC																																																																						
VL1166A0	BB6-AR6 L FITTING	4.000	PC																																																																						
VL1174C0	D1.2 MM CALIBRATED D1.2 MM	1.000	PC																																																																						
VL1186A0	3 WAYS PLUS WASHING DISTRIBUTOR	1.000	PC																																																																						
VL1190A0	PLUS WASHING SYSTEM INLET DISTRIBUTOR	1.000	PC																																																																						
VL1214A0	BAYONET - 6mm BARBED NRV VALVE	1.000	PC																																																																						

COMPONENT			SPARE PART																																																																						
Code	Description	Image	Code	Description	Kit components																																																																				
VL1166A	BB6-AR6 L FITTING		KVL1184A	2 ROTOR ARMS PLUS EU CLEANING SYSTEM KIT	<table border="1"> <thead> <tr> <th>Code</th> <th>Description</th> <th>Qty</th> <th>UOM</th> </tr> </thead> <tbody> <tr> <td>VL1398A0</td> <td>1/4 M N.O. CIL PRESSURE SWITCH</td> <td>1.000</td> <td>PC</td> </tr> <tr> <td>VM1605A0</td> <td>CLIP TWIST LOCK DIAM. 10,2-12,7 MM</td> <td>3.000</td> <td>PC</td> </tr> <tr> <td>VM2172A0</td> <td>LOCKING CLIP FOR PUMP WITH CIRCUIT</td> <td>5.000</td> <td>PC</td> </tr> </tbody> </table>	Code	Description	Qty	UOM	VL1398A0	1/4 M N.O. CIL PRESSURE SWITCH	1.000	PC	VM1605A0	CLIP TWIST LOCK DIAM. 10,2-12,7 MM	3.000	PC	VM2172A0	LOCKING CLIP FOR PUMP WITH CIRCUIT	5.000	PC																																																				
Code	Description	Qty	UOM																																																																						
VL1398A0	1/4 M N.O. CIL PRESSURE SWITCH	1.000	PC																																																																						
VM1605A0	CLIP TWIST LOCK DIAM. 10,2-12,7 MM	3.000	PC																																																																						
VM2172A0	LOCKING CLIP FOR PUMP WITH CIRCUIT	5.000	PC																																																																						
			KVL1183A	1 ROTOR ARM PLUS CLEANING SYSTEM KIT	<table border="1"> <thead> <tr> <th>Code</th> <th>Description</th> <th>Qty</th> <th>UOM</th> </tr> </thead> <tbody> <tr> <td>0H2354A1</td> <td>XEVC-XEVL PLUS WASHING CIRCUIT PLAT</td> <td>1.000</td> <td>PC</td> </tr> <tr> <td>EL1440A0</td> <td>WATER SELF CLEANING VALVE</td> <td>3.000</td> <td>PC</td> </tr> <tr> <td>GN1526A0</td> <td>INT. D.=6.9 TH=1.8 O-RIN</td> <td>7.000</td> <td>PC</td> </tr> <tr> <td>RC1018A0</td> <td>ZINC PLATED D12 ELASTIC CLAMP</td> <td>2.000</td> <td>PC</td> </tr> <tr> <td>RC1019A0</td> <td>D=10 ELASTIC CLAMP</td> <td>14.000</td> <td>PC</td> </tr> <tr> <td>RC1130A0</td> <td>130x2,6 CLAM</td> <td>1.000</td> <td>PC</td> </tr> <tr> <td>RC1131A0</td> <td>200x2,6 BLACK CLAMP</td> <td>2.000</td> <td>PC</td> </tr> <tr> <td>RC1242A0</td> <td>D=10 CLOSED CAP</td> <td>2.000</td> <td>PC</td> </tr> <tr> <td>RC1356A0</td> <td>"STRAIGHT THREADED FEMALE END 8x1/4" BS</td> <td>1.000</td> <td>PC</td> </tr> <tr> <td>TB2821A0</td> <td>EPDM 6X10 L=40MM PIPE</td> <td>6.000</td> <td>PC</td> </tr> <tr> <td>TB3004A0</td> <td>TB2820A L=550mm EPDM BLACK PIPE</td> <td>1.000</td> <td>PC</td> </tr> <tr> <td>TB3005B0</td> <td>TB3132A L=550mm EPDM WHITE-BLUE PIPE</td> <td>1.000</td> <td>PC</td> </tr> <tr> <td>TB3225B0</td> <td>TB2820A-TAN K-WASHYNG SYS CONNECTION</td> <td>1.000</td> <td>PC</td> </tr> <tr> <td>TB3252A0</td> <td></td> <td>1.000</td> <td>PC</td> </tr> <tr> <td>VL1019A0</td> <td>VIBRATION DETERGENT PUMP</td> <td>1.000</td> <td>PC</td> </tr> <tr> <td>VL1047A1</td> <td>D6 PIPE HOLDER - D8 J.G. TERMINAL</td> <td>1.000</td> <td>PC</td> </tr> </tbody> </table>	Code	Description	Qty	UOM	0H2354A1	XEVC-XEVL PLUS WASHING CIRCUIT PLAT	1.000	PC	EL1440A0	WATER SELF CLEANING VALVE	3.000	PC	GN1526A0	INT. D.=6.9 TH=1.8 O-RIN	7.000	PC	RC1018A0	ZINC PLATED D12 ELASTIC CLAMP	2.000	PC	RC1019A0	D=10 ELASTIC CLAMP	14.000	PC	RC1130A0	130x2,6 CLAM	1.000	PC	RC1131A0	200x2,6 BLACK CLAMP	2.000	PC	RC1242A0	D=10 CLOSED CAP	2.000	PC	RC1356A0	"STRAIGHT THREADED FEMALE END 8x1/4" BS	1.000	PC	TB2821A0	EPDM 6X10 L=40MM PIPE	6.000	PC	TB3004A0	TB2820A L=550mm EPDM BLACK PIPE	1.000	PC	TB3005B0	TB3132A L=550mm EPDM WHITE-BLUE PIPE	1.000	PC	TB3225B0	TB2820A-TAN K-WASHYNG SYS CONNECTION	1.000	PC	TB3252A0		1.000	PC	VL1019A0	VIBRATION DETERGENT PUMP	1.000	PC	VL1047A1	D6 PIPE HOLDER - D8 J.G. TERMINAL	1.000	PC
Code	Description	Qty	UOM																																																																						
0H2354A1	XEVC-XEVL PLUS WASHING CIRCUIT PLAT	1.000	PC																																																																						
EL1440A0	WATER SELF CLEANING VALVE	3.000	PC																																																																						
GN1526A0	INT. D.=6.9 TH=1.8 O-RIN	7.000	PC																																																																						
RC1018A0	ZINC PLATED D12 ELASTIC CLAMP	2.000	PC																																																																						
RC1019A0	D=10 ELASTIC CLAMP	14.000	PC																																																																						
RC1130A0	130x2,6 CLAM	1.000	PC																																																																						
RC1131A0	200x2,6 BLACK CLAMP	2.000	PC																																																																						
RC1242A0	D=10 CLOSED CAP	2.000	PC																																																																						
RC1356A0	"STRAIGHT THREADED FEMALE END 8x1/4" BS	1.000	PC																																																																						
TB2821A0	EPDM 6X10 L=40MM PIPE	6.000	PC																																																																						
TB3004A0	TB2820A L=550mm EPDM BLACK PIPE	1.000	PC																																																																						
TB3005B0	TB3132A L=550mm EPDM WHITE-BLUE PIPE	1.000	PC																																																																						
TB3225B0	TB2820A-TAN K-WASHYNG SYS CONNECTION	1.000	PC																																																																						
TB3252A0		1.000	PC																																																																						
VL1019A0	VIBRATION DETERGENT PUMP	1.000	PC																																																																						
VL1047A1	D6 PIPE HOLDER - D8 J.G. TERMINAL	1.000	PC																																																																						







COMPONENT			SPARE PART																																														
Code	Description	Image	Code	Description	Kit components																																												
VL1166A	BB6-AR6 L FITTING		KVL1183A	1 ROTOR ARM PLUS CLEANING SYSTEM KIT	<table border="1"> <thead> <tr> <th>Code</th> <th>Description</th> <th>Qty</th> <th>UOM</th> </tr> </thead> <tbody> <tr> <td>VL1102A1</td> <td>DETERGENT LINE FILTER + BARBED VNR 6 MM</td> <td>1.000</td> <td>PC</td> </tr> <tr> <td>VL1128A1</td> <td>D6 BARBED CHECK VALVE</td> <td>2.000</td> <td>PC</td> </tr> <tr> <td>VL1166A0</td> <td>BB6-AR6 L FITTING</td> <td>3.000</td> <td>PC</td> </tr> <tr> <td>VL1174C0</td> <td>D1.2 MM CALIBRATED D1.2 MM</td> <td>1.000</td> <td>PC</td> </tr> <tr> <td>VL1185A0</td> <td>2 WAYS PLUS WASHING DISTRIBUTOR</td> <td>1.000</td> <td>PC</td> </tr> <tr> <td>VL1190A0</td> <td>PLUS WASHING SYSTEM INLET DISTRIBUTOR</td> <td>1.000</td> <td>PC</td> </tr> <tr> <td>VL1214A0</td> <td>BAYONET - 6mm BARBED NRV VALVE</td> <td>1.000</td> <td>PC</td> </tr> <tr> <td>VL1398A0</td> <td>1/4 M N.O. CIL PRESSURE SWITCH</td> <td>1.000</td> <td>PC</td> </tr> <tr> <td>VM1605A0</td> <td>CLIP TWIST LOCK DIAM. 10,2-12,7 MM</td> <td>3.000</td> <td>PC</td> </tr> <tr> <td>VM2172A0</td> <td>LOCKING CLIP FOR PUMP WITH CIRCUIT</td> <td>4.000</td> <td>PC</td> </tr> </tbody> </table>	Code	Description	Qty	UOM	VL1102A1	DETERGENT LINE FILTER + BARBED VNR 6 MM	1.000	PC	VL1128A1	D6 BARBED CHECK VALVE	2.000	PC	VL1166A0	BB6-AR6 L FITTING	3.000	PC	VL1174C0	D1.2 MM CALIBRATED D1.2 MM	1.000	PC	VL1185A0	2 WAYS PLUS WASHING DISTRIBUTOR	1.000	PC	VL1190A0	PLUS WASHING SYSTEM INLET DISTRIBUTOR	1.000	PC	VL1214A0	BAYONET - 6mm BARBED NRV VALVE	1.000	PC	VL1398A0	1/4 M N.O. CIL PRESSURE SWITCH	1.000	PC	VM1605A0	CLIP TWIST LOCK DIAM. 10,2-12,7 MM	3.000	PC	VM2172A0	LOCKING CLIP FOR PUMP WITH CIRCUIT	4.000	PC
Code	Description	Qty	UOM																																														
VL1102A1	DETERGENT LINE FILTER + BARBED VNR 6 MM	1.000	PC																																														
VL1128A1	D6 BARBED CHECK VALVE	2.000	PC																																														
VL1166A0	BB6-AR6 L FITTING	3.000	PC																																														
VL1174C0	D1.2 MM CALIBRATED D1.2 MM	1.000	PC																																														
VL1185A0	2 WAYS PLUS WASHING DISTRIBUTOR	1.000	PC																																														
VL1190A0	PLUS WASHING SYSTEM INLET DISTRIBUTOR	1.000	PC																																														
VL1214A0	BAYONET - 6mm BARBED NRV VALVE	1.000	PC																																														
VL1398A0	1/4 M N.O. CIL PRESSURE SWITCH	1.000	PC																																														
VM1605A0	CLIP TWIST LOCK DIAM. 10,2-12,7 MM	3.000	PC																																														
VM2172A0	LOCKING CLIP FOR PUMP WITH CIRCUIT	4.000	PC																																														
			KVL1182A	ONE 1ROT CLEANING SYSTEM KIT (0311 EXC.)	<table border="1"> <thead> <tr> <th>Code</th> <th>Description</th> <th>Qty</th> <th>UOM</th> </tr> </thead> <tbody> <tr> <td>0H2202A1</td> <td>ONE WASHING WITH STEAM VALVE SUPPORT</td> <td>1.000</td> <td>PC</td> </tr> <tr> <td>EL1440A0</td> <td>WATER SELF CLEANING VALVE</td> <td>1.000</td> <td>PC</td> </tr> <tr> <td>GN1526A0</td> <td>INT. D.=6.9 TH=1.8 O-RIN</td> <td>3.000</td> <td>PC</td> </tr> <tr> <td>RC1018A0</td> <td>ZINC PLATED D12 ELASTIC CLAMP</td> <td>1.000</td> <td>PC</td> </tr> <tr> <td>RC1019A0</td> <td>D=10 ELASTIC CLAMP</td> <td>14.000</td> <td>PC</td> </tr> <tr> <td>RC1130A0</td> <td>130x2,6 CLAM</td> <td>2.000</td> <td>PC</td> </tr> <tr> <td>RC1242A0</td> <td>D=10 CLOSED CAP</td> <td>2.000</td> <td>PC</td> </tr> <tr> <td>TB2821A0</td> <td>EPDM 6X10 L=40MM PIPE</td> <td>6.000</td> <td>PC</td> </tr> </tbody> </table>	Code	Description	Qty	UOM	0H2202A1	ONE WASHING WITH STEAM VALVE SUPPORT	1.000	PC	EL1440A0	WATER SELF CLEANING VALVE	1.000	PC	GN1526A0	INT. D.=6.9 TH=1.8 O-RIN	3.000	PC	RC1018A0	ZINC PLATED D12 ELASTIC CLAMP	1.000	PC	RC1019A0	D=10 ELASTIC CLAMP	14.000	PC	RC1130A0	130x2,6 CLAM	2.000	PC	RC1242A0	D=10 CLOSED CAP	2.000	PC	TB2821A0	EPDM 6X10 L=40MM PIPE	6.000	PC								
Code	Description	Qty	UOM																																														
0H2202A1	ONE WASHING WITH STEAM VALVE SUPPORT	1.000	PC																																														
EL1440A0	WATER SELF CLEANING VALVE	1.000	PC																																														
GN1526A0	INT. D.=6.9 TH=1.8 O-RIN	3.000	PC																																														
RC1018A0	ZINC PLATED D12 ELASTIC CLAMP	1.000	PC																																														
RC1019A0	D=10 ELASTIC CLAMP	14.000	PC																																														
RC1130A0	130x2,6 CLAM	2.000	PC																																														
RC1242A0	D=10 CLOSED CAP	2.000	PC																																														
TB2821A0	EPDM 6X10 L=40MM PIPE	6.000	PC																																														



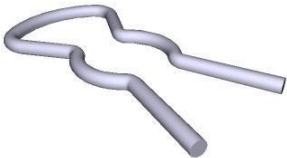
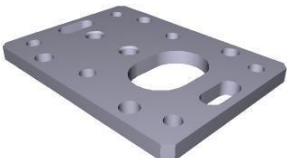



COMPONENT			SPARE PART																																																														
Code	Description	Image	Code	Description	Kit components																																																												
VL1166A	BB6-AR6 L FITTING		KVL1182A	ONE 1ROT CLEANING SYSTEM KIT (0311 EXC.)	<table border="1"> <thead> <tr> <th>Code</th> <th>Description</th> <th>Qty</th> <th>UOM</th> </tr> </thead> <tbody> <tr> <td>TB3004A0</td> <td>TB2820A L=550mm EPDM BLACK PIPE</td> <td>1.000</td> <td>PC</td> </tr> <tr> <td>TB3009B0</td> <td>TB3132A-ONE OVEN WASHING INLET</td> <td>1.000</td> <td>PC</td> </tr> <tr> <td>TB3225B0</td> <td>TB2820A-TAN K-WASHYNG SYS CONNECTION</td> <td>1.000</td> <td>PC</td> </tr> <tr> <td>VI1220A1</td> <td>4,2x12 TCB SELF-TAPPIN G SCREW</td> <td>1.000</td> <td>PC</td> </tr> <tr> <td>VL1019A0</td> <td>VIBRATION DETERGENT PUMP</td> <td>1.000</td> <td>PC</td> </tr> <tr> <td>VL1047A1</td> <td>D6 PIPE HOLDER - D6 J.G. TERMINAL</td> <td>1.000</td> <td>PC</td> </tr> <tr> <td>VL1054B0</td> <td>ONE WASHING SYS INLET DISTRIBUTOR</td> <td>1.000</td> <td>PC</td> </tr> <tr> <td>VL1102A1</td> <td>DETERGENT LINE FILTER + BARBED VNR 6 MM</td> <td>1.000</td> <td>PC</td> </tr> <tr> <td>VL1128A1</td> <td>D6 BARBED CHECK VALVE</td> <td>2.000</td> <td>PC</td> </tr> <tr> <td>VL1166A0</td> <td>BB6-AR6 L FITTING</td> <td>1.000</td> <td>PC</td> </tr> <tr> <td>VL1174C0</td> <td>D1.2 MM CALIBRATED D1.2 MM</td> <td>1.000</td> <td>PC</td> </tr> <tr> <td>VL1191A0</td> <td>ONE WASHING DISTRIBUTOR OUTLETS KIT</td> <td>1.000</td> <td>PC</td> </tr> <tr> <td>VL1214A0</td> <td>BAYONET - 6mm BARBED NRV VALVE</td> <td>1.000</td> <td>PC</td> </tr> <tr> <td>VM2172A0</td> <td>LOCKING CLIP FOR PUMP WITH CIRCUIT</td> <td>2.000</td> <td>PC</td> </tr> </tbody> </table>	Code	Description	Qty	UOM	TB3004A0	TB2820A L=550mm EPDM BLACK PIPE	1.000	PC	TB3009B0	TB3132A-ONE OVEN WASHING INLET	1.000	PC	TB3225B0	TB2820A-TAN K-WASHYNG SYS CONNECTION	1.000	PC	VI1220A1	4,2x12 TCB SELF-TAPPIN G SCREW	1.000	PC	VL1019A0	VIBRATION DETERGENT PUMP	1.000	PC	VL1047A1	D6 PIPE HOLDER - D6 J.G. TERMINAL	1.000	PC	VL1054B0	ONE WASHING SYS INLET DISTRIBUTOR	1.000	PC	VL1102A1	DETERGENT LINE FILTER + BARBED VNR 6 MM	1.000	PC	VL1128A1	D6 BARBED CHECK VALVE	2.000	PC	VL1166A0	BB6-AR6 L FITTING	1.000	PC	VL1174C0	D1.2 MM CALIBRATED D1.2 MM	1.000	PC	VL1191A0	ONE WASHING DISTRIBUTOR OUTLETS KIT	1.000	PC	VL1214A0	BAYONET - 6mm BARBED NRV VALVE	1.000	PC	VM2172A0	LOCKING CLIP FOR PUMP WITH CIRCUIT	2.000	PC
Code	Description	Qty	UOM																																																														
TB3004A0	TB2820A L=550mm EPDM BLACK PIPE	1.000	PC																																																														
TB3009B0	TB3132A-ONE OVEN WASHING INLET	1.000	PC																																																														
TB3225B0	TB2820A-TAN K-WASHYNG SYS CONNECTION	1.000	PC																																																														
VI1220A1	4,2x12 TCB SELF-TAPPIN G SCREW	1.000	PC																																																														
VL1019A0	VIBRATION DETERGENT PUMP	1.000	PC																																																														
VL1047A1	D6 PIPE HOLDER - D6 J.G. TERMINAL	1.000	PC																																																														
VL1054B0	ONE WASHING SYS INLET DISTRIBUTOR	1.000	PC																																																														
VL1102A1	DETERGENT LINE FILTER + BARBED VNR 6 MM	1.000	PC																																																														
VL1128A1	D6 BARBED CHECK VALVE	2.000	PC																																																														
VL1166A0	BB6-AR6 L FITTING	1.000	PC																																																														
VL1174C0	D1.2 MM CALIBRATED D1.2 MM	1.000	PC																																																														
VL1191A0	ONE WASHING DISTRIBUTOR OUTLETS KIT	1.000	PC																																																														
VL1214A0	BAYONET - 6mm BARBED NRV VALVE	1.000	PC																																																														
VM2172A0	LOCKING CLIP FOR PUMP WITH CIRCUIT	2.000	PC																																																														
			KVL1166A	BB6-AR6 L FITTING 5 PCS KIT	<table border="1"> <thead> <tr> <th>Code</th> <th>Description</th> <th>Qty</th> <th>UOM</th> </tr> </thead> <tbody> <tr> <td>VL1166A0</td> <td>BB6-AR6 L FITTING</td> <td>5.000</td> <td>PC</td> </tr> </tbody> </table>	Code	Description	Qty	UOM	VL1166A0	BB6-AR6 L FITTING	5.000	PC																																																				
Code	Description	Qty	UOM																																																														
VL1166A0	BB6-AR6 L FITTING	5.000	PC																																																														







COMPONENT			SPARE PART																										
Code	Description	Image	Code	Description	Kit components																								
VM2172A	LOCKING CLIP FOR PUMP WITH CIRCUIT		VM2172A0	LOCKING CLIP FOR PUMP WITH CIRCUIT																									
0H2561A	6 S. DOOR COUNTERBRACKET		0H2561A0	6 S. DOOR COUNTERBRACKET																									
VI1995A	M5x25 ST. STEEL SCREW		VI1995A0	M5x25 ST. STEEL SCREW																									
VM1240A	NYLON SUPPORT CAP		KVM1240A	4 PCS COUNTER BRACKET SUPPORT CAP KIT	<table border="1"> <thead> <tr> <th>Code</th> <th>Description</th> <th>Qty</th> <th>UOM</th> </tr> </thead> <tbody> <tr> <td>VM1240A0</td> <td>NYLON SUPPORT CAP</td> <td>4.000</td> <td>PC</td> </tr> </tbody> </table>	Code	Description	Qty	UOM	VM1240A0	NYLON SUPPORT CAP	4.000	PC																
Code	Description	Qty	UOM																										
VM1240A0	NYLON SUPPORT CAP	4.000	PC																										
VM2273A	MM DOOR LEFT LOWER BRACKET		KVM2273A	MIND.Maps DOOR LOWER LEFT BRACKET KIT	<table border="1"> <thead> <tr> <th>Code</th> <th>Description</th> <th>Qty</th> <th>UOM</th> </tr> </thead> <tbody> <tr> <td>0H7330A0</td> <td>DOOR LOWER BRACKET WASHER</td> <td>2.000</td> <td>PC</td> </tr> <tr> <td>VI1995A0</td> <td>M5x25 ST. STEEL SCREW</td> <td>4.000</td> <td>PC</td> </tr> <tr> <td>VM2273A1</td> <td>MM DOOR LEFT LOWER BRACKET</td> <td>1.000</td> <td>PC</td> </tr> <tr> <td>VM2352A0</td> <td>MM LOWER DOOR BRACKET LEFT SCREW COVER</td> <td>1.000</td> <td>PC</td> </tr> <tr> <td>VM2353A0</td> <td>MM LOWER DOOR BRACKET RIGHT SCREW COVER</td> <td>1.000</td> <td>PC</td> </tr> </tbody> </table>	Code	Description	Qty	UOM	0H7330A0	DOOR LOWER BRACKET WASHER	2.000	PC	VI1995A0	M5x25 ST. STEEL SCREW	4.000	PC	VM2273A1	MM DOOR LEFT LOWER BRACKET	1.000	PC	VM2352A0	MM LOWER DOOR BRACKET LEFT SCREW COVER	1.000	PC	VM2353A0	MM LOWER DOOR BRACKET RIGHT SCREW COVER	1.000	PC
Code	Description	Qty	UOM																										
0H7330A0	DOOR LOWER BRACKET WASHER	2.000	PC																										
VI1995A0	M5x25 ST. STEEL SCREW	4.000	PC																										
VM2273A1	MM DOOR LEFT LOWER BRACKET	1.000	PC																										
VM2352A0	MM LOWER DOOR BRACKET LEFT SCREW COVER	1.000	PC																										
VM2353A0	MM LOWER DOOR BRACKET RIGHT SCREW COVER	1.000	PC																										







COMPONENT			SPARE PART										
Code	Description	Image	Code	Description	Kit components								
VM2352A	MM LOWER DOOR BRACKET LEFT SCREW COVERI		VM2352A0	MM LOWER DOOR BRACKET LEFT SCREW COVERI									
VM2353A	MM LOWER DOOR BRACKET RIGHT SCREW COVERI		VM2353A0	MM LOWER DOOR BRACKET RIGHT SCREW COVERI									
0H2561A	6 S. DOOR COUNTERBRACKET		0H2561A0	6 S. DOOR COUNTERBRACKET									
VI1995A	M5x25 ST.STEEL SCREW		VI1995A0	M5x25 ST.STEEL SCREW									
VM1240A	NYLON SUPPORT CAP		KVM1240A	4 PCS COUNTER BRACKET SUPPORT CAP KIT	<table border="1"> <thead> <tr> <th>Code</th> <th>Description</th> <th>Qty</th> <th>UOM</th> </tr> </thead> <tbody> <tr> <td>VM1240A0</td> <td>NYLON SUPPORT CAP</td> <td>4.000</td> <td>PC</td> </tr> </tbody> </table>	Code	Description	Qty	UOM	VM1240A0	NYLON SUPPORT CAP	4.000	PC
Code	Description	Qty	UOM										
VM1240A0	NYLON SUPPORT CAP	4.000	PC										





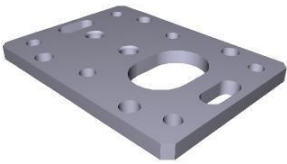

COMPONENT			SPARE PART																														
Code	Description	Image	Code	Description	Kit components																												
VM2271A	MM DOOR LEFT UPPER BRACKET		KVM2271A	MIND.MAPS UPPER LEFT DOOR BRACKET KIT	<table border="1"> <thead> <tr> <th>Code</th> <th>Description</th> <th>Qty</th> <th>UOM</th> </tr> </thead> <tbody> <tr> <td>VI1220A1</td> <td>4,2x12 TCB SELF-TAPPIN G SCREW</td> <td>2.000</td> <td>PC</td> </tr> <tr> <td>VI1995A0</td> <td>M5x25 ST.STEEL SCREW</td> <td>4.000</td> <td>PC</td> </tr> <tr> <td>VI1997A0</td> <td>5x10X1 FLAT WASHER</td> <td>4.000</td> <td>PC</td> </tr> <tr> <td>VM2271A0</td> <td>MM DOOR LEFT UPPER BRACKET</td> <td>1.000</td> <td>PC</td> </tr> <tr> <td>VM2298A0</td> <td>DOOR BRACKET UPPER COVER</td> <td>1.000</td> <td>PC</td> </tr> </tbody> </table>	Code	Description	Qty	UOM	VI1220A1	4,2x12 TCB SELF-TAPPIN G SCREW	2.000	PC	VI1995A0	M5x25 ST.STEEL SCREW	4.000	PC	VI1997A0	5x10X1 FLAT WASHER	4.000	PC	VM2271A0	MM DOOR LEFT UPPER BRACKET	1.000	PC	VM2298A0	DOOR BRACKET UPPER COVER	1.000	PC				
Code	Description	Qty	UOM																														
VI1220A1	4,2x12 TCB SELF-TAPPIN G SCREW	2.000	PC																														
VI1995A0	M5x25 ST.STEEL SCREW	4.000	PC																														
VI1997A0	5x10X1 FLAT WASHER	4.000	PC																														
VM2271A0	MM DOOR LEFT UPPER BRACKET	1.000	PC																														
VM2298A0	DOOR BRACKET UPPER COVER	1.000	PC																														
VM2298A	DOOR BRACKET UPPER COVER		KVM2298A	MIND.Maps DOOR UPPER BRACKET COVER KIT	<table border="1"> <thead> <tr> <th>Code</th> <th>Description</th> <th>Qty</th> <th>UOM</th> </tr> </thead> <tbody> <tr> <td>VI1220A1</td> <td>4,2x12 TCB SELF-TAPPIN G SCREW</td> <td>2.000</td> <td>PC</td> </tr> <tr> <td>VM2298A0</td> <td>DOOR BRACKET UPPER COVER</td> <td>1.000</td> <td>PC</td> </tr> </tbody> </table>	Code	Description	Qty	UOM	VI1220A1	4,2x12 TCB SELF-TAPPIN G SCREW	2.000	PC	VM2298A0	DOOR BRACKET UPPER COVER	1.000	PC																
Code	Description	Qty	UOM																														
VI1220A1	4,2x12 TCB SELF-TAPPIN G SCREW	2.000	PC																														
VM2298A0	DOOR BRACKET UPPER COVER	1.000	PC																														
0H2561A	6 S. DOOR COUNTERBRACKET		0H2561A0	6 S. DOOR COUNTERBRACKET																													
VE1020B	MAGNET DOOR MICROSWITCH		KVE1020B	MICROSWITCH KIT	<table border="1"> <thead> <tr> <th>Code</th> <th>Description</th> <th>Qty</th> <th>UOM</th> </tr> </thead> <tbody> <tr> <td>CE1030A0</td> <td>FEMALE FASTON COVER 6.3X0.8 0.5-1mmq</td> <td>2.000</td> <td>PC</td> </tr> <tr> <td>CE1660A0</td> <td>6,3x0,8 FEMALE FASTON COVE</td> <td>2.000</td> <td>PC</td> </tr> <tr> <td>CE1730A0</td> <td>PVC CABLE NP 2 X AWG22 STYLE 2095</td> <td>0.150</td> <td>M</td> </tr> <tr> <td>CE1740A0</td> <td>MINIFIT MALE END FITTING</td> <td>2.000</td> <td>PC</td> </tr> <tr> <td>CE1745A0</td> <td>2 WAYS FEMALE MINIFIT CONNECTOR</td> <td>1.000</td> <td>PC</td> </tr> <tr> <td>VE1020B0</td> <td>MAGNET DOOR MICROSWITC</td> <td>1.000</td> <td>PC</td> </tr> </tbody> </table>	Code	Description	Qty	UOM	CE1030A0	FEMALE FASTON COVER 6.3X0.8 0.5-1mmq	2.000	PC	CE1660A0	6,3x0,8 FEMALE FASTON COVE	2.000	PC	CE1730A0	PVC CABLE NP 2 X AWG22 STYLE 2095	0.150	M	CE1740A0	MINIFIT MALE END FITTING	2.000	PC	CE1745A0	2 WAYS FEMALE MINIFIT CONNECTOR	1.000	PC	VE1020B0	MAGNET DOOR MICROSWITC	1.000	PC
Code	Description	Qty	UOM																														
CE1030A0	FEMALE FASTON COVER 6.3X0.8 0.5-1mmq	2.000	PC																														
CE1660A0	6,3x0,8 FEMALE FASTON COVE	2.000	PC																														
CE1730A0	PVC CABLE NP 2 X AWG22 STYLE 2095	0.150	M																														
CE1740A0	MINIFIT MALE END FITTING	2.000	PC																														
CE1745A0	2 WAYS FEMALE MINIFIT CONNECTOR	1.000	PC																														
VE1020B0	MAGNET DOOR MICROSWITC	1.000	PC																														







COMPONENT			SPARE PART														
Code	Description	Image	Code	Description	Kit components												
VE1020B	MAGNET DOOR MICROSWITCH		KVE1020B	MICROSWITCH KIT	<table border="1"> <thead> <tr> <th>Code</th> <th>Description</th> <th>Qty</th> <th>UOM</th> </tr> </thead> <tbody> <tr> <td>VE1030A1</td> <td>MAGNET FOR DOOR MICROSWITC H D=22.9mm</td> <td>1.000</td> <td>PC</td> </tr> <tr> <td>V1192A0</td> <td></td> <td>1.000</td> <td>PC</td> </tr> </tbody> </table>	Code	Description	Qty	UOM	VE1030A1	MAGNET FOR DOOR MICROSWITC H D=22.9mm	1.000	PC	V1192A0		1.000	PC
Code	Description	Qty	UOM														
VE1030A1	MAGNET FOR DOOR MICROSWITC H D=22.9mm	1.000	PC														
V1192A0		1.000	PC														
VM1240A	NYLON SUPPORT CAP		KVM1240A	4 PCS COUNTER BRACKET SUPPORT CAP KIT	<table border="1"> <thead> <tr> <th>Code</th> <th>Description</th> <th>Qty</th> <th>UOM</th> </tr> </thead> <tbody> <tr> <td>VM1240A0</td> <td>NYLON SUPPORT CAP</td> <td>4.000</td> <td>PC</td> </tr> </tbody> </table>	Code	Description	Qty	UOM	VM1240A0	NYLON SUPPORT CAP	4.000	PC				
Code	Description	Qty	UOM														
VM1240A0	NYLON SUPPORT CAP	4.000	PC														
VP1075A	PLUS/1/ZERO MICROSWITCH SUPPORT COVER		KVP1075A	-M MICROSWITCH SUPPORT PLATE KI	<table border="1"> <thead> <tr> <th>Code</th> <th>Description</th> <th>Qty</th> <th>UOM</th> </tr> </thead> <tbody> <tr> <td>VP1075A0</td> <td>PLUS/1/ZERO MICROSWITC H SUPPORT COVER</td> <td>1.000</td> <td>PC</td> </tr> </tbody> </table>	Code	Description	Qty	UOM	VP1075A0	PLUS/1/ZERO MICROSWITC H SUPPORT COVER	1.000	PC				
Code	Description	Qty	UOM														
VP1075A0	PLUS/1/ZERO MICROSWITC H SUPPORT COVER	1.000	PC														
0H2561A	6 S. DOOR COUNTERBRACKET		0H2561A0	6 S. DOOR COUNTERBRACKET													
VM1240A	NYLON SUPPORT CAP		KVM1240A	4 PCS COUNTER BRACKET SUPPORT CAP KIT	<table border="1"> <thead> <tr> <th>Code</th> <th>Description</th> <th>Qty</th> <th>UOM</th> </tr> </thead> <tbody> <tr> <td>VM1240A0</td> <td>NYLON SUPPORT CAP</td> <td>4.000</td> <td>PC</td> </tr> </tbody> </table>	Code	Description	Qty	UOM	VM1240A0	NYLON SUPPORT CAP	4.000	PC				
Code	Description	Qty	UOM														
VM1240A0	NYLON SUPPORT CAP	4.000	PC														



COMPONENT			SPARE PART																		
Code	Description	Image	Code	Description	Kit components																
VM2310A	UPPER DOOR BRACKET HOLES COVER		KVM2310A	UPPER BRACKET HOLE COVER KIT	<table border="1"> <thead> <tr> <th>Code</th> <th>Description</th> <th>Qty</th> <th>UOM</th> </tr> </thead> <tbody> <tr> <td>VM2310A0</td> <td>UPPER DOOR BRACKET HOLES COVER</td> <td>1.000</td> <td>PC</td> </tr> </tbody> </table>	Code	Description	Qty	UOM	VM2310A0	UPPER DOOR BRACKET HOLES COVER	1.000	PC								
Code	Description	Qty	UOM																		
VM2310A0	UPPER DOOR BRACKET HOLES COVER	1.000	PC																		
OH1019A	BRACKET FOR CHEFTOP H100 FEE		KOH1019A	CT REINF. PLATE FOR H100 FEET	<table border="1"> <thead> <tr> <th>Code</th> <th>Description</th> <th>Qty</th> <th>UOM</th> </tr> </thead> <tbody> <tr> <td>OH1019A2</td> <td>BRACKET FOR CHEFTOP H100 FEET</td> <td>1.000</td> <td>PC</td> </tr> <tr> <td>VI1739A0</td> <td>ZINC THREAD INSERT M10 FTT/E STP</td> <td>2.000</td> <td>PC</td> </tr> </tbody> </table>	Code	Description	Qty	UOM	OH1019A2	BRACKET FOR CHEFTOP H100 FEET	1.000	PC	VI1739A0	ZINC THREAD INSERT M10 FTT/E STP	2.000	PC				
Code	Description	Qty	UOM																		
OH1019A2	BRACKET FOR CHEFTOP H100 FEET	1.000	PC																		
VI1739A0	ZINC THREAD INSERT M10 FTT/E STP	2.000	PC																		
PD1074A	H=100 SQUARE FOO		KPD1074A	Mind.Maps H100 FOOT KIT	<table border="1"> <thead> <tr> <th>Code</th> <th>Description</th> <th>Qty</th> <th>UOM</th> </tr> </thead> <tbody> <tr> <td>PD1074A0</td> <td>H=100 SQUARE FOO</td> <td>1.000</td> <td>PC</td> </tr> <tr> <td>PD1075A1</td> <td>PD1074 FOOT LOCKING BRACKET</td> <td>1.000</td> <td>PC</td> </tr> <tr> <td>VI1220A1</td> <td>4,2x12 TCB SELF-TAPPIN G SCREW</td> <td>5.000</td> <td>PC</td> </tr> </tbody> </table>	Code	Description	Qty	UOM	PD1074A0	H=100 SQUARE FOO	1.000	PC	PD1075A1	PD1074 FOOT LOCKING BRACKET	1.000	PC	VI1220A1	4,2x12 TCB SELF-TAPPIN G SCREW	5.000	PC
Code	Description	Qty	UOM																		
PD1074A0	H=100 SQUARE FOO	1.000	PC																		
PD1075A1	PD1074 FOOT LOCKING BRACKET	1.000	PC																		
VI1220A1	4,2x12 TCB SELF-TAPPIN G SCREW	5.000	PC																		
PD1075A	PD1074 FOOT LOCKING BRACKET		KPD1075A	OVEN FOOT STOPPING BRACKET 4 PCS KIT	<table border="1"> <thead> <tr> <th>Code</th> <th>Description</th> <th>Qty</th> <th>UOM</th> </tr> </thead> <tbody> <tr> <td>PD1075A1</td> <td>PD1074 FOOT LOCKING BRACKET</td> <td>4.000</td> <td>PC</td> </tr> <tr> <td>VI1950A0</td> <td>ST. STEEL 4,2X13 TCB SELF-DRILLIN G SCREW</td> <td>8.000</td> <td>PC</td> </tr> </tbody> </table>	Code	Description	Qty	UOM	PD1075A1	PD1074 FOOT LOCKING BRACKET	4.000	PC	VI1950A0	ST. STEEL 4,2X13 TCB SELF-DRILLIN G SCREW	8.000	PC				
Code	Description	Qty	UOM																		
PD1075A1	PD1074 FOOT LOCKING BRACKET	4.000	PC																		
VI1950A0	ST. STEEL 4,2X13 TCB SELF-DRILLIN G SCREW	8.000	PC																		
GN1558A	EXHAUST SEAL		KVP1168A	CHIMNEY SEALING RING KIT	<table border="1"> <thead> <tr> <th>Code</th> <th>Description</th> <th>Qty</th> <th>UOM</th> </tr> </thead> <tbody> <tr> <td>VI1220A1</td> <td>4,2x12 TCB SELF-TAPPIN G SCREW</td> <td>3.000</td> <td>PC</td> </tr> <tr> <td>VP1168A0</td> <td></td> <td>1.000</td> <td>PC</td> </tr> </tbody> </table>	Code	Description	Qty	UOM	VI1220A1	4,2x12 TCB SELF-TAPPIN G SCREW	3.000	PC	VP1168A0		1.000	PC				
Code	Description	Qty	UOM																		
VI1220A1	4,2x12 TCB SELF-TAPPIN G SCREW	3.000	PC																		
VP1168A0		1.000	PC																		

COMPONENT			SPARE PART																										
Code	Description	Image	Code	Description	Kit components																								
TR1136A	318°C -0/+24 1 POLE SAFETY THERMOSTAT		KTR1136A	318°C -0/+24 SAFETY THERMOSTAT KIT	<table border="1"> <thead> <tr> <th>Code</th> <th>Description</th> <th>Qty</th> <th>UOM</th> </tr> </thead> <tbody> <tr> <td>0H7030A0</td> <td>THERMOSTAT BULB INLET COVER</td> <td>1.000</td> <td>PC</td> </tr> <tr> <td>GN1531A0</td> <td>THERMOSTAT BULB INLET SEALING</td> <td>1.000</td> <td>PC</td> </tr> <tr> <td>SL1045A0</td> <td>S57 BLACK SILICONE - 80ml CARTRIDGE</td> <td>1.000</td> <td>PC</td> </tr> <tr> <td>TR1136A0</td> <td>318°C -0/+24 1 POLE SAFETY THERMOSTAT</td> <td>1.000</td> <td>PC</td> </tr> <tr> <td>VI1220A1</td> <td>4,2x12 TCB SELF-TAPPIN G SCREW</td> <td>3.000</td> <td>PC</td> </tr> </tbody> </table>	Code	Description	Qty	UOM	0H7030A0	THERMOSTAT BULB INLET COVER	1.000	PC	GN1531A0	THERMOSTAT BULB INLET SEALING	1.000	PC	SL1045A0	S57 BLACK SILICONE - 80ml CARTRIDGE	1.000	PC	TR1136A0	318°C -0/+24 1 POLE SAFETY THERMOSTAT	1.000	PC	VI1220A1	4,2x12 TCB SELF-TAPPIN G SCREW	3.000	PC
Code	Description	Qty	UOM																										
0H7030A0	THERMOSTAT BULB INLET COVER	1.000	PC																										
GN1531A0	THERMOSTAT BULB INLET SEALING	1.000	PC																										
SL1045A0	S57 BLACK SILICONE - 80ml CARTRIDGE	1.000	PC																										
TR1136A0	318°C -0/+24 1 POLE SAFETY THERMOSTAT	1.000	PC																										
VI1220A1	4,2x12 TCB SELF-TAPPIN G SCREW	3.000	PC																										
VM1991A	CHEFTOP E SERIES DRIP TRAY		KVM1991A	E SERIES CHEFTOP DRIP TRAY	<table border="1"> <thead> <tr> <th>Code</th> <th>Description</th> <th>Qty</th> <th>UOM</th> </tr> </thead> <tbody> <tr> <td>VM1220A0</td> <td>CLIP TO FIX DRIP TRAY C.T</td> <td>4.000</td> <td>PC</td> </tr> <tr> <td>VM1991A0</td> <td>CHEFTOP E SERIES DRIP TRAY</td> <td>1.000</td> <td>PC</td> </tr> <tr> <td>VM2074A0</td> <td>DRIP TRAY FIXING CLIP WITH SCREW</td> <td>4.000</td> <td>PC</td> </tr> </tbody> </table>	Code	Description	Qty	UOM	VM1220A0	CLIP TO FIX DRIP TRAY C.T	4.000	PC	VM1991A0	CHEFTOP E SERIES DRIP TRAY	1.000	PC	VM2074A0	DRIP TRAY FIXING CLIP WITH SCREW	4.000	PC								
Code	Description	Qty	UOM																										
VM1220A0	CLIP TO FIX DRIP TRAY C.T	4.000	PC																										
VM1991A0	CHEFTOP E SERIES DRIP TRAY	1.000	PC																										
VM2074A0	DRIP TRAY FIXING CLIP WITH SCREW	4.000	PC																										
VM2035A	DRAIN PIPE SUPPORT		KVM2035A	DRAIN PIPE SUPPORT 2 PCS. KI	<table border="1"> <thead> <tr> <th>Code</th> <th>Description</th> <th>Qty</th> <th>UOM</th> </tr> </thead> <tbody> <tr> <td>VM2035A0</td> <td>DRAIN PIPE SUPPORT</td> <td>2.000</td> <td>PC</td> </tr> </tbody> </table>	Code	Description	Qty	UOM	VM2035A0	DRAIN PIPE SUPPORT	2.000	PC																
Code	Description	Qty	UOM																										
VM2035A0	DRAIN PIPE SUPPORT	2.000	PC																										
VM2061A	ACCESSORIES CABLES WALL PASSING		KVM1505A	THROUGH-WALL CONNECTION+DIAPHRAGM KIT	<table border="1"> <thead> <tr> <th>Code</th> <th>Description</th> <th>Qty</th> <th>UOM</th> </tr> </thead> <tbody> <tr> <td>VI1220A1</td> <td>4,2x12 TCB SELF-TAPPIN G SCREW</td> <td>1.000</td> <td>PC</td> </tr> <tr> <td>VM1505A0</td> <td>WALL PASSING WITH DIAPHRAGM</td> <td>3.000</td> <td>PC</td> </tr> <tr> <td>VM2055A0</td> <td>UPPER WALL PASSING ACCESSORY CABLES</td> <td>1.000</td> <td>PC</td> </tr> <tr> <td>VM2056A0</td> <td>LOWER WALL PASSING ACCESSORY CABLES</td> <td>1.000</td> <td>PC</td> </tr> </tbody> </table>	Code	Description	Qty	UOM	VI1220A1	4,2x12 TCB SELF-TAPPIN G SCREW	1.000	PC	VM1505A0	WALL PASSING WITH DIAPHRAGM	3.000	PC	VM2055A0	UPPER WALL PASSING ACCESSORY CABLES	1.000	PC	VM2056A0	LOWER WALL PASSING ACCESSORY CABLES	1.000	PC				
Code	Description	Qty	UOM																										
VI1220A1	4,2x12 TCB SELF-TAPPIN G SCREW	1.000	PC																										
VM1505A0	WALL PASSING WITH DIAPHRAGM	3.000	PC																										
VM2055A0	UPPER WALL PASSING ACCESSORY CABLES	1.000	PC																										
VM2056A0	LOWER WALL PASSING ACCESSORY CABLES	1.000	PC																										



COMPONENT			SPARE PART																		
Code	Description	Image	Code	Description	Kit components																
VM2074A	DRIP TRAY FIXING CLIP WITH SCREW		KVM1220A	CT/BT DRIP TRAY FIXING CLIPS 4PCS KIT	<table border="1"> <thead> <tr> <th>Code</th> <th>Description</th> <th>Qty</th> <th>UOM</th> </tr> </thead> <tbody> <tr> <td>VI1220A1</td> <td>4,2x12 TCB SELF-TAPPING SCREW</td> <td>4.000</td> <td>PC</td> </tr> <tr> <td>VM1220A0</td> <td>CLIP TO FIX DRIP TRAY C.T</td> <td>4.000</td> <td>PC</td> </tr> <tr> <td>VM2074A0</td> <td>DRIP TRAY FIXING CLIP WITH SCREW</td> <td>4.000</td> <td>PC</td> </tr> </tbody> </table>	Code	Description	Qty	UOM	VI1220A1	4,2x12 TCB SELF-TAPPING SCREW	4.000	PC	VM1220A0	CLIP TO FIX DRIP TRAY C.T	4.000	PC	VM2074A0	DRIP TRAY FIXING CLIP WITH SCREW	4.000	PC
Code	Description	Qty	UOM																		
VI1220A1	4,2x12 TCB SELF-TAPPING SCREW	4.000	PC																		
VM1220A0	CLIP TO FIX DRIP TRAY C.T	4.000	PC																		
VM2074A0	DRIP TRAY FIXING CLIP WITH SCREW	4.000	PC																		
VM2249A	COOKING CHAMBER FRONT CORNER		KVM2249A	CHAMBER FRONT PROFILE CORNER KIT	<table border="1"> <thead> <tr> <th>Code</th> <th>Description</th> <th>Qty</th> <th>UOM</th> </tr> </thead> <tbody> <tr> <td>VM2249A0</td> <td>COOKING CHAMBER FRONT CORNER</td> <td>1.000</td> <td>PC</td> </tr> </tbody> </table>	Code	Description	Qty	UOM	VM2249A0	COOKING CHAMBER FRONT CORNER	1.000	PC								
Code	Description	Qty	UOM																		
VM2249A0	COOKING CHAMBER FRONT CORNER	1.000	PC																		
VM2311A	SCREWS COVER		KVM2311A	SCREWS COVER PLATE KIT	<table border="1"> <thead> <tr> <th>Code</th> <th>Description</th> <th>Qty</th> <th>UOM</th> </tr> </thead> <tbody> <tr> <td>VM2311A0</td> <td>SCREWS COVER</td> <td>1.000</td> <td>PC</td> </tr> </tbody> </table>	Code	Description	Qty	UOM	VM2311A0	SCREWS COVER	1.000	PC								
Code	Description	Qty	UOM																		
VM2311A0	SCREWS COVER	1.000	PC																		
VM2450A	THROUGH-WALL CONNECTION 3 PIPES		KVM2450A	3 PIPES THROUGH-WALL CONNECTION KIT	<table border="1"> <thead> <tr> <th>Code</th> <th>Description</th> <th>Qty</th> <th>UOM</th> </tr> </thead> <tbody> <tr> <td>VM2450A0</td> <td>THROUGH-WALL CONNECTION 3 PIPES</td> <td>1.000</td> <td>PC</td> </tr> </tbody> </table>	Code	Description	Qty	UOM	VM2450A0	THROUGH-WALL CONNECTION 3 PIPES	1.000	PC								
Code	Description	Qty	UOM																		
VM2450A0	THROUGH-WALL CONNECTION 3 PIPES	1.000	PC																		
VP1121A	LEFT-RIGHT WATER SEALING CAP		VP1121A0	LEFT-RIGHT WATER SEALING CAP																	



ASM2921B/0.D04 - Door

FRONT



ASM2921B/0.D04 - Door

REAR





COMPONENT			SPARE PART																																																																		
Code	Description	Image	Code	Description	Kit components																																																																
0B1106A	XEVC-0511-E DOOR EXTERNAL LEFT COLUMN		KDR1325A	0511 ZERO RIGHT -M EXTERNAL DOOR	<table border="1"> <thead> <tr> <th>Code</th> <th>Description</th> <th>Qty</th> <th>UOM</th> </tr> </thead> <tbody> <tr> <td>0B1106A0</td> <td>XEVC-0511-E DOOR EXTERNAL LEFT COLUMN</td> <td>1.000</td> <td>PC</td> </tr> <tr> <td>0B1107A1</td> <td>XEVC-0511-E LEFT INT DOOR COLUMN</td> <td>1.000</td> <td>PC</td> </tr> <tr> <td>0B1108B1</td> <td>XEVC-0511 DOOR EXTERNAL RIGHT COLUMN</td> <td>1.000</td> <td>PC</td> </tr> <tr> <td>0B1109A1</td> <td>XEVC-0511-E RIGHT INT DOOR COLUMN</td> <td>1.000</td> <td>PC</td> </tr> <tr> <td>0B1122B0</td> <td>MM CT DOOR LOWER CROSS BAR</td> <td>1.000</td> <td>PC</td> </tr> <tr> <td>0B1166A1</td> <td>XEVC-0511-E EXT GLASS SUPPORT PROFILE</td> <td>2.000</td> <td>PC</td> </tr> <tr> <td>0B1216B0</td> <td>MM CT DOUBLE GLASS DOOR UPPER CROSS BAR</td> <td>1.000</td> <td>PC</td> </tr> <tr> <td>0B1217A1</td> <td>MM DOUBLE GLASS DOOR INT UPPER BEAM 750</td> <td>1.000</td> <td>PC</td> </tr> <tr> <td>0H2892A0</td> <td>LED BAR UPPER CAP PLATE</td> <td>1.000</td> <td>PC</td> </tr> <tr> <td>0H2893A0</td> <td>LED BAR LOWER CAP PLATE</td> <td>1.000</td> <td>PC</td> </tr> <tr> <td>CE1096A0</td> <td>4 POLES MICROFIT 3 M BUS CABLE</td> <td>1.000</td> <td>PC</td> </tr> <tr> <td>CE1285A0</td> <td>EMI ROUND FERRITE MOD.26438015 02</td> <td>2.000</td> <td>PC</td> </tr> <tr> <td>CE1851A0</td> <td>MICROFIT CABLE 2P M-F-F AWG22</td> <td>1.000</td> <td>PC</td> </tr> <tr> <td>CE2001A0</td> <td>MICROFIT CABLE 2PM-100-2PM 2AWG22</td> <td>1.000</td> <td>PC</td> </tr> <tr> <td>CE2002A0</td> <td>MICROFIT CABLE 2PM-100-AMP MODU2 2AWG22</td> <td>1.000</td> <td>PC</td> </tr> </tbody> </table>	Code	Description	Qty	UOM	0B1106A0	XEVC-0511-E DOOR EXTERNAL LEFT COLUMN	1.000	PC	0B1107A1	XEVC-0511-E LEFT INT DOOR COLUMN	1.000	PC	0B1108B1	XEVC-0511 DOOR EXTERNAL RIGHT COLUMN	1.000	PC	0B1109A1	XEVC-0511-E RIGHT INT DOOR COLUMN	1.000	PC	0B1122B0	MM CT DOOR LOWER CROSS BAR	1.000	PC	0B1166A1	XEVC-0511-E EXT GLASS SUPPORT PROFILE	2.000	PC	0B1216B0	MM CT DOUBLE GLASS DOOR UPPER CROSS BAR	1.000	PC	0B1217A1	MM DOUBLE GLASS DOOR INT UPPER BEAM 750	1.000	PC	0H2892A0	LED BAR UPPER CAP PLATE	1.000	PC	0H2893A0	LED BAR LOWER CAP PLATE	1.000	PC	CE1096A0	4 POLES MICROFIT 3 M BUS CABLE	1.000	PC	CE1285A0	EMI ROUND FERRITE MOD.26438015 02	2.000	PC	CE1851A0	MICROFIT CABLE 2P M-F-F AWG22	1.000	PC	CE2001A0	MICROFIT CABLE 2PM-100-2PM 2AWG22	1.000	PC	CE2002A0	MICROFIT CABLE 2PM-100-AMP MODU2 2AWG22	1.000	PC
					Code	Description	Qty	UOM																																																													
					0B1106A0	XEVC-0511-E DOOR EXTERNAL LEFT COLUMN	1.000	PC																																																													
					0B1107A1	XEVC-0511-E LEFT INT DOOR COLUMN	1.000	PC																																																													
					0B1108B1	XEVC-0511 DOOR EXTERNAL RIGHT COLUMN	1.000	PC																																																													
					0B1109A1	XEVC-0511-E RIGHT INT DOOR COLUMN	1.000	PC																																																													
					0B1122B0	MM CT DOOR LOWER CROSS BAR	1.000	PC																																																													
					0B1166A1	XEVC-0511-E EXT GLASS SUPPORT PROFILE	2.000	PC																																																													
					0B1216B0	MM CT DOUBLE GLASS DOOR UPPER CROSS BAR	1.000	PC																																																													
					0B1217A1	MM DOUBLE GLASS DOOR INT UPPER BEAM 750	1.000	PC																																																													
					0H2892A0	LED BAR UPPER CAP PLATE	1.000	PC																																																													
					0H2893A0	LED BAR LOWER CAP PLATE	1.000	PC																																																													
					CE1096A0	4 POLES MICROFIT 3 M BUS CABLE	1.000	PC																																																													
					CE1285A0	EMI ROUND FERRITE MOD.26438015 02	2.000	PC																																																													
					CE1851A0	MICROFIT CABLE 2P M-F-F AWG22	1.000	PC																																																													
CE2001A0	MICROFIT CABLE 2PM-100-2PM 2AWG22	1.000	PC																																																																		
CE2002A0	MICROFIT CABLE 2PM-100-AMP MODU2 2AWG22	1.000	PC																																																																		



COMPONENT			SPARE PART																																																																						
Code	Description	Image	Code	Description	Kit components																																																																				
OB1106A	XEVC-0511-E DOOR EXTERNAL LEFT COLUMN		KDR1325A	0511 ZERO RIGHT -M EXTERNAL DOOR	<table border="1"> <thead> <tr> <th>Code</th> <th>Description</th> <th>Qty</th> <th>UOM</th> </tr> </thead> <tbody> <tr> <td>GN1525A0</td> <td>O-RING INT DIAM 9,5 THK 1 NBR 70</td> <td>1.000</td> <td>PC</td> </tr> <tr> <td>LP1019A0</td> <td>6 SERIES L200 LED LIGHT BAR - E415</td> <td>1.000</td> <td>PC</td> </tr> <tr> <td>MG1099A1</td> <td>MM COMPLETE HANDLE</td> <td>1.000</td> <td>PC</td> </tr> <tr> <td>RC1200A0</td> <td>ED=4 WIRE D.=0.5 COMPRESSIO N SPRING</td> <td>4.000</td> <td>PC</td> </tr> <tr> <td>SL1170A1</td> <td>S57 BLACK SILICON - 310ml CARTRIDGE</td> <td>30.000</td> <td>ML</td> </tr> <tr> <td>SL1221A0</td> <td>GN1/1 EXTERNAL GLASS UPPER SILICONE</td> <td>1.000</td> <td>PC</td> </tr> <tr> <td>SL1222A0</td> <td>0511 EXTERNAL GLASS LATERAL SILICONE</td> <td>4.000</td> <td>PC</td> </tr> <tr> <td>VE1030A1</td> <td>MAGNET FOR DOOR MICROSWITC H D=22,9mm</td> <td>2.000</td> <td>PC</td> </tr> <tr> <td>VI0239A1</td> <td>SELF-TAPPIN G SCREW 4.2X25 TCB+ INOX</td> <td>4.000</td> <td>PC</td> </tr> <tr> <td>VI1034A0</td> <td>STAINLESS STEEL WASHER 8.4x16x1</td> <td>1.000</td> <td>PC</td> </tr> <tr> <td>VI1074A0</td> <td>4X16 SCREW FOR PLASTIC</td> <td>2.000</td> <td>PC</td> </tr> <tr> <td>VI1103A0</td> <td>40X12 TBSP SCREW FOR PLASTIC</td> <td>2.000</td> <td>PC</td> </tr> <tr> <td>VI1220A1</td> <td>4,2x12 TCB SELF-TAPPIN G SCREW</td> <td>26.000</td> <td>PC</td> </tr> <tr> <td>VI1930A1</td> <td>ST. STEEL 5X20 CHIP SCREW</td> <td>16.000</td> <td>PC</td> </tr> <tr> <td>VI1996A0</td> <td>M5x35 SCREW</td> <td>13.000</td> <td>PC</td> </tr> <tr> <td>VI2037A1</td> <td>40X8 TORX SHEETTRACS SELF-THREAD SCREW</td> <td>6.000</td> <td>PC</td> </tr> </tbody> </table>	Code	Description	Qty	UOM	GN1525A0	O-RING INT DIAM 9,5 THK 1 NBR 70	1.000	PC	LP1019A0	6 SERIES L200 LED LIGHT BAR - E415	1.000	PC	MG1099A1	MM COMPLETE HANDLE	1.000	PC	RC1200A0	ED=4 WIRE D.=0.5 COMPRESSIO N SPRING	4.000	PC	SL1170A1	S57 BLACK SILICON - 310ml CARTRIDGE	30.000	ML	SL1221A0	GN1/1 EXTERNAL GLASS UPPER SILICONE	1.000	PC	SL1222A0	0511 EXTERNAL GLASS LATERAL SILICONE	4.000	PC	VE1030A1	MAGNET FOR DOOR MICROSWITC H D=22,9mm	2.000	PC	VI0239A1	SELF-TAPPIN G SCREW 4.2X25 TCB+ INOX	4.000	PC	VI1034A0	STAINLESS STEEL WASHER 8.4x16x1	1.000	PC	VI1074A0	4X16 SCREW FOR PLASTIC	2.000	PC	VI1103A0	40X12 TBSP SCREW FOR PLASTIC	2.000	PC	VI1220A1	4,2x12 TCB SELF-TAPPIN G SCREW	26.000	PC	VI1930A1	ST. STEEL 5X20 CHIP SCREW	16.000	PC	VI1996A0	M5x35 SCREW	13.000	PC	VI2037A1	40X8 TORX SHEETTRACS SELF-THREAD SCREW	6.000	PC
					Code	Description	Qty	UOM																																																																	
					GN1525A0	O-RING INT DIAM 9,5 THK 1 NBR 70	1.000	PC																																																																	
					LP1019A0	6 SERIES L200 LED LIGHT BAR - E415	1.000	PC																																																																	
					MG1099A1	MM COMPLETE HANDLE	1.000	PC																																																																	
					RC1200A0	ED=4 WIRE D.=0.5 COMPRESSIO N SPRING	4.000	PC																																																																	
					SL1170A1	S57 BLACK SILICON - 310ml CARTRIDGE	30.000	ML																																																																	
					SL1221A0	GN1/1 EXTERNAL GLASS UPPER SILICONE	1.000	PC																																																																	
					SL1222A0	0511 EXTERNAL GLASS LATERAL SILICONE	4.000	PC																																																																	
					VE1030A1	MAGNET FOR DOOR MICROSWITC H D=22,9mm	2.000	PC																																																																	
					VI0239A1	SELF-TAPPIN G SCREW 4.2X25 TCB+ INOX	4.000	PC																																																																	
					VI1034A0	STAINLESS STEEL WASHER 8.4x16x1	1.000	PC																																																																	
					VI1074A0	4X16 SCREW FOR PLASTIC	2.000	PC																																																																	
					VI1103A0	40X12 TBSP SCREW FOR PLASTIC	2.000	PC																																																																	
					VI1220A1	4,2x12 TCB SELF-TAPPIN G SCREW	26.000	PC																																																																	
VI1930A1	ST. STEEL 5X20 CHIP SCREW	16.000	PC																																																																						
VI1996A0	M5x35 SCREW	13.000	PC																																																																						
VI2037A1	40X8 TORX SHEETTRACS SELF-THREAD SCREW	6.000	PC																																																																						



COMPONENT			SPARE PART																																																																														
Code	Description	Image	Code	Description	Kit components																																																																												
OB1106A	XEVC-0511-E DOOR EXTERNAL LEFT COLUMN		KDR1325A	0511 ZERO RIGHT -M EXTERNAL DOOR	<table border="1"> <thead> <tr> <th>Code</th> <th>Description</th> <th>Qty</th> <th>UOM</th> </tr> </thead> <tbody> <tr> <td>VM1490A0</td> <td>CHEFTOP/BAK ERTOP HANDLE SCREWS COVER</td> <td>2.000</td> <td>PC</td> </tr> <tr> <td>VM1630A1</td> <td>INTERNAL GLASS PUSHING CAP</td> <td>3.000</td> <td>PC</td> </tr> <tr> <td>VM1631A0</td> <td>PLUS INNER GLASS PUSHING CAP</td> <td>3.000</td> <td>PC</td> </tr> <tr> <td>VM2259B0</td> <td>VM2259B0</td> <td>1.000</td> <td>PC</td> </tr> <tr> <td>VM2260B0</td> <td>S6 LEFT UPPER CAP</td> <td>1.000</td> <td>PC</td> </tr> <tr> <td>VM2261B0</td> <td>MM -M DOOR RIGHT LOWER CAP</td> <td>1.000</td> <td>PC</td> </tr> <tr> <td>VM2262B0</td> <td>MM -M DOOR RIGHT UPPER CAP</td> <td>1.000</td> <td>PC</td> </tr> <tr> <td>VM2267A0</td> <td>INTERNAL GLASS LOCKING SYSTEM SLIDER</td> <td>2.000</td> <td>PC</td> </tr> <tr> <td>VM2268A0</td> <td>DOOR MAGNET COVER</td> <td>2.000</td> <td>PC</td> </tr> <tr> <td>VM2269B0</td> <td>INNER GLASS FIXING CAP</td> <td>2.000</td> <td>PC</td> </tr> <tr> <td>VM2274A0</td> <td>GROOVED BUSHING</td> <td>1.000</td> <td>PC</td> </tr> <tr> <td>VM2275A0</td> <td>SMOOTH BUSHING</td> <td>1.000</td> <td>PC</td> </tr> <tr> <td>VM2284B0</td> <td>750 SERIES DRIP PROFILE KIT</td> <td>1.000</td> <td>PC</td> </tr> <tr> <td>VM2305A0</td> <td>6 SERIES DOOR CAP FIXING PAWL</td> <td>14.000</td> <td>PC</td> </tr> <tr> <td>VM2312A0</td> <td>6 S. DRIP PROFILE DRAIN LEFT PIPE</td> <td>1.000</td> <td>PC</td> </tr> <tr> <td>VM2314A0</td> <td>6 S. DRIP PROFILE CAP</td> <td>1.000</td> <td>PC</td> </tr> <tr> <td>VM2315B0</td> <td>S6 INTERNAL GLASS SUPPORT</td> <td>3.000</td> <td>PC</td> </tr> <tr> <td>VM2505B1</td> <td>MM PLUS INTERNAL GLASS SUPPORT</td> <td>3.000</td> <td>PC</td> </tr> </tbody> </table>	Code	Description	Qty	UOM	VM1490A0	CHEFTOP/BAK ERTOP HANDLE SCREWS COVER	2.000	PC	VM1630A1	INTERNAL GLASS PUSHING CAP	3.000	PC	VM1631A0	PLUS INNER GLASS PUSHING CAP	3.000	PC	VM2259B0	VM2259B0	1.000	PC	VM2260B0	S6 LEFT UPPER CAP	1.000	PC	VM2261B0	MM -M DOOR RIGHT LOWER CAP	1.000	PC	VM2262B0	MM -M DOOR RIGHT UPPER CAP	1.000	PC	VM2267A0	INTERNAL GLASS LOCKING SYSTEM SLIDER	2.000	PC	VM2268A0	DOOR MAGNET COVER	2.000	PC	VM2269B0	INNER GLASS FIXING CAP	2.000	PC	VM2274A0	GROOVED BUSHING	1.000	PC	VM2275A0	SMOOTH BUSHING	1.000	PC	VM2284B0	750 SERIES DRIP PROFILE KIT	1.000	PC	VM2305A0	6 SERIES DOOR CAP FIXING PAWL	14.000	PC	VM2312A0	6 S. DRIP PROFILE DRAIN LEFT PIPE	1.000	PC	VM2314A0	6 S. DRIP PROFILE CAP	1.000	PC	VM2315B0	S6 INTERNAL GLASS SUPPORT	3.000	PC	VM2505B1	MM PLUS INTERNAL GLASS SUPPORT	3.000	PC
Code	Description	Qty	UOM																																																																														
VM1490A0	CHEFTOP/BAK ERTOP HANDLE SCREWS COVER	2.000	PC																																																																														
VM1630A1	INTERNAL GLASS PUSHING CAP	3.000	PC																																																																														
VM1631A0	PLUS INNER GLASS PUSHING CAP	3.000	PC																																																																														
VM2259B0	VM2259B0	1.000	PC																																																																														
VM2260B0	S6 LEFT UPPER CAP	1.000	PC																																																																														
VM2261B0	MM -M DOOR RIGHT LOWER CAP	1.000	PC																																																																														
VM2262B0	MM -M DOOR RIGHT UPPER CAP	1.000	PC																																																																														
VM2267A0	INTERNAL GLASS LOCKING SYSTEM SLIDER	2.000	PC																																																																														
VM2268A0	DOOR MAGNET COVER	2.000	PC																																																																														
VM2269B0	INNER GLASS FIXING CAP	2.000	PC																																																																														
VM2274A0	GROOVED BUSHING	1.000	PC																																																																														
VM2275A0	SMOOTH BUSHING	1.000	PC																																																																														
VM2284B0	750 SERIES DRIP PROFILE KIT	1.000	PC																																																																														
VM2305A0	6 SERIES DOOR CAP FIXING PAWL	14.000	PC																																																																														
VM2312A0	6 S. DRIP PROFILE DRAIN LEFT PIPE	1.000	PC																																																																														
VM2314A0	6 S. DRIP PROFILE CAP	1.000	PC																																																																														
VM2315B0	S6 INTERNAL GLASS SUPPORT	3.000	PC																																																																														
VM2505B1	MM PLUS INTERNAL GLASS SUPPORT	3.000	PC																																																																														



COMPONENT			SPARE PART																																															
Code	Description	Image	Code	Description	Kit components																																													
0B1106A	XEVC-0511-E DOOR EXTERNAL LEFT COLUMN		KDR1325A	0511 ZERO RIGHT -M EXTERNAL DOOR	<table border="1"> <thead> <tr> <th>Code</th> <th>Description</th> <th>Qty</th> <th>UOM</th> </tr> </thead> <tbody> <tr> <td>VP1080A0</td> <td>UPPER HINGE CAP FOR LOWER INNER GLASS</td> <td>1.000</td> <td>PC</td> </tr> <tr> <td>VP1081A0</td> <td>UPPER HINGE CAP FOR UPPER INNER GLASS</td> <td>1.000</td> <td>PC</td> </tr> <tr> <td>VT1276A0</td> <td>XEVC-0511-E DOOR EXTERNAL GLASS</td> <td>1.000</td> <td>PC</td> </tr> </tbody> </table>	Code	Description	Qty	UOM	VP1080A0	UPPER HINGE CAP FOR LOWER INNER GLASS	1.000	PC	VP1081A0	UPPER HINGE CAP FOR UPPER INNER GLASS	1.000	PC	VT1276A0	XEVC-0511-E DOOR EXTERNAL GLASS	1.000	PC																													
			Code	Description	Qty	UOM																																												
VP1080A0	UPPER HINGE CAP FOR LOWER INNER GLASS	1.000	PC																																															
VP1081A0	UPPER HINGE CAP FOR UPPER INNER GLASS	1.000	PC																																															
VT1276A0	XEVC-0511-E DOOR EXTERNAL GLASS	1.000	PC																																															
KDR1261B	0511 -M RIGHT EXTERNAL DOOR	<table border="1"> <thead> <tr> <th>Code</th> <th>Description</th> <th>Qty</th> <th>UOM</th> </tr> </thead> <tbody> <tr> <td>0B1106A0</td> <td>XEVC-0511-E DOOR EXTERNAL LEFT COLUMN</td> <td>1.000</td> <td>PC</td> </tr> <tr> <td>0B1107A1</td> <td>XEVC-0511-E LEFT INT DOOR COLUM</td> <td>1.000</td> <td>PC</td> </tr> <tr> <td>0B1108B1</td> <td>XEVC-0511 DOOR EXTERNAL RIGHT COLUM</td> <td>1.000</td> <td>PC</td> </tr> <tr> <td>0B1109A1</td> <td>XEVC-0511-E RIGHT INT DOOR COLUM</td> <td>1.000</td> <td>PC</td> </tr> <tr> <td>0B1122B0</td> <td>MM CT DOOR LOWER CROSS BAR</td> <td>1.000</td> <td>PC</td> </tr> <tr> <td>0B1166A1</td> <td>XEVC-0511-E EXT GLASS SUPPORT PROFILE</td> <td>2.000</td> <td>PC</td> </tr> <tr> <td>0B1216B0</td> <td>MM CT DOUBLE GLASS DOOR UPPER CROSS BAR</td> <td>1.000</td> <td>PC</td> </tr> <tr> <td>0B1217A1</td> <td>MM DOUBLE GLASS DOOR INT UPPER BEAM 750</td> <td>1.000</td> <td>PC</td> </tr> <tr> <td>CE1052A1</td> <td>CABLE CONNECTION CONTROL - USB MM 750m</td> <td>1.000</td> <td>PC</td> </tr> <tr> <td>CE1053B0</td> <td>MM MICROFIT LED BAR POWER SUPPLY CABL</td> <td>1.000</td> <td>PC</td> </tr> <tr> <td>CE1096A0</td> <td>4 POLES MICROFIT 3 M BUS CABLE</td> <td>1.000</td> <td>PC</td> </tr> </tbody> </table>	Code	Description	Qty	UOM	0B1106A0	XEVC-0511-E DOOR EXTERNAL LEFT COLUMN	1.000	PC	0B1107A1	XEVC-0511-E LEFT INT DOOR COLUM	1.000	PC	0B1108B1	XEVC-0511 DOOR EXTERNAL RIGHT COLUM	1.000	PC	0B1109A1	XEVC-0511-E RIGHT INT DOOR COLUM	1.000	PC	0B1122B0	MM CT DOOR LOWER CROSS BAR	1.000	PC	0B1166A1	XEVC-0511-E EXT GLASS SUPPORT PROFILE	2.000	PC	0B1216B0	MM CT DOUBLE GLASS DOOR UPPER CROSS BAR	1.000	PC	0B1217A1	MM DOUBLE GLASS DOOR INT UPPER BEAM 750	1.000	PC	CE1052A1	CABLE CONNECTION CONTROL - USB MM 750m	1.000	PC	CE1053B0	MM MICROFIT LED BAR POWER SUPPLY CABL	1.000	PC	CE1096A0	4 POLES MICROFIT 3 M BUS CABLE	1.000	PC
Code	Description	Qty	UOM																																															
0B1106A0	XEVC-0511-E DOOR EXTERNAL LEFT COLUMN	1.000	PC																																															
0B1107A1	XEVC-0511-E LEFT INT DOOR COLUM	1.000	PC																																															
0B1108B1	XEVC-0511 DOOR EXTERNAL RIGHT COLUM	1.000	PC																																															
0B1109A1	XEVC-0511-E RIGHT INT DOOR COLUM	1.000	PC																																															
0B1122B0	MM CT DOOR LOWER CROSS BAR	1.000	PC																																															
0B1166A1	XEVC-0511-E EXT GLASS SUPPORT PROFILE	2.000	PC																																															
0B1216B0	MM CT DOUBLE GLASS DOOR UPPER CROSS BAR	1.000	PC																																															
0B1217A1	MM DOUBLE GLASS DOOR INT UPPER BEAM 750	1.000	PC																																															
CE1052A1	CABLE CONNECTION CONTROL - USB MM 750m	1.000	PC																																															
CE1053B0	MM MICROFIT LED BAR POWER SUPPLY CABL	1.000	PC																																															
CE1096A0	4 POLES MICROFIT 3 M BUS CABLE	1.000	PC																																															



COMPONENT			SPARE PART																																																																		
Code	Description	Image	Code	Description	Kit components																																																																
OB1106A	XEVC-0511-E DOOR EXTERNAL LEFT COLUMN		KDR1261B	0511 -M RIGHT EXTERNAL DOOR	<table border="1"> <thead> <tr> <th>Code</th> <th>Description</th> <th>Qty</th> <th>UOM</th> </tr> </thead> <tbody> <tr> <td>CE1285A0</td> <td>EMI ROUND FERRITE MOD.26438015 02</td> <td>2.000</td> <td>PC</td> </tr> <tr> <td>GN1525A0</td> <td>O-RING INT DIAM 9,5 THK 1 NBR 70</td> <td>1.000</td> <td>PC</td> </tr> <tr> <td>LP1019A0</td> <td>6 SERIES L200 LED LIGHT BAR - E415</td> <td>1.000</td> <td>PC</td> </tr> <tr> <td>LP1025A0</td> <td>L=415 LED LIGHT BAR COVER</td> <td>1.000</td> <td>PC</td> </tr> <tr> <td>MG1099A1</td> <td>MM COMPLETE HANDLE</td> <td>1.000</td> <td>PC</td> </tr> <tr> <td>RC1200A0</td> <td>ED=4 WIRE D.=0.5 COMPRESSIO N SPRING</td> <td>4.000</td> <td>PC</td> </tr> <tr> <td>SL1170A1</td> <td>S57 BLACK SILICON - 310ml CARTRIDGE</td> <td>30.000</td> <td>ML</td> </tr> <tr> <td>SL1221A0</td> <td>GN1/1 EXTERNAL GLASS UPPER SILICONE</td> <td>1.000</td> <td>PC</td> </tr> <tr> <td>SL1222A0</td> <td>0511 EXTERNAL GLASS LATERAL SILICONE</td> <td>4.000</td> <td>PC</td> </tr> <tr> <td>VE1030A1</td> <td>MAGNET FOR DOOR MICROSWITC H D=22,9mm</td> <td>2.000</td> <td>PC</td> </tr> <tr> <td>VI0239A1</td> <td>SELF-TAPPIN G SCREW 4.2X25 TCB+ INOX</td> <td>4.000</td> <td>PC</td> </tr> <tr> <td>VI1034A0</td> <td>STAINLESS STEEL WASHER 8.4x16x1</td> <td>1.000</td> <td>PC</td> </tr> <tr> <td>VI1074A0</td> <td>4X16 SCREW FOR PLASTIC</td> <td>2.000</td> <td>PC</td> </tr> <tr> <td>VI1103A0</td> <td>40X12 TBSP SCREW FOR PLASTIC</td> <td>2.000</td> <td>PC</td> </tr> <tr> <td>VI1220A1</td> <td>4,2x12 TCB SELF-TAPPIN G SCREW</td> <td>26.000</td> <td>PC</td> </tr> </tbody> </table>	Code	Description	Qty	UOM	CE1285A0	EMI ROUND FERRITE MOD.26438015 02	2.000	PC	GN1525A0	O-RING INT DIAM 9,5 THK 1 NBR 70	1.000	PC	LP1019A0	6 SERIES L200 LED LIGHT BAR - E415	1.000	PC	LP1025A0	L=415 LED LIGHT BAR COVER	1.000	PC	MG1099A1	MM COMPLETE HANDLE	1.000	PC	RC1200A0	ED=4 WIRE D.=0.5 COMPRESSIO N SPRING	4.000	PC	SL1170A1	S57 BLACK SILICON - 310ml CARTRIDGE	30.000	ML	SL1221A0	GN1/1 EXTERNAL GLASS UPPER SILICONE	1.000	PC	SL1222A0	0511 EXTERNAL GLASS LATERAL SILICONE	4.000	PC	VE1030A1	MAGNET FOR DOOR MICROSWITC H D=22,9mm	2.000	PC	VI0239A1	SELF-TAPPIN G SCREW 4.2X25 TCB+ INOX	4.000	PC	VI1034A0	STAINLESS STEEL WASHER 8.4x16x1	1.000	PC	VI1074A0	4X16 SCREW FOR PLASTIC	2.000	PC	VI1103A0	40X12 TBSP SCREW FOR PLASTIC	2.000	PC	VI1220A1	4,2x12 TCB SELF-TAPPIN G SCREW	26.000	PC
					Code	Description	Qty	UOM																																																													
					CE1285A0	EMI ROUND FERRITE MOD.26438015 02	2.000	PC																																																													
					GN1525A0	O-RING INT DIAM 9,5 THK 1 NBR 70	1.000	PC																																																													
					LP1019A0	6 SERIES L200 LED LIGHT BAR - E415	1.000	PC																																																													
					LP1025A0	L=415 LED LIGHT BAR COVER	1.000	PC																																																													
					MG1099A1	MM COMPLETE HANDLE	1.000	PC																																																													
					RC1200A0	ED=4 WIRE D.=0.5 COMPRESSIO N SPRING	4.000	PC																																																													
					SL1170A1	S57 BLACK SILICON - 310ml CARTRIDGE	30.000	ML																																																													
					SL1221A0	GN1/1 EXTERNAL GLASS UPPER SILICONE	1.000	PC																																																													
					SL1222A0	0511 EXTERNAL GLASS LATERAL SILICONE	4.000	PC																																																													
					VE1030A1	MAGNET FOR DOOR MICROSWITC H D=22,9mm	2.000	PC																																																													
					VI0239A1	SELF-TAPPIN G SCREW 4.2X25 TCB+ INOX	4.000	PC																																																													
					VI1034A0	STAINLESS STEEL WASHER 8.4x16x1	1.000	PC																																																													
					VI1074A0	4X16 SCREW FOR PLASTIC	2.000	PC																																																													
VI1103A0	40X12 TBSP SCREW FOR PLASTIC	2.000	PC																																																																		
VI1220A1	4,2x12 TCB SELF-TAPPIN G SCREW	26.000	PC																																																																		



COMPONENT			SPARE PART																																																																																		
Code	Description	Image	Code	Description	Kit components																																																																																
OB1106A	XEVC-0511-E DOOR EXTERNAL LEFT COLUMN		KDR1261B	0511 -M RIGHT EXTERNAL DOOR	<table border="1"> <thead> <tr> <th>Code</th> <th>Description</th> <th>Qty</th> <th>UOM</th> </tr> </thead> <tbody> <tr> <td>VI1930A1</td> <td>ST. STEEL 5X20 CHIP SCREW</td> <td>16.000</td> <td>PC</td> </tr> <tr> <td>VI1996A0</td> <td>M5x35 SCREW</td> <td>13.000</td> <td>PC</td> </tr> <tr> <td>VI2037A1</td> <td>40X8 TORX SHEETTRACS SELF-THREAD SCREW</td> <td>6.000</td> <td>PC</td> </tr> <tr> <td>VM1490A0</td> <td>CHEFTOP/BAK ERTOP HANDLE SCREWS COVER</td> <td>2.000</td> <td>PC</td> </tr> <tr> <td>VM1630A1</td> <td>INTERNAL GLASS PUSHING CAP</td> <td>3.000</td> <td>PC</td> </tr> <tr> <td>VM1631A0</td> <td>PLUS INNER GLASS PUSHING CAP</td> <td>3.000</td> <td>PC</td> </tr> <tr> <td>VM2259B0</td> <td>VM2259B0</td> <td>1.000</td> <td>PC</td> </tr> <tr> <td>VM2260B0</td> <td>S6 LEFT UPPER CAP</td> <td>1.000</td> <td>PC</td> </tr> <tr> <td>VM2261B0</td> <td>MM -M DOOR RIGHT LOWER CAP</td> <td>1.000</td> <td>PC</td> </tr> <tr> <td>VM2262B0</td> <td>MM -M DOOR RIGHT UPPER CAP</td> <td>1.000</td> <td>PC</td> </tr> <tr> <td>VM2267A0</td> <td>INTERNAL GLASS LOCKING SYSTEM SLIDER</td> <td>2.000</td> <td>PC</td> </tr> <tr> <td>VM2268A0</td> <td>DOOR MAGNET COVER</td> <td>2.000</td> <td>PC</td> </tr> <tr> <td>VM2269B0</td> <td>INNER GLASS FIXING CAP</td> <td>2.000</td> <td>PC</td> </tr> <tr> <td>VM2274A0</td> <td>GROOVED BUSHING</td> <td>1.000</td> <td>PC</td> </tr> <tr> <td>VM2275A0</td> <td>SMOOTH BUSHING</td> <td>1.000</td> <td>PC</td> </tr> <tr> <td>VM2284B0</td> <td>750 SERIES DRIP PROFILE KIT</td> <td>1.000</td> <td>PC</td> </tr> <tr> <td>VM2305A0</td> <td>6 SERIES DOOR CAP FIXING PAWL</td> <td>14.000</td> <td>PC</td> </tr> <tr> <td>VM2312A0</td> <td>6 S. DRIP PROFILE DRAIN LEFT PIPE</td> <td>1.000</td> <td>PC</td> </tr> <tr> <td>VM2314A0</td> <td>6 S. DRIP PROFILE CAP</td> <td>1.000</td> <td>PC</td> </tr> </tbody> </table>	Code	Description	Qty	UOM	VI1930A1	ST. STEEL 5X20 CHIP SCREW	16.000	PC	VI1996A0	M5x35 SCREW	13.000	PC	VI2037A1	40X8 TORX SHEETTRACS SELF-THREAD SCREW	6.000	PC	VM1490A0	CHEFTOP/BAK ERTOP HANDLE SCREWS COVER	2.000	PC	VM1630A1	INTERNAL GLASS PUSHING CAP	3.000	PC	VM1631A0	PLUS INNER GLASS PUSHING CAP	3.000	PC	VM2259B0	VM2259B0	1.000	PC	VM2260B0	S6 LEFT UPPER CAP	1.000	PC	VM2261B0	MM -M DOOR RIGHT LOWER CAP	1.000	PC	VM2262B0	MM -M DOOR RIGHT UPPER CAP	1.000	PC	VM2267A0	INTERNAL GLASS LOCKING SYSTEM SLIDER	2.000	PC	VM2268A0	DOOR MAGNET COVER	2.000	PC	VM2269B0	INNER GLASS FIXING CAP	2.000	PC	VM2274A0	GROOVED BUSHING	1.000	PC	VM2275A0	SMOOTH BUSHING	1.000	PC	VM2284B0	750 SERIES DRIP PROFILE KIT	1.000	PC	VM2305A0	6 SERIES DOOR CAP FIXING PAWL	14.000	PC	VM2312A0	6 S. DRIP PROFILE DRAIN LEFT PIPE	1.000	PC	VM2314A0	6 S. DRIP PROFILE CAP	1.000	PC
Code	Description	Qty	UOM																																																																																		
VI1930A1	ST. STEEL 5X20 CHIP SCREW	16.000	PC																																																																																		
VI1996A0	M5x35 SCREW	13.000	PC																																																																																		
VI2037A1	40X8 TORX SHEETTRACS SELF-THREAD SCREW	6.000	PC																																																																																		
VM1490A0	CHEFTOP/BAK ERTOP HANDLE SCREWS COVER	2.000	PC																																																																																		
VM1630A1	INTERNAL GLASS PUSHING CAP	3.000	PC																																																																																		
VM1631A0	PLUS INNER GLASS PUSHING CAP	3.000	PC																																																																																		
VM2259B0	VM2259B0	1.000	PC																																																																																		
VM2260B0	S6 LEFT UPPER CAP	1.000	PC																																																																																		
VM2261B0	MM -M DOOR RIGHT LOWER CAP	1.000	PC																																																																																		
VM2262B0	MM -M DOOR RIGHT UPPER CAP	1.000	PC																																																																																		
VM2267A0	INTERNAL GLASS LOCKING SYSTEM SLIDER	2.000	PC																																																																																		
VM2268A0	DOOR MAGNET COVER	2.000	PC																																																																																		
VM2269B0	INNER GLASS FIXING CAP	2.000	PC																																																																																		
VM2274A0	GROOVED BUSHING	1.000	PC																																																																																		
VM2275A0	SMOOTH BUSHING	1.000	PC																																																																																		
VM2284B0	750 SERIES DRIP PROFILE KIT	1.000	PC																																																																																		
VM2305A0	6 SERIES DOOR CAP FIXING PAWL	14.000	PC																																																																																		
VM2312A0	6 S. DRIP PROFILE DRAIN LEFT PIPE	1.000	PC																																																																																		
VM2314A0	6 S. DRIP PROFILE CAP	1.000	PC																																																																																		



COMPONENT			SPARE PART																																							
Code	Description	Image	Code	Description	Kit components																																					
0B1106A	XEVC-0511-E DOOR EXTERNAL LEFT COLUMN		KDR1261B	0511 -M RIGHT EXTERNAL DOOR	<table border="1"> <thead> <tr> <th>Code</th> <th>Description</th> <th>Qty</th> <th>UOM</th> </tr> </thead> <tbody> <tr> <td>VM2315B0</td> <td>S6 INTERNAL GLASS SUPPORT</td> <td>3.000</td> <td>PC</td> </tr> <tr> <td>VM2505B1</td> <td>MM PLUS INTERNAL GLASS SUPPORT</td> <td>3.000</td> <td>PC</td> </tr> <tr> <td>VP1080A0</td> <td>UPPER HINGE CAP FOR LOWER INNER GLASS</td> <td>1.000</td> <td>PC</td> </tr> <tr> <td>VP1081A0</td> <td>UPPER HINGE CAP FOR UPPER INNER GLASS</td> <td>1.000</td> <td>PC</td> </tr> <tr> <td>VT1276A0</td> <td>XEVC-0511-E DOOR EXTERNAL GLASS</td> <td>1.000</td> <td>PC</td> </tr> </tbody> </table>	Code	Description	Qty	UOM	VM2315B0	S6 INTERNAL GLASS SUPPORT	3.000	PC	VM2505B1	MM PLUS INTERNAL GLASS SUPPORT	3.000	PC	VP1080A0	UPPER HINGE CAP FOR LOWER INNER GLASS	1.000	PC	VP1081A0	UPPER HINGE CAP FOR UPPER INNER GLASS	1.000	PC	VT1276A0	XEVC-0511-E DOOR EXTERNAL GLASS	1.000	PC													
			Code	Description	Qty	UOM																																				
VM2315B0	S6 INTERNAL GLASS SUPPORT	3.000	PC																																							
VM2505B1	MM PLUS INTERNAL GLASS SUPPORT	3.000	PC																																							
VP1080A0	UPPER HINGE CAP FOR LOWER INNER GLASS	1.000	PC																																							
VP1081A0	UPPER HINGE CAP FOR UPPER INNER GLASS	1.000	PC																																							
VT1276A0	XEVC-0511-E DOOR EXTERNAL GLASS	1.000	PC																																							
KDR1261A	0511 RIGHT EXTERNAL DOOR	<table border="1"> <thead> <tr> <th>Code</th> <th>Description</th> <th>Qty</th> <th>UOM</th> </tr> </thead> <tbody> <tr> <td>0B1106A0</td> <td>XEVC-0511-E DOOR EXTERNAL LEFT COLUMN</td> <td>1.000</td> <td>PC</td> </tr> <tr> <td>0B1107A1</td> <td>XEVC-0511-E LEFT INT DOOR COLUMN</td> <td>1.000</td> <td>PC</td> </tr> <tr> <td>0B1108B1</td> <td>XEVC-0511 DOOR EXTERNAL RIGHT COLUMN</td> <td>1.000</td> <td>PC</td> </tr> <tr> <td>0B1109A1</td> <td>XEVC-0511-E RIGHT INT DOOR COLUMN</td> <td>1.000</td> <td>PC</td> </tr> <tr> <td>0B1122A1</td> <td>750MM DOOR LOWER FRAME SHAPE</td> <td>1.000</td> <td>PC</td> </tr> <tr> <td>0B1166A1</td> <td>XEVC-0511-E EXT GLASS SUPPORT PROFILE</td> <td>2.000</td> <td>PC</td> </tr> <tr> <td>0B1216A1</td> <td>MM CT DOUBLE GLASS DOOR UPPER BEAM</td> <td>1.000</td> <td>PC</td> </tr> <tr> <td>0B1217A1</td> <td>MM DOUBLE GLASS DOOR INT UPPER BEAM 750</td> <td>1.000</td> <td>PC</td> </tr> <tr> <td>CE1052A1</td> <td>CABLE CONNECTION CONTROL - USB MM 750m</td> <td>1.000</td> <td>PC</td> </tr> </tbody> </table>	Code	Description	Qty	UOM	0B1106A0	XEVC-0511-E DOOR EXTERNAL LEFT COLUMN	1.000	PC	0B1107A1	XEVC-0511-E LEFT INT DOOR COLUMN	1.000	PC	0B1108B1	XEVC-0511 DOOR EXTERNAL RIGHT COLUMN	1.000	PC	0B1109A1	XEVC-0511-E RIGHT INT DOOR COLUMN	1.000	PC	0B1122A1	750MM DOOR LOWER FRAME SHAPE	1.000	PC	0B1166A1	XEVC-0511-E EXT GLASS SUPPORT PROFILE	2.000	PC	0B1216A1	MM CT DOUBLE GLASS DOOR UPPER BEAM	1.000	PC	0B1217A1	MM DOUBLE GLASS DOOR INT UPPER BEAM 750	1.000	PC	CE1052A1	CABLE CONNECTION CONTROL - USB MM 750m	1.000	PC
Code	Description	Qty	UOM																																							
0B1106A0	XEVC-0511-E DOOR EXTERNAL LEFT COLUMN	1.000	PC																																							
0B1107A1	XEVC-0511-E LEFT INT DOOR COLUMN	1.000	PC																																							
0B1108B1	XEVC-0511 DOOR EXTERNAL RIGHT COLUMN	1.000	PC																																							
0B1109A1	XEVC-0511-E RIGHT INT DOOR COLUMN	1.000	PC																																							
0B1122A1	750MM DOOR LOWER FRAME SHAPE	1.000	PC																																							
0B1166A1	XEVC-0511-E EXT GLASS SUPPORT PROFILE	2.000	PC																																							
0B1216A1	MM CT DOUBLE GLASS DOOR UPPER BEAM	1.000	PC																																							
0B1217A1	MM DOUBLE GLASS DOOR INT UPPER BEAM 750	1.000	PC																																							
CE1052A1	CABLE CONNECTION CONTROL - USB MM 750m	1.000	PC																																							



COMPONENT			SPARE PART																																																																						
Code	Description	Image	Code	Description	Kit components																																																																				
OB1106A	XEVC-0511-E DOOR EXTERNAL LEFT COLUMN		KDR1261A	0511 RIGHT EXTERNAL DOOR	<table border="1"> <thead> <tr> <th>Code</th> <th>Description</th> <th>Qty</th> <th>UOM</th> </tr> </thead> <tbody> <tr> <td>CE1053B0</td> <td>MM MICROFIT LED BAR POWER SUPPLY CABL</td> <td>1.000</td> <td>PC</td> </tr> <tr> <td>CE1275A0</td> <td>3M POWER - CONTROL CONNECTION CABLE</td> <td>1.000</td> <td>PC</td> </tr> <tr> <td>CE1285A0</td> <td>EMI ROUND FERRITE MOD.26438015 02</td> <td>1.000</td> <td>PC</td> </tr> <tr> <td>CE1290A0</td> <td>EXTRACTABL E FEMALE TERMINAL CPF 5/4</td> <td>1.000</td> <td>PC</td> </tr> <tr> <td>GN1525A0</td> <td>O-RING INT DIAM 9,5 THK 1 NBR 70</td> <td>1.000</td> <td>PC</td> </tr> <tr> <td>LP1019A0</td> <td>6 SERIES L200 LED LIGHT BAR - E415</td> <td>1.000</td> <td>PC</td> </tr> <tr> <td>LP1025A0</td> <td>L=415 LED LIGHT BAR COVER</td> <td>1.000</td> <td>PC</td> </tr> <tr> <td>MG1083A2</td> <td>MM COMPLETE HANDLE</td> <td>1.000</td> <td>PC</td> </tr> <tr> <td>SL1170A1</td> <td>S57 BLACK SILICON - 310ml CARTRIDGE</td> <td>30.000</td> <td>ML</td> </tr> <tr> <td>VE1030A1</td> <td>MAGNET FOR DOOR MICROSWITC H D=22.9mm</td> <td>2.000</td> <td>PC</td> </tr> <tr> <td>VI1034A0</td> <td>STAINLESS STEEL WASHER 8.4x16x1</td> <td>1.000</td> <td>PC</td> </tr> <tr> <td>VI1147A0</td> <td>5X25 STAINLESS STEEL SCREW</td> <td>16.000</td> <td>PC</td> </tr> <tr> <td>VI1220A1</td> <td>4,2x12 TCB SELF-TAPPIN G SCREW</td> <td>25.000</td> <td>PC</td> </tr> <tr> <td>VI1996A0</td> <td>M5x35 SCREW</td> <td>13.000</td> <td>PC</td> </tr> <tr> <td>VM1630A1</td> <td>INTERNAL GLASS PUSHING CAP</td> <td>3.000</td> <td>PC</td> </tr> <tr> <td>VM1631A0</td> <td>PLUS INNER GLASS PUSHING CAP</td> <td>2.000</td> <td>PC</td> </tr> </tbody> </table>	Code	Description	Qty	UOM	CE1053B0	MM MICROFIT LED BAR POWER SUPPLY CABL	1.000	PC	CE1275A0	3M POWER - CONTROL CONNECTION CABLE	1.000	PC	CE1285A0	EMI ROUND FERRITE MOD.26438015 02	1.000	PC	CE1290A0	EXTRACTABL E FEMALE TERMINAL CPF 5/4	1.000	PC	GN1525A0	O-RING INT DIAM 9,5 THK 1 NBR 70	1.000	PC	LP1019A0	6 SERIES L200 LED LIGHT BAR - E415	1.000	PC	LP1025A0	L=415 LED LIGHT BAR COVER	1.000	PC	MG1083A2	MM COMPLETE HANDLE	1.000	PC	SL1170A1	S57 BLACK SILICON - 310ml CARTRIDGE	30.000	ML	VE1030A1	MAGNET FOR DOOR MICROSWITC H D=22.9mm	2.000	PC	VI1034A0	STAINLESS STEEL WASHER 8.4x16x1	1.000	PC	VI1147A0	5X25 STAINLESS STEEL SCREW	16.000	PC	VI1220A1	4,2x12 TCB SELF-TAPPIN G SCREW	25.000	PC	VI1996A0	M5x35 SCREW	13.000	PC	VM1630A1	INTERNAL GLASS PUSHING CAP	3.000	PC	VM1631A0	PLUS INNER GLASS PUSHING CAP	2.000	PC
Code	Description	Qty	UOM																																																																						
CE1053B0	MM MICROFIT LED BAR POWER SUPPLY CABL	1.000	PC																																																																						
CE1275A0	3M POWER - CONTROL CONNECTION CABLE	1.000	PC																																																																						
CE1285A0	EMI ROUND FERRITE MOD.26438015 02	1.000	PC																																																																						
CE1290A0	EXTRACTABL E FEMALE TERMINAL CPF 5/4	1.000	PC																																																																						
GN1525A0	O-RING INT DIAM 9,5 THK 1 NBR 70	1.000	PC																																																																						
LP1019A0	6 SERIES L200 LED LIGHT BAR - E415	1.000	PC																																																																						
LP1025A0	L=415 LED LIGHT BAR COVER	1.000	PC																																																																						
MG1083A2	MM COMPLETE HANDLE	1.000	PC																																																																						
SL1170A1	S57 BLACK SILICON - 310ml CARTRIDGE	30.000	ML																																																																						
VE1030A1	MAGNET FOR DOOR MICROSWITC H D=22.9mm	2.000	PC																																																																						
VI1034A0	STAINLESS STEEL WASHER 8.4x16x1	1.000	PC																																																																						
VI1147A0	5X25 STAINLESS STEEL SCREW	16.000	PC																																																																						
VI1220A1	4,2x12 TCB SELF-TAPPIN G SCREW	25.000	PC																																																																						
VI1996A0	M5x35 SCREW	13.000	PC																																																																						
VM1630A1	INTERNAL GLASS PUSHING CAP	3.000	PC																																																																						
VM1631A0	PLUS INNER GLASS PUSHING CAP	2.000	PC																																																																						



COMPONENT			SPARE PART																																																																														
Code	Description	Image	Code	Description	Kit components																																																																												
OB1106A	XEVC-0511-E DOOR EXTERNAL LEFT COLUMN		KDR1261A	0511 RIGHT EXTERNAL DOOR	<table border="1"> <thead> <tr> <th>Code</th> <th>Description</th> <th>Qty</th> <th>UOM</th> </tr> </thead> <tbody> <tr> <td>VM2259A1</td> <td>6 SERIES DOOR LOWER LEFT CAP</td> <td>1.000</td> <td>PC</td> </tr> <tr> <td>VM2260A1</td> <td>6 SERIES DOOR UPPER LEFT CAP</td> <td>1.000</td> <td>PC</td> </tr> <tr> <td>VM2261A1</td> <td>MM DOOR LOWER RIGHT CAP</td> <td>1.000</td> <td>PC</td> </tr> <tr> <td>VM2262A1</td> <td>MM DOOR UPPER RIGHT CAP</td> <td>1.000</td> <td>PC</td> </tr> <tr> <td>VM2267A0</td> <td>INTERNAL GLASS LOCKING SYSTEM SLIDER</td> <td>2.000</td> <td>PC</td> </tr> <tr> <td>VM2268A0</td> <td>DOOR MAGNET COVER</td> <td>2.000</td> <td>PC</td> </tr> <tr> <td>VM2269A0</td> <td>INTERNAL GLASS LOCKING SYSTEM CAP</td> <td>2.000</td> <td>PC</td> </tr> <tr> <td>VM2274A0</td> <td>GROOVED BUSHING</td> <td>1.000</td> <td>PC</td> </tr> <tr> <td>VM2275A0</td> <td>SMOOTH BUSHING</td> <td>1.000</td> <td>PC</td> </tr> <tr> <td>VM2284A0</td> <td>750 SERIES DRIP PROFILE</td> <td>1.000</td> <td>PC</td> </tr> <tr> <td>VM2305A0</td> <td>6 SERIES DOOR CAP FIXING PAWL</td> <td>14.000</td> <td>PC</td> </tr> <tr> <td>VM2312A0</td> <td>6 S. DRIP PROFILE DRAIN LEFT PIPE</td> <td>1.000</td> <td>PC</td> </tr> <tr> <td>VM2314A0</td> <td>6 S. DRIP PROFILE CAP</td> <td>1.000</td> <td>PC</td> </tr> <tr> <td>VM2315A0</td> <td>MIND.Maps INTERNAL GLASS CAP SUPPORT</td> <td>3.000</td> <td>PC</td> </tr> <tr> <td>VM2505A0</td> <td>MM PLUS INTERNAL GLASS SUPPORT</td> <td>2.000</td> <td>PC</td> </tr> <tr> <td>VM2518A0</td> <td>BOARD COOLING FAN SUPPORT</td> <td>1.000</td> <td>PC</td> </tr> <tr> <td>VN1179A1</td> <td>CONTROL BOARD 40x40x20mm 12V COOLING FAN</td> <td>1.000</td> <td>PC</td> </tr> <tr> <td>VT1276A0</td> <td>XEVC-0511-E DOOR EXTERNAL GLASS</td> <td>1.000</td> <td>PC</td> </tr> </tbody> </table>	Code	Description	Qty	UOM	VM2259A1	6 SERIES DOOR LOWER LEFT CAP	1.000	PC	VM2260A1	6 SERIES DOOR UPPER LEFT CAP	1.000	PC	VM2261A1	MM DOOR LOWER RIGHT CAP	1.000	PC	VM2262A1	MM DOOR UPPER RIGHT CAP	1.000	PC	VM2267A0	INTERNAL GLASS LOCKING SYSTEM SLIDER	2.000	PC	VM2268A0	DOOR MAGNET COVER	2.000	PC	VM2269A0	INTERNAL GLASS LOCKING SYSTEM CAP	2.000	PC	VM2274A0	GROOVED BUSHING	1.000	PC	VM2275A0	SMOOTH BUSHING	1.000	PC	VM2284A0	750 SERIES DRIP PROFILE	1.000	PC	VM2305A0	6 SERIES DOOR CAP FIXING PAWL	14.000	PC	VM2312A0	6 S. DRIP PROFILE DRAIN LEFT PIPE	1.000	PC	VM2314A0	6 S. DRIP PROFILE CAP	1.000	PC	VM2315A0	MIND.Maps INTERNAL GLASS CAP SUPPORT	3.000	PC	VM2505A0	MM PLUS INTERNAL GLASS SUPPORT	2.000	PC	VM2518A0	BOARD COOLING FAN SUPPORT	1.000	PC	VN1179A1	CONTROL BOARD 40x40x20mm 12V COOLING FAN	1.000	PC	VT1276A0	XEVC-0511-E DOOR EXTERNAL GLASS	1.000	PC
Code	Description	Qty	UOM																																																																														
VM2259A1	6 SERIES DOOR LOWER LEFT CAP	1.000	PC																																																																														
VM2260A1	6 SERIES DOOR UPPER LEFT CAP	1.000	PC																																																																														
VM2261A1	MM DOOR LOWER RIGHT CAP	1.000	PC																																																																														
VM2262A1	MM DOOR UPPER RIGHT CAP	1.000	PC																																																																														
VM2267A0	INTERNAL GLASS LOCKING SYSTEM SLIDER	2.000	PC																																																																														
VM2268A0	DOOR MAGNET COVER	2.000	PC																																																																														
VM2269A0	INTERNAL GLASS LOCKING SYSTEM CAP	2.000	PC																																																																														
VM2274A0	GROOVED BUSHING	1.000	PC																																																																														
VM2275A0	SMOOTH BUSHING	1.000	PC																																																																														
VM2284A0	750 SERIES DRIP PROFILE	1.000	PC																																																																														
VM2305A0	6 SERIES DOOR CAP FIXING PAWL	14.000	PC																																																																														
VM2312A0	6 S. DRIP PROFILE DRAIN LEFT PIPE	1.000	PC																																																																														
VM2314A0	6 S. DRIP PROFILE CAP	1.000	PC																																																																														
VM2315A0	MIND.Maps INTERNAL GLASS CAP SUPPORT	3.000	PC																																																																														
VM2505A0	MM PLUS INTERNAL GLASS SUPPORT	2.000	PC																																																																														
VM2518A0	BOARD COOLING FAN SUPPORT	1.000	PC																																																																														
VN1179A1	CONTROL BOARD 40x40x20mm 12V COOLING FAN	1.000	PC																																																																														
VT1276A0	XEVC-0511-E DOOR EXTERNAL GLASS	1.000	PC																																																																														



COMPONENT			SPARE PART																																																																		
Code	Description	Image	Code	Description	Kit components																																																																
0B1107A	XEVC-0511-E LEFT INT DOOR COLUMN		KDR1325A	0511 ZERO RIGHT -M EXTERNAL DOOR	<table border="1"> <thead> <tr> <th>Code</th> <th>Description</th> <th>Qty</th> <th>UOM</th> </tr> </thead> <tbody> <tr> <td>0B1106A0</td> <td>XEVC-0511-E DOOR EXTERNAL LEFT COLUMN</td> <td>1.000</td> <td>PC</td> </tr> <tr> <td>0B1107A1</td> <td>XEVC-0511-E LEFT INT DOOR COLUMN</td> <td>1.000</td> <td>PC</td> </tr> <tr> <td>0B1108B1</td> <td>XEVC-0511 DOOR EXTERNAL RIGHT COLUMN</td> <td>1.000</td> <td>PC</td> </tr> <tr> <td>0B1109A1</td> <td>XEVC-0511-E RIGHT INT DOOR COLUMN</td> <td>1.000</td> <td>PC</td> </tr> <tr> <td>0B1122B0</td> <td>MM CT DOOR LOWER CROSS BAR</td> <td>1.000</td> <td>PC</td> </tr> <tr> <td>0B1166A1</td> <td>XEVC-0511-E EXT GLASS SUPPORT PROFILE</td> <td>2.000</td> <td>PC</td> </tr> <tr> <td>0B1216B0</td> <td>MM CT DOUBLE GLASS DOOR UPPER CROSS BAR</td> <td>1.000</td> <td>PC</td> </tr> <tr> <td>0B1217A1</td> <td>MM DOUBLE GLASS DOOR INT UPPER BEAM 750</td> <td>1.000</td> <td>PC</td> </tr> <tr> <td>0H2892A0</td> <td>LED BAR UPPER CAP PLATE</td> <td>1.000</td> <td>PC</td> </tr> <tr> <td>0H2893A0</td> <td>LED BAR LOWER CAP PLATE</td> <td>1.000</td> <td>PC</td> </tr> <tr> <td>CE1096A0</td> <td>4 POLES MICROFIT 3 M BUS CABLE</td> <td>1.000</td> <td>PC</td> </tr> <tr> <td>CE1285A0</td> <td>EMI ROUND FERRITE MOD.26438015 02</td> <td>2.000</td> <td>PC</td> </tr> <tr> <td>CE1851A0</td> <td>MICROFIT CABLE 2P M-F-F AWG22</td> <td>1.000</td> <td>PC</td> </tr> <tr> <td>CE2001A0</td> <td>MICROFIT CABLE 2PM-100-2PM 2AWG22</td> <td>1.000</td> <td>PC</td> </tr> <tr> <td>CE2002A0</td> <td>MICROFIT CABLE 2PM-100-AMP MODU2 2AWG22</td> <td>1.000</td> <td>PC</td> </tr> </tbody> </table>	Code	Description	Qty	UOM	0B1106A0	XEVC-0511-E DOOR EXTERNAL LEFT COLUMN	1.000	PC	0B1107A1	XEVC-0511-E LEFT INT DOOR COLUMN	1.000	PC	0B1108B1	XEVC-0511 DOOR EXTERNAL RIGHT COLUMN	1.000	PC	0B1109A1	XEVC-0511-E RIGHT INT DOOR COLUMN	1.000	PC	0B1122B0	MM CT DOOR LOWER CROSS BAR	1.000	PC	0B1166A1	XEVC-0511-E EXT GLASS SUPPORT PROFILE	2.000	PC	0B1216B0	MM CT DOUBLE GLASS DOOR UPPER CROSS BAR	1.000	PC	0B1217A1	MM DOUBLE GLASS DOOR INT UPPER BEAM 750	1.000	PC	0H2892A0	LED BAR UPPER CAP PLATE	1.000	PC	0H2893A0	LED BAR LOWER CAP PLATE	1.000	PC	CE1096A0	4 POLES MICROFIT 3 M BUS CABLE	1.000	PC	CE1285A0	EMI ROUND FERRITE MOD.26438015 02	2.000	PC	CE1851A0	MICROFIT CABLE 2P M-F-F AWG22	1.000	PC	CE2001A0	MICROFIT CABLE 2PM-100-2PM 2AWG22	1.000	PC	CE2002A0	MICROFIT CABLE 2PM-100-AMP MODU2 2AWG22	1.000	PC
					Code	Description	Qty	UOM																																																													
					0B1106A0	XEVC-0511-E DOOR EXTERNAL LEFT COLUMN	1.000	PC																																																													
					0B1107A1	XEVC-0511-E LEFT INT DOOR COLUMN	1.000	PC																																																													
					0B1108B1	XEVC-0511 DOOR EXTERNAL RIGHT COLUMN	1.000	PC																																																													
					0B1109A1	XEVC-0511-E RIGHT INT DOOR COLUMN	1.000	PC																																																													
					0B1122B0	MM CT DOOR LOWER CROSS BAR	1.000	PC																																																													
					0B1166A1	XEVC-0511-E EXT GLASS SUPPORT PROFILE	2.000	PC																																																													
					0B1216B0	MM CT DOUBLE GLASS DOOR UPPER CROSS BAR	1.000	PC																																																													
					0B1217A1	MM DOUBLE GLASS DOOR INT UPPER BEAM 750	1.000	PC																																																													
					0H2892A0	LED BAR UPPER CAP PLATE	1.000	PC																																																													
					0H2893A0	LED BAR LOWER CAP PLATE	1.000	PC																																																													
					CE1096A0	4 POLES MICROFIT 3 M BUS CABLE	1.000	PC																																																													
					CE1285A0	EMI ROUND FERRITE MOD.26438015 02	2.000	PC																																																													
CE1851A0	MICROFIT CABLE 2P M-F-F AWG22	1.000	PC																																																																		
CE2001A0	MICROFIT CABLE 2PM-100-2PM 2AWG22	1.000	PC																																																																		
CE2002A0	MICROFIT CABLE 2PM-100-AMP MODU2 2AWG22	1.000	PC																																																																		



COMPONENT			SPARE PART																																																																						
Code	Description	Image	Code	Description	Kit components																																																																				
OB1107A	XEVC-0511-E LEFT INT DOOR COLUMN		KDR1325A	0511 ZERO RIGHT -M EXTERNAL DOOR	<table border="1"> <thead> <tr> <th>Code</th> <th>Description</th> <th>Qty</th> <th>UOM</th> </tr> </thead> <tbody> <tr> <td>GN1525A0</td> <td>O-RING INT DIAM 9,5 THK 1 NBR 70</td> <td>1.000</td> <td>PC</td> </tr> <tr> <td>LP1019A0</td> <td>6 SERIES L200 LED LIGHT BAR - E415</td> <td>1.000</td> <td>PC</td> </tr> <tr> <td>MG1099A1</td> <td>MM COMPLETE HANDLE</td> <td>1.000</td> <td>PC</td> </tr> <tr> <td>RC1200A0</td> <td>ED=4 WIRE D.=0.5 COMPRESSIO N SPRING</td> <td>4.000</td> <td>PC</td> </tr> <tr> <td>SL1170A1</td> <td>S57 BLACK SILICON - 310ml CARTRIDGE</td> <td>30.000</td> <td>ML</td> </tr> <tr> <td>SL1221A0</td> <td>GN1/1 EXTERNAL GLASS UPPER SILICONE</td> <td>1.000</td> <td>PC</td> </tr> <tr> <td>SL1222A0</td> <td>0511 EXTERNAL GLASS LATERAL SILICONE</td> <td>4.000</td> <td>PC</td> </tr> <tr> <td>VE1030A1</td> <td>MAGNET FOR DOOR MICROSWITC H D=22,9mm</td> <td>2.000</td> <td>PC</td> </tr> <tr> <td>VI0239A1</td> <td>SELF-TAPPIN G SCREW 4.2X25 TCB+ INOX</td> <td>4.000</td> <td>PC</td> </tr> <tr> <td>VI1034A0</td> <td>STAINLESS STEEL WASHER 8.4x16x1</td> <td>1.000</td> <td>PC</td> </tr> <tr> <td>VI1074A0</td> <td>4X16 SCREW FOR PLASTIC</td> <td>2.000</td> <td>PC</td> </tr> <tr> <td>VI1103A0</td> <td>40X12 TBSP SCREW FOR PLASTIC</td> <td>2.000</td> <td>PC</td> </tr> <tr> <td>VI1220A1</td> <td>4,2x12 TCB SELF-TAPPIN G SCREW</td> <td>26.000</td> <td>PC</td> </tr> <tr> <td>VI1930A1</td> <td>ST. STEEL 5X20 CHIP SCREW</td> <td>16.000</td> <td>PC</td> </tr> <tr> <td>VI1996A0</td> <td>M5x35 SCREW</td> <td>13.000</td> <td>PC</td> </tr> <tr> <td>VI2037A1</td> <td>40X8 TORX SHEETTRACS SELF-THREAD SCREW</td> <td>6.000</td> <td>PC</td> </tr> </tbody> </table>	Code	Description	Qty	UOM	GN1525A0	O-RING INT DIAM 9,5 THK 1 NBR 70	1.000	PC	LP1019A0	6 SERIES L200 LED LIGHT BAR - E415	1.000	PC	MG1099A1	MM COMPLETE HANDLE	1.000	PC	RC1200A0	ED=4 WIRE D.=0.5 COMPRESSIO N SPRING	4.000	PC	SL1170A1	S57 BLACK SILICON - 310ml CARTRIDGE	30.000	ML	SL1221A0	GN1/1 EXTERNAL GLASS UPPER SILICONE	1.000	PC	SL1222A0	0511 EXTERNAL GLASS LATERAL SILICONE	4.000	PC	VE1030A1	MAGNET FOR DOOR MICROSWITC H D=22,9mm	2.000	PC	VI0239A1	SELF-TAPPIN G SCREW 4.2X25 TCB+ INOX	4.000	PC	VI1034A0	STAINLESS STEEL WASHER 8.4x16x1	1.000	PC	VI1074A0	4X16 SCREW FOR PLASTIC	2.000	PC	VI1103A0	40X12 TBSP SCREW FOR PLASTIC	2.000	PC	VI1220A1	4,2x12 TCB SELF-TAPPIN G SCREW	26.000	PC	VI1930A1	ST. STEEL 5X20 CHIP SCREW	16.000	PC	VI1996A0	M5x35 SCREW	13.000	PC	VI2037A1	40X8 TORX SHEETTRACS SELF-THREAD SCREW	6.000	PC
					Code	Description	Qty	UOM																																																																	
					GN1525A0	O-RING INT DIAM 9,5 THK 1 NBR 70	1.000	PC																																																																	
					LP1019A0	6 SERIES L200 LED LIGHT BAR - E415	1.000	PC																																																																	
					MG1099A1	MM COMPLETE HANDLE	1.000	PC																																																																	
					RC1200A0	ED=4 WIRE D.=0.5 COMPRESSIO N SPRING	4.000	PC																																																																	
					SL1170A1	S57 BLACK SILICON - 310ml CARTRIDGE	30.000	ML																																																																	
					SL1221A0	GN1/1 EXTERNAL GLASS UPPER SILICONE	1.000	PC																																																																	
					SL1222A0	0511 EXTERNAL GLASS LATERAL SILICONE	4.000	PC																																																																	
					VE1030A1	MAGNET FOR DOOR MICROSWITC H D=22,9mm	2.000	PC																																																																	
					VI0239A1	SELF-TAPPIN G SCREW 4.2X25 TCB+ INOX	4.000	PC																																																																	
					VI1034A0	STAINLESS STEEL WASHER 8.4x16x1	1.000	PC																																																																	
					VI1074A0	4X16 SCREW FOR PLASTIC	2.000	PC																																																																	
					VI1103A0	40X12 TBSP SCREW FOR PLASTIC	2.000	PC																																																																	
					VI1220A1	4,2x12 TCB SELF-TAPPIN G SCREW	26.000	PC																																																																	
VI1930A1	ST. STEEL 5X20 CHIP SCREW	16.000	PC																																																																						
VI1996A0	M5x35 SCREW	13.000	PC																																																																						
VI2037A1	40X8 TORX SHEETTRACS SELF-THREAD SCREW	6.000	PC																																																																						



COMPONENT			SPARE PART																																																																														
Code	Description	Image	Code	Description	Kit components																																																																												
OB1107A	XEVC-0511-E LEFT INT DOOR COLUMN		KDR1325A	0511 ZERO RIGHT -M EXTERNAL DOOR	<table border="1"> <thead> <tr> <th>Code</th> <th>Description</th> <th>Qty</th> <th>UOM</th> </tr> </thead> <tbody> <tr> <td>VM1490A0</td> <td>CHEFTOP/BAK ERTOP HANDLE SCREWS COVER</td> <td>2.000</td> <td>PC</td> </tr> <tr> <td>VM1630A1</td> <td>INTERNAL GLASS PUSHING CAP</td> <td>3.000</td> <td>PC</td> </tr> <tr> <td>VM1631A0</td> <td>PLUS INNER GLASS PUSHING CAP</td> <td>3.000</td> <td>PC</td> </tr> <tr> <td>VM2259B0</td> <td>VM2259B0</td> <td>1.000</td> <td>PC</td> </tr> <tr> <td>VM2260B0</td> <td>S6 LEFT UPPER CAP</td> <td>1.000</td> <td>PC</td> </tr> <tr> <td>VM2261B0</td> <td>MM -M DOOR RIGHT LOWER CAP</td> <td>1.000</td> <td>PC</td> </tr> <tr> <td>VM2262B0</td> <td>MM -M DOOR RIGHT UPPER CAP</td> <td>1.000</td> <td>PC</td> </tr> <tr> <td>VM2267A0</td> <td>INTERNAL GLASS LOCKING SYSTEM SLIDER</td> <td>2.000</td> <td>PC</td> </tr> <tr> <td>VM2268A0</td> <td>DOOR MAGNET COVER</td> <td>2.000</td> <td>PC</td> </tr> <tr> <td>VM2269B0</td> <td>INNER GLASS FIXING CAP</td> <td>2.000</td> <td>PC</td> </tr> <tr> <td>VM2274A0</td> <td>GROOVED BUSHING</td> <td>1.000</td> <td>PC</td> </tr> <tr> <td>VM2275A0</td> <td>SMOOTH BUSHING</td> <td>1.000</td> <td>PC</td> </tr> <tr> <td>VM2284B0</td> <td>750 SERIES DRIP PROFILE KIT</td> <td>1.000</td> <td>PC</td> </tr> <tr> <td>VM2305A0</td> <td>6 SERIES DOOR CAP FIXING PAWL</td> <td>14.000</td> <td>PC</td> </tr> <tr> <td>VM2312A0</td> <td>6 S. DRIP PROFILE DRAIN LEFT PIPE</td> <td>1.000</td> <td>PC</td> </tr> <tr> <td>VM2314A0</td> <td>6 S. DRIP PROFILE CAP</td> <td>1.000</td> <td>PC</td> </tr> <tr> <td>VM2315B0</td> <td>S6 INTERNAL GLASS SUPPORT</td> <td>3.000</td> <td>PC</td> </tr> <tr> <td>VM2505B1</td> <td>MM PLUS INTERNAL GLASS SUPPORT</td> <td>3.000</td> <td>PC</td> </tr> </tbody> </table>	Code	Description	Qty	UOM	VM1490A0	CHEFTOP/BAK ERTOP HANDLE SCREWS COVER	2.000	PC	VM1630A1	INTERNAL GLASS PUSHING CAP	3.000	PC	VM1631A0	PLUS INNER GLASS PUSHING CAP	3.000	PC	VM2259B0	VM2259B0	1.000	PC	VM2260B0	S6 LEFT UPPER CAP	1.000	PC	VM2261B0	MM -M DOOR RIGHT LOWER CAP	1.000	PC	VM2262B0	MM -M DOOR RIGHT UPPER CAP	1.000	PC	VM2267A0	INTERNAL GLASS LOCKING SYSTEM SLIDER	2.000	PC	VM2268A0	DOOR MAGNET COVER	2.000	PC	VM2269B0	INNER GLASS FIXING CAP	2.000	PC	VM2274A0	GROOVED BUSHING	1.000	PC	VM2275A0	SMOOTH BUSHING	1.000	PC	VM2284B0	750 SERIES DRIP PROFILE KIT	1.000	PC	VM2305A0	6 SERIES DOOR CAP FIXING PAWL	14.000	PC	VM2312A0	6 S. DRIP PROFILE DRAIN LEFT PIPE	1.000	PC	VM2314A0	6 S. DRIP PROFILE CAP	1.000	PC	VM2315B0	S6 INTERNAL GLASS SUPPORT	3.000	PC	VM2505B1	MM PLUS INTERNAL GLASS SUPPORT	3.000	PC
Code	Description	Qty	UOM																																																																														
VM1490A0	CHEFTOP/BAK ERTOP HANDLE SCREWS COVER	2.000	PC																																																																														
VM1630A1	INTERNAL GLASS PUSHING CAP	3.000	PC																																																																														
VM1631A0	PLUS INNER GLASS PUSHING CAP	3.000	PC																																																																														
VM2259B0	VM2259B0	1.000	PC																																																																														
VM2260B0	S6 LEFT UPPER CAP	1.000	PC																																																																														
VM2261B0	MM -M DOOR RIGHT LOWER CAP	1.000	PC																																																																														
VM2262B0	MM -M DOOR RIGHT UPPER CAP	1.000	PC																																																																														
VM2267A0	INTERNAL GLASS LOCKING SYSTEM SLIDER	2.000	PC																																																																														
VM2268A0	DOOR MAGNET COVER	2.000	PC																																																																														
VM2269B0	INNER GLASS FIXING CAP	2.000	PC																																																																														
VM2274A0	GROOVED BUSHING	1.000	PC																																																																														
VM2275A0	SMOOTH BUSHING	1.000	PC																																																																														
VM2284B0	750 SERIES DRIP PROFILE KIT	1.000	PC																																																																														
VM2305A0	6 SERIES DOOR CAP FIXING PAWL	14.000	PC																																																																														
VM2312A0	6 S. DRIP PROFILE DRAIN LEFT PIPE	1.000	PC																																																																														
VM2314A0	6 S. DRIP PROFILE CAP	1.000	PC																																																																														
VM2315B0	S6 INTERNAL GLASS SUPPORT	3.000	PC																																																																														
VM2505B1	MM PLUS INTERNAL GLASS SUPPORT	3.000	PC																																																																														



COMPONENT			SPARE PART																																															
Code	Description	Image	Code	Description	Kit components																																													
OB1107A	XEVC-0511-E LEFT INT DOOR COLUMN		KDR1325A	0511 ZERO RIGHT -M EXTERNAL DOOR	<table border="1"> <thead> <tr> <th>Code</th> <th>Description</th> <th>Qty</th> <th>UOM</th> </tr> </thead> <tbody> <tr> <td>VP1080A0</td> <td>UPPER HINGE CAP FOR LOWER INNER GLASS</td> <td>1.000</td> <td>PC</td> </tr> <tr> <td>VP1081A0</td> <td>UPPER HINGE CAP FOR UPPER INNER GLASS</td> <td>1.000</td> <td>PC</td> </tr> <tr> <td>VT1276A0</td> <td>XEVC-0511-E DOOR EXTERNAL GLASS</td> <td>1.000</td> <td>PC</td> </tr> </tbody> </table>	Code	Description	Qty	UOM	VP1080A0	UPPER HINGE CAP FOR LOWER INNER GLASS	1.000	PC	VP1081A0	UPPER HINGE CAP FOR UPPER INNER GLASS	1.000	PC	VT1276A0	XEVC-0511-E DOOR EXTERNAL GLASS	1.000	PC																													
			Code	Description	Qty	UOM																																												
VP1080A0	UPPER HINGE CAP FOR LOWER INNER GLASS	1.000	PC																																															
VP1081A0	UPPER HINGE CAP FOR UPPER INNER GLASS	1.000	PC																																															
VT1276A0	XEVC-0511-E DOOR EXTERNAL GLASS	1.000	PC																																															
KDR1269B	BT-04 -M EXTERNAL RIGHT DOOR	<table border="1"> <thead> <tr> <th>Code</th> <th>Description</th> <th>Qty</th> <th>UOM</th> </tr> </thead> <tbody> <tr> <td>OB1107A1</td> <td>XEVC-0511-E LEFT INT DOOR COLUM</td> <td>1.000</td> <td>PC</td> </tr> <tr> <td>OB1108B1</td> <td>XEVC-0511 DOOR EXTERNAL RIGHT COLUM</td> <td>1.000</td> <td>PC</td> </tr> <tr> <td>OB1109A1</td> <td>XEVC-0511-E RIGHT INT DOOR COLUM</td> <td>1.000</td> <td>PC</td> </tr> <tr> <td>OB1126B0</td> <td>MM BT DOOR LOWER CROSS BAR</td> <td>1.000</td> <td>PC</td> </tr> <tr> <td>OB1166A1</td> <td>XEVC-0511-E EXT GLASS SUPPORT PROFILE</td> <td>2.000</td> <td>PC</td> </tr> <tr> <td>OB1174A0</td> <td>XEBC-04EU-E LEFT EXT DOOR COLUM</td> <td>1.000</td> <td>PC</td> </tr> <tr> <td>OB1218B0</td> <td>MM BT DOUBLE GLASS DOOR UPPER CROSS BAR</td> <td>1.000</td> <td>PC</td> </tr> <tr> <td>OB1219A1</td> <td>MM DOUBLE GLASS DOOR INT UPPER BEAM 860</td> <td>1.000</td> <td>PC</td> </tr> <tr> <td>CE1052A1</td> <td>CABLE CONNECTION CONTROL - USB MM 750m</td> <td>1.000</td> <td>PC</td> </tr> <tr> <td>CE1053B0</td> <td>MM MICROFIT LED BAR POWER SUPPLY CABL</td> <td>1.000</td> <td>PC</td> </tr> <tr> <td>CE1097A0</td> <td>4M SIHF 4 POLES MICROFIT CANBUS</td> <td>1.000</td> <td>PC</td> </tr> </tbody> </table>	Code	Description	Qty	UOM	OB1107A1	XEVC-0511-E LEFT INT DOOR COLUM	1.000	PC	OB1108B1	XEVC-0511 DOOR EXTERNAL RIGHT COLUM	1.000	PC	OB1109A1	XEVC-0511-E RIGHT INT DOOR COLUM	1.000	PC	OB1126B0	MM BT DOOR LOWER CROSS BAR	1.000	PC	OB1166A1	XEVC-0511-E EXT GLASS SUPPORT PROFILE	2.000	PC	OB1174A0	XEBC-04EU-E LEFT EXT DOOR COLUM	1.000	PC	OB1218B0	MM BT DOUBLE GLASS DOOR UPPER CROSS BAR	1.000	PC	OB1219A1	MM DOUBLE GLASS DOOR INT UPPER BEAM 860	1.000	PC	CE1052A1	CABLE CONNECTION CONTROL - USB MM 750m	1.000	PC	CE1053B0	MM MICROFIT LED BAR POWER SUPPLY CABL	1.000	PC	CE1097A0	4M SIHF 4 POLES MICROFIT CANBUS	1.000	PC
Code	Description	Qty	UOM																																															
OB1107A1	XEVC-0511-E LEFT INT DOOR COLUM	1.000	PC																																															
OB1108B1	XEVC-0511 DOOR EXTERNAL RIGHT COLUM	1.000	PC																																															
OB1109A1	XEVC-0511-E RIGHT INT DOOR COLUM	1.000	PC																																															
OB1126B0	MM BT DOOR LOWER CROSS BAR	1.000	PC																																															
OB1166A1	XEVC-0511-E EXT GLASS SUPPORT PROFILE	2.000	PC																																															
OB1174A0	XEBC-04EU-E LEFT EXT DOOR COLUM	1.000	PC																																															
OB1218B0	MM BT DOUBLE GLASS DOOR UPPER CROSS BAR	1.000	PC																																															
OB1219A1	MM DOUBLE GLASS DOOR INT UPPER BEAM 860	1.000	PC																																															
CE1052A1	CABLE CONNECTION CONTROL - USB MM 750m	1.000	PC																																															
CE1053B0	MM MICROFIT LED BAR POWER SUPPLY CABL	1.000	PC																																															
CE1097A0	4M SIHF 4 POLES MICROFIT CANBUS	1.000	PC																																															



COMPONENT			SPARE PART																																																																						
Code	Description	Image	Code	Description	Kit components																																																																				
OB1107A	XEVC-0511-E LEFT INT DOOR COLUMN		KDR1269B	BT-04 -M EXTERNAL RIGHT DOOR	<table border="1"> <thead> <tr> <th>Code</th> <th>Description</th> <th>Qty</th> <th>UOM</th> </tr> </thead> <tbody> <tr> <td>CE1285A0</td> <td>EMI ROUND FERRITE MOD.26438015 02</td> <td>2.000</td> <td>PC</td> </tr> <tr> <td>LP1019A0</td> <td>6 SERIES L200 LED LIGHT BAR - E415</td> <td>1.000</td> <td>PC</td> </tr> <tr> <td>LP1025A0</td> <td>L=415 LED LIGHT BAR COVER</td> <td>1.000</td> <td>PC</td> </tr> <tr> <td>MG1099A1</td> <td>MM COMPLETE HANDLE</td> <td>1.000</td> <td>PC</td> </tr> <tr> <td>RC1200A0</td> <td>ED=4 WIRE D.=0.5 COMPRESSIO N SPRING</td> <td>4.000</td> <td>PC</td> </tr> <tr> <td>SL1170A1</td> <td>S57 BLACK SILICON - 310ml CARTRIDGE</td> <td>35.000</td> <td>ML</td> </tr> <tr> <td>SL1222A0</td> <td>0511 EXTERNAL GLASS LATERAL SILICONE</td> <td>4.000</td> <td>PC</td> </tr> <tr> <td>SL1229A0</td> <td>BAKER EXTERNAL GLASS UPPER SILICONE</td> <td>1.000</td> <td>PC</td> </tr> <tr> <td>VE1030A1</td> <td>MAGNET FOR DOOR MICROSWITC H D=22,9mm</td> <td>2.000</td> <td>PC</td> </tr> <tr> <td>VI0239A1</td> <td>SELF-TAPPIN G SCREW 4.2X25 TCB+ INOX</td> <td>4.000</td> <td>PC</td> </tr> <tr> <td>VI1074A0</td> <td>4X16 SCREW FOR PLASTIC</td> <td>2.000</td> <td>PC</td> </tr> <tr> <td>VI1103A0</td> <td>40X12 TBSP SCREW FOR PLASTIC</td> <td>4.000</td> <td>PC</td> </tr> <tr> <td>VI1220A1</td> <td>4,2x12 TCB SELF-TAPPIN G SCREW</td> <td>28.000</td> <td>PC</td> </tr> <tr> <td>VI1930A1</td> <td>ST. STEEL 5X20 CHIP SCREW</td> <td>16.000</td> <td>PC</td> </tr> <tr> <td>VI1996A0</td> <td>M5x35 SCREW</td> <td>13.000</td> <td>PC</td> </tr> <tr> <td>VI2037A1</td> <td>40X8 TORX SHEETTRACS SELF-THREAD SCREW</td> <td>6.000</td> <td>PC</td> </tr> </tbody> </table>	Code	Description	Qty	UOM	CE1285A0	EMI ROUND FERRITE MOD.26438015 02	2.000	PC	LP1019A0	6 SERIES L200 LED LIGHT BAR - E415	1.000	PC	LP1025A0	L=415 LED LIGHT BAR COVER	1.000	PC	MG1099A1	MM COMPLETE HANDLE	1.000	PC	RC1200A0	ED=4 WIRE D.=0.5 COMPRESSIO N SPRING	4.000	PC	SL1170A1	S57 BLACK SILICON - 310ml CARTRIDGE	35.000	ML	SL1222A0	0511 EXTERNAL GLASS LATERAL SILICONE	4.000	PC	SL1229A0	BAKER EXTERNAL GLASS UPPER SILICONE	1.000	PC	VE1030A1	MAGNET FOR DOOR MICROSWITC H D=22,9mm	2.000	PC	VI0239A1	SELF-TAPPIN G SCREW 4.2X25 TCB+ INOX	4.000	PC	VI1074A0	4X16 SCREW FOR PLASTIC	2.000	PC	VI1103A0	40X12 TBSP SCREW FOR PLASTIC	4.000	PC	VI1220A1	4,2x12 TCB SELF-TAPPIN G SCREW	28.000	PC	VI1930A1	ST. STEEL 5X20 CHIP SCREW	16.000	PC	VI1996A0	M5x35 SCREW	13.000	PC	VI2037A1	40X8 TORX SHEETTRACS SELF-THREAD SCREW	6.000	PC
					Code	Description	Qty	UOM																																																																	
					CE1285A0	EMI ROUND FERRITE MOD.26438015 02	2.000	PC																																																																	
					LP1019A0	6 SERIES L200 LED LIGHT BAR - E415	1.000	PC																																																																	
					LP1025A0	L=415 LED LIGHT BAR COVER	1.000	PC																																																																	
					MG1099A1	MM COMPLETE HANDLE	1.000	PC																																																																	
					RC1200A0	ED=4 WIRE D.=0.5 COMPRESSIO N SPRING	4.000	PC																																																																	
					SL1170A1	S57 BLACK SILICON - 310ml CARTRIDGE	35.000	ML																																																																	
					SL1222A0	0511 EXTERNAL GLASS LATERAL SILICONE	4.000	PC																																																																	
					SL1229A0	BAKER EXTERNAL GLASS UPPER SILICONE	1.000	PC																																																																	
					VE1030A1	MAGNET FOR DOOR MICROSWITC H D=22,9mm	2.000	PC																																																																	
					VI0239A1	SELF-TAPPIN G SCREW 4.2X25 TCB+ INOX	4.000	PC																																																																	
					VI1074A0	4X16 SCREW FOR PLASTIC	2.000	PC																																																																	
					VI1103A0	40X12 TBSP SCREW FOR PLASTIC	4.000	PC																																																																	
					VI1220A1	4,2x12 TCB SELF-TAPPIN G SCREW	28.000	PC																																																																	
					VI1930A1	ST. STEEL 5X20 CHIP SCREW	16.000	PC																																																																	
					VI1996A0	M5x35 SCREW	13.000	PC																																																																	
VI2037A1	40X8 TORX SHEETTRACS SELF-THREAD SCREW	6.000	PC																																																																						



COMPONENT			SPARE PART																																																																														
Code	Description	Image	Code	Description	Kit components																																																																												
OB1107A	XEVC-0511-E LEFT INT DOOR COLUMN		KDR1269B	BT-04 -M EXTERNAL RIGHT DOOR	<table border="1"> <thead> <tr> <th>Code</th> <th>Description</th> <th>Qty</th> <th>UOM</th> </tr> </thead> <tbody> <tr> <td>VM1490A0</td> <td>CHEFTOP/BAK ERTOP HANDLE SCREWS COVER</td> <td>2.000</td> <td>PC</td> </tr> <tr> <td>VM1630A1</td> <td>INTERNAL GLASS PUSHING CAP</td> <td>3.000</td> <td>PC</td> </tr> <tr> <td>VM1631A0</td> <td>PLUS INNER GLASS PUSHING CAP</td> <td>3.000</td> <td>PC</td> </tr> <tr> <td>VM2259B0</td> <td>VM2259B0</td> <td>1.000</td> <td>PC</td> </tr> <tr> <td>VM2260B0</td> <td>S6 LEFT UPPER CAP</td> <td>1.000</td> <td>PC</td> </tr> <tr> <td>VM2261B0</td> <td>MM -M DOOR RIGHT LOWER CAP</td> <td>1.000</td> <td>PC</td> </tr> <tr> <td>VM2262B0</td> <td>MM -M DOOR RIGHT UPPER CAP</td> <td>1.000</td> <td>PC</td> </tr> <tr> <td>VM2267A0</td> <td>INTERNAL GLASS LOCKING SYSTEM SLIDER</td> <td>2.000</td> <td>PC</td> </tr> <tr> <td>VM2268A0</td> <td>DOOR MAGNET COVER</td> <td>2.000</td> <td>PC</td> </tr> <tr> <td>VM2269B0</td> <td>INNER GLASS FIXING CAP</td> <td>2.000</td> <td>PC</td> </tr> <tr> <td>VM2274A0</td> <td>GROOVED BUSHING</td> <td>1.000</td> <td>PC</td> </tr> <tr> <td>VM2275A0</td> <td>SMOOTH BUSHING</td> <td>1.000</td> <td>PC</td> </tr> <tr> <td>VM2285B0</td> <td>860 SERIES DRIP PROFILE KIT</td> <td>1.000</td> <td>PC</td> </tr> <tr> <td>VM2305A0</td> <td>6 SERIES DOOR CAP FIXING PAWL</td> <td>14.000</td> <td>PC</td> </tr> <tr> <td>VM2312A0</td> <td>6 S. DRIP PROFILE DRAIN LEFT PIPE</td> <td>1.000</td> <td>PC</td> </tr> <tr> <td>VM2314A0</td> <td>6 S. DRIP PROFILE CAP</td> <td>1.000</td> <td>PC</td> </tr> <tr> <td>VM2315B0</td> <td>S6 INTERNAL GLASS SUPPORT</td> <td>3.000</td> <td>PC</td> </tr> <tr> <td>VM2505B1</td> <td>MM PLUS INTERNAL GLASS SUPPORT</td> <td>3.000</td> <td>PC</td> </tr> </tbody> </table>	Code	Description	Qty	UOM	VM1490A0	CHEFTOP/BAK ERTOP HANDLE SCREWS COVER	2.000	PC	VM1630A1	INTERNAL GLASS PUSHING CAP	3.000	PC	VM1631A0	PLUS INNER GLASS PUSHING CAP	3.000	PC	VM2259B0	VM2259B0	1.000	PC	VM2260B0	S6 LEFT UPPER CAP	1.000	PC	VM2261B0	MM -M DOOR RIGHT LOWER CAP	1.000	PC	VM2262B0	MM -M DOOR RIGHT UPPER CAP	1.000	PC	VM2267A0	INTERNAL GLASS LOCKING SYSTEM SLIDER	2.000	PC	VM2268A0	DOOR MAGNET COVER	2.000	PC	VM2269B0	INNER GLASS FIXING CAP	2.000	PC	VM2274A0	GROOVED BUSHING	1.000	PC	VM2275A0	SMOOTH BUSHING	1.000	PC	VM2285B0	860 SERIES DRIP PROFILE KIT	1.000	PC	VM2305A0	6 SERIES DOOR CAP FIXING PAWL	14.000	PC	VM2312A0	6 S. DRIP PROFILE DRAIN LEFT PIPE	1.000	PC	VM2314A0	6 S. DRIP PROFILE CAP	1.000	PC	VM2315B0	S6 INTERNAL GLASS SUPPORT	3.000	PC	VM2505B1	MM PLUS INTERNAL GLASS SUPPORT	3.000	PC
Code	Description	Qty	UOM																																																																														
VM1490A0	CHEFTOP/BAK ERTOP HANDLE SCREWS COVER	2.000	PC																																																																														
VM1630A1	INTERNAL GLASS PUSHING CAP	3.000	PC																																																																														
VM1631A0	PLUS INNER GLASS PUSHING CAP	3.000	PC																																																																														
VM2259B0	VM2259B0	1.000	PC																																																																														
VM2260B0	S6 LEFT UPPER CAP	1.000	PC																																																																														
VM2261B0	MM -M DOOR RIGHT LOWER CAP	1.000	PC																																																																														
VM2262B0	MM -M DOOR RIGHT UPPER CAP	1.000	PC																																																																														
VM2267A0	INTERNAL GLASS LOCKING SYSTEM SLIDER	2.000	PC																																																																														
VM2268A0	DOOR MAGNET COVER	2.000	PC																																																																														
VM2269B0	INNER GLASS FIXING CAP	2.000	PC																																																																														
VM2274A0	GROOVED BUSHING	1.000	PC																																																																														
VM2275A0	SMOOTH BUSHING	1.000	PC																																																																														
VM2285B0	860 SERIES DRIP PROFILE KIT	1.000	PC																																																																														
VM2305A0	6 SERIES DOOR CAP FIXING PAWL	14.000	PC																																																																														
VM2312A0	6 S. DRIP PROFILE DRAIN LEFT PIPE	1.000	PC																																																																														
VM2314A0	6 S. DRIP PROFILE CAP	1.000	PC																																																																														
VM2315B0	S6 INTERNAL GLASS SUPPORT	3.000	PC																																																																														
VM2505B1	MM PLUS INTERNAL GLASS SUPPORT	3.000	PC																																																																														



COMPONENT			SPARE PART																																							
Code	Description	Image	Code	Description	Kit components																																					
0B1107A	XEVC-0511-E LEFT INT DOOR COLUMN		KDR1269B	BT-04 -M EXTERNAL RIGHT DOOR	<table border="1"> <thead> <tr> <th>Code</th> <th>Description</th> <th>Qty</th> <th>UOM</th> </tr> </thead> <tbody> <tr> <td>VM2518A0</td> <td>BOARD COOLING FAN SUPPORT</td> <td>1.000</td> <td>PC</td> </tr> <tr> <td>VN1179A1</td> <td>CONTROL BOARD 40x40x20mm 12V COOLING FAN</td> <td>1.000</td> <td>PC</td> </tr> <tr> <td>VP1080A0</td> <td>UPPER HINGE CAP FOR LOWER INNER GLASS</td> <td>1.000</td> <td>PC</td> </tr> <tr> <td>VP1081A0</td> <td>UPPER HINGE CAP FOR UPPER INNER GLASS</td> <td>1.000</td> <td>PC</td> </tr> <tr> <td>VT1290A0</td> <td>EXTERNAL GLASS XEBC-04EU-E</td> <td>1.000</td> <td>PC</td> </tr> </tbody> </table>	Code	Description	Qty	UOM	VM2518A0	BOARD COOLING FAN SUPPORT	1.000	PC	VN1179A1	CONTROL BOARD 40x40x20mm 12V COOLING FAN	1.000	PC	VP1080A0	UPPER HINGE CAP FOR LOWER INNER GLASS	1.000	PC	VP1081A0	UPPER HINGE CAP FOR UPPER INNER GLASS	1.000	PC	VT1290A0	EXTERNAL GLASS XEBC-04EU-E	1.000	PC													
			Code	Description	Qty	UOM																																				
VM2518A0	BOARD COOLING FAN SUPPORT	1.000	PC																																							
VN1179A1	CONTROL BOARD 40x40x20mm 12V COOLING FAN	1.000	PC																																							
VP1080A0	UPPER HINGE CAP FOR LOWER INNER GLASS	1.000	PC																																							
VP1081A0	UPPER HINGE CAP FOR UPPER INNER GLASS	1.000	PC																																							
VT1290A0	EXTERNAL GLASS XEBC-04EU-E	1.000	PC																																							
KDR1269A	BT-04 EXTERNAL RIGHT DOOR	<table border="1"> <thead> <tr> <th>Code</th> <th>Description</th> <th>Qty</th> <th>UOM</th> </tr> </thead> <tbody> <tr> <td>0B1107A1</td> <td>XEVC-0511-E LEFT INT DOOR COLUMN</td> <td>1.000</td> <td>PC</td> </tr> <tr> <td>0B1108B1</td> <td>XEVC-0511 DOOR EXTERNAL RIGHT COLUMN</td> <td>1.000</td> <td>PC</td> </tr> <tr> <td>0B1109A1</td> <td>XEVC-0511-E RIGHT INT DOOR COLUMN</td> <td>1.000</td> <td>PC</td> </tr> <tr> <td>0B1126A1</td> <td>MM BT DOOR LOWER CROSS BAR</td> <td>1.000</td> <td>PC</td> </tr> <tr> <td>0B1166A1</td> <td>XEVC-0511-E EXT GLASS SUPPORT PROFILE</td> <td>2.000</td> <td>PC</td> </tr> <tr> <td>0B1174A0</td> <td>XEBC-04EU-E LEFT EXT DOOR COLUMN</td> <td>1.000</td> <td>PC</td> </tr> <tr> <td>0B1218A1</td> <td>MM BT DOUBLE GLASS DOOR UPPER CROSS BAR</td> <td>1.000</td> <td>PC</td> </tr> <tr> <td>0B1219A1</td> <td>MM DOUBLE GLASS DOOR INT UPPER BEAM 860</td> <td>1.000</td> <td>PC</td> </tr> <tr> <td>CE1052A1</td> <td>CABLE CONNECTION CONTROL - USB MM 750m</td> <td>1.000</td> <td>PC</td> </tr> </tbody> </table>	Code	Description	Qty	UOM	0B1107A1	XEVC-0511-E LEFT INT DOOR COLUMN	1.000	PC	0B1108B1	XEVC-0511 DOOR EXTERNAL RIGHT COLUMN	1.000	PC	0B1109A1	XEVC-0511-E RIGHT INT DOOR COLUMN	1.000	PC	0B1126A1	MM BT DOOR LOWER CROSS BAR	1.000	PC	0B1166A1	XEVC-0511-E EXT GLASS SUPPORT PROFILE	2.000	PC	0B1174A0	XEBC-04EU-E LEFT EXT DOOR COLUMN	1.000	PC	0B1218A1	MM BT DOUBLE GLASS DOOR UPPER CROSS BAR	1.000	PC	0B1219A1	MM DOUBLE GLASS DOOR INT UPPER BEAM 860	1.000	PC	CE1052A1	CABLE CONNECTION CONTROL - USB MM 750m	1.000	PC
Code	Description	Qty	UOM																																							
0B1107A1	XEVC-0511-E LEFT INT DOOR COLUMN	1.000	PC																																							
0B1108B1	XEVC-0511 DOOR EXTERNAL RIGHT COLUMN	1.000	PC																																							
0B1109A1	XEVC-0511-E RIGHT INT DOOR COLUMN	1.000	PC																																							
0B1126A1	MM BT DOOR LOWER CROSS BAR	1.000	PC																																							
0B1166A1	XEVC-0511-E EXT GLASS SUPPORT PROFILE	2.000	PC																																							
0B1174A0	XEBC-04EU-E LEFT EXT DOOR COLUMN	1.000	PC																																							
0B1218A1	MM BT DOUBLE GLASS DOOR UPPER CROSS BAR	1.000	PC																																							
0B1219A1	MM DOUBLE GLASS DOOR INT UPPER BEAM 860	1.000	PC																																							
CE1052A1	CABLE CONNECTION CONTROL - USB MM 750m	1.000	PC																																							



COMPONENT			SPARE PART																																																																						
Code	Description	Image	Code	Description	Kit components																																																																				
OB1107A	XEVC-0511-E LEFT INT DOOR COLUMN		KDR1269A	BT-04 EXTERNAL RIGHT DOOR	<table border="1"> <thead> <tr> <th>Code</th> <th>Description</th> <th>Qty</th> <th>UOM</th> </tr> </thead> <tbody> <tr> <td>CE1053B0</td> <td>MM MICROFIT LED BAR POWER SUPPLY CABL</td> <td>1.000</td> <td>PC</td> </tr> <tr> <td>CE1285A0</td> <td>EMI ROUND FERRITE MOD.26438015 02</td> <td>1.000</td> <td>PC</td> </tr> <tr> <td>CE1290A0</td> <td>EXTRACTABL E FEMALE TERMINAL CPF 5/4</td> <td>1.000</td> <td>PC</td> </tr> <tr> <td>CE1310A1</td> <td>POWER - CONTROL BOARD CONNECTING CABLE</td> <td>1.000</td> <td>PC</td> </tr> <tr> <td>LP1019A0</td> <td>6 SERIES L200 LED LIGHT BAR - E415</td> <td>1.000</td> <td>PC</td> </tr> <tr> <td>LP1025A0</td> <td>L=415 LED LIGHT BAR COVER</td> <td>1.000</td> <td>PC</td> </tr> <tr> <td>MG1083A2</td> <td>MM COMPLETE HANDLE</td> <td>1.000</td> <td>PC</td> </tr> <tr> <td>SL1170A1</td> <td>S57 BLACK SILICON - 310ml CARTRIDGE</td> <td>30.000</td> <td>ML</td> </tr> <tr> <td>VE1030A1</td> <td>MAGNET FOR DOOR MICROSWITC H D=22,9mm</td> <td>2.000</td> <td>PC</td> </tr> <tr> <td>VH1147A0</td> <td>5X25 STAINLESS STEEL SCREW</td> <td>16.000</td> <td>PC</td> </tr> <tr> <td>VH1220A1</td> <td>4,2x12 TCB SELF-TAPPIN G SCREW</td> <td>25.000</td> <td>PC</td> </tr> <tr> <td>VH1996A0</td> <td>M5x35 SCREW</td> <td>13.000</td> <td>PC</td> </tr> <tr> <td>VM1630A1</td> <td>INTERNAL GLASS PUSHING CAP</td> <td>3.000</td> <td>PC</td> </tr> <tr> <td>VM1631A0</td> <td>PLUS INNER GLASS PUSHING CAP</td> <td>2.000</td> <td>PC</td> </tr> <tr> <td>VM2259A1</td> <td>6 SERIES DOOR LOWER LEFT CAP</td> <td>1.000</td> <td>PC</td> </tr> <tr> <td>VM2260A1</td> <td>6 SERIES DOOR UPPER LEFT CAP</td> <td>1.000</td> <td>PC</td> </tr> </tbody> </table>	Code	Description	Qty	UOM	CE1053B0	MM MICROFIT LED BAR POWER SUPPLY CABL	1.000	PC	CE1285A0	EMI ROUND FERRITE MOD.26438015 02	1.000	PC	CE1290A0	EXTRACTABL E FEMALE TERMINAL CPF 5/4	1.000	PC	CE1310A1	POWER - CONTROL BOARD CONNECTING CABLE	1.000	PC	LP1019A0	6 SERIES L200 LED LIGHT BAR - E415	1.000	PC	LP1025A0	L=415 LED LIGHT BAR COVER	1.000	PC	MG1083A2	MM COMPLETE HANDLE	1.000	PC	SL1170A1	S57 BLACK SILICON - 310ml CARTRIDGE	30.000	ML	VE1030A1	MAGNET FOR DOOR MICROSWITC H D=22,9mm	2.000	PC	VH1147A0	5X25 STAINLESS STEEL SCREW	16.000	PC	VH1220A1	4,2x12 TCB SELF-TAPPIN G SCREW	25.000	PC	VH1996A0	M5x35 SCREW	13.000	PC	VM1630A1	INTERNAL GLASS PUSHING CAP	3.000	PC	VM1631A0	PLUS INNER GLASS PUSHING CAP	2.000	PC	VM2259A1	6 SERIES DOOR LOWER LEFT CAP	1.000	PC	VM2260A1	6 SERIES DOOR UPPER LEFT CAP	1.000	PC
Code	Description	Qty	UOM																																																																						
CE1053B0	MM MICROFIT LED BAR POWER SUPPLY CABL	1.000	PC																																																																						
CE1285A0	EMI ROUND FERRITE MOD.26438015 02	1.000	PC																																																																						
CE1290A0	EXTRACTABL E FEMALE TERMINAL CPF 5/4	1.000	PC																																																																						
CE1310A1	POWER - CONTROL BOARD CONNECTING CABLE	1.000	PC																																																																						
LP1019A0	6 SERIES L200 LED LIGHT BAR - E415	1.000	PC																																																																						
LP1025A0	L=415 LED LIGHT BAR COVER	1.000	PC																																																																						
MG1083A2	MM COMPLETE HANDLE	1.000	PC																																																																						
SL1170A1	S57 BLACK SILICON - 310ml CARTRIDGE	30.000	ML																																																																						
VE1030A1	MAGNET FOR DOOR MICROSWITC H D=22,9mm	2.000	PC																																																																						
VH1147A0	5X25 STAINLESS STEEL SCREW	16.000	PC																																																																						
VH1220A1	4,2x12 TCB SELF-TAPPIN G SCREW	25.000	PC																																																																						
VH1996A0	M5x35 SCREW	13.000	PC																																																																						
VM1630A1	INTERNAL GLASS PUSHING CAP	3.000	PC																																																																						
VM1631A0	PLUS INNER GLASS PUSHING CAP	2.000	PC																																																																						
VM2259A1	6 SERIES DOOR LOWER LEFT CAP	1.000	PC																																																																						
VM2260A1	6 SERIES DOOR UPPER LEFT CAP	1.000	PC																																																																						



COMPONENT			SPARE PART					
Code	Description	Image	Code	Description	Kit components			
OB1107A	XEVC-0511-E LEFT INT DOOR COLUMN		KDR1269A	BT-04 EXTERNAL RIGHT DOOR	Code	Description	Qty	UOM
					VM2261A1	MM DOOR LOWER RIGHT CAP	1.000	PC
					VM2262A1	MM DOOR UPPER RIGHT CAP	1.000	PC
					VM2267A0	INTERNAL GLASS LOCKING SYSTEM SLIDER	2.000	PC
					VM2268A0	DOOR MAGNET COVER	2.000	PC
					VM2269A0	INTERNAL GLASS LOCKING SYSTEM CAP	2.000	PC
					VM2274A0	GROOVED BUSHING	1.000	PC
					VM2275A0	SMOOTH BUSHING	1.000	PC
					VM2285A0	860 SERIES DRIP PROFILE	1.000	PC
					VM2305A0	6 SERIES DOOR CAP FIXING PAWL	14.000	PC
					VM2312A0	6 S. DRIP PROFILE DRAIN LEFT PIPE	1.000	PC
					VM2313A0	TUBE DX DISCHARGE DRIP MM	1.000	PC
					VM2314A0	6 S. DRIP PROFILE CAP	1.000	PC
					VM2315A0	MIND.Maps INTERNAL GLASS CAP SUPPORT	3.000	PC
					VM2505A0	MM PLUS INTERNAL GLASS SUPPORT	2.000	PC
					VM2518A0	BOARD COOLING FAN SUPPORT	1.000	PC
					VN1179A1	CONTROL BOARD 40x40x20mm 12V COOLING FAN	1.000	PC
VT1290A0	EXTERNAL GLASS XEBC-04EU-E	1.000	PC					



COMPONENT			SPARE PART																																																																		
Code	Description	Image	Code	Description	Kit components																																																																
0B1107A	XEVC-0511-E LEFT INT DOOR COLUMN		KDR1261B	0511 -M RIGHT EXTERNAL DOOR	<table border="1"> <thead> <tr> <th>Code</th> <th>Description</th> <th>Qty</th> <th>UOM</th> </tr> </thead> <tbody> <tr> <td>0B1106A0</td> <td>XEVC-0511-E DOOR EXTERNAL LEFT COLUMN</td> <td>1.000</td> <td>PC</td> </tr> <tr> <td>0B1107A1</td> <td>XEVC-0511-E LEFT INT DOOR COLUM</td> <td>1.000</td> <td>PC</td> </tr> <tr> <td>0B1108B1</td> <td>XEVC-0511 DOOR EXTERNAL RIGHT COLUM</td> <td>1.000</td> <td>PC</td> </tr> <tr> <td>0B1109A1</td> <td>XEVC-0511-E RIGHT INT DOOR COLUM</td> <td>1.000</td> <td>PC</td> </tr> <tr> <td>0B1122B0</td> <td>MM CT DOOR LOWER CROSS BAR</td> <td>1.000</td> <td>PC</td> </tr> <tr> <td>0B1166A1</td> <td>XEVC-0511-E EXT GLASS SUPPORT PROFILE</td> <td>2.000</td> <td>PC</td> </tr> <tr> <td>0B1216B0</td> <td>MM CT DOUBLE GLASS DOOR UPPER CROSS BAR</td> <td>1.000</td> <td>PC</td> </tr> <tr> <td>0B1217A1</td> <td>MM DOUBLE GLASS DOOR INT UPPER BEAM 750</td> <td>1.000</td> <td>PC</td> </tr> <tr> <td>CE1052A1</td> <td>CABLE CONNECTION CONTROL - USB MM 750m</td> <td>1.000</td> <td>PC</td> </tr> <tr> <td>CE1053B0</td> <td>MM MICROFIT LED BAR POWER SUPPLY CABL</td> <td>1.000</td> <td>PC</td> </tr> <tr> <td>CE1096A0</td> <td>4 POLES MICROFIT 3 M BUS CABLE</td> <td>1.000</td> <td>PC</td> </tr> <tr> <td>CE1285A0</td> <td>EMI ROUND FERRITE MOD.26438015 02</td> <td>2.000</td> <td>PC</td> </tr> <tr> <td>GN1525A0</td> <td>O-RING INT DIAM 9,5 THK 1 NBR 70</td> <td>1.000</td> <td>PC</td> </tr> <tr> <td>LP1019A0</td> <td>6 SERIES L200 LED LIGHT BAR - E415</td> <td>1.000</td> <td>PC</td> </tr> <tr> <td>LP1025A0</td> <td>L=415 LED LIGHT BAR COVER</td> <td>1.000</td> <td>PC</td> </tr> </tbody> </table>	Code	Description	Qty	UOM	0B1106A0	XEVC-0511-E DOOR EXTERNAL LEFT COLUMN	1.000	PC	0B1107A1	XEVC-0511-E LEFT INT DOOR COLUM	1.000	PC	0B1108B1	XEVC-0511 DOOR EXTERNAL RIGHT COLUM	1.000	PC	0B1109A1	XEVC-0511-E RIGHT INT DOOR COLUM	1.000	PC	0B1122B0	MM CT DOOR LOWER CROSS BAR	1.000	PC	0B1166A1	XEVC-0511-E EXT GLASS SUPPORT PROFILE	2.000	PC	0B1216B0	MM CT DOUBLE GLASS DOOR UPPER CROSS BAR	1.000	PC	0B1217A1	MM DOUBLE GLASS DOOR INT UPPER BEAM 750	1.000	PC	CE1052A1	CABLE CONNECTION CONTROL - USB MM 750m	1.000	PC	CE1053B0	MM MICROFIT LED BAR POWER SUPPLY CABL	1.000	PC	CE1096A0	4 POLES MICROFIT 3 M BUS CABLE	1.000	PC	CE1285A0	EMI ROUND FERRITE MOD.26438015 02	2.000	PC	GN1525A0	O-RING INT DIAM 9,5 THK 1 NBR 70	1.000	PC	LP1019A0	6 SERIES L200 LED LIGHT BAR - E415	1.000	PC	LP1025A0	L=415 LED LIGHT BAR COVER	1.000	PC
					Code	Description	Qty	UOM																																																													
					0B1106A0	XEVC-0511-E DOOR EXTERNAL LEFT COLUMN	1.000	PC																																																													
					0B1107A1	XEVC-0511-E LEFT INT DOOR COLUM	1.000	PC																																																													
					0B1108B1	XEVC-0511 DOOR EXTERNAL RIGHT COLUM	1.000	PC																																																													
					0B1109A1	XEVC-0511-E RIGHT INT DOOR COLUM	1.000	PC																																																													
					0B1122B0	MM CT DOOR LOWER CROSS BAR	1.000	PC																																																													
					0B1166A1	XEVC-0511-E EXT GLASS SUPPORT PROFILE	2.000	PC																																																													
					0B1216B0	MM CT DOUBLE GLASS DOOR UPPER CROSS BAR	1.000	PC																																																													
					0B1217A1	MM DOUBLE GLASS DOOR INT UPPER BEAM 750	1.000	PC																																																													
					CE1052A1	CABLE CONNECTION CONTROL - USB MM 750m	1.000	PC																																																													
					CE1053B0	MM MICROFIT LED BAR POWER SUPPLY CABL	1.000	PC																																																													
					CE1096A0	4 POLES MICROFIT 3 M BUS CABLE	1.000	PC																																																													
					CE1285A0	EMI ROUND FERRITE MOD.26438015 02	2.000	PC																																																													
GN1525A0	O-RING INT DIAM 9,5 THK 1 NBR 70	1.000	PC																																																																		
LP1019A0	6 SERIES L200 LED LIGHT BAR - E415	1.000	PC																																																																		
LP1025A0	L=415 LED LIGHT BAR COVER	1.000	PC																																																																		



COMPONENT			SPARE PART																																																																		
Code	Description	Image	Code	Description	Kit components																																																																
OB1107A	XEVC-0511-E LEFT INT DOOR COLUMN		KDR1261B	0511 -M RIGHT EXTERNAL DOOR	<table border="1"> <thead> <tr> <th>Code</th> <th>Description</th> <th>Qty</th> <th>UOM</th> </tr> </thead> <tbody> <tr> <td>MG1099A1</td> <td>MM COMPLETE HANDLE</td> <td>1.000</td> <td>PC</td> </tr> <tr> <td>RC1200A0</td> <td>ED=4 WIRE D.=0.5 COMPRESSIO N SPRING</td> <td>4.000</td> <td>PC</td> </tr> <tr> <td>SL1170A1</td> <td>S57 BLACK SILICON - 310ml CARTRIDGE</td> <td>30.000</td> <td>ML</td> </tr> <tr> <td>SL1221A0</td> <td>GN1/1 EXTERNAL GLASS UPPER SILICONE</td> <td>1.000</td> <td>PC</td> </tr> <tr> <td>SL1222A0</td> <td>0511 EXTERNAL GLASS LATERAL SILICONE</td> <td>4.000</td> <td>PC</td> </tr> <tr> <td>VE1030A1</td> <td>MAGNET FOR DOOR MICROSWITC H D=22,9mm</td> <td>2.000</td> <td>PC</td> </tr> <tr> <td>VI0239A1</td> <td>SELF-TAPPIN G SCREW 4,2X25 TCB+ INOX</td> <td>4.000</td> <td>PC</td> </tr> <tr> <td>VI1034A0</td> <td>STAINLESS STEEL WASHER 8,4x16x1</td> <td>1.000</td> <td>PC</td> </tr> <tr> <td>VI1074A0</td> <td>4X16 SCREW FOR PLASTIC</td> <td>2.000</td> <td>PC</td> </tr> <tr> <td>VI1103A0</td> <td>40X12 TBSP SCREW FOR PLASTIC</td> <td>2.000</td> <td>PC</td> </tr> <tr> <td>VI1220A1</td> <td>4,2x12 TCB SELF-TAPPIN G SCREW</td> <td>26.000</td> <td>PC</td> </tr> <tr> <td>VI1930A1</td> <td>ST. STEEL 5X20 CHIP SCREW</td> <td>16.000</td> <td>PC</td> </tr> <tr> <td>VI1996A0</td> <td>M5x35 SCREW</td> <td>13.000</td> <td>PC</td> </tr> <tr> <td>VI2037A1</td> <td>40X8 TORX SHEETTRACS SELF-THREAD SCREW</td> <td>6.000</td> <td>PC</td> </tr> <tr> <td>VM1490A0</td> <td>CHEFTOP/BAK ERTOP HANDLE SCREWS COVER</td> <td>2.000</td> <td>PC</td> </tr> </tbody> </table>	Code	Description	Qty	UOM	MG1099A1	MM COMPLETE HANDLE	1.000	PC	RC1200A0	ED=4 WIRE D.=0.5 COMPRESSIO N SPRING	4.000	PC	SL1170A1	S57 BLACK SILICON - 310ml CARTRIDGE	30.000	ML	SL1221A0	GN1/1 EXTERNAL GLASS UPPER SILICONE	1.000	PC	SL1222A0	0511 EXTERNAL GLASS LATERAL SILICONE	4.000	PC	VE1030A1	MAGNET FOR DOOR MICROSWITC H D=22,9mm	2.000	PC	VI0239A1	SELF-TAPPIN G SCREW 4,2X25 TCB+ INOX	4.000	PC	VI1034A0	STAINLESS STEEL WASHER 8,4x16x1	1.000	PC	VI1074A0	4X16 SCREW FOR PLASTIC	2.000	PC	VI1103A0	40X12 TBSP SCREW FOR PLASTIC	2.000	PC	VI1220A1	4,2x12 TCB SELF-TAPPIN G SCREW	26.000	PC	VI1930A1	ST. STEEL 5X20 CHIP SCREW	16.000	PC	VI1996A0	M5x35 SCREW	13.000	PC	VI2037A1	40X8 TORX SHEETTRACS SELF-THREAD SCREW	6.000	PC	VM1490A0	CHEFTOP/BAK ERTOP HANDLE SCREWS COVER	2.000	PC
Code	Description	Qty	UOM																																																																		
MG1099A1	MM COMPLETE HANDLE	1.000	PC																																																																		
RC1200A0	ED=4 WIRE D.=0.5 COMPRESSIO N SPRING	4.000	PC																																																																		
SL1170A1	S57 BLACK SILICON - 310ml CARTRIDGE	30.000	ML																																																																		
SL1221A0	GN1/1 EXTERNAL GLASS UPPER SILICONE	1.000	PC																																																																		
SL1222A0	0511 EXTERNAL GLASS LATERAL SILICONE	4.000	PC																																																																		
VE1030A1	MAGNET FOR DOOR MICROSWITC H D=22,9mm	2.000	PC																																																																		
VI0239A1	SELF-TAPPIN G SCREW 4,2X25 TCB+ INOX	4.000	PC																																																																		
VI1034A0	STAINLESS STEEL WASHER 8,4x16x1	1.000	PC																																																																		
VI1074A0	4X16 SCREW FOR PLASTIC	2.000	PC																																																																		
VI1103A0	40X12 TBSP SCREW FOR PLASTIC	2.000	PC																																																																		
VI1220A1	4,2x12 TCB SELF-TAPPIN G SCREW	26.000	PC																																																																		
VI1930A1	ST. STEEL 5X20 CHIP SCREW	16.000	PC																																																																		
VI1996A0	M5x35 SCREW	13.000	PC																																																																		
VI2037A1	40X8 TORX SHEETTRACS SELF-THREAD SCREW	6.000	PC																																																																		
VM1490A0	CHEFTOP/BAK ERTOP HANDLE SCREWS COVER	2.000	PC																																																																		



COMPONENT			SPARE PART																																																																															
Code	Description	Image	Code	Description	Kit components																																																																													
OB1107A	XEVC-0511-E LEFT INT DOOR COLUMN		KDR1261B	0511 -M RIGHT EXTERNAL DOOR	<table border="1"> <thead> <tr> <th>Code</th> <th>Description</th> <th>Qty</th> <th>UOM</th> </tr> </thead> <tbody> <tr> <td>VM1630A1</td> <td>INTERNAL GLASS PUSHING CAP</td> <td>3.000</td> <td>PC</td> </tr> <tr> <td>VM1631A0</td> <td>PLUS INNER GLASS PUSHING CAP</td> <td>3.000</td> <td>PC</td> </tr> <tr> <td>VM2259B0</td> <td>VM2259B0</td> <td>1.000</td> <td>PC</td> </tr> <tr> <td>VM2260B0</td> <td>S6 LEFT UPPER CAP</td> <td>1.000</td> <td>PC</td> </tr> <tr> <td>VM2261B0</td> <td>MM -M DOOR RIGHT LOWER CAP</td> <td>1.000</td> <td>PC</td> </tr> <tr> <td>VM2262B0</td> <td>MM -M DOOR RIGHT UPPER CAP</td> <td>1.000</td> <td>PC</td> </tr> <tr> <td>VM2267A0</td> <td>INTERNAL GLASS LOCKING SYSTEM SLIDER</td> <td>2.000</td> <td>PC</td> </tr> <tr> <td>VM2268A0</td> <td>DOOR MAGNET COVER</td> <td>2.000</td> <td>PC</td> </tr> <tr> <td>VM2269B0</td> <td>INNER GLASS FIXING CAP</td> <td>2.000</td> <td>PC</td> </tr> <tr> <td>VM2274A0</td> <td>GROOVED BUSHING</td> <td>1.000</td> <td>PC</td> </tr> <tr> <td>VM2275A0</td> <td>SMOOTH BUSHING</td> <td>1.000</td> <td>PC</td> </tr> <tr> <td>VM2284B0</td> <td>750 SERIES DRIP PROFILE KIT</td> <td>1.000</td> <td>PC</td> </tr> <tr> <td>VM2305A0</td> <td>6 SERIES DOOR CAP FIXING PAWL</td> <td>14.000</td> <td>PC</td> </tr> <tr> <td>VM2312A0</td> <td>6 S. DRIP PROFILE DRAIN LEFT PIPE</td> <td>1.000</td> <td>PC</td> </tr> <tr> <td>VM2314A0</td> <td>6 S. DRIP PROFILE CAP</td> <td>1.000</td> <td>PC</td> </tr> <tr> <td>VM2315B0</td> <td>S6 INTERNAL GLASS SUPPORT</td> <td>3.000</td> <td>PC</td> </tr> <tr> <td>VM2505B1</td> <td>MM PLUS INTERNAL GLASS SUPPORT</td> <td>3.000</td> <td>PC</td> </tr> <tr> <td>VP1080A0</td> <td>UPPER HINGE CAP FOR LOWER INNER GLASS</td> <td>1.000</td> <td>PC</td> </tr> </tbody> </table>	Code	Description	Qty	UOM	VM1630A1	INTERNAL GLASS PUSHING CAP	3.000	PC	VM1631A0	PLUS INNER GLASS PUSHING CAP	3.000	PC	VM2259B0	VM2259B0	1.000	PC	VM2260B0	S6 LEFT UPPER CAP	1.000	PC	VM2261B0	MM -M DOOR RIGHT LOWER CAP	1.000	PC	VM2262B0	MM -M DOOR RIGHT UPPER CAP	1.000	PC	VM2267A0	INTERNAL GLASS LOCKING SYSTEM SLIDER	2.000	PC	VM2268A0	DOOR MAGNET COVER	2.000	PC	VM2269B0	INNER GLASS FIXING CAP	2.000	PC	VM2274A0	GROOVED BUSHING	1.000	PC	VM2275A0	SMOOTH BUSHING	1.000	PC	VM2284B0	750 SERIES DRIP PROFILE KIT	1.000	PC	VM2305A0	6 SERIES DOOR CAP FIXING PAWL	14.000	PC	VM2312A0	6 S. DRIP PROFILE DRAIN LEFT PIPE	1.000	PC	VM2314A0	6 S. DRIP PROFILE CAP	1.000	PC	VM2315B0	S6 INTERNAL GLASS SUPPORT	3.000	PC	VM2505B1	MM PLUS INTERNAL GLASS SUPPORT	3.000	PC	VP1080A0	UPPER HINGE CAP FOR LOWER INNER GLASS	1.000	PC	
Code	Description	Qty	UOM																																																																															
VM1630A1	INTERNAL GLASS PUSHING CAP	3.000	PC																																																																															
VM1631A0	PLUS INNER GLASS PUSHING CAP	3.000	PC																																																																															
VM2259B0	VM2259B0	1.000	PC																																																																															
VM2260B0	S6 LEFT UPPER CAP	1.000	PC																																																																															
VM2261B0	MM -M DOOR RIGHT LOWER CAP	1.000	PC																																																																															
VM2262B0	MM -M DOOR RIGHT UPPER CAP	1.000	PC																																																																															
VM2267A0	INTERNAL GLASS LOCKING SYSTEM SLIDER	2.000	PC																																																																															
VM2268A0	DOOR MAGNET COVER	2.000	PC																																																																															
VM2269B0	INNER GLASS FIXING CAP	2.000	PC																																																																															
VM2274A0	GROOVED BUSHING	1.000	PC																																																																															
VM2275A0	SMOOTH BUSHING	1.000	PC																																																																															
VM2284B0	750 SERIES DRIP PROFILE KIT	1.000	PC																																																																															
VM2305A0	6 SERIES DOOR CAP FIXING PAWL	14.000	PC																																																																															
VM2312A0	6 S. DRIP PROFILE DRAIN LEFT PIPE	1.000	PC																																																																															
VM2314A0	6 S. DRIP PROFILE CAP	1.000	PC																																																																															
VM2315B0	S6 INTERNAL GLASS SUPPORT	3.000	PC																																																																															
VM2505B1	MM PLUS INTERNAL GLASS SUPPORT	3.000	PC																																																																															
VP1080A0	UPPER HINGE CAP FOR LOWER INNER GLASS	1.000	PC																																																																															



COMPONENT			SPARE PART																																																			
Code	Description	Image	Code	Description	Kit components																																																	
0B1107A	XEVC-0511-E LEFT INT DOOR COLUMN		KDR1261B	0511 -M RIGHT EXTERNAL DOOR	<table border="1"> <thead> <tr> <th>Code</th> <th>Description</th> <th>Qty</th> <th>UOM</th> </tr> </thead> <tbody> <tr> <td>VP1081A0</td> <td>UPPER HINGE CAP FOR UPPER INNER GLASS</td> <td>1.000</td> <td>PC</td> </tr> <tr> <td>VT1276A0</td> <td>XEVC-0511-E DOOR EXTERNAL GLASS</td> <td>1.000</td> <td>PC</td> </tr> </tbody> </table>	Code	Description	Qty	UOM	VP1081A0	UPPER HINGE CAP FOR UPPER INNER GLASS	1.000	PC	VT1276A0	XEVC-0511-E DOOR EXTERNAL GLASS	1.000	PC																																					
			Code	Description	Qty	UOM																																																
VP1081A0	UPPER HINGE CAP FOR UPPER INNER GLASS	1.000	PC																																																			
VT1276A0	XEVC-0511-E DOOR EXTERNAL GLASS	1.000	PC																																																			
KDR1261A	0511 RIGHT EXTERNAL DOOR	<table border="1"> <thead> <tr> <th>Code</th> <th>Description</th> <th>Qty</th> <th>UOM</th> </tr> </thead> <tbody> <tr> <td>0B1106A0</td> <td>XEVC-0511-E DOOR EXTERNAL LEFT COLUMN</td> <td>1.000</td> <td>PC</td> </tr> <tr> <td>0B1107A1</td> <td>XEVC-0511-E LEFT INT DOOR COLUM</td> <td>1.000</td> <td>PC</td> </tr> <tr> <td>0B1108B1</td> <td>XEVC-0511 DOOR EXTERNAL RIGHT COLUM</td> <td>1.000</td> <td>PC</td> </tr> <tr> <td>0B1109A1</td> <td>XEVC-0511-E RIGHT INT DOOR COLUM</td> <td>1.000</td> <td>PC</td> </tr> <tr> <td>0B1122A1</td> <td>750MM DOOR LOWER FRAME SHAPE</td> <td>1.000</td> <td>PC</td> </tr> <tr> <td>0B1166A1</td> <td>XEVC-0511-E EXT GLASS SUPPORT PROFILE</td> <td>2.000</td> <td>PC</td> </tr> <tr> <td>0B1216A1</td> <td>MM CT DOUBLE GLASS DOOR UPPER BEAM</td> <td>1.000</td> <td>PC</td> </tr> <tr> <td>0B1217A1</td> <td>MM DOUBLE GLASS DOOR INT UPPER BEAM 750</td> <td>1.000</td> <td>PC</td> </tr> <tr> <td>CE1052A1</td> <td>CABLE CONNECTION CONTROL - USB MM 750m</td> <td>1.000</td> <td>PC</td> </tr> <tr> <td>CE1053B0</td> <td>MM MICROFIT LED BAR POWER SUPPLY CABL</td> <td>1.000</td> <td>PC</td> </tr> <tr> <td>CE1275A0</td> <td>3M POWER - CONTROL CONNECTION CABLE</td> <td>1.000</td> <td>PC</td> </tr> <tr> <td>CE1285A0</td> <td>EMI ROUND FERRITE MOD.26438015 02</td> <td>1.000</td> <td>PC</td> </tr> </tbody> </table>	Code	Description	Qty	UOM	0B1106A0	XEVC-0511-E DOOR EXTERNAL LEFT COLUMN	1.000	PC	0B1107A1	XEVC-0511-E LEFT INT DOOR COLUM	1.000	PC	0B1108B1	XEVC-0511 DOOR EXTERNAL RIGHT COLUM	1.000	PC	0B1109A1	XEVC-0511-E RIGHT INT DOOR COLUM	1.000	PC	0B1122A1	750MM DOOR LOWER FRAME SHAPE	1.000	PC	0B1166A1	XEVC-0511-E EXT GLASS SUPPORT PROFILE	2.000	PC	0B1216A1	MM CT DOUBLE GLASS DOOR UPPER BEAM	1.000	PC	0B1217A1	MM DOUBLE GLASS DOOR INT UPPER BEAM 750	1.000	PC	CE1052A1	CABLE CONNECTION CONTROL - USB MM 750m	1.000	PC	CE1053B0	MM MICROFIT LED BAR POWER SUPPLY CABL	1.000	PC	CE1275A0	3M POWER - CONTROL CONNECTION CABLE	1.000	PC	CE1285A0	EMI ROUND FERRITE MOD.26438015 02	1.000	PC
Code	Description	Qty	UOM																																																			
0B1106A0	XEVC-0511-E DOOR EXTERNAL LEFT COLUMN	1.000	PC																																																			
0B1107A1	XEVC-0511-E LEFT INT DOOR COLUM	1.000	PC																																																			
0B1108B1	XEVC-0511 DOOR EXTERNAL RIGHT COLUM	1.000	PC																																																			
0B1109A1	XEVC-0511-E RIGHT INT DOOR COLUM	1.000	PC																																																			
0B1122A1	750MM DOOR LOWER FRAME SHAPE	1.000	PC																																																			
0B1166A1	XEVC-0511-E EXT GLASS SUPPORT PROFILE	2.000	PC																																																			
0B1216A1	MM CT DOUBLE GLASS DOOR UPPER BEAM	1.000	PC																																																			
0B1217A1	MM DOUBLE GLASS DOOR INT UPPER BEAM 750	1.000	PC																																																			
CE1052A1	CABLE CONNECTION CONTROL - USB MM 750m	1.000	PC																																																			
CE1053B0	MM MICROFIT LED BAR POWER SUPPLY CABL	1.000	PC																																																			
CE1275A0	3M POWER - CONTROL CONNECTION CABLE	1.000	PC																																																			
CE1285A0	EMI ROUND FERRITE MOD.26438015 02	1.000	PC																																																			



COMPONENT			SPARE PART																																																																										
Code	Description	Image	Code	Description	Kit components																																																																								
OB1107A	XEVC-0511-E LEFT INT DOOR COLUMN		KDR1261A	0511 RIGHT EXTERNAL DOOR	<table border="1"> <thead> <tr> <th>Code</th> <th>Description</th> <th>Qty</th> <th>UOM</th> </tr> </thead> <tbody> <tr> <td>CE1290A0</td> <td>EXTRACTABL E FEMALE TERMINAL CPF 5/4</td> <td>1.000</td> <td>PC</td> </tr> <tr> <td>GN1525A0</td> <td>O-RING INT DIAM 9,5 THK 1 NBR 70</td> <td>1.000</td> <td>PC</td> </tr> <tr> <td>LP1019A0</td> <td>6 SERIES L200 LED LIGHT BAR - E415</td> <td>1.000</td> <td>PC</td> </tr> <tr> <td>LP1025A0</td> <td>L=415 LED LIGHT BAR COVER</td> <td>1.000</td> <td>PC</td> </tr> <tr> <td>MG1083A2</td> <td>MM COMPLETE HANDLE</td> <td>1.000</td> <td>PC</td> </tr> <tr> <td>SL1170A1</td> <td>S57 BLACK SILICON - 310ml CARTRIDGE</td> <td>30.000</td> <td>ML</td> </tr> <tr> <td>VE1030A1</td> <td>MAGNET FOR DOOR MICROSWITC H D=22,9mm</td> <td>2.000</td> <td>PC</td> </tr> <tr> <td>VI1034A0</td> <td>STAINLESS STEEL WASHER 8,4x16x1</td> <td>1.000</td> <td>PC</td> </tr> <tr> <td>VI1147A0</td> <td>5X25 STAINLESS STEEL SCREW</td> <td>16.000</td> <td>PC</td> </tr> <tr> <td>VI1220A1</td> <td>4,2x12 TCB SELF-TAPPIN G SCREW</td> <td>25.000</td> <td>PC</td> </tr> <tr> <td>VI1996A0</td> <td>M5x35 SCREW</td> <td>13.000</td> <td>PC</td> </tr> <tr> <td>VM1630A1</td> <td>INTERNAL GLASS PUSHING CAP</td> <td>3.000</td> <td>PC</td> </tr> <tr> <td>VM1631A0</td> <td>PLUS INNER GLASS PUSHING CAP</td> <td>2.000</td> <td>PC</td> </tr> <tr> <td>VM2259A1</td> <td>6 SERIES DOOR LOWER LEFT CAP</td> <td>1.000</td> <td>PC</td> </tr> <tr> <td>VM2260A1</td> <td>6 SERIES DOOR UPPER LEFT CAP</td> <td>1.000</td> <td>PC</td> </tr> <tr> <td>VM2261A1</td> <td>MM DOOR LOWER RIGHT CAP</td> <td>1.000</td> <td>PC</td> </tr> <tr> <td>VM2262A1</td> <td>MM DOOR UPPER RIGHT CAP</td> <td>1.000</td> <td>PC</td> </tr> </tbody> </table>	Code	Description	Qty	UOM	CE1290A0	EXTRACTABL E FEMALE TERMINAL CPF 5/4	1.000	PC	GN1525A0	O-RING INT DIAM 9,5 THK 1 NBR 70	1.000	PC	LP1019A0	6 SERIES L200 LED LIGHT BAR - E415	1.000	PC	LP1025A0	L=415 LED LIGHT BAR COVER	1.000	PC	MG1083A2	MM COMPLETE HANDLE	1.000	PC	SL1170A1	S57 BLACK SILICON - 310ml CARTRIDGE	30.000	ML	VE1030A1	MAGNET FOR DOOR MICROSWITC H D=22,9mm	2.000	PC	VI1034A0	STAINLESS STEEL WASHER 8,4x16x1	1.000	PC	VI1147A0	5X25 STAINLESS STEEL SCREW	16.000	PC	VI1220A1	4,2x12 TCB SELF-TAPPIN G SCREW	25.000	PC	VI1996A0	M5x35 SCREW	13.000	PC	VM1630A1	INTERNAL GLASS PUSHING CAP	3.000	PC	VM1631A0	PLUS INNER GLASS PUSHING CAP	2.000	PC	VM2259A1	6 SERIES DOOR LOWER LEFT CAP	1.000	PC	VM2260A1	6 SERIES DOOR UPPER LEFT CAP	1.000	PC	VM2261A1	MM DOOR LOWER RIGHT CAP	1.000	PC	VM2262A1	MM DOOR UPPER RIGHT CAP	1.000	PC
					Code	Description	Qty	UOM																																																																					
					CE1290A0	EXTRACTABL E FEMALE TERMINAL CPF 5/4	1.000	PC																																																																					
					GN1525A0	O-RING INT DIAM 9,5 THK 1 NBR 70	1.000	PC																																																																					
					LP1019A0	6 SERIES L200 LED LIGHT BAR - E415	1.000	PC																																																																					
					LP1025A0	L=415 LED LIGHT BAR COVER	1.000	PC																																																																					
					MG1083A2	MM COMPLETE HANDLE	1.000	PC																																																																					
					SL1170A1	S57 BLACK SILICON - 310ml CARTRIDGE	30.000	ML																																																																					
					VE1030A1	MAGNET FOR DOOR MICROSWITC H D=22,9mm	2.000	PC																																																																					
					VI1034A0	STAINLESS STEEL WASHER 8,4x16x1	1.000	PC																																																																					
					VI1147A0	5X25 STAINLESS STEEL SCREW	16.000	PC																																																																					
					VI1220A1	4,2x12 TCB SELF-TAPPIN G SCREW	25.000	PC																																																																					
					VI1996A0	M5x35 SCREW	13.000	PC																																																																					
					VM1630A1	INTERNAL GLASS PUSHING CAP	3.000	PC																																																																					
					VM1631A0	PLUS INNER GLASS PUSHING CAP	2.000	PC																																																																					
					VM2259A1	6 SERIES DOOR LOWER LEFT CAP	1.000	PC																																																																					
					VM2260A1	6 SERIES DOOR UPPER LEFT CAP	1.000	PC																																																																					
VM2261A1	MM DOOR LOWER RIGHT CAP	1.000	PC																																																																										
VM2262A1	MM DOOR UPPER RIGHT CAP	1.000	PC																																																																										



COMPONENT			SPARE PART																																																														
Code	Description	Image	Code	Description	Kit components																																																												
OB1107A	XEVC-0511-E LEFT INT DOOR COLUMN		KDR1261A	0511 RIGHT EXTERNAL DOOR	<table border="1"> <thead> <tr> <th>Code</th> <th>Description</th> <th>Qty</th> <th>UOM</th> </tr> </thead> <tbody> <tr> <td>VM2267A0</td> <td>INTERNAL GLASS LOCKING SYSTEM SLIDER</td> <td>2.000</td> <td>PC</td> </tr> <tr> <td>VM2268A0</td> <td>DOOR MAGNET COVER</td> <td>2.000</td> <td>PC</td> </tr> <tr> <td>VM2269A0</td> <td>INTERNAL GLASS LOCKING SYSTEM CAP</td> <td>2.000</td> <td>PC</td> </tr> <tr> <td>VM2274A0</td> <td>GROOVED BUSHING</td> <td>1.000</td> <td>PC</td> </tr> <tr> <td>VM2275A0</td> <td>SMOOTH BUSHING</td> <td>1.000</td> <td>PC</td> </tr> <tr> <td>VM2284A0</td> <td>750 SERIES DRIP PROFILE</td> <td>1.000</td> <td>PC</td> </tr> <tr> <td>VM2305A0</td> <td>6 SERIES DOOR CAP FIXING PAWL</td> <td>14.000</td> <td>PC</td> </tr> <tr> <td>VM2312A0</td> <td>6 S. DRIP PROFILE DRAIN LEFT PIPE</td> <td>1.000</td> <td>PC</td> </tr> <tr> <td>VM2314A0</td> <td>6 S. DRIP PROFILE CAP</td> <td>1.000</td> <td>PC</td> </tr> <tr> <td>VM2315A0</td> <td>MIND.Maps INTERNAL GLASS CAP SUPPORT</td> <td>3.000</td> <td>PC</td> </tr> <tr> <td>VM2505A0</td> <td>MM PLUS INTERNAL GLASS SUPPORT</td> <td>2.000</td> <td>PC</td> </tr> <tr> <td>VM2518A0</td> <td>BOARD COOLING FAN SUPPORT</td> <td>1.000</td> <td>PC</td> </tr> <tr> <td>VN1179A1</td> <td>CONTROL BOARD 40x40x20mm 12V COOLING FAN</td> <td>1.000</td> <td>PC</td> </tr> <tr> <td>VT1276A0</td> <td>XEVC-0511-E DOOR EXTERNAL GLASS</td> <td>1.000</td> <td>PC</td> </tr> </tbody> </table>	Code	Description	Qty	UOM	VM2267A0	INTERNAL GLASS LOCKING SYSTEM SLIDER	2.000	PC	VM2268A0	DOOR MAGNET COVER	2.000	PC	VM2269A0	INTERNAL GLASS LOCKING SYSTEM CAP	2.000	PC	VM2274A0	GROOVED BUSHING	1.000	PC	VM2275A0	SMOOTH BUSHING	1.000	PC	VM2284A0	750 SERIES DRIP PROFILE	1.000	PC	VM2305A0	6 SERIES DOOR CAP FIXING PAWL	14.000	PC	VM2312A0	6 S. DRIP PROFILE DRAIN LEFT PIPE	1.000	PC	VM2314A0	6 S. DRIP PROFILE CAP	1.000	PC	VM2315A0	MIND.Maps INTERNAL GLASS CAP SUPPORT	3.000	PC	VM2505A0	MM PLUS INTERNAL GLASS SUPPORT	2.000	PC	VM2518A0	BOARD COOLING FAN SUPPORT	1.000	PC	VN1179A1	CONTROL BOARD 40x40x20mm 12V COOLING FAN	1.000	PC	VT1276A0	XEVC-0511-E DOOR EXTERNAL GLASS	1.000	PC
Code	Description	Qty	UOM																																																														
VM2267A0	INTERNAL GLASS LOCKING SYSTEM SLIDER	2.000	PC																																																														
VM2268A0	DOOR MAGNET COVER	2.000	PC																																																														
VM2269A0	INTERNAL GLASS LOCKING SYSTEM CAP	2.000	PC																																																														
VM2274A0	GROOVED BUSHING	1.000	PC																																																														
VM2275A0	SMOOTH BUSHING	1.000	PC																																																														
VM2284A0	750 SERIES DRIP PROFILE	1.000	PC																																																														
VM2305A0	6 SERIES DOOR CAP FIXING PAWL	14.000	PC																																																														
VM2312A0	6 S. DRIP PROFILE DRAIN LEFT PIPE	1.000	PC																																																														
VM2314A0	6 S. DRIP PROFILE CAP	1.000	PC																																																														
VM2315A0	MIND.Maps INTERNAL GLASS CAP SUPPORT	3.000	PC																																																														
VM2505A0	MM PLUS INTERNAL GLASS SUPPORT	2.000	PC																																																														
VM2518A0	BOARD COOLING FAN SUPPORT	1.000	PC																																																														
VN1179A1	CONTROL BOARD 40x40x20mm 12V COOLING FAN	1.000	PC																																																														
VT1276A0	XEVC-0511-E DOOR EXTERNAL GLASS	1.000	PC																																																														



COMPONENT			SPARE PART					
Code	Description	Image	Code	Description	Kit components			
0B1108B	XEVC-0511 DOOR EXTERNAL RIGHT COLUMN		KDR1325A	0511 ZERO RIGHT -M EXTERNAL DOOR	Code	Description	Qty	UOM
					0B1106A0	XEVC-0511-E DOOR EXTERNAL LEFT COLUMN	1.000	PC
					0B1107A1	XEVC-0511-E LEFT INT DOOR COLUM	1.000	PC
					0B1108B1	XEVC-0511 DOOR EXTERNAL RIGHT COLUM	1.000	PC
					0B1109A1	XEVC-0511-E RIGHT INT DOOR COLUM	1.000	PC
					0B1122B0	MM CT DOOR LOWER CROSS BAR	1.000	PC
					0B1166A1	XEVC-0511-E EXT GLASS SUPPORT PROFILE	2.000	PC
					0B1216B0	MM CT DOUBLE GLASS DOOR UPPER CROSS BAR	1.000	PC
					0B1217A1	MM DOUBLE GLASS DOOR INT UPPER BEAM 750	1.000	PC
					0H2892A0	LED BAR UPPER CAP PLATE	1.000	PC
					0H2893A0	LED BAR LOWER CAP PLATE	1.000	PC
					CE1096A0	4 POLES MICROFIT 3 M BUS CABLE	1.000	PC
					CE1285A0	EMI ROUND FERRITE MOD.26438015 02	2.000	PC
					CE1851A0	MICROFIT CABLE 2P M-F-F AWG22	1.000	PC
					CE2001A0	MICROFIT CABLE 2PM-100-2PM 2AWG22	1.000	PC
CE2002A0	MICROFIT CABLE 2PM-100-AMP MODU2 2AWG22	1.000	PC					



COMPONENT			SPARE PART																																																																						
Code	Description	Image	Code	Description	Kit components																																																																				
0B1108B	XEVC-0511 DOOR EXTERNAL RIGHT COLUMN		KDR1325A	0511 ZERO RIGHT -M EXTERNAL DOOR	<table border="1"> <thead> <tr> <th>Code</th> <th>Description</th> <th>Qty</th> <th>UOM</th> </tr> </thead> <tbody> <tr> <td>GN1525A0</td> <td>O-RING INT DIAM 9,5 THK 1 NBR 70</td> <td>1.000</td> <td>PC</td> </tr> <tr> <td>LP1019A0</td> <td>6 SERIES L200 LED LIGHT BAR - E415</td> <td>1.000</td> <td>PC</td> </tr> <tr> <td>MG1099A1</td> <td>MM COMPLETE HANDLE</td> <td>1.000</td> <td>PC</td> </tr> <tr> <td>RC1200A0</td> <td>ED=4 WIRE D.=0.5 COMPRESSIO N SPRING</td> <td>4.000</td> <td>PC</td> </tr> <tr> <td>SL1170A1</td> <td>S57 BLACK SILICON - 310ml CARTRIDGE</td> <td>30.000</td> <td>ML</td> </tr> <tr> <td>SL1221A0</td> <td>GN1/1 EXTERNAL GLASS UPPER SILICONE</td> <td>1.000</td> <td>PC</td> </tr> <tr> <td>SL1222A0</td> <td>0511 EXTERNAL GLASS LATERAL SILICONE</td> <td>4.000</td> <td>PC</td> </tr> <tr> <td>VE1030A1</td> <td>MAGNET FOR DOOR MICROSWITC H D=22,9mm</td> <td>2.000</td> <td>PC</td> </tr> <tr> <td>VI0239A1</td> <td>SELF-TAPPIN G SCREW 4.2X25 TCB+ INOX</td> <td>4.000</td> <td>PC</td> </tr> <tr> <td>VI1034A0</td> <td>STAINLESS STEEL WASHER 8.4x16x1</td> <td>1.000</td> <td>PC</td> </tr> <tr> <td>VI1074A0</td> <td>4X16 SCREW FOR PLASTIC</td> <td>2.000</td> <td>PC</td> </tr> <tr> <td>VI1103A0</td> <td>40X12 TBSP SCREW FOR PLASTIC</td> <td>2.000</td> <td>PC</td> </tr> <tr> <td>VI1220A1</td> <td>4,2x12 TCB SELF-TAPPIN G SCREW</td> <td>26.000</td> <td>PC</td> </tr> <tr> <td>VI1930A1</td> <td>ST. STEEL 5X20 CHIP SCREW</td> <td>16.000</td> <td>PC</td> </tr> <tr> <td>VI1996A0</td> <td>M5x35 SCREW</td> <td>13.000</td> <td>PC</td> </tr> <tr> <td>VI2037A1</td> <td>40X8 TORX SHEETTRACS SELF-THREAD SCREW</td> <td>6.000</td> <td>PC</td> </tr> </tbody> </table>	Code	Description	Qty	UOM	GN1525A0	O-RING INT DIAM 9,5 THK 1 NBR 70	1.000	PC	LP1019A0	6 SERIES L200 LED LIGHT BAR - E415	1.000	PC	MG1099A1	MM COMPLETE HANDLE	1.000	PC	RC1200A0	ED=4 WIRE D.=0.5 COMPRESSIO N SPRING	4.000	PC	SL1170A1	S57 BLACK SILICON - 310ml CARTRIDGE	30.000	ML	SL1221A0	GN1/1 EXTERNAL GLASS UPPER SILICONE	1.000	PC	SL1222A0	0511 EXTERNAL GLASS LATERAL SILICONE	4.000	PC	VE1030A1	MAGNET FOR DOOR MICROSWITC H D=22,9mm	2.000	PC	VI0239A1	SELF-TAPPIN G SCREW 4.2X25 TCB+ INOX	4.000	PC	VI1034A0	STAINLESS STEEL WASHER 8.4x16x1	1.000	PC	VI1074A0	4X16 SCREW FOR PLASTIC	2.000	PC	VI1103A0	40X12 TBSP SCREW FOR PLASTIC	2.000	PC	VI1220A1	4,2x12 TCB SELF-TAPPIN G SCREW	26.000	PC	VI1930A1	ST. STEEL 5X20 CHIP SCREW	16.000	PC	VI1996A0	M5x35 SCREW	13.000	PC	VI2037A1	40X8 TORX SHEETTRACS SELF-THREAD SCREW	6.000	PC
					Code	Description	Qty	UOM																																																																	
					GN1525A0	O-RING INT DIAM 9,5 THK 1 NBR 70	1.000	PC																																																																	
					LP1019A0	6 SERIES L200 LED LIGHT BAR - E415	1.000	PC																																																																	
					MG1099A1	MM COMPLETE HANDLE	1.000	PC																																																																	
					RC1200A0	ED=4 WIRE D.=0.5 COMPRESSIO N SPRING	4.000	PC																																																																	
					SL1170A1	S57 BLACK SILICON - 310ml CARTRIDGE	30.000	ML																																																																	
					SL1221A0	GN1/1 EXTERNAL GLASS UPPER SILICONE	1.000	PC																																																																	
					SL1222A0	0511 EXTERNAL GLASS LATERAL SILICONE	4.000	PC																																																																	
					VE1030A1	MAGNET FOR DOOR MICROSWITC H D=22,9mm	2.000	PC																																																																	
					VI0239A1	SELF-TAPPIN G SCREW 4.2X25 TCB+ INOX	4.000	PC																																																																	
					VI1034A0	STAINLESS STEEL WASHER 8.4x16x1	1.000	PC																																																																	
					VI1074A0	4X16 SCREW FOR PLASTIC	2.000	PC																																																																	
					VI1103A0	40X12 TBSP SCREW FOR PLASTIC	2.000	PC																																																																	
					VI1220A1	4,2x12 TCB SELF-TAPPIN G SCREW	26.000	PC																																																																	
					VI1930A1	ST. STEEL 5X20 CHIP SCREW	16.000	PC																																																																	
					VI1996A0	M5x35 SCREW	13.000	PC																																																																	
VI2037A1	40X8 TORX SHEETTRACS SELF-THREAD SCREW	6.000	PC																																																																						



COMPONENT			SPARE PART																																																																														
Code	Description	Image	Code	Description	Kit components																																																																												
OB1108B	XEVC-0511 DOOR EXTERNAL RIGHT COLUMN		KDR1325A	0511 ZERO RIGHT -M EXTERNAL DOOR	<table border="1"> <thead> <tr> <th>Code</th> <th>Description</th> <th>Qty</th> <th>UOM</th> </tr> </thead> <tbody> <tr> <td>VM1490A0</td> <td>CHEFTOP/BAK ERTOP HANDLE SCREWS COVER</td> <td>2.000</td> <td>PC</td> </tr> <tr> <td>VM1630A1</td> <td>INTERNAL GLASS PUSHING CAP</td> <td>3.000</td> <td>PC</td> </tr> <tr> <td>VM1631A0</td> <td>PLUS INNER GLASS PUSHING CAP</td> <td>3.000</td> <td>PC</td> </tr> <tr> <td>VM2259B0</td> <td>VM2259B0</td> <td>1.000</td> <td>PC</td> </tr> <tr> <td>VM2260B0</td> <td>S6 LEFT UPPER CAP</td> <td>1.000</td> <td>PC</td> </tr> <tr> <td>VM2261B0</td> <td>MM -M DOOR RIGHT LOWER CAP</td> <td>1.000</td> <td>PC</td> </tr> <tr> <td>VM2262B0</td> <td>MM -M DOOR RIGHT UPPER CAP</td> <td>1.000</td> <td>PC</td> </tr> <tr> <td>VM2267A0</td> <td>INTERNAL GLASS LOCKING SYSTEM SLIDER</td> <td>2.000</td> <td>PC</td> </tr> <tr> <td>VM2268A0</td> <td>DOOR MAGNET COVER</td> <td>2.000</td> <td>PC</td> </tr> <tr> <td>VM2269B0</td> <td>INNER GLASS FIXING CAP</td> <td>2.000</td> <td>PC</td> </tr> <tr> <td>VM2274A0</td> <td>GROOVED BUSHING</td> <td>1.000</td> <td>PC</td> </tr> <tr> <td>VM2275A0</td> <td>SMOOTH BUSHING</td> <td>1.000</td> <td>PC</td> </tr> <tr> <td>VM2284B0</td> <td>750 SERIES DRIP PROFILE KIT</td> <td>1.000</td> <td>PC</td> </tr> <tr> <td>VM2305A0</td> <td>6 SERIES DOOR CAP FIXING PAWL</td> <td>14.000</td> <td>PC</td> </tr> <tr> <td>VM2312A0</td> <td>6 S. DRIP PROFILE DRAIN LEFT PIPE</td> <td>1.000</td> <td>PC</td> </tr> <tr> <td>VM2314A0</td> <td>6 S. DRIP PROFILE CAP</td> <td>1.000</td> <td>PC</td> </tr> <tr> <td>VM2315B0</td> <td>S6 INTERNAL GLASS SUPPORT</td> <td>3.000</td> <td>PC</td> </tr> <tr> <td>VM2505B1</td> <td>MM PLUS INTERNAL GLASS SUPPORT</td> <td>3.000</td> <td>PC</td> </tr> </tbody> </table>	Code	Description	Qty	UOM	VM1490A0	CHEFTOP/BAK ERTOP HANDLE SCREWS COVER	2.000	PC	VM1630A1	INTERNAL GLASS PUSHING CAP	3.000	PC	VM1631A0	PLUS INNER GLASS PUSHING CAP	3.000	PC	VM2259B0	VM2259B0	1.000	PC	VM2260B0	S6 LEFT UPPER CAP	1.000	PC	VM2261B0	MM -M DOOR RIGHT LOWER CAP	1.000	PC	VM2262B0	MM -M DOOR RIGHT UPPER CAP	1.000	PC	VM2267A0	INTERNAL GLASS LOCKING SYSTEM SLIDER	2.000	PC	VM2268A0	DOOR MAGNET COVER	2.000	PC	VM2269B0	INNER GLASS FIXING CAP	2.000	PC	VM2274A0	GROOVED BUSHING	1.000	PC	VM2275A0	SMOOTH BUSHING	1.000	PC	VM2284B0	750 SERIES DRIP PROFILE KIT	1.000	PC	VM2305A0	6 SERIES DOOR CAP FIXING PAWL	14.000	PC	VM2312A0	6 S. DRIP PROFILE DRAIN LEFT PIPE	1.000	PC	VM2314A0	6 S. DRIP PROFILE CAP	1.000	PC	VM2315B0	S6 INTERNAL GLASS SUPPORT	3.000	PC	VM2505B1	MM PLUS INTERNAL GLASS SUPPORT	3.000	PC
Code	Description	Qty	UOM																																																																														
VM1490A0	CHEFTOP/BAK ERTOP HANDLE SCREWS COVER	2.000	PC																																																																														
VM1630A1	INTERNAL GLASS PUSHING CAP	3.000	PC																																																																														
VM1631A0	PLUS INNER GLASS PUSHING CAP	3.000	PC																																																																														
VM2259B0	VM2259B0	1.000	PC																																																																														
VM2260B0	S6 LEFT UPPER CAP	1.000	PC																																																																														
VM2261B0	MM -M DOOR RIGHT LOWER CAP	1.000	PC																																																																														
VM2262B0	MM -M DOOR RIGHT UPPER CAP	1.000	PC																																																																														
VM2267A0	INTERNAL GLASS LOCKING SYSTEM SLIDER	2.000	PC																																																																														
VM2268A0	DOOR MAGNET COVER	2.000	PC																																																																														
VM2269B0	INNER GLASS FIXING CAP	2.000	PC																																																																														
VM2274A0	GROOVED BUSHING	1.000	PC																																																																														
VM2275A0	SMOOTH BUSHING	1.000	PC																																																																														
VM2284B0	750 SERIES DRIP PROFILE KIT	1.000	PC																																																																														
VM2305A0	6 SERIES DOOR CAP FIXING PAWL	14.000	PC																																																																														
VM2312A0	6 S. DRIP PROFILE DRAIN LEFT PIPE	1.000	PC																																																																														
VM2314A0	6 S. DRIP PROFILE CAP	1.000	PC																																																																														
VM2315B0	S6 INTERNAL GLASS SUPPORT	3.000	PC																																																																														
VM2505B1	MM PLUS INTERNAL GLASS SUPPORT	3.000	PC																																																																														



COMPONENT			SPARE PART																																															
Code	Description	Image	Code	Description	Kit components																																													
OB1108B	XEVC-0511 DOOR EXTERNAL RIGHT COLUMN		KDR1325A	0511 ZERO RIGHT -M EXTERNAL DOOR	<table border="1"> <thead> <tr> <th>Code</th> <th>Description</th> <th>Qty</th> <th>UOM</th> </tr> </thead> <tbody> <tr> <td>VP1080A0</td> <td>UPPER HINGE CAP FOR LOWER INNER GLASS</td> <td>1.000</td> <td>PC</td> </tr> <tr> <td>VP1081A0</td> <td>UPPER HINGE CAP FOR UPPER INNER GLASS</td> <td>1.000</td> <td>PC</td> </tr> <tr> <td>VT1276A0</td> <td>XEVC-0511-E DOOR EXTERNAL GLASS</td> <td>1.000</td> <td>PC</td> </tr> </tbody> </table>	Code	Description	Qty	UOM	VP1080A0	UPPER HINGE CAP FOR LOWER INNER GLASS	1.000	PC	VP1081A0	UPPER HINGE CAP FOR UPPER INNER GLASS	1.000	PC	VT1276A0	XEVC-0511-E DOOR EXTERNAL GLASS	1.000	PC																													
			Code	Description	Qty	UOM																																												
VP1080A0	UPPER HINGE CAP FOR LOWER INNER GLASS	1.000	PC																																															
VP1081A0	UPPER HINGE CAP FOR UPPER INNER GLASS	1.000	PC																																															
VT1276A0	XEVC-0511-E DOOR EXTERNAL GLASS	1.000	PC																																															
KDR1269B	BT-04 -M EXTERNAL RIGHT DOOR	<table border="1"> <thead> <tr> <th>Code</th> <th>Description</th> <th>Qty</th> <th>UOM</th> </tr> </thead> <tbody> <tr> <td>OB1107A1</td> <td>XEVC-0511-E LEFT INT DOOR COLUM</td> <td>1.000</td> <td>PC</td> </tr> <tr> <td>OB1108B1</td> <td>XEVC-0511 DOOR EXTERNAL RIGHT COLUM</td> <td>1.000</td> <td>PC</td> </tr> <tr> <td>OB1109A1</td> <td>XEVC-0511-E RIGHT INT DOOR COLUM</td> <td>1.000</td> <td>PC</td> </tr> <tr> <td>OB1126B0</td> <td>MM BT DOOR LOWER CROSS BAR</td> <td>1.000</td> <td>PC</td> </tr> <tr> <td>OB1166A1</td> <td>XEVC-0511-E EXT GLASS SUPPORT PROFILE</td> <td>2.000</td> <td>PC</td> </tr> <tr> <td>OB1174A0</td> <td>XEBC-04EU-E LEFT EXT DOOR COLUM</td> <td>1.000</td> <td>PC</td> </tr> <tr> <td>OB1218B0</td> <td>MM BT DOUBLE GLASS DOOR UPPER CROSS BAR</td> <td>1.000</td> <td>PC</td> </tr> <tr> <td>OB1219A1</td> <td>MM DOUBLE GLASS DOOR INT UPPER BEAM 860</td> <td>1.000</td> <td>PC</td> </tr> <tr> <td>CE1052A1</td> <td>CABLE CONNECTION CONTROL - USB MM 750m</td> <td>1.000</td> <td>PC</td> </tr> <tr> <td>CE1053B0</td> <td>MM MICROFIT LED BAR POWER SUPPLY CABL</td> <td>1.000</td> <td>PC</td> </tr> <tr> <td>CE1097A0</td> <td>4M SIHF 4 POLES MICROFIT CANBUS</td> <td>1.000</td> <td>PC</td> </tr> </tbody> </table>	Code	Description	Qty	UOM	OB1107A1	XEVC-0511-E LEFT INT DOOR COLUM	1.000	PC	OB1108B1	XEVC-0511 DOOR EXTERNAL RIGHT COLUM	1.000	PC	OB1109A1	XEVC-0511-E RIGHT INT DOOR COLUM	1.000	PC	OB1126B0	MM BT DOOR LOWER CROSS BAR	1.000	PC	OB1166A1	XEVC-0511-E EXT GLASS SUPPORT PROFILE	2.000	PC	OB1174A0	XEBC-04EU-E LEFT EXT DOOR COLUM	1.000	PC	OB1218B0	MM BT DOUBLE GLASS DOOR UPPER CROSS BAR	1.000	PC	OB1219A1	MM DOUBLE GLASS DOOR INT UPPER BEAM 860	1.000	PC	CE1052A1	CABLE CONNECTION CONTROL - USB MM 750m	1.000	PC	CE1053B0	MM MICROFIT LED BAR POWER SUPPLY CABL	1.000	PC	CE1097A0	4M SIHF 4 POLES MICROFIT CANBUS	1.000	PC
Code	Description	Qty	UOM																																															
OB1107A1	XEVC-0511-E LEFT INT DOOR COLUM	1.000	PC																																															
OB1108B1	XEVC-0511 DOOR EXTERNAL RIGHT COLUM	1.000	PC																																															
OB1109A1	XEVC-0511-E RIGHT INT DOOR COLUM	1.000	PC																																															
OB1126B0	MM BT DOOR LOWER CROSS BAR	1.000	PC																																															
OB1166A1	XEVC-0511-E EXT GLASS SUPPORT PROFILE	2.000	PC																																															
OB1174A0	XEBC-04EU-E LEFT EXT DOOR COLUM	1.000	PC																																															
OB1218B0	MM BT DOUBLE GLASS DOOR UPPER CROSS BAR	1.000	PC																																															
OB1219A1	MM DOUBLE GLASS DOOR INT UPPER BEAM 860	1.000	PC																																															
CE1052A1	CABLE CONNECTION CONTROL - USB MM 750m	1.000	PC																																															
CE1053B0	MM MICROFIT LED BAR POWER SUPPLY CABL	1.000	PC																																															
CE1097A0	4M SIHF 4 POLES MICROFIT CANBUS	1.000	PC																																															



COMPONENT			SPARE PART																																																																						
Code	Description	Image	Code	Description	Kit components																																																																				
OB1108B	XEVC-0511 DOOR EXTERNAL RIGHT COLUMN		KDR1269B	BT-04 -M EXTERNAL RIGHT DOOR	<table border="1"> <thead> <tr> <th>Code</th> <th>Description</th> <th>Qty</th> <th>UOM</th> </tr> </thead> <tbody> <tr> <td>CE1285A0</td> <td>EMI ROUND FERRITE MOD.26438015 02</td> <td>2.000</td> <td>PC</td> </tr> <tr> <td>LP1019A0</td> <td>6 SERIES L200 LED LIGHT BAR - E415</td> <td>1.000</td> <td>PC</td> </tr> <tr> <td>LP1025A0</td> <td>L=415 LED LIGHT BAR COVER</td> <td>1.000</td> <td>PC</td> </tr> <tr> <td>MG1099A1</td> <td>MM COMPLETE HANDLE</td> <td>1.000</td> <td>PC</td> </tr> <tr> <td>RC1200A0</td> <td>ED=4 WIRE D.=0.5 COMPRESSIO N SPRING</td> <td>4.000</td> <td>PC</td> </tr> <tr> <td>SL1170A1</td> <td>S57 BLACK SILICON - 310ml CARTRIDGE</td> <td>35.000</td> <td>ML</td> </tr> <tr> <td>SL1222A0</td> <td>0511 EXTERNAL GLASS LATERAL SILICONE</td> <td>4.000</td> <td>PC</td> </tr> <tr> <td>SL1229A0</td> <td>BAKER EXTERNAL GLASS UPPER SILICONE</td> <td>1.000</td> <td>PC</td> </tr> <tr> <td>VE1030A1</td> <td>MAGNET FOR DOOR MICROSWITC H D=22,9mm</td> <td>2.000</td> <td>PC</td> </tr> <tr> <td>VI0239A1</td> <td>SELF-TAPPIN G SCREW 4.2X25 TCB+ INOX</td> <td>4.000</td> <td>PC</td> </tr> <tr> <td>VI1074A0</td> <td>4X16 SCREW FOR PLASTIC</td> <td>2.000</td> <td>PC</td> </tr> <tr> <td>VI1103A0</td> <td>40X12 TBSP SCREW FOR PLASTIC</td> <td>4.000</td> <td>PC</td> </tr> <tr> <td>VI1220A1</td> <td>4,2x12 TCB SELF-TAPPIN G SCREW</td> <td>28.000</td> <td>PC</td> </tr> <tr> <td>VI1930A1</td> <td>ST. STEEL 5X20 CHIP SCREW</td> <td>16.000</td> <td>PC</td> </tr> <tr> <td>VI1996A0</td> <td>M5x35 SCREW</td> <td>13.000</td> <td>PC</td> </tr> <tr> <td>VI2037A1</td> <td>40X8 TORX SHEETTRACS SELF-THREAD SCREW</td> <td>6.000</td> <td>PC</td> </tr> </tbody> </table>	Code	Description	Qty	UOM	CE1285A0	EMI ROUND FERRITE MOD.26438015 02	2.000	PC	LP1019A0	6 SERIES L200 LED LIGHT BAR - E415	1.000	PC	LP1025A0	L=415 LED LIGHT BAR COVER	1.000	PC	MG1099A1	MM COMPLETE HANDLE	1.000	PC	RC1200A0	ED=4 WIRE D.=0.5 COMPRESSIO N SPRING	4.000	PC	SL1170A1	S57 BLACK SILICON - 310ml CARTRIDGE	35.000	ML	SL1222A0	0511 EXTERNAL GLASS LATERAL SILICONE	4.000	PC	SL1229A0	BAKER EXTERNAL GLASS UPPER SILICONE	1.000	PC	VE1030A1	MAGNET FOR DOOR MICROSWITC H D=22,9mm	2.000	PC	VI0239A1	SELF-TAPPIN G SCREW 4.2X25 TCB+ INOX	4.000	PC	VI1074A0	4X16 SCREW FOR PLASTIC	2.000	PC	VI1103A0	40X12 TBSP SCREW FOR PLASTIC	4.000	PC	VI1220A1	4,2x12 TCB SELF-TAPPIN G SCREW	28.000	PC	VI1930A1	ST. STEEL 5X20 CHIP SCREW	16.000	PC	VI1996A0	M5x35 SCREW	13.000	PC	VI2037A1	40X8 TORX SHEETTRACS SELF-THREAD SCREW	6.000	PC
					Code	Description	Qty	UOM																																																																	
					CE1285A0	EMI ROUND FERRITE MOD.26438015 02	2.000	PC																																																																	
					LP1019A0	6 SERIES L200 LED LIGHT BAR - E415	1.000	PC																																																																	
					LP1025A0	L=415 LED LIGHT BAR COVER	1.000	PC																																																																	
					MG1099A1	MM COMPLETE HANDLE	1.000	PC																																																																	
					RC1200A0	ED=4 WIRE D.=0.5 COMPRESSIO N SPRING	4.000	PC																																																																	
					SL1170A1	S57 BLACK SILICON - 310ml CARTRIDGE	35.000	ML																																																																	
					SL1222A0	0511 EXTERNAL GLASS LATERAL SILICONE	4.000	PC																																																																	
					SL1229A0	BAKER EXTERNAL GLASS UPPER SILICONE	1.000	PC																																																																	
					VE1030A1	MAGNET FOR DOOR MICROSWITC H D=22,9mm	2.000	PC																																																																	
					VI0239A1	SELF-TAPPIN G SCREW 4.2X25 TCB+ INOX	4.000	PC																																																																	
					VI1074A0	4X16 SCREW FOR PLASTIC	2.000	PC																																																																	
					VI1103A0	40X12 TBSP SCREW FOR PLASTIC	4.000	PC																																																																	
					VI1220A1	4,2x12 TCB SELF-TAPPIN G SCREW	28.000	PC																																																																	
VI1930A1	ST. STEEL 5X20 CHIP SCREW	16.000	PC																																																																						
VI1996A0	M5x35 SCREW	13.000	PC																																																																						
VI2037A1	40X8 TORX SHEETTRACS SELF-THREAD SCREW	6.000	PC																																																																						



COMPONENT			SPARE PART																																																																														
Code	Description	Image	Code	Description	Kit components																																																																												
OB1108B	XEVC-0511 DOOR EXTERNAL RIGHT COLUMN		KDR1269B	BT-04 -M EXTERNAL RIGHT DOOR	<table border="1"> <thead> <tr> <th>Code</th> <th>Description</th> <th>Qty</th> <th>UOM</th> </tr> </thead> <tbody> <tr> <td>VM1490A0</td> <td>CHEFTOP/BAK ERTOP HANDLE SCREWS COVER</td> <td>2.000</td> <td>PC</td> </tr> <tr> <td>VM1630A1</td> <td>INTERNAL GLASS PUSHING CAP</td> <td>3.000</td> <td>PC</td> </tr> <tr> <td>VM1631A0</td> <td>PLUS INNER GLASS PUSHING CAP</td> <td>3.000</td> <td>PC</td> </tr> <tr> <td>VM2259B0</td> <td>VM2259B0</td> <td>1.000</td> <td>PC</td> </tr> <tr> <td>VM2260B0</td> <td>S6 LEFT UPPER CAP</td> <td>1.000</td> <td>PC</td> </tr> <tr> <td>VM2261B0</td> <td>MM -M DOOR RIGHT LOWER CAP</td> <td>1.000</td> <td>PC</td> </tr> <tr> <td>VM2262B0</td> <td>MM -M DOOR RIGHT UPPER CAP</td> <td>1.000</td> <td>PC</td> </tr> <tr> <td>VM2267A0</td> <td>INTERNAL GLASS LOCKING SYSTEM SLIDER</td> <td>2.000</td> <td>PC</td> </tr> <tr> <td>VM2268A0</td> <td>DOOR MAGNET COVER</td> <td>2.000</td> <td>PC</td> </tr> <tr> <td>VM2269B0</td> <td>INNER GLASS FIXING CAP</td> <td>2.000</td> <td>PC</td> </tr> <tr> <td>VM2274A0</td> <td>GROOVED BUSHING</td> <td>1.000</td> <td>PC</td> </tr> <tr> <td>VM2275A0</td> <td>SMOOTH BUSHING</td> <td>1.000</td> <td>PC</td> </tr> <tr> <td>VM2285B0</td> <td>860 SERIES DRIP PROFILE KIT</td> <td>1.000</td> <td>PC</td> </tr> <tr> <td>VM2305A0</td> <td>6 SERIES DOOR CAP FIXING PAWL</td> <td>14.000</td> <td>PC</td> </tr> <tr> <td>VM2312A0</td> <td>6 S. DRIP PROFILE DRAIN LEFT PIPE</td> <td>1.000</td> <td>PC</td> </tr> <tr> <td>VM2314A0</td> <td>6 S. DRIP PROFILE CAP</td> <td>1.000</td> <td>PC</td> </tr> <tr> <td>VM2315B0</td> <td>S6 INTERNAL GLASS SUPPORT</td> <td>3.000</td> <td>PC</td> </tr> <tr> <td>VM2505B1</td> <td>MM PLUS INTERNAL GLASS SUPPORT</td> <td>3.000</td> <td>PC</td> </tr> </tbody> </table>	Code	Description	Qty	UOM	VM1490A0	CHEFTOP/BAK ERTOP HANDLE SCREWS COVER	2.000	PC	VM1630A1	INTERNAL GLASS PUSHING CAP	3.000	PC	VM1631A0	PLUS INNER GLASS PUSHING CAP	3.000	PC	VM2259B0	VM2259B0	1.000	PC	VM2260B0	S6 LEFT UPPER CAP	1.000	PC	VM2261B0	MM -M DOOR RIGHT LOWER CAP	1.000	PC	VM2262B0	MM -M DOOR RIGHT UPPER CAP	1.000	PC	VM2267A0	INTERNAL GLASS LOCKING SYSTEM SLIDER	2.000	PC	VM2268A0	DOOR MAGNET COVER	2.000	PC	VM2269B0	INNER GLASS FIXING CAP	2.000	PC	VM2274A0	GROOVED BUSHING	1.000	PC	VM2275A0	SMOOTH BUSHING	1.000	PC	VM2285B0	860 SERIES DRIP PROFILE KIT	1.000	PC	VM2305A0	6 SERIES DOOR CAP FIXING PAWL	14.000	PC	VM2312A0	6 S. DRIP PROFILE DRAIN LEFT PIPE	1.000	PC	VM2314A0	6 S. DRIP PROFILE CAP	1.000	PC	VM2315B0	S6 INTERNAL GLASS SUPPORT	3.000	PC	VM2505B1	MM PLUS INTERNAL GLASS SUPPORT	3.000	PC
Code	Description	Qty	UOM																																																																														
VM1490A0	CHEFTOP/BAK ERTOP HANDLE SCREWS COVER	2.000	PC																																																																														
VM1630A1	INTERNAL GLASS PUSHING CAP	3.000	PC																																																																														
VM1631A0	PLUS INNER GLASS PUSHING CAP	3.000	PC																																																																														
VM2259B0	VM2259B0	1.000	PC																																																																														
VM2260B0	S6 LEFT UPPER CAP	1.000	PC																																																																														
VM2261B0	MM -M DOOR RIGHT LOWER CAP	1.000	PC																																																																														
VM2262B0	MM -M DOOR RIGHT UPPER CAP	1.000	PC																																																																														
VM2267A0	INTERNAL GLASS LOCKING SYSTEM SLIDER	2.000	PC																																																																														
VM2268A0	DOOR MAGNET COVER	2.000	PC																																																																														
VM2269B0	INNER GLASS FIXING CAP	2.000	PC																																																																														
VM2274A0	GROOVED BUSHING	1.000	PC																																																																														
VM2275A0	SMOOTH BUSHING	1.000	PC																																																																														
VM2285B0	860 SERIES DRIP PROFILE KIT	1.000	PC																																																																														
VM2305A0	6 SERIES DOOR CAP FIXING PAWL	14.000	PC																																																																														
VM2312A0	6 S. DRIP PROFILE DRAIN LEFT PIPE	1.000	PC																																																																														
VM2314A0	6 S. DRIP PROFILE CAP	1.000	PC																																																																														
VM2315B0	S6 INTERNAL GLASS SUPPORT	3.000	PC																																																																														
VM2505B1	MM PLUS INTERNAL GLASS SUPPORT	3.000	PC																																																																														



COMPONENT			SPARE PART																																							
Code	Description	Image	Code	Description	Kit components																																					
0B1108B	XEVC-0511 DOOR EXTERNAL RIGHT COLUMN		KDR1269B	BT-04 -M EXTERNAL RIGHT DOOR	<table border="1"> <thead> <tr> <th>Code</th> <th>Description</th> <th>Qty</th> <th>UOM</th> </tr> </thead> <tbody> <tr> <td>VM2518A0</td> <td>BOARD COOLING FAN SUPPORT</td> <td>1.000</td> <td>PC</td> </tr> <tr> <td>VN1179A1</td> <td>CONTROL BOARD 40x40x20mm 12V COOLING FAN</td> <td>1.000</td> <td>PC</td> </tr> <tr> <td>VP1080A0</td> <td>UPPER HINGE CAP FOR LOWER INNER GLASS</td> <td>1.000</td> <td>PC</td> </tr> <tr> <td>VP1081A0</td> <td>UPPER HINGE CAP FOR UPPER INNER GLASS</td> <td>1.000</td> <td>PC</td> </tr> <tr> <td>VT1290A0</td> <td>EXTERNAL GLASS XEBC-04EU-E</td> <td>1.000</td> <td>PC</td> </tr> </tbody> </table>	Code	Description	Qty	UOM	VM2518A0	BOARD COOLING FAN SUPPORT	1.000	PC	VN1179A1	CONTROL BOARD 40x40x20mm 12V COOLING FAN	1.000	PC	VP1080A0	UPPER HINGE CAP FOR LOWER INNER GLASS	1.000	PC	VP1081A0	UPPER HINGE CAP FOR UPPER INNER GLASS	1.000	PC	VT1290A0	EXTERNAL GLASS XEBC-04EU-E	1.000	PC													
			Code	Description	Qty	UOM																																				
VM2518A0	BOARD COOLING FAN SUPPORT	1.000	PC																																							
VN1179A1	CONTROL BOARD 40x40x20mm 12V COOLING FAN	1.000	PC																																							
VP1080A0	UPPER HINGE CAP FOR LOWER INNER GLASS	1.000	PC																																							
VP1081A0	UPPER HINGE CAP FOR UPPER INNER GLASS	1.000	PC																																							
VT1290A0	EXTERNAL GLASS XEBC-04EU-E	1.000	PC																																							
KDR1269A	BT-04 EXTERNAL RIGHT DOOR	<table border="1"> <thead> <tr> <th>Code</th> <th>Description</th> <th>Qty</th> <th>UOM</th> </tr> </thead> <tbody> <tr> <td>0B1107A1</td> <td>XEVC-0511-E LEFT INT DOOR COLUM</td> <td>1.000</td> <td>PC</td> </tr> <tr> <td>0B1108B1</td> <td>XEVC-0511 DOOR EXTERNAL RIGHT COLUM</td> <td>1.000</td> <td>PC</td> </tr> <tr> <td>0B1109A1</td> <td>XEVC-0511-E RIGHT INT DOOR COLUM</td> <td>1.000</td> <td>PC</td> </tr> <tr> <td>0B1126A1</td> <td>MM BT DOOR LOWER CROSS BAR</td> <td>1.000</td> <td>PC</td> </tr> <tr> <td>0B1166A1</td> <td>XEVC-0511-E EXT GLASS SUPPORT PROFILE</td> <td>2.000</td> <td>PC</td> </tr> <tr> <td>0B1174A0</td> <td>XEBC-04EU-E LEFT EXT DOOR COLUM</td> <td>1.000</td> <td>PC</td> </tr> <tr> <td>0B1218A1</td> <td>MM BT DOUBLE GLASS DOOR UPPER CROSS BAR</td> <td>1.000</td> <td>PC</td> </tr> <tr> <td>0B1219A1</td> <td>MM DOUBLE GLASS DOOR INT UPPER BEAM 860</td> <td>1.000</td> <td>PC</td> </tr> <tr> <td>CE1052A1</td> <td>CABLE CONNECTION CONTROL - USB MM 750m</td> <td>1.000</td> <td>PC</td> </tr> </tbody> </table>	Code	Description	Qty	UOM	0B1107A1	XEVC-0511-E LEFT INT DOOR COLUM	1.000	PC	0B1108B1	XEVC-0511 DOOR EXTERNAL RIGHT COLUM	1.000	PC	0B1109A1	XEVC-0511-E RIGHT INT DOOR COLUM	1.000	PC	0B1126A1	MM BT DOOR LOWER CROSS BAR	1.000	PC	0B1166A1	XEVC-0511-E EXT GLASS SUPPORT PROFILE	2.000	PC	0B1174A0	XEBC-04EU-E LEFT EXT DOOR COLUM	1.000	PC	0B1218A1	MM BT DOUBLE GLASS DOOR UPPER CROSS BAR	1.000	PC	0B1219A1	MM DOUBLE GLASS DOOR INT UPPER BEAM 860	1.000	PC	CE1052A1	CABLE CONNECTION CONTROL - USB MM 750m	1.000	PC
Code	Description	Qty	UOM																																							
0B1107A1	XEVC-0511-E LEFT INT DOOR COLUM	1.000	PC																																							
0B1108B1	XEVC-0511 DOOR EXTERNAL RIGHT COLUM	1.000	PC																																							
0B1109A1	XEVC-0511-E RIGHT INT DOOR COLUM	1.000	PC																																							
0B1126A1	MM BT DOOR LOWER CROSS BAR	1.000	PC																																							
0B1166A1	XEVC-0511-E EXT GLASS SUPPORT PROFILE	2.000	PC																																							
0B1174A0	XEBC-04EU-E LEFT EXT DOOR COLUM	1.000	PC																																							
0B1218A1	MM BT DOUBLE GLASS DOOR UPPER CROSS BAR	1.000	PC																																							
0B1219A1	MM DOUBLE GLASS DOOR INT UPPER BEAM 860	1.000	PC																																							
CE1052A1	CABLE CONNECTION CONTROL - USB MM 750m	1.000	PC																																							



COMPONENT			SPARE PART																																																																						
Code	Description	Image	Code	Description	Kit components																																																																				
OB1108B	XEVC-0511 DOOR EXTERNAL RIGHT COLUMN		KDR1269A	BT-04 EXTERNAL RIGHT DOOR	<table border="1"> <thead> <tr> <th>Code</th> <th>Description</th> <th>Qty</th> <th>UOM</th> </tr> </thead> <tbody> <tr> <td>CE1053B0</td> <td>MM MICROFIT LED BAR POWER SUPPLY CABL</td> <td>1.000</td> <td>PC</td> </tr> <tr> <td>CE1285A0</td> <td>EMI ROUND FERRITE MOD.26438015 02</td> <td>1.000</td> <td>PC</td> </tr> <tr> <td>CE1290A0</td> <td>EXTRACTABL E FEMALE TERMINAL CPF 5/4</td> <td>1.000</td> <td>PC</td> </tr> <tr> <td>CE1310A1</td> <td>POWER - CONTROL BOARD CONNECTING CABLE</td> <td>1.000</td> <td>PC</td> </tr> <tr> <td>LP1019A0</td> <td>6 SERIES L200 LED LIGHT BAR - E415</td> <td>1.000</td> <td>PC</td> </tr> <tr> <td>LP1025A0</td> <td>L=415 LED LIGHT BAR COVER</td> <td>1.000</td> <td>PC</td> </tr> <tr> <td>MG1083A2</td> <td>MM COMPLETE HANDLE</td> <td>1.000</td> <td>PC</td> </tr> <tr> <td>SL1170A1</td> <td>S57 BLACK SILICON - 310ml CARTRIDGE</td> <td>30.000</td> <td>ML</td> </tr> <tr> <td>VE1030A1</td> <td>MAGNET FOR DOOR MICROSWITC H D=22,9mm</td> <td>2.000</td> <td>PC</td> </tr> <tr> <td>VH1147A0</td> <td>5X25 STAINLESS STEEL SCREW</td> <td>16.000</td> <td>PC</td> </tr> <tr> <td>VH1220A1</td> <td>4,2x12 TCB SELF-TAPPIN G SCREW</td> <td>25.000</td> <td>PC</td> </tr> <tr> <td>VH1996A0</td> <td>M5x35 SCREW</td> <td>13.000</td> <td>PC</td> </tr> <tr> <td>VM1630A1</td> <td>INTERNAL GLASS PUSHING CAP</td> <td>3.000</td> <td>PC</td> </tr> <tr> <td>VM1631A0</td> <td>PLUS INNER GLASS PUSHING CAP</td> <td>2.000</td> <td>PC</td> </tr> <tr> <td>VM2259A1</td> <td>6 SERIES DOOR LOWER LEFT CAP</td> <td>1.000</td> <td>PC</td> </tr> <tr> <td>VM2260A1</td> <td>6 SERIES DOOR UPPER LEFT CAP</td> <td>1.000</td> <td>PC</td> </tr> </tbody> </table>	Code	Description	Qty	UOM	CE1053B0	MM MICROFIT LED BAR POWER SUPPLY CABL	1.000	PC	CE1285A0	EMI ROUND FERRITE MOD.26438015 02	1.000	PC	CE1290A0	EXTRACTABL E FEMALE TERMINAL CPF 5/4	1.000	PC	CE1310A1	POWER - CONTROL BOARD CONNECTING CABLE	1.000	PC	LP1019A0	6 SERIES L200 LED LIGHT BAR - E415	1.000	PC	LP1025A0	L=415 LED LIGHT BAR COVER	1.000	PC	MG1083A2	MM COMPLETE HANDLE	1.000	PC	SL1170A1	S57 BLACK SILICON - 310ml CARTRIDGE	30.000	ML	VE1030A1	MAGNET FOR DOOR MICROSWITC H D=22,9mm	2.000	PC	VH1147A0	5X25 STAINLESS STEEL SCREW	16.000	PC	VH1220A1	4,2x12 TCB SELF-TAPPIN G SCREW	25.000	PC	VH1996A0	M5x35 SCREW	13.000	PC	VM1630A1	INTERNAL GLASS PUSHING CAP	3.000	PC	VM1631A0	PLUS INNER GLASS PUSHING CAP	2.000	PC	VM2259A1	6 SERIES DOOR LOWER LEFT CAP	1.000	PC	VM2260A1	6 SERIES DOOR UPPER LEFT CAP	1.000	PC
					Code	Description	Qty	UOM																																																																	
					CE1053B0	MM MICROFIT LED BAR POWER SUPPLY CABL	1.000	PC																																																																	
					CE1285A0	EMI ROUND FERRITE MOD.26438015 02	1.000	PC																																																																	
					CE1290A0	EXTRACTABL E FEMALE TERMINAL CPF 5/4	1.000	PC																																																																	
					CE1310A1	POWER - CONTROL BOARD CONNECTING CABLE	1.000	PC																																																																	
					LP1019A0	6 SERIES L200 LED LIGHT BAR - E415	1.000	PC																																																																	
					LP1025A0	L=415 LED LIGHT BAR COVER	1.000	PC																																																																	
					MG1083A2	MM COMPLETE HANDLE	1.000	PC																																																																	
					SL1170A1	S57 BLACK SILICON - 310ml CARTRIDGE	30.000	ML																																																																	
					VE1030A1	MAGNET FOR DOOR MICROSWITC H D=22,9mm	2.000	PC																																																																	
					VH1147A0	5X25 STAINLESS STEEL SCREW	16.000	PC																																																																	
					VH1220A1	4,2x12 TCB SELF-TAPPIN G SCREW	25.000	PC																																																																	
					VH1996A0	M5x35 SCREW	13.000	PC																																																																	
					VM1630A1	INTERNAL GLASS PUSHING CAP	3.000	PC																																																																	
VM1631A0	PLUS INNER GLASS PUSHING CAP	2.000	PC																																																																						
VM2259A1	6 SERIES DOOR LOWER LEFT CAP	1.000	PC																																																																						
VM2260A1	6 SERIES DOOR UPPER LEFT CAP	1.000	PC																																																																						



COMPONENT			SPARE PART					
Code	Description	Image	Code	Description	Kit components			
OB1108B	XEVC-0511 DOOR EXTERNAL RIGHT COLUMN		KDR1269A	BT-04 EXTERNAL RIGHT DOOR	Code	Description	Qty	UOM
					VM2261A1	MM DOOR LOWER RIGHT CAP	1.000	PC
					VM2262A1	MM DOOR UPPER RIGHT CAP	1.000	PC
					VM2267A0	INTERNAL GLASS LOCKING SYSTEM SLIDER	2.000	PC
					VM2268A0	DOOR MAGNET COVER	2.000	PC
					VM2269A0	INTERNAL GLASS LOCKING SYSTEM CAP	2.000	PC
					VM2274A0	GROOVED BUSHING	1.000	PC
					VM2275A0	SMOOTH BUSHING	1.000	PC
					VM2285A0	860 SERIES DRIP PROFILE	1.000	PC
					VM2305A0	6 SERIES DOOR CAP FIXING PAWL	14.000	PC
					VM2312A0	6 S. DRIP PROFILE DRAIN LEFT PIPE	1.000	PC
					VM2313A0	TUBE DX DISCHARGE DRIP MM	1.000	PC
					VM2314A0	6 S. DRIP PROFILE CAP	1.000	PC
					VM2315A0	MIND.Maps INTERNAL GLASS CAP SUPPORT	3.000	PC
					VM2505A0	MM PLUS INTERNAL GLASS SUPPORT	2.000	PC
					VM2518A0	BOARD COOLING FAN SUPPORT	1.000	PC
					VN1179A1	CONTROL BOARD 40x40x20mm 12V COOLING FAN	1.000	PC
VT1290A0	EXTERNAL GLASS XEBC-04EU-E	1.000	PC					



COMPONENT			SPARE PART																																																																		
Code	Description	Image	Code	Description	Kit components																																																																
0B1108B	XEVC-0511 DOOR EXTERNAL RIGHT COLUMN		KDR1261B	0511 -M RIGHT EXTERNAL DOOR	<table border="1"> <thead> <tr> <th>Code</th> <th>Description</th> <th>Qty</th> <th>UOM</th> </tr> </thead> <tbody> <tr> <td>0B1106A0</td> <td>XEVC-0511-E DOOR EXTERNAL LEFT COLUMN</td> <td>1.000</td> <td>PC</td> </tr> <tr> <td>0B1107A1</td> <td>XEVC-0511-E LEFT INT DOOR COLUM</td> <td>1.000</td> <td>PC</td> </tr> <tr> <td>0B1108B1</td> <td>XEVC-0511 DOOR EXTERNAL RIGHT COLUM</td> <td>1.000</td> <td>PC</td> </tr> <tr> <td>0B1109A1</td> <td>XEVC-0511-E RIGHT INT DOOR COLUM</td> <td>1.000</td> <td>PC</td> </tr> <tr> <td>0B1122B0</td> <td>MM CT DOOR LOWER CROSS BAR</td> <td>1.000</td> <td>PC</td> </tr> <tr> <td>0B1166A1</td> <td>XEVC-0511-E EXT GLASS SUPPORT PROFILE</td> <td>2.000</td> <td>PC</td> </tr> <tr> <td>0B1216B0</td> <td>MM CT DOUBLE GLASS DOOR UPPER CROSS BAR</td> <td>1.000</td> <td>PC</td> </tr> <tr> <td>0B1217A1</td> <td>MM DOUBLE GLASS DOOR INT UPPER BEAM 750</td> <td>1.000</td> <td>PC</td> </tr> <tr> <td>CE1052A1</td> <td>CABLE CONNECTION CONTROL - USB MM 750m</td> <td>1.000</td> <td>PC</td> </tr> <tr> <td>CE1053B0</td> <td>MM MICROFIT LED BAR POWER SUPPLY CABL</td> <td>1.000</td> <td>PC</td> </tr> <tr> <td>CE1096A0</td> <td>4 POLES MICROFIT 3 M BUS CABLE</td> <td>1.000</td> <td>PC</td> </tr> <tr> <td>CE1285A0</td> <td>EMI ROUND FERRITE MOD.26438015 02</td> <td>2.000</td> <td>PC</td> </tr> <tr> <td>GN1525A0</td> <td>O-RING INT DIAM 9,5 THK 1 NBR 70</td> <td>1.000</td> <td>PC</td> </tr> <tr> <td>LP1019A0</td> <td>6 SERIES L200 LED LIGHT BAR - E415</td> <td>1.000</td> <td>PC</td> </tr> <tr> <td>LP1025A0</td> <td>L=415 LED LIGHT BAR COVER</td> <td>1.000</td> <td>PC</td> </tr> </tbody> </table>	Code	Description	Qty	UOM	0B1106A0	XEVC-0511-E DOOR EXTERNAL LEFT COLUMN	1.000	PC	0B1107A1	XEVC-0511-E LEFT INT DOOR COLUM	1.000	PC	0B1108B1	XEVC-0511 DOOR EXTERNAL RIGHT COLUM	1.000	PC	0B1109A1	XEVC-0511-E RIGHT INT DOOR COLUM	1.000	PC	0B1122B0	MM CT DOOR LOWER CROSS BAR	1.000	PC	0B1166A1	XEVC-0511-E EXT GLASS SUPPORT PROFILE	2.000	PC	0B1216B0	MM CT DOUBLE GLASS DOOR UPPER CROSS BAR	1.000	PC	0B1217A1	MM DOUBLE GLASS DOOR INT UPPER BEAM 750	1.000	PC	CE1052A1	CABLE CONNECTION CONTROL - USB MM 750m	1.000	PC	CE1053B0	MM MICROFIT LED BAR POWER SUPPLY CABL	1.000	PC	CE1096A0	4 POLES MICROFIT 3 M BUS CABLE	1.000	PC	CE1285A0	EMI ROUND FERRITE MOD.26438015 02	2.000	PC	GN1525A0	O-RING INT DIAM 9,5 THK 1 NBR 70	1.000	PC	LP1019A0	6 SERIES L200 LED LIGHT BAR - E415	1.000	PC	LP1025A0	L=415 LED LIGHT BAR COVER	1.000	PC
					Code	Description	Qty	UOM																																																													
					0B1106A0	XEVC-0511-E DOOR EXTERNAL LEFT COLUMN	1.000	PC																																																													
					0B1107A1	XEVC-0511-E LEFT INT DOOR COLUM	1.000	PC																																																													
					0B1108B1	XEVC-0511 DOOR EXTERNAL RIGHT COLUM	1.000	PC																																																													
					0B1109A1	XEVC-0511-E RIGHT INT DOOR COLUM	1.000	PC																																																													
					0B1122B0	MM CT DOOR LOWER CROSS BAR	1.000	PC																																																													
					0B1166A1	XEVC-0511-E EXT GLASS SUPPORT PROFILE	2.000	PC																																																													
					0B1216B0	MM CT DOUBLE GLASS DOOR UPPER CROSS BAR	1.000	PC																																																													
					0B1217A1	MM DOUBLE GLASS DOOR INT UPPER BEAM 750	1.000	PC																																																													
					CE1052A1	CABLE CONNECTION CONTROL - USB MM 750m	1.000	PC																																																													
					CE1053B0	MM MICROFIT LED BAR POWER SUPPLY CABL	1.000	PC																																																													
					CE1096A0	4 POLES MICROFIT 3 M BUS CABLE	1.000	PC																																																													
					CE1285A0	EMI ROUND FERRITE MOD.26438015 02	2.000	PC																																																													
					GN1525A0	O-RING INT DIAM 9,5 THK 1 NBR 70	1.000	PC																																																													
LP1019A0	6 SERIES L200 LED LIGHT BAR - E415	1.000	PC																																																																		
LP1025A0	L=415 LED LIGHT BAR COVER	1.000	PC																																																																		



COMPONENT			SPARE PART					
Code	Description	Image	Code	Description	Kit components			
0B1108B	XEVC-0511 DOOR EXTERNAL RIGHT COLUMN		KDR1261B	0511 -M RIGHT EXTERNAL DOOR	Code	Description	Qty	UOM
					MG1099A1	MM COMPLETE HANDLE	1.000	PC
					RC1200A0	ED=4 WIRE D.=0.5 COMPRESSIO N SPRING	4.000	PC
					SL1170A1	S57 BLACK SILICON - 310ml CARTRIDGE	30.000	ML
					SL1221A0	GN1/1 EXTERNAL GLASS UPPER SILICONE	1.000	PC
					SL1222A0	0511 EXTERNAL GLASS LATERAL SILICONE	4.000	PC
					VE1030A1	MAGNET FOR DOOR MICROSWITC H D=22,9mm	2.000	PC
					VI0239A1	SELF-TAPPIN G SCREW 4.2X25 TCB+ INOX	4.000	PC
					VI1034A0	STAINLESS STEEL WASHER 8.4x16x1	1.000	PC
					VI1074A0	4X16 SCREW FOR PLASTIC	2.000	PC
					VI1103A0	40X12 TBSP SCREW FOR PLASTIC	2.000	PC
					VI1220A1	4,2x12 TCB SELF-TAPPIN G SCREW	26.000	PC
					VI1930A1	ST. STEEL 5X20 CHIP SCREW	16.000	PC
					VI1996A0	M5x35 SCREW	13.000	PC
					VI2037A1	40X8 TORX SHEETTRACS SELF-THREAD SCREW	6.000	PC
					VM1490A0	CHEFTOP/BAK ERTOP HANDLE SCREWS COVER	2.000	PC



COMPONENT			SPARE PART																																																																														
Code	Description	Image	Code	Description	Kit components																																																																												
OB1108B	XEVC-0511 DOOR EXTERNAL RIGHT COLUMN		KDR1261B	0511 -M RIGHT EXTERNAL DOOR	<table border="1"> <thead> <tr> <th>Code</th> <th>Description</th> <th>Qty</th> <th>UOM</th> </tr> </thead> <tbody> <tr> <td>VM1630A1</td> <td>INTERNAL GLASS PUSHING CAP</td> <td>3.000</td> <td>PC</td> </tr> <tr> <td>VM1631A0</td> <td>PLUS INNER GLASS PUSHING CAP</td> <td>3.000</td> <td>PC</td> </tr> <tr> <td>VM2259B0</td> <td>VM2259B0</td> <td>1.000</td> <td>PC</td> </tr> <tr> <td>VM2260B0</td> <td>S6 LEFT UPPER CAP</td> <td>1.000</td> <td>PC</td> </tr> <tr> <td>VM2261B0</td> <td>MM -M DOOR RIGHT LOWER CAP</td> <td>1.000</td> <td>PC</td> </tr> <tr> <td>VM2262B0</td> <td>MM -M DOOR RIGHT UPPER CAP</td> <td>1.000</td> <td>PC</td> </tr> <tr> <td>VM2267A0</td> <td>INTERNAL GLASS LOCKING SYSTEM SLIDER</td> <td>2.000</td> <td>PC</td> </tr> <tr> <td>VM2268A0</td> <td>DOOR MAGNET COVER</td> <td>2.000</td> <td>PC</td> </tr> <tr> <td>VM2269B0</td> <td>INNER GLASS FIXING CAP</td> <td>2.000</td> <td>PC</td> </tr> <tr> <td>VM2274A0</td> <td>GROOVED BUSHING</td> <td>1.000</td> <td>PC</td> </tr> <tr> <td>VM2275A0</td> <td>SMOOTH BUSHING</td> <td>1.000</td> <td>PC</td> </tr> <tr> <td>VM2284B0</td> <td>750 SERIES DRIP PROFILE KIT</td> <td>1.000</td> <td>PC</td> </tr> <tr> <td>VM2305A0</td> <td>6 SERIES DOOR CAP FIXING PAWL</td> <td>14.000</td> <td>PC</td> </tr> <tr> <td>VM2312A0</td> <td>6 S. DRIP PROFILE DRAIN LEFT PIPE</td> <td>1.000</td> <td>PC</td> </tr> <tr> <td>VM2314A0</td> <td>6 S. DRIP PROFILE CAP</td> <td>1.000</td> <td>PC</td> </tr> <tr> <td>VM2315B0</td> <td>S6 INTERNAL GLASS SUPPORT</td> <td>3.000</td> <td>PC</td> </tr> <tr> <td>VM2505B1</td> <td>MM PLUS INTERNAL GLASS SUPPORT</td> <td>3.000</td> <td>PC</td> </tr> <tr> <td>VP1080A0</td> <td>UPPER HINGE CAP FOR LOWER INNER GLASS</td> <td>1.000</td> <td>PC</td> </tr> </tbody> </table>	Code	Description	Qty	UOM	VM1630A1	INTERNAL GLASS PUSHING CAP	3.000	PC	VM1631A0	PLUS INNER GLASS PUSHING CAP	3.000	PC	VM2259B0	VM2259B0	1.000	PC	VM2260B0	S6 LEFT UPPER CAP	1.000	PC	VM2261B0	MM -M DOOR RIGHT LOWER CAP	1.000	PC	VM2262B0	MM -M DOOR RIGHT UPPER CAP	1.000	PC	VM2267A0	INTERNAL GLASS LOCKING SYSTEM SLIDER	2.000	PC	VM2268A0	DOOR MAGNET COVER	2.000	PC	VM2269B0	INNER GLASS FIXING CAP	2.000	PC	VM2274A0	GROOVED BUSHING	1.000	PC	VM2275A0	SMOOTH BUSHING	1.000	PC	VM2284B0	750 SERIES DRIP PROFILE KIT	1.000	PC	VM2305A0	6 SERIES DOOR CAP FIXING PAWL	14.000	PC	VM2312A0	6 S. DRIP PROFILE DRAIN LEFT PIPE	1.000	PC	VM2314A0	6 S. DRIP PROFILE CAP	1.000	PC	VM2315B0	S6 INTERNAL GLASS SUPPORT	3.000	PC	VM2505B1	MM PLUS INTERNAL GLASS SUPPORT	3.000	PC	VP1080A0	UPPER HINGE CAP FOR LOWER INNER GLASS	1.000	PC
Code	Description	Qty	UOM																																																																														
VM1630A1	INTERNAL GLASS PUSHING CAP	3.000	PC																																																																														
VM1631A0	PLUS INNER GLASS PUSHING CAP	3.000	PC																																																																														
VM2259B0	VM2259B0	1.000	PC																																																																														
VM2260B0	S6 LEFT UPPER CAP	1.000	PC																																																																														
VM2261B0	MM -M DOOR RIGHT LOWER CAP	1.000	PC																																																																														
VM2262B0	MM -M DOOR RIGHT UPPER CAP	1.000	PC																																																																														
VM2267A0	INTERNAL GLASS LOCKING SYSTEM SLIDER	2.000	PC																																																																														
VM2268A0	DOOR MAGNET COVER	2.000	PC																																																																														
VM2269B0	INNER GLASS FIXING CAP	2.000	PC																																																																														
VM2274A0	GROOVED BUSHING	1.000	PC																																																																														
VM2275A0	SMOOTH BUSHING	1.000	PC																																																																														
VM2284B0	750 SERIES DRIP PROFILE KIT	1.000	PC																																																																														
VM2305A0	6 SERIES DOOR CAP FIXING PAWL	14.000	PC																																																																														
VM2312A0	6 S. DRIP PROFILE DRAIN LEFT PIPE	1.000	PC																																																																														
VM2314A0	6 S. DRIP PROFILE CAP	1.000	PC																																																																														
VM2315B0	S6 INTERNAL GLASS SUPPORT	3.000	PC																																																																														
VM2505B1	MM PLUS INTERNAL GLASS SUPPORT	3.000	PC																																																																														
VP1080A0	UPPER HINGE CAP FOR LOWER INNER GLASS	1.000	PC																																																																														



COMPONENT			SPARE PART																																																			
Code	Description	Image	Code	Description	Kit components																																																	
0B1108B	XEVC-0511 DOOR EXTERNAL RIGHT COLUMN		KDR1261B	0511 -M RIGHT EXTERNAL DOOR	<table border="1"> <thead> <tr> <th>Code</th> <th>Description</th> <th>Qty</th> <th>UOM</th> </tr> </thead> <tbody> <tr> <td>VP1081A0</td> <td>UPPER HINGE CAP FOR UPPER INNER GLASS</td> <td>1.000</td> <td>PC</td> </tr> <tr> <td>VT1276A0</td> <td>XEVC-0511-E DOOR EXTERNAL GLASS</td> <td>1.000</td> <td>PC</td> </tr> </tbody> </table>	Code	Description	Qty	UOM	VP1081A0	UPPER HINGE CAP FOR UPPER INNER GLASS	1.000	PC	VT1276A0	XEVC-0511-E DOOR EXTERNAL GLASS	1.000	PC																																					
			Code	Description	Qty	UOM																																																
VP1081A0	UPPER HINGE CAP FOR UPPER INNER GLASS	1.000	PC																																																			
VT1276A0	XEVC-0511-E DOOR EXTERNAL GLASS	1.000	PC																																																			
KDR1261A	0511 RIGHT EXTERNAL DOOR	<table border="1"> <thead> <tr> <th>Code</th> <th>Description</th> <th>Qty</th> <th>UOM</th> </tr> </thead> <tbody> <tr> <td>0B1106A0</td> <td>XEVC-0511-E DOOR EXTERNAL LEFT COLUMN</td> <td>1.000</td> <td>PC</td> </tr> <tr> <td>0B1107A1</td> <td>XEVC-0511-E LEFT INT DOOR COLUM</td> <td>1.000</td> <td>PC</td> </tr> <tr> <td>0B1108B1</td> <td>XEVC-0511 DOOR EXTERNAL RIGHT COLUM</td> <td>1.000</td> <td>PC</td> </tr> <tr> <td>0B1109A1</td> <td>XEVC-0511-E RIGHT INT DOOR COLUM</td> <td>1.000</td> <td>PC</td> </tr> <tr> <td>0B1122A1</td> <td>750MM DOOR LOWER FRAME SHAPE</td> <td>1.000</td> <td>PC</td> </tr> <tr> <td>0B1166A1</td> <td>XEVC-0511-E EXT GLASS SUPPORT PROFILE</td> <td>2.000</td> <td>PC</td> </tr> <tr> <td>0B1216A1</td> <td>MM CT DOUBLE GLASS DOOR UPPER BEAM</td> <td>1.000</td> <td>PC</td> </tr> <tr> <td>0B1217A1</td> <td>MM DOUBLE GLASS DOOR INT UPPER BEAM 750</td> <td>1.000</td> <td>PC</td> </tr> <tr> <td>CE1052A1</td> <td>CABLE CONNECTION CONTROL - USB MM 750m</td> <td>1.000</td> <td>PC</td> </tr> <tr> <td>CE1053B0</td> <td>MM MICROFIT LED BAR POWER SUPPLY CABL</td> <td>1.000</td> <td>PC</td> </tr> <tr> <td>CE1275A0</td> <td>3M POWER - CONTROL CONNECTION CABLE</td> <td>1.000</td> <td>PC</td> </tr> <tr> <td>CE1285A0</td> <td>EMI ROUND FERRITE MOD.26438015 02</td> <td>1.000</td> <td>PC</td> </tr> </tbody> </table>	Code	Description	Qty	UOM	0B1106A0	XEVC-0511-E DOOR EXTERNAL LEFT COLUMN	1.000	PC	0B1107A1	XEVC-0511-E LEFT INT DOOR COLUM	1.000	PC	0B1108B1	XEVC-0511 DOOR EXTERNAL RIGHT COLUM	1.000	PC	0B1109A1	XEVC-0511-E RIGHT INT DOOR COLUM	1.000	PC	0B1122A1	750MM DOOR LOWER FRAME SHAPE	1.000	PC	0B1166A1	XEVC-0511-E EXT GLASS SUPPORT PROFILE	2.000	PC	0B1216A1	MM CT DOUBLE GLASS DOOR UPPER BEAM	1.000	PC	0B1217A1	MM DOUBLE GLASS DOOR INT UPPER BEAM 750	1.000	PC	CE1052A1	CABLE CONNECTION CONTROL - USB MM 750m	1.000	PC	CE1053B0	MM MICROFIT LED BAR POWER SUPPLY CABL	1.000	PC	CE1275A0	3M POWER - CONTROL CONNECTION CABLE	1.000	PC	CE1285A0	EMI ROUND FERRITE MOD.26438015 02	1.000	PC
Code	Description	Qty	UOM																																																			
0B1106A0	XEVC-0511-E DOOR EXTERNAL LEFT COLUMN	1.000	PC																																																			
0B1107A1	XEVC-0511-E LEFT INT DOOR COLUM	1.000	PC																																																			
0B1108B1	XEVC-0511 DOOR EXTERNAL RIGHT COLUM	1.000	PC																																																			
0B1109A1	XEVC-0511-E RIGHT INT DOOR COLUM	1.000	PC																																																			
0B1122A1	750MM DOOR LOWER FRAME SHAPE	1.000	PC																																																			
0B1166A1	XEVC-0511-E EXT GLASS SUPPORT PROFILE	2.000	PC																																																			
0B1216A1	MM CT DOUBLE GLASS DOOR UPPER BEAM	1.000	PC																																																			
0B1217A1	MM DOUBLE GLASS DOOR INT UPPER BEAM 750	1.000	PC																																																			
CE1052A1	CABLE CONNECTION CONTROL - USB MM 750m	1.000	PC																																																			
CE1053B0	MM MICROFIT LED BAR POWER SUPPLY CABL	1.000	PC																																																			
CE1275A0	3M POWER - CONTROL CONNECTION CABLE	1.000	PC																																																			
CE1285A0	EMI ROUND FERRITE MOD.26438015 02	1.000	PC																																																			



COMPONENT			SPARE PART					
Code	Description	Image	Code	Description	Kit components			
OB1108B	XEVC-0511 DOOR EXTERNAL RIGHT COLUMN		KDR1261A	0511 RIGHT EXTERNAL DOOR	Code	Description	Qty	UOM
					CE1290A0	EXTRACTABL E FEMALE TERMINAL CPF 5/4	1.000	PC
					GN1525A0	O-RING INT DIAM 9,5 THK 1 NBR 70	1.000	PC
					LP1019A0	6 SERIES L200 LED LIGHT BAR - E415	1.000	PC
					LP1025A0	L=415 LED LIGHT BAR COVER	1.000	PC
					MG1083A2	MM COMPLETE HANDLE	1.000	PC
					SL1170A1	S57 BLACK SILICON - 310ml CARTRIDGE	30.000	ML
					VE1030A1	MAGNET FOR DOOR MICROSWITC H D=22,9mm	2.000	PC
					VI1034A0	STAINLESS STEEL WASHER 8,4x16x1	1.000	PC
					VI1147A0	5X25 STAINLESS STEEL SCREW	16.000	PC
					VI1220A1	4,2x12 TCB SELF-TAPPIN G SCREW	25.000	PC
					VI1996A0	M5x35 SCREW	13.000	PC
					VM1630A1	INTERNAL GLASS PUSHING CAP	3.000	PC
					VM1631A0	PLUS INNER GLASS PUSHING CAP	2.000	PC
					VM2259A1	6 SERIES DOOR LOWER LEFT CAP	1.000	PC
					VM2260A1	6 SERIES DOOR UPPER LEFT CAP	1.000	PC
					VM2261A1	MM DOOR LOWER RIGHT CAP	1.000	PC
VM2262A1	MM DOOR UPPER RIGHT CAP	1.000	PC					



COMPONENT			SPARE PART																																																														
Code	Description	Image	Code	Description	Kit components																																																												
OB1108B	XEVC-0511 DOOR EXTERNAL RIGHT COLUMN		KDR1261A	0511 RIGHT EXTERNAL DOOR	<table border="1"> <thead> <tr> <th>Code</th> <th>Description</th> <th>Qty</th> <th>UOM</th> </tr> </thead> <tbody> <tr> <td>VM2267A0</td> <td>INTERNAL GLASS LOCKING SYSTEM SLIDER</td> <td>2.000</td> <td>PC</td> </tr> <tr> <td>VM2268A0</td> <td>DOOR MAGNET COVER</td> <td>2.000</td> <td>PC</td> </tr> <tr> <td>VM2269A0</td> <td>INTERNAL GLASS LOCKING SYSTEM CAP</td> <td>2.000</td> <td>PC</td> </tr> <tr> <td>VM2274A0</td> <td>GROOVED BUSHING</td> <td>1.000</td> <td>PC</td> </tr> <tr> <td>VM2275A0</td> <td>SMOOTH BUSHING</td> <td>1.000</td> <td>PC</td> </tr> <tr> <td>VM2284A0</td> <td>750 SERIES DRIP PROFILE</td> <td>1.000</td> <td>PC</td> </tr> <tr> <td>VM2305A0</td> <td>6 SERIES DOOR CAP FIXING PAWL</td> <td>14.000</td> <td>PC</td> </tr> <tr> <td>VM2312A0</td> <td>6 S. DRIP PROFILE DRAIN LEFT PIPE</td> <td>1.000</td> <td>PC</td> </tr> <tr> <td>VM2314A0</td> <td>6 S. DRIP PROFILE CAP</td> <td>1.000</td> <td>PC</td> </tr> <tr> <td>VM2315A0</td> <td>MIND.Maps INTERNAL GLASS CAP SUPPORT</td> <td>3.000</td> <td>PC</td> </tr> <tr> <td>VM2505A0</td> <td>MM PLUS INTERNAL GLASS SUPPORT</td> <td>2.000</td> <td>PC</td> </tr> <tr> <td>VM2518A0</td> <td>BOARD COOLING FAN SUPPORT</td> <td>1.000</td> <td>PC</td> </tr> <tr> <td>VN1179A1</td> <td>CONTROL BOARD 40x40x20mm 12V COOLING FAN</td> <td>1.000</td> <td>PC</td> </tr> <tr> <td>VT1276A0</td> <td>XEVC-0511-E DOOR EXTERNAL GLASS</td> <td>1.000</td> <td>PC</td> </tr> </tbody> </table>	Code	Description	Qty	UOM	VM2267A0	INTERNAL GLASS LOCKING SYSTEM SLIDER	2.000	PC	VM2268A0	DOOR MAGNET COVER	2.000	PC	VM2269A0	INTERNAL GLASS LOCKING SYSTEM CAP	2.000	PC	VM2274A0	GROOVED BUSHING	1.000	PC	VM2275A0	SMOOTH BUSHING	1.000	PC	VM2284A0	750 SERIES DRIP PROFILE	1.000	PC	VM2305A0	6 SERIES DOOR CAP FIXING PAWL	14.000	PC	VM2312A0	6 S. DRIP PROFILE DRAIN LEFT PIPE	1.000	PC	VM2314A0	6 S. DRIP PROFILE CAP	1.000	PC	VM2315A0	MIND.Maps INTERNAL GLASS CAP SUPPORT	3.000	PC	VM2505A0	MM PLUS INTERNAL GLASS SUPPORT	2.000	PC	VM2518A0	BOARD COOLING FAN SUPPORT	1.000	PC	VN1179A1	CONTROL BOARD 40x40x20mm 12V COOLING FAN	1.000	PC	VT1276A0	XEVC-0511-E DOOR EXTERNAL GLASS	1.000	PC
Code	Description	Qty	UOM																																																														
VM2267A0	INTERNAL GLASS LOCKING SYSTEM SLIDER	2.000	PC																																																														
VM2268A0	DOOR MAGNET COVER	2.000	PC																																																														
VM2269A0	INTERNAL GLASS LOCKING SYSTEM CAP	2.000	PC																																																														
VM2274A0	GROOVED BUSHING	1.000	PC																																																														
VM2275A0	SMOOTH BUSHING	1.000	PC																																																														
VM2284A0	750 SERIES DRIP PROFILE	1.000	PC																																																														
VM2305A0	6 SERIES DOOR CAP FIXING PAWL	14.000	PC																																																														
VM2312A0	6 S. DRIP PROFILE DRAIN LEFT PIPE	1.000	PC																																																														
VM2314A0	6 S. DRIP PROFILE CAP	1.000	PC																																																														
VM2315A0	MIND.Maps INTERNAL GLASS CAP SUPPORT	3.000	PC																																																														
VM2505A0	MM PLUS INTERNAL GLASS SUPPORT	2.000	PC																																																														
VM2518A0	BOARD COOLING FAN SUPPORT	1.000	PC																																																														
VN1179A1	CONTROL BOARD 40x40x20mm 12V COOLING FAN	1.000	PC																																																														
VT1276A0	XEVC-0511-E DOOR EXTERNAL GLASS	1.000	PC																																																														



COMPONENT			SPARE PART					
Code	Description	Image	Code	Description	Kit components			
OB1109A	XEVC-0511-E RIGHT INT DOOR COLUMN		KDR1325A	0511 ZERO RIGHT -M EXTERNAL DOOR	Code	Description	Qty	UOM
					OB1106A0	XEVC-0511-E DOOR EXTERNAL LEFT COLUMN	1.000	PC
					OB1107A1	XEVC-0511-E LEFT INT DOOR COLUMN	1.000	PC
					OB1108B1	XEVC-0511 DOOR EXTERNAL RIGHT COLUMN	1.000	PC
					OB1109A1	XEVC-0511-E RIGHT INT DOOR COLUMN	1.000	PC
					OB1122B0	MM CT DOOR LOWER CROSS BAR	1.000	PC
					OB1166A1	XEVC-0511-E EXT GLASS SUPPORT PROFILE	2.000	PC
					OB1216B0	MM CT DOUBLE GLASS DOOR UPPER CROSS BAR	1.000	PC
					OB1217A1	MM DOUBLE GLASS DOOR INT UPPER BEAM 750	1.000	PC
					0H2892A0	LED BAR UPPER CAP PLATE	1.000	PC
					0H2893A0	LED BAR LOWER CAP PLATE	1.000	PC
					CE1096A0	4 POLES MICROFIT 3 M BUS CABLE	1.000	PC
					CE1285A0	EMI ROUND FERRITE MOD.26438015 02	2.000	PC
					CE1851A0	MICROFIT CABLE 2P M-F-F AWG22	1.000	PC
					CE2001A0	MICROFIT CABLE 2PM-100-2PM 2AWG22	1.000	PC
CE2002A0	MICROFIT CABLE 2PM-100-AMP MODU2 2AWG22	1.000	PC					



COMPONENT			SPARE PART																																																																						
Code	Description	Image	Code	Description	Kit components																																																																				
OB1109A	XEVC-0511-E RIGHT INT DOOR COLUMN		KDR1325A	0511 ZERO RIGHT -M EXTERNAL DOOR	<table border="1"> <thead> <tr> <th>Code</th> <th>Description</th> <th>Qty</th> <th>UOM</th> </tr> </thead> <tbody> <tr> <td>GN1525A0</td> <td>O-RING INT DIAM 9,5 THK 1 NBR 70</td> <td>1.000</td> <td>PC</td> </tr> <tr> <td>LP1019A0</td> <td>6 SERIES L200 LED LIGHT BAR - E415</td> <td>1.000</td> <td>PC</td> </tr> <tr> <td>MG1099A1</td> <td>MM COMPLETE HANDLE</td> <td>1.000</td> <td>PC</td> </tr> <tr> <td>RC1200A0</td> <td>ED=4 WIRE D.=0.5 COMPRESSIO N SPRING</td> <td>4.000</td> <td>PC</td> </tr> <tr> <td>SL1170A1</td> <td>S57 BLACK SILICON - 310ml CARTRIDGE</td> <td>30.000</td> <td>ML</td> </tr> <tr> <td>SL1221A0</td> <td>GN1/1 EXTERNAL GLASS UPPER SILICONE</td> <td>1.000</td> <td>PC</td> </tr> <tr> <td>SL1222A0</td> <td>0511 EXTERNAL GLASS LATERAL SILICONE</td> <td>4.000</td> <td>PC</td> </tr> <tr> <td>VE1030A1</td> <td>MAGNET FOR DOOR MICROSWITC H D=22,9mm</td> <td>2.000</td> <td>PC</td> </tr> <tr> <td>VI0239A1</td> <td>SELF-TAPPIN G SCREW 4.2X25 TCB+ INOX</td> <td>4.000</td> <td>PC</td> </tr> <tr> <td>VI1034A0</td> <td>STAINLESS STEEL WASHER 8.4x16x1</td> <td>1.000</td> <td>PC</td> </tr> <tr> <td>VI1074A0</td> <td>4X16 SCREW FOR PLASTIC</td> <td>2.000</td> <td>PC</td> </tr> <tr> <td>VI1103A0</td> <td>40X12 TBSP SCREW FOR PLASTIC</td> <td>2.000</td> <td>PC</td> </tr> <tr> <td>VI1220A1</td> <td>4,2x12 TCB SELF-TAPPIN G SCREW</td> <td>26.000</td> <td>PC</td> </tr> <tr> <td>VI1930A1</td> <td>ST. STEEL 5X20 CHIP SCREW</td> <td>16.000</td> <td>PC</td> </tr> <tr> <td>VI1996A0</td> <td>M5x35 SCREW</td> <td>13.000</td> <td>PC</td> </tr> <tr> <td>VI2037A1</td> <td>40X8 TORX SHEETTRACS SELF-THREAD SCREW</td> <td>6.000</td> <td>PC</td> </tr> </tbody> </table>	Code	Description	Qty	UOM	GN1525A0	O-RING INT DIAM 9,5 THK 1 NBR 70	1.000	PC	LP1019A0	6 SERIES L200 LED LIGHT BAR - E415	1.000	PC	MG1099A1	MM COMPLETE HANDLE	1.000	PC	RC1200A0	ED=4 WIRE D.=0.5 COMPRESSIO N SPRING	4.000	PC	SL1170A1	S57 BLACK SILICON - 310ml CARTRIDGE	30.000	ML	SL1221A0	GN1/1 EXTERNAL GLASS UPPER SILICONE	1.000	PC	SL1222A0	0511 EXTERNAL GLASS LATERAL SILICONE	4.000	PC	VE1030A1	MAGNET FOR DOOR MICROSWITC H D=22,9mm	2.000	PC	VI0239A1	SELF-TAPPIN G SCREW 4.2X25 TCB+ INOX	4.000	PC	VI1034A0	STAINLESS STEEL WASHER 8.4x16x1	1.000	PC	VI1074A0	4X16 SCREW FOR PLASTIC	2.000	PC	VI1103A0	40X12 TBSP SCREW FOR PLASTIC	2.000	PC	VI1220A1	4,2x12 TCB SELF-TAPPIN G SCREW	26.000	PC	VI1930A1	ST. STEEL 5X20 CHIP SCREW	16.000	PC	VI1996A0	M5x35 SCREW	13.000	PC	VI2037A1	40X8 TORX SHEETTRACS SELF-THREAD SCREW	6.000	PC
					Code	Description	Qty	UOM																																																																	
					GN1525A0	O-RING INT DIAM 9,5 THK 1 NBR 70	1.000	PC																																																																	
					LP1019A0	6 SERIES L200 LED LIGHT BAR - E415	1.000	PC																																																																	
					MG1099A1	MM COMPLETE HANDLE	1.000	PC																																																																	
					RC1200A0	ED=4 WIRE D.=0.5 COMPRESSIO N SPRING	4.000	PC																																																																	
					SL1170A1	S57 BLACK SILICON - 310ml CARTRIDGE	30.000	ML																																																																	
					SL1221A0	GN1/1 EXTERNAL GLASS UPPER SILICONE	1.000	PC																																																																	
					SL1222A0	0511 EXTERNAL GLASS LATERAL SILICONE	4.000	PC																																																																	
					VE1030A1	MAGNET FOR DOOR MICROSWITC H D=22,9mm	2.000	PC																																																																	
					VI0239A1	SELF-TAPPIN G SCREW 4.2X25 TCB+ INOX	4.000	PC																																																																	
					VI1034A0	STAINLESS STEEL WASHER 8.4x16x1	1.000	PC																																																																	
					VI1074A0	4X16 SCREW FOR PLASTIC	2.000	PC																																																																	
					VI1103A0	40X12 TBSP SCREW FOR PLASTIC	2.000	PC																																																																	
					VI1220A1	4,2x12 TCB SELF-TAPPIN G SCREW	26.000	PC																																																																	
VI1930A1	ST. STEEL 5X20 CHIP SCREW	16.000	PC																																																																						
VI1996A0	M5x35 SCREW	13.000	PC																																																																						
VI2037A1	40X8 TORX SHEETTRACS SELF-THREAD SCREW	6.000	PC																																																																						



COMPONENT			SPARE PART																																																																														
Code	Description	Image	Code	Description	Kit components																																																																												
OB1109A	XEVC-0511-E RIGHT INT DOOR COLUMN		KDR1325A	0511 ZERO RIGHT -M EXTERNAL DOOR	<table border="1"> <thead> <tr> <th>Code</th> <th>Description</th> <th>Qty</th> <th>UOM</th> </tr> </thead> <tbody> <tr> <td>VM1490A0</td> <td>CHEFTOP/BAK ERTOP HANDLE SCREWS COVER</td> <td>2.000</td> <td>PC</td> </tr> <tr> <td>VM1630A1</td> <td>INTERNAL GLASS PUSHING CAP</td> <td>3.000</td> <td>PC</td> </tr> <tr> <td>VM1631A0</td> <td>PLUS INNER GLASS PUSHING CAP</td> <td>3.000</td> <td>PC</td> </tr> <tr> <td>VM2259B0</td> <td>VM2259B0</td> <td>1.000</td> <td>PC</td> </tr> <tr> <td>VM2260B0</td> <td>S6 LEFT UPPER CAP</td> <td>1.000</td> <td>PC</td> </tr> <tr> <td>VM2261B0</td> <td>MM -M DOOR RIGHT LOWER CAP</td> <td>1.000</td> <td>PC</td> </tr> <tr> <td>VM2262B0</td> <td>MM -M DOOR RIGHT UPPER CAP</td> <td>1.000</td> <td>PC</td> </tr> <tr> <td>VM2267A0</td> <td>INTERNAL GLASS LOCKING SYSTEM SLIDER</td> <td>2.000</td> <td>PC</td> </tr> <tr> <td>VM2268A0</td> <td>DOOR MAGNET COVER</td> <td>2.000</td> <td>PC</td> </tr> <tr> <td>VM2269B0</td> <td>INNER GLASS FIXING CAP</td> <td>2.000</td> <td>PC</td> </tr> <tr> <td>VM2274A0</td> <td>GROOVED BUSHING</td> <td>1.000</td> <td>PC</td> </tr> <tr> <td>VM2275A0</td> <td>SMOOTH BUSHING</td> <td>1.000</td> <td>PC</td> </tr> <tr> <td>VM2284B0</td> <td>750 SERIES DRIP PROFILE KIT</td> <td>1.000</td> <td>PC</td> </tr> <tr> <td>VM2305A0</td> <td>6 SERIES DOOR CAP FIXING PAWL</td> <td>14.000</td> <td>PC</td> </tr> <tr> <td>VM2312A0</td> <td>6 S. DRIP PROFILE DRAIN LEFT PIPE</td> <td>1.000</td> <td>PC</td> </tr> <tr> <td>VM2314A0</td> <td>6 S. DRIP PROFILE CAP</td> <td>1.000</td> <td>PC</td> </tr> <tr> <td>VM2315B0</td> <td>S6 INTERNAL GLASS SUPPORT</td> <td>3.000</td> <td>PC</td> </tr> <tr> <td>VM2505B1</td> <td>MM PLUS INTERNAL GLASS SUPPORT</td> <td>3.000</td> <td>PC</td> </tr> </tbody> </table>	Code	Description	Qty	UOM	VM1490A0	CHEFTOP/BAK ERTOP HANDLE SCREWS COVER	2.000	PC	VM1630A1	INTERNAL GLASS PUSHING CAP	3.000	PC	VM1631A0	PLUS INNER GLASS PUSHING CAP	3.000	PC	VM2259B0	VM2259B0	1.000	PC	VM2260B0	S6 LEFT UPPER CAP	1.000	PC	VM2261B0	MM -M DOOR RIGHT LOWER CAP	1.000	PC	VM2262B0	MM -M DOOR RIGHT UPPER CAP	1.000	PC	VM2267A0	INTERNAL GLASS LOCKING SYSTEM SLIDER	2.000	PC	VM2268A0	DOOR MAGNET COVER	2.000	PC	VM2269B0	INNER GLASS FIXING CAP	2.000	PC	VM2274A0	GROOVED BUSHING	1.000	PC	VM2275A0	SMOOTH BUSHING	1.000	PC	VM2284B0	750 SERIES DRIP PROFILE KIT	1.000	PC	VM2305A0	6 SERIES DOOR CAP FIXING PAWL	14.000	PC	VM2312A0	6 S. DRIP PROFILE DRAIN LEFT PIPE	1.000	PC	VM2314A0	6 S. DRIP PROFILE CAP	1.000	PC	VM2315B0	S6 INTERNAL GLASS SUPPORT	3.000	PC	VM2505B1	MM PLUS INTERNAL GLASS SUPPORT	3.000	PC
Code	Description	Qty	UOM																																																																														
VM1490A0	CHEFTOP/BAK ERTOP HANDLE SCREWS COVER	2.000	PC																																																																														
VM1630A1	INTERNAL GLASS PUSHING CAP	3.000	PC																																																																														
VM1631A0	PLUS INNER GLASS PUSHING CAP	3.000	PC																																																																														
VM2259B0	VM2259B0	1.000	PC																																																																														
VM2260B0	S6 LEFT UPPER CAP	1.000	PC																																																																														
VM2261B0	MM -M DOOR RIGHT LOWER CAP	1.000	PC																																																																														
VM2262B0	MM -M DOOR RIGHT UPPER CAP	1.000	PC																																																																														
VM2267A0	INTERNAL GLASS LOCKING SYSTEM SLIDER	2.000	PC																																																																														
VM2268A0	DOOR MAGNET COVER	2.000	PC																																																																														
VM2269B0	INNER GLASS FIXING CAP	2.000	PC																																																																														
VM2274A0	GROOVED BUSHING	1.000	PC																																																																														
VM2275A0	SMOOTH BUSHING	1.000	PC																																																																														
VM2284B0	750 SERIES DRIP PROFILE KIT	1.000	PC																																																																														
VM2305A0	6 SERIES DOOR CAP FIXING PAWL	14.000	PC																																																																														
VM2312A0	6 S. DRIP PROFILE DRAIN LEFT PIPE	1.000	PC																																																																														
VM2314A0	6 S. DRIP PROFILE CAP	1.000	PC																																																																														
VM2315B0	S6 INTERNAL GLASS SUPPORT	3.000	PC																																																																														
VM2505B1	MM PLUS INTERNAL GLASS SUPPORT	3.000	PC																																																																														



COMPONENT			SPARE PART																																															
Code	Description	Image	Code	Description	Kit components																																													
OB1109A	XEVC-0511-E RIGHT INT DOOR COLUMN		KDR1325A	0511 ZERO RIGHT -M EXTERNAL DOOR	<table border="1"> <thead> <tr> <th>Code</th> <th>Description</th> <th>Qty</th> <th>UOM</th> </tr> </thead> <tbody> <tr> <td>VP1080A0</td> <td>UPPER HINGE CAP FOR LOWER INNER GLASS</td> <td>1.000</td> <td>PC</td> </tr> <tr> <td>VP1081A0</td> <td>UPPER HINGE CAP FOR UPPER INNER GLASS</td> <td>1.000</td> <td>PC</td> </tr> <tr> <td>VT1276A0</td> <td>XEVC-0511-E DOOR EXTERNAL GLASS</td> <td>1.000</td> <td>PC</td> </tr> </tbody> </table>	Code	Description	Qty	UOM	VP1080A0	UPPER HINGE CAP FOR LOWER INNER GLASS	1.000	PC	VP1081A0	UPPER HINGE CAP FOR UPPER INNER GLASS	1.000	PC	VT1276A0	XEVC-0511-E DOOR EXTERNAL GLASS	1.000	PC																													
			Code	Description	Qty	UOM																																												
VP1080A0	UPPER HINGE CAP FOR LOWER INNER GLASS	1.000	PC																																															
VP1081A0	UPPER HINGE CAP FOR UPPER INNER GLASS	1.000	PC																																															
VT1276A0	XEVC-0511-E DOOR EXTERNAL GLASS	1.000	PC																																															
KDR1269B	BT-04 -M EXTERNAL RIGHT DOOR	<table border="1"> <thead> <tr> <th>Code</th> <th>Description</th> <th>Qty</th> <th>UOM</th> </tr> </thead> <tbody> <tr> <td>OB1107A1</td> <td>XEVC-0511-E LEFT INT DOOR COLUM</td> <td>1.000</td> <td>PC</td> </tr> <tr> <td>OB1108B1</td> <td>XEVC-0511 DOOR EXTERNAL RIGHT COLUM</td> <td>1.000</td> <td>PC</td> </tr> <tr> <td>OB1109A1</td> <td>XEVC-0511-E RIGHT INT DOOR COLUM</td> <td>1.000</td> <td>PC</td> </tr> <tr> <td>OB1126B0</td> <td>MM BT DOOR LOWER CROSS BAR</td> <td>1.000</td> <td>PC</td> </tr> <tr> <td>OB1166A1</td> <td>XEVC-0511-E EXT GLASS SUPPORT PROFILE</td> <td>2.000</td> <td>PC</td> </tr> <tr> <td>OB1174A0</td> <td>XEBC-04EU-E LEFT EXT DOOR COLUM</td> <td>1.000</td> <td>PC</td> </tr> <tr> <td>OB1218B0</td> <td>MM BT DOUBLE GLASS DOOR UPPER CROSS BAR</td> <td>1.000</td> <td>PC</td> </tr> <tr> <td>OB1219A1</td> <td>MM DOUBLE GLASS DOOR INT UPPER BEAM 860</td> <td>1.000</td> <td>PC</td> </tr> <tr> <td>CE1052A1</td> <td>CABLE CONNECTION CONTROL - USB MM 750m</td> <td>1.000</td> <td>PC</td> </tr> <tr> <td>CE1053B0</td> <td>MM MICROFIT LED BAR POWER SUPPLY CABL</td> <td>1.000</td> <td>PC</td> </tr> <tr> <td>CE1097A0</td> <td>4M SIHF 4 POLES MICROFIT CANBUS</td> <td>1.000</td> <td>PC</td> </tr> </tbody> </table>	Code	Description	Qty	UOM	OB1107A1	XEVC-0511-E LEFT INT DOOR COLUM	1.000	PC	OB1108B1	XEVC-0511 DOOR EXTERNAL RIGHT COLUM	1.000	PC	OB1109A1	XEVC-0511-E RIGHT INT DOOR COLUM	1.000	PC	OB1126B0	MM BT DOOR LOWER CROSS BAR	1.000	PC	OB1166A1	XEVC-0511-E EXT GLASS SUPPORT PROFILE	2.000	PC	OB1174A0	XEBC-04EU-E LEFT EXT DOOR COLUM	1.000	PC	OB1218B0	MM BT DOUBLE GLASS DOOR UPPER CROSS BAR	1.000	PC	OB1219A1	MM DOUBLE GLASS DOOR INT UPPER BEAM 860	1.000	PC	CE1052A1	CABLE CONNECTION CONTROL - USB MM 750m	1.000	PC	CE1053B0	MM MICROFIT LED BAR POWER SUPPLY CABL	1.000	PC	CE1097A0	4M SIHF 4 POLES MICROFIT CANBUS	1.000	PC
Code	Description	Qty	UOM																																															
OB1107A1	XEVC-0511-E LEFT INT DOOR COLUM	1.000	PC																																															
OB1108B1	XEVC-0511 DOOR EXTERNAL RIGHT COLUM	1.000	PC																																															
OB1109A1	XEVC-0511-E RIGHT INT DOOR COLUM	1.000	PC																																															
OB1126B0	MM BT DOOR LOWER CROSS BAR	1.000	PC																																															
OB1166A1	XEVC-0511-E EXT GLASS SUPPORT PROFILE	2.000	PC																																															
OB1174A0	XEBC-04EU-E LEFT EXT DOOR COLUM	1.000	PC																																															
OB1218B0	MM BT DOUBLE GLASS DOOR UPPER CROSS BAR	1.000	PC																																															
OB1219A1	MM DOUBLE GLASS DOOR INT UPPER BEAM 860	1.000	PC																																															
CE1052A1	CABLE CONNECTION CONTROL - USB MM 750m	1.000	PC																																															
CE1053B0	MM MICROFIT LED BAR POWER SUPPLY CABL	1.000	PC																																															
CE1097A0	4M SIHF 4 POLES MICROFIT CANBUS	1.000	PC																																															



COMPONENT			SPARE PART																																																																						
Code	Description	Image	Code	Description	Kit components																																																																				
OB1109A	XEVC-0511-E RIGHT INT DOOR COLUMN		KDR1269B	BT-04 -M EXTERNAL RIGHT DOOR	<table border="1"> <thead> <tr> <th>Code</th> <th>Description</th> <th>Qty</th> <th>UOM</th> </tr> </thead> <tbody> <tr> <td>CE1285A0</td> <td>EMI ROUND FERRITE MOD.26438015 02</td> <td>2.000</td> <td>PC</td> </tr> <tr> <td>LP1019A0</td> <td>6 SERIES L200 LED LIGHT BAR - E415</td> <td>1.000</td> <td>PC</td> </tr> <tr> <td>LP1025A0</td> <td>L=415 LED LIGHT BAR COVER</td> <td>1.000</td> <td>PC</td> </tr> <tr> <td>MG1099A1</td> <td>MM COMPLETE HANDLE</td> <td>1.000</td> <td>PC</td> </tr> <tr> <td>RC1200A0</td> <td>ED=4 WIRE D.=0.5 COMPRESSIO N SPRING</td> <td>4.000</td> <td>PC</td> </tr> <tr> <td>SL1170A1</td> <td>S57 BLACK SILICON - 310ml CARTRIDGE</td> <td>35.000</td> <td>ML</td> </tr> <tr> <td>SL1222A0</td> <td>0511 EXTERNAL GLASS LATERAL SILICONE</td> <td>4.000</td> <td>PC</td> </tr> <tr> <td>SL1229A0</td> <td>BAKER EXTERNAL GLASS UPPER SILICONE</td> <td>1.000</td> <td>PC</td> </tr> <tr> <td>VE1030A1</td> <td>MAGNET FOR DOOR MICROSWITC H D=22,9mm</td> <td>2.000</td> <td>PC</td> </tr> <tr> <td>VI0239A1</td> <td>SELF-TAPPIN G SCREW 4.2X25 TCB+ INOX</td> <td>4.000</td> <td>PC</td> </tr> <tr> <td>VI1074A0</td> <td>4X16 SCREW FOR PLASTIC</td> <td>2.000</td> <td>PC</td> </tr> <tr> <td>VI1103A0</td> <td>40X12 TBSP SCREW FOR PLASTIC</td> <td>4.000</td> <td>PC</td> </tr> <tr> <td>VI1220A1</td> <td>4,2x12 TCB SELF-TAPPIN G SCREW</td> <td>28.000</td> <td>PC</td> </tr> <tr> <td>VI1930A1</td> <td>ST. STEEL 5X20 CHIP SCREW</td> <td>16.000</td> <td>PC</td> </tr> <tr> <td>VI1996A0</td> <td>M5x35 SCREW</td> <td>13.000</td> <td>PC</td> </tr> <tr> <td>VI2037A1</td> <td>40X8 TORX SHEETTRACS SELF-THREAD SCREW</td> <td>6.000</td> <td>PC</td> </tr> </tbody> </table>	Code	Description	Qty	UOM	CE1285A0	EMI ROUND FERRITE MOD.26438015 02	2.000	PC	LP1019A0	6 SERIES L200 LED LIGHT BAR - E415	1.000	PC	LP1025A0	L=415 LED LIGHT BAR COVER	1.000	PC	MG1099A1	MM COMPLETE HANDLE	1.000	PC	RC1200A0	ED=4 WIRE D.=0.5 COMPRESSIO N SPRING	4.000	PC	SL1170A1	S57 BLACK SILICON - 310ml CARTRIDGE	35.000	ML	SL1222A0	0511 EXTERNAL GLASS LATERAL SILICONE	4.000	PC	SL1229A0	BAKER EXTERNAL GLASS UPPER SILICONE	1.000	PC	VE1030A1	MAGNET FOR DOOR MICROSWITC H D=22,9mm	2.000	PC	VI0239A1	SELF-TAPPIN G SCREW 4.2X25 TCB+ INOX	4.000	PC	VI1074A0	4X16 SCREW FOR PLASTIC	2.000	PC	VI1103A0	40X12 TBSP SCREW FOR PLASTIC	4.000	PC	VI1220A1	4,2x12 TCB SELF-TAPPIN G SCREW	28.000	PC	VI1930A1	ST. STEEL 5X20 CHIP SCREW	16.000	PC	VI1996A0	M5x35 SCREW	13.000	PC	VI2037A1	40X8 TORX SHEETTRACS SELF-THREAD SCREW	6.000	PC
					Code	Description	Qty	UOM																																																																	
					CE1285A0	EMI ROUND FERRITE MOD.26438015 02	2.000	PC																																																																	
					LP1019A0	6 SERIES L200 LED LIGHT BAR - E415	1.000	PC																																																																	
					LP1025A0	L=415 LED LIGHT BAR COVER	1.000	PC																																																																	
					MG1099A1	MM COMPLETE HANDLE	1.000	PC																																																																	
					RC1200A0	ED=4 WIRE D.=0.5 COMPRESSIO N SPRING	4.000	PC																																																																	
					SL1170A1	S57 BLACK SILICON - 310ml CARTRIDGE	35.000	ML																																																																	
					SL1222A0	0511 EXTERNAL GLASS LATERAL SILICONE	4.000	PC																																																																	
					SL1229A0	BAKER EXTERNAL GLASS UPPER SILICONE	1.000	PC																																																																	
					VE1030A1	MAGNET FOR DOOR MICROSWITC H D=22,9mm	2.000	PC																																																																	
					VI0239A1	SELF-TAPPIN G SCREW 4.2X25 TCB+ INOX	4.000	PC																																																																	
					VI1074A0	4X16 SCREW FOR PLASTIC	2.000	PC																																																																	
					VI1103A0	40X12 TBSP SCREW FOR PLASTIC	4.000	PC																																																																	
					VI1220A1	4,2x12 TCB SELF-TAPPIN G SCREW	28.000	PC																																																																	
VI1930A1	ST. STEEL 5X20 CHIP SCREW	16.000	PC																																																																						
VI1996A0	M5x35 SCREW	13.000	PC																																																																						
VI2037A1	40X8 TORX SHEETTRACS SELF-THREAD SCREW	6.000	PC																																																																						



COMPONENT			SPARE PART																																																																														
Code	Description	Image	Code	Description	Kit components																																																																												
OB1109A	XEVC-0511-E RIGHT INT DOOR COLUMN		KDR1269B	BT-04 -M EXTERNAL RIGHT DOOR	<table border="1"> <thead> <tr> <th>Code</th> <th>Description</th> <th>Qty</th> <th>UOM</th> </tr> </thead> <tbody> <tr> <td>VM1490A0</td> <td>CHEFTOP/BAK ERTOP HANDLE SCREWS COVER</td> <td>2.000</td> <td>PC</td> </tr> <tr> <td>VM1630A1</td> <td>INTERNAL GLASS PUSHING CAP</td> <td>3.000</td> <td>PC</td> </tr> <tr> <td>VM1631A0</td> <td>PLUS INNER GLASS PUSHING CAP</td> <td>3.000</td> <td>PC</td> </tr> <tr> <td>VM2259B0</td> <td>VM2259B0</td> <td>1.000</td> <td>PC</td> </tr> <tr> <td>VM2260B0</td> <td>S6 LEFT UPPER CAP</td> <td>1.000</td> <td>PC</td> </tr> <tr> <td>VM2261B0</td> <td>MM -M DOOR RIGHT LOWER CAP</td> <td>1.000</td> <td>PC</td> </tr> <tr> <td>VM2262B0</td> <td>MM -M DOOR RIGHT UPPER CAP</td> <td>1.000</td> <td>PC</td> </tr> <tr> <td>VM2267A0</td> <td>INTERNAL GLASS LOCKING SYSTEM SLIDER</td> <td>2.000</td> <td>PC</td> </tr> <tr> <td>VM2268A0</td> <td>DOOR MAGNET COVER</td> <td>2.000</td> <td>PC</td> </tr> <tr> <td>VM2269B0</td> <td>INNER GLASS FIXING CAP</td> <td>2.000</td> <td>PC</td> </tr> <tr> <td>VM2274A0</td> <td>GROOVED BUSHING</td> <td>1.000</td> <td>PC</td> </tr> <tr> <td>VM2275A0</td> <td>SMOOTH BUSHING</td> <td>1.000</td> <td>PC</td> </tr> <tr> <td>VM2285B0</td> <td>860 SERIES DRIP PROFILE KIT</td> <td>1.000</td> <td>PC</td> </tr> <tr> <td>VM2305A0</td> <td>6 SERIES DOOR CAP FIXING PAWL</td> <td>14.000</td> <td>PC</td> </tr> <tr> <td>VM2312A0</td> <td>6 S. DRIP PROFILE DRAIN LEFT PIPE</td> <td>1.000</td> <td>PC</td> </tr> <tr> <td>VM2314A0</td> <td>6 S. DRIP PROFILE CAP</td> <td>1.000</td> <td>PC</td> </tr> <tr> <td>VM2315B0</td> <td>S6 INTERNAL GLASS SUPPORT</td> <td>3.000</td> <td>PC</td> </tr> <tr> <td>VM2505B1</td> <td>MM PLUS INTERNAL GLASS SUPPORT</td> <td>3.000</td> <td>PC</td> </tr> </tbody> </table>	Code	Description	Qty	UOM	VM1490A0	CHEFTOP/BAK ERTOP HANDLE SCREWS COVER	2.000	PC	VM1630A1	INTERNAL GLASS PUSHING CAP	3.000	PC	VM1631A0	PLUS INNER GLASS PUSHING CAP	3.000	PC	VM2259B0	VM2259B0	1.000	PC	VM2260B0	S6 LEFT UPPER CAP	1.000	PC	VM2261B0	MM -M DOOR RIGHT LOWER CAP	1.000	PC	VM2262B0	MM -M DOOR RIGHT UPPER CAP	1.000	PC	VM2267A0	INTERNAL GLASS LOCKING SYSTEM SLIDER	2.000	PC	VM2268A0	DOOR MAGNET COVER	2.000	PC	VM2269B0	INNER GLASS FIXING CAP	2.000	PC	VM2274A0	GROOVED BUSHING	1.000	PC	VM2275A0	SMOOTH BUSHING	1.000	PC	VM2285B0	860 SERIES DRIP PROFILE KIT	1.000	PC	VM2305A0	6 SERIES DOOR CAP FIXING PAWL	14.000	PC	VM2312A0	6 S. DRIP PROFILE DRAIN LEFT PIPE	1.000	PC	VM2314A0	6 S. DRIP PROFILE CAP	1.000	PC	VM2315B0	S6 INTERNAL GLASS SUPPORT	3.000	PC	VM2505B1	MM PLUS INTERNAL GLASS SUPPORT	3.000	PC
Code	Description	Qty	UOM																																																																														
VM1490A0	CHEFTOP/BAK ERTOP HANDLE SCREWS COVER	2.000	PC																																																																														
VM1630A1	INTERNAL GLASS PUSHING CAP	3.000	PC																																																																														
VM1631A0	PLUS INNER GLASS PUSHING CAP	3.000	PC																																																																														
VM2259B0	VM2259B0	1.000	PC																																																																														
VM2260B0	S6 LEFT UPPER CAP	1.000	PC																																																																														
VM2261B0	MM -M DOOR RIGHT LOWER CAP	1.000	PC																																																																														
VM2262B0	MM -M DOOR RIGHT UPPER CAP	1.000	PC																																																																														
VM2267A0	INTERNAL GLASS LOCKING SYSTEM SLIDER	2.000	PC																																																																														
VM2268A0	DOOR MAGNET COVER	2.000	PC																																																																														
VM2269B0	INNER GLASS FIXING CAP	2.000	PC																																																																														
VM2274A0	GROOVED BUSHING	1.000	PC																																																																														
VM2275A0	SMOOTH BUSHING	1.000	PC																																																																														
VM2285B0	860 SERIES DRIP PROFILE KIT	1.000	PC																																																																														
VM2305A0	6 SERIES DOOR CAP FIXING PAWL	14.000	PC																																																																														
VM2312A0	6 S. DRIP PROFILE DRAIN LEFT PIPE	1.000	PC																																																																														
VM2314A0	6 S. DRIP PROFILE CAP	1.000	PC																																																																														
VM2315B0	S6 INTERNAL GLASS SUPPORT	3.000	PC																																																																														
VM2505B1	MM PLUS INTERNAL GLASS SUPPORT	3.000	PC																																																																														



COMPONENT			SPARE PART																																							
Code	Description	Image	Code	Description	Kit components																																					
0B1109A	XEVC-0511-E RIGHT INT DOOR COLUMN		KDR1269B	BT-04 -M EXTERNAL RIGHT DOOR	<table border="1"> <thead> <tr> <th>Code</th> <th>Description</th> <th>Qty</th> <th>UOM</th> </tr> </thead> <tbody> <tr> <td>VM2518A0</td> <td>BOARD COOLING FAN SUPPORT</td> <td>1.000</td> <td>PC</td> </tr> <tr> <td>VN1179A1</td> <td>CONTROL BOARD 40x40x20mm 12V COOLING FAN</td> <td>1.000</td> <td>PC</td> </tr> <tr> <td>VP1080A0</td> <td>UPPER HINGE CAP FOR LOWER INNER GLASS</td> <td>1.000</td> <td>PC</td> </tr> <tr> <td>VP1081A0</td> <td>UPPER HINGE CAP FOR UPPER INNER GLASS</td> <td>1.000</td> <td>PC</td> </tr> <tr> <td>VT1290A0</td> <td>EXTERNAL GLASS XEBC-04EU-E</td> <td>1.000</td> <td>PC</td> </tr> </tbody> </table>	Code	Description	Qty	UOM	VM2518A0	BOARD COOLING FAN SUPPORT	1.000	PC	VN1179A1	CONTROL BOARD 40x40x20mm 12V COOLING FAN	1.000	PC	VP1080A0	UPPER HINGE CAP FOR LOWER INNER GLASS	1.000	PC	VP1081A0	UPPER HINGE CAP FOR UPPER INNER GLASS	1.000	PC	VT1290A0	EXTERNAL GLASS XEBC-04EU-E	1.000	PC													
			Code	Description	Qty	UOM																																				
VM2518A0	BOARD COOLING FAN SUPPORT	1.000	PC																																							
VN1179A1	CONTROL BOARD 40x40x20mm 12V COOLING FAN	1.000	PC																																							
VP1080A0	UPPER HINGE CAP FOR LOWER INNER GLASS	1.000	PC																																							
VP1081A0	UPPER HINGE CAP FOR UPPER INNER GLASS	1.000	PC																																							
VT1290A0	EXTERNAL GLASS XEBC-04EU-E	1.000	PC																																							
KDR1269A	BT-04 EXTERNAL RIGHT DOOR	<table border="1"> <thead> <tr> <th>Code</th> <th>Description</th> <th>Qty</th> <th>UOM</th> </tr> </thead> <tbody> <tr> <td>0B1107A1</td> <td>XEVC-0511-E LEFT INT DOOR COLUM</td> <td>1.000</td> <td>PC</td> </tr> <tr> <td>0B1108B1</td> <td>XEVC-0511 DOOR EXTERNAL RIGHT COLUM</td> <td>1.000</td> <td>PC</td> </tr> <tr> <td>0B1109A1</td> <td>XEVC-0511-E RIGHT INT DOOR COLUM</td> <td>1.000</td> <td>PC</td> </tr> <tr> <td>0B1126A1</td> <td>MM BT DOOR LOWER CROSS BAR</td> <td>1.000</td> <td>PC</td> </tr> <tr> <td>0B1166A1</td> <td>XEVC-0511-E EXT GLASS SUPPORT PROFILE</td> <td>2.000</td> <td>PC</td> </tr> <tr> <td>0B1174A0</td> <td>XEBC-04EU-E LEFT EXT DOOR COLUM</td> <td>1.000</td> <td>PC</td> </tr> <tr> <td>0B1218A1</td> <td>MM BT DOUBLE GLASS DOOR UPPER CROSS BAR</td> <td>1.000</td> <td>PC</td> </tr> <tr> <td>0B1219A1</td> <td>MM DOUBLE GLASS DOOR INT UPPER BEAM 860</td> <td>1.000</td> <td>PC</td> </tr> <tr> <td>CE1052A1</td> <td>CABLE CONNECTION CONTROL - USB MM 750m</td> <td>1.000</td> <td>PC</td> </tr> </tbody> </table>	Code	Description	Qty	UOM	0B1107A1	XEVC-0511-E LEFT INT DOOR COLUM	1.000	PC	0B1108B1	XEVC-0511 DOOR EXTERNAL RIGHT COLUM	1.000	PC	0B1109A1	XEVC-0511-E RIGHT INT DOOR COLUM	1.000	PC	0B1126A1	MM BT DOOR LOWER CROSS BAR	1.000	PC	0B1166A1	XEVC-0511-E EXT GLASS SUPPORT PROFILE	2.000	PC	0B1174A0	XEBC-04EU-E LEFT EXT DOOR COLUM	1.000	PC	0B1218A1	MM BT DOUBLE GLASS DOOR UPPER CROSS BAR	1.000	PC	0B1219A1	MM DOUBLE GLASS DOOR INT UPPER BEAM 860	1.000	PC	CE1052A1	CABLE CONNECTION CONTROL - USB MM 750m	1.000	PC
Code	Description	Qty	UOM																																							
0B1107A1	XEVC-0511-E LEFT INT DOOR COLUM	1.000	PC																																							
0B1108B1	XEVC-0511 DOOR EXTERNAL RIGHT COLUM	1.000	PC																																							
0B1109A1	XEVC-0511-E RIGHT INT DOOR COLUM	1.000	PC																																							
0B1126A1	MM BT DOOR LOWER CROSS BAR	1.000	PC																																							
0B1166A1	XEVC-0511-E EXT GLASS SUPPORT PROFILE	2.000	PC																																							
0B1174A0	XEBC-04EU-E LEFT EXT DOOR COLUM	1.000	PC																																							
0B1218A1	MM BT DOUBLE GLASS DOOR UPPER CROSS BAR	1.000	PC																																							
0B1219A1	MM DOUBLE GLASS DOOR INT UPPER BEAM 860	1.000	PC																																							
CE1052A1	CABLE CONNECTION CONTROL - USB MM 750m	1.000	PC																																							



COMPONENT			SPARE PART																																																																						
Code	Description	Image	Code	Description	Kit components																																																																				
OB1109A	XEVC-0511-E RIGHT INT DOOR COLUMN		KDR1269A	BT-04 EXTERNAL RIGHT DOOR	<table border="1"> <thead> <tr> <th>Code</th> <th>Description</th> <th>Qty</th> <th>UOM</th> </tr> </thead> <tbody> <tr> <td>CE1053B0</td> <td>MM MICROFIT LED BAR POWER SUPPLY CABL</td> <td>1.000</td> <td>PC</td> </tr> <tr> <td>CE1285A0</td> <td>EMI ROUND FERRITE MOD.26438015 02</td> <td>1.000</td> <td>PC</td> </tr> <tr> <td>CE1290A0</td> <td>EXTRACTABL E FEMALE TERMINAL CPF 5/4</td> <td>1.000</td> <td>PC</td> </tr> <tr> <td>CE1310A1</td> <td>POWER - CONTROL BOARD CONNECTING CABLE</td> <td>1.000</td> <td>PC</td> </tr> <tr> <td>LP1019A0</td> <td>6 SERIES L200 LED LIGHT BAR - E415</td> <td>1.000</td> <td>PC</td> </tr> <tr> <td>LP1025A0</td> <td>L=415 LED LIGHT BAR COVER</td> <td>1.000</td> <td>PC</td> </tr> <tr> <td>MG1083A2</td> <td>MM COMPLETE HANDLE</td> <td>1.000</td> <td>PC</td> </tr> <tr> <td>SL1170A1</td> <td>S57 BLACK SILICON - 310ml CARTRIDGE</td> <td>30.000</td> <td>ML</td> </tr> <tr> <td>VE1030A1</td> <td>MAGNET FOR DOOR MICROSWITC H D=22,9mm</td> <td>2.000</td> <td>PC</td> </tr> <tr> <td>VH1147A0</td> <td>5X25 STAINLESS STEEL SCREW</td> <td>16.000</td> <td>PC</td> </tr> <tr> <td>VH1220A1</td> <td>4,2x12 TCB SELF-TAPPIN G SCREW</td> <td>25.000</td> <td>PC</td> </tr> <tr> <td>VH1996A0</td> <td>M5x35 SCREW</td> <td>13.000</td> <td>PC</td> </tr> <tr> <td>VM1630A1</td> <td>INTERNAL GLASS PUSHING CAP</td> <td>3.000</td> <td>PC</td> </tr> <tr> <td>VM1631A0</td> <td>PLUS INNER GLASS PUSHING CAP</td> <td>2.000</td> <td>PC</td> </tr> <tr> <td>VM2259A1</td> <td>6 SERIES DOOR LOWER LEFT CAP</td> <td>1.000</td> <td>PC</td> </tr> <tr> <td>VM2260A1</td> <td>6 SERIES DOOR UPPER LEFT CAP</td> <td>1.000</td> <td>PC</td> </tr> </tbody> </table>	Code	Description	Qty	UOM	CE1053B0	MM MICROFIT LED BAR POWER SUPPLY CABL	1.000	PC	CE1285A0	EMI ROUND FERRITE MOD.26438015 02	1.000	PC	CE1290A0	EXTRACTABL E FEMALE TERMINAL CPF 5/4	1.000	PC	CE1310A1	POWER - CONTROL BOARD CONNECTING CABLE	1.000	PC	LP1019A0	6 SERIES L200 LED LIGHT BAR - E415	1.000	PC	LP1025A0	L=415 LED LIGHT BAR COVER	1.000	PC	MG1083A2	MM COMPLETE HANDLE	1.000	PC	SL1170A1	S57 BLACK SILICON - 310ml CARTRIDGE	30.000	ML	VE1030A1	MAGNET FOR DOOR MICROSWITC H D=22,9mm	2.000	PC	VH1147A0	5X25 STAINLESS STEEL SCREW	16.000	PC	VH1220A1	4,2x12 TCB SELF-TAPPIN G SCREW	25.000	PC	VH1996A0	M5x35 SCREW	13.000	PC	VM1630A1	INTERNAL GLASS PUSHING CAP	3.000	PC	VM1631A0	PLUS INNER GLASS PUSHING CAP	2.000	PC	VM2259A1	6 SERIES DOOR LOWER LEFT CAP	1.000	PC	VM2260A1	6 SERIES DOOR UPPER LEFT CAP	1.000	PC
Code	Description	Qty	UOM																																																																						
CE1053B0	MM MICROFIT LED BAR POWER SUPPLY CABL	1.000	PC																																																																						
CE1285A0	EMI ROUND FERRITE MOD.26438015 02	1.000	PC																																																																						
CE1290A0	EXTRACTABL E FEMALE TERMINAL CPF 5/4	1.000	PC																																																																						
CE1310A1	POWER - CONTROL BOARD CONNECTING CABLE	1.000	PC																																																																						
LP1019A0	6 SERIES L200 LED LIGHT BAR - E415	1.000	PC																																																																						
LP1025A0	L=415 LED LIGHT BAR COVER	1.000	PC																																																																						
MG1083A2	MM COMPLETE HANDLE	1.000	PC																																																																						
SL1170A1	S57 BLACK SILICON - 310ml CARTRIDGE	30.000	ML																																																																						
VE1030A1	MAGNET FOR DOOR MICROSWITC H D=22,9mm	2.000	PC																																																																						
VH1147A0	5X25 STAINLESS STEEL SCREW	16.000	PC																																																																						
VH1220A1	4,2x12 TCB SELF-TAPPIN G SCREW	25.000	PC																																																																						
VH1996A0	M5x35 SCREW	13.000	PC																																																																						
VM1630A1	INTERNAL GLASS PUSHING CAP	3.000	PC																																																																						
VM1631A0	PLUS INNER GLASS PUSHING CAP	2.000	PC																																																																						
VM2259A1	6 SERIES DOOR LOWER LEFT CAP	1.000	PC																																																																						
VM2260A1	6 SERIES DOOR UPPER LEFT CAP	1.000	PC																																																																						



COMPONENT			SPARE PART																																																																										
Code	Description	Image	Code	Description	Kit components																																																																								
OB1109A	XEVC-0511-E RIGHT INT DOOR COLUMN		KDR1269A	BT-04 EXTERNAL RIGHT DOOR	<table border="1"> <thead> <tr> <th>Code</th> <th>Description</th> <th>Qty</th> <th>UOM</th> </tr> </thead> <tbody> <tr> <td>VM2261A1</td> <td>MM DOOR LOWER RIGHT CAP</td> <td>1.000</td> <td>PC</td> </tr> <tr> <td>VM2262A1</td> <td>MM DOOR UPPER RIGHT CAP</td> <td>1.000</td> <td>PC</td> </tr> <tr> <td>VM2267A0</td> <td>INTERNAL GLASS LOCKING SYSTEM SLIDER</td> <td>2.000</td> <td>PC</td> </tr> <tr> <td>VM2268A0</td> <td>DOOR MAGNET COVER</td> <td>2.000</td> <td>PC</td> </tr> <tr> <td>VM2269A0</td> <td>INTERNAL GLASS LOCKING SYSTEM CAP</td> <td>2.000</td> <td>PC</td> </tr> <tr> <td>VM2274A0</td> <td>GROOVED BUSHING</td> <td>1.000</td> <td>PC</td> </tr> <tr> <td>VM2275A0</td> <td>SMOOTH BUSHING</td> <td>1.000</td> <td>PC</td> </tr> <tr> <td>VM2285A0</td> <td>860 SERIES DRIP PROFILE</td> <td>1.000</td> <td>PC</td> </tr> <tr> <td>VM2305A0</td> <td>6 SERIES DOOR CAP FIXING PAWL</td> <td>14.000</td> <td>PC</td> </tr> <tr> <td>VM2312A0</td> <td>6 S. DRIP PROFILE DRAIN LEFT PIPE</td> <td>1.000</td> <td>PC</td> </tr> <tr> <td>VM2313A0</td> <td>TUBE DX DISCHARGE DRIP MM</td> <td>1.000</td> <td>PC</td> </tr> <tr> <td>VM2314A0</td> <td>6 S. DRIP PROFILE CAP</td> <td>1.000</td> <td>PC</td> </tr> <tr> <td>VM2315A0</td> <td>MIND.Maps INTERNAL GLASS CAP SUPPORT</td> <td>3.000</td> <td>PC</td> </tr> <tr> <td>VM2505A0</td> <td>MM PLUS INTERNAL GLASS SUPPORT</td> <td>2.000</td> <td>PC</td> </tr> <tr> <td>VM2518A0</td> <td>BOARD COOLING FAN SUPPORT</td> <td>1.000</td> <td>PC</td> </tr> <tr> <td>VN1179A1</td> <td>CONTROL BOARD 40x40x20mm 12V COOLING FAN</td> <td>1.000</td> <td>PC</td> </tr> <tr> <td>VT1290A0</td> <td>EXTERNAL GLASS XEBC-04EU-E</td> <td>1.000</td> <td>PC</td> </tr> </tbody> </table>	Code	Description	Qty	UOM	VM2261A1	MM DOOR LOWER RIGHT CAP	1.000	PC	VM2262A1	MM DOOR UPPER RIGHT CAP	1.000	PC	VM2267A0	INTERNAL GLASS LOCKING SYSTEM SLIDER	2.000	PC	VM2268A0	DOOR MAGNET COVER	2.000	PC	VM2269A0	INTERNAL GLASS LOCKING SYSTEM CAP	2.000	PC	VM2274A0	GROOVED BUSHING	1.000	PC	VM2275A0	SMOOTH BUSHING	1.000	PC	VM2285A0	860 SERIES DRIP PROFILE	1.000	PC	VM2305A0	6 SERIES DOOR CAP FIXING PAWL	14.000	PC	VM2312A0	6 S. DRIP PROFILE DRAIN LEFT PIPE	1.000	PC	VM2313A0	TUBE DX DISCHARGE DRIP MM	1.000	PC	VM2314A0	6 S. DRIP PROFILE CAP	1.000	PC	VM2315A0	MIND.Maps INTERNAL GLASS CAP SUPPORT	3.000	PC	VM2505A0	MM PLUS INTERNAL GLASS SUPPORT	2.000	PC	VM2518A0	BOARD COOLING FAN SUPPORT	1.000	PC	VN1179A1	CONTROL BOARD 40x40x20mm 12V COOLING FAN	1.000	PC	VT1290A0	EXTERNAL GLASS XEBC-04EU-E	1.000	PC
					Code	Description	Qty	UOM																																																																					
					VM2261A1	MM DOOR LOWER RIGHT CAP	1.000	PC																																																																					
					VM2262A1	MM DOOR UPPER RIGHT CAP	1.000	PC																																																																					
					VM2267A0	INTERNAL GLASS LOCKING SYSTEM SLIDER	2.000	PC																																																																					
					VM2268A0	DOOR MAGNET COVER	2.000	PC																																																																					
					VM2269A0	INTERNAL GLASS LOCKING SYSTEM CAP	2.000	PC																																																																					
					VM2274A0	GROOVED BUSHING	1.000	PC																																																																					
					VM2275A0	SMOOTH BUSHING	1.000	PC																																																																					
					VM2285A0	860 SERIES DRIP PROFILE	1.000	PC																																																																					
					VM2305A0	6 SERIES DOOR CAP FIXING PAWL	14.000	PC																																																																					
					VM2312A0	6 S. DRIP PROFILE DRAIN LEFT PIPE	1.000	PC																																																																					
					VM2313A0	TUBE DX DISCHARGE DRIP MM	1.000	PC																																																																					
					VM2314A0	6 S. DRIP PROFILE CAP	1.000	PC																																																																					
					VM2315A0	MIND.Maps INTERNAL GLASS CAP SUPPORT	3.000	PC																																																																					
					VM2505A0	MM PLUS INTERNAL GLASS SUPPORT	2.000	PC																																																																					
					VM2518A0	BOARD COOLING FAN SUPPORT	1.000	PC																																																																					
VN1179A1	CONTROL BOARD 40x40x20mm 12V COOLING FAN	1.000	PC																																																																										
VT1290A0	EXTERNAL GLASS XEBC-04EU-E	1.000	PC																																																																										



COMPONENT			SPARE PART																																																																		
Code	Description	Image	Code	Description	Kit components																																																																
OB1109A	XEVC-0511-E RIGHT INT DOOR COLUMN		KDR1261B	0511 -M RIGHT EXTERNAL DOOR	<table border="1"> <thead> <tr> <th>Code</th> <th>Description</th> <th>Qty</th> <th>UOM</th> </tr> </thead> <tbody> <tr> <td>OB1106A0</td> <td>XEVC-0511-E DOOR EXTERNAL LEFT COLUMN</td> <td>1.000</td> <td>PC</td> </tr> <tr> <td>OB1107A1</td> <td>XEVC-0511-E LEFT INT DOOR COLUM</td> <td>1.000</td> <td>PC</td> </tr> <tr> <td>OB1108B1</td> <td>XEVC-0511 DOOR EXTERNAL RIGHT COLUM</td> <td>1.000</td> <td>PC</td> </tr> <tr> <td>OB1109A1</td> <td>XEVC-0511-E RIGHT INT DOOR COLUM</td> <td>1.000</td> <td>PC</td> </tr> <tr> <td>OB1122B0</td> <td>MM CT DOOR LOWER CROSS BAR</td> <td>1.000</td> <td>PC</td> </tr> <tr> <td>OB1166A1</td> <td>XEVC-0511-E EXT GLASS SUPPORT PROFILE</td> <td>2.000</td> <td>PC</td> </tr> <tr> <td>OB1216B0</td> <td>MM CT DOUBLE GLASS DOOR UPPER CROSS BAR</td> <td>1.000</td> <td>PC</td> </tr> <tr> <td>OB1217A1</td> <td>MM DOUBLE GLASS DOOR INT UPPER BEAM 750</td> <td>1.000</td> <td>PC</td> </tr> <tr> <td>CE1052A1</td> <td>CABLE CONNECTION CONTROL - USB MM 750m</td> <td>1.000</td> <td>PC</td> </tr> <tr> <td>CE1053B0</td> <td>MM MICROFIT LED BAR POWER SUPPLY CABL</td> <td>1.000</td> <td>PC</td> </tr> <tr> <td>CE1096A0</td> <td>4 POLES MICROFIT 3 M BUS CABLE</td> <td>1.000</td> <td>PC</td> </tr> <tr> <td>CE1285A0</td> <td>EMI ROUND FERRITE MOD.26438015 02</td> <td>2.000</td> <td>PC</td> </tr> <tr> <td>GN1525A0</td> <td>O-RING INT DIAM 9,5 THK 1 NBR 70</td> <td>1.000</td> <td>PC</td> </tr> <tr> <td>LP1019A0</td> <td>6 SERIES L200 LED LIGHT BAR - E415</td> <td>1.000</td> <td>PC</td> </tr> <tr> <td>LP1025A0</td> <td>L=415 LED LIGHT BAR COVER</td> <td>1.000</td> <td>PC</td> </tr> </tbody> </table>	Code	Description	Qty	UOM	OB1106A0	XEVC-0511-E DOOR EXTERNAL LEFT COLUMN	1.000	PC	OB1107A1	XEVC-0511-E LEFT INT DOOR COLUM	1.000	PC	OB1108B1	XEVC-0511 DOOR EXTERNAL RIGHT COLUM	1.000	PC	OB1109A1	XEVC-0511-E RIGHT INT DOOR COLUM	1.000	PC	OB1122B0	MM CT DOOR LOWER CROSS BAR	1.000	PC	OB1166A1	XEVC-0511-E EXT GLASS SUPPORT PROFILE	2.000	PC	OB1216B0	MM CT DOUBLE GLASS DOOR UPPER CROSS BAR	1.000	PC	OB1217A1	MM DOUBLE GLASS DOOR INT UPPER BEAM 750	1.000	PC	CE1052A1	CABLE CONNECTION CONTROL - USB MM 750m	1.000	PC	CE1053B0	MM MICROFIT LED BAR POWER SUPPLY CABL	1.000	PC	CE1096A0	4 POLES MICROFIT 3 M BUS CABLE	1.000	PC	CE1285A0	EMI ROUND FERRITE MOD.26438015 02	2.000	PC	GN1525A0	O-RING INT DIAM 9,5 THK 1 NBR 70	1.000	PC	LP1019A0	6 SERIES L200 LED LIGHT BAR - E415	1.000	PC	LP1025A0	L=415 LED LIGHT BAR COVER	1.000	PC
Code	Description	Qty	UOM																																																																		
OB1106A0	XEVC-0511-E DOOR EXTERNAL LEFT COLUMN	1.000	PC																																																																		
OB1107A1	XEVC-0511-E LEFT INT DOOR COLUM	1.000	PC																																																																		
OB1108B1	XEVC-0511 DOOR EXTERNAL RIGHT COLUM	1.000	PC																																																																		
OB1109A1	XEVC-0511-E RIGHT INT DOOR COLUM	1.000	PC																																																																		
OB1122B0	MM CT DOOR LOWER CROSS BAR	1.000	PC																																																																		
OB1166A1	XEVC-0511-E EXT GLASS SUPPORT PROFILE	2.000	PC																																																																		
OB1216B0	MM CT DOUBLE GLASS DOOR UPPER CROSS BAR	1.000	PC																																																																		
OB1217A1	MM DOUBLE GLASS DOOR INT UPPER BEAM 750	1.000	PC																																																																		
CE1052A1	CABLE CONNECTION CONTROL - USB MM 750m	1.000	PC																																																																		
CE1053B0	MM MICROFIT LED BAR POWER SUPPLY CABL	1.000	PC																																																																		
CE1096A0	4 POLES MICROFIT 3 M BUS CABLE	1.000	PC																																																																		
CE1285A0	EMI ROUND FERRITE MOD.26438015 02	2.000	PC																																																																		
GN1525A0	O-RING INT DIAM 9,5 THK 1 NBR 70	1.000	PC																																																																		
LP1019A0	6 SERIES L200 LED LIGHT BAR - E415	1.000	PC																																																																		
LP1025A0	L=415 LED LIGHT BAR COVER	1.000	PC																																																																		



COMPONENT			SPARE PART																																																																			
Code	Description	Image	Code	Description	Kit components																																																																	
OB1109A	XEVC-0511-E RIGHT INT DOOR COLUMN		KDR1261B	0511 -M RIGHT EXTERNAL DOOR	<table border="1"> <thead> <tr> <th>Code</th> <th>Description</th> <th>Qty</th> <th>UOM</th> </tr> </thead> <tbody> <tr> <td>MG1099A1</td> <td>MM COMPLETE HANDLE</td> <td>1.000</td> <td>PC</td> </tr> <tr> <td>RC1200A0</td> <td>ED=4 WIRE D.=0.5 COMPRESSIO N SPRING</td> <td>4.000</td> <td>PC</td> </tr> <tr> <td>SL1170A1</td> <td>S57 BLACK SILICON - 310ml CARTRIDGE</td> <td>30.000</td> <td>ML</td> </tr> <tr> <td>SL1221A0</td> <td>GN1/1 EXTERNAL GLASS UPPER SILICONE</td> <td>1.000</td> <td>PC</td> </tr> <tr> <td>SL1222A0</td> <td>0511 EXTERNAL GLASS LATERAL SILICONE</td> <td>4.000</td> <td>PC</td> </tr> <tr> <td>VE1030A1</td> <td>MAGNET FOR DOOR MICROSWITC H D=22,9mm</td> <td>2.000</td> <td>PC</td> </tr> <tr> <td>VI0239A1</td> <td>SELF-TAPPIN G SCREW 4,2X25 TCB+ INOX</td> <td>4.000</td> <td>PC</td> </tr> <tr> <td>VI1034A0</td> <td>STAINLESS STEEL WASHER 8,4x16x1</td> <td>1.000</td> <td>PC</td> </tr> <tr> <td>VI1074A0</td> <td>4X16 SCREW FOR PLASTIC</td> <td>2.000</td> <td>PC</td> </tr> <tr> <td>VI1103A0</td> <td>40X12 TBSP SCREW FOR PLASTIC</td> <td>2.000</td> <td>PC</td> </tr> <tr> <td>VI1220A1</td> <td>4,2x12 TCB SELF-TAPPIN G SCREW</td> <td>26.000</td> <td>PC</td> </tr> <tr> <td>VI1930A1</td> <td>ST. STEEL 5X20 CHIP SCREW</td> <td>16.000</td> <td>PC</td> </tr> <tr> <td>VI1996A0</td> <td>M5x35 SCREW</td> <td>13.000</td> <td>PC</td> </tr> <tr> <td>VI2037A1</td> <td>40X8 TORX SHEETTRACS SELF-THREAD SCREW</td> <td>6.000</td> <td>PC</td> </tr> <tr> <td>VM1490A0</td> <td>CHEFTOP/BAK ERTOP HANDLE SCREWS COVER</td> <td>2.000</td> <td>PC</td> </tr> </tbody> </table>	Code	Description	Qty	UOM	MG1099A1	MM COMPLETE HANDLE	1.000	PC	RC1200A0	ED=4 WIRE D.=0.5 COMPRESSIO N SPRING	4.000	PC	SL1170A1	S57 BLACK SILICON - 310ml CARTRIDGE	30.000	ML	SL1221A0	GN1/1 EXTERNAL GLASS UPPER SILICONE	1.000	PC	SL1222A0	0511 EXTERNAL GLASS LATERAL SILICONE	4.000	PC	VE1030A1	MAGNET FOR DOOR MICROSWITC H D=22,9mm	2.000	PC	VI0239A1	SELF-TAPPIN G SCREW 4,2X25 TCB+ INOX	4.000	PC	VI1034A0	STAINLESS STEEL WASHER 8,4x16x1	1.000	PC	VI1074A0	4X16 SCREW FOR PLASTIC	2.000	PC	VI1103A0	40X12 TBSP SCREW FOR PLASTIC	2.000	PC	VI1220A1	4,2x12 TCB SELF-TAPPIN G SCREW	26.000	PC	VI1930A1	ST. STEEL 5X20 CHIP SCREW	16.000	PC	VI1996A0	M5x35 SCREW	13.000	PC	VI2037A1	40X8 TORX SHEETTRACS SELF-THREAD SCREW	6.000	PC	VM1490A0	CHEFTOP/BAK ERTOP HANDLE SCREWS COVER	2.000	PC	
Code	Description	Qty	UOM																																																																			
MG1099A1	MM COMPLETE HANDLE	1.000	PC																																																																			
RC1200A0	ED=4 WIRE D.=0.5 COMPRESSIO N SPRING	4.000	PC																																																																			
SL1170A1	S57 BLACK SILICON - 310ml CARTRIDGE	30.000	ML																																																																			
SL1221A0	GN1/1 EXTERNAL GLASS UPPER SILICONE	1.000	PC																																																																			
SL1222A0	0511 EXTERNAL GLASS LATERAL SILICONE	4.000	PC																																																																			
VE1030A1	MAGNET FOR DOOR MICROSWITC H D=22,9mm	2.000	PC																																																																			
VI0239A1	SELF-TAPPIN G SCREW 4,2X25 TCB+ INOX	4.000	PC																																																																			
VI1034A0	STAINLESS STEEL WASHER 8,4x16x1	1.000	PC																																																																			
VI1074A0	4X16 SCREW FOR PLASTIC	2.000	PC																																																																			
VI1103A0	40X12 TBSP SCREW FOR PLASTIC	2.000	PC																																																																			
VI1220A1	4,2x12 TCB SELF-TAPPIN G SCREW	26.000	PC																																																																			
VI1930A1	ST. STEEL 5X20 CHIP SCREW	16.000	PC																																																																			
VI1996A0	M5x35 SCREW	13.000	PC																																																																			
VI2037A1	40X8 TORX SHEETTRACS SELF-THREAD SCREW	6.000	PC																																																																			
VM1490A0	CHEFTOP/BAK ERTOP HANDLE SCREWS COVER	2.000	PC																																																																			



COMPONENT			SPARE PART																																																																															
Code	Description	Image	Code	Description	Kit components																																																																													
OB1109A	XEVC-0511-E RIGHT INT DOOR COLUMN		KDR1261B	0511 -M RIGHT EXTERNAL DOOR	<table border="1"> <thead> <tr> <th>Code</th> <th>Description</th> <th>Qty</th> <th>UOM</th> </tr> </thead> <tbody> <tr> <td>VM1630A1</td> <td>INTERNAL GLASS PUSHING CAP</td> <td>3.000</td> <td>PC</td> </tr> <tr> <td>VM1631A0</td> <td>PLUS INNER GLASS PUSHING CAP</td> <td>3.000</td> <td>PC</td> </tr> <tr> <td>VM2259B0</td> <td>VM2259B0</td> <td>1.000</td> <td>PC</td> </tr> <tr> <td>VM2260B0</td> <td>S6 LEFT UPPER CAP</td> <td>1.000</td> <td>PC</td> </tr> <tr> <td>VM2261B0</td> <td>MM -M DOOR RIGHT LOWER CAP</td> <td>1.000</td> <td>PC</td> </tr> <tr> <td>VM2262B0</td> <td>MM -M DOOR RIGHT UPPER CAP</td> <td>1.000</td> <td>PC</td> </tr> <tr> <td>VM2267A0</td> <td>INTERNAL GLASS LOCKING SYSTEM SLIDER</td> <td>2.000</td> <td>PC</td> </tr> <tr> <td>VM2268A0</td> <td>DOOR MAGNET COVER</td> <td>2.000</td> <td>PC</td> </tr> <tr> <td>VM2269B0</td> <td>INNER GLASS FIXING CAP</td> <td>2.000</td> <td>PC</td> </tr> <tr> <td>VM2274A0</td> <td>GROOVED BUSHING</td> <td>1.000</td> <td>PC</td> </tr> <tr> <td>VM2275A0</td> <td>SMOOTH BUSHING</td> <td>1.000</td> <td>PC</td> </tr> <tr> <td>VM2284B0</td> <td>750 SERIES DRIP PROFILE KIT</td> <td>1.000</td> <td>PC</td> </tr> <tr> <td>VM2305A0</td> <td>6 SERIES DOOR CAP FIXING PAWL</td> <td>14.000</td> <td>PC</td> </tr> <tr> <td>VM2312A0</td> <td>6 S. DRIP PROFILE DRAIN LEFT PIPE</td> <td>1.000</td> <td>PC</td> </tr> <tr> <td>VM2314A0</td> <td>6 S. DRIP PROFILE CAP</td> <td>1.000</td> <td>PC</td> </tr> <tr> <td>VM2315B0</td> <td>S6 INTERNAL GLASS SUPPORT</td> <td>3.000</td> <td>PC</td> </tr> <tr> <td>VM2505B1</td> <td>MM PLUS INTERNAL GLASS SUPPORT</td> <td>3.000</td> <td>PC</td> </tr> <tr> <td>VP1080A0</td> <td>UPPER HINGE CAP FOR LOWER INNER GLASS</td> <td>1.000</td> <td>PC</td> </tr> </tbody> </table>	Code	Description	Qty	UOM	VM1630A1	INTERNAL GLASS PUSHING CAP	3.000	PC	VM1631A0	PLUS INNER GLASS PUSHING CAP	3.000	PC	VM2259B0	VM2259B0	1.000	PC	VM2260B0	S6 LEFT UPPER CAP	1.000	PC	VM2261B0	MM -M DOOR RIGHT LOWER CAP	1.000	PC	VM2262B0	MM -M DOOR RIGHT UPPER CAP	1.000	PC	VM2267A0	INTERNAL GLASS LOCKING SYSTEM SLIDER	2.000	PC	VM2268A0	DOOR MAGNET COVER	2.000	PC	VM2269B0	INNER GLASS FIXING CAP	2.000	PC	VM2274A0	GROOVED BUSHING	1.000	PC	VM2275A0	SMOOTH BUSHING	1.000	PC	VM2284B0	750 SERIES DRIP PROFILE KIT	1.000	PC	VM2305A0	6 SERIES DOOR CAP FIXING PAWL	14.000	PC	VM2312A0	6 S. DRIP PROFILE DRAIN LEFT PIPE	1.000	PC	VM2314A0	6 S. DRIP PROFILE CAP	1.000	PC	VM2315B0	S6 INTERNAL GLASS SUPPORT	3.000	PC	VM2505B1	MM PLUS INTERNAL GLASS SUPPORT	3.000	PC	VP1080A0	UPPER HINGE CAP FOR LOWER INNER GLASS	1.000	PC	
Code	Description	Qty	UOM																																																																															
VM1630A1	INTERNAL GLASS PUSHING CAP	3.000	PC																																																																															
VM1631A0	PLUS INNER GLASS PUSHING CAP	3.000	PC																																																																															
VM2259B0	VM2259B0	1.000	PC																																																																															
VM2260B0	S6 LEFT UPPER CAP	1.000	PC																																																																															
VM2261B0	MM -M DOOR RIGHT LOWER CAP	1.000	PC																																																																															
VM2262B0	MM -M DOOR RIGHT UPPER CAP	1.000	PC																																																																															
VM2267A0	INTERNAL GLASS LOCKING SYSTEM SLIDER	2.000	PC																																																																															
VM2268A0	DOOR MAGNET COVER	2.000	PC																																																																															
VM2269B0	INNER GLASS FIXING CAP	2.000	PC																																																																															
VM2274A0	GROOVED BUSHING	1.000	PC																																																																															
VM2275A0	SMOOTH BUSHING	1.000	PC																																																																															
VM2284B0	750 SERIES DRIP PROFILE KIT	1.000	PC																																																																															
VM2305A0	6 SERIES DOOR CAP FIXING PAWL	14.000	PC																																																																															
VM2312A0	6 S. DRIP PROFILE DRAIN LEFT PIPE	1.000	PC																																																																															
VM2314A0	6 S. DRIP PROFILE CAP	1.000	PC																																																																															
VM2315B0	S6 INTERNAL GLASS SUPPORT	3.000	PC																																																																															
VM2505B1	MM PLUS INTERNAL GLASS SUPPORT	3.000	PC																																																																															
VP1080A0	UPPER HINGE CAP FOR LOWER INNER GLASS	1.000	PC																																																																															



COMPONENT			SPARE PART																																																			
Code	Description	Image	Code	Description	Kit components																																																	
OB1109A	XEVC-0511-E RIGHT INT DOOR COLUMN		KDR1261B	0511 -M RIGHT EXTERNAL DOOR	<table border="1"> <thead> <tr> <th>Code</th> <th>Description</th> <th>Qty</th> <th>UOM</th> </tr> </thead> <tbody> <tr> <td>VP1081A0</td> <td>UPPER HINGE CAP FOR UPPER INNER GLASS</td> <td>1.000</td> <td>PC</td> </tr> <tr> <td>VT1276A0</td> <td>XEVC-0511-E DOOR EXTERNAL GLASS</td> <td>1.000</td> <td>PC</td> </tr> </tbody> </table>	Code	Description	Qty	UOM	VP1081A0	UPPER HINGE CAP FOR UPPER INNER GLASS	1.000	PC	VT1276A0	XEVC-0511-E DOOR EXTERNAL GLASS	1.000	PC																																					
			Code	Description	Qty	UOM																																																
VP1081A0	UPPER HINGE CAP FOR UPPER INNER GLASS	1.000	PC																																																			
VT1276A0	XEVC-0511-E DOOR EXTERNAL GLASS	1.000	PC																																																			
KDR1261A	0511 RIGHT EXTERNAL DOOR	<table border="1"> <thead> <tr> <th>Code</th> <th>Description</th> <th>Qty</th> <th>UOM</th> </tr> </thead> <tbody> <tr> <td>OB1106A0</td> <td>XEVC-0511-E DOOR EXTERNAL LEFT COLUMN</td> <td>1.000</td> <td>PC</td> </tr> <tr> <td>OB1107A1</td> <td>XEVC-0511-E LEFT INT DOOR COLUM</td> <td>1.000</td> <td>PC</td> </tr> <tr> <td>OB1108B1</td> <td>XEVC-0511 DOOR EXTERNAL RIGHT COLUM</td> <td>1.000</td> <td>PC</td> </tr> <tr> <td>OB1109A1</td> <td>XEVC-0511-E RIGHT INT DOOR COLUM</td> <td>1.000</td> <td>PC</td> </tr> <tr> <td>OB1122A1</td> <td>750MM DOOR LOWER FRAME SHAPE</td> <td>1.000</td> <td>PC</td> </tr> <tr> <td>OB1166A1</td> <td>XEVC-0511-E EXT GLASS SUPPORT PROFILE</td> <td>2.000</td> <td>PC</td> </tr> <tr> <td>OB1216A1</td> <td>MM CT DOUBLE GLASS DOOR UPPER BEAM</td> <td>1.000</td> <td>PC</td> </tr> <tr> <td>OB1217A1</td> <td>MM DOUBLE GLASS DOOR INT UPPER BEAM 750</td> <td>1.000</td> <td>PC</td> </tr> <tr> <td>CE1052A1</td> <td>CABLE CONNECTION CONTROL - USB MM 750m</td> <td>1.000</td> <td>PC</td> </tr> <tr> <td>CE1053B0</td> <td>MM MICROFIT LED BAR POWER SUPPLY CABL</td> <td>1.000</td> <td>PC</td> </tr> <tr> <td>CE1275A0</td> <td>3M POWER - CONTROL CONNECTION CABLE</td> <td>1.000</td> <td>PC</td> </tr> <tr> <td>CE1285A0</td> <td>EMI ROUND FERRITE MOD.26438015 02</td> <td>1.000</td> <td>PC</td> </tr> </tbody> </table>	Code	Description	Qty	UOM	OB1106A0	XEVC-0511-E DOOR EXTERNAL LEFT COLUMN	1.000	PC	OB1107A1	XEVC-0511-E LEFT INT DOOR COLUM	1.000	PC	OB1108B1	XEVC-0511 DOOR EXTERNAL RIGHT COLUM	1.000	PC	OB1109A1	XEVC-0511-E RIGHT INT DOOR COLUM	1.000	PC	OB1122A1	750MM DOOR LOWER FRAME SHAPE	1.000	PC	OB1166A1	XEVC-0511-E EXT GLASS SUPPORT PROFILE	2.000	PC	OB1216A1	MM CT DOUBLE GLASS DOOR UPPER BEAM	1.000	PC	OB1217A1	MM DOUBLE GLASS DOOR INT UPPER BEAM 750	1.000	PC	CE1052A1	CABLE CONNECTION CONTROL - USB MM 750m	1.000	PC	CE1053B0	MM MICROFIT LED BAR POWER SUPPLY CABL	1.000	PC	CE1275A0	3M POWER - CONTROL CONNECTION CABLE	1.000	PC	CE1285A0	EMI ROUND FERRITE MOD.26438015 02	1.000	PC
Code	Description	Qty	UOM																																																			
OB1106A0	XEVC-0511-E DOOR EXTERNAL LEFT COLUMN	1.000	PC																																																			
OB1107A1	XEVC-0511-E LEFT INT DOOR COLUM	1.000	PC																																																			
OB1108B1	XEVC-0511 DOOR EXTERNAL RIGHT COLUM	1.000	PC																																																			
OB1109A1	XEVC-0511-E RIGHT INT DOOR COLUM	1.000	PC																																																			
OB1122A1	750MM DOOR LOWER FRAME SHAPE	1.000	PC																																																			
OB1166A1	XEVC-0511-E EXT GLASS SUPPORT PROFILE	2.000	PC																																																			
OB1216A1	MM CT DOUBLE GLASS DOOR UPPER BEAM	1.000	PC																																																			
OB1217A1	MM DOUBLE GLASS DOOR INT UPPER BEAM 750	1.000	PC																																																			
CE1052A1	CABLE CONNECTION CONTROL - USB MM 750m	1.000	PC																																																			
CE1053B0	MM MICROFIT LED BAR POWER SUPPLY CABL	1.000	PC																																																			
CE1275A0	3M POWER - CONTROL CONNECTION CABLE	1.000	PC																																																			
CE1285A0	EMI ROUND FERRITE MOD.26438015 02	1.000	PC																																																			



COMPONENT			SPARE PART																																																																										
Code	Description	Image	Code	Description	Kit components																																																																								
OB1109A	XEVC-0511-E RIGHT INT DOOR COLUMN		KDR1261A	0511 RIGHT EXTERNAL DOOR	<table border="1"> <thead> <tr> <th>Code</th> <th>Description</th> <th>Qty</th> <th>UOM</th> </tr> </thead> <tbody> <tr> <td>CE1290A0</td> <td>EXTRACTABL E FEMALE TERMINAL CPF 5/4</td> <td>1.000</td> <td>PC</td> </tr> <tr> <td>GN1525A0</td> <td>O-RING INT DIAM 9,5 THK 1 NBR 70</td> <td>1.000</td> <td>PC</td> </tr> <tr> <td>LP1019A0</td> <td>6 SERIES L200 LED LIGHT BAR - E415</td> <td>1.000</td> <td>PC</td> </tr> <tr> <td>LP1025A0</td> <td>L=415 LED LIGHT BAR COVER</td> <td>1.000</td> <td>PC</td> </tr> <tr> <td>MG1083A2</td> <td>MM COMPLETE HANDLE</td> <td>1.000</td> <td>PC</td> </tr> <tr> <td>SL1170A1</td> <td>S57 BLACK SILICON - 310ml CARTRIDGE</td> <td>30.000</td> <td>ML</td> </tr> <tr> <td>VE1030A1</td> <td>MAGNET FOR DOOR MICROSWITC H D=22,9mm</td> <td>2.000</td> <td>PC</td> </tr> <tr> <td>VI1034A0</td> <td>STAINLESS STEEL WASHER 8,4x16x1</td> <td>1.000</td> <td>PC</td> </tr> <tr> <td>VI1147A0</td> <td>5X25 STAINLESS STEEL SCREW</td> <td>16.000</td> <td>PC</td> </tr> <tr> <td>VI1220A1</td> <td>4,2x12 TCB SELF-TAPPIN G SCREW</td> <td>25.000</td> <td>PC</td> </tr> <tr> <td>VI1996A0</td> <td>M5x35 SCREW</td> <td>13.000</td> <td>PC</td> </tr> <tr> <td>VM1630A1</td> <td>INTERNAL GLASS PUSHING CAP</td> <td>3.000</td> <td>PC</td> </tr> <tr> <td>VM1631A0</td> <td>PLUS INNER GLASS PUSHING CAP</td> <td>2.000</td> <td>PC</td> </tr> <tr> <td>VM2259A1</td> <td>6 SERIES DOOR LOWER LEFT CAP</td> <td>1.000</td> <td>PC</td> </tr> <tr> <td>VM2260A1</td> <td>6 SERIES DOOR UPPER LEFT CAP</td> <td>1.000</td> <td>PC</td> </tr> <tr> <td>VM2261A1</td> <td>MM DOOR LOWER RIGHT CAP</td> <td>1.000</td> <td>PC</td> </tr> <tr> <td>VM2262A1</td> <td>MM DOOR UPPER RIGHT CAP</td> <td>1.000</td> <td>PC</td> </tr> </tbody> </table>	Code	Description	Qty	UOM	CE1290A0	EXTRACTABL E FEMALE TERMINAL CPF 5/4	1.000	PC	GN1525A0	O-RING INT DIAM 9,5 THK 1 NBR 70	1.000	PC	LP1019A0	6 SERIES L200 LED LIGHT BAR - E415	1.000	PC	LP1025A0	L=415 LED LIGHT BAR COVER	1.000	PC	MG1083A2	MM COMPLETE HANDLE	1.000	PC	SL1170A1	S57 BLACK SILICON - 310ml CARTRIDGE	30.000	ML	VE1030A1	MAGNET FOR DOOR MICROSWITC H D=22,9mm	2.000	PC	VI1034A0	STAINLESS STEEL WASHER 8,4x16x1	1.000	PC	VI1147A0	5X25 STAINLESS STEEL SCREW	16.000	PC	VI1220A1	4,2x12 TCB SELF-TAPPIN G SCREW	25.000	PC	VI1996A0	M5x35 SCREW	13.000	PC	VM1630A1	INTERNAL GLASS PUSHING CAP	3.000	PC	VM1631A0	PLUS INNER GLASS PUSHING CAP	2.000	PC	VM2259A1	6 SERIES DOOR LOWER LEFT CAP	1.000	PC	VM2260A1	6 SERIES DOOR UPPER LEFT CAP	1.000	PC	VM2261A1	MM DOOR LOWER RIGHT CAP	1.000	PC	VM2262A1	MM DOOR UPPER RIGHT CAP	1.000	PC
Code	Description	Qty	UOM																																																																										
CE1290A0	EXTRACTABL E FEMALE TERMINAL CPF 5/4	1.000	PC																																																																										
GN1525A0	O-RING INT DIAM 9,5 THK 1 NBR 70	1.000	PC																																																																										
LP1019A0	6 SERIES L200 LED LIGHT BAR - E415	1.000	PC																																																																										
LP1025A0	L=415 LED LIGHT BAR COVER	1.000	PC																																																																										
MG1083A2	MM COMPLETE HANDLE	1.000	PC																																																																										
SL1170A1	S57 BLACK SILICON - 310ml CARTRIDGE	30.000	ML																																																																										
VE1030A1	MAGNET FOR DOOR MICROSWITC H D=22,9mm	2.000	PC																																																																										
VI1034A0	STAINLESS STEEL WASHER 8,4x16x1	1.000	PC																																																																										
VI1147A0	5X25 STAINLESS STEEL SCREW	16.000	PC																																																																										
VI1220A1	4,2x12 TCB SELF-TAPPIN G SCREW	25.000	PC																																																																										
VI1996A0	M5x35 SCREW	13.000	PC																																																																										
VM1630A1	INTERNAL GLASS PUSHING CAP	3.000	PC																																																																										
VM1631A0	PLUS INNER GLASS PUSHING CAP	2.000	PC																																																																										
VM2259A1	6 SERIES DOOR LOWER LEFT CAP	1.000	PC																																																																										
VM2260A1	6 SERIES DOOR UPPER LEFT CAP	1.000	PC																																																																										
VM2261A1	MM DOOR LOWER RIGHT CAP	1.000	PC																																																																										
VM2262A1	MM DOOR UPPER RIGHT CAP	1.000	PC																																																																										







COMPONENT			SPARE PART																																																														
Code	Description	Image	Code	Description	Kit components																																																												
OB1109A	XEVC-0511-E RIGHT INT DOOR COLUMN		KDR1261A	0511 RIGHT EXTERNAL DOOR	<table border="1"> <thead> <tr> <th>Code</th> <th>Description</th> <th>Qty</th> <th>UOM</th> </tr> </thead> <tbody> <tr> <td>VM2267A0</td> <td>INTERNAL GLASS LOCKING SYSTEM SLIDER</td> <td>2.000</td> <td>PC</td> </tr> <tr> <td>VM2268A0</td> <td>DOOR MAGNET COVER</td> <td>2.000</td> <td>PC</td> </tr> <tr> <td>VM2269A0</td> <td>INTERNAL GLASS LOCKING SYSTEM CAP</td> <td>2.000</td> <td>PC</td> </tr> <tr> <td>VM2274A0</td> <td>GROOVED BUSHING</td> <td>1.000</td> <td>PC</td> </tr> <tr> <td>VM2275A0</td> <td>SMOOTH BUSHING</td> <td>1.000</td> <td>PC</td> </tr> <tr> <td>VM2284A0</td> <td>750 SERIES DRIP PROFILE</td> <td>1.000</td> <td>PC</td> </tr> <tr> <td>VM2305A0</td> <td>6 SERIES DOOR CAP FIXING PAWL</td> <td>14.000</td> <td>PC</td> </tr> <tr> <td>VM2312A0</td> <td>6 S. DRIP PROFILE DRAIN LEFT PIPE</td> <td>1.000</td> <td>PC</td> </tr> <tr> <td>VM2314A0</td> <td>6 S. DRIP PROFILE CAP</td> <td>1.000</td> <td>PC</td> </tr> <tr> <td>VM2315A0</td> <td>MIND.Maps INTERNAL GLASS CAP SUPPORT</td> <td>3.000</td> <td>PC</td> </tr> <tr> <td>VM2505A0</td> <td>MM PLUS INTERNAL GLASS SUPPORT</td> <td>2.000</td> <td>PC</td> </tr> <tr> <td>VM2518A0</td> <td>BOARD COOLING FAN SUPPORT</td> <td>1.000</td> <td>PC</td> </tr> <tr> <td>VN1179A1</td> <td>CONTROL BOARD 40x40x20mm 12V COOLING FAN</td> <td>1.000</td> <td>PC</td> </tr> <tr> <td>VT1276A0</td> <td>XEVC-0511-E DOOR EXTERNAL GLASS</td> <td>1.000</td> <td>PC</td> </tr> </tbody> </table>	Code	Description	Qty	UOM	VM2267A0	INTERNAL GLASS LOCKING SYSTEM SLIDER	2.000	PC	VM2268A0	DOOR MAGNET COVER	2.000	PC	VM2269A0	INTERNAL GLASS LOCKING SYSTEM CAP	2.000	PC	VM2274A0	GROOVED BUSHING	1.000	PC	VM2275A0	SMOOTH BUSHING	1.000	PC	VM2284A0	750 SERIES DRIP PROFILE	1.000	PC	VM2305A0	6 SERIES DOOR CAP FIXING PAWL	14.000	PC	VM2312A0	6 S. DRIP PROFILE DRAIN LEFT PIPE	1.000	PC	VM2314A0	6 S. DRIP PROFILE CAP	1.000	PC	VM2315A0	MIND.Maps INTERNAL GLASS CAP SUPPORT	3.000	PC	VM2505A0	MM PLUS INTERNAL GLASS SUPPORT	2.000	PC	VM2518A0	BOARD COOLING FAN SUPPORT	1.000	PC	VN1179A1	CONTROL BOARD 40x40x20mm 12V COOLING FAN	1.000	PC	VT1276A0	XEVC-0511-E DOOR EXTERNAL GLASS	1.000	PC
Code	Description	Qty	UOM																																																														
VM2267A0	INTERNAL GLASS LOCKING SYSTEM SLIDER	2.000	PC																																																														
VM2268A0	DOOR MAGNET COVER	2.000	PC																																																														
VM2269A0	INTERNAL GLASS LOCKING SYSTEM CAP	2.000	PC																																																														
VM2274A0	GROOVED BUSHING	1.000	PC																																																														
VM2275A0	SMOOTH BUSHING	1.000	PC																																																														
VM2284A0	750 SERIES DRIP PROFILE	1.000	PC																																																														
VM2305A0	6 SERIES DOOR CAP FIXING PAWL	14.000	PC																																																														
VM2312A0	6 S. DRIP PROFILE DRAIN LEFT PIPE	1.000	PC																																																														
VM2314A0	6 S. DRIP PROFILE CAP	1.000	PC																																																														
VM2315A0	MIND.Maps INTERNAL GLASS CAP SUPPORT	3.000	PC																																																														
VM2505A0	MM PLUS INTERNAL GLASS SUPPORT	2.000	PC																																																														
VM2518A0	BOARD COOLING FAN SUPPORT	1.000	PC																																																														
VN1179A1	CONTROL BOARD 40x40x20mm 12V COOLING FAN	1.000	PC																																																														
VT1276A0	XEVC-0511-E DOOR EXTERNAL GLASS	1.000	PC																																																														



COMPONENT			SPARE PART																																																																																					
Code	Description	Image	Code	Description	Kit components																																																																																			
0B1122B	MM CT DOOR LOWER CROSS BAR		K0B1122BR	CHEFTOP MM -M RIGHT DOOR LOWER BEAM KIT	<table border="1"> <thead> <tr> <th>Code</th> <th>Description</th> <th>Qty</th> <th>UOM</th> </tr> </thead> <tbody> <tr> <td>0B1122B0</td> <td>MM CT DOOR LOWER CROSS BAR</td> <td>1.000</td> <td>PC</td> </tr> <tr> <td>RC1200A0</td> <td>ED=4 WIRE D.=0.5 COMPRESSIO N SPRING</td> <td>2.000</td> <td>PC</td> </tr> <tr> <td>VE1030A1</td> <td>MAGNET FOR DOOR MICROSWITC H D=22.9mm</td> <td>1.000</td> <td>PC</td> </tr> <tr> <td>VI1103A0</td> <td>40X12 TBSP SCREW FOR PLASTIC</td> <td>1.000</td> <td>PC</td> </tr> <tr> <td>VI1220A1</td> <td>4,2x12 TCB SELF-TAPPIN G SCREW</td> <td>1.000</td> <td>PC</td> </tr> <tr> <td>VI1930A1</td> <td>ST. STEEL 5X20 CHIP SCREW</td> <td>8.000</td> <td>PC</td> </tr> <tr> <td>VI1996A0</td> <td>M5x35 SCREW</td> <td>7.000</td> <td>PC</td> </tr> <tr> <td>VM1794A0</td> <td>250x4.8 PA66 BLACK CLAMP</td> <td>2.000</td> <td>PC</td> </tr> <tr> <td>VM2103A0</td> <td>CLAMP LOCK</td> <td>2.000</td> <td>PC</td> </tr> <tr> <td>VM2259B0</td> <td>VM2259B0</td> <td>1.000</td> <td>PC</td> </tr> <tr> <td>VM2261B0</td> <td>MM -M DOOR RIGHT LOWER CAP</td> <td>1.000</td> <td>PC</td> </tr> <tr> <td>VM2267A0</td> <td>INTERNAL GLASS LOCKING SYSTEM SLIDER</td> <td>1.000</td> <td>PC</td> </tr> <tr> <td>VM2268A0</td> <td>DOOR MAGNET COVER</td> <td>1.000</td> <td>PC</td> </tr> <tr> <td>VM2269B0</td> <td>INNER GLASS FIXING CAP</td> <td>1.000</td> <td>PC</td> </tr> <tr> <td>VM2274A0</td> <td>GROOVED BUSHING</td> <td>1.000</td> <td>PC</td> </tr> <tr> <td>VM2305A0</td> <td>6 SERIES DOOR CAP FIXING PAWL</td> <td>7.000</td> <td>PC</td> </tr> <tr> <td>VP1080A0</td> <td>UPPER HINGE CAP FOR LOWER INNER GLASS</td> <td>1.000</td> <td>PC</td> </tr> </tbody> </table>	Code	Description	Qty	UOM	0B1122B0	MM CT DOOR LOWER CROSS BAR	1.000	PC	RC1200A0	ED=4 WIRE D.=0.5 COMPRESSIO N SPRING	2.000	PC	VE1030A1	MAGNET FOR DOOR MICROSWITC H D=22.9mm	1.000	PC	VI1103A0	40X12 TBSP SCREW FOR PLASTIC	1.000	PC	VI1220A1	4,2x12 TCB SELF-TAPPIN G SCREW	1.000	PC	VI1930A1	ST. STEEL 5X20 CHIP SCREW	8.000	PC	VI1996A0	M5x35 SCREW	7.000	PC	VM1794A0	250x4.8 PA66 BLACK CLAMP	2.000	PC	VM2103A0	CLAMP LOCK	2.000	PC	VM2259B0	VM2259B0	1.000	PC	VM2261B0	MM -M DOOR RIGHT LOWER CAP	1.000	PC	VM2267A0	INTERNAL GLASS LOCKING SYSTEM SLIDER	1.000	PC	VM2268A0	DOOR MAGNET COVER	1.000	PC	VM2269B0	INNER GLASS FIXING CAP	1.000	PC	VM2274A0	GROOVED BUSHING	1.000	PC	VM2305A0	6 SERIES DOOR CAP FIXING PAWL	7.000	PC	VP1080A0	UPPER HINGE CAP FOR LOWER INNER GLASS	1.000	PC	K0B1122BL	CHEFTOP MM -M LEFT DOOR LOWER BEAM KIT	<table border="1"> <thead> <tr> <th>Code</th> <th>Description</th> <th>Qty</th> <th>UOM</th> </tr> </thead> <tbody> <tr> <td>0B1122B0</td> <td>MM CT DOOR LOWER CROSS BAR</td> <td>1.000</td> <td>PC</td> </tr> </tbody> </table>	Code	Description	Qty	UOM	0B1122B0	MM CT DOOR LOWER CROSS BAR	1.000	PC
			Code	Description	Qty	UOM																																																																																		
0B1122B0	MM CT DOOR LOWER CROSS BAR	1.000	PC																																																																																					
RC1200A0	ED=4 WIRE D.=0.5 COMPRESSIO N SPRING	2.000	PC																																																																																					
VE1030A1	MAGNET FOR DOOR MICROSWITC H D=22.9mm	1.000	PC																																																																																					
VI1103A0	40X12 TBSP SCREW FOR PLASTIC	1.000	PC																																																																																					
VI1220A1	4,2x12 TCB SELF-TAPPIN G SCREW	1.000	PC																																																																																					
VI1930A1	ST. STEEL 5X20 CHIP SCREW	8.000	PC																																																																																					
VI1996A0	M5x35 SCREW	7.000	PC																																																																																					
VM1794A0	250x4.8 PA66 BLACK CLAMP	2.000	PC																																																																																					
VM2103A0	CLAMP LOCK	2.000	PC																																																																																					
VM2259B0	VM2259B0	1.000	PC																																																																																					
VM2261B0	MM -M DOOR RIGHT LOWER CAP	1.000	PC																																																																																					
VM2267A0	INTERNAL GLASS LOCKING SYSTEM SLIDER	1.000	PC																																																																																					
VM2268A0	DOOR MAGNET COVER	1.000	PC																																																																																					
VM2269B0	INNER GLASS FIXING CAP	1.000	PC																																																																																					
VM2274A0	GROOVED BUSHING	1.000	PC																																																																																					
VM2305A0	6 SERIES DOOR CAP FIXING PAWL	7.000	PC																																																																																					
VP1080A0	UPPER HINGE CAP FOR LOWER INNER GLASS	1.000	PC																																																																																					
Code	Description	Qty	UOM																																																																																					
0B1122B0	MM CT DOOR LOWER CROSS BAR	1.000	PC																																																																																					



COMPONENT			SPARE PART																																																																						
Code	Description	Image	Code	Description	Kit components																																																																				
0B1122B	MM CT DOOR LOWER CROSS BAR		K0B1122BL	CHEFTOP MM -M LEFT DOOR LOWER BEAM KIT	<table border="1"> <thead> <tr> <th>Code</th> <th>Description</th> <th>Qty</th> <th>UOM</th> </tr> </thead> <tbody> <tr> <td>RC1200A0</td> <td>ED=4 WIRE D.=0.5 COMPRESSION SPRING</td> <td>2.000</td> <td>PC</td> </tr> <tr> <td>VE1030A1</td> <td>MAGNET FOR DOOR MICROSWITCH H D=22.9mm</td> <td>1.000</td> <td>PC</td> </tr> <tr> <td>VI1103A0</td> <td>40X12 TBSP SCREW FOR PLASTIC</td> <td>1.000</td> <td>PC</td> </tr> <tr> <td>VI1220A1</td> <td>4,2x12 TCB SELF-TAPPING SCREW</td> <td>1.000</td> <td>PC</td> </tr> <tr> <td>VI1930A1</td> <td>ST. STEEL 5X20 CHIP SCREW</td> <td>8.000</td> <td>PC</td> </tr> <tr> <td>VI1996A0</td> <td>M5x35 SCREW</td> <td>6.000</td> <td>PC</td> </tr> <tr> <td>VM1794A0</td> <td>250x4.8 PA66 BLACK CLAMP</td> <td>2.000</td> <td>PC</td> </tr> <tr> <td>VM2103A0</td> <td>CLAMP LOCK</td> <td>2.000</td> <td>PC</td> </tr> <tr> <td>VM2267A0</td> <td>INTERNAL GLASS LOCKING SYSTEM SLIDER</td> <td>1.000</td> <td>PC</td> </tr> <tr> <td>VM2268A0</td> <td>DOOR MAGNET COVER</td> <td>1.000</td> <td>PC</td> </tr> <tr> <td>VM2269B0</td> <td>INNER GLASS FIXING CAP</td> <td>1.000</td> <td>PC</td> </tr> <tr> <td>VM2274A0</td> <td>GROOVED BUSHING</td> <td>1.000</td> <td>PC</td> </tr> <tr> <td>VM2305A0</td> <td>6 SERIES DOOR CAP FIXING PAWL</td> <td>7.000</td> <td>PC</td> </tr> <tr> <td>VM2384B0</td> <td></td> <td>1.000</td> <td>PC</td> </tr> <tr> <td>VM2386B0</td> <td>MM -M LEFT DOOR LEFT LOWER CAP KIT</td> <td>1.000</td> <td>PC</td> </tr> <tr> <td>VP1081A0</td> <td>UPPER HINGE CAP FOR UPPER INNER GLASS</td> <td>1.000</td> <td>PC</td> </tr> </tbody> </table>	Code	Description	Qty	UOM	RC1200A0	ED=4 WIRE D.=0.5 COMPRESSION SPRING	2.000	PC	VE1030A1	MAGNET FOR DOOR MICROSWITCH H D=22.9mm	1.000	PC	VI1103A0	40X12 TBSP SCREW FOR PLASTIC	1.000	PC	VI1220A1	4,2x12 TCB SELF-TAPPING SCREW	1.000	PC	VI1930A1	ST. STEEL 5X20 CHIP SCREW	8.000	PC	VI1996A0	M5x35 SCREW	6.000	PC	VM1794A0	250x4.8 PA66 BLACK CLAMP	2.000	PC	VM2103A0	CLAMP LOCK	2.000	PC	VM2267A0	INTERNAL GLASS LOCKING SYSTEM SLIDER	1.000	PC	VM2268A0	DOOR MAGNET COVER	1.000	PC	VM2269B0	INNER GLASS FIXING CAP	1.000	PC	VM2274A0	GROOVED BUSHING	1.000	PC	VM2305A0	6 SERIES DOOR CAP FIXING PAWL	7.000	PC	VM2384B0		1.000	PC	VM2386B0	MM -M LEFT DOOR LEFT LOWER CAP KIT	1.000	PC	VP1081A0	UPPER HINGE CAP FOR UPPER INNER GLASS	1.000	PC
					Code	Description	Qty	UOM																																																																	
RC1200A0	ED=4 WIRE D.=0.5 COMPRESSION SPRING	2.000	PC																																																																						
VE1030A1	MAGNET FOR DOOR MICROSWITCH H D=22.9mm	1.000	PC																																																																						
VI1103A0	40X12 TBSP SCREW FOR PLASTIC	1.000	PC																																																																						
VI1220A1	4,2x12 TCB SELF-TAPPING SCREW	1.000	PC																																																																						
VI1930A1	ST. STEEL 5X20 CHIP SCREW	8.000	PC																																																																						
VI1996A0	M5x35 SCREW	6.000	PC																																																																						
VM1794A0	250x4.8 PA66 BLACK CLAMP	2.000	PC																																																																						
VM2103A0	CLAMP LOCK	2.000	PC																																																																						
VM2267A0	INTERNAL GLASS LOCKING SYSTEM SLIDER	1.000	PC																																																																						
VM2268A0	DOOR MAGNET COVER	1.000	PC																																																																						
VM2269B0	INNER GLASS FIXING CAP	1.000	PC																																																																						
VM2274A0	GROOVED BUSHING	1.000	PC																																																																						
VM2305A0	6 SERIES DOOR CAP FIXING PAWL	7.000	PC																																																																						
VM2384B0		1.000	PC																																																																						
VM2386B0	MM -M LEFT DOOR LEFT LOWER CAP KIT	1.000	PC																																																																						
VP1081A0	UPPER HINGE CAP FOR UPPER INNER GLASS	1.000	PC																																																																						
0B1216B	MM CT DOUBLE GLASS DOOR UPPER CROSS BAR		0B1216B0	MM CT DOUBLE GLASS DOOR UPPER CROSS BAR																																																																					

COMPONENT			SPARE PART																																						
Code	Description	Image	Code	Description	Kit components																																				
0B1217A	MM DOUBLE GLASS DOOR INT UPPER BEAM 750		OUTOFPRODUCTIO	ITEM OUT OF PRODUCTION																																					
VE1030A	MAGNET FOR DOOR MICROSWITCH D=22,9mm		KVE1030A	2 PCS MAGNET KIT FOR DOOR SWITCH	<table border="1"> <thead> <tr> <th>Code</th> <th>Description</th> <th>Qty</th> <th>UOM</th> </tr> </thead> <tbody> <tr> <td>VE1030A1</td> <td>MAGNET FOR DOOR MICROSWITC H D=22,9mm</td> <td>2.000</td> <td>PC</td> </tr> <tr> <td>VI1220A1</td> <td>4,2x12 TCB SELF-TAPPIN G SCREW</td> <td>1.000</td> <td>PC</td> </tr> </tbody> </table>	Code	Description	Qty	UOM	VE1030A1	MAGNET FOR DOOR MICROSWITC H D=22,9mm	2.000	PC	VI1220A1	4,2x12 TCB SELF-TAPPIN G SCREW	1.000	PC																								
Code	Description	Qty	UOM																																						
VE1030A1	MAGNET FOR DOOR MICROSWITC H D=22,9mm	2.000	PC																																						
VI1220A1	4,2x12 TCB SELF-TAPPIN G SCREW	1.000	PC																																						
			KVE1020B	MICROSWITCH KIT	<table border="1"> <thead> <tr> <th>Code</th> <th>Description</th> <th>Qty</th> <th>UOM</th> </tr> </thead> <tbody> <tr> <td>CE1030A0</td> <td>FEMALE FASTON COVER 6.3X0.8 0,5-1mmg</td> <td>2.000</td> <td>PC</td> </tr> <tr> <td>CE1660A0</td> <td>6,3x0,8 FEMALE FASTON COVE</td> <td>2.000</td> <td>PC</td> </tr> <tr> <td>CE1730A0</td> <td>PVC CABLE NP 2 X AWG22 STYLE 2095</td> <td>0.150</td> <td>M</td> </tr> <tr> <td>CE1740A0</td> <td>MINIFIT MALE END FITTING</td> <td>2.000</td> <td>PC</td> </tr> <tr> <td>CE1745A0</td> <td>2 WAYS FEMALE MINIFIT CONNECTOR</td> <td>1.000</td> <td>PC</td> </tr> <tr> <td>VE1020B0</td> <td>MAGNET DOOR MICROSWITC</td> <td>1.000</td> <td>PC</td> </tr> <tr> <td>VE1030A1</td> <td>MAGNET FOR DOOR MICROSWITC H D=22,9mm</td> <td>1.000</td> <td>PC</td> </tr> <tr> <td>VI1192A0</td> <td></td> <td>1.000</td> <td>PC</td> </tr> </tbody> </table>	Code	Description	Qty	UOM	CE1030A0	FEMALE FASTON COVER 6.3X0.8 0,5-1mmg	2.000	PC	CE1660A0	6,3x0,8 FEMALE FASTON COVE	2.000	PC	CE1730A0	PVC CABLE NP 2 X AWG22 STYLE 2095	0.150	M	CE1740A0	MINIFIT MALE END FITTING	2.000	PC	CE1745A0	2 WAYS FEMALE MINIFIT CONNECTOR	1.000	PC	VE1020B0	MAGNET DOOR MICROSWITC	1.000	PC	VE1030A1	MAGNET FOR DOOR MICROSWITC H D=22,9mm	1.000	PC	VI1192A0		1.000	PC
Code	Description	Qty	UOM																																						
CE1030A0	FEMALE FASTON COVER 6.3X0.8 0,5-1mmg	2.000	PC																																						
CE1660A0	6,3x0,8 FEMALE FASTON COVE	2.000	PC																																						
CE1730A0	PVC CABLE NP 2 X AWG22 STYLE 2095	0.150	M																																						
CE1740A0	MINIFIT MALE END FITTING	2.000	PC																																						
CE1745A0	2 WAYS FEMALE MINIFIT CONNECTOR	1.000	PC																																						
VE1020B0	MAGNET DOOR MICROSWITC	1.000	PC																																						
VE1030A1	MAGNET FOR DOOR MICROSWITC H D=22,9mm	1.000	PC																																						
VI1192A0		1.000	PC																																						
VI1930A	ST. STEEL 5X20 CHIP SCREW		VI1147A0	5X25 STAINLESS STEEL SCREW																																					

COMPONENT			SPARE PART																																														
Code	Description	Image	Code	Description	Kit components																																												
VI1996A	M5x35 SCREW		VI1996A0	M5x35 SCREW																																													
VM2262B	MM -M DOOR RIGHT UPPER CAP		KVM2262B	MIND.MAPS -M DOOR RIGHT UPPER CAP KIT	<table border="1"> <thead> <tr> <th>Code</th> <th>Description</th> <th>Qty</th> <th>UOM</th> </tr> </thead> <tbody> <tr> <td>RC1200A0</td> <td>ED=4 WIRE D.=0.5 COMPRESSIO N SPRING</td> <td>2.000</td> <td>PC</td> </tr> <tr> <td>VE1030A1</td> <td>MAGNET FOR DOOR MICROSWITC H D=22.9mm</td> <td>1.000</td> <td>PC</td> </tr> <tr> <td>VI1220A1</td> <td>4,2x12 TCB SELF-TAPPIN G SCREW</td> <td>1.000</td> <td>PC</td> </tr> <tr> <td>VI1930A1</td> <td>ST. STEEL 5X20 CHIP SCREW</td> <td>4.000</td> <td>PC</td> </tr> <tr> <td>VI1996A0</td> <td>M5x35 SCREW</td> <td>4.000</td> <td>PC</td> </tr> <tr> <td>VM2262B0</td> <td>MM -M DOOR RIGHT UPPER CAP</td> <td>1.000</td> <td>PC</td> </tr> <tr> <td>VM2267A0</td> <td>INTERNAL GLASS LOCKING SYSTEM SLIDER</td> <td>1.000</td> <td>PC</td> </tr> <tr> <td>VM2268A0</td> <td>DOOR MAGNET COVER</td> <td>1.000</td> <td>PC</td> </tr> <tr> <td>VM2269B0</td> <td>INNER GLASS FIXING CAP</td> <td>1.000</td> <td>PC</td> </tr> <tr> <td>VM2305A0</td> <td>6 SERIES DOOR CAP FIXING PAWL</td> <td>4.000</td> <td>PC</td> </tr> </tbody> </table>	Code	Description	Qty	UOM	RC1200A0	ED=4 WIRE D.=0.5 COMPRESSIO N SPRING	2.000	PC	VE1030A1	MAGNET FOR DOOR MICROSWITC H D=22.9mm	1.000	PC	VI1220A1	4,2x12 TCB SELF-TAPPIN G SCREW	1.000	PC	VI1930A1	ST. STEEL 5X20 CHIP SCREW	4.000	PC	VI1996A0	M5x35 SCREW	4.000	PC	VM2262B0	MM -M DOOR RIGHT UPPER CAP	1.000	PC	VM2267A0	INTERNAL GLASS LOCKING SYSTEM SLIDER	1.000	PC	VM2268A0	DOOR MAGNET COVER	1.000	PC	VM2269B0	INNER GLASS FIXING CAP	1.000	PC	VM2305A0	6 SERIES DOOR CAP FIXING PAWL	4.000	PC
Code	Description	Qty	UOM																																														
RC1200A0	ED=4 WIRE D.=0.5 COMPRESSIO N SPRING	2.000	PC																																														
VE1030A1	MAGNET FOR DOOR MICROSWITC H D=22.9mm	1.000	PC																																														
VI1220A1	4,2x12 TCB SELF-TAPPIN G SCREW	1.000	PC																																														
VI1930A1	ST. STEEL 5X20 CHIP SCREW	4.000	PC																																														
VI1996A0	M5x35 SCREW	4.000	PC																																														
VM2262B0	MM -M DOOR RIGHT UPPER CAP	1.000	PC																																														
VM2267A0	INTERNAL GLASS LOCKING SYSTEM SLIDER	1.000	PC																																														
VM2268A0	DOOR MAGNET COVER	1.000	PC																																														
VM2269B0	INNER GLASS FIXING CAP	1.000	PC																																														
VM2305A0	6 SERIES DOOR CAP FIXING PAWL	4.000	PC																																														
VM2267A	INTERNAL GLASS LOCKING SYSTEM SLIDER		KVM2386B	MM -M LEFT DOOR LEFT LOWER CAP KI	<table border="1"> <thead> <tr> <th>Code</th> <th>Description</th> <th>Qty</th> <th>UOM</th> </tr> </thead> <tbody> <tr> <td>RC1200A0</td> <td>ED=4 WIRE D.=0.5 COMPRESSIO N SPRING</td> <td>2.000</td> <td>PC</td> </tr> <tr> <td>VE1030A1</td> <td>MAGNET FOR DOOR MICROSWITC H D=22.9mm</td> <td>1.000</td> <td>PC</td> </tr> <tr> <td>VI1220A1</td> <td>4,2x12 TCB SELF-TAPPIN G SCREW</td> <td>1.000</td> <td>PC</td> </tr> </tbody> </table>	Code	Description	Qty	UOM	RC1200A0	ED=4 WIRE D.=0.5 COMPRESSIO N SPRING	2.000	PC	VE1030A1	MAGNET FOR DOOR MICROSWITC H D=22.9mm	1.000	PC	VI1220A1	4,2x12 TCB SELF-TAPPIN G SCREW	1.000	PC																												
Code	Description	Qty	UOM																																														
RC1200A0	ED=4 WIRE D.=0.5 COMPRESSIO N SPRING	2.000	PC																																														
VE1030A1	MAGNET FOR DOOR MICROSWITC H D=22.9mm	1.000	PC																																														
VI1220A1	4,2x12 TCB SELF-TAPPIN G SCREW	1.000	PC																																														



COMPONENT			SPARE PART																																											
Code	Description	Image	Code	Description	Kit components																																									
VM2267A	INTERNAL GLASS LOCKING SYSTEM SLIDER		KVM2386B	MM -M LEFT DOOR LEFT LOWER CAP KI	<table border="1"> <thead> <tr> <th>Code</th> <th>Description</th> <th>Qty</th> <th>UOM</th> </tr> </thead> <tbody> <tr> <td>VI1930A1</td> <td>ST. STEEL 5X20 CHIP SCREW</td> <td>4.000</td> <td>PC</td> </tr> <tr> <td>VI1996A0</td> <td>M5x35 SCREW</td> <td>4.000</td> <td>PC</td> </tr> <tr> <td>VM2267A0</td> <td>INTERNAL GLASS LOCKING SYSTEM SLIDER</td> <td>1.000</td> <td>PC</td> </tr> <tr> <td>VM2268A0</td> <td>DOOR MAGNET COVER</td> <td>1.000</td> <td>PC</td> </tr> <tr> <td>VM2269B0</td> <td>INNER GLASS FIXING CAP</td> <td>1.000</td> <td>PC</td> </tr> <tr> <td>VM2305A0</td> <td>6 SERIES DOOR CAP FIXING PAWL</td> <td>4.000</td> <td>PC</td> </tr> <tr> <td>VM2386B0</td> <td>MM -M LEFT DOOR LEFT LOWER CAP KI</td> <td>1.000</td> <td>PC</td> </tr> </tbody> </table>	Code	Description	Qty	UOM	VI1930A1	ST. STEEL 5X20 CHIP SCREW	4.000	PC	VI1996A0	M5x35 SCREW	4.000	PC	VM2267A0	INTERNAL GLASS LOCKING SYSTEM SLIDER	1.000	PC	VM2268A0	DOOR MAGNET COVER	1.000	PC	VM2269B0	INNER GLASS FIXING CAP	1.000	PC	VM2305A0	6 SERIES DOOR CAP FIXING PAWL	4.000	PC	VM2386B0	MM -M LEFT DOOR LEFT LOWER CAP KI	1.000	PC									
			Code	Description	Qty	UOM																																								
VI1930A1	ST. STEEL 5X20 CHIP SCREW	4.000	PC																																											
VI1996A0	M5x35 SCREW	4.000	PC																																											
VM2267A0	INTERNAL GLASS LOCKING SYSTEM SLIDER	1.000	PC																																											
VM2268A0	DOOR MAGNET COVER	1.000	PC																																											
VM2269B0	INNER GLASS FIXING CAP	1.000	PC																																											
VM2305A0	6 SERIES DOOR CAP FIXING PAWL	4.000	PC																																											
VM2386B0	MM -M LEFT DOOR LEFT LOWER CAP KI	1.000	PC																																											
KVM2385B	MM -M LEFT DOOR LEFT UPPER CAP KI	<table border="1"> <thead> <tr> <th>Code</th> <th>Description</th> <th>Qty</th> <th>UOM</th> </tr> </thead> <tbody> <tr> <td>RC1200A0</td> <td>ED=4 WIRE D.=0.5 COMPRESSIO N SPRING</td> <td>2.000</td> <td>PC</td> </tr> <tr> <td>VE1030A1</td> <td>MAGNET FOR DOOR MICROSWITC H D=22,9mm</td> <td>1.000</td> <td>PC</td> </tr> <tr> <td>VI1220A1</td> <td>4,2x12 TCB SELF-TAPPIN G SCREW</td> <td>1.000</td> <td>PC</td> </tr> <tr> <td>VI1930A1</td> <td>ST. STEEL 5X20 CHIP SCREW</td> <td>4.000</td> <td>PC</td> </tr> <tr> <td>VI1996A0</td> <td>M5x35 SCREW</td> <td>4.000</td> <td>PC</td> </tr> <tr> <td>VM2267A0</td> <td>INTERNAL GLASS LOCKING SYSTEM SLIDER</td> <td>1.000</td> <td>PC</td> </tr> <tr> <td>VM2268A0</td> <td>DOOR MAGNET COVER</td> <td>1.000</td> <td>PC</td> </tr> <tr> <td>VM2269B0</td> <td>INNER GLASS FIXING CAP</td> <td>1.000</td> <td>PC</td> </tr> <tr> <td>VM2305A0</td> <td>6 SERIES DOOR CAP FIXING PAWL</td> <td>4.000</td> <td>PC</td> </tr> <tr> <td>VM2385B0</td> <td>S6 LEFT OVENS UPPER LEFT CAP</td> <td>1.000</td> <td>PC</td> </tr> </tbody> </table>	Code	Description	Qty	UOM	RC1200A0	ED=4 WIRE D.=0.5 COMPRESSIO N SPRING	2.000	PC	VE1030A1	MAGNET FOR DOOR MICROSWITC H D=22,9mm	1.000	PC	VI1220A1	4,2x12 TCB SELF-TAPPIN G SCREW	1.000	PC	VI1930A1	ST. STEEL 5X20 CHIP SCREW	4.000	PC	VI1996A0	M5x35 SCREW	4.000	PC	VM2267A0	INTERNAL GLASS LOCKING SYSTEM SLIDER	1.000	PC	VM2268A0	DOOR MAGNET COVER	1.000	PC	VM2269B0	INNER GLASS FIXING CAP	1.000	PC	VM2305A0	6 SERIES DOOR CAP FIXING PAWL	4.000	PC	VM2385B0	S6 LEFT OVENS UPPER LEFT CAP	1.000	PC
Code	Description	Qty	UOM																																											
RC1200A0	ED=4 WIRE D.=0.5 COMPRESSIO N SPRING	2.000	PC																																											
VE1030A1	MAGNET FOR DOOR MICROSWITC H D=22,9mm	1.000	PC																																											
VI1220A1	4,2x12 TCB SELF-TAPPIN G SCREW	1.000	PC																																											
VI1930A1	ST. STEEL 5X20 CHIP SCREW	4.000	PC																																											
VI1996A0	M5x35 SCREW	4.000	PC																																											
VM2267A0	INTERNAL GLASS LOCKING SYSTEM SLIDER	1.000	PC																																											
VM2268A0	DOOR MAGNET COVER	1.000	PC																																											
VM2269B0	INNER GLASS FIXING CAP	1.000	PC																																											
VM2305A0	6 SERIES DOOR CAP FIXING PAWL	4.000	PC																																											
VM2385B0	S6 LEFT OVENS UPPER LEFT CAP	1.000	PC																																											



COMPONENT			SPARE PART																																																																													
Code	Description	Image	Code	Description	Kit components																																																																											
VM2267A	INTERNAL GLASS LOCKING SYSTEM SLIDER		KVM2262B	MIND.MAPS -M DOOR RIGHT UPPER CAP KIT	<table border="1"> <thead> <tr> <th>Code</th> <th>Description</th> <th>Qty</th> <th>UOM</th> </tr> </thead> <tbody> <tr> <td>RC1200A0</td> <td>ED=4 WIRE D.=0.5 COMPRESSIO N SPRING</td> <td>2.000</td> <td>PC</td> </tr> <tr> <td>VE1030A1</td> <td>MAGNET FOR DOOR MICROSWITC H D=22.9mm</td> <td>1.000</td> <td>PC</td> </tr> <tr> <td>VI1220A1</td> <td>4,2x12 TCB SELF-TAPPIN G SCREW</td> <td>1.000</td> <td>PC</td> </tr> <tr> <td>VI1930A1</td> <td>ST. STEEL 5X20 CHIP SCREW</td> <td>4.000</td> <td>PC</td> </tr> <tr> <td>VI1996A0</td> <td>M5x35 SCREW</td> <td>4.000</td> <td>PC</td> </tr> <tr> <td>VM2262B0</td> <td>MM -M DOOR RIGHT UPPER CAP</td> <td>1.000</td> <td>PC</td> </tr> <tr> <td>VM2267A0</td> <td>INTERNAL GLASS LOCKING SYSTEM SLIDER</td> <td>1.000</td> <td>PC</td> </tr> <tr> <td>VM2268A0</td> <td>DOOR MAGNET COVER</td> <td>1.000</td> <td>PC</td> </tr> <tr> <td>VM2269B0</td> <td>INNER GLASS FIXING CAP</td> <td>1.000</td> <td>PC</td> </tr> <tr> <td>VM2305A0</td> <td>6 SERIES DOOR CAP FIXING PAWL</td> <td>4.000</td> <td>PC</td> </tr> </tbody> </table>	Code	Description	Qty	UOM	RC1200A0	ED=4 WIRE D.=0.5 COMPRESSIO N SPRING	2.000	PC	VE1030A1	MAGNET FOR DOOR MICROSWITC H D=22.9mm	1.000	PC	VI1220A1	4,2x12 TCB SELF-TAPPIN G SCREW	1.000	PC	VI1930A1	ST. STEEL 5X20 CHIP SCREW	4.000	PC	VI1996A0	M5x35 SCREW	4.000	PC	VM2262B0	MM -M DOOR RIGHT UPPER CAP	1.000	PC	VM2267A0	INTERNAL GLASS LOCKING SYSTEM SLIDER	1.000	PC	VM2268A0	DOOR MAGNET COVER	1.000	PC	VM2269B0	INNER GLASS FIXING CAP	1.000	PC	VM2305A0	6 SERIES DOOR CAP FIXING PAWL	4.000	PC	KVM2261B	MIND.MAPS -M DOOR RIGHT LOWER CAP KIT	<table border="1"> <thead> <tr> <th>Code</th> <th>Description</th> <th>Qty</th> <th>UOM</th> </tr> </thead> <tbody> <tr> <td>RC1200A0</td> <td>ED=4 WIRE D.=0.5 COMPRESSIO N SPRING</td> <td>2.000</td> <td>PC</td> </tr> <tr> <td>VE1030A1</td> <td>MAGNET FOR DOOR MICROSWITC H D=22.9mm</td> <td>1.000</td> <td>PC</td> </tr> <tr> <td>VI1220A1</td> <td>4,2x12 TCB SELF-TAPPIN G SCREW</td> <td>1.000</td> <td>PC</td> </tr> <tr> <td>VI1930A1</td> <td>ST. STEEL 5X20 CHIP SCREW</td> <td>4.000</td> <td>PC</td> </tr> <tr> <td>VI1996A0</td> <td>M5x35 SCREW</td> <td>4.000</td> <td>PC</td> </tr> <tr> <td>VM2261B0</td> <td>MM -M DOOR RIGHT LOWER CAP</td> <td>1.000</td> <td>PC</td> </tr> </tbody> </table>	Code	Description	Qty	UOM	RC1200A0	ED=4 WIRE D.=0.5 COMPRESSIO N SPRING	2.000	PC	VE1030A1	MAGNET FOR DOOR MICROSWITC H D=22.9mm	1.000	PC	VI1220A1	4,2x12 TCB SELF-TAPPIN G SCREW	1.000	PC	VI1930A1	ST. STEEL 5X20 CHIP SCREW	4.000	PC	VI1996A0	M5x35 SCREW	4.000	PC	VM2261B0	MM -M DOOR RIGHT LOWER CAP	1.000	PC
			Code	Description	Qty	UOM																																																																										
RC1200A0	ED=4 WIRE D.=0.5 COMPRESSIO N SPRING	2.000	PC																																																																													
VE1030A1	MAGNET FOR DOOR MICROSWITC H D=22.9mm	1.000	PC																																																																													
VI1220A1	4,2x12 TCB SELF-TAPPIN G SCREW	1.000	PC																																																																													
VI1930A1	ST. STEEL 5X20 CHIP SCREW	4.000	PC																																																																													
VI1996A0	M5x35 SCREW	4.000	PC																																																																													
VM2262B0	MM -M DOOR RIGHT UPPER CAP	1.000	PC																																																																													
VM2267A0	INTERNAL GLASS LOCKING SYSTEM SLIDER	1.000	PC																																																																													
VM2268A0	DOOR MAGNET COVER	1.000	PC																																																																													
VM2269B0	INNER GLASS FIXING CAP	1.000	PC																																																																													
VM2305A0	6 SERIES DOOR CAP FIXING PAWL	4.000	PC																																																																													
Code	Description	Qty	UOM																																																																													
RC1200A0	ED=4 WIRE D.=0.5 COMPRESSIO N SPRING	2.000	PC																																																																													
VE1030A1	MAGNET FOR DOOR MICROSWITC H D=22.9mm	1.000	PC																																																																													
VI1220A1	4,2x12 TCB SELF-TAPPIN G SCREW	1.000	PC																																																																													
VI1930A1	ST. STEEL 5X20 CHIP SCREW	4.000	PC																																																																													
VI1996A0	M5x35 SCREW	4.000	PC																																																																													
VM2261B0	MM -M DOOR RIGHT LOWER CAP	1.000	PC																																																																													

COMPONENT			SPARE PART																						
Code	Description	Image	Code	Description	Kit components																				
VM2267A	INTERNAL GLASS LOCKING SYSTEM SLIDER		KVM2261B	MIND.MAPS -M DOOR RIGHT LOWER CAP KIT	<table border="1"> <thead> <tr> <th>Code</th> <th>Description</th> <th>Qty</th> <th>UOM</th> </tr> </thead> <tbody> <tr> <td>VM2267A0</td> <td>INTERNAL GLASS LOCKING SYSTEM SLIDER</td> <td>1.000</td> <td>PC</td> </tr> <tr> <td>VM2268A0</td> <td>DOOR MAGNET COVER</td> <td>1.000</td> <td>PC</td> </tr> <tr> <td>VM2269B0</td> <td>INNER GLASS FIXING CAP</td> <td>1.000</td> <td>PC</td> </tr> <tr> <td>VM2305A0</td> <td>6 SERIES DOOR CAP FIXING PAWL</td> <td>4.000</td> <td>PC</td> </tr> </tbody> </table>	Code	Description	Qty	UOM	VM2267A0	INTERNAL GLASS LOCKING SYSTEM SLIDER	1.000	PC	VM2268A0	DOOR MAGNET COVER	1.000	PC	VM2269B0	INNER GLASS FIXING CAP	1.000	PC	VM2305A0	6 SERIES DOOR CAP FIXING PAWL	4.000	PC
Code	Description	Qty	UOM																						
VM2267A0	INTERNAL GLASS LOCKING SYSTEM SLIDER	1.000	PC																						
VM2268A0	DOOR MAGNET COVER	1.000	PC																						
VM2269B0	INNER GLASS FIXING CAP	1.000	PC																						
VM2305A0	6 SERIES DOOR CAP FIXING PAWL	4.000	PC																						
VM2268A	DOOR MAGNET COVER		KVM2268A	DOOR MAGNET COVER KIT	<table border="1"> <thead> <tr> <th>Code</th> <th>Description</th> <th>Qty</th> <th>UOM</th> </tr> </thead> <tbody> <tr> <td>VM2268A0</td> <td>DOOR MAGNET COVER</td> <td>1.000</td> <td>PC</td> </tr> </tbody> </table>	Code	Description	Qty	UOM	VM2268A0	DOOR MAGNET COVER	1.000	PC												
Code	Description	Qty	UOM																						
VM2268A0	DOOR MAGNET COVER	1.000	PC																						
VM2269B	INNER GLASS FIXING CAP		KVM2269B	INNER GLASS FIXING CAP KIT -M	<table border="1"> <thead> <tr> <th>Code</th> <th>Description</th> <th>Qty</th> <th>UOM</th> </tr> </thead> <tbody> <tr> <td>VM2269B0</td> <td>INNER GLASS FIXING CAP</td> <td>2.000</td> <td>PC</td> </tr> </tbody> </table>	Code	Description	Qty	UOM	VM2269B0	INNER GLASS FIXING CAP	2.000	PC												
Code	Description	Qty	UOM																						
VM2269B0	INNER GLASS FIXING CAP	2.000	PC																						
VM2305A	6 SERIES DOOR CAP FIXING PAWL		KVM2305A	MM FIXING DOOR THUB SCREWS 10 PCS KIT	<table border="1"> <thead> <tr> <th>Code</th> <th>Description</th> <th>Qty</th> <th>UOM</th> </tr> </thead> <tbody> <tr> <td>VM2305A0</td> <td>6 SERIES DOOR CAP FIXING PAWL</td> <td>10.000</td> <td>PC</td> </tr> </tbody> </table>	Code	Description	Qty	UOM	VM2305A0	6 SERIES DOOR CAP FIXING PAWL	10.000	PC												
Code	Description	Qty	UOM																						
VM2305A0	6 SERIES DOOR CAP FIXING PAWL	10.000	PC																						
VE1030A	MAGNET FOR DOOR MICROSWITCH D=22,9mm		KVE1030A	2 PCS MAGNET KIT FOR DOOR SWITCH	<table border="1"> <thead> <tr> <th>Code</th> <th>Description</th> <th>Qty</th> <th>UOM</th> </tr> </thead> <tbody> <tr> <td>VE1030A1</td> <td>MAGNET FOR DOOR MICROSWITCH H D=22,9mm</td> <td>2.000</td> <td>PC</td> </tr> <tr> <td>VI1220A1</td> <td>4,2x12 TCB SELF-TAPPING SCREW</td> <td>1.000</td> <td>PC</td> </tr> </tbody> </table>	Code	Description	Qty	UOM	VE1030A1	MAGNET FOR DOOR MICROSWITCH H D=22,9mm	2.000	PC	VI1220A1	4,2x12 TCB SELF-TAPPING SCREW	1.000	PC								
Code	Description	Qty	UOM																						
VE1030A1	MAGNET FOR DOOR MICROSWITCH H D=22,9mm	2.000	PC																						
VI1220A1	4,2x12 TCB SELF-TAPPING SCREW	1.000	PC																						

COMPONENT			SPARE PART																																						
Code	Description	Image	Code	Description	Kit components																																				
VE1030A	MAGNET FOR DOOR MICROSWITCH D=22,9mm		KVE1020B	MICROSWITCH KIT	<table border="1"> <thead> <tr> <th>Code</th> <th>Description</th> <th>Qty</th> <th>UOM</th> </tr> </thead> <tbody> <tr> <td>CE1030A0</td> <td>FEMALE FASTON COVER 6.3X0.8 0,5-1mmq</td> <td>2.000</td> <td>PC</td> </tr> <tr> <td>CE1660A0</td> <td>6,3x0,8 FEMALE FASTON COVE</td> <td>2.000</td> <td>PC</td> </tr> <tr> <td>CE1730A0</td> <td>PVC CABLE NP 2 X AWG22 STYLE 2095</td> <td>0.150</td> <td>M</td> </tr> <tr> <td>CE1740A0</td> <td>MINIFIT MALE END FITTING</td> <td>2.000</td> <td>PC</td> </tr> <tr> <td>CE1745A0</td> <td>2 WAYS FEMALE MINIFIT CONNECTOR</td> <td>1.000</td> <td>PC</td> </tr> <tr> <td>VE1020B0</td> <td>MAGNET DOOR MICROSWITC</td> <td>1.000</td> <td>PC</td> </tr> <tr> <td>VE1030A1</td> <td>MAGNET FOR DOOR MICROSWITC H D=22,9mm</td> <td>1.000</td> <td>PC</td> </tr> <tr> <td>VI1192A0</td> <td></td> <td>1.000</td> <td>PC</td> </tr> </tbody> </table>	Code	Description	Qty	UOM	CE1030A0	FEMALE FASTON COVER 6.3X0.8 0,5-1mmq	2.000	PC	CE1660A0	6,3x0,8 FEMALE FASTON COVE	2.000	PC	CE1730A0	PVC CABLE NP 2 X AWG22 STYLE 2095	0.150	M	CE1740A0	MINIFIT MALE END FITTING	2.000	PC	CE1745A0	2 WAYS FEMALE MINIFIT CONNECTOR	1.000	PC	VE1020B0	MAGNET DOOR MICROSWITC	1.000	PC	VE1030A1	MAGNET FOR DOOR MICROSWITC H D=22,9mm	1.000	PC	VI1192A0		1.000	PC
					Code	Description	Qty	UOM																																	
					CE1030A0	FEMALE FASTON COVER 6.3X0.8 0,5-1mmq	2.000	PC																																	
					CE1660A0	6,3x0,8 FEMALE FASTON COVE	2.000	PC																																	
					CE1730A0	PVC CABLE NP 2 X AWG22 STYLE 2095	0.150	M																																	
					CE1740A0	MINIFIT MALE END FITTING	2.000	PC																																	
					CE1745A0	2 WAYS FEMALE MINIFIT CONNECTOR	1.000	PC																																	
					VE1020B0	MAGNET DOOR MICROSWITC	1.000	PC																																	
					VE1030A1	MAGNET FOR DOOR MICROSWITC H D=22,9mm	1.000	PC																																	
VI1192A0		1.000	PC																																						
VI1930A	ST. STEEL 5X20 CHIP SCREW		VI1147A0	5X25 STAINLESS STEEL SCREW																																					
VI1996A	M5x35 SCREW		VI1996A0	M5x35 SCREW																																					



COMPONENT			SPARE PART																																														
Code	Description	Image	Code	Description	Kit components																																												
VM2261B	MM -M DOOR RIGHT LOWER CAP		KVM2261B	MIND.MAPS -M DOOR RIGHT LOWER CAP KIT	<table border="1"> <thead> <tr> <th>Code</th> <th>Description</th> <th>Qty</th> <th>UOM</th> </tr> </thead> <tbody> <tr> <td>RC1200A0</td> <td>ED=4 WIRE D.=0.5 COMPRESSIO N SPRING</td> <td>2.000</td> <td>PC</td> </tr> <tr> <td>VE1030A1</td> <td>MAGNET FOR DOOR MICROSWITC H D=22.9mm</td> <td>1.000</td> <td>PC</td> </tr> <tr> <td>VI1220A1</td> <td>4,2x12 TCB SELF-TAPPIN G SCREW</td> <td>1.000</td> <td>PC</td> </tr> <tr> <td>VI1930A1</td> <td>ST. STEEL 5X20 CHIP SCREW</td> <td>4.000</td> <td>PC</td> </tr> <tr> <td>VI1996A0</td> <td>M5x35 SCREW</td> <td>4.000</td> <td>PC</td> </tr> <tr> <td>VM2261B0</td> <td>MM -M DOOR RIGHT LOWER CAP</td> <td>1.000</td> <td>PC</td> </tr> <tr> <td>VM2267A0</td> <td>INTERNAL GLASS LOCKING SYSTEM SLIDER</td> <td>1.000</td> <td>PC</td> </tr> <tr> <td>VM2268A0</td> <td>DOOR MAGNET COVER</td> <td>1.000</td> <td>PC</td> </tr> <tr> <td>VM2269B0</td> <td>INNER GLASS FIXING CAP</td> <td>1.000</td> <td>PC</td> </tr> <tr> <td>VM2305A0</td> <td>6 SERIES DOOR CAP FIXING PAWL</td> <td>4.000</td> <td>PC</td> </tr> </tbody> </table>	Code	Description	Qty	UOM	RC1200A0	ED=4 WIRE D.=0.5 COMPRESSIO N SPRING	2.000	PC	VE1030A1	MAGNET FOR DOOR MICROSWITC H D=22.9mm	1.000	PC	VI1220A1	4,2x12 TCB SELF-TAPPIN G SCREW	1.000	PC	VI1930A1	ST. STEEL 5X20 CHIP SCREW	4.000	PC	VI1996A0	M5x35 SCREW	4.000	PC	VM2261B0	MM -M DOOR RIGHT LOWER CAP	1.000	PC	VM2267A0	INTERNAL GLASS LOCKING SYSTEM SLIDER	1.000	PC	VM2268A0	DOOR MAGNET COVER	1.000	PC	VM2269B0	INNER GLASS FIXING CAP	1.000	PC	VM2305A0	6 SERIES DOOR CAP FIXING PAWL	4.000	PC
Code	Description	Qty	UOM																																														
RC1200A0	ED=4 WIRE D.=0.5 COMPRESSIO N SPRING	2.000	PC																																														
VE1030A1	MAGNET FOR DOOR MICROSWITC H D=22.9mm	1.000	PC																																														
VI1220A1	4,2x12 TCB SELF-TAPPIN G SCREW	1.000	PC																																														
VI1930A1	ST. STEEL 5X20 CHIP SCREW	4.000	PC																																														
VI1996A0	M5x35 SCREW	4.000	PC																																														
VM2261B0	MM -M DOOR RIGHT LOWER CAP	1.000	PC																																														
VM2267A0	INTERNAL GLASS LOCKING SYSTEM SLIDER	1.000	PC																																														
VM2268A0	DOOR MAGNET COVER	1.000	PC																																														
VM2269B0	INNER GLASS FIXING CAP	1.000	PC																																														
VM2305A0	6 SERIES DOOR CAP FIXING PAWL	4.000	PC																																														
VM2267A	INTERNAL GLASS LOCKING SYSTEM SLIDER		KVM2386B	MM -M LEFT DOOR LEFT LOWER CAP KI	<table border="1"> <thead> <tr> <th>Code</th> <th>Description</th> <th>Qty</th> <th>UOM</th> </tr> </thead> <tbody> <tr> <td>RC1200A0</td> <td>ED=4 WIRE D.=0.5 COMPRESSIO N SPRING</td> <td>2.000</td> <td>PC</td> </tr> <tr> <td>VE1030A1</td> <td>MAGNET FOR DOOR MICROSWITC H D=22.9mm</td> <td>1.000</td> <td>PC</td> </tr> <tr> <td>VI1220A1</td> <td>4,2x12 TCB SELF-TAPPIN G SCREW</td> <td>1.000</td> <td>PC</td> </tr> <tr> <td>VI1930A1</td> <td>ST. STEEL 5X20 CHIP SCREW</td> <td>4.000</td> <td>PC</td> </tr> <tr> <td>VI1996A0</td> <td>M5x35 SCREW</td> <td>4.000</td> <td>PC</td> </tr> <tr> <td>VM2267A0</td> <td>INTERNAL GLASS LOCKING SYSTEM SLIDER</td> <td>1.000</td> <td>PC</td> </tr> </tbody> </table>	Code	Description	Qty	UOM	RC1200A0	ED=4 WIRE D.=0.5 COMPRESSIO N SPRING	2.000	PC	VE1030A1	MAGNET FOR DOOR MICROSWITC H D=22.9mm	1.000	PC	VI1220A1	4,2x12 TCB SELF-TAPPIN G SCREW	1.000	PC	VI1930A1	ST. STEEL 5X20 CHIP SCREW	4.000	PC	VI1996A0	M5x35 SCREW	4.000	PC	VM2267A0	INTERNAL GLASS LOCKING SYSTEM SLIDER	1.000	PC																
Code	Description	Qty	UOM																																														
RC1200A0	ED=4 WIRE D.=0.5 COMPRESSIO N SPRING	2.000	PC																																														
VE1030A1	MAGNET FOR DOOR MICROSWITC H D=22.9mm	1.000	PC																																														
VI1220A1	4,2x12 TCB SELF-TAPPIN G SCREW	1.000	PC																																														
VI1930A1	ST. STEEL 5X20 CHIP SCREW	4.000	PC																																														
VI1996A0	M5x35 SCREW	4.000	PC																																														
VM2267A0	INTERNAL GLASS LOCKING SYSTEM SLIDER	1.000	PC																																														



COMPONENT			SPARE PART																																											
Code	Description	Image	Code	Description	Kit components																																									
VM2267A	INTERNAL GLASS LOCKING SYSTEM SLIDER		KVM2386B	MM -M LEFT DOOR LEFT LOWER CAP KI	<table border="1"> <thead> <tr> <th>Code</th> <th>Description</th> <th>Qty</th> <th>UOM</th> </tr> </thead> <tbody> <tr> <td>VM2268A0</td> <td>DOOR MAGNET COVER</td> <td>1.000</td> <td>PC</td> </tr> <tr> <td>VM2269B0</td> <td>INNER GLASS FIXING CAP</td> <td>1.000</td> <td>PC</td> </tr> <tr> <td>VM2305A0</td> <td>6 SERIES DOOR CAP FIXING PAWL</td> <td>4.000</td> <td>PC</td> </tr> <tr> <td>VM2386B0</td> <td>MM -M LEFT DOOR LEFT LOWER CAP KI</td> <td>1.000</td> <td>PC</td> </tr> </tbody> </table>	Code	Description	Qty	UOM	VM2268A0	DOOR MAGNET COVER	1.000	PC	VM2269B0	INNER GLASS FIXING CAP	1.000	PC	VM2305A0	6 SERIES DOOR CAP FIXING PAWL	4.000	PC	VM2386B0	MM -M LEFT DOOR LEFT LOWER CAP KI	1.000	PC																					
			Code	Description	Qty	UOM																																								
			VM2268A0	DOOR MAGNET COVER	1.000	PC																																								
VM2269B0	INNER GLASS FIXING CAP	1.000	PC																																											
VM2305A0	6 SERIES DOOR CAP FIXING PAWL	4.000	PC																																											
VM2386B0	MM -M LEFT DOOR LEFT LOWER CAP KI	1.000	PC																																											
KVM2385B	MM -M LEFT DOOR LEFT UPPER CAP KI	<table border="1"> <thead> <tr> <th>Code</th> <th>Description</th> <th>Qty</th> <th>UOM</th> </tr> </thead> <tbody> <tr> <td>RC1200A0</td> <td>ED=4 WIRE D.=0.5 COMPRESSIO N SPRING</td> <td>2.000</td> <td>PC</td> </tr> <tr> <td>VE1030A1</td> <td>MAGNET FOR DOOR MICROSWITC H D=22,9mm</td> <td>1.000</td> <td>PC</td> </tr> <tr> <td>VI1220A1</td> <td>4,2x12 TCB SELF-TAPPIN G SCREW</td> <td>1.000</td> <td>PC</td> </tr> <tr> <td>VI1930A1</td> <td>ST. STEEL 5X20 CHIP SCREW</td> <td>4.000</td> <td>PC</td> </tr> <tr> <td>VI1996A0</td> <td>M5x35 SCREW</td> <td>4.000</td> <td>PC</td> </tr> <tr> <td>VM2267A0</td> <td>INTERNAL GLASS LOCKING SYSTEM SLIDER</td> <td>1.000</td> <td>PC</td> </tr> <tr> <td>VM2268A0</td> <td>DOOR MAGNET COVER</td> <td>1.000</td> <td>PC</td> </tr> <tr> <td>VM2269B0</td> <td>INNER GLASS FIXING CAP</td> <td>1.000</td> <td>PC</td> </tr> <tr> <td>VM2305A0</td> <td>6 SERIES DOOR CAP FIXING PAWL</td> <td>4.000</td> <td>PC</td> </tr> <tr> <td>VM2385B0</td> <td>S6 LEFT OVENS UPPER LEFT CAP</td> <td>1.000</td> <td>PC</td> </tr> </tbody> </table>	Code	Description	Qty	UOM	RC1200A0	ED=4 WIRE D.=0.5 COMPRESSIO N SPRING	2.000	PC	VE1030A1	MAGNET FOR DOOR MICROSWITC H D=22,9mm	1.000	PC	VI1220A1	4,2x12 TCB SELF-TAPPIN G SCREW	1.000	PC	VI1930A1	ST. STEEL 5X20 CHIP SCREW	4.000	PC	VI1996A0	M5x35 SCREW	4.000	PC	VM2267A0	INTERNAL GLASS LOCKING SYSTEM SLIDER	1.000	PC	VM2268A0	DOOR MAGNET COVER	1.000	PC	VM2269B0	INNER GLASS FIXING CAP	1.000	PC	VM2305A0	6 SERIES DOOR CAP FIXING PAWL	4.000	PC	VM2385B0	S6 LEFT OVENS UPPER LEFT CAP	1.000	PC
Code	Description	Qty	UOM																																											
RC1200A0	ED=4 WIRE D.=0.5 COMPRESSIO N SPRING	2.000	PC																																											
VE1030A1	MAGNET FOR DOOR MICROSWITC H D=22,9mm	1.000	PC																																											
VI1220A1	4,2x12 TCB SELF-TAPPIN G SCREW	1.000	PC																																											
VI1930A1	ST. STEEL 5X20 CHIP SCREW	4.000	PC																																											
VI1996A0	M5x35 SCREW	4.000	PC																																											
VM2267A0	INTERNAL GLASS LOCKING SYSTEM SLIDER	1.000	PC																																											
VM2268A0	DOOR MAGNET COVER	1.000	PC																																											
VM2269B0	INNER GLASS FIXING CAP	1.000	PC																																											
VM2305A0	6 SERIES DOOR CAP FIXING PAWL	4.000	PC																																											
VM2385B0	S6 LEFT OVENS UPPER LEFT CAP	1.000	PC																																											
KVM2262B	MIND.MAPS -M DOOR RIGHT UPPER CAP KIT	<table border="1"> <thead> <tr> <th>Code</th> <th>Description</th> <th>Qty</th> <th>UOM</th> </tr> </thead> <tbody> <tr> <td>RC1200A0</td> <td>ED=4 WIRE D.=0.5 COMPRESSIO N SPRING</td> <td>2.000</td> <td>PC</td> </tr> <tr> <td>VE1030A1</td> <td>MAGNET FOR DOOR MICROSWITC H D=22,9mm</td> <td>1.000</td> <td>PC</td> </tr> </tbody> </table>	Code	Description	Qty	UOM	RC1200A0	ED=4 WIRE D.=0.5 COMPRESSIO N SPRING	2.000	PC	VE1030A1	MAGNET FOR DOOR MICROSWITC H D=22,9mm	1.000	PC																																
Code	Description	Qty	UOM																																											
RC1200A0	ED=4 WIRE D.=0.5 COMPRESSIO N SPRING	2.000	PC																																											
VE1030A1	MAGNET FOR DOOR MICROSWITC H D=22,9mm	1.000	PC																																											



COMPONENT			SPARE PART																																											
Code	Description	Image	Code	Description	Kit components																																									
VM2267A	INTERNAL GLASS LOCKING SYSTEM SLIDER		KVM2262B	MIND.MAPS -M DOOR RIGHT UPPER CAP KIT	<table border="1"> <thead> <tr> <th>Code</th> <th>Description</th> <th>Qty</th> <th>UOM</th> </tr> </thead> <tbody> <tr> <td>VI1220A1</td> <td>4,2x12 TCB SELF-TAPPIN G SCREW</td> <td>1.000</td> <td>PC</td> </tr> <tr> <td>VI1930A1</td> <td>ST. STEEL 5X20 CHIP SCREW</td> <td>4.000</td> <td>PC</td> </tr> <tr> <td>VI1996A0</td> <td>M5x35 SCREW</td> <td>4.000</td> <td>PC</td> </tr> <tr> <td>VM2262B0</td> <td>MM -M DOOR RIGHT UPPER CAP</td> <td>1.000</td> <td>PC</td> </tr> <tr> <td>VM2267A0</td> <td>INTERNAL GLASS LOCKING SYSTEM SLIDER</td> <td>1.000</td> <td>PC</td> </tr> <tr> <td>VM2268A0</td> <td>DOOR MAGNET COVER</td> <td>1.000</td> <td>PC</td> </tr> <tr> <td>VM2269B0</td> <td>INNER GLASS FIXING CAP</td> <td>1.000</td> <td>PC</td> </tr> <tr> <td>VM2305A0</td> <td>6 SERIES DOOR CAP FIXING PAWL</td> <td>4.000</td> <td>PC</td> </tr> </tbody> </table>	Code	Description	Qty	UOM	VI1220A1	4,2x12 TCB SELF-TAPPIN G SCREW	1.000	PC	VI1930A1	ST. STEEL 5X20 CHIP SCREW	4.000	PC	VI1996A0	M5x35 SCREW	4.000	PC	VM2262B0	MM -M DOOR RIGHT UPPER CAP	1.000	PC	VM2267A0	INTERNAL GLASS LOCKING SYSTEM SLIDER	1.000	PC	VM2268A0	DOOR MAGNET COVER	1.000	PC	VM2269B0	INNER GLASS FIXING CAP	1.000	PC	VM2305A0	6 SERIES DOOR CAP FIXING PAWL	4.000	PC					
			Code	Description	Qty	UOM																																								
VI1220A1	4,2x12 TCB SELF-TAPPIN G SCREW	1.000	PC																																											
VI1930A1	ST. STEEL 5X20 CHIP SCREW	4.000	PC																																											
VI1996A0	M5x35 SCREW	4.000	PC																																											
VM2262B0	MM -M DOOR RIGHT UPPER CAP	1.000	PC																																											
VM2267A0	INTERNAL GLASS LOCKING SYSTEM SLIDER	1.000	PC																																											
VM2268A0	DOOR MAGNET COVER	1.000	PC																																											
VM2269B0	INNER GLASS FIXING CAP	1.000	PC																																											
VM2305A0	6 SERIES DOOR CAP FIXING PAWL	4.000	PC																																											
KVM2261B	MIND.MAPS -M DOOR RIGHT LOWER CAP KIT	<table border="1"> <thead> <tr> <th>Code</th> <th>Description</th> <th>Qty</th> <th>UOM</th> </tr> </thead> <tbody> <tr> <td>RC1200A0</td> <td>ED=4 WIRE D.=0.5 COMPRESSIO N SPRING</td> <td>2.000</td> <td>PC</td> </tr> <tr> <td>VE1030A1</td> <td>MAGNET FOR DOOR MICROSWITC H D=22,9mm</td> <td>1.000</td> <td>PC</td> </tr> <tr> <td>VI1220A1</td> <td>4,2x12 TCB SELF-TAPPIN G SCREW</td> <td>1.000</td> <td>PC</td> </tr> <tr> <td>VI1930A1</td> <td>ST. STEEL 5X20 CHIP SCREW</td> <td>4.000</td> <td>PC</td> </tr> <tr> <td>VI1996A0</td> <td>M5x35 SCREW</td> <td>4.000</td> <td>PC</td> </tr> <tr> <td>VM2261B0</td> <td>MM -M DOOR RIGHT LOWER CAP</td> <td>1.000</td> <td>PC</td> </tr> <tr> <td>VM2267A0</td> <td>INTERNAL GLASS LOCKING SYSTEM SLIDER</td> <td>1.000</td> <td>PC</td> </tr> <tr> <td>VM2268A0</td> <td>DOOR MAGNET COVER</td> <td>1.000</td> <td>PC</td> </tr> <tr> <td>VM2269B0</td> <td>INNER GLASS FIXING CAP</td> <td>1.000</td> <td>PC</td> </tr> <tr> <td>VM2305A0</td> <td>6 SERIES DOOR CAP FIXING PAWL</td> <td>4.000</td> <td>PC</td> </tr> </tbody> </table>	Code	Description	Qty	UOM	RC1200A0	ED=4 WIRE D.=0.5 COMPRESSIO N SPRING	2.000	PC	VE1030A1	MAGNET FOR DOOR MICROSWITC H D=22,9mm	1.000	PC	VI1220A1	4,2x12 TCB SELF-TAPPIN G SCREW	1.000	PC	VI1930A1	ST. STEEL 5X20 CHIP SCREW	4.000	PC	VI1996A0	M5x35 SCREW	4.000	PC	VM2261B0	MM -M DOOR RIGHT LOWER CAP	1.000	PC	VM2267A0	INTERNAL GLASS LOCKING SYSTEM SLIDER	1.000	PC	VM2268A0	DOOR MAGNET COVER	1.000	PC	VM2269B0	INNER GLASS FIXING CAP	1.000	PC	VM2305A0	6 SERIES DOOR CAP FIXING PAWL	4.000	PC
Code	Description	Qty	UOM																																											
RC1200A0	ED=4 WIRE D.=0.5 COMPRESSIO N SPRING	2.000	PC																																											
VE1030A1	MAGNET FOR DOOR MICROSWITC H D=22,9mm	1.000	PC																																											
VI1220A1	4,2x12 TCB SELF-TAPPIN G SCREW	1.000	PC																																											
VI1930A1	ST. STEEL 5X20 CHIP SCREW	4.000	PC																																											
VI1996A0	M5x35 SCREW	4.000	PC																																											
VM2261B0	MM -M DOOR RIGHT LOWER CAP	1.000	PC																																											
VM2267A0	INTERNAL GLASS LOCKING SYSTEM SLIDER	1.000	PC																																											
VM2268A0	DOOR MAGNET COVER	1.000	PC																																											
VM2269B0	INNER GLASS FIXING CAP	1.000	PC																																											
VM2305A0	6 SERIES DOOR CAP FIXING PAWL	4.000	PC																																											



COMPONENT			SPARE PART										
Code	Description	Image	Code	Description	Kit components								
VM2268A	DOOR MAGNET COVER		KVM2268A	DOOR MAGNET COVER KIT	<table border="1"> <thead> <tr> <th>Code</th> <th>Description</th> <th>Qty</th> <th>UOM</th> </tr> </thead> <tbody> <tr> <td>VM2268A0</td> <td>DOOR MAGNET COVER</td> <td>1.000</td> <td>PC</td> </tr> </tbody> </table>	Code	Description	Qty	UOM	VM2268A0	DOOR MAGNET COVER	1.000	PC
Code	Description	Qty	UOM										
VM2268A0	DOOR MAGNET COVER	1.000	PC										
VM2269B	INNER GLASS FIXING CAP		KVM2269B	INNER GLASS FIXING CAP KIT -M	<table border="1"> <thead> <tr> <th>Code</th> <th>Description</th> <th>Qty</th> <th>UOM</th> </tr> </thead> <tbody> <tr> <td>VM2269B0</td> <td>INNER GLASS FIXING CAP</td> <td>2.000</td> <td>PC</td> </tr> </tbody> </table>	Code	Description	Qty	UOM	VM2269B0	INNER GLASS FIXING CAP	2.000	PC
Code	Description	Qty	UOM										
VM2269B0	INNER GLASS FIXING CAP	2.000	PC										
VM2305A	6 SERIES DOOR CAP FIXING PAWL		KVM2305A	MM FIXING DOOR THUB SCREWS 10 PCS KIT	<table border="1"> <thead> <tr> <th>Code</th> <th>Description</th> <th>Qty</th> <th>UOM</th> </tr> </thead> <tbody> <tr> <td>VM2305A0</td> <td>6 SERIES DOOR CAP FIXING PAWL</td> <td>10.000</td> <td>PC</td> </tr> </tbody> </table>	Code	Description	Qty	UOM	VM2305A0	6 SERIES DOOR CAP FIXING PAWL	10.000	PC
Code	Description	Qty	UOM										
VM2305A0	6 SERIES DOOR CAP FIXING PAWL	10.000	PC										
VI1074A	4X16 SCREW FOR PLASTIC		VI1074A0	4X16 SCREW FOR PLASTIC									
VI1930A	ST. STEEL 5X20 CHIP SCREW		VI1147A0	5X25 STAINLESS STEEL SCREW									



COMPONENT			SPARE PART																																		
Code	Description	Image	Code	Description	Kit components																																
VI1996A	M5x35 SCREW		VI1996A0	M5x35 SCREW																																	
VM2260B	S6 LEFT UPPER CAP		KVM2260B	MM M RIGHT DOOR -LEFT UPPER CAP KI	<table border="1"> <thead> <tr> <th>Code</th> <th>Description</th> <th>Qty</th> <th>UOM</th> </tr> </thead> <tbody> <tr> <td>VI1103A0</td> <td>40X12 TBSP SCREW FOR PLASTIC</td> <td>1.000</td> <td>PC</td> </tr> <tr> <td>VI1930A1</td> <td>ST. STEEL 5X20 CHIP SCREW</td> <td>4.000</td> <td>PC</td> </tr> <tr> <td>VI1996A0</td> <td>M5x35 SCREW</td> <td>2.000</td> <td>PC</td> </tr> <tr> <td>VM2260B0</td> <td>S6 LEFT UPPER CAP</td> <td>1.000</td> <td>PC</td> </tr> <tr> <td>VM2275A0</td> <td>SMOOTH BUSHING</td> <td>1.000</td> <td>PC</td> </tr> <tr> <td>VM2305A0</td> <td>6 SERIES DOOR CAP FIXING PAWL</td> <td>3.000</td> <td>PC</td> </tr> <tr> <td>VP1081A0</td> <td>UPPER HINGE CAP FOR UPPER INNER GLASS</td> <td>1.000</td> <td>PC</td> </tr> </tbody> </table>	Code	Description	Qty	UOM	VI1103A0	40X12 TBSP SCREW FOR PLASTIC	1.000	PC	VI1930A1	ST. STEEL 5X20 CHIP SCREW	4.000	PC	VI1996A0	M5x35 SCREW	2.000	PC	VM2260B0	S6 LEFT UPPER CAP	1.000	PC	VM2275A0	SMOOTH BUSHING	1.000	PC	VM2305A0	6 SERIES DOOR CAP FIXING PAWL	3.000	PC	VP1081A0	UPPER HINGE CAP FOR UPPER INNER GLASS	1.000	PC
Code	Description	Qty	UOM																																		
VI1103A0	40X12 TBSP SCREW FOR PLASTIC	1.000	PC																																		
VI1930A1	ST. STEEL 5X20 CHIP SCREW	4.000	PC																																		
VI1996A0	M5x35 SCREW	2.000	PC																																		
VM2260B0	S6 LEFT UPPER CAP	1.000	PC																																		
VM2275A0	SMOOTH BUSHING	1.000	PC																																		
VM2305A0	6 SERIES DOOR CAP FIXING PAWL	3.000	PC																																		
VP1081A0	UPPER HINGE CAP FOR UPPER INNER GLASS	1.000	PC																																		
VM2275A	SMOOTH BUSHING		KVM2275A	SMOOTH PIN BUSHING KIT	<table border="1"> <thead> <tr> <th>Code</th> <th>Description</th> <th>Qty</th> <th>UOM</th> </tr> </thead> <tbody> <tr> <td>VM2275A0</td> <td>SMOOTH BUSHING</td> <td>1.000</td> <td>PC</td> </tr> </tbody> </table>	Code	Description	Qty	UOM	VM2275A0	SMOOTH BUSHING	1.000	PC																								
Code	Description	Qty	UOM																																		
VM2275A0	SMOOTH BUSHING	1.000	PC																																		
VM2305A	6 SERIES DOOR CAP FIXING PAWL		KVM2305A	MM FIXING DOOR THUB SCREWS 10 PCS KIT	<table border="1"> <thead> <tr> <th>Code</th> <th>Description</th> <th>Qty</th> <th>UOM</th> </tr> </thead> <tbody> <tr> <td>VM2305A0</td> <td>6 SERIES DOOR CAP FIXING PAWL</td> <td>10.000</td> <td>PC</td> </tr> </tbody> </table>	Code	Description	Qty	UOM	VM2305A0	6 SERIES DOOR CAP FIXING PAWL	10.000	PC																								
Code	Description	Qty	UOM																																		
VM2305A0	6 SERIES DOOR CAP FIXING PAWL	10.000	PC																																		



COMPONENT			SPARE PART																																		
Code	Description	Image	Code	Description	Kit components																																
VP1081A	UPPER HINGE CAP FOR UPPER INNER GLASS		KVM2384B	MM- M LEFT DOOR RIGHT LOWER CAP KIT	<table border="1"> <thead> <tr> <th>Code</th> <th>Description</th> <th>Qty</th> <th>UOM</th> </tr> </thead> <tbody> <tr> <td>VI1074A0</td> <td>4X16 SCREW FOR PLASTIC</td> <td>1.000</td> <td>PC</td> </tr> <tr> <td>VI1930A1</td> <td>ST. STEEL 5X20 CHIP SCREW</td> <td>4.000</td> <td>PC</td> </tr> <tr> <td>VI1996A0</td> <td>M5x35 SCREW</td> <td>3.000</td> <td>PC</td> </tr> <tr> <td>VM2274A0</td> <td>GROOVED BUSHING</td> <td>1.000</td> <td>PC</td> </tr> <tr> <td>VM2305A0</td> <td>6 SERIES DOOR CAP FIXING PAWL</td> <td>3.000</td> <td>PC</td> </tr> <tr> <td>VM2384B0</td> <td></td> <td>1.000</td> <td>PC</td> </tr> <tr> <td>VP1081A0</td> <td>UPPER HINGE CAP FOR UPPER INNER GLASS</td> <td>1.000</td> <td>PC</td> </tr> </tbody> </table>	Code	Description	Qty	UOM	VI1074A0	4X16 SCREW FOR PLASTIC	1.000	PC	VI1930A1	ST. STEEL 5X20 CHIP SCREW	4.000	PC	VI1996A0	M5x35 SCREW	3.000	PC	VM2274A0	GROOVED BUSHING	1.000	PC	VM2305A0	6 SERIES DOOR CAP FIXING PAWL	3.000	PC	VM2384B0		1.000	PC	VP1081A0	UPPER HINGE CAP FOR UPPER INNER GLASS	1.000	PC
			Code		Description	Qty	UOM																														
VI1074A0	4X16 SCREW FOR PLASTIC	1.000	PC																																		
VI1930A1	ST. STEEL 5X20 CHIP SCREW	4.000	PC																																		
VI1996A0	M5x35 SCREW	3.000	PC																																		
VM2274A0	GROOVED BUSHING	1.000	PC																																		
VM2305A0	6 SERIES DOOR CAP FIXING PAWL	3.000	PC																																		
VM2384B0		1.000	PC																																		
VP1081A0	UPPER HINGE CAP FOR UPPER INNER GLASS	1.000	PC																																		
KVM2260B	MM M RIGHT DOOR -LEFT UPPER CAP KI	<table border="1"> <thead> <tr> <th>Code</th> <th>Description</th> <th>Qty</th> <th>UOM</th> </tr> </thead> <tbody> <tr> <td>VI1103A0</td> <td>40X12 TBSP SCREW FOR PLASTIC</td> <td>1.000</td> <td>PC</td> </tr> <tr> <td>VI1930A1</td> <td>ST. STEEL 5X20 CHIP SCREW</td> <td>4.000</td> <td>PC</td> </tr> <tr> <td>VI1996A0</td> <td>M5x35 SCREW</td> <td>2.000</td> <td>PC</td> </tr> <tr> <td>VM2260B0</td> <td>S6 LEFT UPPER CAP</td> <td>1.000</td> <td>PC</td> </tr> <tr> <td>VM2275A0</td> <td>SMOOTH BUSHING</td> <td>1.000</td> <td>PC</td> </tr> <tr> <td>VM2305A0</td> <td>6 SERIES DOOR CAP FIXING PAWL</td> <td>3.000</td> <td>PC</td> </tr> <tr> <td>VP1081A0</td> <td>UPPER HINGE CAP FOR UPPER INNER GLASS</td> <td>1.000</td> <td>PC</td> </tr> </tbody> </table>	Code		Description	Qty	UOM	VI1103A0	40X12 TBSP SCREW FOR PLASTIC	1.000	PC	VI1930A1	ST. STEEL 5X20 CHIP SCREW	4.000	PC	VI1996A0	M5x35 SCREW	2.000	PC	VM2260B0	S6 LEFT UPPER CAP	1.000	PC	VM2275A0	SMOOTH BUSHING	1.000	PC	VM2305A0	6 SERIES DOOR CAP FIXING PAWL	3.000	PC	VP1081A0	UPPER HINGE CAP FOR UPPER INNER GLASS	1.000	PC		
Code		Description	Qty		UOM																																
VI1103A0		40X12 TBSP SCREW FOR PLASTIC	1.000		PC																																
VI1930A1		ST. STEEL 5X20 CHIP SCREW	4.000		PC																																
VI1996A0		M5x35 SCREW	2.000	PC																																	
VM2260B0		S6 LEFT UPPER CAP	1.000	PC																																	
VM2275A0		SMOOTH BUSHING	1.000	PC																																	
VM2305A0		6 SERIES DOOR CAP FIXING PAWL	3.000	PC																																	
VP1081A0		UPPER HINGE CAP FOR UPPER INNER GLASS	1.000	PC																																	
VI1074A		4X16 SCREW FOR PLASTIC		VI1074A0	4X16 SCREW FOR PLASTIC																																



COMPONENT			SPARE PART																																		
Code	Description	Image	Code	Description	Kit components																																
VI1930A	ST. STEEL 5X20 CHIP SCREW		VI1147A0	5X25 STAINLESS STEEL SCREW																																	
VI1996A	M5x35 SCREW		VI1996A0	M5x35 SCREW																																	
VM2259B	VM2259B0		KVM2259B	MM -M RIGHT DOOR LEFT LOWER CAP KI	<table border="1"> <thead> <tr> <th>Code</th> <th>Description</th> <th>Qty</th> <th>UOM</th> </tr> </thead> <tbody> <tr> <td>VI1103A0</td> <td>40X12 TBSP SCREW FOR PLASTIC</td> <td>1.000</td> <td>PC</td> </tr> <tr> <td>VI1930A1</td> <td>ST. STEEL 5X20 CHIP SCREW</td> <td>4.000</td> <td>PC</td> </tr> <tr> <td>VI1996A0</td> <td>M5x35 SCREW</td> <td>3.000</td> <td>PC</td> </tr> <tr> <td>VM2259B0</td> <td>VM2259B0</td> <td>1.000</td> <td>PC</td> </tr> <tr> <td>VM2274A0</td> <td>GROOVED BUSHING</td> <td>1.000</td> <td>PC</td> </tr> <tr> <td>VM2305A0</td> <td>6 SERIES DOOR CAP FIXING PAWL</td> <td>3.000</td> <td>PC</td> </tr> <tr> <td>VP1080A0</td> <td>UPPER HINGE CAP FOR LOWER INNER GLASS</td> <td>1.000</td> <td>PC</td> </tr> </tbody> </table>	Code	Description	Qty	UOM	VI1103A0	40X12 TBSP SCREW FOR PLASTIC	1.000	PC	VI1930A1	ST. STEEL 5X20 CHIP SCREW	4.000	PC	VI1996A0	M5x35 SCREW	3.000	PC	VM2259B0	VM2259B0	1.000	PC	VM2274A0	GROOVED BUSHING	1.000	PC	VM2305A0	6 SERIES DOOR CAP FIXING PAWL	3.000	PC	VP1080A0	UPPER HINGE CAP FOR LOWER INNER GLASS	1.000	PC
Code	Description	Qty	UOM																																		
VI1103A0	40X12 TBSP SCREW FOR PLASTIC	1.000	PC																																		
VI1930A1	ST. STEEL 5X20 CHIP SCREW	4.000	PC																																		
VI1996A0	M5x35 SCREW	3.000	PC																																		
VM2259B0	VM2259B0	1.000	PC																																		
VM2274A0	GROOVED BUSHING	1.000	PC																																		
VM2305A0	6 SERIES DOOR CAP FIXING PAWL	3.000	PC																																		
VP1080A0	UPPER HINGE CAP FOR LOWER INNER GLASS	1.000	PC																																		
VM2274A	GROOVED BUSHING		KVM2274A	GROOVED PIN BUSHING KIT	<table border="1"> <thead> <tr> <th>Code</th> <th>Description</th> <th>Qty</th> <th>UOM</th> </tr> </thead> <tbody> <tr> <td>VM2274A0</td> <td>GROOVED BUSHING</td> <td>1.000</td> <td>PC</td> </tr> </tbody> </table>	Code	Description	Qty	UOM	VM2274A0	GROOVED BUSHING	1.000	PC																								
Code	Description	Qty	UOM																																		
VM2274A0	GROOVED BUSHING	1.000	PC																																		
			K0B1126AR	BAKERTOP MM RIGHT DOOR LOWER BEAM KIT	<table border="1"> <thead> <tr> <th>Code</th> <th>Description</th> <th>Qty</th> <th>UOM</th> </tr> </thead> <tbody> <tr> <td>0B1126A1</td> <td>MM BT DOOR LOWER CROSS BAR</td> <td>1.000</td> <td>PC</td> </tr> <tr> <td>RC1200A0</td> <td>ED=4 WIRE D.=0.5 COMPRESSIO N SPRING</td> <td>2.000</td> <td>PC</td> </tr> <tr> <td>VI1220A1</td> <td>4,2x12 TCB SELF-TAPPIN G SCREW</td> <td>1.000</td> <td>PC</td> </tr> <tr> <td>VI1996A0</td> <td>M5x35 SCREW</td> <td>7.000</td> <td>PC</td> </tr> </tbody> </table>	Code	Description	Qty	UOM	0B1126A1	MM BT DOOR LOWER CROSS BAR	1.000	PC	RC1200A0	ED=4 WIRE D.=0.5 COMPRESSIO N SPRING	2.000	PC	VI1220A1	4,2x12 TCB SELF-TAPPIN G SCREW	1.000	PC	VI1996A0	M5x35 SCREW	7.000	PC												
Code	Description	Qty	UOM																																		
0B1126A1	MM BT DOOR LOWER CROSS BAR	1.000	PC																																		
RC1200A0	ED=4 WIRE D.=0.5 COMPRESSIO N SPRING	2.000	PC																																		
VI1220A1	4,2x12 TCB SELF-TAPPIN G SCREW	1.000	PC																																		
VI1996A0	M5x35 SCREW	7.000	PC																																		



COMPONENT			SPARE PART																																																			
Code	Description	Image	Code	Description	Kit components																																																	
VM2274A	GROOVED BUSHING		K0B1126AR	BAKERTOP MM RIGHT DOOR LOWER BEAM KIT	<table border="1"> <thead> <tr> <th>Code</th> <th>Description</th> <th>Qty</th> <th>UOM</th> </tr> </thead> <tbody> <tr> <td>VM1794A0</td> <td>250x4.8 PA66 BLACK CLAMP</td> <td>2.000</td> <td>PC</td> </tr> <tr> <td>VM2103A0</td> <td>CLAMP LOCK</td> <td>2.000</td> <td>PC</td> </tr> <tr> <td>VM2259A1</td> <td>6 SERIES DOOR LOWER LEFT CAP</td> <td>1.000</td> <td>PC</td> </tr> <tr> <td>VM2261A1</td> <td>MM DOOR LOWER RIGHT CAP</td> <td>1.000</td> <td>PC</td> </tr> <tr> <td>VM2267A0</td> <td>INTERNAL GLASS LOCKING SYSTEM SLIDER</td> <td>1.000</td> <td>PC</td> </tr> <tr> <td>VM2269A0</td> <td>INTERNAL GLASS LOCKING SYSTEM CAP</td> <td>1.000</td> <td>PC</td> </tr> <tr> <td>VM2274A0</td> <td>GROOVED BUSHING</td> <td>1.000</td> <td>PC</td> </tr> <tr> <td>VM2305A0</td> <td>6 SERIES DOOR CAP FIXING PAWL</td> <td>7.000</td> <td>PC</td> </tr> </tbody> </table>	Code	Description	Qty	UOM	VM1794A0	250x4.8 PA66 BLACK CLAMP	2.000	PC	VM2103A0	CLAMP LOCK	2.000	PC	VM2259A1	6 SERIES DOOR LOWER LEFT CAP	1.000	PC	VM2261A1	MM DOOR LOWER RIGHT CAP	1.000	PC	VM2267A0	INTERNAL GLASS LOCKING SYSTEM SLIDER	1.000	PC	VM2269A0	INTERNAL GLASS LOCKING SYSTEM CAP	1.000	PC	VM2274A0	GROOVED BUSHING	1.000	PC	VM2305A0	6 SERIES DOOR CAP FIXING PAWL	7.000	PC													
			Code	Description	Qty	UOM																																																
VM1794A0	250x4.8 PA66 BLACK CLAMP	2.000	PC																																																			
VM2103A0	CLAMP LOCK	2.000	PC																																																			
VM2259A1	6 SERIES DOOR LOWER LEFT CAP	1.000	PC																																																			
VM2261A1	MM DOOR LOWER RIGHT CAP	1.000	PC																																																			
VM2267A0	INTERNAL GLASS LOCKING SYSTEM SLIDER	1.000	PC																																																			
VM2269A0	INTERNAL GLASS LOCKING SYSTEM CAP	1.000	PC																																																			
VM2274A0	GROOVED BUSHING	1.000	PC																																																			
VM2305A0	6 SERIES DOOR CAP FIXING PAWL	7.000	PC																																																			
K0B1126AL	EU AND 2/1 MM LEFT DOOR LOWER BEAM KIT	<table border="1"> <thead> <tr> <th>Code</th> <th>Description</th> <th>Qty</th> <th>UOM</th> </tr> </thead> <tbody> <tr> <td>0B1126A1</td> <td>MM BT DOOR LOWER CROSS BAR</td> <td>1.000</td> <td>PC</td> </tr> <tr> <td>RC1200A0</td> <td>ED=4 WIRE D.=0.5 COMPRESSION SPRING</td> <td>2.000</td> <td>PC</td> </tr> <tr> <td>VI1220A1</td> <td>4,2x12 TCB SELF-TAPPING SCREW</td> <td>1.000</td> <td>PC</td> </tr> <tr> <td>VI1996A0</td> <td>M5x35 SCREW</td> <td>7.000</td> <td>PC</td> </tr> <tr> <td>VM1794A0</td> <td>250x4.8 PA66 BLACK CLAMP</td> <td>2.000</td> <td>PC</td> </tr> <tr> <td>VM2103A0</td> <td>CLAMP LOCK</td> <td>2.000</td> <td>PC</td> </tr> <tr> <td>VM2267A0</td> <td>INTERNAL GLASS LOCKING SYSTEM SLIDER</td> <td>1.000</td> <td>PC</td> </tr> <tr> <td>VM2269A0</td> <td>INTERNAL GLASS LOCKING SYSTEM CAP</td> <td>1.000</td> <td>PC</td> </tr> <tr> <td>VM2274A0</td> <td>GROOVED BUSHING</td> <td>1.000</td> <td>PC</td> </tr> <tr> <td>VM2305A0</td> <td>6 SERIES DOOR CAP FIXING PAWL</td> <td>7.000</td> <td>PC</td> </tr> <tr> <td>VM2384A0</td> <td>MM LEFT DOOR RIGHT LOWER CAP</td> <td>1.000</td> <td>PC</td> </tr> <tr> <td>VM2386A1</td> <td>LEFT MM DOOR LOWER LEFT CAP</td> <td>1.000</td> <td>PC</td> </tr> </tbody> </table>	Code	Description	Qty	UOM	0B1126A1	MM BT DOOR LOWER CROSS BAR	1.000	PC	RC1200A0	ED=4 WIRE D.=0.5 COMPRESSION SPRING	2.000	PC	VI1220A1	4,2x12 TCB SELF-TAPPING SCREW	1.000	PC	VI1996A0	M5x35 SCREW	7.000	PC	VM1794A0	250x4.8 PA66 BLACK CLAMP	2.000	PC	VM2103A0	CLAMP LOCK	2.000	PC	VM2267A0	INTERNAL GLASS LOCKING SYSTEM SLIDER	1.000	PC	VM2269A0	INTERNAL GLASS LOCKING SYSTEM CAP	1.000	PC	VM2274A0	GROOVED BUSHING	1.000	PC	VM2305A0	6 SERIES DOOR CAP FIXING PAWL	7.000	PC	VM2384A0	MM LEFT DOOR RIGHT LOWER CAP	1.000	PC	VM2386A1	LEFT MM DOOR LOWER LEFT CAP	1.000	PC
Code	Description	Qty	UOM																																																			
0B1126A1	MM BT DOOR LOWER CROSS BAR	1.000	PC																																																			
RC1200A0	ED=4 WIRE D.=0.5 COMPRESSION SPRING	2.000	PC																																																			
VI1220A1	4,2x12 TCB SELF-TAPPING SCREW	1.000	PC																																																			
VI1996A0	M5x35 SCREW	7.000	PC																																																			
VM1794A0	250x4.8 PA66 BLACK CLAMP	2.000	PC																																																			
VM2103A0	CLAMP LOCK	2.000	PC																																																			
VM2267A0	INTERNAL GLASS LOCKING SYSTEM SLIDER	1.000	PC																																																			
VM2269A0	INTERNAL GLASS LOCKING SYSTEM CAP	1.000	PC																																																			
VM2274A0	GROOVED BUSHING	1.000	PC																																																			
VM2305A0	6 SERIES DOOR CAP FIXING PAWL	7.000	PC																																																			
VM2384A0	MM LEFT DOOR RIGHT LOWER CAP	1.000	PC																																																			
VM2386A1	LEFT MM DOOR LOWER LEFT CAP	1.000	PC																																																			



COMPONENT			SPARE PART																																																																																									
Code	Description	Image	Code	Description	Kit components																																																																																							
VM2274A	GROOVED BUSHING		K0B1122AR	CHEFTOP MM RIGHT DOOR LOWER BEAM KIT	<table border="1"> <thead> <tr> <th>Code</th> <th>Description</th> <th>Qty</th> <th>UOM</th> </tr> </thead> <tbody> <tr> <td>0B1122A1</td> <td>750MM DOOR LOWER FRAME SHAPE</td> <td>1.000</td> <td>PC</td> </tr> <tr> <td>RC1200A0</td> <td>ED=4 WIRE D.=0.5 COMPRESSIO N SPRING</td> <td>2.000</td> <td>PC</td> </tr> <tr> <td>V11220A1</td> <td>4,2x12 TCB SELF-TAPPIN G SCREW</td> <td>1.000</td> <td>PC</td> </tr> <tr> <td>V11996A0</td> <td>M5x35 SCREW</td> <td>7.000</td> <td>PC</td> </tr> <tr> <td>VM1794A0</td> <td>250x4.8 PA66 BLACK CLAMP</td> <td>2.000</td> <td>PC</td> </tr> <tr> <td>VM2103A0</td> <td>CLAMP LOCK</td> <td>2.000</td> <td>PC</td> </tr> <tr> <td>VM2259A1</td> <td>6 SERIES DOOR LOWER LEFT CAP</td> <td>1.000</td> <td>PC</td> </tr> <tr> <td>VM2261A1</td> <td>MM DOOR LOWER RIGHT CAP</td> <td>1.000</td> <td>PC</td> </tr> <tr> <td>VM2267A0</td> <td>INTERNAL GLASS LOCKING SYSTEM SLIDER</td> <td>1.000</td> <td>PC</td> </tr> <tr> <td>VM2269A0</td> <td>INTERNAL GLASS LOCKING SYSTEM CAP</td> <td>1.000</td> <td>PC</td> </tr> <tr> <td>VM2274A0</td> <td>GROOVED BUSHING</td> <td>1.000</td> <td>PC</td> </tr> <tr> <td>VM2305A0</td> <td>6 SERIES DOOR CAP FIXING PAWL</td> <td>7.000</td> <td>PC</td> </tr> </tbody> </table>	Code	Description	Qty	UOM	0B1122A1	750MM DOOR LOWER FRAME SHAPE	1.000	PC	RC1200A0	ED=4 WIRE D.=0.5 COMPRESSIO N SPRING	2.000	PC	V11220A1	4,2x12 TCB SELF-TAPPIN G SCREW	1.000	PC	V11996A0	M5x35 SCREW	7.000	PC	VM1794A0	250x4.8 PA66 BLACK CLAMP	2.000	PC	VM2103A0	CLAMP LOCK	2.000	PC	VM2259A1	6 SERIES DOOR LOWER LEFT CAP	1.000	PC	VM2261A1	MM DOOR LOWER RIGHT CAP	1.000	PC	VM2267A0	INTERNAL GLASS LOCKING SYSTEM SLIDER	1.000	PC	VM2269A0	INTERNAL GLASS LOCKING SYSTEM CAP	1.000	PC	VM2274A0	GROOVED BUSHING	1.000	PC	VM2305A0	6 SERIES DOOR CAP FIXING PAWL	7.000	PC	K0B1122AL	CHEFTOP MM LEFT DOOR LOWER BEAM KIT	<table border="1"> <thead> <tr> <th>Code</th> <th>Description</th> <th>Qty</th> <th>UOM</th> </tr> </thead> <tbody> <tr> <td>0B1122A1</td> <td>750MM DOOR LOWER FRAME SHAPE</td> <td>1.000</td> <td>PC</td> </tr> <tr> <td>RC1200A0</td> <td>ED=4 WIRE D.=0.5 COMPRESSIO N SPRING</td> <td>2.000</td> <td>PC</td> </tr> <tr> <td>V11220A1</td> <td>4,2x12 TCB SELF-TAPPIN G SCREW</td> <td>1.000</td> <td>PC</td> </tr> <tr> <td>V11996A0</td> <td>M5x35 SCREW</td> <td>7.000</td> <td>PC</td> </tr> <tr> <td>VM1794A0</td> <td>250x4.8 PA66 BLACK CLAMP</td> <td>2.000</td> <td>PC</td> </tr> <tr> <td>VM2103A0</td> <td>CLAMP LOCK</td> <td>2.000</td> <td>PC</td> </tr> <tr> <td>VM2267A0</td> <td>INTERNAL GLASS LOCKING SYSTEM SLIDER</td> <td>1.000</td> <td>PC</td> </tr> </tbody> </table>	Code	Description	Qty	UOM	0B1122A1	750MM DOOR LOWER FRAME SHAPE	1.000	PC	RC1200A0	ED=4 WIRE D.=0.5 COMPRESSIO N SPRING	2.000	PC	V11220A1	4,2x12 TCB SELF-TAPPIN G SCREW	1.000	PC	V11996A0	M5x35 SCREW	7.000	PC	VM1794A0	250x4.8 PA66 BLACK CLAMP	2.000	PC	VM2103A0	CLAMP LOCK	2.000	PC	VM2267A0	INTERNAL GLASS LOCKING SYSTEM SLIDER	1.000	PC
			Code	Description	Qty	UOM																																																																																						
0B1122A1	750MM DOOR LOWER FRAME SHAPE	1.000	PC																																																																																									
RC1200A0	ED=4 WIRE D.=0.5 COMPRESSIO N SPRING	2.000	PC																																																																																									
V11220A1	4,2x12 TCB SELF-TAPPIN G SCREW	1.000	PC																																																																																									
V11996A0	M5x35 SCREW	7.000	PC																																																																																									
VM1794A0	250x4.8 PA66 BLACK CLAMP	2.000	PC																																																																																									
VM2103A0	CLAMP LOCK	2.000	PC																																																																																									
VM2259A1	6 SERIES DOOR LOWER LEFT CAP	1.000	PC																																																																																									
VM2261A1	MM DOOR LOWER RIGHT CAP	1.000	PC																																																																																									
VM2267A0	INTERNAL GLASS LOCKING SYSTEM SLIDER	1.000	PC																																																																																									
VM2269A0	INTERNAL GLASS LOCKING SYSTEM CAP	1.000	PC																																																																																									
VM2274A0	GROOVED BUSHING	1.000	PC																																																																																									
VM2305A0	6 SERIES DOOR CAP FIXING PAWL	7.000	PC																																																																																									
Code	Description	Qty	UOM																																																																																									
0B1122A1	750MM DOOR LOWER FRAME SHAPE	1.000	PC																																																																																									
RC1200A0	ED=4 WIRE D.=0.5 COMPRESSIO N SPRING	2.000	PC																																																																																									
V11220A1	4,2x12 TCB SELF-TAPPIN G SCREW	1.000	PC																																																																																									
V11996A0	M5x35 SCREW	7.000	PC																																																																																									
VM1794A0	250x4.8 PA66 BLACK CLAMP	2.000	PC																																																																																									
VM2103A0	CLAMP LOCK	2.000	PC																																																																																									
VM2267A0	INTERNAL GLASS LOCKING SYSTEM SLIDER	1.000	PC																																																																																									





COMPONENT			SPARE PART																		
Code	Description	Image	Code	Description	Kit components																
VP1080A	UPPER HINGE CAP FOR LOWER INNER GLASS		KVM2259B	MM -M RIGHT DOOR LEFT LOWER CAP KI	<table border="1"> <thead> <tr> <th>Code</th> <th>Description</th> <th>Qty</th> <th>UOM</th> </tr> </thead> <tbody> <tr> <td>VM2274A0</td> <td>GROOVED BUSHING</td> <td>1.000</td> <td>PC</td> </tr> <tr> <td>VM2305A0</td> <td>6 SERIES DOOR CAP FIXING PAWL</td> <td>3.000</td> <td>PC</td> </tr> <tr> <td>VP1080A0</td> <td>UPPER HINGE CAP FOR LOWER INNER GLASS</td> <td>1.000</td> <td>PC</td> </tr> </tbody> </table>	Code	Description	Qty	UOM	VM2274A0	GROOVED BUSHING	1.000	PC	VM2305A0	6 SERIES DOOR CAP FIXING PAWL	3.000	PC	VP1080A0	UPPER HINGE CAP FOR LOWER INNER GLASS	1.000	PC
					Code	Description	Qty	UOM													
VM2274A0	GROOVED BUSHING	1.000	PC																		
VM2305A0	6 SERIES DOOR CAP FIXING PAWL	3.000	PC																		
VP1080A0	UPPER HINGE CAP FOR LOWER INNER GLASS	1.000	PC																		
VM1679A	VM1679A0		VM1679A0	VM1679A0																	
VM1681A	VM1681A0		VM1681A0	VM1681A0																	
VM2284B	750 SERIES DRIP PROFILE KIT		KVM2284B	750 -M SERIES DRIP PROFILE KIT	<table border="1"> <thead> <tr> <th>Code</th> <th>Description</th> <th>Qty</th> <th>UOM</th> </tr> </thead> <tbody> <tr> <td>VM2284B0</td> <td>750 SERIES DRIP PROFILE KIT</td> <td>1.000</td> <td>PC</td> </tr> </tbody> </table>	Code	Description	Qty	UOM	VM2284B0	750 SERIES DRIP PROFILE KIT	1.000	PC								
					Code	Description	Qty	UOM													
VM2284B0	750 SERIES DRIP PROFILE KIT	1.000	PC																		
VM2312A	6 S. DRIP PROFILE DRAIN LEFT PIPE		KVM2312A	M.M. DRIP TRAY LEFT DRAIN PIPE KI	<table border="1"> <thead> <tr> <th>Code</th> <th>Description</th> <th>Qty</th> <th>UOM</th> </tr> </thead> <tbody> <tr> <td>VI1220A1</td> <td>4,2x12 TCB SELF-TAPPING SCREW</td> <td>1.000</td> <td>PC</td> </tr> <tr> <td>VM2312A0</td> <td>6 S. DRIP PROFILE DRAIN LEFT PIPE</td> <td>1.000</td> <td>PC</td> </tr> </tbody> </table>	Code	Description	Qty	UOM	VI1220A1	4,2x12 TCB SELF-TAPPING SCREW	1.000	PC	VM2312A0	6 S. DRIP PROFILE DRAIN LEFT PIPE	1.000	PC				
Code	Description	Qty	UOM																		
VI1220A1	4,2x12 TCB SELF-TAPPING SCREW	1.000	PC																		
VM2312A0	6 S. DRIP PROFILE DRAIN LEFT PIPE	1.000	PC																		





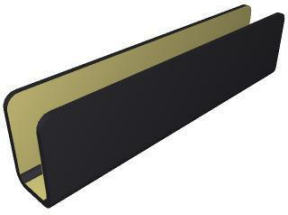

COMPONENT			SPARE PART																														
Code	Description	Image	Code	Description	Kit components																												
VM2314A	6 S. DRIP PROFILE CAP		KVM2314A	MIND.Maps DRIP TRAY CAP	<table border="1"> <thead> <tr> <th>Code</th> <th>Description</th> <th>Qty</th> <th>UOM</th> </tr> </thead> <tbody> <tr> <td>VM2314A0</td> <td>6 S. DRIP PROFILE CAP</td> <td>1.000</td> <td>PC</td> </tr> </tbody> </table>	Code	Description	Qty	UOM	VM2314A0	6 S. DRIP PROFILE CAP	1.000	PC																				
Code	Description	Qty	UOM																														
VM2314A0	6 S. DRIP PROFILE CAP	1.000	PC																														
VM1630A	INTERNAL GLASS PUSHING CAP		KVM1630A	CAP FOR INTERNAL GLASS 10 PCS KIT	<table border="1"> <thead> <tr> <th>Code</th> <th>Description</th> <th>Qty</th> <th>UOM</th> </tr> </thead> <tbody> <tr> <td>VM1630A1</td> <td>INTERNAL GLASS PUSHING CAP</td> <td>10.000</td> <td>PC</td> </tr> </tbody> </table>	Code	Description	Qty	UOM	VM1630A1	INTERNAL GLASS PUSHING CAP	10.000	PC																				
Code	Description	Qty	UOM																														
VM1630A1	INTERNAL GLASS PUSHING CAP	10.000	PC																														
VM2315B	S6 INTERNAL GLASS SUPPORT		KVM2315B	3 PCS MM -M INTERNAL GLASS SUPPORT KIT	<table border="1"> <thead> <tr> <th>Code</th> <th>Description</th> <th>Qty</th> <th>UOM</th> </tr> </thead> <tbody> <tr> <td>VI1220A1</td> <td>4,2x12 TCB SELF-TAPPING SCREW</td> <td>3.000</td> <td>PC</td> </tr> <tr> <td>VM1630A1</td> <td>INTERNAL GLASS PUSHING CAP</td> <td>3.000</td> <td>PC</td> </tr> <tr> <td>VM2315B0</td> <td>S6 INTERNAL GLASS SUPPORT</td> <td>3.000</td> <td>PC</td> </tr> </tbody> </table>	Code	Description	Qty	UOM	VI1220A1	4,2x12 TCB SELF-TAPPING SCREW	3.000	PC	VM1630A1	INTERNAL GLASS PUSHING CAP	3.000	PC	VM2315B0	S6 INTERNAL GLASS SUPPORT	3.000	PC												
Code	Description	Qty	UOM																														
VI1220A1	4,2x12 TCB SELF-TAPPING SCREW	3.000	PC																														
VM1630A1	INTERNAL GLASS PUSHING CAP	3.000	PC																														
VM2315B0	S6 INTERNAL GLASS SUPPORT	3.000	PC																														
CR1103A	INTERNAL GLASS ST. STEEL UPPER HINGE		KCR1103A	INTERNAL GLASS UPPER HINGE KIT	<table border="1"> <thead> <tr> <th>Code</th> <th>Description</th> <th>Qty</th> <th>UOM</th> </tr> </thead> <tbody> <tr> <td>CR1103A0</td> <td>INTERNAL GLASS ST. STEEL UPPER HINGE</td> <td>1.000</td> <td>PC</td> </tr> <tr> <td>GN1182A1</td> <td>INTERNAL GLASS HINGE CR1103-1104 SEAL</td> <td>1.000</td> <td>PC</td> </tr> <tr> <td>VI1810A0</td> <td>M6X6 STAINLESS STEEL FLATHEAD SCREW</td> <td>3.000</td> <td>PC</td> </tr> <tr> <td>VM2399A0</td> <td>DOOR HINGES HEADLESS SCREWS COVER</td> <td>1.000</td> <td>PC</td> </tr> <tr> <td>VM2476A0</td> <td>BL SP H6 INTERNAL GLASS HINGE GASKET</td> <td>1.000</td> <td>PC</td> </tr> <tr> <td>VP1163A0</td> <td>INNER GLASS HOLDING PROFILE - ONE OVENS</td> <td>1.000</td> <td>PC</td> </tr> </tbody> </table>	Code	Description	Qty	UOM	CR1103A0	INTERNAL GLASS ST. STEEL UPPER HINGE	1.000	PC	GN1182A1	INTERNAL GLASS HINGE CR1103-1104 SEAL	1.000	PC	VI1810A0	M6X6 STAINLESS STEEL FLATHEAD SCREW	3.000	PC	VM2399A0	DOOR HINGES HEADLESS SCREWS COVER	1.000	PC	VM2476A0	BL SP H6 INTERNAL GLASS HINGE GASKET	1.000	PC	VP1163A0	INNER GLASS HOLDING PROFILE - ONE OVENS	1.000	PC
Code	Description	Qty	UOM																														
CR1103A0	INTERNAL GLASS ST. STEEL UPPER HINGE	1.000	PC																														
GN1182A1	INTERNAL GLASS HINGE CR1103-1104 SEAL	1.000	PC																														
VI1810A0	M6X6 STAINLESS STEEL FLATHEAD SCREW	3.000	PC																														
VM2399A0	DOOR HINGES HEADLESS SCREWS COVER	1.000	PC																														
VM2476A0	BL SP H6 INTERNAL GLASS HINGE GASKET	1.000	PC																														
VP1163A0	INNER GLASS HOLDING PROFILE - ONE OVENS	1.000	PC																														

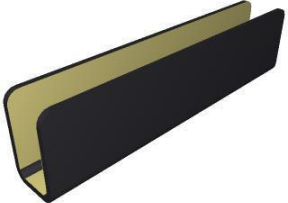

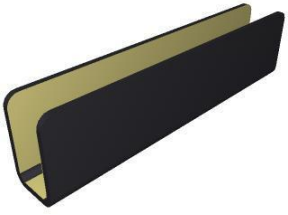



COMPONENT			SPARE PART																														
Code	Description	Image	Code	Description	Kit components																												
GN1182A	INTERNAL GLASS HINGE CR1103-1104 SEAL		KCR1104A	INTERNAL GLASS LOWER HINGE KIT	<table border="1"> <thead> <tr> <th>Code</th> <th>Description</th> <th>Qty</th> <th>UOM</th> </tr> </thead> <tbody> <tr> <td>CR1104A0</td> <td>INTERNAL GLASS ST. STEEL LOWER HINGE</td> <td>1.000</td> <td>PC</td> </tr> <tr> <td>GN1182A1</td> <td>INTERNAL GLASS HINGE CR1103-1104 SEAL</td> <td>1.000</td> <td>PC</td> </tr> <tr> <td>VI1810A0</td> <td>M6X6 STAINLESS STEEL FLATHEAD SCREW</td> <td>3.000</td> <td>PC</td> </tr> <tr> <td>VM2399A0</td> <td>DOOR HINGES HEADLESS SCREWS COVER</td> <td>1.000</td> <td>PC</td> </tr> <tr> <td>VM2476A0</td> <td>BL SP H6 INTERNAL GLASS HINGE GASKET</td> <td>1.000</td> <td>PC</td> </tr> <tr> <td>VP1163A0</td> <td>INNER GLASS HOLDING PROFILE - ONE OVENS</td> <td>1.000</td> <td>PC</td> </tr> </tbody> </table>	Code	Description	Qty	UOM	CR1104A0	INTERNAL GLASS ST. STEEL LOWER HINGE	1.000	PC	GN1182A1	INTERNAL GLASS HINGE CR1103-1104 SEAL	1.000	PC	VI1810A0	M6X6 STAINLESS STEEL FLATHEAD SCREW	3.000	PC	VM2399A0	DOOR HINGES HEADLESS SCREWS COVER	1.000	PC	VM2476A0	BL SP H6 INTERNAL GLASS HINGE GASKET	1.000	PC	VP1163A0	INNER GLASS HOLDING PROFILE - ONE OVENS	1.000	PC
			Code	Description	Qty	UOM																											
CR1104A0	INTERNAL GLASS ST. STEEL LOWER HINGE	1.000	PC																														
GN1182A1	INTERNAL GLASS HINGE CR1103-1104 SEAL	1.000	PC																														
VI1810A0	M6X6 STAINLESS STEEL FLATHEAD SCREW	3.000	PC																														
VM2399A0	DOOR HINGES HEADLESS SCREWS COVER	1.000	PC																														
VM2476A0	BL SP H6 INTERNAL GLASS HINGE GASKET	1.000	PC																														
VP1163A0	INNER GLASS HOLDING PROFILE - ONE OVENS	1.000	PC																														
KCR1103A	INTERNAL GLASS UPPER HINGE KIT	<table border="1"> <thead> <tr> <th>Code</th> <th>Description</th> <th>Qty</th> <th>UOM</th> </tr> </thead> <tbody> <tr> <td>CR1103A0</td> <td>INTERNAL GLASS ST. STEEL UPPER HINGE</td> <td>1.000</td> <td>PC</td> </tr> <tr> <td>GN1182A1</td> <td>INTERNAL GLASS HINGE CR1103-1104 SEAL</td> <td>1.000</td> <td>PC</td> </tr> <tr> <td>VI1810A0</td> <td>M6X6 STAINLESS STEEL FLATHEAD SCREW</td> <td>3.000</td> <td>PC</td> </tr> <tr> <td>VM2399A0</td> <td>DOOR HINGES HEADLESS SCREWS COVER</td> <td>1.000</td> <td>PC</td> </tr> <tr> <td>VM2476A0</td> <td>BL SP H6 INTERNAL GLASS HINGE GASKET</td> <td>1.000</td> <td>PC</td> </tr> <tr> <td>VP1163A0</td> <td>INNER GLASS HOLDING PROFILE - ONE OVENS</td> <td>1.000</td> <td>PC</td> </tr> </tbody> </table>	Code	Description	Qty	UOM	CR1103A0	INTERNAL GLASS ST. STEEL UPPER HINGE	1.000	PC	GN1182A1	INTERNAL GLASS HINGE CR1103-1104 SEAL	1.000	PC	VI1810A0	M6X6 STAINLESS STEEL FLATHEAD SCREW	3.000	PC	VM2399A0	DOOR HINGES HEADLESS SCREWS COVER	1.000	PC	VM2476A0	BL SP H6 INTERNAL GLASS HINGE GASKET	1.000	PC	VP1163A0	INNER GLASS HOLDING PROFILE - ONE OVENS	1.000	PC			
Code	Description	Qty	UOM																														
CR1103A0	INTERNAL GLASS ST. STEEL UPPER HINGE	1.000	PC																														
GN1182A1	INTERNAL GLASS HINGE CR1103-1104 SEAL	1.000	PC																														
VI1810A0	M6X6 STAINLESS STEEL FLATHEAD SCREW	3.000	PC																														
VM2399A0	DOOR HINGES HEADLESS SCREWS COVER	1.000	PC																														
VM2476A0	BL SP H6 INTERNAL GLASS HINGE GASKET	1.000	PC																														
VP1163A0	INNER GLASS HOLDING PROFILE - ONE OVENS	1.000	PC																														

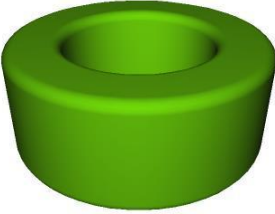



COMPONENT			SPARE PART																														
Code	Description	Image	Code	Description	Kit components																												
VM2399A	DOOR HINGES HEADLESS SCREWS COVER		VM2399A0	DOOR HINGES HEADLESS SCREWS COVER																													
CR1104A	INTERNAL GLASS ST. STEEL LOWER HINGE		KCR1104A	INTERNAL GLASS LOWER HINGE KIT	<table border="1"> <thead> <tr> <th>Code</th> <th>Description</th> <th>Qty</th> <th>UOM</th> </tr> </thead> <tbody> <tr> <td>CR1104A0</td> <td>INTERNAL GLASS ST. STEEL LOWER HINGE</td> <td>1.000</td> <td>PC</td> </tr> <tr> <td>GN1182A1</td> <td>INTERNAL GLASS HINGE CR1103-1104 SEAL</td> <td>1.000</td> <td>PC</td> </tr> <tr> <td>VI1810A0</td> <td>M6X6 STAINLESS STEEL FLATHEAD SCREW</td> <td>3.000</td> <td>PC</td> </tr> <tr> <td>VM2399A0</td> <td>DOOR HINGES HEADLESS SCREWS COVER</td> <td>1.000</td> <td>PC</td> </tr> <tr> <td>VM2476A0</td> <td>BL SP H6 INTERNAL GLASS HINGE GASKET</td> <td>1.000</td> <td>PC</td> </tr> <tr> <td>VP1163A0</td> <td>INNER GLASS HOLDING PROFILE - ONE OVENS</td> <td>1.000</td> <td>PC</td> </tr> </tbody> </table>	Code	Description	Qty	UOM	CR1104A0	INTERNAL GLASS ST. STEEL LOWER HINGE	1.000	PC	GN1182A1	INTERNAL GLASS HINGE CR1103-1104 SEAL	1.000	PC	VI1810A0	M6X6 STAINLESS STEEL FLATHEAD SCREW	3.000	PC	VM2399A0	DOOR HINGES HEADLESS SCREWS COVER	1.000	PC	VM2476A0	BL SP H6 INTERNAL GLASS HINGE GASKET	1.000	PC	VP1163A0	INNER GLASS HOLDING PROFILE - ONE OVENS	1.000	PC
Code	Description	Qty	UOM																														
CR1104A0	INTERNAL GLASS ST. STEEL LOWER HINGE	1.000	PC																														
GN1182A1	INTERNAL GLASS HINGE CR1103-1104 SEAL	1.000	PC																														
VI1810A0	M6X6 STAINLESS STEEL FLATHEAD SCREW	3.000	PC																														
VM2399A0	DOOR HINGES HEADLESS SCREWS COVER	1.000	PC																														
VM2476A0	BL SP H6 INTERNAL GLASS HINGE GASKET	1.000	PC																														
VP1163A0	INNER GLASS HOLDING PROFILE - ONE OVENS	1.000	PC																														
GN1182A	INTERNAL GLASS HINGE CR1103-1104 SEAL		KCR1104A	INTERNAL GLASS LOWER HINGE KIT	<table border="1"> <thead> <tr> <th>Code</th> <th>Description</th> <th>Qty</th> <th>UOM</th> </tr> </thead> <tbody> <tr> <td>CR1104A0</td> <td>INTERNAL GLASS ST. STEEL LOWER HINGE</td> <td>1.000</td> <td>PC</td> </tr> <tr> <td>GN1182A1</td> <td>INTERNAL GLASS HINGE CR1103-1104 SEAL</td> <td>1.000</td> <td>PC</td> </tr> <tr> <td>VI1810A0</td> <td>M6X6 STAINLESS STEEL FLATHEAD SCREW</td> <td>3.000</td> <td>PC</td> </tr> <tr> <td>VM2399A0</td> <td>DOOR HINGES HEADLESS SCREWS COVER</td> <td>1.000</td> <td>PC</td> </tr> </tbody> </table>	Code	Description	Qty	UOM	CR1104A0	INTERNAL GLASS ST. STEEL LOWER HINGE	1.000	PC	GN1182A1	INTERNAL GLASS HINGE CR1103-1104 SEAL	1.000	PC	VI1810A0	M6X6 STAINLESS STEEL FLATHEAD SCREW	3.000	PC	VM2399A0	DOOR HINGES HEADLESS SCREWS COVER	1.000	PC								
Code	Description	Qty	UOM																														
CR1104A0	INTERNAL GLASS ST. STEEL LOWER HINGE	1.000	PC																														
GN1182A1	INTERNAL GLASS HINGE CR1103-1104 SEAL	1.000	PC																														
VI1810A0	M6X6 STAINLESS STEEL FLATHEAD SCREW	3.000	PC																														
VM2399A0	DOOR HINGES HEADLESS SCREWS COVER	1.000	PC																														

COMPONENT			SPARE PART																											
Code	Description	Image	Code	Description	Kit components																									
GN1182A	INTERNAL GLASS HINGE CR1103-1104 SEAL		KCR1104A	INTERNAL GLASS LOWER HINGE KIT	<table border="1"> <thead> <tr> <th>Code</th> <th>Description</th> <th>Qty</th> <th>UOM</th> </tr> </thead> <tbody> <tr> <td>VM2476A0</td> <td>BL SP H6 INTERNAL GLASS HINGE GASKET</td> <td>1.000</td> <td>PC</td> </tr> <tr> <td>VP1163A0</td> <td>INNER GLASS HOLDING PROFILE - ONE OVENS</td> <td>1.000</td> <td>PC</td> </tr> </tbody> </table>	Code	Description	Qty	UOM	VM2476A0	BL SP H6 INTERNAL GLASS HINGE GASKET	1.000	PC	VP1163A0	INNER GLASS HOLDING PROFILE - ONE OVENS	1.000	PC													
			Code	Description	Qty	UOM																								
VM2476A0	BL SP H6 INTERNAL GLASS HINGE GASKET	1.000	PC																											
VP1163A0	INNER GLASS HOLDING PROFILE - ONE OVENS	1.000	PC																											
KCR1103A	INTERNAL GLASS UPPER HINGE KIT	<table border="1"> <thead> <tr> <th>Code</th> <th>Description</th> <th>Qty</th> <th>UOM</th> </tr> </thead> <tbody> <tr> <td>CR1103A0</td> <td>INTERNAL GLASS ST. STEEL UPPER HINGE</td> <td>1.000</td> <td>PC</td> </tr> <tr> <td>GN1182A1</td> <td>INTERNAL GLASS HINGE CR1103-1104 SEAL</td> <td>1.000</td> <td>PC</td> </tr> <tr> <td>VI1810A0</td> <td>M6X6 STAINLESS STEEL FLATHEAD SCREW</td> <td>3.000</td> <td>PC</td> </tr> <tr> <td>VM2399A0</td> <td>DOOR HINGES HEADLESS SCREWS COVER</td> <td>1.000</td> <td>PC</td> </tr> <tr> <td>VM2476A0</td> <td>BL SP H6 INTERNAL GLASS HINGE GASKET</td> <td>1.000</td> <td>PC</td> </tr> <tr> <td>VP1163A0</td> <td>INNER GLASS HOLDING PROFILE - ONE OVENS</td> <td>1.000</td> <td>PC</td> </tr> </tbody> </table>	Code	Description	Qty	UOM	CR1103A0	INTERNAL GLASS ST. STEEL UPPER HINGE	1.000	PC	GN1182A1	INTERNAL GLASS HINGE CR1103-1104 SEAL	1.000	PC	VI1810A0	M6X6 STAINLESS STEEL FLATHEAD SCREW	3.000	PC	VM2399A0	DOOR HINGES HEADLESS SCREWS COVER	1.000	PC	VM2476A0	BL SP H6 INTERNAL GLASS HINGE GASKET	1.000	PC	VP1163A0	INNER GLASS HOLDING PROFILE - ONE OVENS	1.000	PC
Code	Description	Qty	UOM																											
CR1103A0	INTERNAL GLASS ST. STEEL UPPER HINGE	1.000	PC																											
GN1182A1	INTERNAL GLASS HINGE CR1103-1104 SEAL	1.000	PC																											
VI1810A0	M6X6 STAINLESS STEEL FLATHEAD SCREW	3.000	PC																											
VM2399A0	DOOR HINGES HEADLESS SCREWS COVER	1.000	PC																											
VM2476A0	BL SP H6 INTERNAL GLASS HINGE GASKET	1.000	PC																											
VP1163A0	INNER GLASS HOLDING PROFILE - ONE OVENS	1.000	PC																											
VM2399A	DOOR HINGES HEADLESS SCREWS COVER		VM2399A0	DOOR HINGES HEADLESS SCREWS COVER																										

COMPONENT			SPARE PART										
Code	Description	Image	Code	Description	Kit components								
VT1280B	XEVC-0511 643x456x6 INNER SINGLE GLASS		KVT1280B	0511 INTERNAL SINGLE GLASS KIT	<table border="1"> <thead> <tr> <th>Code</th> <th>Description</th> <th>Qty</th> <th>UOM</th> </tr> </thead> <tbody> <tr> <td>VT1280B0</td> <td>XEVC-0511 643x456x6 INNER SINGLE GLASS</td> <td>1.000</td> <td>PC</td> </tr> </tbody> </table>	Code	Description	Qty	UOM	VT1280B0	XEVC-0511 643x456x6 INNER SINGLE GLASS	1.000	PC
Code	Description	Qty	UOM										
VT1280B0	XEVC-0511 643x456x6 INNER SINGLE GLASS	1.000	PC										
VM2518A	BOARD COOLING FAN SUPPORT		KVM2518A	PANEL COOLING FAN SUPPORT KIT	<table border="1"> <thead> <tr> <th>Code</th> <th>Description</th> <th>Qty</th> <th>UOM</th> </tr> </thead> <tbody> <tr> <td>VM2518A0</td> <td>BOARD COOLING FAN SUPPORT</td> <td>1.000</td> <td>PC</td> </tr> </tbody> </table>	Code	Description	Qty	UOM	VM2518A0	BOARD COOLING FAN SUPPORT	1.000	PC
Code	Description	Qty	UOM										
VM2518A0	BOARD COOLING FAN SUPPORT	1.000	PC										
VN1179A	CONTROL BOARD 40x40x20mm 12V COOLING FAN		KVN1179A	CONTROL BOARD COOLING FAN KIT	<table border="1"> <thead> <tr> <th>Code</th> <th>Description</th> <th>Qty</th> <th>UOM</th> </tr> </thead> <tbody> <tr> <td>VN1179A1</td> <td>CONTROL BOARD 40x40x20mm 12V COOLING FAN</td> <td>1.000</td> <td>PC</td> </tr> </tbody> </table>	Code	Description	Qty	UOM	VN1179A1	CONTROL BOARD 40x40x20mm 12V COOLING FAN	1.000	PC
Code	Description	Qty	UOM										
VN1179A1	CONTROL BOARD 40x40x20mm 12V COOLING FAN	1.000	PC										
CE1096A	4 POLES MICROFIT 3 M BUS CABLE		KCE1096A	3 M POWER-CONTROL 4 POLES BUS CABLE KIT	<table border="1"> <thead> <tr> <th>Code</th> <th>Description</th> <th>Qty</th> <th>UOM</th> </tr> </thead> <tbody> <tr> <td>CE1096A0</td> <td>4 POLES MICROFIT 3 M BUS CABLE</td> <td>1.000</td> <td>PC</td> </tr> </tbody> </table>	Code	Description	Qty	UOM	CE1096A0	4 POLES MICROFIT 3 M BUS CABLE	1.000	PC
Code	Description	Qty	UOM										
CE1096A0	4 POLES MICROFIT 3 M BUS CABLE	1.000	PC										
CE1285A	EMI ROUND FERRITE MOD.2643801502		OUTOFPRODUCTIO	ITEM OUT OF PRODUCTION									



COMPONENT			SPARE PART																		
Code	Description	Image	Code	Description	Kit components																
VI1074A	4X16 SCREW FOR PLASTIC		VI1074A0	4X16 SCREW FOR PLASTIC																	
MG1099A	MM COMPLETE HANDLE		KMG1099A	MIND.Maps SERIES HANDLE KIT -M	<table border="1"> <thead> <tr> <th>Code</th> <th>Description</th> <th>Qty</th> <th>UOM</th> </tr> </thead> <tbody> <tr> <td>MG1099A1</td> <td>MM COMPLETE HANDLE</td> <td>1.000</td> <td>PC</td> </tr> <tr> <td>VI0239A1</td> <td>SELF-TAPPIN G SCREW 4.2X25 TCB+ INOX</td> <td>4.000</td> <td>PC</td> </tr> <tr> <td>VM1490A0</td> <td>CHEFTOP/BAK ERTOP HANDLE SCREWS COVER</td> <td>2.000</td> <td>PC</td> </tr> </tbody> </table>	Code	Description	Qty	UOM	MG1099A1	MM COMPLETE HANDLE	1.000	PC	VI0239A1	SELF-TAPPIN G SCREW 4.2X25 TCB+ INOX	4.000	PC	VM1490A0	CHEFTOP/BAK ERTOP HANDLE SCREWS COVER	2.000	PC
Code	Description	Qty	UOM																		
MG1099A1	MM COMPLETE HANDLE	1.000	PC																		
VI0239A1	SELF-TAPPIN G SCREW 4.2X25 TCB+ INOX	4.000	PC																		
VM1490A0	CHEFTOP/BAK ERTOP HANDLE SCREWS COVER	2.000	PC																		
CE1052A	CABLE CONNECTION CONTROL - USB MM 750mm		KCE1052A	CONTROL BOARD-USB 650 CONN. CABLE KIT	<table border="1"> <thead> <tr> <th>Code</th> <th>Description</th> <th>Qty</th> <th>UOM</th> </tr> </thead> <tbody> <tr> <td>CE1052A1</td> <td>CABLE CONNECTION CONTROL - USB MM 750m</td> <td>1.000</td> <td>PC</td> </tr> </tbody> </table>	Code	Description	Qty	UOM	CE1052A1	CABLE CONNECTION CONTROL - USB MM 750m	1.000	PC								
Code	Description	Qty	UOM																		
CE1052A1	CABLE CONNECTION CONTROL - USB MM 750m	1.000	PC																		
CE1053B	MM MICROFIT LED BAR POWER SUPPLY CABLE		KCE1053B	LED BAR EXTENSION CABLE KIT	<table border="1"> <thead> <tr> <th>Code</th> <th>Description</th> <th>Qty</th> <th>UOM</th> </tr> </thead> <tbody> <tr> <td>CE1053B0</td> <td>MM MICROFIT LED BAR POWER SUPPLY CABL</td> <td>1.000</td> <td>PC</td> </tr> </tbody> </table>	Code	Description	Qty	UOM	CE1053B0	MM MICROFIT LED BAR POWER SUPPLY CABL	1.000	PC								
Code	Description	Qty	UOM																		
CE1053B0	MM MICROFIT LED BAR POWER SUPPLY CABL	1.000	PC																		
LP1019A	6 SERIES L200 LED LIGHT BAR - E415		KLP1019A	L200 E415 LED LIGHT BAR KIT	<table border="1"> <thead> <tr> <th>Code</th> <th>Description</th> <th>Qty</th> <th>UOM</th> </tr> </thead> <tbody> <tr> <td>LP1019A0</td> <td>6 SERIES L200 LED LIGHT BAR - E415</td> <td>1.000</td> <td>PC</td> </tr> </tbody> </table>	Code	Description	Qty	UOM	LP1019A0	6 SERIES L200 LED LIGHT BAR - E415	1.000	PC								
Code	Description	Qty	UOM																		
LP1019A0	6 SERIES L200 LED LIGHT BAR - E415	1.000	PC																		

COMPONENT			SPARE PART																																		
Code	Description	Image	Code	Description	Kit components																																
LP1025A	L=415 LED LIGHT BAR COVER		KLP1025A	L415 MM NO LED LIGHT HOLDER KIT	<table border="1"> <thead> <tr> <th>Code</th> <th>Description</th> <th>Qty</th> <th>UOM</th> </tr> </thead> <tbody> <tr> <td>LP1025A0</td> <td>L=415 LED LIGHT BAR COVER</td> <td>1.000</td> <td>PC</td> </tr> </tbody> </table>	Code	Description	Qty	UOM	LP1025A0	L=415 LED LIGHT BAR COVER	1.000	PC																								
Code	Description	Qty	UOM																																		
LP1025A0	L=415 LED LIGHT BAR COVER	1.000	PC																																		
PE1058A	MM ONE CONTROL BOARD		KPE1058A	MM ONE CONTROL BOARD KIT	<table border="1"> <thead> <tr> <th>Code</th> <th>Description</th> <th>Qty</th> <th>UOM</th> </tr> </thead> <tbody> <tr> <td>CE2007A0</td> <td>4PM-MINIFIT 4PF 100mm MICROFIT CABLE</td> <td>1.000</td> <td>PC</td> </tr> <tr> <td>PE1058A2</td> <td></td> <td>1.000</td> <td>PC</td> </tr> <tr> <td>VI1074A0</td> <td>4X16 SCREW FOR PLASTIC</td> <td>2.000</td> <td>PC</td> </tr> <tr> <td>VP1005A0</td> <td>BIG-L DOOR CONTROL BOARD SUPPPORT</td> <td>1.000</td> <td>PC</td> </tr> <tr> <td>VP1005B0</td> <td>70 MM BIG-L DOOR CONTROL SUPPORT</td> <td>1.000</td> <td>PC</td> </tr> <tr> <td>VP1067A0</td> <td>MM CONTROL BOARD RETROFIT SPACER</td> <td>1.000</td> <td>PC</td> </tr> <tr> <td>VP1078A0</td> <td>MM CONTROL BOARD RETROFIT FRAME</td> <td>1.000</td> <td>PC</td> </tr> </tbody> </table>	Code	Description	Qty	UOM	CE2007A0	4PM-MINIFIT 4PF 100mm MICROFIT CABLE	1.000	PC	PE1058A2		1.000	PC	VI1074A0	4X16 SCREW FOR PLASTIC	2.000	PC	VP1005A0	BIG-L DOOR CONTROL BOARD SUPPPORT	1.000	PC	VP1005B0	70 MM BIG-L DOOR CONTROL SUPPORT	1.000	PC	VP1067A0	MM CONTROL BOARD RETROFIT SPACER	1.000	PC	VP1078A0	MM CONTROL BOARD RETROFIT FRAME	1.000	PC
Code	Description	Qty	UOM																																		
CE2007A0	4PM-MINIFIT 4PF 100mm MICROFIT CABLE	1.000	PC																																		
PE1058A2		1.000	PC																																		
VI1074A0	4X16 SCREW FOR PLASTIC	2.000	PC																																		
VP1005A0	BIG-L DOOR CONTROL BOARD SUPPPORT	1.000	PC																																		
VP1005B0	70 MM BIG-L DOOR CONTROL SUPPORT	1.000	PC																																		
VP1067A0	MM CONTROL BOARD RETROFIT SPACER	1.000	PC																																		
VP1078A0	MM CONTROL BOARD RETROFIT FRAME	1.000	PC																																		
PE1059A	MM USB-RESET SUPPORT		KPE1059A	MM USB-RESET SUPPORT KIT	<table border="1"> <thead> <tr> <th>Code</th> <th>Description</th> <th>Qty</th> <th>UOM</th> </tr> </thead> <tbody> <tr> <td>PE1059A0</td> <td>MM USB-RESET SUPPORT</td> <td>1.000</td> <td>PC</td> </tr> <tr> <td>VI1220A1</td> <td>4,2x12 TCB SELF-TAPPIN G SCREW</td> <td>2.000</td> <td>PC</td> </tr> </tbody> </table>	Code	Description	Qty	UOM	PE1059A0	MM USB-RESET SUPPORT	1.000	PC	VI1220A1	4,2x12 TCB SELF-TAPPIN G SCREW	2.000	PC																				
Code	Description	Qty	UOM																																		
PE1059A0	MM USB-RESET SUPPORT	1.000	PC																																		
VI1220A1	4,2x12 TCB SELF-TAPPIN G SCREW	2.000	PC																																		
VP1163A	INNER GLASS HOLDING PROFILE - ONE OVENS		VP1163A0	INNER GLASS HOLDING PROFILE - ONE OVENS																																	



COMPONENT			SPARE PART																																											
Code	Description	Image	Code	Description	Kit components																																									
VT1276A	XEVC-0511-E DOOR EXTERNAL GLASS		KVT1276A	0511 EXTERNAL GLASS KIT	<table border="1"> <thead> <tr> <th>Code</th> <th>Description</th> <th>Qty</th> <th>UOM</th> </tr> </thead> <tbody> <tr> <td>0B1166A1</td> <td>XEVC-0511-E EXT GLASS SUPPORT PROFILE</td> <td>2.000</td> <td>PC</td> </tr> <tr> <td>SL1221A0</td> <td>GN1/1 EXTERNAL GLASS UPPER SILICONE</td> <td>1.000</td> <td>PC</td> </tr> <tr> <td>SL1222A0</td> <td>0511 EXTERNAL GLASS LATERAL SILICONE</td> <td>4.000</td> <td>PC</td> </tr> <tr> <td>VT1276A0</td> <td>XEVC-0511-E DOOR EXTERNAL GLASS</td> <td>1.000</td> <td>PC</td> </tr> </tbody> </table>	Code	Description	Qty	UOM	0B1166A1	XEVC-0511-E EXT GLASS SUPPORT PROFILE	2.000	PC	SL1221A0	GN1/1 EXTERNAL GLASS UPPER SILICONE	1.000	PC	SL1222A0	0511 EXTERNAL GLASS LATERAL SILICONE	4.000	PC	VT1276A0	XEVC-0511-E DOOR EXTERNAL GLASS	1.000	PC																					
			Code	Description	Qty	UOM																																								
0B1166A1	XEVC-0511-E EXT GLASS SUPPORT PROFILE	2.000	PC																																											
SL1221A0	GN1/1 EXTERNAL GLASS UPPER SILICONE	1.000	PC																																											
SL1222A0	0511 EXTERNAL GLASS LATERAL SILICONE	4.000	PC																																											
VT1276A0	XEVC-0511-E DOOR EXTERNAL GLASS	1.000	PC																																											
KDR1326A	0511 ZERO LEFT -M EXTERNAL DOOR	<table border="1"> <thead> <tr> <th>Code</th> <th>Description</th> <th>Qty</th> <th>UOM</th> </tr> </thead> <tbody> <tr> <td>0B1122B0</td> <td>MM CT DOOR LOWER CROSS BAR</td> <td>1.000</td> <td>PC</td> </tr> <tr> <td>0B1166A1</td> <td>XEVC-0511-E EXT GLASS SUPPORT PROFILE</td> <td>2.000</td> <td>PC</td> </tr> <tr> <td>0B1195B1</td> <td>0511 LEFT DOOR LEFT EXTERNAL COLUMN</td> <td>1.000</td> <td>PC</td> </tr> <tr> <td>0B1196A1</td> <td>0511 LEFT - DOOR RIGHT INT COLUMN</td> <td>1.000</td> <td>PC</td> </tr> <tr> <td>0B1197A1</td> <td>0511 LEFT - DOOR LEFT INT COLUMN</td> <td>1.000</td> <td>PC</td> </tr> <tr> <td>0B1206A0</td> <td>0511 LEFT - DOOR RIGHT EXT COLUMN</td> <td>1.000</td> <td>PC</td> </tr> <tr> <td>0B1216B0</td> <td>MM CT DOUBLE GLASS DOOR UPPER CROSS BAR</td> <td>1.000</td> <td>PC</td> </tr> <tr> <td>0B1217A1</td> <td>MM DOUBLE GLASS DOOR INT UPPER BEAM 750</td> <td>1.000</td> <td>PC</td> </tr> <tr> <td>0H2892A0</td> <td>LED BAR UPPER CAP PLATE</td> <td>1.000</td> <td>PC</td> </tr> <tr> <td>0H2893A0</td> <td>LED BAR LOWER CAP PLATE</td> <td>1.000</td> <td>PC</td> </tr> </tbody> </table>	Code	Description	Qty	UOM	0B1122B0	MM CT DOOR LOWER CROSS BAR	1.000	PC	0B1166A1	XEVC-0511-E EXT GLASS SUPPORT PROFILE	2.000	PC	0B1195B1	0511 LEFT DOOR LEFT EXTERNAL COLUMN	1.000	PC	0B1196A1	0511 LEFT - DOOR RIGHT INT COLUMN	1.000	PC	0B1197A1	0511 LEFT - DOOR LEFT INT COLUMN	1.000	PC	0B1206A0	0511 LEFT - DOOR RIGHT EXT COLUMN	1.000	PC	0B1216B0	MM CT DOUBLE GLASS DOOR UPPER CROSS BAR	1.000	PC	0B1217A1	MM DOUBLE GLASS DOOR INT UPPER BEAM 750	1.000	PC	0H2892A0	LED BAR UPPER CAP PLATE	1.000	PC	0H2893A0	LED BAR LOWER CAP PLATE	1.000	PC
Code	Description	Qty	UOM																																											
0B1122B0	MM CT DOOR LOWER CROSS BAR	1.000	PC																																											
0B1166A1	XEVC-0511-E EXT GLASS SUPPORT PROFILE	2.000	PC																																											
0B1195B1	0511 LEFT DOOR LEFT EXTERNAL COLUMN	1.000	PC																																											
0B1196A1	0511 LEFT - DOOR RIGHT INT COLUMN	1.000	PC																																											
0B1197A1	0511 LEFT - DOOR LEFT INT COLUMN	1.000	PC																																											
0B1206A0	0511 LEFT - DOOR RIGHT EXT COLUMN	1.000	PC																																											
0B1216B0	MM CT DOUBLE GLASS DOOR UPPER CROSS BAR	1.000	PC																																											
0B1217A1	MM DOUBLE GLASS DOOR INT UPPER BEAM 750	1.000	PC																																											
0H2892A0	LED BAR UPPER CAP PLATE	1.000	PC																																											
0H2893A0	LED BAR LOWER CAP PLATE	1.000	PC																																											



COMPONENT			SPARE PART					
Code	Description	Image	Code	Description	Kit components			
VT1276A	XEVC-0511-E DOOR EXTERNAL GLASS		KDR1326A	0511 ZERO LEFT -M EXTERNAL DOOR	Code	Description	Qty	UOM
					CE1096A0	4 POLES MICROFIT 3 M BUS CABLE	1.000	PC
					CE1285A0	EMI ROUND FERRITE MOD.26438015 02	2.000	PC
					CE1851A0	MICROFIT CABLE 2P M-F-F AWG22	1.000	PC
					CE2001A0	MICROFIT CABLE 2PM-100-2PM 2AWG22	1.000	PC
					CE2002A0	MICROFIT CABLE 2PM-100-AMP MODU2 2AWG22	1.000	PC
					GN1525A0	O-RING INT DIAM 9,5 THK 1 NBR 70	1.000	PC
					LP1019A0	6 SERIES L200 LED LIGHT BAR - E415	1.000	PC
					MG1099A1	MM COMPLETE HANDLE	1.000	PC
					RC1200A0	ED=4 WIRE D.=0.5 COMPRESSIO N SPRING	4.000	PC
					SL1170A1	S57 BLACK SILICON - 310ml CARTRIDGE	30.000	ML
					SL1221A0	GN1/1 EXTERNAL GLASS UPPER SILICONE	1.000	PC
					SL1222A0	0511 EXTERNAL GLASS LATERAL SILICONE	4.000	PC
					VE1030A1	MAGNET FOR DOOR MICROSWITC H D=-22,9mm	2.000	PC
VI0239A1	SELF-TAPPIN G SCREW 4.2X25 TCB+ INOX	4.000	PC					



COMPONENT			SPARE PART			
Code	Description	Image	Code	Description	Kit components	
VT1276A	XEVC-0511-E DOOR EXTERNAL GLASS		KDR1326A	0511 ZERO LEFT -M EXTERNAL DOOR	Code	Description Qty UOM
					VI1034A0	STAINLESS STEEL WASHER 8.4x16x1 1.000 PC
					VI1074A0	4X16 SCREW FOR PLASTIC 2.000 PC
					VI1103A0	40X12 TBSP SCREW FOR PLASTIC 2.000 PC
					VI1220A1	4,2x12 TCB SELF-TAPPIN G SCREW 26.000 PC
					VI1930A1	ST. STEEL 5X20 CHIP SCREW 16.000 PC
					VI1996A0	M5x35 SCREW 13.000 PC
					VI2037A1	40X8 TORX SHEETTRACS SELF-THREAD SCREW 6.000 PC
					VM1490A0	CHEFTOP/BAK ERTOP HANDLE SCREWS COVER 2.000 PC
					VM1630A1	INTERNAL GLASS PUSHING CAP 3.000 PC
					VM1631A0	PLUS INNER GLASS PUSHING CAP 3.000 PC
					VM2267A0	INTERNAL GLASS LOCKING SYSTEM SLIDER 2.000 PC
					VM2268A0	DOOR MAGNET COVER 2.000 PC
					VM2269B0	INNER GLASS FIXING CAP 2.000 PC
					VM2274A0	GROOVED BUSHING 1.000 PC
					VM2275A0	SMOOTH BUSHING 1.000 PC
					VM2284B0	750 SERIES DRIP PROFILE KIT 1.000 PC
VM2305A0	6 SERIES DOOR CAP FIXING PAWL 14.000 PC					
VM2313A0	TUBE DX DISCHARGE DRIP MM 1.000 PC					



COMPONENT			SPARE PART																																														
Code	Description	Image	Code	Description	Kit components																																												
VT1276A	XEVC-0511-E DOOR EXTERNAL GLASS		KDR1326A	0511 ZERO LEFT -M EXTERNAL DOOR	<table border="1"> <thead> <tr> <th>Code</th> <th>Description</th> <th>Qty</th> <th>UOM</th> </tr> </thead> <tbody> <tr> <td>VM2314A0</td> <td>6 S. DRIP PROFILE CAP</td> <td>1.000</td> <td>PC</td> </tr> <tr> <td>VM2315B0</td> <td>S6 INTERNAL GLASS SUPPORT</td> <td>3.000</td> <td>PC</td> </tr> <tr> <td>VM2383B0</td> <td>S6 LEFT OVENS UPPER RIGHT CAP</td> <td>1.000</td> <td>PC</td> </tr> <tr> <td>VM2384B0</td> <td></td> <td>1.000</td> <td>PC</td> </tr> <tr> <td>VM2385B0</td> <td>S6 LEFT OVENS UPPER LEFT CAP</td> <td>1.000</td> <td>PC</td> </tr> <tr> <td>VM2386B0</td> <td>MM -M LEFT DOOR LEFT LOWER CAP KI</td> <td>1.000</td> <td>PC</td> </tr> <tr> <td>VM2505B1</td> <td>MM PLUS INTERNAL GLASS SUPPORT</td> <td>3.000</td> <td>PC</td> </tr> <tr> <td>VP1080A0</td> <td>UPPER HINGE CAP FOR LOWER INNER GLASS</td> <td>1.000</td> <td>PC</td> </tr> <tr> <td>VP1081A0</td> <td>UPPER HINGE CAP FOR UPPER INNER GLASS</td> <td>1.000</td> <td>PC</td> </tr> <tr> <td>VT1276A0</td> <td>XEVC-0511-E DOOR EXTERNAL GLASS</td> <td>1.000</td> <td>PC</td> </tr> </tbody> </table>	Code	Description	Qty	UOM	VM2314A0	6 S. DRIP PROFILE CAP	1.000	PC	VM2315B0	S6 INTERNAL GLASS SUPPORT	3.000	PC	VM2383B0	S6 LEFT OVENS UPPER RIGHT CAP	1.000	PC	VM2384B0		1.000	PC	VM2385B0	S6 LEFT OVENS UPPER LEFT CAP	1.000	PC	VM2386B0	MM -M LEFT DOOR LEFT LOWER CAP KI	1.000	PC	VM2505B1	MM PLUS INTERNAL GLASS SUPPORT	3.000	PC	VP1080A0	UPPER HINGE CAP FOR LOWER INNER GLASS	1.000	PC	VP1081A0	UPPER HINGE CAP FOR UPPER INNER GLASS	1.000	PC	VT1276A0	XEVC-0511-E DOOR EXTERNAL GLASS	1.000	PC
			Code	Description	Qty	UOM																																											
VM2314A0	6 S. DRIP PROFILE CAP	1.000	PC																																														
VM2315B0	S6 INTERNAL GLASS SUPPORT	3.000	PC																																														
VM2383B0	S6 LEFT OVENS UPPER RIGHT CAP	1.000	PC																																														
VM2384B0		1.000	PC																																														
VM2385B0	S6 LEFT OVENS UPPER LEFT CAP	1.000	PC																																														
VM2386B0	MM -M LEFT DOOR LEFT LOWER CAP KI	1.000	PC																																														
VM2505B1	MM PLUS INTERNAL GLASS SUPPORT	3.000	PC																																														
VP1080A0	UPPER HINGE CAP FOR LOWER INNER GLASS	1.000	PC																																														
VP1081A0	UPPER HINGE CAP FOR UPPER INNER GLASS	1.000	PC																																														
VT1276A0	XEVC-0511-E DOOR EXTERNAL GLASS	1.000	PC																																														
KDR1325A	0511 ZERO RIGHT -M EXTERNAL DOOR	<table border="1"> <thead> <tr> <th>Code</th> <th>Description</th> <th>Qty</th> <th>UOM</th> </tr> </thead> <tbody> <tr> <td>0B1106A0</td> <td>XEVC-0511-E DOOR EXTERNAL LEFT COLUMN</td> <td>1.000</td> <td>PC</td> </tr> <tr> <td>0B1107A1</td> <td>XEVC-0511-E LEFT INT DOOR COLUM</td> <td>1.000</td> <td>PC</td> </tr> <tr> <td>0B1108B1</td> <td>XEVC-0511 DOOR EXTERNAL RIGHT COLUM</td> <td>1.000</td> <td>PC</td> </tr> <tr> <td>0B1109A1</td> <td>XEVC-0511-E RIGHT INT DOOR COLUM</td> <td>1.000</td> <td>PC</td> </tr> <tr> <td>0B1122B0</td> <td>MM CT DOOR LOWER CROSS BAR</td> <td>1.000</td> <td>PC</td> </tr> <tr> <td>0B1166A1</td> <td>XEVC-0511-E EXT GLASS SUPPORT PROFILE</td> <td>2.000</td> <td>PC</td> </tr> </tbody> </table>	Code	Description	Qty	UOM	0B1106A0	XEVC-0511-E DOOR EXTERNAL LEFT COLUMN	1.000	PC	0B1107A1	XEVC-0511-E LEFT INT DOOR COLUM	1.000	PC	0B1108B1	XEVC-0511 DOOR EXTERNAL RIGHT COLUM	1.000	PC	0B1109A1	XEVC-0511-E RIGHT INT DOOR COLUM	1.000	PC	0B1122B0	MM CT DOOR LOWER CROSS BAR	1.000	PC	0B1166A1	XEVC-0511-E EXT GLASS SUPPORT PROFILE	2.000	PC																			
Code	Description	Qty	UOM																																														
0B1106A0	XEVC-0511-E DOOR EXTERNAL LEFT COLUMN	1.000	PC																																														
0B1107A1	XEVC-0511-E LEFT INT DOOR COLUM	1.000	PC																																														
0B1108B1	XEVC-0511 DOOR EXTERNAL RIGHT COLUM	1.000	PC																																														
0B1109A1	XEVC-0511-E RIGHT INT DOOR COLUM	1.000	PC																																														
0B1122B0	MM CT DOOR LOWER CROSS BAR	1.000	PC																																														
0B1166A1	XEVC-0511-E EXT GLASS SUPPORT PROFILE	2.000	PC																																														



COMPONENT			SPARE PART																																																																		
Code	Description	Image	Code	Description	Kit components																																																																
VT1276A	XEVC-0511-E DOOR EXTERNAL GLASS		KDR1325A	0511 ZERO RIGHT -M EXTERNAL DOOR	<table border="1"> <thead> <tr> <th>Code</th> <th>Description</th> <th>Qty</th> <th>UOM</th> </tr> </thead> <tbody> <tr> <td>0B1216B0</td> <td>MM CT DOUBLE GLASS DOOR UPPER CROSS BAR</td> <td>1.000</td> <td>PC</td> </tr> <tr> <td>0B1217A1</td> <td>MM DOUBLE GLASS DOOR INT UPPER BEAM 750</td> <td>1.000</td> <td>PC</td> </tr> <tr> <td>0H2892A0</td> <td>LED BAR UPPER CAP PLATE</td> <td>1.000</td> <td>PC</td> </tr> <tr> <td>0H2893A0</td> <td>LED BAR LOWER CAP PLATE</td> <td>1.000</td> <td>PC</td> </tr> <tr> <td>CE1096A0</td> <td>4 POLES MICROFIT 3 M BUS CABLE</td> <td>1.000</td> <td>PC</td> </tr> <tr> <td>CE1285A0</td> <td>EMI ROUND FERRITE MOD.26438015 02</td> <td>2.000</td> <td>PC</td> </tr> <tr> <td>CE1851A0</td> <td>MICROFIT CABLE 2P M-F-F AWG22</td> <td>1.000</td> <td>PC</td> </tr> <tr> <td>CE2001A0</td> <td>MICROFIT CABLE 2PM-100-2PM 2AWG22</td> <td>1.000</td> <td>PC</td> </tr> <tr> <td>CE2002A0</td> <td>MICROFIT CABLE 2PM-100-AMP MODU2 2AWG22</td> <td>1.000</td> <td>PC</td> </tr> <tr> <td>GN1525A0</td> <td>O-RING INT DIAM 9,5 THK 1 NBR 70</td> <td>1.000</td> <td>PC</td> </tr> <tr> <td>LP1019A0</td> <td>6 SERIES L200 LED LIGHT BAR - E415</td> <td>1.000</td> <td>PC</td> </tr> <tr> <td>MG1099A1</td> <td>MM COMPLETE HANDLE</td> <td>1.000</td> <td>PC</td> </tr> <tr> <td>RC1200A0</td> <td>ED=4 WIRE D.=0.5 COMPRESSIO N SPRING</td> <td>4.000</td> <td>PC</td> </tr> <tr> <td>SL1170A1</td> <td>S57 BLACK SILICON - 310ml CARTRIDGE</td> <td>30.000</td> <td>ML</td> </tr> <tr> <td>SL1221A0</td> <td>GN1/1 EXTERNAL GLASS UPPER SILICONE</td> <td>1.000</td> <td>PC</td> </tr> </tbody> </table>	Code	Description	Qty	UOM	0B1216B0	MM CT DOUBLE GLASS DOOR UPPER CROSS BAR	1.000	PC	0B1217A1	MM DOUBLE GLASS DOOR INT UPPER BEAM 750	1.000	PC	0H2892A0	LED BAR UPPER CAP PLATE	1.000	PC	0H2893A0	LED BAR LOWER CAP PLATE	1.000	PC	CE1096A0	4 POLES MICROFIT 3 M BUS CABLE	1.000	PC	CE1285A0	EMI ROUND FERRITE MOD.26438015 02	2.000	PC	CE1851A0	MICROFIT CABLE 2P M-F-F AWG22	1.000	PC	CE2001A0	MICROFIT CABLE 2PM-100-2PM 2AWG22	1.000	PC	CE2002A0	MICROFIT CABLE 2PM-100-AMP MODU2 2AWG22	1.000	PC	GN1525A0	O-RING INT DIAM 9,5 THK 1 NBR 70	1.000	PC	LP1019A0	6 SERIES L200 LED LIGHT BAR - E415	1.000	PC	MG1099A1	MM COMPLETE HANDLE	1.000	PC	RC1200A0	ED=4 WIRE D.=0.5 COMPRESSIO N SPRING	4.000	PC	SL1170A1	S57 BLACK SILICON - 310ml CARTRIDGE	30.000	ML	SL1221A0	GN1/1 EXTERNAL GLASS UPPER SILICONE	1.000	PC
					Code	Description	Qty	UOM																																																													
					0B1216B0	MM CT DOUBLE GLASS DOOR UPPER CROSS BAR	1.000	PC																																																													
					0B1217A1	MM DOUBLE GLASS DOOR INT UPPER BEAM 750	1.000	PC																																																													
					0H2892A0	LED BAR UPPER CAP PLATE	1.000	PC																																																													
					0H2893A0	LED BAR LOWER CAP PLATE	1.000	PC																																																													
					CE1096A0	4 POLES MICROFIT 3 M BUS CABLE	1.000	PC																																																													
					CE1285A0	EMI ROUND FERRITE MOD.26438015 02	2.000	PC																																																													
					CE1851A0	MICROFIT CABLE 2P M-F-F AWG22	1.000	PC																																																													
					CE2001A0	MICROFIT CABLE 2PM-100-2PM 2AWG22	1.000	PC																																																													
					CE2002A0	MICROFIT CABLE 2PM-100-AMP MODU2 2AWG22	1.000	PC																																																													
					GN1525A0	O-RING INT DIAM 9,5 THK 1 NBR 70	1.000	PC																																																													
					LP1019A0	6 SERIES L200 LED LIGHT BAR - E415	1.000	PC																																																													
					MG1099A1	MM COMPLETE HANDLE	1.000	PC																																																													
					RC1200A0	ED=4 WIRE D.=0.5 COMPRESSIO N SPRING	4.000	PC																																																													
SL1170A1	S57 BLACK SILICON - 310ml CARTRIDGE	30.000	ML																																																																		
SL1221A0	GN1/1 EXTERNAL GLASS UPPER SILICONE	1.000	PC																																																																		



COMPONENT			SPARE PART																																																																										
Code	Description	Image	Code	Description	Kit components																																																																								
VT1276A	XEVC-0511-E DOOR EXTERNAL GLASS		KDR1325A	0511 ZERO RIGHT -M EXTERNAL DOOR	<table border="1"> <thead> <tr> <th>Code</th> <th>Description</th> <th>Qty</th> <th>UOM</th> </tr> </thead> <tbody> <tr> <td>SL1222A0</td> <td>0511 EXTERNAL GLASS LATERAL SILICONE</td> <td>4.000</td> <td>PC</td> </tr> <tr> <td>VE1030A1</td> <td>MAGNET FOR DOOR MICROSWITC H D=22,9mm</td> <td>2.000</td> <td>PC</td> </tr> <tr> <td>VI0239A1</td> <td>SELF-TAPPIN G SCREW 4.2X25 TCB+ INOX</td> <td>4.000</td> <td>PC</td> </tr> <tr> <td>VI1034A0</td> <td>STAINLESS STEEL WASHER 8.4x16x1</td> <td>1.000</td> <td>PC</td> </tr> <tr> <td>VI1074A0</td> <td>4X16 SCREW FOR PLASTIC</td> <td>2.000</td> <td>PC</td> </tr> <tr> <td>VI1103A0</td> <td>40X12 TBSP SCREW FOR PLASTIC</td> <td>2.000</td> <td>PC</td> </tr> <tr> <td>VI1220A1</td> <td>4,2x12 TCB SELF-TAPPIN G SCREW</td> <td>26.000</td> <td>PC</td> </tr> <tr> <td>VI1930A1</td> <td>ST. STEEL 5X20 CHIP SCREW</td> <td>16.000</td> <td>PC</td> </tr> <tr> <td>VI1996A0</td> <td>M5x35 SCREW</td> <td>13.000</td> <td>PC</td> </tr> <tr> <td>VI2037A1</td> <td>40X8 TORX SHEETTRACS SELF-THREAD SCREW</td> <td>6.000</td> <td>PC</td> </tr> <tr> <td>VM1490A0</td> <td>CHEFTOP/BAK ERTOP HANDLE SCREWS COVER</td> <td>2.000</td> <td>PC</td> </tr> <tr> <td>VM1630A1</td> <td>INTERNAL GLASS PUSHING CAP</td> <td>3.000</td> <td>PC</td> </tr> <tr> <td>VM1631A0</td> <td>PLUS INNER GLASS PUSHING CAP</td> <td>3.000</td> <td>PC</td> </tr> <tr> <td>VM2259B0</td> <td>VM2259B0</td> <td>1.000</td> <td>PC</td> </tr> <tr> <td>VM2260B0</td> <td>S6 LEFT UPPER CAP</td> <td>1.000</td> <td>PC</td> </tr> <tr> <td>VM2261B0</td> <td>MM -M DOOR RIGHT LOWER CAP</td> <td>1.000</td> <td>PC</td> </tr> <tr> <td>VM2262B0</td> <td>MM -M DOOR RIGHT UPPER CAP</td> <td>1.000</td> <td>PC</td> </tr> </tbody> </table>	Code	Description	Qty	UOM	SL1222A0	0511 EXTERNAL GLASS LATERAL SILICONE	4.000	PC	VE1030A1	MAGNET FOR DOOR MICROSWITC H D=22,9mm	2.000	PC	VI0239A1	SELF-TAPPIN G SCREW 4.2X25 TCB+ INOX	4.000	PC	VI1034A0	STAINLESS STEEL WASHER 8.4x16x1	1.000	PC	VI1074A0	4X16 SCREW FOR PLASTIC	2.000	PC	VI1103A0	40X12 TBSP SCREW FOR PLASTIC	2.000	PC	VI1220A1	4,2x12 TCB SELF-TAPPIN G SCREW	26.000	PC	VI1930A1	ST. STEEL 5X20 CHIP SCREW	16.000	PC	VI1996A0	M5x35 SCREW	13.000	PC	VI2037A1	40X8 TORX SHEETTRACS SELF-THREAD SCREW	6.000	PC	VM1490A0	CHEFTOP/BAK ERTOP HANDLE SCREWS COVER	2.000	PC	VM1630A1	INTERNAL GLASS PUSHING CAP	3.000	PC	VM1631A0	PLUS INNER GLASS PUSHING CAP	3.000	PC	VM2259B0	VM2259B0	1.000	PC	VM2260B0	S6 LEFT UPPER CAP	1.000	PC	VM2261B0	MM -M DOOR RIGHT LOWER CAP	1.000	PC	VM2262B0	MM -M DOOR RIGHT UPPER CAP	1.000	PC
Code	Description	Qty	UOM																																																																										
SL1222A0	0511 EXTERNAL GLASS LATERAL SILICONE	4.000	PC																																																																										
VE1030A1	MAGNET FOR DOOR MICROSWITC H D=22,9mm	2.000	PC																																																																										
VI0239A1	SELF-TAPPIN G SCREW 4.2X25 TCB+ INOX	4.000	PC																																																																										
VI1034A0	STAINLESS STEEL WASHER 8.4x16x1	1.000	PC																																																																										
VI1074A0	4X16 SCREW FOR PLASTIC	2.000	PC																																																																										
VI1103A0	40X12 TBSP SCREW FOR PLASTIC	2.000	PC																																																																										
VI1220A1	4,2x12 TCB SELF-TAPPIN G SCREW	26.000	PC																																																																										
VI1930A1	ST. STEEL 5X20 CHIP SCREW	16.000	PC																																																																										
VI1996A0	M5x35 SCREW	13.000	PC																																																																										
VI2037A1	40X8 TORX SHEETTRACS SELF-THREAD SCREW	6.000	PC																																																																										
VM1490A0	CHEFTOP/BAK ERTOP HANDLE SCREWS COVER	2.000	PC																																																																										
VM1630A1	INTERNAL GLASS PUSHING CAP	3.000	PC																																																																										
VM1631A0	PLUS INNER GLASS PUSHING CAP	3.000	PC																																																																										
VM2259B0	VM2259B0	1.000	PC																																																																										
VM2260B0	S6 LEFT UPPER CAP	1.000	PC																																																																										
VM2261B0	MM -M DOOR RIGHT LOWER CAP	1.000	PC																																																																										
VM2262B0	MM -M DOOR RIGHT UPPER CAP	1.000	PC																																																																										



COMPONENT			SPARE PART																																																																													
Code	Description	Image	Code	Description	Kit components																																																																											
VT1276A	XEVC-0511-E DOOR EXTERNAL GLASS		KDR1325A	0511 ZERO RIGHT -M EXTERNAL DOOR	<table border="1"> <thead> <tr> <th>Code</th> <th>Description</th> <th>Qty</th> <th>UOM</th> </tr> </thead> <tbody> <tr> <td>VM2267A0</td> <td>INTERNAL GLASS LOCKING SYSTEM SLIDER</td> <td>2.000</td> <td>PC</td> </tr> <tr> <td>VM2268A0</td> <td>DOOR MAGNET COVER</td> <td>2.000</td> <td>PC</td> </tr> <tr> <td>VM2269B0</td> <td>INNER GLASS FIXING CAP</td> <td>2.000</td> <td>PC</td> </tr> <tr> <td>VM2274A0</td> <td>GROOVED BUSHING</td> <td>1.000</td> <td>PC</td> </tr> <tr> <td>VM2275A0</td> <td>SMOOTH BUSHING</td> <td>1.000</td> <td>PC</td> </tr> <tr> <td>VM2284B0</td> <td>750 SERIES DRIP PROFILE KIT</td> <td>1.000</td> <td>PC</td> </tr> <tr> <td>VM2305A0</td> <td>6 SERIES DOOR CAP FIXING PAWL</td> <td>14.000</td> <td>PC</td> </tr> <tr> <td>VM2312A0</td> <td>6 S. DRIP PROFILE DRAIN LEFT PIPE</td> <td>1.000</td> <td>PC</td> </tr> <tr> <td>VM2314A0</td> <td>6 S. DRIP PROFILE CAP</td> <td>1.000</td> <td>PC</td> </tr> <tr> <td>VM2315B0</td> <td>S6 INTERNAL GLASS SUPPORT</td> <td>3.000</td> <td>PC</td> </tr> <tr> <td>VM2505B1</td> <td>MM PLUS INTERNAL GLASS SUPPORT</td> <td>3.000</td> <td>PC</td> </tr> <tr> <td>VP1080A0</td> <td>UPPER HINGE CAP FOR LOWER INNER GLASS</td> <td>1.000</td> <td>PC</td> </tr> <tr> <td>VP1081A0</td> <td>UPPER HINGE CAP FOR UPPER INNER GLASS</td> <td>1.000</td> <td>PC</td> </tr> <tr> <td>VT1276A0</td> <td>XEVC-0511-E DOOR EXTERNAL GLASS</td> <td>1.000</td> <td>PC</td> </tr> </tbody> </table>	Code	Description	Qty	UOM	VM2267A0	INTERNAL GLASS LOCKING SYSTEM SLIDER	2.000	PC	VM2268A0	DOOR MAGNET COVER	2.000	PC	VM2269B0	INNER GLASS FIXING CAP	2.000	PC	VM2274A0	GROOVED BUSHING	1.000	PC	VM2275A0	SMOOTH BUSHING	1.000	PC	VM2284B0	750 SERIES DRIP PROFILE KIT	1.000	PC	VM2305A0	6 SERIES DOOR CAP FIXING PAWL	14.000	PC	VM2312A0	6 S. DRIP PROFILE DRAIN LEFT PIPE	1.000	PC	VM2314A0	6 S. DRIP PROFILE CAP	1.000	PC	VM2315B0	S6 INTERNAL GLASS SUPPORT	3.000	PC	VM2505B1	MM PLUS INTERNAL GLASS SUPPORT	3.000	PC	VP1080A0	UPPER HINGE CAP FOR LOWER INNER GLASS	1.000	PC	VP1081A0	UPPER HINGE CAP FOR UPPER INNER GLASS	1.000	PC	VT1276A0	XEVC-0511-E DOOR EXTERNAL GLASS	1.000	PC	KDR1265B	0511 -M LEFT EXTERNAL DOOR	<table border="1"> <thead> <tr> <th>Code</th> <th>Description</th> <th>Qty</th> <th>UOM</th> </tr> </thead> <tbody> <tr> <td>0B1122B0</td> <td>MM CT DOOR LOWER CROSS BAR</td> <td>1.000</td> <td>PC</td> </tr> <tr> <td>0B1166A1</td> <td>XEVC-0511-E EXT GLASS SUPPORT PROFILE</td> <td>2.000</td> <td>PC</td> </tr> </tbody> </table>	Code	Description	Qty	UOM	0B1122B0	MM CT DOOR LOWER CROSS BAR	1.000	PC	0B1166A1	XEVC-0511-E EXT GLASS SUPPORT PROFILE	2.000	PC
			Code	Description	Qty	UOM																																																																										
VM2267A0	INTERNAL GLASS LOCKING SYSTEM SLIDER	2.000	PC																																																																													
VM2268A0	DOOR MAGNET COVER	2.000	PC																																																																													
VM2269B0	INNER GLASS FIXING CAP	2.000	PC																																																																													
VM2274A0	GROOVED BUSHING	1.000	PC																																																																													
VM2275A0	SMOOTH BUSHING	1.000	PC																																																																													
VM2284B0	750 SERIES DRIP PROFILE KIT	1.000	PC																																																																													
VM2305A0	6 SERIES DOOR CAP FIXING PAWL	14.000	PC																																																																													
VM2312A0	6 S. DRIP PROFILE DRAIN LEFT PIPE	1.000	PC																																																																													
VM2314A0	6 S. DRIP PROFILE CAP	1.000	PC																																																																													
VM2315B0	S6 INTERNAL GLASS SUPPORT	3.000	PC																																																																													
VM2505B1	MM PLUS INTERNAL GLASS SUPPORT	3.000	PC																																																																													
VP1080A0	UPPER HINGE CAP FOR LOWER INNER GLASS	1.000	PC																																																																													
VP1081A0	UPPER HINGE CAP FOR UPPER INNER GLASS	1.000	PC																																																																													
VT1276A0	XEVC-0511-E DOOR EXTERNAL GLASS	1.000	PC																																																																													
Code	Description	Qty	UOM																																																																													
0B1122B0	MM CT DOOR LOWER CROSS BAR	1.000	PC																																																																													
0B1166A1	XEVC-0511-E EXT GLASS SUPPORT PROFILE	2.000	PC																																																																													



COMPONENT			SPARE PART																																																																		
Code	Description	Image	Code	Description	Kit components																																																																
VT1276A	XEVC-0511-E DOOR EXTERNAL GLASS		KDR1265B	0511 -M LEFT EXTERNAL DOOR	<table border="1"> <thead> <tr> <th>Code</th> <th>Description</th> <th>Qty</th> <th>UOM</th> </tr> </thead> <tbody> <tr> <td>0B1195B1</td> <td>0511 LEFT DOOR LEFT EXTERNAL COLUMN</td> <td>1.000</td> <td>PC</td> </tr> <tr> <td>0B1196A1</td> <td>0511 LEFT - DOOR RIGHT INT COLUMN</td> <td>1.000</td> <td>PC</td> </tr> <tr> <td>0B1197A1</td> <td>0511 LEFT - DOOR LEFT INT COLUMN</td> <td>1.000</td> <td>PC</td> </tr> <tr> <td>0B1206A0</td> <td>0511 LEFT - DOOR RIGHT EXT COLUMN</td> <td>1.000</td> <td>PC</td> </tr> <tr> <td>0B1216B0</td> <td>MM CT DOUBLE GLASS DOOR UPPER CROSS BAR</td> <td>1.000</td> <td>PC</td> </tr> <tr> <td>0B1217A1</td> <td>MM DOUBLE GLASS DOOR INT UPPER BEAM 750</td> <td>1.000</td> <td>PC</td> </tr> <tr> <td>CE1052A1</td> <td>CABLE CONNECTION CONTROL - USB MM 750m</td> <td>1.000</td> <td>PC</td> </tr> <tr> <td>CE1053B0</td> <td>MM MICROFIT LED BAR POWER SUPPLY CABL</td> <td>1.000</td> <td>PC</td> </tr> <tr> <td>CE1096A0</td> <td>4 POLES MICROFIT 3 M BUS CABLE</td> <td>1.000</td> <td>PC</td> </tr> <tr> <td>CE1285A0</td> <td>EMI ROUND FERRITE MOD.26438015 02</td> <td>2.000</td> <td>PC</td> </tr> <tr> <td>GN1525A0</td> <td>O-RING INT DIAM 9,5 THK 1 NBR 70</td> <td>1.000</td> <td>PC</td> </tr> <tr> <td>LP1019A0</td> <td>6 SERIES L200 LED LIGHT BAR - E415</td> <td>1.000</td> <td>PC</td> </tr> <tr> <td>LP1025A0</td> <td>L=415 LED LIGHT BAR COVER</td> <td>1.000</td> <td>PC</td> </tr> <tr> <td>MG1099A1</td> <td>MM COMPLETE HANDLE</td> <td>1.000</td> <td>PC</td> </tr> <tr> <td>RC1200A0</td> <td>ED=4 WIRE D.=0.5 COMPRESSIO N SPRING</td> <td>4.000</td> <td>PC</td> </tr> </tbody> </table>	Code	Description	Qty	UOM	0B1195B1	0511 LEFT DOOR LEFT EXTERNAL COLUMN	1.000	PC	0B1196A1	0511 LEFT - DOOR RIGHT INT COLUMN	1.000	PC	0B1197A1	0511 LEFT - DOOR LEFT INT COLUMN	1.000	PC	0B1206A0	0511 LEFT - DOOR RIGHT EXT COLUMN	1.000	PC	0B1216B0	MM CT DOUBLE GLASS DOOR UPPER CROSS BAR	1.000	PC	0B1217A1	MM DOUBLE GLASS DOOR INT UPPER BEAM 750	1.000	PC	CE1052A1	CABLE CONNECTION CONTROL - USB MM 750m	1.000	PC	CE1053B0	MM MICROFIT LED BAR POWER SUPPLY CABL	1.000	PC	CE1096A0	4 POLES MICROFIT 3 M BUS CABLE	1.000	PC	CE1285A0	EMI ROUND FERRITE MOD.26438015 02	2.000	PC	GN1525A0	O-RING INT DIAM 9,5 THK 1 NBR 70	1.000	PC	LP1019A0	6 SERIES L200 LED LIGHT BAR - E415	1.000	PC	LP1025A0	L=415 LED LIGHT BAR COVER	1.000	PC	MG1099A1	MM COMPLETE HANDLE	1.000	PC	RC1200A0	ED=4 WIRE D.=0.5 COMPRESSIO N SPRING	4.000	PC
Code	Description	Qty	UOM																																																																		
0B1195B1	0511 LEFT DOOR LEFT EXTERNAL COLUMN	1.000	PC																																																																		
0B1196A1	0511 LEFT - DOOR RIGHT INT COLUMN	1.000	PC																																																																		
0B1197A1	0511 LEFT - DOOR LEFT INT COLUMN	1.000	PC																																																																		
0B1206A0	0511 LEFT - DOOR RIGHT EXT COLUMN	1.000	PC																																																																		
0B1216B0	MM CT DOUBLE GLASS DOOR UPPER CROSS BAR	1.000	PC																																																																		
0B1217A1	MM DOUBLE GLASS DOOR INT UPPER BEAM 750	1.000	PC																																																																		
CE1052A1	CABLE CONNECTION CONTROL - USB MM 750m	1.000	PC																																																																		
CE1053B0	MM MICROFIT LED BAR POWER SUPPLY CABL	1.000	PC																																																																		
CE1096A0	4 POLES MICROFIT 3 M BUS CABLE	1.000	PC																																																																		
CE1285A0	EMI ROUND FERRITE MOD.26438015 02	2.000	PC																																																																		
GN1525A0	O-RING INT DIAM 9,5 THK 1 NBR 70	1.000	PC																																																																		
LP1019A0	6 SERIES L200 LED LIGHT BAR - E415	1.000	PC																																																																		
LP1025A0	L=415 LED LIGHT BAR COVER	1.000	PC																																																																		
MG1099A1	MM COMPLETE HANDLE	1.000	PC																																																																		
RC1200A0	ED=4 WIRE D.=0.5 COMPRESSIO N SPRING	4.000	PC																																																																		



COMPONENT			SPARE PART																																																																						
Code	Description	Image	Code	Description	Kit components																																																																				
VT1276A	XEVC-0511-E DOOR EXTERNAL GLASS		KDR1265B	0511 -M LEFT EXTERNAL DOOR	<table border="1"> <thead> <tr> <th>Code</th> <th>Description</th> <th>Qty</th> <th>UOM</th> </tr> </thead> <tbody> <tr> <td>SL1155A1</td> <td>LOCTITE BICOMPONEN T SILICON</td> <td>60.000</td> <td>ML</td> </tr> <tr> <td>SL1170A1</td> <td>S57 BLACK SILICON - 310ml CARTRIDGE</td> <td>30.000</td> <td>ML</td> </tr> <tr> <td>SL1221A0</td> <td>GN1/1 EXTERNAL GLASS UPPER SILICONE</td> <td>1.000</td> <td>PC</td> </tr> <tr> <td>SL1222A0</td> <td>0511 EXTERNAL GLASS LATERAL SILICONE</td> <td>4.000</td> <td>PC</td> </tr> <tr> <td>VE1030A1</td> <td>MAGNET FOR DOOR MICROSWITC H D=22,9mm</td> <td>2.000</td> <td>PC</td> </tr> <tr> <td>VI0239A1</td> <td>SELF-TAPPIN G SCREW 4.2X25 TCB+ INOX</td> <td>4.000</td> <td>PC</td> </tr> <tr> <td>VI1034A0</td> <td>STAINLESS STEEL WASHER 8,4x16x1</td> <td>1.000</td> <td>PC</td> </tr> <tr> <td>VI1074A0</td> <td>4X16 SCREW FOR PLASTIC</td> <td>2.000</td> <td>PC</td> </tr> <tr> <td>VI1103A0</td> <td>40X12 TBSP SCREW FOR PLASTIC</td> <td>2.000</td> <td>PC</td> </tr> <tr> <td>VI1220A1</td> <td>4,2x12 TCB SELF-TAPPIN G SCREW</td> <td>26.000</td> <td>PC</td> </tr> <tr> <td>VI1930A1</td> <td>ST. STEEL 5X20 CHIP SCREW</td> <td>16.000</td> <td>PC</td> </tr> <tr> <td>VI1996A0</td> <td>M5x35 SCREW</td> <td>13.000</td> <td>PC</td> </tr> <tr> <td>VI2037A1</td> <td>40X8 TORX SHEETTRACS SELF-THREAD SCREW</td> <td>6.000</td> <td>PC</td> </tr> <tr> <td>VM1490A0</td> <td>CHEFTOP/BAK ERTOP HANDLE SCREWS COVER</td> <td>2.000</td> <td>PC</td> </tr> <tr> <td>VM1630A1</td> <td>INTERNAL GLASS PUSHING CAP</td> <td>3.000</td> <td>PC</td> </tr> <tr> <td>VM1631A0</td> <td>PLUS INNER GLASS PUSHING CAP</td> <td>3.000</td> <td>PC</td> </tr> </tbody> </table>	Code	Description	Qty	UOM	SL1155A1	LOCTITE BICOMPONEN T SILICON	60.000	ML	SL1170A1	S57 BLACK SILICON - 310ml CARTRIDGE	30.000	ML	SL1221A0	GN1/1 EXTERNAL GLASS UPPER SILICONE	1.000	PC	SL1222A0	0511 EXTERNAL GLASS LATERAL SILICONE	4.000	PC	VE1030A1	MAGNET FOR DOOR MICROSWITC H D=22,9mm	2.000	PC	VI0239A1	SELF-TAPPIN G SCREW 4.2X25 TCB+ INOX	4.000	PC	VI1034A0	STAINLESS STEEL WASHER 8,4x16x1	1.000	PC	VI1074A0	4X16 SCREW FOR PLASTIC	2.000	PC	VI1103A0	40X12 TBSP SCREW FOR PLASTIC	2.000	PC	VI1220A1	4,2x12 TCB SELF-TAPPIN G SCREW	26.000	PC	VI1930A1	ST. STEEL 5X20 CHIP SCREW	16.000	PC	VI1996A0	M5x35 SCREW	13.000	PC	VI2037A1	40X8 TORX SHEETTRACS SELF-THREAD SCREW	6.000	PC	VM1490A0	CHEFTOP/BAK ERTOP HANDLE SCREWS COVER	2.000	PC	VM1630A1	INTERNAL GLASS PUSHING CAP	3.000	PC	VM1631A0	PLUS INNER GLASS PUSHING CAP	3.000	PC
Code	Description	Qty	UOM																																																																						
SL1155A1	LOCTITE BICOMPONEN T SILICON	60.000	ML																																																																						
SL1170A1	S57 BLACK SILICON - 310ml CARTRIDGE	30.000	ML																																																																						
SL1221A0	GN1/1 EXTERNAL GLASS UPPER SILICONE	1.000	PC																																																																						
SL1222A0	0511 EXTERNAL GLASS LATERAL SILICONE	4.000	PC																																																																						
VE1030A1	MAGNET FOR DOOR MICROSWITC H D=22,9mm	2.000	PC																																																																						
VI0239A1	SELF-TAPPIN G SCREW 4.2X25 TCB+ INOX	4.000	PC																																																																						
VI1034A0	STAINLESS STEEL WASHER 8,4x16x1	1.000	PC																																																																						
VI1074A0	4X16 SCREW FOR PLASTIC	2.000	PC																																																																						
VI1103A0	40X12 TBSP SCREW FOR PLASTIC	2.000	PC																																																																						
VI1220A1	4,2x12 TCB SELF-TAPPIN G SCREW	26.000	PC																																																																						
VI1930A1	ST. STEEL 5X20 CHIP SCREW	16.000	PC																																																																						
VI1996A0	M5x35 SCREW	13.000	PC																																																																						
VI2037A1	40X8 TORX SHEETTRACS SELF-THREAD SCREW	6.000	PC																																																																						
VM1490A0	CHEFTOP/BAK ERTOP HANDLE SCREWS COVER	2.000	PC																																																																						
VM1630A1	INTERNAL GLASS PUSHING CAP	3.000	PC																																																																						
VM1631A0	PLUS INNER GLASS PUSHING CAP	3.000	PC																																																																						



COMPONENT			SPARE PART																																																																														
Code	Description	Image	Code	Description	Kit components																																																																												
VT1276A	XEVC-0511-E DOOR EXTERNAL GLASS		KDR1265B	0511 -M LEFT EXTERNAL DOOR	<table border="1"> <thead> <tr> <th>Code</th> <th>Description</th> <th>Qty</th> <th>UOM</th> </tr> </thead> <tbody> <tr> <td>VM2267A0</td> <td>INTERNAL GLASS LOCKING SYSTEM SLIDER</td> <td>2.000</td> <td>PC</td> </tr> <tr> <td>VM2268A0</td> <td>DOOR MAGNET COVER</td> <td>2.000</td> <td>PC</td> </tr> <tr> <td>VM2269B0</td> <td>INNER GLASS FIXING CAP</td> <td>2.000</td> <td>PC</td> </tr> <tr> <td>VM2274A0</td> <td>GROOVED BUSHING</td> <td>1.000</td> <td>PC</td> </tr> <tr> <td>VM2275A0</td> <td>SMOOTH BUSHING</td> <td>1.000</td> <td>PC</td> </tr> <tr> <td>VM2284B0</td> <td>750 SERIES DRIP PROFILE KIT</td> <td>1.000</td> <td>PC</td> </tr> <tr> <td>VM2305A0</td> <td>6 SERIES DOOR CAP FIXING PAWL</td> <td>14.000</td> <td>PC</td> </tr> <tr> <td>VM2313A0</td> <td>TUBE DX DISCHARGE DRIP MM</td> <td>1.000</td> <td>PC</td> </tr> <tr> <td>VM2314A0</td> <td>6 S. DRIP PROFILE CAP</td> <td>1.000</td> <td>PC</td> </tr> <tr> <td>VM2315B0</td> <td>S6 INTERNAL GLASS SUPPORT</td> <td>3.000</td> <td>PC</td> </tr> <tr> <td>VM2383B0</td> <td>S6 LEFT OVENS UPPER RIGHT CAP</td> <td>1.000</td> <td>PC</td> </tr> <tr> <td>VM2384B0</td> <td></td> <td>1.000</td> <td>PC</td> </tr> <tr> <td>VM2385B0</td> <td>S6 LEFT OVENS UPPER LEFT CAP</td> <td>1.000</td> <td>PC</td> </tr> <tr> <td>VM2386B0</td> <td>MM -M LEFT DOOR LEFT LOWER CAP KI</td> <td>1.000</td> <td>PC</td> </tr> <tr> <td>VM2505B1</td> <td>MM PLUS INTERNAL GLASS SUPPORT</td> <td>3.000</td> <td>PC</td> </tr> <tr> <td>VP1080A0</td> <td>UPPER HINGE CAP FOR LOWER INNER GLASS</td> <td>1.000</td> <td>PC</td> </tr> <tr> <td>VP1081A0</td> <td>UPPER HINGE CAP FOR UPPER INNER GLASS</td> <td>1.000</td> <td>PC</td> </tr> <tr> <td>VT1276A0</td> <td>XEVC-0511-E DOOR EXTERNAL GLASS</td> <td>1.000</td> <td>PC</td> </tr> </tbody> </table>	Code	Description	Qty	UOM	VM2267A0	INTERNAL GLASS LOCKING SYSTEM SLIDER	2.000	PC	VM2268A0	DOOR MAGNET COVER	2.000	PC	VM2269B0	INNER GLASS FIXING CAP	2.000	PC	VM2274A0	GROOVED BUSHING	1.000	PC	VM2275A0	SMOOTH BUSHING	1.000	PC	VM2284B0	750 SERIES DRIP PROFILE KIT	1.000	PC	VM2305A0	6 SERIES DOOR CAP FIXING PAWL	14.000	PC	VM2313A0	TUBE DX DISCHARGE DRIP MM	1.000	PC	VM2314A0	6 S. DRIP PROFILE CAP	1.000	PC	VM2315B0	S6 INTERNAL GLASS SUPPORT	3.000	PC	VM2383B0	S6 LEFT OVENS UPPER RIGHT CAP	1.000	PC	VM2384B0		1.000	PC	VM2385B0	S6 LEFT OVENS UPPER LEFT CAP	1.000	PC	VM2386B0	MM -M LEFT DOOR LEFT LOWER CAP KI	1.000	PC	VM2505B1	MM PLUS INTERNAL GLASS SUPPORT	3.000	PC	VP1080A0	UPPER HINGE CAP FOR LOWER INNER GLASS	1.000	PC	VP1081A0	UPPER HINGE CAP FOR UPPER INNER GLASS	1.000	PC	VT1276A0	XEVC-0511-E DOOR EXTERNAL GLASS	1.000	PC
Code	Description	Qty	UOM																																																																														
VM2267A0	INTERNAL GLASS LOCKING SYSTEM SLIDER	2.000	PC																																																																														
VM2268A0	DOOR MAGNET COVER	2.000	PC																																																																														
VM2269B0	INNER GLASS FIXING CAP	2.000	PC																																																																														
VM2274A0	GROOVED BUSHING	1.000	PC																																																																														
VM2275A0	SMOOTH BUSHING	1.000	PC																																																																														
VM2284B0	750 SERIES DRIP PROFILE KIT	1.000	PC																																																																														
VM2305A0	6 SERIES DOOR CAP FIXING PAWL	14.000	PC																																																																														
VM2313A0	TUBE DX DISCHARGE DRIP MM	1.000	PC																																																																														
VM2314A0	6 S. DRIP PROFILE CAP	1.000	PC																																																																														
VM2315B0	S6 INTERNAL GLASS SUPPORT	3.000	PC																																																																														
VM2383B0	S6 LEFT OVENS UPPER RIGHT CAP	1.000	PC																																																																														
VM2384B0		1.000	PC																																																																														
VM2385B0	S6 LEFT OVENS UPPER LEFT CAP	1.000	PC																																																																														
VM2386B0	MM -M LEFT DOOR LEFT LOWER CAP KI	1.000	PC																																																																														
VM2505B1	MM PLUS INTERNAL GLASS SUPPORT	3.000	PC																																																																														
VP1080A0	UPPER HINGE CAP FOR LOWER INNER GLASS	1.000	PC																																																																														
VP1081A0	UPPER HINGE CAP FOR UPPER INNER GLASS	1.000	PC																																																																														
VT1276A0	XEVC-0511-E DOOR EXTERNAL GLASS	1.000	PC																																																																														



COMPONENT			SPARE PART																																																																		
Code	Description	Image	Code	Description	Kit components																																																																
VT1276A	XEVC-0511-E DOOR EXTERNAL GLASS		KDR1265A	0511 LEFT EXTERNAL DOOR	<table border="1"> <thead> <tr> <th>Code</th> <th>Description</th> <th>Qty</th> <th>UOM</th> </tr> </thead> <tbody> <tr> <td>0B1122A1</td> <td>750MM DOOR LOWER FRAME SHAPE</td> <td>1.000</td> <td>PC</td> </tr> <tr> <td>0B1166A1</td> <td>XEVC-0511-E EXT GLASS SUPPORT PROFILE</td> <td>2.000</td> <td>PC</td> </tr> <tr> <td>0B1195B1</td> <td>0511 LEFT DOOR LEFT EXTERNAL COLUMN</td> <td>1.000</td> <td>PC</td> </tr> <tr> <td>0B1196A1</td> <td>0511 LEFT - DOOR RIGHT INT COLUMN</td> <td>1.000</td> <td>PC</td> </tr> <tr> <td>0B1197A1</td> <td>0511 LEFT - DOOR LEFT INT COLUMN</td> <td>1.000</td> <td>PC</td> </tr> <tr> <td>0B1206A0</td> <td>0511 LEFT - DOOR RIGHT EXT COLUMN</td> <td>1.000</td> <td>PC</td> </tr> <tr> <td>0B1216A1</td> <td>MM CT DOUBLE GLASS DOOR UPPER BEAM</td> <td>1.000</td> <td>PC</td> </tr> <tr> <td>0B1217A1</td> <td>MM DOUBLE GLASS DOOR INT UPPER BEAM 750</td> <td>1.000</td> <td>PC</td> </tr> <tr> <td>CE1052A1</td> <td>CABLE CONNECTION CONTROL - USB MM 750m</td> <td>1.000</td> <td>PC</td> </tr> <tr> <td>CE1053B0</td> <td>MM MICROFIT LED BAR POWER SUPPLY CABL</td> <td>1.000</td> <td>PC</td> </tr> <tr> <td>CE1275A0</td> <td>3M POWER - CONTROL CONNECTION CABLE</td> <td>1.000</td> <td>PC</td> </tr> <tr> <td>CE1285A0</td> <td>EMI ROUND FERRITE MOD.26438015 02</td> <td>1.000</td> <td>PC</td> </tr> <tr> <td>CE1290A0</td> <td>EXTRACTABL E FEMALE TERMINAL CPF 5/4</td> <td>1.000</td> <td>PC</td> </tr> <tr> <td>GN1525A0</td> <td>O-RING INT DIAM 9,5 THK 1 NBR 70</td> <td>1.000</td> <td>PC</td> </tr> <tr> <td>LP1019A0</td> <td>6 SERIES L200 LED LIGHT BAR - E415</td> <td>1.000</td> <td>PC</td> </tr> </tbody> </table>	Code	Description	Qty	UOM	0B1122A1	750MM DOOR LOWER FRAME SHAPE	1.000	PC	0B1166A1	XEVC-0511-E EXT GLASS SUPPORT PROFILE	2.000	PC	0B1195B1	0511 LEFT DOOR LEFT EXTERNAL COLUMN	1.000	PC	0B1196A1	0511 LEFT - DOOR RIGHT INT COLUMN	1.000	PC	0B1197A1	0511 LEFT - DOOR LEFT INT COLUMN	1.000	PC	0B1206A0	0511 LEFT - DOOR RIGHT EXT COLUMN	1.000	PC	0B1216A1	MM CT DOUBLE GLASS DOOR UPPER BEAM	1.000	PC	0B1217A1	MM DOUBLE GLASS DOOR INT UPPER BEAM 750	1.000	PC	CE1052A1	CABLE CONNECTION CONTROL - USB MM 750m	1.000	PC	CE1053B0	MM MICROFIT LED BAR POWER SUPPLY CABL	1.000	PC	CE1275A0	3M POWER - CONTROL CONNECTION CABLE	1.000	PC	CE1285A0	EMI ROUND FERRITE MOD.26438015 02	1.000	PC	CE1290A0	EXTRACTABL E FEMALE TERMINAL CPF 5/4	1.000	PC	GN1525A0	O-RING INT DIAM 9,5 THK 1 NBR 70	1.000	PC	LP1019A0	6 SERIES L200 LED LIGHT BAR - E415	1.000	PC
Code	Description	Qty	UOM																																																																		
0B1122A1	750MM DOOR LOWER FRAME SHAPE	1.000	PC																																																																		
0B1166A1	XEVC-0511-E EXT GLASS SUPPORT PROFILE	2.000	PC																																																																		
0B1195B1	0511 LEFT DOOR LEFT EXTERNAL COLUMN	1.000	PC																																																																		
0B1196A1	0511 LEFT - DOOR RIGHT INT COLUMN	1.000	PC																																																																		
0B1197A1	0511 LEFT - DOOR LEFT INT COLUMN	1.000	PC																																																																		
0B1206A0	0511 LEFT - DOOR RIGHT EXT COLUMN	1.000	PC																																																																		
0B1216A1	MM CT DOUBLE GLASS DOOR UPPER BEAM	1.000	PC																																																																		
0B1217A1	MM DOUBLE GLASS DOOR INT UPPER BEAM 750	1.000	PC																																																																		
CE1052A1	CABLE CONNECTION CONTROL - USB MM 750m	1.000	PC																																																																		
CE1053B0	MM MICROFIT LED BAR POWER SUPPLY CABL	1.000	PC																																																																		
CE1275A0	3M POWER - CONTROL CONNECTION CABLE	1.000	PC																																																																		
CE1285A0	EMI ROUND FERRITE MOD.26438015 02	1.000	PC																																																																		
CE1290A0	EXTRACTABL E FEMALE TERMINAL CPF 5/4	1.000	PC																																																																		
GN1525A0	O-RING INT DIAM 9,5 THK 1 NBR 70	1.000	PC																																																																		
LP1019A0	6 SERIES L200 LED LIGHT BAR - E415	1.000	PC																																																																		



COMPONENT			SPARE PART																																																																															
Code	Description	Image	Code	Description	Kit components																																																																													
VT1276A	XEVC-0511-E DOOR EXTERNAL GLASS		KDR1265A	0511 LEFT EXTERNAL DOOR	<table border="1"> <thead> <tr> <th>Code</th> <th>Description</th> <th>Qty</th> <th>UOM</th> </tr> </thead> <tbody> <tr> <td>LP1025A0</td> <td>L=415 LED LIGHT BAR COVER</td> <td>1.000</td> <td>PC</td> </tr> <tr> <td>MG1083A2</td> <td>MM COMPLETE HANDLE</td> <td>1.000</td> <td>PC</td> </tr> <tr> <td>SL1170A1</td> <td>S57 BLACK SILICON - 310ml CARTRIDGE</td> <td>21.000</td> <td>ML</td> </tr> <tr> <td>VE1030A1</td> <td>MAGNET FOR DOOR MICROSWITC H D=22.9mm</td> <td>2.000</td> <td>PC</td> </tr> <tr> <td>VI1034A0</td> <td>STAINLESS STEEL WASHER 8.4x16x1</td> <td>1.000</td> <td>PC</td> </tr> <tr> <td>VI1147A0</td> <td>5X25 STAINLESS STEEL SCREW</td> <td>16.000</td> <td>PC</td> </tr> <tr> <td>VI1220A1</td> <td>4,2x12 TCB SELF-TAPPIN G SCREW</td> <td>23.000</td> <td>PC</td> </tr> <tr> <td>VI1996A0</td> <td>M5x35 SCREW</td> <td>13.000</td> <td>PC</td> </tr> <tr> <td>VM1630A1</td> <td>INTERNAL GLASS PUSHING CAP</td> <td>1.000</td> <td>PC</td> </tr> <tr> <td>VM1631A0</td> <td>PLUS INNER GLASS PUSHING CAP</td> <td>2.000</td> <td>PC</td> </tr> <tr> <td>VM2260A1</td> <td>6 SERIES DOOR UPPER LEFT CAP</td> <td>1.000</td> <td>PC</td> </tr> <tr> <td>VM2267A0</td> <td>INTERNAL GLASS LOCKING SYSTEM SLIDER</td> <td>2.000</td> <td>PC</td> </tr> <tr> <td>VM2268A0</td> <td>DOOR MAGNET COVER</td> <td>2.000</td> <td>PC</td> </tr> <tr> <td>VM2269A0</td> <td>INTERNAL GLASS LOCKING SYSTEM CAP</td> <td>2.000</td> <td>PC</td> </tr> <tr> <td>VM2274A0</td> <td>GROOVED BUSHING</td> <td>1.000</td> <td>PC</td> </tr> <tr> <td>VM2275A0</td> <td>SMOOTH BUSHING</td> <td>1.000</td> <td>PC</td> </tr> <tr> <td>VM2284A0</td> <td>750 SERIES DRIP PROFILE</td> <td>1.000</td> <td>PC</td> </tr> <tr> <td>VM2305A0</td> <td>6 SERIES DOOR CAP FIXING PAWL</td> <td>14.000</td> <td>PC</td> </tr> </tbody> </table>	Code	Description	Qty	UOM	LP1025A0	L=415 LED LIGHT BAR COVER	1.000	PC	MG1083A2	MM COMPLETE HANDLE	1.000	PC	SL1170A1	S57 BLACK SILICON - 310ml CARTRIDGE	21.000	ML	VE1030A1	MAGNET FOR DOOR MICROSWITC H D=22.9mm	2.000	PC	VI1034A0	STAINLESS STEEL WASHER 8.4x16x1	1.000	PC	VI1147A0	5X25 STAINLESS STEEL SCREW	16.000	PC	VI1220A1	4,2x12 TCB SELF-TAPPIN G SCREW	23.000	PC	VI1996A0	M5x35 SCREW	13.000	PC	VM1630A1	INTERNAL GLASS PUSHING CAP	1.000	PC	VM1631A0	PLUS INNER GLASS PUSHING CAP	2.000	PC	VM2260A1	6 SERIES DOOR UPPER LEFT CAP	1.000	PC	VM2267A0	INTERNAL GLASS LOCKING SYSTEM SLIDER	2.000	PC	VM2268A0	DOOR MAGNET COVER	2.000	PC	VM2269A0	INTERNAL GLASS LOCKING SYSTEM CAP	2.000	PC	VM2274A0	GROOVED BUSHING	1.000	PC	VM2275A0	SMOOTH BUSHING	1.000	PC	VM2284A0	750 SERIES DRIP PROFILE	1.000	PC	VM2305A0	6 SERIES DOOR CAP FIXING PAWL	14.000	PC	
Code	Description	Qty	UOM																																																																															
LP1025A0	L=415 LED LIGHT BAR COVER	1.000	PC																																																																															
MG1083A2	MM COMPLETE HANDLE	1.000	PC																																																																															
SL1170A1	S57 BLACK SILICON - 310ml CARTRIDGE	21.000	ML																																																																															
VE1030A1	MAGNET FOR DOOR MICROSWITC H D=22.9mm	2.000	PC																																																																															
VI1034A0	STAINLESS STEEL WASHER 8.4x16x1	1.000	PC																																																																															
VI1147A0	5X25 STAINLESS STEEL SCREW	16.000	PC																																																																															
VI1220A1	4,2x12 TCB SELF-TAPPIN G SCREW	23.000	PC																																																																															
VI1996A0	M5x35 SCREW	13.000	PC																																																																															
VM1630A1	INTERNAL GLASS PUSHING CAP	1.000	PC																																																																															
VM1631A0	PLUS INNER GLASS PUSHING CAP	2.000	PC																																																																															
VM2260A1	6 SERIES DOOR UPPER LEFT CAP	1.000	PC																																																																															
VM2267A0	INTERNAL GLASS LOCKING SYSTEM SLIDER	2.000	PC																																																																															
VM2268A0	DOOR MAGNET COVER	2.000	PC																																																																															
VM2269A0	INTERNAL GLASS LOCKING SYSTEM CAP	2.000	PC																																																																															
VM2274A0	GROOVED BUSHING	1.000	PC																																																																															
VM2275A0	SMOOTH BUSHING	1.000	PC																																																																															
VM2284A0	750 SERIES DRIP PROFILE	1.000	PC																																																																															
VM2305A0	6 SERIES DOOR CAP FIXING PAWL	14.000	PC																																																																															



COMPONENT			SPARE PART																																																																									
Code	Description	Image	Code	Description	Kit components																																																																							
VT1276A	XEVC-0511-E DOOR EXTERNAL GLASS		KDR1265A	0511 LEFT EXTERNAL DOOR	<table border="1"> <thead> <tr> <th>Code</th> <th>Description</th> <th>Qty</th> <th>UOM</th> </tr> </thead> <tbody> <tr> <td>VM2312A0</td> <td>6 S. DRIP PROFILE DRAIN LEFT PIPE</td> <td>1.000</td> <td>PC</td> </tr> <tr> <td>VM2313A0</td> <td>TUBE DX DISCHARGE DRIP MM</td> <td>1.000</td> <td>PC</td> </tr> <tr> <td>VM2314A0</td> <td>6 S. DRIP PROFILE CAP</td> <td>1.000</td> <td>PC</td> </tr> <tr> <td>VM2315A0</td> <td>MIND.Maps INTERNAL GLASS CAP SUPPORT</td> <td>1.000</td> <td>PC</td> </tr> <tr> <td>VM2383A0</td> <td>MM LEFT DOOR RIGHT UPPER CAP</td> <td>1.000</td> <td>PC</td> </tr> <tr> <td>VM2385A1</td> <td>LEFT MM DOOR UPPER LEFT CAP</td> <td>1.000</td> <td>PC</td> </tr> <tr> <td>VM2386A1</td> <td>LEFT MM DOOR LOWER LEFT CAP</td> <td>1.000</td> <td>PC</td> </tr> <tr> <td>VM2505A0</td> <td>MM PLUS INTERNAL GLASS SUPPORT</td> <td>2.000</td> <td>PC</td> </tr> <tr> <td>VM2518A0</td> <td>BOARD COOLING FAN SUPPORT</td> <td>1.000</td> <td>PC</td> </tr> <tr> <td>VN1179A1</td> <td>CONTROL BOARD 40x40x20mm 12V COOLING FAN</td> <td>1.000</td> <td>PC</td> </tr> <tr> <td>VT1276A0</td> <td>XEVC-0511-E DOOR EXTERNAL GLASS</td> <td>1.000</td> <td>PC</td> </tr> </tbody> </table>	Code	Description	Qty	UOM	VM2312A0	6 S. DRIP PROFILE DRAIN LEFT PIPE	1.000	PC	VM2313A0	TUBE DX DISCHARGE DRIP MM	1.000	PC	VM2314A0	6 S. DRIP PROFILE CAP	1.000	PC	VM2315A0	MIND.Maps INTERNAL GLASS CAP SUPPORT	1.000	PC	VM2383A0	MM LEFT DOOR RIGHT UPPER CAP	1.000	PC	VM2385A1	LEFT MM DOOR UPPER LEFT CAP	1.000	PC	VM2386A1	LEFT MM DOOR LOWER LEFT CAP	1.000	PC	VM2505A0	MM PLUS INTERNAL GLASS SUPPORT	2.000	PC	VM2518A0	BOARD COOLING FAN SUPPORT	1.000	PC	VN1179A1	CONTROL BOARD 40x40x20mm 12V COOLING FAN	1.000	PC	VT1276A0	XEVC-0511-E DOOR EXTERNAL GLASS	1.000	PC	KDR1261B	0511 -M RIGHT EXTERNAL DOOR	<table border="1"> <thead> <tr> <th>Code</th> <th>Description</th> <th>Qty</th> <th>UOM</th> </tr> </thead> <tbody> <tr> <td>0B1106A0</td> <td>XEVC-0511-E DOOR EXTERNAL LEFT COLUMN</td> <td>1.000</td> <td>PC</td> </tr> <tr> <td>0B1107A1</td> <td>XEVC-0511-E LEFT INT DOOR COLUM</td> <td>1.000</td> <td>PC</td> </tr> <tr> <td>0B1108B1</td> <td>XEVC-0511 DOOR EXTERNAL RIGHT COLUM</td> <td>1.000</td> <td>PC</td> </tr> <tr> <td>0B1109A1</td> <td>XEVC-0511-E RIGHT INT DOOR COLUM</td> <td>1.000</td> <td>PC</td> </tr> </tbody> </table>	Code	Description	Qty	UOM	0B1106A0	XEVC-0511-E DOOR EXTERNAL LEFT COLUMN	1.000	PC	0B1107A1	XEVC-0511-E LEFT INT DOOR COLUM	1.000	PC	0B1108B1	XEVC-0511 DOOR EXTERNAL RIGHT COLUM	1.000	PC	0B1109A1	XEVC-0511-E RIGHT INT DOOR COLUM	1.000	PC
			Code	Description	Qty	UOM																																																																						
VM2312A0	6 S. DRIP PROFILE DRAIN LEFT PIPE	1.000	PC																																																																									
VM2313A0	TUBE DX DISCHARGE DRIP MM	1.000	PC																																																																									
VM2314A0	6 S. DRIP PROFILE CAP	1.000	PC																																																																									
VM2315A0	MIND.Maps INTERNAL GLASS CAP SUPPORT	1.000	PC																																																																									
VM2383A0	MM LEFT DOOR RIGHT UPPER CAP	1.000	PC																																																																									
VM2385A1	LEFT MM DOOR UPPER LEFT CAP	1.000	PC																																																																									
VM2386A1	LEFT MM DOOR LOWER LEFT CAP	1.000	PC																																																																									
VM2505A0	MM PLUS INTERNAL GLASS SUPPORT	2.000	PC																																																																									
VM2518A0	BOARD COOLING FAN SUPPORT	1.000	PC																																																																									
VN1179A1	CONTROL BOARD 40x40x20mm 12V COOLING FAN	1.000	PC																																																																									
VT1276A0	XEVC-0511-E DOOR EXTERNAL GLASS	1.000	PC																																																																									
Code	Description	Qty	UOM																																																																									
0B1106A0	XEVC-0511-E DOOR EXTERNAL LEFT COLUMN	1.000	PC																																																																									
0B1107A1	XEVC-0511-E LEFT INT DOOR COLUM	1.000	PC																																																																									
0B1108B1	XEVC-0511 DOOR EXTERNAL RIGHT COLUM	1.000	PC																																																																									
0B1109A1	XEVC-0511-E RIGHT INT DOOR COLUM	1.000	PC																																																																									



COMPONENT			SPARE PART																																																																			
Code	Description	Image	Code	Description	Kit components																																																																	
VT1276A	XEVC-0511-E DOOR EXTERNAL GLASS		KDR1261B	0511 -M RIGHT EXTERNAL DOOR	<table border="1"> <thead> <tr> <th>Code</th> <th>Description</th> <th>Qty</th> <th>UOM</th> </tr> </thead> <tbody> <tr> <td>0B1122B0</td> <td>MM CT DOOR LOWER CROSS BAR</td> <td>1.000</td> <td>PC</td> </tr> <tr> <td>0B1166A1</td> <td>XEVC-0511-E EXT GLASS SUPPORT PROFILE</td> <td>2.000</td> <td>PC</td> </tr> <tr> <td>0B1216B0</td> <td>MM CT DOUBLE GLASS DOOR UPPER CROSS BAR</td> <td>1.000</td> <td>PC</td> </tr> <tr> <td>0B1217A1</td> <td>MM DOUBLE GLASS DOOR INT UPPER BEAM 750</td> <td>1.000</td> <td>PC</td> </tr> <tr> <td>CE1052A1</td> <td>CABLE CONNECTION CONTROL - USB MM 750m</td> <td>1.000</td> <td>PC</td> </tr> <tr> <td>CE1053B0</td> <td>MM MICROFIT LED BAR POWER SUPPLY CABL</td> <td>1.000</td> <td>PC</td> </tr> <tr> <td>CE1096A0</td> <td>4 POLES MICROFIT 3 M BUS CABLE</td> <td>1.000</td> <td>PC</td> </tr> <tr> <td>CE1285A0</td> <td>EMI ROUND FERRITE MOD.26438015 02</td> <td>2.000</td> <td>PC</td> </tr> <tr> <td>GN1525A0</td> <td>O-RING INT DIAM 9,5 THK 1 NBR 70</td> <td>1.000</td> <td>PC</td> </tr> <tr> <td>LP1019A0</td> <td>6 SERIES L200 LED LIGHT BAR - E415</td> <td>1.000</td> <td>PC</td> </tr> <tr> <td>LP1025A0</td> <td>L=415 LED LIGHT BAR COVER</td> <td>1.000</td> <td>PC</td> </tr> <tr> <td>MG1099A1</td> <td>MM COMPLETE HANDLE</td> <td>1.000</td> <td>PC</td> </tr> <tr> <td>RC1200A0</td> <td>ED=4 WIRE D.=0.5 COMPRESSIO N SPRING</td> <td>4.000</td> <td>PC</td> </tr> <tr> <td>SL1170A1</td> <td>S57 BLACK SILICON - 310ml CARTRIDGE</td> <td>30.000</td> <td>ML</td> </tr> <tr> <td>SL1221A0</td> <td>GN1/1 EXTERNAL GLASS UPPER SILICONE</td> <td>1.000</td> <td>PC</td> </tr> </tbody> </table>	Code	Description	Qty	UOM	0B1122B0	MM CT DOOR LOWER CROSS BAR	1.000	PC	0B1166A1	XEVC-0511-E EXT GLASS SUPPORT PROFILE	2.000	PC	0B1216B0	MM CT DOUBLE GLASS DOOR UPPER CROSS BAR	1.000	PC	0B1217A1	MM DOUBLE GLASS DOOR INT UPPER BEAM 750	1.000	PC	CE1052A1	CABLE CONNECTION CONTROL - USB MM 750m	1.000	PC	CE1053B0	MM MICROFIT LED BAR POWER SUPPLY CABL	1.000	PC	CE1096A0	4 POLES MICROFIT 3 M BUS CABLE	1.000	PC	CE1285A0	EMI ROUND FERRITE MOD.26438015 02	2.000	PC	GN1525A0	O-RING INT DIAM 9,5 THK 1 NBR 70	1.000	PC	LP1019A0	6 SERIES L200 LED LIGHT BAR - E415	1.000	PC	LP1025A0	L=415 LED LIGHT BAR COVER	1.000	PC	MG1099A1	MM COMPLETE HANDLE	1.000	PC	RC1200A0	ED=4 WIRE D.=0.5 COMPRESSIO N SPRING	4.000	PC	SL1170A1	S57 BLACK SILICON - 310ml CARTRIDGE	30.000	ML	SL1221A0	GN1/1 EXTERNAL GLASS UPPER SILICONE	1.000	PC	
Code	Description	Qty	UOM																																																																			
0B1122B0	MM CT DOOR LOWER CROSS BAR	1.000	PC																																																																			
0B1166A1	XEVC-0511-E EXT GLASS SUPPORT PROFILE	2.000	PC																																																																			
0B1216B0	MM CT DOUBLE GLASS DOOR UPPER CROSS BAR	1.000	PC																																																																			
0B1217A1	MM DOUBLE GLASS DOOR INT UPPER BEAM 750	1.000	PC																																																																			
CE1052A1	CABLE CONNECTION CONTROL - USB MM 750m	1.000	PC																																																																			
CE1053B0	MM MICROFIT LED BAR POWER SUPPLY CABL	1.000	PC																																																																			
CE1096A0	4 POLES MICROFIT 3 M BUS CABLE	1.000	PC																																																																			
CE1285A0	EMI ROUND FERRITE MOD.26438015 02	2.000	PC																																																																			
GN1525A0	O-RING INT DIAM 9,5 THK 1 NBR 70	1.000	PC																																																																			
LP1019A0	6 SERIES L200 LED LIGHT BAR - E415	1.000	PC																																																																			
LP1025A0	L=415 LED LIGHT BAR COVER	1.000	PC																																																																			
MG1099A1	MM COMPLETE HANDLE	1.000	PC																																																																			
RC1200A0	ED=4 WIRE D.=0.5 COMPRESSIO N SPRING	4.000	PC																																																																			
SL1170A1	S57 BLACK SILICON - 310ml CARTRIDGE	30.000	ML																																																																			
SL1221A0	GN1/1 EXTERNAL GLASS UPPER SILICONE	1.000	PC																																																																			



COMPONENT			SPARE PART																																																																										
Code	Description	Image	Code	Description	Kit components																																																																								
VT1276A	XEVC-0511-E DOOR EXTERNAL GLASS		KDR1261B	0511 -M RIGHT EXTERNAL DOOR	<table border="1"> <thead> <tr> <th>Code</th> <th>Description</th> <th>Qty</th> <th>UOM</th> </tr> </thead> <tbody> <tr> <td>SL1222A0</td> <td>0511 EXTERNAL GLASS LATERAL SILICONE</td> <td>4.000</td> <td>PC</td> </tr> <tr> <td>VE1030A1</td> <td>MAGNET FOR DOOR MICROSWITC H D=22,9mm</td> <td>2.000</td> <td>PC</td> </tr> <tr> <td>VI0239A1</td> <td>SELF-TAPPIN G SCREW 4.2X25 TCB+ INOX</td> <td>4.000</td> <td>PC</td> </tr> <tr> <td>VI1034A0</td> <td>STAINLESS STEEL WASHER 8.4x16x1</td> <td>1.000</td> <td>PC</td> </tr> <tr> <td>VI1074A0</td> <td>4X16 SCREW FOR PLASTIC</td> <td>2.000</td> <td>PC</td> </tr> <tr> <td>VI1103A0</td> <td>40X12 TBSP SCREW FOR PLASTIC</td> <td>2.000</td> <td>PC</td> </tr> <tr> <td>VI1220A1</td> <td>4,2x12 TCB SELF-TAPPIN G SCREW</td> <td>26.000</td> <td>PC</td> </tr> <tr> <td>VI1930A1</td> <td>ST. STEEL 5X20 CHIP SCREW</td> <td>16.000</td> <td>PC</td> </tr> <tr> <td>VI1996A0</td> <td>M5x35 SCREW</td> <td>13.000</td> <td>PC</td> </tr> <tr> <td>VI2037A1</td> <td>40X8 TORX SHEETTRACS SELF-THREAD SCREW</td> <td>6.000</td> <td>PC</td> </tr> <tr> <td>VM1490A0</td> <td>CHEFTOP/BAK ERTOP HANDLE SCREWS COVER</td> <td>2.000</td> <td>PC</td> </tr> <tr> <td>VM1630A1</td> <td>INTERNAL GLASS PUSHING CAP</td> <td>3.000</td> <td>PC</td> </tr> <tr> <td>VM1631A0</td> <td>PLUS INNER GLASS PUSHING CAP</td> <td>3.000</td> <td>PC</td> </tr> <tr> <td>VM2259B0</td> <td>VM2259B0</td> <td>1.000</td> <td>PC</td> </tr> <tr> <td>VM2260B0</td> <td>S6 LEFT UPPER CAP</td> <td>1.000</td> <td>PC</td> </tr> <tr> <td>VM2261B0</td> <td>MM -M DOOR RIGHT LOWER CAP</td> <td>1.000</td> <td>PC</td> </tr> <tr> <td>VM2262B0</td> <td>MM -M DOOR RIGHT UPPER CAP</td> <td>1.000</td> <td>PC</td> </tr> </tbody> </table>	Code	Description	Qty	UOM	SL1222A0	0511 EXTERNAL GLASS LATERAL SILICONE	4.000	PC	VE1030A1	MAGNET FOR DOOR MICROSWITC H D=22,9mm	2.000	PC	VI0239A1	SELF-TAPPIN G SCREW 4.2X25 TCB+ INOX	4.000	PC	VI1034A0	STAINLESS STEEL WASHER 8.4x16x1	1.000	PC	VI1074A0	4X16 SCREW FOR PLASTIC	2.000	PC	VI1103A0	40X12 TBSP SCREW FOR PLASTIC	2.000	PC	VI1220A1	4,2x12 TCB SELF-TAPPIN G SCREW	26.000	PC	VI1930A1	ST. STEEL 5X20 CHIP SCREW	16.000	PC	VI1996A0	M5x35 SCREW	13.000	PC	VI2037A1	40X8 TORX SHEETTRACS SELF-THREAD SCREW	6.000	PC	VM1490A0	CHEFTOP/BAK ERTOP HANDLE SCREWS COVER	2.000	PC	VM1630A1	INTERNAL GLASS PUSHING CAP	3.000	PC	VM1631A0	PLUS INNER GLASS PUSHING CAP	3.000	PC	VM2259B0	VM2259B0	1.000	PC	VM2260B0	S6 LEFT UPPER CAP	1.000	PC	VM2261B0	MM -M DOOR RIGHT LOWER CAP	1.000	PC	VM2262B0	MM -M DOOR RIGHT UPPER CAP	1.000	PC
Code	Description	Qty	UOM																																																																										
SL1222A0	0511 EXTERNAL GLASS LATERAL SILICONE	4.000	PC																																																																										
VE1030A1	MAGNET FOR DOOR MICROSWITC H D=22,9mm	2.000	PC																																																																										
VI0239A1	SELF-TAPPIN G SCREW 4.2X25 TCB+ INOX	4.000	PC																																																																										
VI1034A0	STAINLESS STEEL WASHER 8.4x16x1	1.000	PC																																																																										
VI1074A0	4X16 SCREW FOR PLASTIC	2.000	PC																																																																										
VI1103A0	40X12 TBSP SCREW FOR PLASTIC	2.000	PC																																																																										
VI1220A1	4,2x12 TCB SELF-TAPPIN G SCREW	26.000	PC																																																																										
VI1930A1	ST. STEEL 5X20 CHIP SCREW	16.000	PC																																																																										
VI1996A0	M5x35 SCREW	13.000	PC																																																																										
VI2037A1	40X8 TORX SHEETTRACS SELF-THREAD SCREW	6.000	PC																																																																										
VM1490A0	CHEFTOP/BAK ERTOP HANDLE SCREWS COVER	2.000	PC																																																																										
VM1630A1	INTERNAL GLASS PUSHING CAP	3.000	PC																																																																										
VM1631A0	PLUS INNER GLASS PUSHING CAP	3.000	PC																																																																										
VM2259B0	VM2259B0	1.000	PC																																																																										
VM2260B0	S6 LEFT UPPER CAP	1.000	PC																																																																										
VM2261B0	MM -M DOOR RIGHT LOWER CAP	1.000	PC																																																																										
VM2262B0	MM -M DOOR RIGHT UPPER CAP	1.000	PC																																																																										



COMPONENT			SPARE PART																																																																													
Code	Description	Image	Code	Description	Kit components																																																																											
VT1276A	XEVC-0511-E DOOR EXTERNAL GLASS		KDR1261B	0511 -M RIGHT EXTERNAL DOOR	<table border="1"> <thead> <tr> <th>Code</th> <th>Description</th> <th>Qty</th> <th>UOM</th> </tr> </thead> <tbody> <tr> <td>VM2267A0</td> <td>INTERNAL GLASS LOCKING SYSTEM SLIDER</td> <td>2.000</td> <td>PC</td> </tr> <tr> <td>VM2268A0</td> <td>DOOR MAGNET COVER</td> <td>2.000</td> <td>PC</td> </tr> <tr> <td>VM2269B0</td> <td>INNER GLASS FIXING CAP</td> <td>2.000</td> <td>PC</td> </tr> <tr> <td>VM2274A0</td> <td>GROOVED BUSHING</td> <td>1.000</td> <td>PC</td> </tr> <tr> <td>VM2275A0</td> <td>SMOOTH BUSHING</td> <td>1.000</td> <td>PC</td> </tr> <tr> <td>VM2284B0</td> <td>750 SERIES DRIP PROFILE KIT</td> <td>1.000</td> <td>PC</td> </tr> <tr> <td>VM2305A0</td> <td>6 SERIES DOOR CAP FIXING PAWL</td> <td>14.000</td> <td>PC</td> </tr> <tr> <td>VM2312A0</td> <td>6 S. DRIP PROFILE DRAIN LEFT PIPE</td> <td>1.000</td> <td>PC</td> </tr> <tr> <td>VM2314A0</td> <td>6 S. DRIP PROFILE CAP</td> <td>1.000</td> <td>PC</td> </tr> <tr> <td>VM2315B0</td> <td>S6 INTERNAL GLASS SUPPORT</td> <td>3.000</td> <td>PC</td> </tr> <tr> <td>VM2505B1</td> <td>MM PLUS INTERNAL GLASS SUPPORT</td> <td>3.000</td> <td>PC</td> </tr> <tr> <td>VP1080A0</td> <td>UPPER HINGE CAP FOR LOWER INNER GLASS</td> <td>1.000</td> <td>PC</td> </tr> <tr> <td>VP1081A0</td> <td>UPPER HINGE CAP FOR UPPER INNER GLASS</td> <td>1.000</td> <td>PC</td> </tr> <tr> <td>VT1276A0</td> <td>XEVC-0511-E DOOR EXTERNAL GLASS</td> <td>1.000</td> <td>PC</td> </tr> </tbody> </table>	Code	Description	Qty	UOM	VM2267A0	INTERNAL GLASS LOCKING SYSTEM SLIDER	2.000	PC	VM2268A0	DOOR MAGNET COVER	2.000	PC	VM2269B0	INNER GLASS FIXING CAP	2.000	PC	VM2274A0	GROOVED BUSHING	1.000	PC	VM2275A0	SMOOTH BUSHING	1.000	PC	VM2284B0	750 SERIES DRIP PROFILE KIT	1.000	PC	VM2305A0	6 SERIES DOOR CAP FIXING PAWL	14.000	PC	VM2312A0	6 S. DRIP PROFILE DRAIN LEFT PIPE	1.000	PC	VM2314A0	6 S. DRIP PROFILE CAP	1.000	PC	VM2315B0	S6 INTERNAL GLASS SUPPORT	3.000	PC	VM2505B1	MM PLUS INTERNAL GLASS SUPPORT	3.000	PC	VP1080A0	UPPER HINGE CAP FOR LOWER INNER GLASS	1.000	PC	VP1081A0	UPPER HINGE CAP FOR UPPER INNER GLASS	1.000	PC	VT1276A0	XEVC-0511-E DOOR EXTERNAL GLASS	1.000	PC	KDR1261A	0511 RIGHT EXTERNAL DOOR	<table border="1"> <thead> <tr> <th>Code</th> <th>Description</th> <th>Qty</th> <th>UOM</th> </tr> </thead> <tbody> <tr> <td>0B1106A0</td> <td>XEVC-0511-E DOOR EXTERNAL LEFT COLUMN</td> <td>1.000</td> <td>PC</td> </tr> <tr> <td>0B1107A1</td> <td>XEVC-0511-E LEFT INT DOOR COLUM</td> <td>1.000</td> <td>PC</td> </tr> </tbody> </table>	Code	Description	Qty	UOM	0B1106A0	XEVC-0511-E DOOR EXTERNAL LEFT COLUMN	1.000	PC	0B1107A1	XEVC-0511-E LEFT INT DOOR COLUM	1.000	PC
			Code	Description	Qty	UOM																																																																										
VM2267A0	INTERNAL GLASS LOCKING SYSTEM SLIDER	2.000	PC																																																																													
VM2268A0	DOOR MAGNET COVER	2.000	PC																																																																													
VM2269B0	INNER GLASS FIXING CAP	2.000	PC																																																																													
VM2274A0	GROOVED BUSHING	1.000	PC																																																																													
VM2275A0	SMOOTH BUSHING	1.000	PC																																																																													
VM2284B0	750 SERIES DRIP PROFILE KIT	1.000	PC																																																																													
VM2305A0	6 SERIES DOOR CAP FIXING PAWL	14.000	PC																																																																													
VM2312A0	6 S. DRIP PROFILE DRAIN LEFT PIPE	1.000	PC																																																																													
VM2314A0	6 S. DRIP PROFILE CAP	1.000	PC																																																																													
VM2315B0	S6 INTERNAL GLASS SUPPORT	3.000	PC																																																																													
VM2505B1	MM PLUS INTERNAL GLASS SUPPORT	3.000	PC																																																																													
VP1080A0	UPPER HINGE CAP FOR LOWER INNER GLASS	1.000	PC																																																																													
VP1081A0	UPPER HINGE CAP FOR UPPER INNER GLASS	1.000	PC																																																																													
VT1276A0	XEVC-0511-E DOOR EXTERNAL GLASS	1.000	PC																																																																													
Code	Description	Qty	UOM																																																																													
0B1106A0	XEVC-0511-E DOOR EXTERNAL LEFT COLUMN	1.000	PC																																																																													
0B1107A1	XEVC-0511-E LEFT INT DOOR COLUM	1.000	PC																																																																													



COMPONENT			SPARE PART					
Code	Description	Image	Code	Description	Kit components			
VT1276A	XEVC-0511-E DOOR EXTERNAL GLASS		KDR1261A	0511 RIGHT EXTERNAL DOOR	Code	Description	Qty	UOM
					0B1108B1	XEVC-0511 DOOR EXTERNAL RIGHT COLUM	1.000	PC
					0B1109A1	XEVC-0511-E RIGHT INT DOOR COLUM	1.000	PC
					0B1122A1	750MM DOOR LOWER FRAME SHAPE	1.000	PC
					0B1166A1	XEVC-0511-E EXT GLASS SUPPORT PROFILE	2.000	PC
					0B1216A1	MM CT DOUBLE GLASS DOOR UPPER BEAM	1.000	PC
					0B1217A1	MM DOUBLE GLASS DOOR INT UPPER BEAM 750	1.000	PC
					CE1052A1	CABLE CONNECTION CONTROL - USB MM 750m	1.000	PC
					CE1053B0	MM MICROFIT LED BAR POWER SUPPLY CABL	1.000	PC
					CE1275A0	3M POWER - CONTROL CONNECTION CABLE	1.000	PC
					CE1285A0	EMI ROUND FERRITE MOD.26438015 02	1.000	PC
					CE1290A0	EXTRACTABL E FEMALE TERMINAL CPF 5/4	1.000	PC
					GN1525A0	O-RING INT DIAM 9,5 THK 1 NBR 70	1.000	PC
					LP1019A0	6 SERIES L200 LED LIGHT BAR - E415	1.000	PC
					LP1025A0	L=415 LED LIGHT BAR COVER	1.000	PC
MG1083A2	MM COMPLETE HANDLE	1.000	PC					



COMPONENT			SPARE PART																																																																														
Code	Description	Image	Code	Description	Kit components																																																																												
VT1276A	XEVC-0511-E DOOR EXTERNAL GLASS		KDR1261A	0511 RIGHT EXTERNAL DOOR	<table border="1"> <thead> <tr> <th>Code</th> <th>Description</th> <th>Qty</th> <th>UOM</th> </tr> </thead> <tbody> <tr> <td>SL1170A1</td> <td>S57 BLACK SILICON - 310ml CARTRIDGE</td> <td>30.000</td> <td>ML</td> </tr> <tr> <td>VE1030A1</td> <td>MAGNET FOR DOOR MICROSWITC H D=22,9mm</td> <td>2.000</td> <td>PC</td> </tr> <tr> <td>VI1034A0</td> <td>STAINLESS STEEL WASHER 8,4x16x1</td> <td>1.000</td> <td>PC</td> </tr> <tr> <td>VI1147A0</td> <td>5X25 STAINLESS STEEL SCREW</td> <td>16.000</td> <td>PC</td> </tr> <tr> <td>VI1220A1</td> <td>4,2x12 TCB SELF-TAPPIN G SCREW</td> <td>25.000</td> <td>PC</td> </tr> <tr> <td>VI1996A0</td> <td>M5x35 SCREW</td> <td>13.000</td> <td>PC</td> </tr> <tr> <td>VM1630A1</td> <td>INTERNAL GLASS PUSHING CAP</td> <td>3.000</td> <td>PC</td> </tr> <tr> <td>VM1631A0</td> <td>PLUS INNER GLASS PUSHING CAP</td> <td>2.000</td> <td>PC</td> </tr> <tr> <td>VM2259A1</td> <td>6 SERIES DOOR LOWER LEFT CAP</td> <td>1.000</td> <td>PC</td> </tr> <tr> <td>VM2260A1</td> <td>6 SERIES DOOR UPPER LEFT CAP</td> <td>1.000</td> <td>PC</td> </tr> <tr> <td>VM2261A1</td> <td>MM DOOR LOWER RIGHT CAP</td> <td>1.000</td> <td>PC</td> </tr> <tr> <td>VM2262A1</td> <td>MM DOOR UPPER RIGHT CAP</td> <td>1.000</td> <td>PC</td> </tr> <tr> <td>VM2267A0</td> <td>INTERNAL GLASS LOCKING SYSTEM SLIDER</td> <td>2.000</td> <td>PC</td> </tr> <tr> <td>VM2268A0</td> <td>DOOR MAGNET COVER</td> <td>2.000</td> <td>PC</td> </tr> <tr> <td>VM2269A0</td> <td>INTERNAL GLASS LOCKING SYSTEM CAP</td> <td>2.000</td> <td>PC</td> </tr> <tr> <td>VM2274A0</td> <td>GROOVED BUSHING</td> <td>1.000</td> <td>PC</td> </tr> <tr> <td>VM2275A0</td> <td>SMOOTH BUSHING</td> <td>1.000</td> <td>PC</td> </tr> <tr> <td>VM2284A0</td> <td>750 SERIES DRIP PROFILE</td> <td>1.000</td> <td>PC</td> </tr> </tbody> </table>	Code	Description	Qty	UOM	SL1170A1	S57 BLACK SILICON - 310ml CARTRIDGE	30.000	ML	VE1030A1	MAGNET FOR DOOR MICROSWITC H D=22,9mm	2.000	PC	VI1034A0	STAINLESS STEEL WASHER 8,4x16x1	1.000	PC	VI1147A0	5X25 STAINLESS STEEL SCREW	16.000	PC	VI1220A1	4,2x12 TCB SELF-TAPPIN G SCREW	25.000	PC	VI1996A0	M5x35 SCREW	13.000	PC	VM1630A1	INTERNAL GLASS PUSHING CAP	3.000	PC	VM1631A0	PLUS INNER GLASS PUSHING CAP	2.000	PC	VM2259A1	6 SERIES DOOR LOWER LEFT CAP	1.000	PC	VM2260A1	6 SERIES DOOR UPPER LEFT CAP	1.000	PC	VM2261A1	MM DOOR LOWER RIGHT CAP	1.000	PC	VM2262A1	MM DOOR UPPER RIGHT CAP	1.000	PC	VM2267A0	INTERNAL GLASS LOCKING SYSTEM SLIDER	2.000	PC	VM2268A0	DOOR MAGNET COVER	2.000	PC	VM2269A0	INTERNAL GLASS LOCKING SYSTEM CAP	2.000	PC	VM2274A0	GROOVED BUSHING	1.000	PC	VM2275A0	SMOOTH BUSHING	1.000	PC	VM2284A0	750 SERIES DRIP PROFILE	1.000	PC
Code	Description	Qty	UOM																																																																														
SL1170A1	S57 BLACK SILICON - 310ml CARTRIDGE	30.000	ML																																																																														
VE1030A1	MAGNET FOR DOOR MICROSWITC H D=22,9mm	2.000	PC																																																																														
VI1034A0	STAINLESS STEEL WASHER 8,4x16x1	1.000	PC																																																																														
VI1147A0	5X25 STAINLESS STEEL SCREW	16.000	PC																																																																														
VI1220A1	4,2x12 TCB SELF-TAPPIN G SCREW	25.000	PC																																																																														
VI1996A0	M5x35 SCREW	13.000	PC																																																																														
VM1630A1	INTERNAL GLASS PUSHING CAP	3.000	PC																																																																														
VM1631A0	PLUS INNER GLASS PUSHING CAP	2.000	PC																																																																														
VM2259A1	6 SERIES DOOR LOWER LEFT CAP	1.000	PC																																																																														
VM2260A1	6 SERIES DOOR UPPER LEFT CAP	1.000	PC																																																																														
VM2261A1	MM DOOR LOWER RIGHT CAP	1.000	PC																																																																														
VM2262A1	MM DOOR UPPER RIGHT CAP	1.000	PC																																																																														
VM2267A0	INTERNAL GLASS LOCKING SYSTEM SLIDER	2.000	PC																																																																														
VM2268A0	DOOR MAGNET COVER	2.000	PC																																																																														
VM2269A0	INTERNAL GLASS LOCKING SYSTEM CAP	2.000	PC																																																																														
VM2274A0	GROOVED BUSHING	1.000	PC																																																																														
VM2275A0	SMOOTH BUSHING	1.000	PC																																																																														
VM2284A0	750 SERIES DRIP PROFILE	1.000	PC																																																																														



COMPONENT			SPARE PART																																						
Code	Description	Image	Code	Description	Kit components																																				
VT1276A	XEVC-0511-E DOOR EXTERNAL GLASS		KDR1261A	0511 RIGHT EXTERNAL DOOR	<table border="1"> <thead> <tr> <th>Code</th> <th>Description</th> <th>Qty</th> <th>UOM</th> </tr> </thead> <tbody> <tr> <td>VM2305A0</td> <td>6 SERIES DOOR CAP FIXING PAWL</td> <td>14.000</td> <td>PC</td> </tr> <tr> <td>VM2312A0</td> <td>6 S. DRIP PROFILE DRAIN LEFT PIPE</td> <td>1.000</td> <td>PC</td> </tr> <tr> <td>VM2314A0</td> <td>6 S. DRIP PROFILE CAP</td> <td>1.000</td> <td>PC</td> </tr> <tr> <td>VM2315A0</td> <td>MIND.Maps INTERNAL GLASS CAP SUPPORT</td> <td>3.000</td> <td>PC</td> </tr> <tr> <td>VM2505A0</td> <td>MM PLUS INTERNAL GLASS SUPPORT</td> <td>2.000</td> <td>PC</td> </tr> <tr> <td>VM2518A0</td> <td>BOARD COOLING FAN SUPPORT</td> <td>1.000</td> <td>PC</td> </tr> <tr> <td>VN1179A1</td> <td>CONTROL BOARD 40x40x20mm 12V COOLING FAN</td> <td>1.000</td> <td>PC</td> </tr> <tr> <td>VT1276A0</td> <td>XEVC-0511-E DOOR EXTERNAL GLASS</td> <td>1.000</td> <td>PC</td> </tr> </tbody> </table>	Code	Description	Qty	UOM	VM2305A0	6 SERIES DOOR CAP FIXING PAWL	14.000	PC	VM2312A0	6 S. DRIP PROFILE DRAIN LEFT PIPE	1.000	PC	VM2314A0	6 S. DRIP PROFILE CAP	1.000	PC	VM2315A0	MIND.Maps INTERNAL GLASS CAP SUPPORT	3.000	PC	VM2505A0	MM PLUS INTERNAL GLASS SUPPORT	2.000	PC	VM2518A0	BOARD COOLING FAN SUPPORT	1.000	PC	VN1179A1	CONTROL BOARD 40x40x20mm 12V COOLING FAN	1.000	PC	VT1276A0	XEVC-0511-E DOOR EXTERNAL GLASS	1.000	PC
Code	Description	Qty	UOM																																						
VM2305A0	6 SERIES DOOR CAP FIXING PAWL	14.000	PC																																						
VM2312A0	6 S. DRIP PROFILE DRAIN LEFT PIPE	1.000	PC																																						
VM2314A0	6 S. DRIP PROFILE CAP	1.000	PC																																						
VM2315A0	MIND.Maps INTERNAL GLASS CAP SUPPORT	3.000	PC																																						
VM2505A0	MM PLUS INTERNAL GLASS SUPPORT	2.000	PC																																						
VM2518A0	BOARD COOLING FAN SUPPORT	1.000	PC																																						
VN1179A1	CONTROL BOARD 40x40x20mm 12V COOLING FAN	1.000	PC																																						
VT1276A0	XEVC-0511-E DOOR EXTERNAL GLASS	1.000	PC																																						

ASM2926A/0.D03 - Electrical system

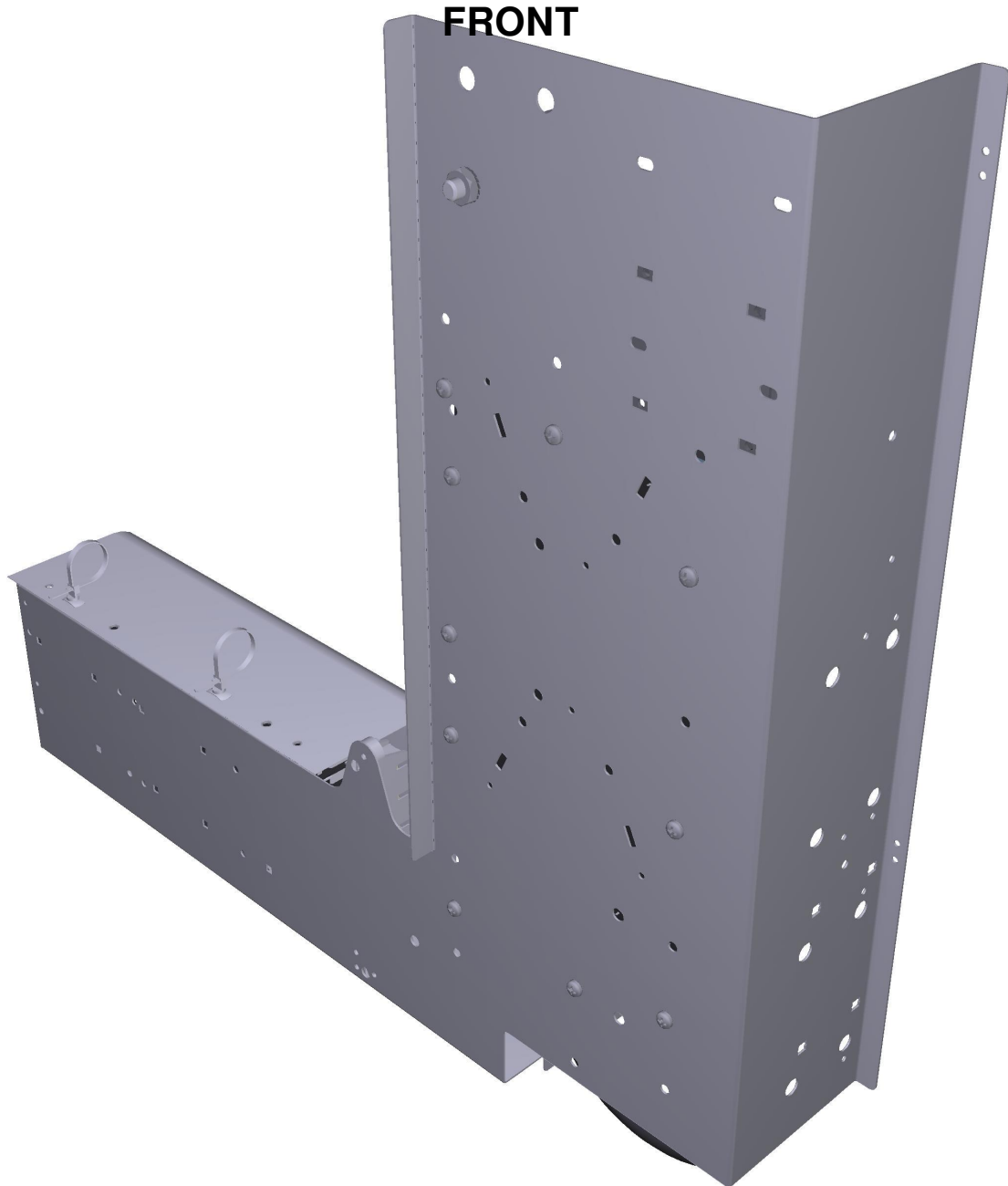



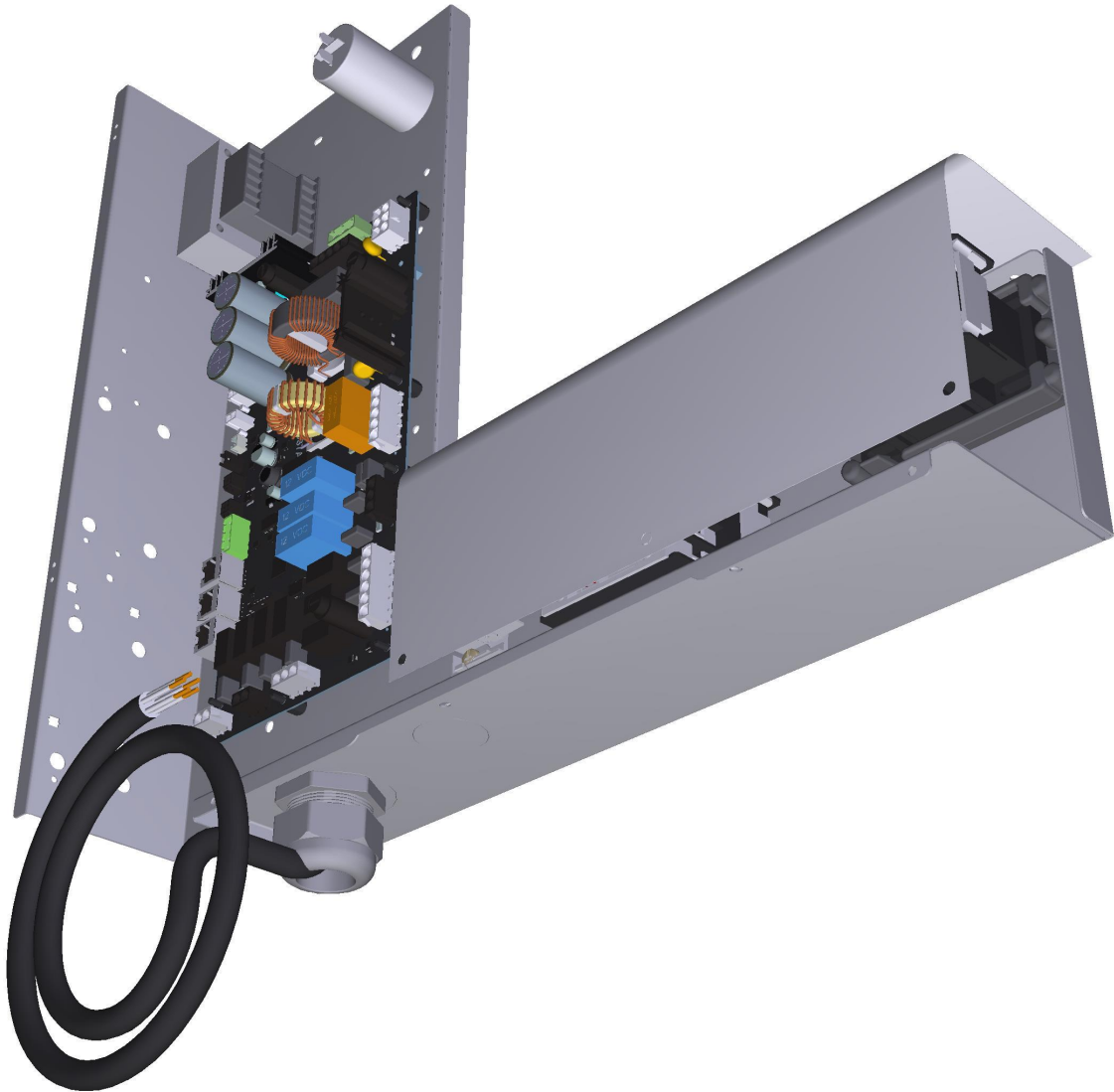

ASM2926A/0.D03 - Electrical system

REAR



COMPONENT			SPARE PART																														
Code	Description	Image	Code	Description	Kit components																												
0H7250A	MM GN1/1 ELECT. COMPONENTS HOLDER		0H7250A0	MM GN1/1 ELECT. COMPONENTS HOLDER																													
PE2037A	MIND.Maps ONE POWER CARD		KPE2037A	MIND.MAPS ONE POWER BOARD KIT	<table border="1"> <thead> <tr> <th>Code</th> <th>Description</th> <th>Qty</th> <th>UOM</th> </tr> </thead> <tbody> <tr> <td>PE2037A0</td> <td>MIND.Maps ONE POWER CARD</td> <td>1.000</td> <td>PC</td> </tr> <tr> <td>VI1850A0</td> <td>TCB M4x6 SCREW</td> <td>9.000</td> <td>PC</td> </tr> <tr> <td>VM1745A0</td> <td>CARD SUPPORT</td> <td>9.000</td> <td>PC</td> </tr> </tbody> </table>	Code	Description	Qty	UOM	PE2037A0	MIND.Maps ONE POWER CARD	1.000	PC	VI1850A0	TCB M4x6 SCREW	9.000	PC	VM1745A0	CARD SUPPORT	9.000	PC												
Code	Description	Qty	UOM																														
PE2037A0	MIND.Maps ONE POWER CARD	1.000	PC																														
VI1850A0	TCB M4x6 SCREW	9.000	PC																														
VM1745A0	CARD SUPPORT	9.000	PC																														
VE1644A	PG 29 STRAIN RELIEF NUT		KVE1645A	REDUCED PG 29 STRAIN RELIEF + NUT KIT	<table border="1"> <thead> <tr> <th>Code</th> <th>Description</th> <th>Qty</th> <th>UOM</th> </tr> </thead> <tbody> <tr> <td>VE1644A0</td> <td>PG 29 STRAIN RELIEF NUT</td> <td>1.000</td> <td>PC</td> </tr> <tr> <td>VE1645A1</td> <td>REDUCED PG 29 STRAIN RELIEF</td> <td>1.000</td> <td>PC</td> </tr> </tbody> </table>	Code	Description	Qty	UOM	VE1644A0	PG 29 STRAIN RELIEF NUT	1.000	PC	VE1645A1	REDUCED PG 29 STRAIN RELIEF	1.000	PC																
Code	Description	Qty	UOM																														
VE1644A0	PG 29 STRAIN RELIEF NUT	1.000	PC																														
VE1645A1	REDUCED PG 29 STRAIN RELIEF	1.000	PC																														
VE1645A	REDUCED PG 29 STRAIN RELIEF		KVE1645A	REDUCED PG 29 STRAIN RELIEF + NUT KIT	<table border="1"> <thead> <tr> <th>Code</th> <th>Description</th> <th>Qty</th> <th>UOM</th> </tr> </thead> <tbody> <tr> <td>VE1644A0</td> <td>PG 29 STRAIN RELIEF NUT</td> <td>1.000</td> <td>PC</td> </tr> <tr> <td>VE1645A1</td> <td>REDUCED PG 29 STRAIN RELIEF</td> <td>1.000</td> <td>PC</td> </tr> </tbody> </table>	Code	Description	Qty	UOM	VE1644A0	PG 29 STRAIN RELIEF NUT	1.000	PC	VE1645A1	REDUCED PG 29 STRAIN RELIEF	1.000	PC																
Code	Description	Qty	UOM																														
VE1644A0	PG 29 STRAIN RELIEF NUT	1.000	PC																														
VE1645A1	REDUCED PG 29 STRAIN RELIEF	1.000	PC																														
VE1095A	GE 25A 230V REMOTE CONTROL SWITCH		KVE2000A	50/60HZ 230V 30A 4P CONTACTOR KIT	<table border="1"> <thead> <tr> <th>Code</th> <th>Description</th> <th>Qty</th> <th>UOM</th> </tr> </thead> <tbody> <tr> <td>CE1455A0</td> <td>TIP END FITTING</td> <td>2.000</td> <td>PC</td> </tr> <tr> <td>CE1560A0</td> <td>BALCK UNIP AWG18 ST.3135 WIRE</td> <td>0.250</td> <td>M</td> </tr> <tr> <td>VE2000A0</td> <td>50/60HZ 230V 30A 4P CONTACTOR</td> <td>1.000</td> <td>PC</td> </tr> <tr> <td>VI1220A1</td> <td>4,2x12 TCB SELF-TAPPIN G SCREW</td> <td>2.000</td> <td>PC</td> </tr> <tr> <td>VM1075A1</td> <td>PLASTIC CLIP TO FIX CONTACTORS</td> <td>4.000</td> <td>PC</td> </tr> <tr> <td>VM2191A1</td> <td>VE1095 CONTACTOR BRACKET</td> <td>1.000</td> <td>PC</td> </tr> </tbody> </table>	Code	Description	Qty	UOM	CE1455A0	TIP END FITTING	2.000	PC	CE1560A0	BALCK UNIP AWG18 ST.3135 WIRE	0.250	M	VE2000A0	50/60HZ 230V 30A 4P CONTACTOR	1.000	PC	VI1220A1	4,2x12 TCB SELF-TAPPIN G SCREW	2.000	PC	VM1075A1	PLASTIC CLIP TO FIX CONTACTORS	4.000	PC	VM2191A1	VE1095 CONTACTOR BRACKET	1.000	PC
Code	Description	Qty	UOM																														
CE1455A0	TIP END FITTING	2.000	PC																														
CE1560A0	BALCK UNIP AWG18 ST.3135 WIRE	0.250	M																														
VE2000A0	50/60HZ 230V 30A 4P CONTACTOR	1.000	PC																														
VI1220A1	4,2x12 TCB SELF-TAPPIN G SCREW	2.000	PC																														
VM1075A1	PLASTIC CLIP TO FIX CONTACTORS	4.000	PC																														
VM2191A1	VE1095 CONTACTOR BRACKET	1.000	PC																														

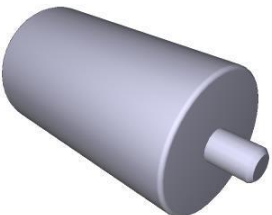

COMPONENT			SPARE PART																		
Code	Description	Image	Code	Description	Kit components																
VM2191A	VE1095 BIG SWITCH BRACKET		VM2191A0	VE1095 BIG SWITCH BRACKET																	
CE1355A	CABLE 5 X 2,5 MMQ H07RNF L = 1,5 MT		KCE1355A	L=1.5M 5x2.5mmq POWER CABLE KIT	<table border="1"> <thead> <tr> <th>Code</th> <th>Description</th> <th>Qty</th> <th>UOM</th> </tr> </thead> <tbody> <tr> <td>CE1355A1</td> <td>CABLE 5 X 2,5 MMQ H07RNF L = 1,5 MT</td> <td>1.000</td> <td>PC</td> </tr> </tbody> </table>	Code	Description	Qty	UOM	CE1355A1	CABLE 5 X 2,5 MMQ H07RNF L = 1,5 MT	1.000	PC								
Code	Description	Qty	UOM																		
CE1355A1	CABLE 5 X 2,5 MMQ H07RNF L = 1,5 MT	1.000	PC																		
CN1003A	6,3 Uf MOTOR CAPACITOR		KCN1003A	6,3 uF MOTOR CAPACITOR KIT	<table border="1"> <thead> <tr> <th>Code</th> <th>Description</th> <th>Qty</th> <th>UOM</th> </tr> </thead> <tbody> <tr> <td>CN1003A0</td> <td>6,3 Uf MOTOR CAPACITOR</td> <td>1.000</td> <td>PC</td> </tr> <tr> <td>VI1931A0</td> <td>M8x1.65 H4 CH13 ZINC PLATED NUT</td> <td>1.000</td> <td>PC</td> </tr> <tr> <td>VI1932A0</td> <td>D8 INDENTED ZINC PLATED WASHER</td> <td>1.000</td> <td>PC</td> </tr> </tbody> </table>	Code	Description	Qty	UOM	CN1003A0	6,3 Uf MOTOR CAPACITOR	1.000	PC	VI1931A0	M8x1.65 H4 CH13 ZINC PLATED NUT	1.000	PC	VI1932A0	D8 INDENTED ZINC PLATED WASHER	1.000	PC
Code	Description	Qty	UOM																		
CN1003A0	6,3 Uf MOTOR CAPACITOR	1.000	PC																		
VI1931A0	M8x1.65 H4 CH13 ZINC PLATED NUT	1.000	PC																		
VI1932A0	D8 INDENTED ZINC PLATED WASHER	1.000	PC																		
MR1004A	41A 450V 7 POLES TERMINAL		KMR1004A	7FTW 1+2+3/4+5+6 TERMINAL BLOCK KIT	<table border="1"> <thead> <tr> <th>Code</th> <th>Description</th> <th>Qty</th> <th>UOM</th> </tr> </thead> <tbody> <tr> <td>MR1004A1</td> <td>41A 450V 7 POLES TERMINAL</td> <td>1.000</td> <td>PC</td> </tr> </tbody> </table>	Code	Description	Qty	UOM	MR1004A1	41A 450V 7 POLES TERMINAL	1.000	PC								
Code	Description	Qty	UOM																		
MR1004A1	41A 450V 7 POLES TERMINAL	1.000	PC																		
VE1639A	TRANSFORMER 230-12Vac 60VA		KVE1639A	230-12Vac 60VA TRANSFORMER KIT	<table border="1"> <thead> <tr> <th>Code</th> <th>Description</th> <th>Qty</th> <th>UOM</th> </tr> </thead> <tbody> <tr> <td>VE1639A0</td> <td>TRANSFORMER 230-12Vac 60VA</td> <td>1.000</td> <td>PC</td> </tr> <tr> <td>VI1950A0</td> <td>ST. STEEL 4,2X13 TCB SELF-DRILLING SCREW</td> <td>4.000</td> <td>PC</td> </tr> </tbody> </table>	Code	Description	Qty	UOM	VE1639A0	TRANSFORMER 230-12Vac 60VA	1.000	PC	VI1950A0	ST. STEEL 4,2X13 TCB SELF-DRILLING SCREW	4.000	PC				
Code	Description	Qty	UOM																		
VE1639A0	TRANSFORMER 230-12Vac 60VA	1.000	PC																		
VI1950A0	ST. STEEL 4,2X13 TCB SELF-DRILLING SCREW	4.000	PC																		

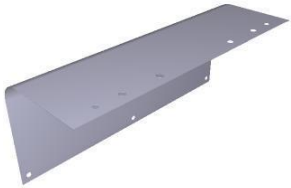

COMPONENT			SPARE PART		
<i>Code</i>	<i>Description</i>	<i>Image</i>	<i>Code</i>	<i>Description</i>	<i>Kit components</i>
VM2387A	MM REMOTE CONTROL SWITCH PROTECTION		VM2387A0	MM REMOTE CONTROL SWITCH PROTECTION	