







Código del conjunto	Descripción del conjunto	Imagen del conjunto
ASM4040A/0.D00	Cámara de cocción	
ASM4043A/0.D00	Cobertura exterior	
ASM1854A/0.D01	Conjunto genérico	
ASM2921A/0.D01	Puerta	

ASM4040A/0.D00 - Cámara de cocción

ANVERSO

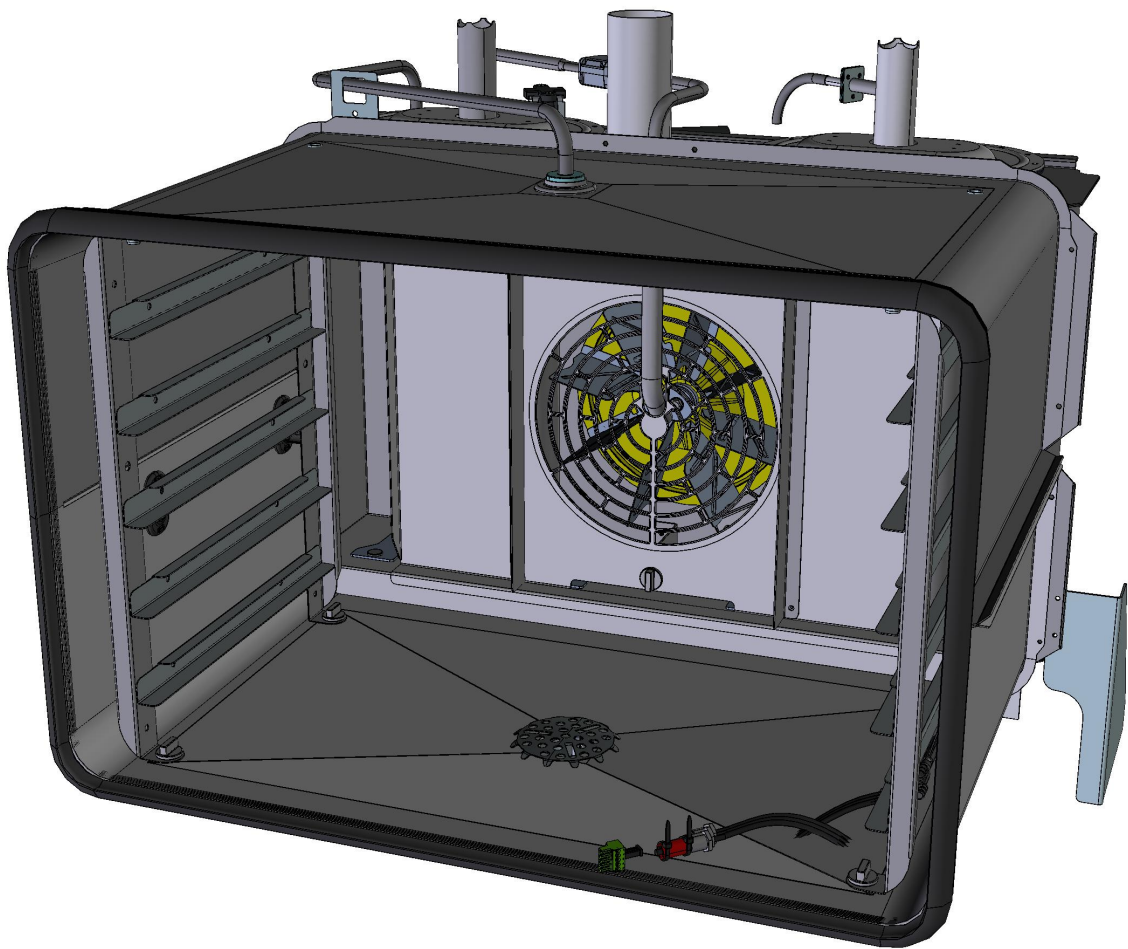

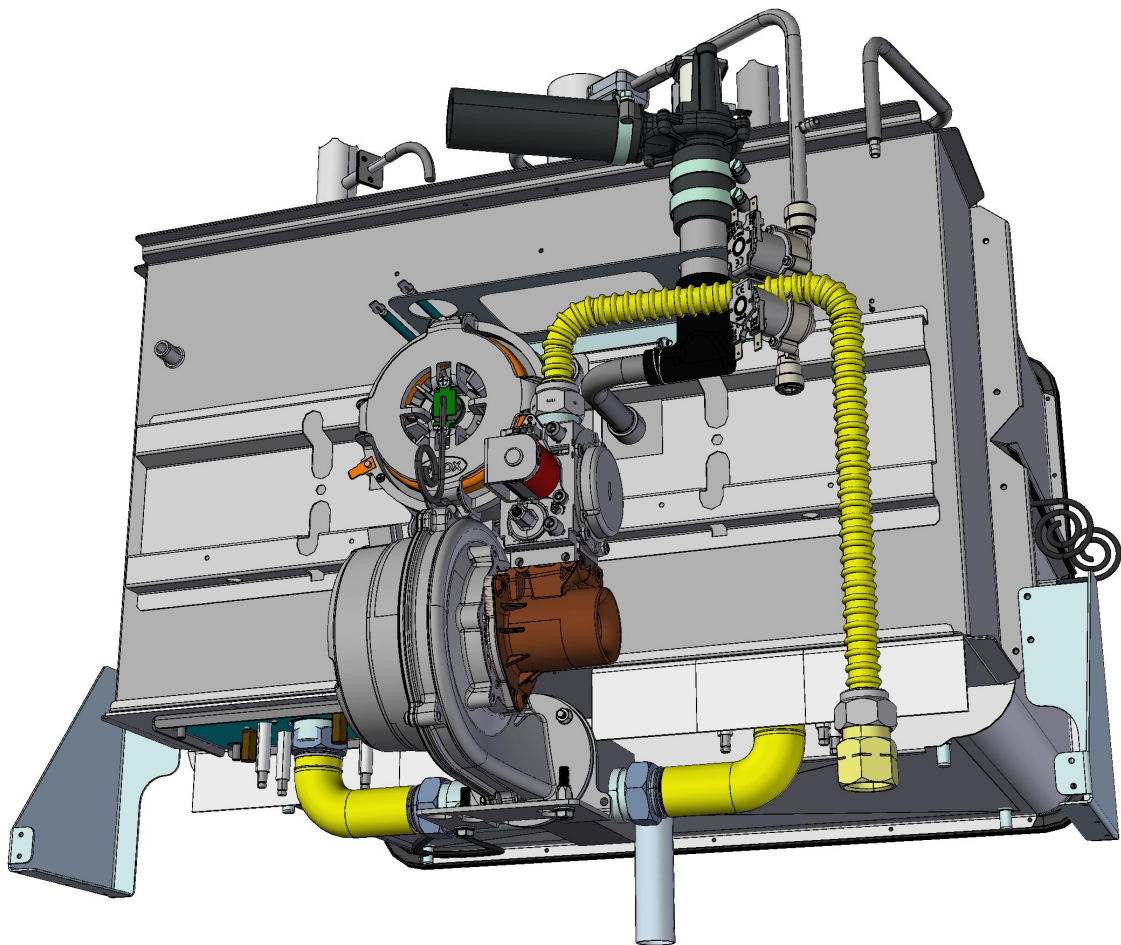
ASM4040A/0.D00 - Cámara de cocción**REVERSO**

COMPONENTE			REPUESTO																														
Código	Descripción	Imagen	Código	Descripción	Lista de componentes																												
RC1170A	TUERCA M=14 H=8 CH=22 INOX		KRC1170A	KIT 10 TUERCAS M14 H8 CH22	<table border="1"> <thead> <tr> <th>Código</th> <th>Descripción</th> <th>Cant.</th> <th>UdM</th> </tr> </thead> <tbody> <tr> <td>RC1170A1</td> <td>TUERCA M=14 H=8 CH=22 INOX</td> <td>10</td> <td>PZ</td> </tr> </tbody> </table>	Código	Descripción	Cant.	UdM	RC1170A1	TUERCA M=14 H=8 CH=22 INOX	10	PZ																				
Código	Descripción	Cant.	UdM																														
RC1170A1	TUERCA M=14 H=8 CH=22 INOX	10	PZ																														
MT1012A	MOTOR 330W 230V		KMT1012A	KIT MOTOR MIND.MAPS 330W 230V	<table border="1"> <thead> <tr> <th>Código</th> <th>Descripción</th> <th>Cant.</th> <th>UdM</th> </tr> </thead> <tbody> <tr> <td>GN1140A2</td> <td>GOMA SUJETA MOTOR</td> <td>1</td> <td>PZ</td> </tr> <tr> <td>MT1012A0</td> <td>MOTOR 330W 230V</td> <td>1</td> <td>PZ</td> </tr> <tr> <td>VI1077A1</td> <td></td> <td>1</td> <td>PZ</td> </tr> <tr> <td>VI1521A0</td> <td></td> <td>1</td> <td>PZ</td> </tr> <tr> <td>VM1794A0</td> <td>ABRAZADERA NEGRA 250X4.8 PA66</td> <td>4</td> <td>PZ</td> </tr> <tr> <td>VM2103A0</td> <td>PLAQUETA FIJA ABRAZADERA</td> <td>4</td> <td>PZ</td> </tr> </tbody> </table>	Código	Descripción	Cant.	UdM	GN1140A2	GOMA SUJETA MOTOR	1	PZ	MT1012A0	MOTOR 330W 230V	1	PZ	VI1077A1		1	PZ	VI1521A0		1	PZ	VM1794A0	ABRAZADERA NEGRA 250X4.8 PA66	4	PZ	VM2103A0	PLAQUETA FIJA ABRAZADERA	4	PZ
Código	Descripción	Cant.	UdM																														
GN1140A2	GOMA SUJETA MOTOR	1	PZ																														
MT1012A0	MOTOR 330W 230V	1	PZ																														
VI1077A1		1	PZ																														
VI1521A0		1	PZ																														
VM1794A0	ABRAZADERA NEGRA 250X4.8 PA66	4	PZ																														
VM2103A0	PLAQUETA FIJA ABRAZADERA	4	PZ																														
OH7170A			OH7170A0																														
GN1140A	GOMA SUJETA MOTOR		KG1140A	KIT 5 UDS GOMA PORTAMOTOR	<table border="1"> <thead> <tr> <th>Código</th> <th>Descripción</th> <th>Cant.</th> <th>UdM</th> </tr> </thead> <tbody> <tr> <td>GN1140A2</td> <td>GOMA SUJETA MOTOR</td> <td>5</td> <td>PZ</td> </tr> </tbody> </table>	Código	Descripción	Cant.	UdM	GN1140A2	GOMA SUJETA MOTOR	5	PZ																				
Código	Descripción	Cant.	UdM																														
GN1140A2	GOMA SUJETA MOTOR	5	PZ																														
OH4305A			KOH4305A	KIT DISCO SELLADO PARA EJE MOTOR	<table border="1"> <thead> <tr> <th>Código</th> <th>Descripción</th> <th>Cant.</th> <th>UdM</th> </tr> </thead> <tbody> <tr> <td>OH4305A1</td> <td></td> <td>1</td> <td>PZ</td> </tr> <tr> <td>GN1140A2</td> <td>GOMA SUJETA MOTOR</td> <td>1</td> <td>PZ</td> </tr> <tr> <td>SL1045A0</td> <td>SILICONA ANTRACITA S53 SP-5007 80ML</td> <td>1</td> <td>PZ</td> </tr> <tr> <td>VI1220A1</td> <td>VITE AUTOFIL. 4.2X12 TCB MARUTEX</td> <td>3</td> <td>PZ</td> </tr> </tbody> </table>	Código	Descripción	Cant.	UdM	OH4305A1		1	PZ	GN1140A2	GOMA SUJETA MOTOR	1	PZ	SL1045A0	SILICONA ANTRACITA S53 SP-5007 80ML	1	PZ	VI1220A1	VITE AUTOFIL. 4.2X12 TCB MARUTEX	3	PZ								
Código	Descripción	Cant.	UdM																														
OH4305A1		1	PZ																														
GN1140A2	GOMA SUJETA MOTOR	1	PZ																														
SL1045A0	SILICONA ANTRACITA S53 SP-5007 80ML	1	PZ																														
VI1220A1	VITE AUTOFIL. 4.2X12 TCB MARUTEX	3	PZ																														

COMPONENTE			REPUESTO																										
Código	Descripción	Imagen	Código	Descripción	Lista de componentes																								
VN1170A			KVN1170A	KIT TURBINA D195 H80 8 ASPAS TORNILLO M8	<table border="1"> <thead> <tr> <th>Código</th> <th>Descripción</th> <th>Cant.</th> <th>UdM</th> </tr> </thead> <tbody> <tr> <td>VI1077A1</td> <td></td> <td>1</td> <td>PZ</td> </tr> <tr> <td>VI1521A0</td> <td></td> <td>1</td> <td>PZ</td> </tr> <tr> <td>VN1170A2</td> <td></td> <td>1</td> <td>PZ</td> </tr> </tbody> </table>	Código	Descripción	Cant.	UdM	VI1077A1		1	PZ	VI1521A0		1	PZ	VN1170A2		1	PZ								
Código	Descripción	Cant.	UdM																										
VI1077A1		1	PZ																										
VI1521A0		1	PZ																										
VN1170A2		1	PZ																										
PE1710B	SENSOR NUMERO GIROS DE MOTOR		KPE1710B	KIT SENSOR NUMERO GIROS DE MOTOR MM	<table border="1"> <thead> <tr> <th>Código</th> <th>Descripción</th> <th>Cant.</th> <th>UdM</th> </tr> </thead> <tbody> <tr> <td>PE1710B0</td> <td>SENSOR NUMERO GIROS DE MOTOR</td> <td>1</td> <td>PZ</td> </tr> <tr> <td>VE1550A0</td> <td>IMAN NEODIMIO 5X3 MM</td> <td>1</td> <td>PZ</td> </tr> <tr> <td>VI1966A0</td> <td></td> <td>1</td> <td>PZ</td> </tr> <tr> <td>VM1635A0</td> <td>DISCO SOPORTE IMA</td> <td>1</td> <td>PZ</td> </tr> </tbody> </table>	Código	Descripción	Cant.	UdM	PE1710B0	SENSOR NUMERO GIROS DE MOTOR	1	PZ	VE1550A0	IMAN NEODIMIO 5X3 MM	1	PZ	VI1966A0		1	PZ	VM1635A0	DISCO SOPORTE IMA	1	PZ				
Código	Descripción	Cant.	UdM																										
PE1710B0	SENSOR NUMERO GIROS DE MOTOR	1	PZ																										
VE1550A0	IMAN NEODIMIO 5X3 MM	1	PZ																										
VI1966A0		1	PZ																										
VM1635A0	DISCO SOPORTE IMA	1	PZ																										
VE1550A	IMAN NEODIMIO 5X3 MM		VE1550A0	IMAN NEODIMIO 5X3 MM																									
RS1215A	RESISTENCIA PLANA 147W 105V D230 1ESPIRA		KRS1215A	KIT RESISTENCIA PARADA 147W 105V RS1215	<table border="1"> <thead> <tr> <th>Código</th> <th>Descripción</th> <th>Cant.</th> <th>UdM</th> </tr> </thead> <tbody> <tr> <td>GN1326A1</td> <td>GOMA RESISTENCIA 71X19 G6.25</td> <td>1</td> <td>PZ</td> </tr> <tr> <td>RS1215A1</td> <td>RESISTENCIA PLANA 147W 105V D230 1ESPIRA</td> <td>1</td> <td>PZ</td> </tr> <tr> <td>SL1045A0</td> <td>SILICONA ANTRACITA S53 SP-5007 80ML</td> <td>1</td> <td>PZ</td> </tr> <tr> <td>VI1220A1</td> <td>VITE AUTOFIL. 4.2X12 TCB MARUTEX</td> <td>2</td> <td>PZ</td> </tr> <tr> <td>VM2147A0</td> <td></td> <td>1</td> <td>PZ</td> </tr> </tbody> </table>	Código	Descripción	Cant.	UdM	GN1326A1	GOMA RESISTENCIA 71X19 G6.25	1	PZ	RS1215A1	RESISTENCIA PLANA 147W 105V D230 1ESPIRA	1	PZ	SL1045A0	SILICONA ANTRACITA S53 SP-5007 80ML	1	PZ	VI1220A1	VITE AUTOFIL. 4.2X12 TCB MARUTEX	2	PZ	VM2147A0		1	PZ
Código	Descripción	Cant.	UdM																										
GN1326A1	GOMA RESISTENCIA 71X19 G6.25	1	PZ																										
RS1215A1	RESISTENCIA PLANA 147W 105V D230 1ESPIRA	1	PZ																										
SL1045A0	SILICONA ANTRACITA S53 SP-5007 80ML	1	PZ																										
VI1220A1	VITE AUTOFIL. 4.2X12 TCB MARUTEX	2	PZ																										
VM2147A0		1	PZ																										

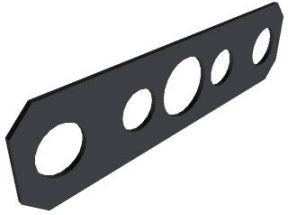

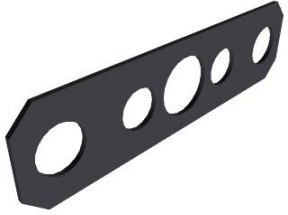
COMPONENTE			REPUESTO																												
Código	Descripción	Imagen	Código	Descripción	Lista de componentes																										
GN1326A	GOMA RESISTENCIA 71X19 G6.25		KRS1261A	KIT RESISTENCIA PARADA BL CL	<table border="1"> <thead> <tr> <th>Código</th> <th>Descripción</th> <th>Cant.</th> <th>UdM</th> </tr> </thead> <tbody> <tr> <td>GN1326A1</td> <td>GOMA RESISTENCIA 71X19 G6.25</td> <td>1</td> <td>PZ</td> </tr> <tr> <td>RS1261A0</td> <td>RESISTENCIA MOTOR BAKERLUX\CH EFLUX</td> <td>1</td> <td>PZ</td> </tr> <tr> <td>SL1045A0</td> <td>SILICONA ANTRACITA S53 SP-5007 80ML</td> <td>1</td> <td>PZ</td> </tr> <tr> <td>VI1220A1</td> <td>VITE AUTOFIL. 4.2X12 TCB MARUTEX</td> <td>2</td> <td>PZ</td> </tr> <tr> <td>VM2147A0</td> <td></td> <td>1</td> <td>PZ</td> </tr> </tbody> </table>	Código	Descripción	Cant.	UdM	GN1326A1	GOMA RESISTENCIA 71X19 G6.25	1	PZ	RS1261A0	RESISTENCIA MOTOR BAKERLUX\CH EFLUX	1	PZ	SL1045A0	SILICONA ANTRACITA S53 SP-5007 80ML	1	PZ	VI1220A1	VITE AUTOFIL. 4.2X12 TCB MARUTEX	2	PZ	VM2147A0		1	PZ		
			Código	Descripción	Cant.	UdM																									
			GN1326A1	GOMA RESISTENCIA 71X19 G6.25	1	PZ																									
			RS1261A0	RESISTENCIA MOTOR BAKERLUX\CH EFLUX	1	PZ																									
SL1045A0	SILICONA ANTRACITA S53 SP-5007 80ML	1	PZ																												
VI1220A1	VITE AUTOFIL. 4.2X12 TCB MARUTEX	2	PZ																												
VM2147A0		1	PZ																												
KRS1215A	KIT RESISTENCIA PARADA 147W 105V RS1215	<table border="1"> <thead> <tr> <th>Código</th> <th>Descripción</th> <th>Cant.</th> <th>UdM</th> </tr> </thead> <tbody> <tr> <td>GN1326A1</td> <td>GOMA RESISTENCIA 71X19 G6.25</td> <td>1</td> <td>PZ</td> </tr> <tr> <td>RS1215A1</td> <td>RESISTENCIA PLANA 147W 105V D230 1ESPIRA</td> <td>1</td> <td>PZ</td> </tr> <tr> <td>SL1045A0</td> <td>SILICONA ANTRACITA S53 SP-5007 80ML</td> <td>1</td> <td>PZ</td> </tr> <tr> <td>VI1220A1</td> <td>VITE AUTOFIL. 4.2X12 TCB MARUTEX</td> <td>2</td> <td>PZ</td> </tr> <tr> <td>VM2147A0</td> <td></td> <td>1</td> <td>PZ</td> </tr> </tbody> </table>	Código	Descripción	Cant.	UdM	GN1326A1	GOMA RESISTENCIA 71X19 G6.25	1	PZ	RS1215A1	RESISTENCIA PLANA 147W 105V D230 1ESPIRA	1	PZ	SL1045A0	SILICONA ANTRACITA S53 SP-5007 80ML	1	PZ	VI1220A1	VITE AUTOFIL. 4.2X12 TCB MARUTEX	2	PZ	VM2147A0		1	PZ					
Código	Descripción	Cant.	UdM																												
GN1326A1	GOMA RESISTENCIA 71X19 G6.25	1	PZ																												
RS1215A1	RESISTENCIA PLANA 147W 105V D230 1ESPIRA	1	PZ																												
SL1045A0	SILICONA ANTRACITA S53 SP-5007 80ML	1	PZ																												
VI1220A1	VITE AUTOFIL. 4.2X12 TCB MARUTEX	2	PZ																												
VM2147A0		1	PZ																												
KRS1095A	KIT RESISTENCIA 1.2KW RS1095A	<table border="1"> <thead> <tr> <th>Código</th> <th>Descripción</th> <th>Cant.</th> <th>UdM</th> </tr> </thead> <tbody> <tr> <td>GN1326A1</td> <td>GOMA RESISTENCIA 71X19 G6.25</td> <td>1</td> <td>PZ</td> </tr> <tr> <td>IP1385A0</td> <td></td> <td>1.200</td> <td>PZ</td> </tr> <tr> <td>RS1095A1</td> <td></td> <td>1</td> <td>PZ</td> </tr> <tr> <td>SL1045A0</td> <td>SILICONA ANTRACITA S53 SP-5007 80ML</td> <td>1</td> <td>PZ</td> </tr> <tr> <td>VI1220A1</td> <td>VITE AUTOFIL. 4.2X12 TCB MARUTEX</td> <td>2</td> <td>PZ</td> </tr> <tr> <td>VM1059A1</td> <td></td> <td>1.200</td> <td>M</td> </tr> </tbody> </table>	Código	Descripción	Cant.	UdM	GN1326A1	GOMA RESISTENCIA 71X19 G6.25	1	PZ	IP1385A0		1.200	PZ	RS1095A1		1	PZ	SL1045A0	SILICONA ANTRACITA S53 SP-5007 80ML	1	PZ	VI1220A1	VITE AUTOFIL. 4.2X12 TCB MARUTEX	2	PZ	VM1059A1		1.200	M	
Código	Descripción	Cant.	UdM																												
GN1326A1	GOMA RESISTENCIA 71X19 G6.25	1	PZ																												
IP1385A0		1.200	PZ																												
RS1095A1		1	PZ																												
SL1045A0	SILICONA ANTRACITA S53 SP-5007 80ML	1	PZ																												
VI1220A1	VITE AUTOFIL. 4.2X12 TCB MARUTEX	2	PZ																												
VM1059A1		1.200	M																												
KRS1012A	KIT RESISTENCIA 1365W 120V RS1012A0	<table border="1"> <thead> <tr> <th>Código</th> <th>Descripción</th> <th>Cant.</th> <th>UdM</th> </tr> </thead> <tbody> <tr> <td>GN1326A1</td> <td>GOMA RESISTENCIA 71X19 G6.25</td> <td>1</td> <td>PZ</td> </tr> <tr> <td>RS1012A0</td> <td></td> <td>1</td> <td>PZ</td> </tr> </tbody> </table>	Código	Descripción	Cant.	UdM	GN1326A1	GOMA RESISTENCIA 71X19 G6.25	1	PZ	RS1012A0		1	PZ																	
Código	Descripción	Cant.	UdM																												
GN1326A1	GOMA RESISTENCIA 71X19 G6.25	1	PZ																												
RS1012A0		1	PZ																												

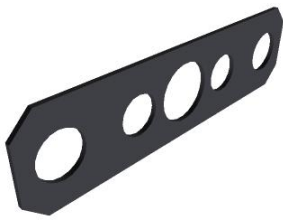
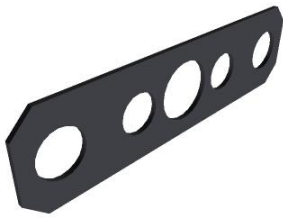
COMPONENTE			REPUESTO							
Código	Descripción	Imagen	Código	Descripción	Lista de componentes					
GN1326A	GOMA RESISTENCIA 71X19 G6.25		KRS1012A	KIT RESISTENCIA 1365W 120V RS1012A0	Código	Descripción	Cant.	UdM		
					VI1220A1	VITE AUTOFIL. 4.2X12 TCB MARUTEX	5	PZ		
					VM1794A0	ABRAZADERA NEGRA 250X4.8 PA66	2	PZ		
					VM2103A0	PLAQUETA FIJA ABRAZADERA	2	PZ		
							Código	Descripción	Cant.	UdM
					KRS1011A	KIT RESISTENCIA XF003/010/013	GN1326A1	GOMA RESISTENCIA 71X19 G6.25	1	PZ
							RS1011A0	RESISTENCIA CIRCULAR 2560W 220-230	1	PZ
							SL1045A0	SILICONA ANTRACITA S53 SP-5007 80ML	1	PZ
							VI1220A1	VITE AUTOFIL. 4.2X12 TCB MARUTEX	5	PZ
							VM1794A0	ABRAZADERA NEGRA 250X4.8 PA66	2	PZ
							VM2103A0	PLAQUETA FIJA ABRAZADERA	2	PZ
									Código	Descripción
		KRS0090A	KIT RESISTENCIA 1.26KW RS0090A	GN1326A1	GOMA RESISTENCIA 71X19 G6.25	1	PZ			
				RS0090A0		1	PZ			
				VI1220A1	VITE AUTOFIL. 4.2X12 TCB MARUTEX	3	PZ			
				VM1794A0	ABRAZADERA NEGRA 250X4.8 PA66	2	PZ			
				VM2103A0	PLAQUETA FIJA ABRAZADERA	2	PZ			
						Código	Descripción	Cant.	UdM	
		KRS0050A	KIT RESISTENCIA 0.5KW RS0050A	GN1326A1	GOMA RESISTENCIA 71X19 G6.25	1	PZ			
				IP1075A1		1	PZ			
				IP1080A1		1	PZ			
				RS0050A0		1	PZ			
				VI1220A1	VITE AUTOFIL. 4.2X12 TCB MARUTEX	2	PZ			

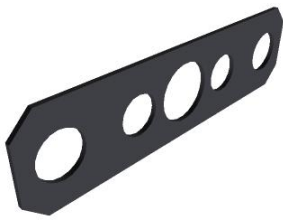

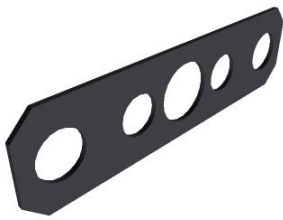

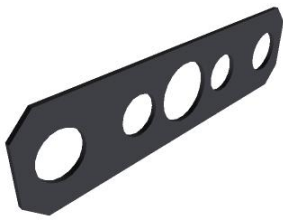
COMPONENTE			REPUESTO																										
Código	Descripción	Imagen	Código	Descripción	Lista de componentes																								
GN1326A	GOMA RESISTENCIA 71X19 G6.25		KRS0011A		<table border="1"> <thead> <tr> <th>Código</th> <th>Descripción</th> <th>Cant.</th> <th>UdM</th> </tr> </thead> <tbody> <tr> <td>GN1326A1</td> <td>GOMA RESISTENCIA 71X19 G6.25</td> <td>1</td> <td>PZ</td> </tr> <tr> <td>RS0011A0</td> <td></td> <td>1</td> <td>PZ</td> </tr> <tr> <td>VI1220A1</td> <td>VITE AUTOFIL. 4.2X12 TCB MARUTEX</td> <td>3</td> <td>PZ</td> </tr> <tr> <td>VM1794A0</td> <td>ABRAZADERA NEGRA 250X4.8 PA66</td> <td>2</td> <td>PZ</td> </tr> <tr> <td>VM2103A0</td> <td>PLAQUETA FIJA ABRAZADERA</td> <td>2</td> <td>PZ</td> </tr> </tbody> </table>	Código	Descripción	Cant.	UdM	GN1326A1	GOMA RESISTENCIA 71X19 G6.25	1	PZ	RS0011A0		1	PZ	VI1220A1	VITE AUTOFIL. 4.2X12 TCB MARUTEX	3	PZ	VM1794A0	ABRAZADERA NEGRA 250X4.8 PA66	2	PZ	VM2103A0	PLAQUETA FIJA ABRAZADERA	2	PZ
			Código	Descripción	Cant.	UdM																							
			GN1326A1	GOMA RESISTENCIA 71X19 G6.25	1	PZ																							
RS0011A0		1	PZ																										
VI1220A1	VITE AUTOFIL. 4.2X12 TCB MARUTEX	3	PZ																										
VM1794A0	ABRAZADERA NEGRA 250X4.8 PA66	2	PZ																										
VM2103A0	PLAQUETA FIJA ABRAZADERA	2	PZ																										
KRS0010A		<table border="1"> <thead> <tr> <th>Código</th> <th>Descripción</th> <th>Cant.</th> <th>UdM</th> </tr> </thead> <tbody> <tr> <td>GN1326A1</td> <td>GOMA RESISTENCIA 71X19 G6.25</td> <td>1</td> <td>PZ</td> </tr> <tr> <td>IP1075A1</td> <td></td> <td>1</td> <td>PZ</td> </tr> <tr> <td>IP1080A1</td> <td></td> <td>5</td> <td>PZ</td> </tr> <tr> <td>RS0010A0</td> <td></td> <td>1</td> <td>PZ</td> </tr> <tr> <td>VI1220A1</td> <td>VITE AUTOFIL. 4.2X12 TCB MARUTEX</td> <td>3</td> <td>PZ</td> </tr> </tbody> </table>	Código	Descripción	Cant.	UdM	GN1326A1	GOMA RESISTENCIA 71X19 G6.25	1	PZ	IP1075A1		1	PZ	IP1080A1		5	PZ	RS0010A0		1	PZ	VI1220A1	VITE AUTOFIL. 4.2X12 TCB MARUTEX	3	PZ			
Código	Descripción	Cant.	UdM																										
GN1326A1	GOMA RESISTENCIA 71X19 G6.25	1	PZ																										
IP1075A1		1	PZ																										
IP1080A1		5	PZ																										
RS0010A0		1	PZ																										
VI1220A1	VITE AUTOFIL. 4.2X12 TCB MARUTEX	3	PZ																										
KGN1326A		<table border="1"> <thead> <tr> <th>Código</th> <th>Descripción</th> <th>Cant.</th> <th>UdM</th> </tr> </thead> <tbody> <tr> <td>GN1326A1</td> <td>GOMA RESISTENCIA 71X19 G6.25</td> <td>5</td> <td>PZ</td> </tr> </tbody> </table>	Código	Descripción	Cant.	UdM	GN1326A1	GOMA RESISTENCIA 71X19 G6.25	5	PZ																			
Código	Descripción	Cant.	UdM																										
GN1326A1	GOMA RESISTENCIA 71X19 G6.25	5	PZ																										
GN1326A	GOMA RESISTENCIA 71X19 G6.25		KRS1261A	KIT RESISTENCIA PARADA BL CL	<table border="1"> <thead> <tr> <th>Código</th> <th>Descripción</th> <th>Cant.</th> <th>UdM</th> </tr> </thead> <tbody> <tr> <td>GN1326A1</td> <td>GOMA RESISTENCIA 71X19 G6.25</td> <td>1</td> <td>PZ</td> </tr> <tr> <td>RS1261A0</td> <td>RESISTENCIA MOTOR BAKERLUX\CH EFLUX</td> <td>1</td> <td>PZ</td> </tr> <tr> <td>SL1045A0</td> <td>SILICONA ANTRACITA S53 SP-5007 80ML</td> <td>1</td> <td>PZ</td> </tr> <tr> <td>VI1220A1</td> <td>VITE AUTOFIL. 4.2X12 TCB MARUTEX</td> <td>2</td> <td>PZ</td> </tr> <tr> <td>VM2147A0</td> <td></td> <td>1</td> <td>PZ</td> </tr> </tbody> </table>	Código	Descripción	Cant.	UdM	GN1326A1	GOMA RESISTENCIA 71X19 G6.25	1	PZ	RS1261A0	RESISTENCIA MOTOR BAKERLUX\CH EFLUX	1	PZ	SL1045A0	SILICONA ANTRACITA S53 SP-5007 80ML	1	PZ	VI1220A1	VITE AUTOFIL. 4.2X12 TCB MARUTEX	2	PZ	VM2147A0		1	PZ
			Código	Descripción	Cant.	UdM																							
GN1326A1	GOMA RESISTENCIA 71X19 G6.25	1	PZ																										
RS1261A0	RESISTENCIA MOTOR BAKERLUX\CH EFLUX	1	PZ																										
SL1045A0	SILICONA ANTRACITA S53 SP-5007 80ML	1	PZ																										
VI1220A1	VITE AUTOFIL. 4.2X12 TCB MARUTEX	2	PZ																										
VM2147A0		1	PZ																										
KRS1215A	KIT RESISTENCIA PARADA 147W 105V RS1215	<table border="1"> <thead> <tr> <th>Código</th> <th>Descripción</th> <th>Cant.</th> <th>UdM</th> </tr> </thead> <tbody> <tr> <td>GN1326A1</td> <td>GOMA RESISTENCIA 71X19 G6.25</td> <td>1</td> <td>PZ</td> </tr> </tbody> </table>	Código	Descripción	Cant.	UdM	GN1326A1	GOMA RESISTENCIA 71X19 G6.25	1	PZ																			
Código	Descripción	Cant.	UdM																										
GN1326A1	GOMA RESISTENCIA 71X19 G6.25	1	PZ																										





COMPONENTE			REPUESTO					
Código	Descripción	Imagen	Código	Descripción	Lista de componentes			
GN1326A	GOMA RESISTENCIA 71X19 G6.25		KRS1215A	KIT RESISTENCIA PARADA 147W 105V RS1215	Código	Descripción	Cant.	UdM
			RS1215A1	RESISTENCIA PLANA 147W 105V D230 1ESPIRA	1	PZ		
			SL1045A0	SILICONA ANTRACITA S53 SP-5007 80ML	1	PZ		
			VI1220A1	VITE AUTOFIL. 4.2X12 TCB MARUTEX	2	PZ		
			VM2147A0		1	PZ		
			KRS1095A	KIT RESISTENCIA 1.2KW RS1095A	Código	Descripción	Cant.	UdM
			GN1326A1	GOMA RESISTENCIA 71X19 G6.25	1	PZ		
			IP1385A0		1.200	PZ		
			RS1095A1		1	PZ		
			SL1045A0	SILICONA ANTRACITA S53 SP-5007 80ML	1	PZ		
			VI1220A1	VITE AUTOFIL. 4.2X12 TCB MARUTEX	2	PZ		
			VM1059A1		1.200	M		
KRS1012A	KIT RESISTENCIA 1365W 120V RS1012A0	Código	Descripción	Cant.	UdM			
GN1326A1	GOMA RESISTENCIA 71X19 G6.25	1	PZ					
RS1012A0		1	PZ					
VI1220A1	VITE AUTOFIL. 4.2X12 TCB MARUTEX	5	PZ					
VM1794A0	ABRAZADERA NEGRA 250X4.8 PA66	2	PZ					
VM2103A0	PLAQUETA FIJA ABRAZADERA	2	PZ					
KRS1011A	KIT RESISTENCIA XF003/010/013	Código	Descripción	Cant.	UdM			
GN1326A1	GOMA RESISTENCIA 71X19 G6.25	1	PZ					
RS1011A0	RESISTENCIA CIRCULAR 2560W 220-230	1	PZ					
SL1045A0	SILICONA ANTRACITA S53 SP-5007 80ML	1	PZ					



COMPONENTE			REPUESTO																							
Código	Descripción	Imagen	Código	Descripción	Lista de componentes																					
GN1326A	GOMA RESISTENCIA 71X19 G6.25		KRS1011A	KIT RESISTENCIA XF003/010/013	<table border="1"> <thead> <tr> <th>Código</th> <th>Descripción</th> <th>Cant.</th> <th>UdM</th> </tr> </thead> <tbody> <tr> <td>VI1220A1</td> <td>VITE AUTOFIL. 4.2X12 TCB MARUTEX</td> <td>5</td> <td>PZ</td> </tr> <tr> <td>VM1794A0</td> <td>ABRAZADERA NEGRA 250X4.8 PA66</td> <td>2</td> <td>PZ</td> </tr> <tr> <td>VM2103A0</td> <td>PLAQUETA FIJA ABRAZADERA</td> <td>2</td> <td>PZ</td> </tr> </tbody> </table>	Código	Descripción	Cant.	UdM	VI1220A1	VITE AUTOFIL. 4.2X12 TCB MARUTEX	5	PZ	VM1794A0	ABRAZADERA NEGRA 250X4.8 PA66	2	PZ	VM2103A0	PLAQUETA FIJA ABRAZADERA	2	PZ					
			Código	Descripción	Cant.	UdM																				
			VI1220A1	VITE AUTOFIL. 4.2X12 TCB MARUTEX	5	PZ																				
			VM1794A0	ABRAZADERA NEGRA 250X4.8 PA66	2	PZ																				
VM2103A0	PLAQUETA FIJA ABRAZADERA	2	PZ																							
KRS0090A	KIT RESISTENCIA 1.26KW RS0090A	<table border="1"> <thead> <tr> <th>Código</th> <th>Descripción</th> <th>Cant.</th> <th>UdM</th> </tr> </thead> <tbody> <tr> <td>GN1326A1</td> <td>GOMA RESISTENCIA 71X19 G6.25</td> <td>1</td> <td>PZ</td> </tr> <tr> <td>RS0090A0</td> <td></td> <td>1</td> <td>PZ</td> </tr> <tr> <td>VI1220A1</td> <td>VITE AUTOFIL. 4.2X12 TCB MARUTEX</td> <td>3</td> <td>PZ</td> </tr> <tr> <td>VM1794A0</td> <td>ABRAZADERA NEGRA 250X4.8 PA66</td> <td>2</td> <td>PZ</td> </tr> <tr> <td>VM2103A0</td> <td>PLAQUETA FIJA ABRAZADERA</td> <td>2</td> <td>PZ</td> </tr> </tbody> </table>	Código	Descripción	Cant.	UdM	GN1326A1	GOMA RESISTENCIA 71X19 G6.25	1	PZ	RS0090A0		1	PZ	VI1220A1	VITE AUTOFIL. 4.2X12 TCB MARUTEX	3	PZ	VM1794A0	ABRAZADERA NEGRA 250X4.8 PA66	2	PZ	VM2103A0	PLAQUETA FIJA ABRAZADERA	2	PZ
Código	Descripción	Cant.	UdM																							
GN1326A1	GOMA RESISTENCIA 71X19 G6.25	1	PZ																							
RS0090A0		1	PZ																							
VI1220A1	VITE AUTOFIL. 4.2X12 TCB MARUTEX	3	PZ																							
VM1794A0	ABRAZADERA NEGRA 250X4.8 PA66	2	PZ																							
VM2103A0	PLAQUETA FIJA ABRAZADERA	2	PZ																							
KRS0050A	KIT RESISTENCIA 0.5KW RS0050A	<table border="1"> <thead> <tr> <th>Código</th> <th>Descripción</th> <th>Cant.</th> <th>UdM</th> </tr> </thead> <tbody> <tr> <td>GN1326A1</td> <td>GOMA RESISTENCIA 71X19 G6.25</td> <td>1</td> <td>PZ</td> </tr> <tr> <td>IP1075A1</td> <td></td> <td>1</td> <td>PZ</td> </tr> <tr> <td>IP1080A1</td> <td></td> <td>1</td> <td>PZ</td> </tr> <tr> <td>RS0050A0</td> <td></td> <td>1</td> <td>PZ</td> </tr> <tr> <td>VI1220A1</td> <td>VITE AUTOFIL. 4.2X12 TCB MARUTEX</td> <td>2</td> <td>PZ</td> </tr> </tbody> </table>	Código	Descripción	Cant.	UdM	GN1326A1	GOMA RESISTENCIA 71X19 G6.25	1	PZ	IP1075A1		1	PZ	IP1080A1		1	PZ	RS0050A0		1	PZ	VI1220A1	VITE AUTOFIL. 4.2X12 TCB MARUTEX	2	PZ
Código	Descripción	Cant.	UdM																							
GN1326A1	GOMA RESISTENCIA 71X19 G6.25	1	PZ																							
IP1075A1		1	PZ																							
IP1080A1		1	PZ																							
RS0050A0		1	PZ																							
VI1220A1	VITE AUTOFIL. 4.2X12 TCB MARUTEX	2	PZ																							
KRS0011A	KIT RESISTENCIA	<table border="1"> <thead> <tr> <th>Código</th> <th>Descripción</th> <th>Cant.</th> <th>UdM</th> </tr> </thead> <tbody> <tr> <td>GN1326A1</td> <td>GOMA RESISTENCIA 71X19 G6.25</td> <td>1</td> <td>PZ</td> </tr> <tr> <td>RS0011A0</td> <td></td> <td>1</td> <td>PZ</td> </tr> <tr> <td>VI1220A1</td> <td>VITE AUTOFIL. 4.2X12 TCB MARUTEX</td> <td>3</td> <td>PZ</td> </tr> <tr> <td>VM1794A0</td> <td>ABRAZADERA NEGRA 250X4.8 PA66</td> <td>2</td> <td>PZ</td> </tr> <tr> <td>VM2103A0</td> <td>PLAQUETA FIJA ABRAZADERA</td> <td>2</td> <td>PZ</td> </tr> </tbody> </table>	Código	Descripción	Cant.	UdM	GN1326A1	GOMA RESISTENCIA 71X19 G6.25	1	PZ	RS0011A0		1	PZ	VI1220A1	VITE AUTOFIL. 4.2X12 TCB MARUTEX	3	PZ	VM1794A0	ABRAZADERA NEGRA 250X4.8 PA66	2	PZ	VM2103A0	PLAQUETA FIJA ABRAZADERA	2	PZ
Código	Descripción	Cant.	UdM																							
GN1326A1	GOMA RESISTENCIA 71X19 G6.25	1	PZ																							
RS0011A0		1	PZ																							
VI1220A1	VITE AUTOFIL. 4.2X12 TCB MARUTEX	3	PZ																							
VM1794A0	ABRAZADERA NEGRA 250X4.8 PA66	2	PZ																							
VM2103A0	PLAQUETA FIJA ABRAZADERA	2	PZ																							

COMPONENTE			REPUESTO																										
Código	Descripción	Imagen	Código	Descripción	Lista de componentes																								
GN1326A	GOMA RESISTENCIA 71X19 G6.25		KRS0010A		<table border="1"> <thead> <tr> <th>Código</th> <th>Descripción</th> <th>Cant.</th> <th>UdM</th> </tr> </thead> <tbody> <tr> <td>GN1326A1</td> <td>GOMA RESISTENCIA 71X19 G6.25</td> <td>1</td> <td>PZ</td> </tr> <tr> <td>IP1075A1</td> <td></td> <td>1</td> <td>PZ</td> </tr> <tr> <td>IP1080A1</td> <td></td> <td>5</td> <td>PZ</td> </tr> <tr> <td>RS0010A0</td> <td></td> <td>1</td> <td>PZ</td> </tr> <tr> <td>VI1220A1</td> <td>VITE AUTOFIL. 4.2X12 TCB MARUTEX</td> <td>3</td> <td>PZ</td> </tr> </tbody> </table>	Código	Descripción	Cant.	UdM	GN1326A1	GOMA RESISTENCIA 71X19 G6.25	1	PZ	IP1075A1		1	PZ	IP1080A1		5	PZ	RS0010A0		1	PZ	VI1220A1	VITE AUTOFIL. 4.2X12 TCB MARUTEX	3	PZ
			Código	Descripción	Cant.	UdM																							
GN1326A1	GOMA RESISTENCIA 71X19 G6.25	1	PZ																										
IP1075A1		1	PZ																										
IP1080A1		5	PZ																										
RS0010A0		1	PZ																										
VI1220A1	VITE AUTOFIL. 4.2X12 TCB MARUTEX	3	PZ																										
KGN1326A		<table border="1"> <thead> <tr> <th>Código</th> <th>Descripción</th> <th>Cant.</th> <th>UdM</th> </tr> </thead> <tbody> <tr> <td>GN1326A1</td> <td>GOMA RESISTENCIA 71X19 G6.25</td> <td>5</td> <td>PZ</td> </tr> </tbody> </table>	Código	Descripción	Cant.	UdM	GN1326A1	GOMA RESISTENCIA 71X19 G6.25	5	PZ																			
Código	Descripción	Cant.	UdM																										
GN1326A1	GOMA RESISTENCIA 71X19 G6.25	5	PZ																										
RS1274A			KRS1274A	KIT RESISTENCIA PARADA 100W 60V	<table border="1"> <thead> <tr> <th>Código</th> <th>Descripción</th> <th>Cant.</th> <th>UdM</th> </tr> </thead> <tbody> <tr> <td>GN1326A1</td> <td>GOMA RESISTENCIA 71X19 G6.25</td> <td>1</td> <td>PZ</td> </tr> <tr> <td>RS1274A0</td> <td></td> <td>1</td> <td>PZ</td> </tr> <tr> <td>SL1045A0</td> <td>SILICONA ANTRACITA S53 SP-5007 80ML</td> <td>1</td> <td>PZ</td> </tr> <tr> <td>VI1220A1</td> <td>VITE AUTOFIL. 4.2X12 TCB MARUTEX</td> <td>2</td> <td>PZ</td> </tr> </tbody> </table>	Código	Descripción	Cant.	UdM	GN1326A1	GOMA RESISTENCIA 71X19 G6.25	1	PZ	RS1274A0		1	PZ	SL1045A0	SILICONA ANTRACITA S53 SP-5007 80ML	1	PZ	VI1220A1	VITE AUTOFIL. 4.2X12 TCB MARUTEX	2	PZ				
Código	Descripción	Cant.	UdM																										
GN1326A1	GOMA RESISTENCIA 71X19 G6.25	1	PZ																										
RS1274A0		1	PZ																										
SL1045A0	SILICONA ANTRACITA S53 SP-5007 80ML	1	PZ																										
VI1220A1	VITE AUTOFIL. 4.2X12 TCB MARUTEX	2	PZ																										
GN1285A	GOMA SONDA TEMPERATURA NTC		KTR1106A	KIT SONDA TEMPERATURA L2000	<table border="1"> <thead> <tr> <th>Código</th> <th>Descripción</th> <th>Cant.</th> <th>UdM</th> </tr> </thead> <tbody> <tr> <td>GN1285A0</td> <td>GOMA SONDA TEMPERATUR A NTC</td> <td>1</td> <td>PZ</td> </tr> <tr> <td>SL1045A0</td> <td>SILICONA ANTRACITA S53 SP-5007 80ML</td> <td>1</td> <td>PZ</td> </tr> <tr> <td>TR1106A3</td> <td>SONDA TEMPERATUR A PT100 L2000</td> <td>1</td> <td>PZ</td> </tr> <tr> <td>VI1220A1</td> <td>VITE AUTOFIL. 4.2X12 TCB MARUTEX</td> <td>2</td> <td>PZ</td> </tr> <tr> <td>VM1465A0</td> <td>TAPA SONDA TEMPERATUR A CHEFTOP</td> <td>1</td> <td>PZ</td> </tr> </tbody> </table>	Código	Descripción	Cant.	UdM	GN1285A0	GOMA SONDA TEMPERATUR A NTC	1	PZ	SL1045A0	SILICONA ANTRACITA S53 SP-5007 80ML	1	PZ	TR1106A3	SONDA TEMPERATUR A PT100 L2000	1	PZ	VI1220A1	VITE AUTOFIL. 4.2X12 TCB MARUTEX	2	PZ	VM1465A0	TAPA SONDA TEMPERATUR A CHEFTOP	1	PZ
			Código	Descripción	Cant.	UdM																							
GN1285A0	GOMA SONDA TEMPERATUR A NTC	1	PZ																										
SL1045A0	SILICONA ANTRACITA S53 SP-5007 80ML	1	PZ																										
TR1106A3	SONDA TEMPERATUR A PT100 L2000	1	PZ																										
VI1220A1	VITE AUTOFIL. 4.2X12 TCB MARUTEX	2	PZ																										
VM1465A0	TAPA SONDA TEMPERATUR A CHEFTOP	1	PZ																										
KTR1105A	KIT SONDA TEMPERATURA L1000	<table border="1"> <thead> <tr> <th>Código</th> <th>Descripción</th> <th>Cant.</th> <th>UdM</th> </tr> </thead> <tbody> <tr> <td>GN1120A0</td> <td>GOMA SONDA TEMPERATUR</td> <td>1</td> <td>PZ</td> </tr> <tr> <td>GN1285A0</td> <td>GOMA SONDA TEMPERATUR A NTC</td> <td>1</td> <td>PZ</td> </tr> </tbody> </table>	Código	Descripción	Cant.	UdM	GN1120A0	GOMA SONDA TEMPERATUR	1	PZ	GN1285A0	GOMA SONDA TEMPERATUR A NTC	1	PZ															
Código	Descripción	Cant.	UdM																										
GN1120A0	GOMA SONDA TEMPERATUR	1	PZ																										
GN1285A0	GOMA SONDA TEMPERATUR A NTC	1	PZ																										

COMPONENTE			REPUESTO																												
Código	Descripción	Imagen	Código	Descripción	Lista de componentes																										
GN1285A	GOMA SONDA TEMPERATURA NTC		KTR1105A	KIT SONDA TEMPERATURA L1000	<table border="1"> <thead> <tr> <th>Código</th> <th>Descripción</th> <th>Cant.</th> <th>UdM</th> </tr> </thead> <tbody> <tr> <td>SL1045A0</td> <td>SILICONA ANTRACITA S53 SP-5007 80ML</td> <td>1</td> <td>PZ</td> </tr> <tr> <td>TR1105A3</td> <td>SONDA TEMPERATUR A PT100 L1000</td> <td>1</td> <td>PZ</td> </tr> <tr> <td>VI1220A1</td> <td>VITE AUTOFIL. 4.2X12 TCB MARUTEX</td> <td>2</td> <td>PZ</td> </tr> <tr> <td>VM1465A0</td> <td>TAPA SONDA TEMPERATUR A CHEFTOP</td> <td>1</td> <td>PZ</td> </tr> </tbody> </table>	Código	Descripción	Cant.	UdM	SL1045A0	SILICONA ANTRACITA S53 SP-5007 80ML	1	PZ	TR1105A3	SONDA TEMPERATUR A PT100 L1000	1	PZ	VI1220A1	VITE AUTOFIL. 4.2X12 TCB MARUTEX	2	PZ	VM1465A0	TAPA SONDA TEMPERATUR A CHEFTOP	1	PZ						
			Código	Descripción	Cant.	UdM																									
			SL1045A0	SILICONA ANTRACITA S53 SP-5007 80ML	1	PZ																									
TR1105A3	SONDA TEMPERATUR A PT100 L1000	1	PZ																												
VI1220A1	VITE AUTOFIL. 4.2X12 TCB MARUTEX	2	PZ																												
VM1465A0	TAPA SONDA TEMPERATUR A CHEFTOP	1	PZ																												
KTR1096A	KIT SONDA TEMPERATURA L=1500 TR196A0	<table border="1"> <thead> <tr> <th>Código</th> <th>Descripción</th> <th>Cant.</th> <th>UdM</th> </tr> </thead> <tbody> <tr> <td>GN1120A0</td> <td>GOMA SONDA TEMPERATUR</td> <td>1</td> <td>PZ</td> </tr> <tr> <td>GN1285A0</td> <td>GOMA SONDA TEMPERATUR A NTC</td> <td>2</td> <td>PZ</td> </tr> <tr> <td>SL1045A0</td> <td>SILICONA ANTRACITA S53 SP-5007 80ML</td> <td>1</td> <td>PZ</td> </tr> <tr> <td>TR1096A0</td> <td></td> <td>1</td> <td>PZ</td> </tr> <tr> <td>VI1220A1</td> <td>VITE AUTOFIL. 4.2X12 TCB MARUTEX</td> <td>2</td> <td>PZ</td> </tr> <tr> <td>VM1465A0</td> <td>TAPA SONDA TEMPERATUR A CHEFTOP</td> <td>1</td> <td>PZ</td> </tr> </tbody> </table>	Código	Descripción	Cant.	UdM	GN1120A0	GOMA SONDA TEMPERATUR	1	PZ	GN1285A0	GOMA SONDA TEMPERATUR A NTC	2	PZ	SL1045A0	SILICONA ANTRACITA S53 SP-5007 80ML	1	PZ	TR1096A0		1	PZ	VI1220A1	VITE AUTOFIL. 4.2X12 TCB MARUTEX	2	PZ	VM1465A0	TAPA SONDA TEMPERATUR A CHEFTOP	1	PZ	
Código	Descripción	Cant.	UdM																												
GN1120A0	GOMA SONDA TEMPERATUR	1	PZ																												
GN1285A0	GOMA SONDA TEMPERATUR A NTC	2	PZ																												
SL1045A0	SILICONA ANTRACITA S53 SP-5007 80ML	1	PZ																												
TR1096A0		1	PZ																												
VI1220A1	VITE AUTOFIL. 4.2X12 TCB MARUTEX	2	PZ																												
VM1465A0	TAPA SONDA TEMPERATUR A CHEFTOP	1	PZ																												
KTR1095A	KIT SONDA TEMPERATURA TR1095A0	<table border="1"> <thead> <tr> <th>Código</th> <th>Descripción</th> <th>Cant.</th> <th>UdM</th> </tr> </thead> <tbody> <tr> <td>GN1120A0</td> <td>GOMA SONDA TEMPERATUR</td> <td>1</td> <td>PZ</td> </tr> <tr> <td>GN1285A0</td> <td>GOMA SONDA TEMPERATUR A NTC</td> <td>1</td> <td>PZ</td> </tr> <tr> <td>SL1045A0</td> <td>SILICONA ANTRACITA S53 SP-5007 80ML</td> <td>1</td> <td>PZ</td> </tr> <tr> <td>TR1095A0</td> <td>TEMPERATUR E PROBE NTC 150 L=1050</td> <td>1</td> <td>PZ</td> </tr> <tr> <td>VI1220A1</td> <td>VITE AUTOFIL. 4.2X12 TCB MARUTEX</td> <td>2</td> <td>PZ</td> </tr> <tr> <td>VM1465A0</td> <td>TAPA SONDA TEMPERATUR A CHEFTOP</td> <td>1</td> <td>PZ</td> </tr> </tbody> </table>	Código	Descripción	Cant.	UdM	GN1120A0	GOMA SONDA TEMPERATUR	1	PZ	GN1285A0	GOMA SONDA TEMPERATUR A NTC	1	PZ	SL1045A0	SILICONA ANTRACITA S53 SP-5007 80ML	1	PZ	TR1095A0	TEMPERATUR E PROBE NTC 150 L=1050	1	PZ	VI1220A1	VITE AUTOFIL. 4.2X12 TCB MARUTEX	2	PZ	VM1465A0	TAPA SONDA TEMPERATUR A CHEFTOP	1	PZ	
Código	Descripción	Cant.	UdM																												
GN1120A0	GOMA SONDA TEMPERATUR	1	PZ																												
GN1285A0	GOMA SONDA TEMPERATUR A NTC	1	PZ																												
SL1045A0	SILICONA ANTRACITA S53 SP-5007 80ML	1	PZ																												
TR1095A0	TEMPERATUR E PROBE NTC 150 L=1050	1	PZ																												
VI1220A1	VITE AUTOFIL. 4.2X12 TCB MARUTEX	2	PZ																												
VM1465A0	TAPA SONDA TEMPERATUR A CHEFTOP	1	PZ																												

COMPONENTE			REPUESTO																										
Código	Descripción	Imagen	Código	Descripción	Lista de componentes																								
GN1285A	GOMA SONDA TEMPERATURA NTC		KTR1002A		<table border="1"> <thead> <tr> <th>Código</th> <th>Descripción</th> <th>Cant.</th> <th>UdM</th> </tr> </thead> <tbody> <tr> <td>GN1285A0</td> <td>GOMA SONDA TEMPERATUR A NTC</td> <td>2</td> <td>PZ</td> </tr> <tr> <td>SL1045A0</td> <td>SILICONA ANTRACITA S53 SP-5007 80ML</td> <td>1</td> <td>PZ</td> </tr> <tr> <td>TR1002A0</td> <td></td> <td>1</td> <td>PZ</td> </tr> <tr> <td>VI1220A1</td> <td>VITE AUTOFIL. 4.2X12 TCB MARUTEX</td> <td>2</td> <td>PZ</td> </tr> <tr> <td>VM1465A0</td> <td>TAPA SONDA TEMPERATUR A CHEFTOP</td> <td>1</td> <td>PZ</td> </tr> </tbody> </table>	Código	Descripción	Cant.	UdM	GN1285A0	GOMA SONDA TEMPERATUR A NTC	2	PZ	SL1045A0	SILICONA ANTRACITA S53 SP-5007 80ML	1	PZ	TR1002A0		1	PZ	VI1220A1	VITE AUTOFIL. 4.2X12 TCB MARUTEX	2	PZ	VM1465A0	TAPA SONDA TEMPERATUR A CHEFTOP	1	PZ
Código	Descripción	Cant.	UdM																										
GN1285A0	GOMA SONDA TEMPERATUR A NTC	2	PZ																										
SL1045A0	SILICONA ANTRACITA S53 SP-5007 80ML	1	PZ																										
TR1002A0		1	PZ																										
VI1220A1	VITE AUTOFIL. 4.2X12 TCB MARUTEX	2	PZ																										
VM1465A0	TAPA SONDA TEMPERATUR A CHEFTOP	1	PZ																										
TR1106A	SONDA TEMPERATURA PT100 L2000		KTR1106A	KIT SONDA TEMPERATURA L2000	<table border="1"> <thead> <tr> <th>Código</th> <th>Descripción</th> <th>Cant.</th> <th>UdM</th> </tr> </thead> <tbody> <tr> <td>GN1285A0</td> <td>GOMA SONDA TEMPERATUR A NTC</td> <td>1</td> <td>PZ</td> </tr> <tr> <td>SL1045A0</td> <td>SILICONA ANTRACITA S53 SP-5007 80ML</td> <td>1</td> <td>PZ</td> </tr> <tr> <td>TR1106A3</td> <td>SONDA TEMPERATUR A PT100 L2000</td> <td>1</td> <td>PZ</td> </tr> <tr> <td>VI1220A1</td> <td>VITE AUTOFIL. 4.2X12 TCB MARUTEX</td> <td>2</td> <td>PZ</td> </tr> <tr> <td>VM1465A0</td> <td>TAPA SONDA TEMPERATUR A CHEFTOP</td> <td>1</td> <td>PZ</td> </tr> </tbody> </table>	Código	Descripción	Cant.	UdM	GN1285A0	GOMA SONDA TEMPERATUR A NTC	1	PZ	SL1045A0	SILICONA ANTRACITA S53 SP-5007 80ML	1	PZ	TR1106A3	SONDA TEMPERATUR A PT100 L2000	1	PZ	VI1220A1	VITE AUTOFIL. 4.2X12 TCB MARUTEX	2	PZ	VM1465A0	TAPA SONDA TEMPERATUR A CHEFTOP	1	PZ
Código	Descripción	Cant.	UdM																										
GN1285A0	GOMA SONDA TEMPERATUR A NTC	1	PZ																										
SL1045A0	SILICONA ANTRACITA S53 SP-5007 80ML	1	PZ																										
TR1106A3	SONDA TEMPERATUR A PT100 L2000	1	PZ																										
VI1220A1	VITE AUTOFIL. 4.2X12 TCB MARUTEX	2	PZ																										
VM1465A0	TAPA SONDA TEMPERATUR A CHEFTOP	1	PZ																										
VM1464A			VM1464A0																										
GN1531A	GOMA SONDA		KTR1136A	KIT TERMOSTATO DE SEGUR. UNIPOL TR1136A	<table border="1"> <thead> <tr> <th>Código</th> <th>Descripción</th> <th>Cant.</th> <th>UdM</th> </tr> </thead> <tbody> <tr> <td>0H7030A0</td> <td>TAPA ENTRADA BULBO</td> <td>1</td> <td>PZ</td> </tr> <tr> <td>GN1531A0</td> <td>GOMA SONDA</td> <td>1</td> <td>PZ</td> </tr> <tr> <td>SL1045A0</td> <td>SILICONA ANTRACITA S53 SP-5007 80ML</td> <td>1</td> <td>PZ</td> </tr> <tr> <td>TR1136A0</td> <td>TERMOSTATO SEGURIDAD 330°C</td> <td>1</td> <td>PZ</td> </tr> <tr> <td>VI1220A1</td> <td>VITE AUTOFIL. 4.2X12 TCB MARUTEX</td> <td>3</td> <td>PZ</td> </tr> </tbody> </table>	Código	Descripción	Cant.	UdM	0H7030A0	TAPA ENTRADA BULBO	1	PZ	GN1531A0	GOMA SONDA	1	PZ	SL1045A0	SILICONA ANTRACITA S53 SP-5007 80ML	1	PZ	TR1136A0	TERMOSTATO SEGURIDAD 330°C	1	PZ	VI1220A1	VITE AUTOFIL. 4.2X12 TCB MARUTEX	3	PZ
Código	Descripción	Cant.	UdM																										
0H7030A0	TAPA ENTRADA BULBO	1	PZ																										
GN1531A0	GOMA SONDA	1	PZ																										
SL1045A0	SILICONA ANTRACITA S53 SP-5007 80ML	1	PZ																										
TR1136A0	TERMOSTATO SEGURIDAD 330°C	1	PZ																										
VI1220A1	VITE AUTOFIL. 4.2X12 TCB MARUTEX	3	PZ																										



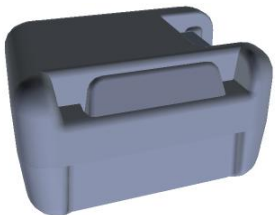
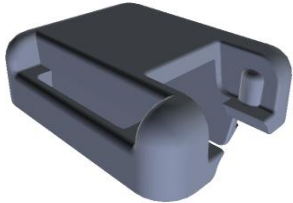

COMPONENTE			REPUESTO																										
Código	Descripción	Imagen	Código	Descripción	Lista de componentes																								
0H7030A	TAPA ENTRADA BULBO		0H7030A0	TAPA ENTRADA BULBO																									
GRL1390A			GRL1390A0																										
GRL1389A			GRL1389A0																										
TR1040A	SONDA AL CORAZON MOLDEADA L1320		KTR1040A	KIT SONDA AL CORAZON MOLDEADA L=1320 TR1	<table border="1"> <thead> <tr> <th>Código</th> <th>Descripción</th> <th>Cant.</th> <th>UdM</th> </tr> </thead> <tbody> <tr> <td>0H7374A0</td> <td>LAMINA CABLE SONDA CORAZON</td> <td>1</td> <td>PZ</td> </tr> <tr> <td>TR1040A2</td> <td>SONDA AL CORAZON MOLDEADA L1320</td> <td>1</td> <td>PZ</td> </tr> </tbody> </table>	Código	Descripción	Cant.	UdM	0H7374A0	LAMINA CABLE SONDA CORAZON	1	PZ	TR1040A2	SONDA AL CORAZON MOLDEADA L1320	1	PZ												
Código	Descripción	Cant.	UdM																										
0H7374A0	LAMINA CABLE SONDA CORAZON	1	PZ																										
TR1040A2	SONDA AL CORAZON MOLDEADA L1320	1	PZ																										
SN1019A			KSN1019A	KIT SONDA AL CORAZON MULTIPUNTO L1550	<table border="1"> <thead> <tr> <th>Código</th> <th>Descripción</th> <th>Cant.</th> <th>UdM</th> </tr> </thead> <tbody> <tr> <td>CE1037A0</td> <td></td> <td>0.600</td> <td>M</td> </tr> <tr> <td>CE1685A0</td> <td>BORNE HEMBRA MRT8 P3,81 5P</td> <td>1</td> <td>PZ</td> </tr> <tr> <td>RC1130A0</td> <td></td> <td>2</td> <td>PZ</td> </tr> <tr> <td>SN1000A1</td> <td>SONDA AL CORAZON MULTIPUNTO L1550</td> <td>1</td> <td>PZ</td> </tr> <tr> <td>SN1000A2</td> <td></td> <td>1</td> <td>PZ</td> </tr> </tbody> </table>	Código	Descripción	Cant.	UdM	CE1037A0		0.600	M	CE1685A0	BORNE HEMBRA MRT8 P3,81 5P	1	PZ	RC1130A0		2	PZ	SN1000A1	SONDA AL CORAZON MULTIPUNTO L1550	1	PZ	SN1000A2		1	PZ
Código	Descripción	Cant.	UdM																										
CE1037A0		0.600	M																										
CE1685A0	BORNE HEMBRA MRT8 P3,81 5P	1	PZ																										
RC1130A0		2	PZ																										
SN1000A1	SONDA AL CORAZON MULTIPUNTO L1550	1	PZ																										
SN1000A2		1	PZ																										



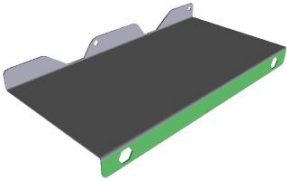

COMPONENTE			REPUESTO																										
Código	Descripción	Imagen	Código	Descripción	Lista de componentes																								
SN1000A			KSN1019A	KIT SONDA AL CORAZON MULTIPUNTO L1550	<table border="1"> <thead> <tr> <th>Código</th> <th>Descripción</th> <th>Cant.</th> <th>UdM</th> </tr> </thead> <tbody> <tr> <td>CE1037A0</td> <td></td> <td>0.600</td> <td>M</td> </tr> <tr> <td>CE1685A0</td> <td>BORNE HEMBRA MRT8 P3,81 5P</td> <td>1</td> <td>PZ</td> </tr> <tr> <td>RC1130A0</td> <td></td> <td>2</td> <td>PZ</td> </tr> <tr> <td>SN1000A1</td> <td>SONDA AL CORAZON MULTIPUNTO L1550</td> <td>1</td> <td>PZ</td> </tr> <tr> <td>SN1000A2</td> <td></td> <td>1</td> <td>PZ</td> </tr> </tbody> </table>	Código	Descripción	Cant.	UdM	CE1037A0		0.600	M	CE1685A0	BORNE HEMBRA MRT8 P3,81 5P	1	PZ	RC1130A0		2	PZ	SN1000A1	SONDA AL CORAZON MULTIPUNTO L1550	1	PZ	SN1000A2		1	PZ
					Código	Descripción	Cant.	UdM																					
					CE1037A0		0.600	M																					
			CE1685A0	BORNE HEMBRA MRT8 P3,81 5P	1	PZ																							
			RC1130A0		2	PZ																							
			SN1000A1	SONDA AL CORAZON MULTIPUNTO L1550	1	PZ																							
			SN1000A2		1	PZ																							
			KSN1000A	KIT SONDA AL CORAZON MULTIPUNTO L1550	<table border="1"> <thead> <tr> <th>Código</th> <th>Descripción</th> <th>Cant.</th> <th>UdM</th> </tr> </thead> <tbody> <tr> <td>0H7374A0</td> <td>LAMINA CABLE SONDA CORAZON</td> <td>1</td> <td>PZ</td> </tr> <tr> <td>CE1685A0</td> <td>BORNE HEMBRA MRT8 P3,81 5P</td> <td>1</td> <td>PZ</td> </tr> <tr> <td>SN1000A1</td> <td>SONDA AL CORAZON MULTIPUNTO L1550</td> <td>1</td> <td>PZ</td> </tr> <tr> <td>SN1000A2</td> <td></td> <td>1</td> <td>PZ</td> </tr> </tbody> </table>	Código	Descripción	Cant.	UdM	0H7374A0	LAMINA CABLE SONDA CORAZON	1	PZ	CE1685A0	BORNE HEMBRA MRT8 P3,81 5P	1	PZ	SN1000A1	SONDA AL CORAZON MULTIPUNTO L1550	1	PZ	SN1000A2		1	PZ				
					Código	Descripción	Cant.	UdM																					
					0H7374A0	LAMINA CABLE SONDA CORAZON	1	PZ																					
			CE1685A0	BORNE HEMBRA MRT8 P3,81 5P	1	PZ																							
			SN1000A1	SONDA AL CORAZON MULTIPUNTO L1550	1	PZ																							
			SN1000A2		1	PZ																							
			KSN0001A	KIT SONDA AL CORAZON MULTIPUNTO L1550	<table border="1"> <thead> <tr> <th>Código</th> <th>Descripción</th> <th>Cant.</th> <th>UdM</th> </tr> </thead> <tbody> <tr> <td>0H7374A0</td> <td>LAMINA CABLE SONDA CORAZON</td> <td>1</td> <td>PZ</td> </tr> <tr> <td>CE1037A0</td> <td></td> <td>0.700</td> <td>M</td> </tr> <tr> <td>CE1685A0</td> <td>BORNE HEMBRA MRT8 P3,81 5P</td> <td>1</td> <td>PZ</td> </tr> <tr> <td>SN1000A1</td> <td>SONDA AL CORAZON MULTIPUNTO L1550</td> <td>1</td> <td>PZ</td> </tr> <tr> <td>SN1000A2</td> <td></td> <td>1</td> <td>PZ</td> </tr> </tbody> </table>	Código	Descripción	Cant.	UdM	0H7374A0	LAMINA CABLE SONDA CORAZON	1	PZ	CE1037A0		0.700	M	CE1685A0	BORNE HEMBRA MRT8 P3,81 5P	1	PZ	SN1000A1	SONDA AL CORAZON MULTIPUNTO L1550	1	PZ	SN1000A2		1	PZ
					Código	Descripción	Cant.	UdM																					
0H7374A0	LAMINA CABLE SONDA CORAZON	1			PZ																								
CE1037A0		0.700			M																								
CE1685A0	BORNE HEMBRA MRT8 P3,81 5P	1			PZ																								
SN1000A1	SONDA AL CORAZON MULTIPUNTO L1550	1			PZ																								
SN1000A2		1			PZ																								
0H2551A	TAPON TUBO ESCAPE LIQUIDOS INOX XBC/XVC				0H2551A0	TAPON TUBO ESCAPE LIQUIDOS INOX XBC/XVC																							

COMPONENTE			REPUESTO																						
Código	Descripción	Imagen	Código	Descripción	Lista de componentes																				
GN1563A			KG1563A	KIT GOMA PUERTA 0511	<table border="1"> <thead> <tr> <th>Código</th> <th>Descripción</th> <th>Cant.</th> <th>UdM</th> </tr> </thead> <tbody> <tr> <td>GN1006A1</td> <td>GOMA DE PUERTA</td> <td>2.240</td> <td>M</td> </tr> <tr> <td>GN1008A0</td> <td>GOMA INTERNA PARA CONEXION GN1006</td> <td>0.030</td> <td>M</td> </tr> <tr> <td>SL1025A0</td> <td>SILICONA 90ML DOW CORNING 734 CLEAR</td> <td>0.012</td> <td>PZ</td> </tr> <tr> <td>VM2277A0</td> <td>CONEXION INTERNA GOMA PUERT</td> <td>1</td> <td>PZ</td> </tr> </tbody> </table>	Código	Descripción	Cant.	UdM	GN1006A1	GOMA DE PUERTA	2.240	M	GN1008A0	GOMA INTERNA PARA CONEXION GN1006	0.030	M	SL1025A0	SILICONA 90ML DOW CORNING 734 CLEAR	0.012	PZ	VM2277A0	CONEXION INTERNA GOMA PUERT	1	PZ
Código	Descripción	Cant.	UdM																						
GN1006A1	GOMA DE PUERTA	2.240	M																						
GN1008A0	GOMA INTERNA PARA CONEXION GN1006	0.030	M																						
SL1025A0	SILICONA 90ML DOW CORNING 734 CLEAR	0.012	PZ																						
VM2277A0	CONEXION INTERNA GOMA PUERT	1	PZ																						
0H7170A			0H7170A0																						
ASM1748A	Conjunto genérico		ASM1748A0	Conjunto genérico																					
VM2344A			VM2344A0																						



COMPONENTE			REPUESTO																														
Código	Descripción	Imagen	Código	Descripción	Lista de componentes																												
VL1086A			VL1086A0																														
EL1361A	ELECTROVALVULA 3 VIAS J.G. D8-D10		KEL1361A	KIT ELECTROVALVULA EL1361A	<table border="1"> <thead> <tr> <th>Código</th> <th>Descripción</th> <th>Cant.</th> <th>UdM</th> </tr> </thead> <tbody> <tr> <td>EL1361A0</td> <td>ELECTROVAL VULA 3 VIAS J.G. D8-D10</td> <td>1</td> <td>PZ</td> </tr> </tbody> </table>	Código	Descripción	Cant.	UdM	EL1361A0	ELECTROVAL VULA 3 VIAS J.G. D8-D10	1	PZ																				
Código	Descripción	Cant.	UdM																														
EL1361A0	ELECTROVAL VULA 3 VIAS J.G. D8-D10	1	PZ																														
GN1285A	GOMA SONDA TEMPERATURA NTC		KTR1106A	KIT SONDA TEMPERATURA L2000	<table border="1"> <thead> <tr> <th>Código</th> <th>Descripción</th> <th>Cant.</th> <th>UdM</th> </tr> </thead> <tbody> <tr> <td>GN1285A0</td> <td>GOMA SONDA TEMPERATUR A NTC</td> <td>1</td> <td>PZ</td> </tr> <tr> <td>SL1045A0</td> <td>SILICONA ANTRACITA S53 SP-5007 80ML</td> <td>1</td> <td>PZ</td> </tr> <tr> <td>TR1106A3</td> <td>SONDA TEMPERATUR A PT100 L2000</td> <td>1</td> <td>PZ</td> </tr> <tr> <td>VI1220A1</td> <td>VITE AUTOFIL. 4.2X12 TCB MARUTEX</td> <td>2</td> <td>PZ</td> </tr> <tr> <td>VM1465A0</td> <td>TAPA SONDA TEMPERATUR A CHEFTOP</td> <td>1</td> <td>PZ</td> </tr> </tbody> </table>	Código	Descripción	Cant.	UdM	GN1285A0	GOMA SONDA TEMPERATUR A NTC	1	PZ	SL1045A0	SILICONA ANTRACITA S53 SP-5007 80ML	1	PZ	TR1106A3	SONDA TEMPERATUR A PT100 L2000	1	PZ	VI1220A1	VITE AUTOFIL. 4.2X12 TCB MARUTEX	2	PZ	VM1465A0	TAPA SONDA TEMPERATUR A CHEFTOP	1	PZ				
Código	Descripción	Cant.	UdM																														
GN1285A0	GOMA SONDA TEMPERATUR A NTC	1	PZ																														
SL1045A0	SILICONA ANTRACITA S53 SP-5007 80ML	1	PZ																														
TR1106A3	SONDA TEMPERATUR A PT100 L2000	1	PZ																														
VI1220A1	VITE AUTOFIL. 4.2X12 TCB MARUTEX	2	PZ																														
VM1465A0	TAPA SONDA TEMPERATUR A CHEFTOP	1	PZ																														
			KTR1105A	KIT SONDA TEMPERATURA L1000	<table border="1"> <thead> <tr> <th>Código</th> <th>Descripción</th> <th>Cant.</th> <th>UdM</th> </tr> </thead> <tbody> <tr> <td>GN1120A0</td> <td>GOMA SONDA TEMPERATUR</td> <td>1</td> <td>PZ</td> </tr> <tr> <td>GN1285A0</td> <td>GOMA SONDA TEMPERATUR A NTC</td> <td>1</td> <td>PZ</td> </tr> <tr> <td>SL1045A0</td> <td>SILICONA ANTRACITA S53 SP-5007 80ML</td> <td>1</td> <td>PZ</td> </tr> <tr> <td>TR1105A3</td> <td>SONDA TEMPERATUR A PT100 L1000</td> <td>1</td> <td>PZ</td> </tr> <tr> <td>VI1220A1</td> <td>VITE AUTOFIL. 4.2X12 TCB MARUTEX</td> <td>2</td> <td>PZ</td> </tr> <tr> <td>VM1465A0</td> <td>TAPA SONDA TEMPERATUR A CHEFTOP</td> <td>1</td> <td>PZ</td> </tr> </tbody> </table>	Código	Descripción	Cant.	UdM	GN1120A0	GOMA SONDA TEMPERATUR	1	PZ	GN1285A0	GOMA SONDA TEMPERATUR A NTC	1	PZ	SL1045A0	SILICONA ANTRACITA S53 SP-5007 80ML	1	PZ	TR1105A3	SONDA TEMPERATUR A PT100 L1000	1	PZ	VI1220A1	VITE AUTOFIL. 4.2X12 TCB MARUTEX	2	PZ	VM1465A0	TAPA SONDA TEMPERATUR A CHEFTOP	1	PZ
Código	Descripción	Cant.	UdM																														
GN1120A0	GOMA SONDA TEMPERATUR	1	PZ																														
GN1285A0	GOMA SONDA TEMPERATUR A NTC	1	PZ																														
SL1045A0	SILICONA ANTRACITA S53 SP-5007 80ML	1	PZ																														
TR1105A3	SONDA TEMPERATUR A PT100 L1000	1	PZ																														
VI1220A1	VITE AUTOFIL. 4.2X12 TCB MARUTEX	2	PZ																														
VM1465A0	TAPA SONDA TEMPERATUR A CHEFTOP	1	PZ																														



COMPONENTE			REPUESTO																																																											
Código	Descripción	Imagen	Código	Descripción	Lista de componentes																																																									
GN1285A	GOMA SONDA TEMPERATURA NTC		KTR1096A	KIT SONDA TEMPERATURA L=1500 TR196A0	<table border="1"> <thead> <tr> <th>Código</th> <th>Descripción</th> <th>Cant.</th> <th>UdM</th> </tr> </thead> <tbody> <tr> <td>GN1120A0</td> <td>GOMA SONDA TEMPERATUR</td> <td>1</td> <td>PZ</td> </tr> <tr> <td>GN1285A0</td> <td>GOMA SONDA TEMPERATUR A NTC</td> <td>2</td> <td>PZ</td> </tr> <tr> <td>SL1045A0</td> <td>SILICONA ANTRACITA S53 SP-5007 80ML</td> <td>1</td> <td>PZ</td> </tr> <tr> <td>TR1096A0</td> <td></td> <td>1</td> <td>PZ</td> </tr> <tr> <td>VI1220A1</td> <td>VITE AUTOFIL. 4.2X12 TCB MARUTEX</td> <td>2</td> <td>PZ</td> </tr> <tr> <td>VM1465A0</td> <td>TAPA SONDA TEMPERATUR A CHEFTOP</td> <td>1</td> <td>PZ</td> </tr> </tbody> </table>	Código	Descripción	Cant.	UdM	GN1120A0	GOMA SONDA TEMPERATUR	1	PZ	GN1285A0	GOMA SONDA TEMPERATUR A NTC	2	PZ	SL1045A0	SILICONA ANTRACITA S53 SP-5007 80ML	1	PZ	TR1096A0		1	PZ	VI1220A1	VITE AUTOFIL. 4.2X12 TCB MARUTEX	2	PZ	VM1465A0	TAPA SONDA TEMPERATUR A CHEFTOP	1	PZ	<table border="1"> <thead> <tr> <th>Código</th> <th>Descripción</th> <th>Cant.</th> <th>UdM</th> </tr> </thead> <tbody> <tr> <td>GN1120A0</td> <td>GOMA SONDA TEMPERATUR</td> <td>1</td> <td>PZ</td> </tr> <tr> <td>GN1285A0</td> <td>GOMA SONDA TEMPERATUR A NTC</td> <td>1</td> <td>PZ</td> </tr> <tr> <td>SL1045A0</td> <td>SILICONA ANTRACITA S53 SP-5007 80ML</td> <td>1</td> <td>PZ</td> </tr> <tr> <td>TR1095A0</td> <td>TEMPERATUR E PROBE NTC 150 L=1050</td> <td>1</td> <td>PZ</td> </tr> <tr> <td>VI1220A1</td> <td>VITE AUTOFIL. 4.2X12 TCB MARUTEX</td> <td>2</td> <td>PZ</td> </tr> <tr> <td>VM1465A0</td> <td>TAPA SONDA TEMPERATUR A CHEFTOP</td> <td>1</td> <td>PZ</td> </tr> </tbody> </table>	Código	Descripción	Cant.	UdM	GN1120A0	GOMA SONDA TEMPERATUR	1	PZ	GN1285A0	GOMA SONDA TEMPERATUR A NTC	1	PZ	SL1045A0	SILICONA ANTRACITA S53 SP-5007 80ML	1	PZ	TR1095A0	TEMPERATUR E PROBE NTC 150 L=1050	1	PZ	VI1220A1	VITE AUTOFIL. 4.2X12 TCB MARUTEX	2	PZ	VM1465A0	TAPA SONDA TEMPERATUR A CHEFTOP	1	PZ
			Código	Descripción	Cant.	UdM																																																								
			GN1120A0	GOMA SONDA TEMPERATUR	1	PZ																																																								
GN1285A0	GOMA SONDA TEMPERATUR A NTC	2	PZ																																																											
SL1045A0	SILICONA ANTRACITA S53 SP-5007 80ML	1	PZ																																																											
TR1096A0		1	PZ																																																											
VI1220A1	VITE AUTOFIL. 4.2X12 TCB MARUTEX	2	PZ																																																											
VM1465A0	TAPA SONDA TEMPERATUR A CHEFTOP	1	PZ																																																											
Código	Descripción	Cant.	UdM																																																											
GN1120A0	GOMA SONDA TEMPERATUR	1	PZ																																																											
GN1285A0	GOMA SONDA TEMPERATUR A NTC	1	PZ																																																											
SL1045A0	SILICONA ANTRACITA S53 SP-5007 80ML	1	PZ																																																											
TR1095A0	TEMPERATUR E PROBE NTC 150 L=1050	1	PZ																																																											
VI1220A1	VITE AUTOFIL. 4.2X12 TCB MARUTEX	2	PZ																																																											
VM1465A0	TAPA SONDA TEMPERATUR A CHEFTOP	1	PZ																																																											
KTR1095A	KIT SONDA TEMPERATURA TR1095A0	<table border="1"> <thead> <tr> <th>Código</th> <th>Descripción</th> <th>Cant.</th> <th>UdM</th> </tr> </thead> <tbody> <tr> <td>GN1120A0</td> <td>GOMA SONDA TEMPERATUR</td> <td>1</td> <td>PZ</td> </tr> <tr> <td>GN1285A0</td> <td>GOMA SONDA TEMPERATUR A NTC</td> <td>1</td> <td>PZ</td> </tr> <tr> <td>SL1045A0</td> <td>SILICONA ANTRACITA S53 SP-5007 80ML</td> <td>1</td> <td>PZ</td> </tr> <tr> <td>TR1095A0</td> <td>TEMPERATUR E PROBE NTC 150 L=1050</td> <td>1</td> <td>PZ</td> </tr> <tr> <td>VI1220A1</td> <td>VITE AUTOFIL. 4.2X12 TCB MARUTEX</td> <td>2</td> <td>PZ</td> </tr> <tr> <td>VM1465A0</td> <td>TAPA SONDA TEMPERATUR A CHEFTOP</td> <td>1</td> <td>PZ</td> </tr> </tbody> </table>	Código	Descripción	Cant.	UdM	GN1120A0	GOMA SONDA TEMPERATUR	1	PZ	GN1285A0	GOMA SONDA TEMPERATUR A NTC	1	PZ	SL1045A0	SILICONA ANTRACITA S53 SP-5007 80ML	1	PZ	TR1095A0	TEMPERATUR E PROBE NTC 150 L=1050	1	PZ	VI1220A1	VITE AUTOFIL. 4.2X12 TCB MARUTEX	2	PZ	VM1465A0	TAPA SONDA TEMPERATUR A CHEFTOP	1	PZ																																
Código	Descripción	Cant.	UdM																																																											
GN1120A0	GOMA SONDA TEMPERATUR	1	PZ																																																											
GN1285A0	GOMA SONDA TEMPERATUR A NTC	1	PZ																																																											
SL1045A0	SILICONA ANTRACITA S53 SP-5007 80ML	1	PZ																																																											
TR1095A0	TEMPERATUR E PROBE NTC 150 L=1050	1	PZ																																																											
VI1220A1	VITE AUTOFIL. 4.2X12 TCB MARUTEX	2	PZ																																																											
VM1465A0	TAPA SONDA TEMPERATUR A CHEFTOP	1	PZ																																																											
KTR1002A	KIT SONDA TEMPERATURA TR1002A0	<table border="1"> <thead> <tr> <th>Código</th> <th>Descripción</th> <th>Cant.</th> <th>UdM</th> </tr> </thead> <tbody> <tr> <td>GN1285A0</td> <td>GOMA SONDA TEMPERATUR A NTC</td> <td>2</td> <td>PZ</td> </tr> <tr> <td>SL1045A0</td> <td>SILICONA ANTRACITA S53 SP-5007 80ML</td> <td>1</td> <td>PZ</td> </tr> <tr> <td>TR1002A0</td> <td></td> <td>1</td> <td>PZ</td> </tr> <tr> <td>VI1220A1</td> <td>VITE AUTOFIL. 4.2X12 TCB MARUTEX</td> <td>2</td> <td>PZ</td> </tr> <tr> <td>VM1465A0</td> <td>TAPA SONDA TEMPERATUR A CHEFTOP</td> <td>1</td> <td>PZ</td> </tr> </tbody> </table>	Código	Descripción	Cant.	UdM	GN1285A0	GOMA SONDA TEMPERATUR A NTC	2	PZ	SL1045A0	SILICONA ANTRACITA S53 SP-5007 80ML	1	PZ	TR1002A0		1	PZ	VI1220A1	VITE AUTOFIL. 4.2X12 TCB MARUTEX	2	PZ	VM1465A0	TAPA SONDA TEMPERATUR A CHEFTOP	1	PZ																																				
Código	Descripción	Cant.	UdM																																																											
GN1285A0	GOMA SONDA TEMPERATUR A NTC	2	PZ																																																											
SL1045A0	SILICONA ANTRACITA S53 SP-5007 80ML	1	PZ																																																											
TR1002A0		1	PZ																																																											
VI1220A1	VITE AUTOFIL. 4.2X12 TCB MARUTEX	2	PZ																																																											
VM1465A0	TAPA SONDA TEMPERATUR A CHEFTOP	1	PZ																																																											

COMPONENTE			REPUESTO																										
Código	Descripción	Imagen	Código	Descripción	Lista de componentes																								
VM1465A	TAPA SONDA TEMPERATURA CHEFTOP		VM1465A0	TAPA SONDA TEMPERATURA CHEFTOP																									
TR1106A	SONDA TEMPERATURA PT100 L2000		KTR1106A	KIT SONDA TEMPERATURA L2000	<table border="1"> <thead> <tr> <th>Código</th> <th>Descripción</th> <th>Cant.</th> <th>UdM</th> </tr> </thead> <tbody> <tr> <td>GN1285A0</td> <td>GOMA SONDA TEMPERATUR A NTC</td> <td>1</td> <td>PZ</td> </tr> <tr> <td>SL1045A0</td> <td>SILICONA ANTRACITA S53 SP-5007 80ML</td> <td>1</td> <td>PZ</td> </tr> <tr> <td>TR1106A3</td> <td>SONDA TEMPERATUR A PT100 L2000</td> <td>1</td> <td>PZ</td> </tr> <tr> <td>VH1220A1</td> <td>VITE AUTOFIL. 4.2X12 TCB MARUTEX</td> <td>2</td> <td>PZ</td> </tr> <tr> <td>VM1465A0</td> <td>TAPA SONDA TEMPERATUR A CHEFTOP</td> <td>1</td> <td>PZ</td> </tr> </tbody> </table>	Código	Descripción	Cant.	UdM	GN1285A0	GOMA SONDA TEMPERATUR A NTC	1	PZ	SL1045A0	SILICONA ANTRACITA S53 SP-5007 80ML	1	PZ	TR1106A3	SONDA TEMPERATUR A PT100 L2000	1	PZ	VH1220A1	VITE AUTOFIL. 4.2X12 TCB MARUTEX	2	PZ	VM1465A0	TAPA SONDA TEMPERATUR A CHEFTOP	1	PZ
Código	Descripción	Cant.	UdM																										
GN1285A0	GOMA SONDA TEMPERATUR A NTC	1	PZ																										
SL1045A0	SILICONA ANTRACITA S53 SP-5007 80ML	1	PZ																										
TR1106A3	SONDA TEMPERATUR A PT100 L2000	1	PZ																										
VH1220A1	VITE AUTOFIL. 4.2X12 TCB MARUTEX	2	PZ																										
VM1465A0	TAPA SONDA TEMPERATUR A CHEFTOP	1	PZ																										
OG1453A	SEPARADOR CARTER CHEFTOP GAS S.5E		OG1453A0	SEPARADOR CARTER CHEFTOP GAS S.5E																									
TB2909A			TB2909A0																										

COMPONENTE			REPUESTO																																		
Código	Descripción	Imagen	Código	Descripción	Lista de componentes																																
0H7449A			0H7449A0																																		
TB2902A			TB2902A0																																		
0H7231A			0H7231A0																																		
0H7230A			0H7230A0																																		
RC1378A			KVE1135A	KIT VENTURI HORNOS SERIE 5/E	<table border="1"> <thead> <tr> <th>Código</th> <th>Descripción</th> <th>Cant.</th> <th>UdM</th> </tr> </thead> <tbody> <tr> <td>GN1310A0</td> <td>GOMA SILICONA VENTURI</td> <td>1</td> <td>PZ</td> </tr> <tr> <td>GN1556A0</td> <td>MM GOMA VENTURI</td> <td>1</td> <td>PZ</td> </tr> <tr> <td>RC1378A0</td> <td></td> <td>2</td> <td>PZ</td> </tr> <tr> <td>TB1520A0</td> <td>TUBO NEGRO D.INT=30 SP=4 GOMA EPDM</td> <td>0.050</td> <td>M</td> </tr> <tr> <td>VE1135A0</td> <td>ENCENDIDO VENTURI 220V 50/60 HZ SERIE 2</td> <td>1</td> <td>PZ</td> </tr> <tr> <td>VI1032A0</td> <td></td> <td>1</td> <td>PZ</td> </tr> <tr> <td>VI1511A0</td> <td></td> <td>2</td> <td>PZ</td> </tr> </tbody> </table>	Código	Descripción	Cant.	UdM	GN1310A0	GOMA SILICONA VENTURI	1	PZ	GN1556A0	MM GOMA VENTURI	1	PZ	RC1378A0		2	PZ	TB1520A0	TUBO NEGRO D.INT=30 SP=4 GOMA EPDM	0.050	M	VE1135A0	ENCENDIDO VENTURI 220V 50/60 HZ SERIE 2	1	PZ	VI1032A0		1	PZ	VI1511A0		2	PZ
Código	Descripción	Cant.	UdM																																		
GN1310A0	GOMA SILICONA VENTURI	1	PZ																																		
GN1556A0	MM GOMA VENTURI	1	PZ																																		
RC1378A0		2	PZ																																		
TB1520A0	TUBO NEGRO D.INT=30 SP=4 GOMA EPDM	0.050	M																																		
VE1135A0	ENCENDIDO VENTURI 220V 50/60 HZ SERIE 2	1	PZ																																		
VI1032A0		1	PZ																																		
VI1511A0		2	PZ																																		



COMPONENTE			REPUESTO					
Código	Descripción	Imagen	Código	Descripción	Lista de componentes			
RC1378A			KVE1135A	KIT VENTURI HORNOS SERIE 5/E	Código	Descripción	Cant.	UdM
					VI1850A0	TORNILLOS DE FIJACION NIQUELADOS M4X6	2	PZ
					VI1865A0		3	PZ
					VM1565B0	SOPORTE BOBINA INFERIOR VENTURI CT B	1	PZ
					VM1566A0	SOPORTE BOBINA SUPERIOR CT BT	1	PZ
					VM1567A0	ANILLO INFERIOR VENTURI	1	PZ
				VM1568A0	SEPARADOR PLATILLO VENTURI	1	PZ	
VM2377A			KVM2377A	KIT VENTURI 220V 50/60HZ MM SERIE	Código	Descripción	Cant.	UdM
					GN1556A0	MM GOMA VENTURI	1	PZ
					RC1378A0		3	PZ
					TB1520A0	TUBO NEGRO D.INT=30 SP=4 GOMA EPDM	0.170	M
					VE1135A0	ENCENDIDO VENTURI 220V 50/60 HZ SERIE 2	1	PZ
					VI1032A0		1	PZ
					VI1220A1	VITE AUTOFIL. 4.2X12 TCB MARUTEX	6	PZ
					VM2345A0	CUERPO SUPERIOR VENTURI MM	1	PZ
					VM2346A0	CUERPO INFERIOR VENTURI MM	1	PZ
					VM2347A0	CUBIERTA VENTURI MIND.MAPS	1	PZ
					VM2348A0	SEPARADOR PLATILLO VENTURI	1	PZ
					VM2349A0	ANILLO INFERIOR VENTURI	1	PZ





COMPONENTE			REPUESTO																																																										
Código	Descripción	Imagen	Código	Descripción	Lista de componentes																																																								
GN1584A			GN1584A0																																																										
TB1956A	TB1520A-TUBO NEGRO EPDM L=50		KVE1135A	KIT VENTURI HORNOS SERIE 5/E	<table border="1"> <thead> <tr> <th>Código</th> <th>Descripción</th> <th>Cant.</th> <th>UdM</th> </tr> </thead> <tbody> <tr> <td>GN1310A0</td> <td>GOMA SILICONA VENTURI</td> <td>1</td> <td>PZ</td> </tr> <tr> <td>GN1556A0</td> <td>MM GOMA VENTURI</td> <td>1</td> <td>PZ</td> </tr> <tr> <td>RC1378A0</td> <td></td> <td>2</td> <td>PZ</td> </tr> <tr> <td>TB1520A0</td> <td>TUBO NEGRO D.INT=30 SP=4 GOMA EPDM</td> <td>0.050</td> <td>M</td> </tr> <tr> <td>VE1135A0</td> <td>ENCENDIDO VENTURI 220V 50/60 HZ SERIE 2</td> <td>1</td> <td>PZ</td> </tr> <tr> <td>VI1032A0</td> <td></td> <td>1</td> <td>PZ</td> </tr> <tr> <td>VI1511A0</td> <td></td> <td>2</td> <td>PZ</td> </tr> <tr> <td>VI1850A0</td> <td>TORNILLOS DE FIJACION NIQUELADOS M4X6</td> <td>2</td> <td>PZ</td> </tr> <tr> <td>VI1865A0</td> <td></td> <td>3</td> <td>PZ</td> </tr> <tr> <td>VM1565B0</td> <td>SOPORTE BOBINA INFERIOR VENTURI CT B</td> <td>1</td> <td>PZ</td> </tr> <tr> <td>VM1566A0</td> <td>SOPORTE BOBINA SUPERIOR CT BT</td> <td>1</td> <td>PZ</td> </tr> <tr> <td>VM1567A0</td> <td>ANILLO INFERIOR VENTURI</td> <td>1</td> <td>PZ</td> </tr> <tr> <td>VM1568A0</td> <td>SEPARADOR PLATILLO VENTURI</td> <td>1</td> <td>PZ</td> </tr> </tbody> </table>	Código	Descripción	Cant.	UdM	GN1310A0	GOMA SILICONA VENTURI	1	PZ	GN1556A0	MM GOMA VENTURI	1	PZ	RC1378A0		2	PZ	TB1520A0	TUBO NEGRO D.INT=30 SP=4 GOMA EPDM	0.050	M	VE1135A0	ENCENDIDO VENTURI 220V 50/60 HZ SERIE 2	1	PZ	VI1032A0		1	PZ	VI1511A0		2	PZ	VI1850A0	TORNILLOS DE FIJACION NIQUELADOS M4X6	2	PZ	VI1865A0		3	PZ	VM1565B0	SOPORTE BOBINA INFERIOR VENTURI CT B	1	PZ	VM1566A0	SOPORTE BOBINA SUPERIOR CT BT	1	PZ	VM1567A0	ANILLO INFERIOR VENTURI	1	PZ	VM1568A0	SEPARADOR PLATILLO VENTURI	1	PZ
Código	Descripción	Cant.	UdM																																																										
GN1310A0	GOMA SILICONA VENTURI	1	PZ																																																										
GN1556A0	MM GOMA VENTURI	1	PZ																																																										
RC1378A0		2	PZ																																																										
TB1520A0	TUBO NEGRO D.INT=30 SP=4 GOMA EPDM	0.050	M																																																										
VE1135A0	ENCENDIDO VENTURI 220V 50/60 HZ SERIE 2	1	PZ																																																										
VI1032A0		1	PZ																																																										
VI1511A0		2	PZ																																																										
VI1850A0	TORNILLOS DE FIJACION NIQUELADOS M4X6	2	PZ																																																										
VI1865A0		3	PZ																																																										
VM1565B0	SOPORTE BOBINA INFERIOR VENTURI CT B	1	PZ																																																										
VM1566A0	SOPORTE BOBINA SUPERIOR CT BT	1	PZ																																																										
VM1567A0	ANILLO INFERIOR VENTURI	1	PZ																																																										
VM1568A0	SEPARADOR PLATILLO VENTURI	1	PZ																																																										
TB2603A			TB2603A0																																																										



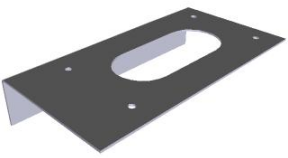

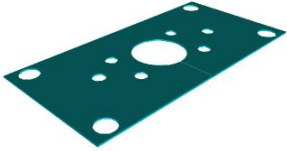
COMPONENTE			REPUESTO																																						
Código	Descripción	Imagen	Código	Descripción	Lista de componentes																																				
TB3069B			TB3069B0																																						
RC1042A			RC1042A0																																						
GN1541A			KG1569A	KIT GOMA ANTORCHA GAS	<table border="1"> <thead> <tr> <th>Código</th> <th>Descripción</th> <th>Cant.</th> <th>UdM</th> </tr> </thead> <tbody> <tr> <td>GN1541A0</td> <td></td> <td>2</td> <td>PZ</td> </tr> <tr> <td>GN1542A0</td> <td></td> <td>4</td> <td>PZ</td> </tr> <tr> <td>GN1543A0</td> <td></td> <td>6</td> <td>PZ</td> </tr> <tr> <td>GN1548A0</td> <td></td> <td>4</td> <td>PZ</td> </tr> <tr> <td>GN1551A1</td> <td></td> <td>2</td> <td>PZ</td> </tr> <tr> <td>GN1559A0</td> <td></td> <td>2</td> <td>PZ</td> </tr> <tr> <td>GN1580A1</td> <td></td> <td>6</td> <td>PZ</td> </tr> <tr> <td>GN1586A1</td> <td></td> <td>2</td> <td>PZ</td> </tr> </tbody> </table>	Código	Descripción	Cant.	UdM	GN1541A0		2	PZ	GN1542A0		4	PZ	GN1543A0		6	PZ	GN1548A0		4	PZ	GN1551A1		2	PZ	GN1559A0		2	PZ	GN1580A1		6	PZ	GN1586A1		2	PZ
Código	Descripción	Cant.	UdM																																						
GN1541A0		2	PZ																																						
GN1542A0		4	PZ																																						
GN1543A0		6	PZ																																						
GN1548A0		4	PZ																																						
GN1551A1		2	PZ																																						
GN1559A0		2	PZ																																						
GN1580A1		6	PZ																																						
GN1586A1		2	PZ																																						
VG1014A			KVG1014A	KIT SISTEMA DE SOPLADO-VENTURI 230V 35KW	<table border="1"> <thead> <tr> <th>Código</th> <th>Descripción</th> <th>Cant.</th> <th>UdM</th> </tr> </thead> <tbody> <tr> <td>GN1415A0</td> <td></td> <td>1</td> <td>PZ</td> </tr> <tr> <td>GN1541A0</td> <td></td> <td>1</td> <td>PZ</td> </tr> <tr> <td>IP1385A1</td> <td></td> <td>0.240</td> <td>M</td> </tr> <tr> <td>VG1014A0</td> <td></td> <td>1</td> <td>PZ</td> </tr> <tr> <td>VI1770A0</td> <td></td> <td>3</td> <td>PZ</td> </tr> <tr> <td>VI2008A0</td> <td></td> <td>3</td> <td>PZ</td> </tr> <tr> <td>VI2021A0</td> <td></td> <td>4</td> <td>PZ</td> </tr> </tbody> </table>	Código	Descripción	Cant.	UdM	GN1415A0		1	PZ	GN1541A0		1	PZ	IP1385A1		0.240	M	VG1014A0		1	PZ	VI1770A0		3	PZ	VI2008A0		3	PZ	VI2021A0		4	PZ				
Código	Descripción	Cant.	UdM																																						
GN1415A0		1	PZ																																						
GN1541A0		1	PZ																																						
IP1385A1		0.240	M																																						
VG1014A0		1	PZ																																						
VI1770A0		3	PZ																																						
VI2008A0		3	PZ																																						
VI2021A0		4	PZ																																						
VN1169A			VN1168A0																																						





COMPONENTE			REPUESTO																																						
Código	Descripción	Imagen	Código	Descripción	Lista de componentes																																				
VG1012A			VG1012A0																																						
VG1010A			VG1010A0																																						
RC1394A																																									
ON1415A			ON1415A0																																						
GN1548A			KG1569A	KIT GOMA ANTORCHA GAS	<table border="1"> <thead> <tr> <th>Código</th> <th>Descripción</th> <th>Cant.</th> <th>UdM</th> </tr> </thead> <tbody> <tr> <td>GN1541A0</td> <td></td> <td>2</td> <td>PZ</td> </tr> <tr> <td>GN1542A0</td> <td></td> <td>4</td> <td>PZ</td> </tr> <tr> <td>GN1543A0</td> <td></td> <td>6</td> <td>PZ</td> </tr> <tr> <td>GN1548A0</td> <td></td> <td>4</td> <td>PZ</td> </tr> <tr> <td>GN1551A1</td> <td></td> <td>2</td> <td>PZ</td> </tr> <tr> <td>GN1559A0</td> <td></td> <td>2</td> <td>PZ</td> </tr> <tr> <td>GN1580A1</td> <td></td> <td>6</td> <td>PZ</td> </tr> <tr> <td>GN1586A1</td> <td></td> <td>2</td> <td>PZ</td> </tr> </tbody> </table>	Código	Descripción	Cant.	UdM	GN1541A0		2	PZ	GN1542A0		4	PZ	GN1543A0		6	PZ	GN1548A0		4	PZ	GN1551A1		2	PZ	GN1559A0		2	PZ	GN1580A1		6	PZ	GN1586A1		2	PZ
Código	Descripción	Cant.	UdM																																						
GN1541A0		2	PZ																																						
GN1542A0		4	PZ																																						
GN1543A0		6	PZ																																						
GN1548A0		4	PZ																																						
GN1551A1		2	PZ																																						
GN1559A0		2	PZ																																						
GN1580A1		6	PZ																																						
GN1586A1		2	PZ																																						

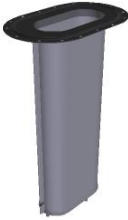

COMPONENTE			REPUESTO																																																																						
Código	Descripción	Imagen	Código	Descripción	Lista de componentes																																																																				
GN1542A			KGN1569A	KIT GOMA ANTORCHA GAS	<table border="1"> <thead> <tr> <th>Código</th> <th>Descripción</th> <th>Cant.</th> <th>UdM</th> </tr> </thead> <tbody> <tr> <td>GN1541A0</td> <td></td> <td>2</td> <td>PZ</td> </tr> <tr> <td>GN1542A0</td> <td></td> <td>4</td> <td>PZ</td> </tr> <tr> <td>GN1543A0</td> <td></td> <td>6</td> <td>PZ</td> </tr> <tr> <td>GN1548A0</td> <td></td> <td>4</td> <td>PZ</td> </tr> <tr> <td>GN1551A1</td> <td></td> <td>2</td> <td>PZ</td> </tr> <tr> <td>GN1559A0</td> <td></td> <td>2</td> <td>PZ</td> </tr> <tr> <td>GN1580A1</td> <td></td> <td>6</td> <td>PZ</td> </tr> <tr> <td>GN1586A1</td> <td></td> <td>2</td> <td>PZ</td> </tr> </tbody> </table>	Código	Descripción	Cant.	UdM	GN1541A0		2	PZ	GN1542A0		4	PZ	GN1543A0		6	PZ	GN1548A0		4	PZ	GN1551A1		2	PZ	GN1559A0		2	PZ	GN1580A1		6	PZ	GN1586A1		2	PZ																																
Código	Descripción	Cant.	UdM																																																																						
GN1541A0		2	PZ																																																																						
GN1542A0		4	PZ																																																																						
GN1543A0		6	PZ																																																																						
GN1548A0		4	PZ																																																																						
GN1551A1		2	PZ																																																																						
GN1559A0		2	PZ																																																																						
GN1580A1		6	PZ																																																																						
GN1586A1		2	PZ																																																																						
RC1385A			RC1385A0																																																																						
ON1383A			ON1383A0																																																																						
GN1543A			KGN1569A	KIT GOMA ANTORCHA GAS	<table border="1"> <thead> <tr> <th>Código</th> <th>Descripción</th> <th>Cant.</th> <th>UdM</th> </tr> </thead> <tbody> <tr> <td>GN1541A0</td> <td></td> <td>2</td> <td>PZ</td> </tr> <tr> <td>GN1542A0</td> <td></td> <td>4</td> <td>PZ</td> </tr> <tr> <td>GN1543A0</td> <td></td> <td>6</td> <td>PZ</td> </tr> <tr> <td>GN1548A0</td> <td></td> <td>4</td> <td>PZ</td> </tr> <tr> <td>GN1551A1</td> <td></td> <td>2</td> <td>PZ</td> </tr> <tr> <td>GN1559A0</td> <td></td> <td>2</td> <td>PZ</td> </tr> <tr> <td>GN1580A1</td> <td></td> <td>6</td> <td>PZ</td> </tr> <tr> <td>GN1586A1</td> <td></td> <td>2</td> <td>PZ</td> </tr> </tbody> </table>	Código	Descripción	Cant.	UdM	GN1541A0		2	PZ	GN1542A0		4	PZ	GN1543A0		6	PZ	GN1548A0		4	PZ	GN1551A1		2	PZ	GN1559A0		2	PZ	GN1580A1		6	PZ	GN1586A1		2	PZ																																
Código	Descripción	Cant.	UdM																																																																						
GN1541A0		2	PZ																																																																						
GN1542A0		4	PZ																																																																						
GN1543A0		6	PZ																																																																						
GN1548A0		4	PZ																																																																						
GN1551A1		2	PZ																																																																						
GN1559A0		2	PZ																																																																						
GN1580A1		6	PZ																																																																						
GN1586A1		2	PZ																																																																						
BR1345A			KVG1031A	KIT CONJUNTO SOPLETE 7.5KW+BUJIAS 0511-G	<table border="1"> <thead> <tr> <th>Código</th> <th>Descripción</th> <th>Cant.</th> <th>UdM</th> </tr> </thead> <tbody> <tr> <td>BR1340A0</td> <td></td> <td>3</td> <td>PZ</td> </tr> <tr> <td>BR1340A1</td> <td></td> <td>3</td> <td>PZ</td> </tr> <tr> <td>BR1345A0</td> <td></td> <td>1</td> <td>PZ</td> </tr> <tr> <td>BR1345A1</td> <td></td> <td>1</td> <td>PZ</td> </tr> <tr> <td>BR1350A0</td> <td></td> <td>1</td> <td>PZ</td> </tr> <tr> <td>GN1542A0</td> <td></td> <td>1</td> <td>PZ</td> </tr> <tr> <td>GN1543A0</td> <td></td> <td>3</td> <td>PZ</td> </tr> <tr> <td>GN1551A0</td> <td></td> <td>1</td> <td>PZ</td> </tr> <tr> <td>GN1551A1</td> <td></td> <td>1</td> <td>PZ</td> </tr> <tr> <td>GN1580A0</td> <td></td> <td>3</td> <td>PZ</td> </tr> <tr> <td>GN1580A1</td> <td></td> <td>3</td> <td>PZ</td> </tr> <tr> <td>GN1586A0</td> <td></td> <td>1</td> <td>PZ</td> </tr> <tr> <td>GN1586A1</td> <td></td> <td>1</td> <td>PZ</td> </tr> <tr> <td>IP1385A1</td> <td></td> <td>0.270</td> <td>M</td> </tr> <tr> <td>RC1385A0</td> <td></td> <td>1</td> <td>PZ</td> </tr> <tr> <td>VI0504A1</td> <td></td> <td>3</td> <td>PZ</td> </tr> </tbody> </table>	Código	Descripción	Cant.	UdM	BR1340A0		3	PZ	BR1340A1		3	PZ	BR1345A0		1	PZ	BR1345A1		1	PZ	BR1350A0		1	PZ	GN1542A0		1	PZ	GN1543A0		3	PZ	GN1551A0		1	PZ	GN1551A1		1	PZ	GN1580A0		3	PZ	GN1580A1		3	PZ	GN1586A0		1	PZ	GN1586A1		1	PZ	IP1385A1		0.270	M	RC1385A0		1	PZ	VI0504A1		3	PZ
Código	Descripción	Cant.	UdM																																																																						
BR1340A0		3	PZ																																																																						
BR1340A1		3	PZ																																																																						
BR1345A0		1	PZ																																																																						
BR1345A1		1	PZ																																																																						
BR1350A0		1	PZ																																																																						
GN1542A0		1	PZ																																																																						
GN1543A0		3	PZ																																																																						
GN1551A0		1	PZ																																																																						
GN1551A1		1	PZ																																																																						
GN1580A0		3	PZ																																																																						
GN1580A1		3	PZ																																																																						
GN1586A0		1	PZ																																																																						
GN1586A1		1	PZ																																																																						
IP1385A1		0.270	M																																																																						
RC1385A0		1	PZ																																																																						
VI0504A1		3	PZ																																																																						

COMPONENTE			REPUESTO																																																			
Código	Descripción	Imagen	Código	Descripción	Lista de componentes																																																	
BR1345A			KVG1031A	KIT CONJUNTO SOPLETE 7.5KW+BUJIAS 0511-G	<table border="1"> <thead> <tr> <th>Código</th> <th>Descripción</th> <th>Cant.</th> <th>UdM</th> </tr> </thead> <tbody> <tr> <td>VI1075A0</td> <td>TUERCA M4 H=4 INOX UNI5587</td> <td>3</td> <td>PZ</td> </tr> <tr> <td>VI2009A0</td> <td></td> <td>3</td> <td>PZ</td> </tr> <tr> <td>VI2009A1</td> <td></td> <td>3</td> <td>PZ</td> </tr> </tbody> </table>	Código	Descripción	Cant.	UdM	VI1075A0	TUERCA M4 H=4 INOX UNI5587	3	PZ	VI2009A0		3	PZ	VI2009A1		3	PZ																																	
			Código	Descripción	Cant.	UdM																																																
VI1075A0	TUERCA M4 H=4 INOX UNI5587	3	PZ																																																			
VI2009A0		3	PZ																																																			
VI2009A1		3	PZ																																																			
KBR1345A	KIT ANTORCHA GAS PREMIX 7,5KW+SOPORTE	<table border="1"> <thead> <tr> <th>Código</th> <th>Descripción</th> <th>Cant.</th> <th>UdM</th> </tr> </thead> <tbody> <tr> <td>BR1340A0</td> <td></td> <td>3</td> <td>PZ</td> </tr> <tr> <td>BR1340A1</td> <td></td> <td>3</td> <td>PZ</td> </tr> <tr> <td>BR1345A0</td> <td></td> <td>1</td> <td>PZ</td> </tr> <tr> <td>BR1345A1</td> <td></td> <td>1</td> <td>PZ</td> </tr> <tr> <td>GN1543A0</td> <td></td> <td>3</td> <td>PZ</td> </tr> <tr> <td>GN1551A0</td> <td></td> <td>1</td> <td>PZ</td> </tr> <tr> <td>GN1551A1</td> <td></td> <td>1</td> <td>PZ</td> </tr> <tr> <td>GN1580A0</td> <td></td> <td>3</td> <td>PZ</td> </tr> <tr> <td>GN1580A1</td> <td></td> <td>3</td> <td>PZ</td> </tr> <tr> <td>VI0504A0</td> <td></td> <td>3</td> <td>PZ</td> </tr> <tr> <td>VI1075A0</td> <td>TUERCA M4 H=4 INOX UNI5587</td> <td>3</td> <td>PZ</td> </tr> <tr> <td>VI2009A0</td> <td></td> <td>3</td> <td>PZ</td> </tr> </tbody> </table>	Código	Descripción	Cant.	UdM	BR1340A0		3	PZ	BR1340A1		3	PZ	BR1345A0		1	PZ	BR1345A1		1	PZ	GN1543A0		3	PZ	GN1551A0		1	PZ	GN1551A1		1	PZ	GN1580A0		3	PZ	GN1580A1		3	PZ	VI0504A0		3	PZ	VI1075A0	TUERCA M4 H=4 INOX UNI5587	3	PZ	VI2009A0		3	PZ
Código	Descripción	Cant.	UdM																																																			
BR1340A0		3	PZ																																																			
BR1340A1		3	PZ																																																			
BR1345A0		1	PZ																																																			
BR1345A1		1	PZ																																																			
GN1543A0		3	PZ																																																			
GN1551A0		1	PZ																																																			
GN1551A1		1	PZ																																																			
GN1580A0		3	PZ																																																			
GN1580A1		3	PZ																																																			
VI0504A0		3	PZ																																																			
VI1075A0	TUERCA M4 H=4 INOX UNI5587	3	PZ																																																			
VI2009A0		3	PZ																																																			
BR1340A			KBR1340A	KIT 6 UDS BUJIA DE ENCENDIDO PREMI	<table border="1"> <thead> <tr> <th>Código</th> <th>Descripción</th> <th>Cant.</th> <th>UdM</th> </tr> </thead> <tbody> <tr> <td>BR1340A0</td> <td></td> <td>1</td> <td>PZ</td> </tr> <tr> <td>BR1340A1</td> <td></td> <td>6</td> <td>PZ</td> </tr> <tr> <td>GN1543A0</td> <td></td> <td>1</td> <td>PZ</td> </tr> <tr> <td>VI1075A0</td> <td>TUERCA M4 H=4 INOX UNI5587</td> <td>2</td> <td>PZ</td> </tr> <tr> <td>VI1550A0</td> <td></td> <td>2</td> <td>PZ</td> </tr> </tbody> </table>	Código	Descripción	Cant.	UdM	BR1340A0		1	PZ	BR1340A1		6	PZ	GN1543A0		1	PZ	VI1075A0	TUERCA M4 H=4 INOX UNI5587	2	PZ	VI1550A0		2	PZ																									
Código	Descripción	Cant.	UdM																																																			
BR1340A0		1	PZ																																																			
BR1340A1		6	PZ																																																			
GN1543A0		1	PZ																																																			
VI1075A0	TUERCA M4 H=4 INOX UNI5587	2	PZ																																																			
VI1550A0		2	PZ																																																			
GN1580A			KGN1569A	KIT GOMA ANTORCHA GAS	<table border="1"> <thead> <tr> <th>Código</th> <th>Descripción</th> <th>Cant.</th> <th>UdM</th> </tr> </thead> <tbody> <tr> <td>GN1541A0</td> <td></td> <td>2</td> <td>PZ</td> </tr> <tr> <td>GN1542A0</td> <td></td> <td>4</td> <td>PZ</td> </tr> <tr> <td>GN1543A0</td> <td></td> <td>6</td> <td>PZ</td> </tr> <tr> <td>GN1548A0</td> <td></td> <td>4</td> <td>PZ</td> </tr> <tr> <td>GN1551A1</td> <td></td> <td>2</td> <td>PZ</td> </tr> <tr> <td>GN1559A0</td> <td></td> <td>2</td> <td>PZ</td> </tr> <tr> <td>GN1580A1</td> <td></td> <td>6</td> <td>PZ</td> </tr> <tr> <td>GN1586A1</td> <td></td> <td>2</td> <td>PZ</td> </tr> </tbody> </table>	Código	Descripción	Cant.	UdM	GN1541A0		2	PZ	GN1542A0		4	PZ	GN1543A0		6	PZ	GN1548A0		4	PZ	GN1551A1		2	PZ	GN1559A0		2	PZ	GN1580A1		6	PZ	GN1586A1		2	PZ													
Código	Descripción	Cant.	UdM																																																			
GN1541A0		2	PZ																																																			
GN1542A0		4	PZ																																																			
GN1543A0		6	PZ																																																			
GN1548A0		4	PZ																																																			
GN1551A1		2	PZ																																																			
GN1559A0		2	PZ																																																			
GN1580A1		6	PZ																																																			
GN1586A1		2	PZ																																																			
GN1551A			KGN1569A	KIT GOMA ANTORCHA GAS	<table border="1"> <thead> <tr> <th>Código</th> <th>Descripción</th> <th>Cant.</th> <th>UdM</th> </tr> </thead> <tbody> <tr> <td>GN1541A0</td> <td></td> <td>2</td> <td>PZ</td> </tr> <tr> <td>GN1542A0</td> <td></td> <td>4</td> <td>PZ</td> </tr> <tr> <td>GN1543A0</td> <td></td> <td>6</td> <td>PZ</td> </tr> <tr> <td>GN1548A0</td> <td></td> <td>4</td> <td>PZ</td> </tr> <tr> <td>GN1551A1</td> <td></td> <td>2</td> <td>PZ</td> </tr> <tr> <td>GN1559A0</td> <td></td> <td>2</td> <td>PZ</td> </tr> <tr> <td>GN1580A1</td> <td></td> <td>6</td> <td>PZ</td> </tr> <tr> <td>GN1586A1</td> <td></td> <td>2</td> <td>PZ</td> </tr> </tbody> </table>	Código	Descripción	Cant.	UdM	GN1541A0		2	PZ	GN1542A0		4	PZ	GN1543A0		6	PZ	GN1548A0		4	PZ	GN1551A1		2	PZ	GN1559A0		2	PZ	GN1580A1		6	PZ	GN1586A1		2	PZ													
Código	Descripción	Cant.	UdM																																																			
GN1541A0		2	PZ																																																			
GN1542A0		4	PZ																																																			
GN1543A0		6	PZ																																																			
GN1548A0		4	PZ																																																			
GN1551A1		2	PZ																																																			
GN1559A0		2	PZ																																																			
GN1580A1		6	PZ																																																			
GN1586A1		2	PZ																																																			

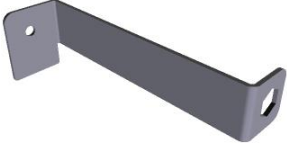
COMPONENTE			REPUESTO																																						
Código	Descripción	Imagen	Código	Descripción	Lista de componentes																																				
GN1586A			KG1569A	KIT GOMA ANTORCHA GAS	<table border="1"> <thead> <tr> <th>Código</th> <th>Descripción</th> <th>Cant.</th> <th>UdM</th> </tr> </thead> <tbody> <tr> <td>GN1541A0</td> <td></td> <td>2</td> <td>PZ</td> </tr> <tr> <td>GN1542A0</td> <td></td> <td>4</td> <td>PZ</td> </tr> <tr> <td>GN1543A0</td> <td></td> <td>6</td> <td>PZ</td> </tr> <tr> <td>GN1548A0</td> <td></td> <td>4</td> <td>PZ</td> </tr> <tr> <td>GN1551A1</td> <td></td> <td>2</td> <td>PZ</td> </tr> <tr> <td>GN1559A0</td> <td></td> <td>2</td> <td>PZ</td> </tr> <tr> <td>GN1580A1</td> <td></td> <td>6</td> <td>PZ</td> </tr> <tr> <td>GN1586A1</td> <td></td> <td>2</td> <td>PZ</td> </tr> </tbody> </table>	Código	Descripción	Cant.	UdM	GN1541A0		2	PZ	GN1542A0		4	PZ	GN1543A0		6	PZ	GN1548A0		4	PZ	GN1551A1		2	PZ	GN1559A0		2	PZ	GN1580A1		6	PZ	GN1586A1		2	PZ
Código	Descripción	Cant.	UdM																																						
GN1541A0		2	PZ																																						
GN1542A0		4	PZ																																						
GN1543A0		6	PZ																																						
GN1548A0		4	PZ																																						
GN1551A1		2	PZ																																						
GN1559A0		2	PZ																																						
GN1580A1		6	PZ																																						
GN1586A1		2	PZ																																						
BR1350A			BR1350A0																																						
0N1420A			0N1420A0																																						
0N1405A			0N1405A0																																						
0N1394A			0N1394A1																																						

COMPONENTE			REPUESTO		
Código	Descripción	Imagen	Código	Descripción	Lista de componentes
TB3067B			TB3067B0		
TR1113A			TR1113A0		
GN1583A			GN1583A0		
ON1421B			ON1421B0		
ON1405A			ON1405A0		

COMPONENTE			REPUESTO																																		
Código	Descripción	Imagen	Código	Descripción	Lista de componentes																																
0N1394A			0N1394A1																																		
0G1606C			0G1606C0																																		
0H7629A			0H7629A0																																		
VL1037A			KVL1037A	KIT SUSTITUCION ROTOR DE LAVADO	<table border="1"> <thead> <tr> <th>Código</th> <th>Descripción</th> <th>Cant.</th> <th>UdM</th> </tr> </thead> <tbody> <tr> <td>GN1416B0</td> <td>BUJE ROTOR SISTEMA DE LAVADO</td> <td>1</td> <td>PZ</td> </tr> <tr> <td>TF1065B0</td> <td>EJE ROTACION ROTOR SISTEMA DE LAVADO</td> <td>1</td> <td>PZ</td> </tr> <tr> <td>TF1066A1</td> <td>BUJE ROTOR LAVADO</td> <td>1</td> <td>PZ</td> </tr> <tr> <td>UG1005B1</td> <td>INYECTOR AGUA CHORRO ANCHO ROTO</td> <td>1</td> <td>PZ</td> </tr> <tr> <td>UG1006B3</td> <td>INYECTOR AGUA ROTOR</td> <td>1</td> <td>PZ</td> </tr> <tr> <td>VI1220A1</td> <td>VITE AUTOFIL. 4.2X12 TCB MARUTEX</td> <td>6</td> <td>PZ</td> </tr> <tr> <td>VM1955C0</td> <td>ROTOR SISTEMA DE LAVADO</td> <td>1</td> <td>PZ</td> </tr> </tbody> </table>	Código	Descripción	Cant.	UdM	GN1416B0	BUJE ROTOR SISTEMA DE LAVADO	1	PZ	TF1065B0	EJE ROTACION ROTOR SISTEMA DE LAVADO	1	PZ	TF1066A1	BUJE ROTOR LAVADO	1	PZ	UG1005B1	INYECTOR AGUA CHORRO ANCHO ROTO	1	PZ	UG1006B3	INYECTOR AGUA ROTOR	1	PZ	VI1220A1	VITE AUTOFIL. 4.2X12 TCB MARUTEX	6	PZ	VM1955C0	ROTOR SISTEMA DE LAVADO	1	PZ
Código	Descripción	Cant.	UdM																																		
GN1416B0	BUJE ROTOR SISTEMA DE LAVADO	1	PZ																																		
TF1065B0	EJE ROTACION ROTOR SISTEMA DE LAVADO	1	PZ																																		
TF1066A1	BUJE ROTOR LAVADO	1	PZ																																		
UG1005B1	INYECTOR AGUA CHORRO ANCHO ROTO	1	PZ																																		
UG1006B3	INYECTOR AGUA ROTOR	1	PZ																																		
VI1220A1	VITE AUTOFIL. 4.2X12 TCB MARUTEX	6	PZ																																		
VM1955C0	ROTOR SISTEMA DE LAVADO	1	PZ																																		

COMPONENTE			REPUESTO														
Código	Descripción	Imagen	Código	Descripción	Lista de componentes												
VL1037A			KVL1037A	KIT SUSTITUCION ROTOR DE LAVADO	<table border="1"> <thead> <tr> <th>Código</th> <th>Descripción</th> <th>Cant.</th> <th>UdM</th> </tr> </thead> <tbody> <tr> <td>VM1985C1</td> <td>TAPA ROTOR SISTEMA DE LAVADO</td> <td>1</td> <td>PZ</td> </tr> <tr> <td>VM1986A0</td> <td>TAPON INYECTOR</td> <td>1</td> <td>PZ</td> </tr> </tbody> </table>	Código	Descripción	Cant.	UdM	VM1985C1	TAPA ROTOR SISTEMA DE LAVADO	1	PZ	VM1986A0	TAPON INYECTOR	1	PZ
Código	Descripción	Cant.	UdM														
VM1985C1	TAPA ROTOR SISTEMA DE LAVADO	1	PZ														
VM1986A0	TAPON INYECTOR	1	PZ														
VM1820A			KVM1820A	KIT 10 TRINCHETES CROMADOS SERIE 5	<table border="1"> <thead> <tr> <th>Código</th> <th>Descripción</th> <th>Cant.</th> <th>UdM</th> </tr> </thead> <tbody> <tr> <td>VM1820A0</td> <td></td> <td>10</td> <td>PZ</td> </tr> </tbody> </table>	Código	Descripción	Cant.	UdM	VM1820A0		10	PZ				
Código	Descripción	Cant.	UdM														
VM1820A0		10	PZ														

ASM4043A/0.D00 - Cobertura exterior

ANVERSO

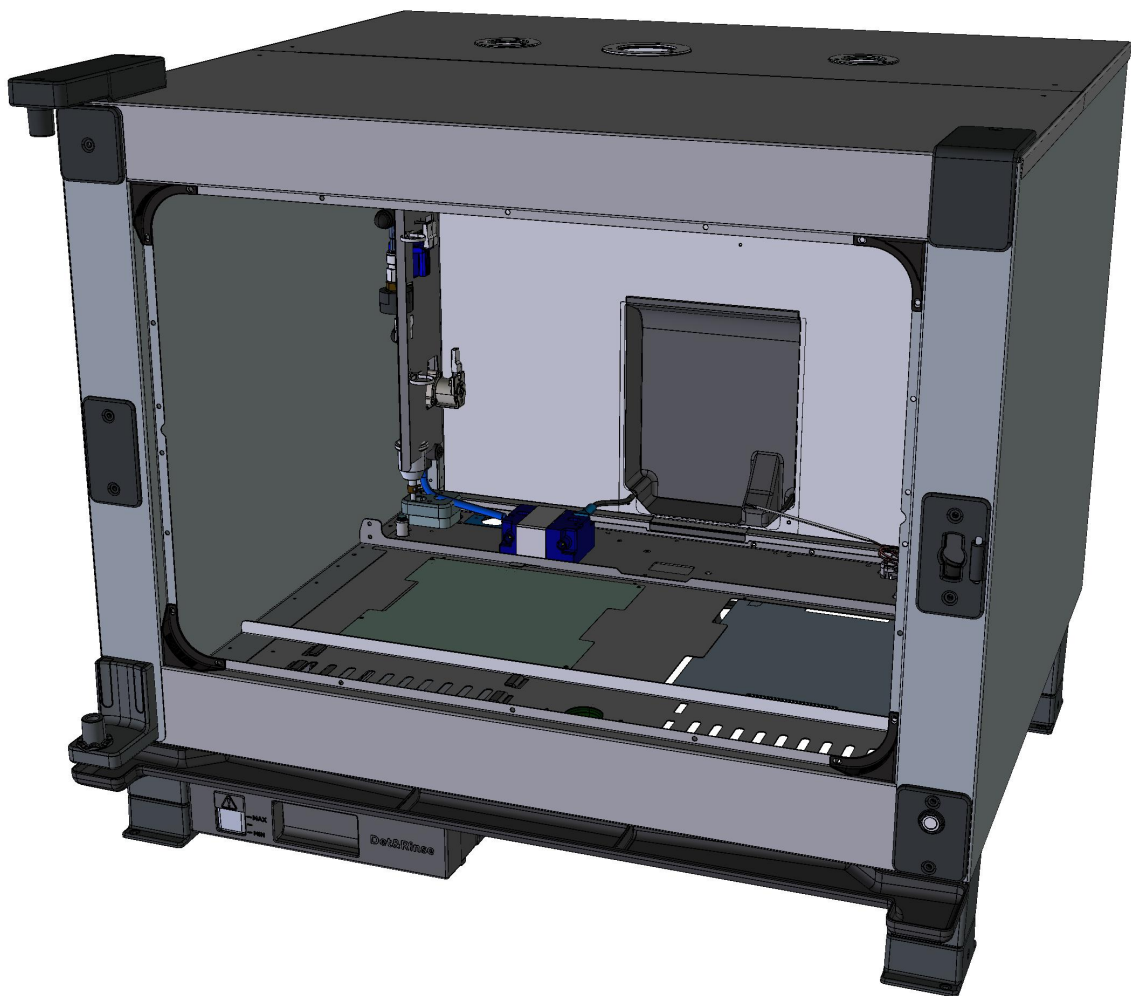

ASM4043A/0.D00 - Cobertura exterior

REVERSO







COMPONENTE			REPUESTO																											
Código	Descripción	Imagen	Código	Descripción	Lista de componentes																									
TR1136A	TERMOSTATO SEGURIDAD 330°C		KTR1136A	KIT TERMOSTATO DE SEGUR. UNIPOL TR1136A	<table border="1"> <thead> <tr> <th>Código</th> <th>Descripción</th> <th>Cant.</th> <th>UdM</th> </tr> </thead> <tbody> <tr> <td>0H7030A0</td> <td>TAPA ENTRADA BULBO</td> <td>1</td> <td>PZ</td> </tr> <tr> <td>GN1531A0</td> <td>GOMA SONDA</td> <td>1</td> <td>PZ</td> </tr> <tr> <td>SL1045A0</td> <td>SILICONA ANTRACITA S53 SP-5007 80ML</td> <td>1</td> <td>PZ</td> </tr> <tr> <td>TR1136A0</td> <td>TERMOSTATO SEGURIDAD 330°C</td> <td>1</td> <td>PZ</td> </tr> <tr> <td>VI1220A1</td> <td>VITE AUTOFIL. 4.2X12 TCB MARUTEX</td> <td>3</td> <td>PZ</td> </tr> </tbody> </table>		Código	Descripción	Cant.	UdM	0H7030A0	TAPA ENTRADA BULBO	1	PZ	GN1531A0	GOMA SONDA	1	PZ	SL1045A0	SILICONA ANTRACITA S53 SP-5007 80ML	1	PZ	TR1136A0	TERMOSTATO SEGURIDAD 330°C	1	PZ	VI1220A1	VITE AUTOFIL. 4.2X12 TCB MARUTEX	3	PZ
Código	Descripción	Cant.	UdM																											
0H7030A0	TAPA ENTRADA BULBO	1	PZ																											
GN1531A0	GOMA SONDA	1	PZ																											
SL1045A0	SILICONA ANTRACITA S53 SP-5007 80ML	1	PZ																											
TR1136A0	TERMOSTATO SEGURIDAD 330°C	1	PZ																											
VI1220A1	VITE AUTOFIL. 4.2X12 TCB MARUTEX	3	PZ																											
VM1750A	PLACA TERMINAL		KVM1750A		<table border="1"> <thead> <tr> <th>Código</th> <th>Descripción</th> <th>Cant.</th> <th>UdM</th> </tr> </thead> <tbody> <tr> <td>VM1750A0</td> <td>PLACA TERMINAL</td> <td>1</td> <td>PZ</td> </tr> </tbody> </table>		Código	Descripción	Cant.	UdM	VM1750A0	PLACA TERMINAL	1	PZ																
Código	Descripción	Cant.	UdM																											
VM1750A0	PLACA TERMINAL	1	PZ																											
VN1165A	TURBINA REFRIGERACION 230V		KVN1165A	KIT TURBINA REFRIGERACION	<table border="1"> <thead> <tr> <th>Código</th> <th>Descripción</th> <th>Cant.</th> <th>UdM</th> </tr> </thead> <tbody> <tr> <td>VI1099A0</td> <td></td> <td>4</td> <td>PZ</td> </tr> <tr> <td>VM1555A2</td> <td>SOPORTE TURBINA REFRIGERACI ON CT BT</td> <td>1</td> <td>PZ</td> </tr> <tr> <td>VN1165A0</td> <td>TURBINA REFRIGERACI ON 230V</td> <td>1</td> <td>PZ</td> </tr> </tbody> </table>		Código	Descripción	Cant.	UdM	VI1099A0		4	PZ	VM1555A2	SOPORTE TURBINA REFRIGERACI ON CT BT	1	PZ	VN1165A0	TURBINA REFRIGERACI ON 230V	1	PZ								
Código	Descripción	Cant.	UdM																											
VI1099A0		4	PZ																											
VM1555A2	SOPORTE TURBINA REFRIGERACI ON CT BT	1	PZ																											
VN1165A0	TURBINA REFRIGERACI ON 230V	1	PZ																											
VM1556A	XBC-XVC COOLING FAN GUARD		KVM1556A		<table border="1"> <thead> <tr> <th>Código</th> <th>Descripción</th> <th>Cant.</th> <th>UdM</th> </tr> </thead> <tbody> <tr> <td>VM1556A0</td> <td>XBC-XVC COOLING FAN GUARD</td> <td>1</td> <td>PZ</td> </tr> </tbody> </table>		Código	Descripción	Cant.	UdM	VM1556A0	XBC-XVC COOLING FAN GUARD	1	PZ																
Código	Descripción	Cant.	UdM																											
VM1556A0	XBC-XVC COOLING FAN GUARD	1	PZ																											



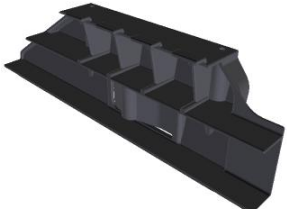

COMPONENTE			REPUESTO																		
Código	Descripción	Imagen	Código	Descripción	Lista de componentes																
VM1555A	SOPORTE TURBINA REFRIGERACION CT BT		KVN1165A	KIT TURBINA REFRIGERACION	<table border="1"> <thead> <tr> <th>Código</th> <th>Descripción</th> <th>Cant.</th> <th>UdM</th> </tr> </thead> <tbody> <tr> <td>VI1099A0</td> <td></td> <td>4</td> <td>PZ</td> </tr> <tr> <td>VM1555A2</td> <td>SOPORTE TURBINA REFRIGERACI ON CT BT</td> <td>1</td> <td>PZ</td> </tr> <tr> <td>VN1165A0</td> <td>TURBINA REFRIGERACI ON 230V</td> <td>1</td> <td>PZ</td> </tr> </tbody> </table>	Código	Descripción	Cant.	UdM	VI1099A0		4	PZ	VM1555A2	SOPORTE TURBINA REFRIGERACI ON CT BT	1	PZ	VN1165A0	TURBINA REFRIGERACI ON 230V	1	PZ
			Código	Descripción	Cant.	UdM															
VI1099A0		4	PZ																		
VM1555A2	SOPORTE TURBINA REFRIGERACI ON CT BT	1	PZ																		
VN1165A0	TURBINA REFRIGERACI ON 230V	1	PZ																		
KVN1164A	KIT TURBINA DE REFRIGERACION	<table border="1"> <thead> <tr> <th>Código</th> <th>Descripción</th> <th>Cant.</th> <th>UdM</th> </tr> </thead> <tbody> <tr> <td>VI1099A0</td> <td></td> <td>4</td> <td>PZ</td> </tr> <tr> <td>VM1555A2</td> <td>SOPORTE TURBINA REFRIGERACI ON CT BT</td> <td>1</td> <td>PZ</td> </tr> <tr> <td>VN1164A0</td> <td>TURBINA DE REFRIGERACI ON 12VDC</td> <td>1</td> <td>PZ</td> </tr> </tbody> </table>	Código	Descripción	Cant.	UdM	VI1099A0		4	PZ	VM1555A2	SOPORTE TURBINA REFRIGERACI ON CT BT	1	PZ	VN1164A0	TURBINA DE REFRIGERACI ON 12VDC	1	PZ			
Código	Descripción	Cant.	UdM																		
VI1099A0		4	PZ																		
VM1555A2	SOPORTE TURBINA REFRIGERACI ON CT BT	1	PZ																		
VN1164A0	TURBINA DE REFRIGERACI ON 12VDC	1	PZ																		
0H1019A			K0H1019A		<table border="1"> <thead> <tr> <th>Código</th> <th>Descripción</th> <th>Cant.</th> <th>UdM</th> </tr> </thead> <tbody> <tr> <td>0H1019A1</td> <td></td> <td>1</td> <td>PZ</td> </tr> <tr> <td>VI1737A0</td> <td></td> <td>2</td> <td>PZ</td> </tr> <tr> <td>VM1106A0</td> <td></td> <td>2</td> <td>PZ</td> </tr> </tbody> </table>	Código	Descripción	Cant.	UdM	0H1019A1		1	PZ	VI1737A0		2	PZ	VM1106A0		2	PZ
Código	Descripción	Cant.	UdM																		
0H1019A1		1	PZ																		
VI1737A0		2	PZ																		
VM1106A0		2	PZ																		
PD1074A																					
PD1075A																					

COMPONENTE			REPUESTO																		
Código	Descripción	Imagen	Código	Descripción	Lista de componentes																
VL1026A			KVL1026A	KIT CURVA PARA TUBO DE DESAGUE	<table border="1"> <thead> <tr> <th>Código</th> <th>Descripción</th> <th>Cant.</th> <th>UdM</th> </tr> </thead> <tbody> <tr> <td>GN1400A0</td> <td></td> <td>1</td> <td>PZ</td> </tr> <tr> <td>VL1026A0</td> <td></td> <td>1</td> <td>PZ</td> </tr> <tr> <td>VM2039A0</td> <td></td> <td>1</td> <td>PZ</td> </tr> </tbody> </table>	Código	Descripción	Cant.	UdM	GN1400A0		1	PZ	VL1026A0		1	PZ	VM2039A0		1	PZ
Código	Descripción	Cant.	UdM																		
GN1400A0		1	PZ																		
VL1026A0		1	PZ																		
VM2039A0		1	PZ																		
VM2039A			KVL1026A	KIT CURVA PARA TUBO DE DESAGUE	<table border="1"> <thead> <tr> <th>Código</th> <th>Descripción</th> <th>Cant.</th> <th>UdM</th> </tr> </thead> <tbody> <tr> <td>GN1400A0</td> <td></td> <td>1</td> <td>PZ</td> </tr> <tr> <td>VL1026A0</td> <td></td> <td>1</td> <td>PZ</td> </tr> <tr> <td>VM2039A0</td> <td></td> <td>1</td> <td>PZ</td> </tr> </tbody> </table>	Código	Descripción	Cant.	UdM	GN1400A0		1	PZ	VL1026A0		1	PZ	VM2039A0		1	PZ
Código	Descripción	Cant.	UdM																		
GN1400A0		1	PZ																		
VL1026A0		1	PZ																		
VM2039A0		1	PZ																		
0H2561A			0H2561A0																		
VM1240A			VM1240A0																		
VM2310A			VM2310A0																		

COMPONENTE			REPUESTO										
Código	Descripción	Imagen	Código	Descripción	Lista de componentes								
VM2306A			VM2306A0										
VM2307A			VM2307A0										
RC1006A			KRC1006A		<table border="1"> <thead> <tr> <th>Código</th> <th>Descripción</th> <th>Cant.</th> <th>UdM</th> </tr> </thead> <tbody> <tr> <td>RC1006A0</td> <td></td> <td>20</td> <td>PZ</td> </tr> </tbody> </table>	Código	Descripción	Cant.	UdM	RC1006A0		20	PZ
Código	Descripción	Cant.	UdM										
RC1006A0		20	PZ										
VM1810A			VM1810A0										
GN1558A			GN1558A0										



COMPONENTE			REPUESTO																																																																						
Código	Descripción	Imagen	Código	Descripción	Lista de componentes																																																																				
0H7291A			0H7291A0																																																																						
VM1118A			KVM1118A	KIT GUIA IZQUIERDA TANQUE DET&RINSE PLUS	<table border="1"> <thead> <tr> <th>Código</th> <th>Descripción</th> <th>Cant.</th> <th>UdM</th> </tr> </thead> <tbody> <tr> <td>VI1220A1</td> <td>VITE AUTOFIL. 4.2X12 TCB MARUTEX</td> <td>2</td> <td>PZ</td> </tr> <tr> <td>VM1118A0</td> <td></td> <td>1</td> <td>PZ</td> </tr> </tbody> </table>	Código	Descripción	Cant.	UdM	VI1220A1	VITE AUTOFIL. 4.2X12 TCB MARUTEX	2	PZ	VM1118A0		1	PZ																																																								
Código	Descripción	Cant.	UdM																																																																						
VI1220A1	VITE AUTOFIL. 4.2X12 TCB MARUTEX	2	PZ																																																																						
VM1118A0		1	PZ																																																																						
VM1119A			KVM1119A	KIT GUIA DERECHA TANQUE DET&RINSE PLUS	<table border="1"> <thead> <tr> <th>Código</th> <th>Descripción</th> <th>Cant.</th> <th>UdM</th> </tr> </thead> <tbody> <tr> <td>VI1220A1</td> <td>VITE AUTOFIL. 4.2X12 TCB MARUTEX</td> <td>2</td> <td>PZ</td> </tr> <tr> <td>VM1119A0</td> <td></td> <td>1</td> <td>PZ</td> </tr> </tbody> </table>	Código	Descripción	Cant.	UdM	VI1220A1	VITE AUTOFIL. 4.2X12 TCB MARUTEX	2	PZ	VM1119A0		1	PZ																																																								
Código	Descripción	Cant.	UdM																																																																						
VI1220A1	VITE AUTOFIL. 4.2X12 TCB MARUTEX	2	PZ																																																																						
VM1119A0		1	PZ																																																																						
SB1015A			XUC060	KIT SOPORTE DETERGENTE PARA FERMENTADORA	<table border="1"> <thead> <tr> <th>Código</th> <th>Descripción</th> <th>Cant.</th> <th>UdM</th> </tr> </thead> <tbody> <tr> <td>0H7558B0</td> <td></td> <td>1</td> <td>PZ</td> </tr> <tr> <td>0H7559B0</td> <td></td> <td>2</td> <td>PZ</td> </tr> <tr> <td>CE1016A0</td> <td></td> <td>2</td> <td>PZ</td> </tr> <tr> <td>CE1630A1</td> <td></td> <td>0.680</td> <td>M</td> </tr> <tr> <td>EL1220A0</td> <td>RACOR DERECHO Ø8 - Ø8</td> <td>1</td> <td>PZ</td> </tr> <tr> <td>IP1385A1</td> <td></td> <td>3.520</td> <td>M</td> </tr> <tr> <td>RC1019A0</td> <td></td> <td>2</td> <td>PZ</td> </tr> <tr> <td>SB1015A1</td> <td></td> <td>1</td> <td>PZ</td> </tr> <tr> <td>TB2820A0</td> <td>TUBO EPDM 6X10</td> <td>2</td> <td>M</td> </tr> <tr> <td>VI1220A1</td> <td>VITE AUTOFIL. 4.2X12 TCB MARUTEX</td> <td>9</td> <td>PZ</td> </tr> <tr> <td>VI1225A0</td> <td></td> <td>8</td> <td>PZ</td> </tr> <tr> <td>VI1950A0</td> <td></td> <td>4</td> <td>PZ</td> </tr> <tr> <td>VL1047A1</td> <td>SOPORTE TUBO D6 - D8 EXTREMO J.G.</td> <td>2</td> <td>PZ</td> </tr> <tr> <td>VM1059A1</td> <td></td> <td>2</td> <td>M</td> </tr> <tr> <td>VM1197A0</td> <td></td> <td>2</td> <td>PZ</td> </tr> <tr> <td>VM1198A0</td> <td></td> <td>8</td> <td>PZ</td> </tr> </tbody> </table>	Código	Descripción	Cant.	UdM	0H7558B0		1	PZ	0H7559B0		2	PZ	CE1016A0		2	PZ	CE1630A1		0.680	M	EL1220A0	RACOR DERECHO Ø8 - Ø8	1	PZ	IP1385A1		3.520	M	RC1019A0		2	PZ	SB1015A1		1	PZ	TB2820A0	TUBO EPDM 6X10	2	M	VI1220A1	VITE AUTOFIL. 4.2X12 TCB MARUTEX	9	PZ	VI1225A0		8	PZ	VI1950A0		4	PZ	VL1047A1	SOPORTE TUBO D6 - D8 EXTREMO J.G.	2	PZ	VM1059A1		2	M	VM1197A0		2	PZ	VM1198A0		8	PZ
Código	Descripción	Cant.	UdM																																																																						
0H7558B0		1	PZ																																																																						
0H7559B0		2	PZ																																																																						
CE1016A0		2	PZ																																																																						
CE1630A1		0.680	M																																																																						
EL1220A0	RACOR DERECHO Ø8 - Ø8	1	PZ																																																																						
IP1385A1		3.520	M																																																																						
RC1019A0		2	PZ																																																																						
SB1015A1		1	PZ																																																																						
TB2820A0	TUBO EPDM 6X10	2	M																																																																						
VI1220A1	VITE AUTOFIL. 4.2X12 TCB MARUTEX	9	PZ																																																																						
VI1225A0		8	PZ																																																																						
VI1950A0		4	PZ																																																																						
VL1047A1	SOPORTE TUBO D6 - D8 EXTREMO J.G.	2	PZ																																																																						
VM1059A1		2	M																																																																						
VM1197A0		2	PZ																																																																						
VM1198A0		8	PZ																																																																						

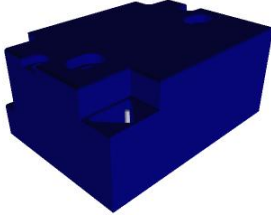

COMPONENTE			REPUESTO																						
Código	Descripción	Imagen	Código	Descripción	Lista de componentes																				
SB1015A			KSB1015A		<table border="1"> <thead> <tr> <th>Código</th> <th>Descripción</th> <th>Cant.</th> <th>UdM</th> </tr> </thead> <tbody> <tr> <td>IP1385A1</td> <td></td> <td>1.200</td> <td>M</td> </tr> <tr> <td>IP1410A0</td> <td></td> <td>2</td> <td>PZ</td> </tr> <tr> <td>SB1015A1</td> <td></td> <td>1</td> <td>PZ</td> </tr> <tr> <td>VM1059A1</td> <td></td> <td>1.200</td> <td>M</td> </tr> </tbody> </table>	Código	Descripción	Cant.	UdM	IP1385A1		1.200	M	IP1410A0		2	PZ	SB1015A1		1	PZ	VM1059A1		1.200	M
Código	Descripción	Cant.	UdM																						
IP1385A1		1.200	M																						
IP1410A0		2	PZ																						
SB1015A1		1	PZ																						
VM1059A1		1.200	M																						
PD1074A																									
PD1075A																									
OH2561A			OH2561A0																						
VM1240A			VM1240A0																						

COMPONENTE			REPUESTO														
Código	Descripción	Imagen	Código	Descripción	Lista de componentes												
VM2282A			VM2282A0														
VE1020B	ES-MICROINTERRUPTORE PORTA MAGNETICO		KVE1020B	KIT MICROPUERTA	<table border="1"> <thead> <tr> <th>Código</th> <th>Descripción</th> <th>Cant.</th> <th>UdM</th> </tr> </thead> <tbody> <tr> <td>VE1020B0</td> <td>ES-MICROINTERRUPTORE PORTA MAGNETICO</td> <td>1</td> <td>PZ</td> </tr> <tr> <td>VE1030A1</td> <td>IMAN D=22,9MM PARA MICROPUERTA</td> <td>1</td> <td>PZ</td> </tr> </tbody> </table>	Código	Descripción	Cant.	UdM	VE1020B0	ES-MICROINTERRUPTORE PORTA MAGNETICO	1	PZ	VE1030A1	IMAN D=22,9MM PARA MICROPUERTA	1	PZ
Código	Descripción	Cant.	UdM														
VE1020B0	ES-MICROINTERRUPTORE PORTA MAGNETICO	1	PZ														
VE1030A1	IMAN D=22,9MM PARA MICROPUERTA	1	PZ														
0H7458A			0H7458A0														
0H7473A			0H7473A0														
GN1579A			GN1579A0														



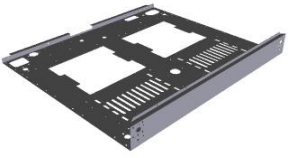

COMPONENTE			REPUESTO																																																																		
Código	Descripción	Imagen	Código	Descripción	Lista de componentes																																																																
0H7459A			0H7459A0																																																																		
VE1625A	ENCENDEDOR S5E		KVE0009B	KIT ENCENDEDOR CON CONEXION AL SUELO	<table border="1"> <thead> <tr> <th>Código</th> <th>Descripción</th> <th>Cant.</th> <th>UdM</th> </tr> </thead> <tbody> <tr> <td>0H5126A0</td> <td>OMEGA FIJACIÓN ENCENDEDOR</td> <td>1</td> <td>PZ</td> </tr> <tr> <td>0H6825A0</td> <td>ABRAZADERA DE METAL</td> <td>1</td> <td>PZ</td> </tr> <tr> <td>CE1390A0</td> <td>CABLE UNIP.AMARRIL LO GOMA.SIL Ø 0.75 MMQ</td> <td>0.260</td> <td>M</td> </tr> <tr> <td>CE1395A0</td> <td></td> <td>4</td> <td>PZ</td> </tr> <tr> <td>CE1661A0</td> <td></td> <td>4</td> <td>PZ</td> </tr> <tr> <td>CE1777A0</td> <td></td> <td>2</td> <td>PZ</td> </tr> <tr> <td>CE1777A1</td> <td>CABLE ENCENDIDO HV L=700 CAPUCHON SILCON</td> <td>2</td> <td>PZ</td> </tr> <tr> <td>CE1782A0</td> <td>CABLE FIDA PUENTA HV L=300</td> <td>1</td> <td>PZ</td> </tr> <tr> <td>CE1792A0</td> <td>CABLE BUJIA DETECTOR DE LLAMA</td> <td>1</td> <td>PZ</td> </tr> <tr> <td>CE1811A1</td> <td>CABLE ALIMENTACIO N ENCENDEDOR 90°</td> <td>1</td> <td>PZ</td> </tr> <tr> <td>GN1328A1</td> <td>GOMA NEGRA TRASERA ADHESIVA 8X3</td> <td>0.500</td> <td>M</td> </tr> <tr> <td>VE1625A0</td> <td>ENCENDEDOR S5E</td> <td>1</td> <td>PZ</td> </tr> <tr> <td>VI1220A1</td> <td>VITE AUTOFIL. 4.2X12 TCB MARUTEX</td> <td>2</td> <td>PZ</td> </tr> <tr> <td>VI1950A0</td> <td></td> <td>1</td> <td>PZ</td> </tr> <tr> <td>VM1255A1</td> <td>TAPON CIERRE MARUTEX</td> <td>1</td> <td>PZ</td> </tr> </tbody> </table>	Código	Descripción	Cant.	UdM	0H5126A0	OMEGA FIJACIÓN ENCENDEDOR	1	PZ	0H6825A0	ABRAZADERA DE METAL	1	PZ	CE1390A0	CABLE UNIP.AMARRIL LO GOMA.SIL Ø 0.75 MMQ	0.260	M	CE1395A0		4	PZ	CE1661A0		4	PZ	CE1777A0		2	PZ	CE1777A1	CABLE ENCENDIDO HV L=700 CAPUCHON SILCON	2	PZ	CE1782A0	CABLE FIDA PUENTA HV L=300	1	PZ	CE1792A0	CABLE BUJIA DETECTOR DE LLAMA	1	PZ	CE1811A1	CABLE ALIMENTACIO N ENCENDEDOR 90°	1	PZ	GN1328A1	GOMA NEGRA TRASERA ADHESIVA 8X3	0.500	M	VE1625A0	ENCENDEDOR S5E	1	PZ	VI1220A1	VITE AUTOFIL. 4.2X12 TCB MARUTEX	2	PZ	VI1950A0		1	PZ	VM1255A1	TAPON CIERRE MARUTEX	1	PZ
Código	Descripción	Cant.	UdM																																																																		
0H5126A0	OMEGA FIJACIÓN ENCENDEDOR	1	PZ																																																																		
0H6825A0	ABRAZADERA DE METAL	1	PZ																																																																		
CE1390A0	CABLE UNIP.AMARRIL LO GOMA.SIL Ø 0.75 MMQ	0.260	M																																																																		
CE1395A0		4	PZ																																																																		
CE1661A0		4	PZ																																																																		
CE1777A0		2	PZ																																																																		
CE1777A1	CABLE ENCENDIDO HV L=700 CAPUCHON SILCON	2	PZ																																																																		
CE1782A0	CABLE FIDA PUENTA HV L=300	1	PZ																																																																		
CE1792A0	CABLE BUJIA DETECTOR DE LLAMA	1	PZ																																																																		
CE1811A1	CABLE ALIMENTACIO N ENCENDEDOR 90°	1	PZ																																																																		
GN1328A1	GOMA NEGRA TRASERA ADHESIVA 8X3	0.500	M																																																																		
VE1625A0	ENCENDEDOR S5E	1	PZ																																																																		
VI1220A1	VITE AUTOFIL. 4.2X12 TCB MARUTEX	2	PZ																																																																		
VI1950A0		1	PZ																																																																		
VM1255A1	TAPON CIERRE MARUTEX	1	PZ																																																																		



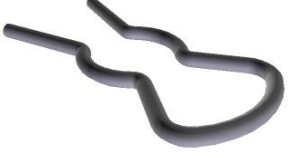
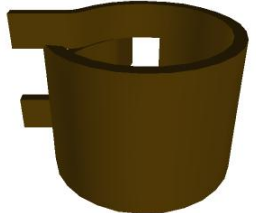

COMPONENTE			REPUESTO																										
Código	Descripción	Imagen	Código	Descripción	Lista de componentes																								
0H7493A			0H7493A0																										
VM1190A			KVM1190A	KIT CIERRE MANETA DCHA/IZDA CT BT	<table border="1"> <thead> <tr> <th>Código</th> <th>Descripción</th> <th>Cant.</th> <th>UdM</th> </tr> </thead> <tbody> <tr> <td>VI0239A1</td> <td></td> <td>2</td> <td>PZ</td> </tr> <tr> <td>VI1220A1</td> <td>VITE AUTOFIL. 4.2X12 TCB MARUTEX</td> <td>2</td> <td>PZ</td> </tr> <tr> <td>VM1190A2</td> <td></td> <td>1</td> <td>PZ</td> </tr> <tr> <td>VM1192A1</td> <td></td> <td>1</td> <td>PZ</td> </tr> <tr> <td>VM1460A0</td> <td></td> <td>1</td> <td>PZ</td> </tr> </tbody> </table>	Código	Descripción	Cant.	UdM	VI0239A1		2	PZ	VI1220A1	VITE AUTOFIL. 4.2X12 TCB MARUTEX	2	PZ	VM1190A2		1	PZ	VM1192A1		1	PZ	VM1460A0		1	PZ
Código	Descripción	Cant.	UdM																										
VI0239A1		2	PZ																										
VI1220A1	VITE AUTOFIL. 4.2X12 TCB MARUTEX	2	PZ																										
VM1190A2		1	PZ																										
VM1192A1		1	PZ																										
VM1460A0		1	PZ																										
VM2280A			KVM2280A	KIT PLAQUETA TAPA CIERRE VM2280A	<table border="1"> <thead> <tr> <th>Código</th> <th>Descripción</th> <th>Cant.</th> <th>UdM</th> </tr> </thead> <tbody> <tr> <td>VM2280A0</td> <td></td> <td>1</td> <td>PZ</td> </tr> </tbody> </table>	Código	Descripción	Cant.	UdM	VM2280A0		1	PZ																
Código	Descripción	Cant.	UdM																										
VM2280A0		1	PZ																										
VM1192A			KVM1191A	KIT CIERRE MANETA IZDA CT BT (PARTE FIJA	<table border="1"> <thead> <tr> <th>Código</th> <th>Descripción</th> <th>Cant.</th> <th>UdM</th> </tr> </thead> <tbody> <tr> <td>VI0239A1</td> <td></td> <td>2</td> <td>PZ</td> </tr> <tr> <td>VI1220A1</td> <td>VITE AUTOFIL. 4.2X12 TCB MARUTEX</td> <td>2</td> <td>PZ</td> </tr> <tr> <td>VM1191A2</td> <td></td> <td>1</td> <td>PZ</td> </tr> <tr> <td>VM1192A1</td> <td></td> <td>1</td> <td>PZ</td> </tr> <tr> <td>VM1460A0</td> <td></td> <td>1</td> <td>PZ</td> </tr> </tbody> </table>	Código	Descripción	Cant.	UdM	VI0239A1		2	PZ	VI1220A1	VITE AUTOFIL. 4.2X12 TCB MARUTEX	2	PZ	VM1191A2		1	PZ	VM1192A1		1	PZ	VM1460A0		1	PZ
Código	Descripción	Cant.	UdM																										
VI0239A1		2	PZ																										
VI1220A1	VITE AUTOFIL. 4.2X12 TCB MARUTEX	2	PZ																										
VM1191A2		1	PZ																										
VM1192A1		1	PZ																										
VM1460A0		1	PZ																										
			KVM1190A	KIT CIERRE MANETA DCHA/IZDA CT BT	<table border="1"> <thead> <tr> <th>Código</th> <th>Descripción</th> <th>Cant.</th> <th>UdM</th> </tr> </thead> <tbody> <tr> <td>VI0239A1</td> <td></td> <td>2</td> <td>PZ</td> </tr> <tr> <td>VI1220A1</td> <td>VITE AUTOFIL. 4.2X12 TCB MARUTEX</td> <td>2</td> <td>PZ</td> </tr> <tr> <td>VM1190A2</td> <td></td> <td>1</td> <td>PZ</td> </tr> <tr> <td>VM1192A1</td> <td></td> <td>1</td> <td>PZ</td> </tr> <tr> <td>VM1460A0</td> <td></td> <td>1</td> <td>PZ</td> </tr> </tbody> </table>	Código	Descripción	Cant.	UdM	VI0239A1		2	PZ	VI1220A1	VITE AUTOFIL. 4.2X12 TCB MARUTEX	2	PZ	VM1190A2		1	PZ	VM1192A1		1	PZ	VM1460A0		1	PZ
Código	Descripción	Cant.	UdM																										
VI0239A1		2	PZ																										
VI1220A1	VITE AUTOFIL. 4.2X12 TCB MARUTEX	2	PZ																										
VM1190A2		1	PZ																										
VM1192A1		1	PZ																										
VM1460A0		1	PZ																										





COMPONENTE			REPUESTO																										
Código	Descripción	Imagen	Código	Descripción	Lista de componentes																								
VM2281A			VM2281A0																										
VM1192A			KVM1191A	KIT CIERRE MANETA IZDA CT BT (PARTE FIJA	<table border="1"> <thead> <tr> <th>Código</th> <th>Descripción</th> <th>Cant.</th> <th>UdM</th> </tr> </thead> <tbody> <tr> <td>VI0239A1</td> <td></td> <td>2</td> <td>PZ</td> </tr> <tr> <td>VI1220A1</td> <td>VITE AUTOFIL. 4.2X12 TCB MARUTEX</td> <td>2</td> <td>PZ</td> </tr> <tr> <td>VM1191A2</td> <td></td> <td>1</td> <td>PZ</td> </tr> <tr> <td>VM1192A1</td> <td></td> <td>1</td> <td>PZ</td> </tr> <tr> <td>VM1460A0</td> <td></td> <td>1</td> <td>PZ</td> </tr> </tbody> </table>	Código	Descripción	Cant.	UdM	VI0239A1		2	PZ	VI1220A1	VITE AUTOFIL. 4.2X12 TCB MARUTEX	2	PZ	VM1191A2		1	PZ	VM1192A1		1	PZ	VM1460A0		1	PZ
Código	Descripción	Cant.	UdM																										
VI0239A1		2	PZ																										
VI1220A1	VITE AUTOFIL. 4.2X12 TCB MARUTEX	2	PZ																										
VM1191A2		1	PZ																										
VM1192A1		1	PZ																										
VM1460A0		1	PZ																										
			KVM1190A	KIT CIERRE MANETA DCHA/IZDA CT BT	<table border="1"> <thead> <tr> <th>Código</th> <th>Descripción</th> <th>Cant.</th> <th>UdM</th> </tr> </thead> <tbody> <tr> <td>VI0239A1</td> <td></td> <td>2</td> <td>PZ</td> </tr> <tr> <td>VI1220A1</td> <td>VITE AUTOFIL. 4.2X12 TCB MARUTEX</td> <td>2</td> <td>PZ</td> </tr> <tr> <td>VM1190A2</td> <td></td> <td>1</td> <td>PZ</td> </tr> <tr> <td>VM1192A1</td> <td></td> <td>1</td> <td>PZ</td> </tr> <tr> <td>VM1460A0</td> <td></td> <td>1</td> <td>PZ</td> </tr> </tbody> </table>	Código	Descripción	Cant.	UdM	VI0239A1		2	PZ	VI1220A1	VITE AUTOFIL. 4.2X12 TCB MARUTEX	2	PZ	VM1190A2		1	PZ	VM1192A1		1	PZ	VM1460A0		1	PZ
Código	Descripción	Cant.	UdM																										
VI0239A1		2	PZ																										
VI1220A1	VITE AUTOFIL. 4.2X12 TCB MARUTEX	2	PZ																										
VM1190A2		1	PZ																										
VM1192A1		1	PZ																										
VM1460A0		1	PZ																										
VM1191A			KVM1191A	KIT CIERRE MANETA IZDA CT BT (PARTE FIJA	<table border="1"> <thead> <tr> <th>Código</th> <th>Descripción</th> <th>Cant.</th> <th>UdM</th> </tr> </thead> <tbody> <tr> <td>VI0239A1</td> <td></td> <td>2</td> <td>PZ</td> </tr> <tr> <td>VI1220A1</td> <td>VITE AUTOFIL. 4.2X12 TCB MARUTEX</td> <td>2</td> <td>PZ</td> </tr> <tr> <td>VM1191A2</td> <td></td> <td>1</td> <td>PZ</td> </tr> <tr> <td>VM1192A1</td> <td></td> <td>1</td> <td>PZ</td> </tr> <tr> <td>VM1460A0</td> <td></td> <td>1</td> <td>PZ</td> </tr> </tbody> </table>	Código	Descripción	Cant.	UdM	VI0239A1		2	PZ	VI1220A1	VITE AUTOFIL. 4.2X12 TCB MARUTEX	2	PZ	VM1191A2		1	PZ	VM1192A1		1	PZ	VM1460A0		1	PZ
Código	Descripción	Cant.	UdM																										
VI0239A1		2	PZ																										
VI1220A1	VITE AUTOFIL. 4.2X12 TCB MARUTEX	2	PZ																										
VM1191A2		1	PZ																										
VM1192A1		1	PZ																										
VM1460A0		1	PZ																										
0E1364B			0E1364B0																										

COMPONENTE			REPUESTO																																																																																										
Código	Descripción	Imagen	Código	Descripción	Lista de componentes																																																																																								
VL1067A			KVL1073A	KIT BOMBA LAVADO MIND.MAPS PLUS	<table border="1"> <thead> <tr> <th>Código</th> <th>Descripción</th> <th>Cant.</th> <th>UdM</th> </tr> </thead> <tbody> <tr><td>GN1526A0</td><td></td><td>1</td><td>PZ</td></tr> <tr><td>RC1019A0</td><td></td><td>4</td><td>PZ</td></tr> <tr><td>RC1130A0</td><td></td><td>1</td><td>PZ</td></tr> <tr><td>RC1242A0</td><td></td><td>2</td><td>PZ</td></tr> <tr><td>TB2820A0</td><td>TUBO EPDM 6X10</td><td>0.120</td><td>M</td></tr> <tr><td>VL1019A0</td><td></td><td>1</td><td>PZ</td></tr> <tr><td>VL1064A0</td><td></td><td>1</td><td>PZ</td></tr> <tr><td>VL1067A0</td><td></td><td>1</td><td>PZ</td></tr> <tr><td>VL1081A0</td><td></td><td>1</td><td>PZ</td></tr> <tr><td>VM2172A0</td><td></td><td>1</td><td>PZ</td></tr> </tbody> </table>	Código	Descripción	Cant.	UdM	GN1526A0		1	PZ	RC1019A0		4	PZ	RC1130A0		1	PZ	RC1242A0		2	PZ	TB2820A0	TUBO EPDM 6X10	0.120	M	VL1019A0		1	PZ	VL1064A0		1	PZ	VL1067A0		1	PZ	VL1081A0		1	PZ	VM2172A0		1	PZ																																												
Código	Descripción	Cant.	UdM																																																																																										
GN1526A0		1	PZ																																																																																										
RC1019A0		4	PZ																																																																																										
RC1130A0		1	PZ																																																																																										
RC1242A0		2	PZ																																																																																										
TB2820A0	TUBO EPDM 6X10	0.120	M																																																																																										
VL1019A0		1	PZ																																																																																										
VL1064A0		1	PZ																																																																																										
VL1067A0		1	PZ																																																																																										
VL1081A0		1	PZ																																																																																										
VM2172A0		1	PZ																																																																																										
VL1019A			KVL1101A	KIT SISTEMA LAVADO PLUS EU	<table border="1"> <thead> <tr> <th>Código</th> <th>Descripción</th> <th>Cant.</th> <th>UdM</th> </tr> </thead> <tbody> <tr><td>0H7323A0</td><td></td><td>1</td><td>PZ</td></tr> <tr><td>EL1252A1</td><td>ELECTROVAL VULA 1 VIA + CONEXION J.G</td><td>1</td><td>PZ</td></tr> <tr><td>EL1424A0</td><td></td><td>1</td><td>PZ</td></tr> <tr><td>EL1436A0</td><td></td><td>1</td><td>PZ</td></tr> <tr><td>GN1526A0</td><td></td><td>1</td><td>PZ</td></tr> <tr><td>RC1019A0</td><td></td><td>11</td><td>PZ</td></tr> <tr><td>RC1130A0</td><td></td><td>1</td><td>PZ</td></tr> <tr><td>RC1242A0</td><td></td><td>2</td><td>PZ</td></tr> <tr><td>RC1310A0</td><td></td><td>2</td><td>PZ</td></tr> <tr><td>RC1356A0</td><td></td><td>1</td><td>PZ</td></tr> <tr><td>TB1818A0</td><td></td><td>0.220</td><td>M</td></tr> <tr><td>TB2820A0</td><td>TUBO EPDM 6X10</td><td>1.240</td><td>M</td></tr> <tr><td>VH1220A1</td><td>VITE AUTOFIL. 4.2X12 TCB MARUTEX</td><td>2</td><td>PZ</td></tr> <tr><td>VL1019A0</td><td></td><td>1</td><td>PZ</td></tr> <tr><td>VL1064A0</td><td></td><td>1</td><td>PZ</td></tr> <tr><td>VL1065A1</td><td></td><td>1</td><td>PZ</td></tr> <tr><td>VL1067A0</td><td></td><td>1</td><td>PZ</td></tr> <tr><td>VL1080A0</td><td></td><td>1</td><td>PZ</td></tr> <tr><td>VL1081A0</td><td></td><td>2</td><td>PZ</td></tr> <tr><td>VL1083A0</td><td></td><td>1</td><td>PZ</td></tr> <tr><td>VM2172A0</td><td></td><td>1</td><td>PZ</td></tr> </tbody> </table>	Código	Descripción	Cant.	UdM	0H7323A0		1	PZ	EL1252A1	ELECTROVAL VULA 1 VIA + CONEXION J.G	1	PZ	EL1424A0		1	PZ	EL1436A0		1	PZ	GN1526A0		1	PZ	RC1019A0		11	PZ	RC1130A0		1	PZ	RC1242A0		2	PZ	RC1310A0		2	PZ	RC1356A0		1	PZ	TB1818A0		0.220	M	TB2820A0	TUBO EPDM 6X10	1.240	M	VH1220A1	VITE AUTOFIL. 4.2X12 TCB MARUTEX	2	PZ	VL1019A0		1	PZ	VL1064A0		1	PZ	VL1065A1		1	PZ	VL1067A0		1	PZ	VL1080A0		1	PZ	VL1081A0		2	PZ	VL1083A0		1	PZ	VM2172A0		1	PZ
Código	Descripción	Cant.	UdM																																																																																										
0H7323A0		1	PZ																																																																																										
EL1252A1	ELECTROVAL VULA 1 VIA + CONEXION J.G	1	PZ																																																																																										
EL1424A0		1	PZ																																																																																										
EL1436A0		1	PZ																																																																																										
GN1526A0		1	PZ																																																																																										
RC1019A0		11	PZ																																																																																										
RC1130A0		1	PZ																																																																																										
RC1242A0		2	PZ																																																																																										
RC1310A0		2	PZ																																																																																										
RC1356A0		1	PZ																																																																																										
TB1818A0		0.220	M																																																																																										
TB2820A0	TUBO EPDM 6X10	1.240	M																																																																																										
VH1220A1	VITE AUTOFIL. 4.2X12 TCB MARUTEX	2	PZ																																																																																										
VL1019A0		1	PZ																																																																																										
VL1064A0		1	PZ																																																																																										
VL1065A1		1	PZ																																																																																										
VL1067A0		1	PZ																																																																																										
VL1080A0		1	PZ																																																																																										
VL1081A0		2	PZ																																																																																										
VL1083A0		1	PZ																																																																																										
VM2172A0		1	PZ																																																																																										
			KVL1073A	KIT BOMBA LAVADO MIND.MAPS PLUS	<table border="1"> <thead> <tr> <th>Código</th> <th>Descripción</th> <th>Cant.</th> <th>UdM</th> </tr> </thead> <tbody> <tr><td>GN1526A0</td><td></td><td>1</td><td>PZ</td></tr> <tr><td>RC1019A0</td><td></td><td>4</td><td>PZ</td></tr> <tr><td>RC1130A0</td><td></td><td>1</td><td>PZ</td></tr> <tr><td>RC1242A0</td><td></td><td>2</td><td>PZ</td></tr> <tr><td>TB2820A0</td><td>TUBO EPDM 6X10</td><td>0.120</td><td>M</td></tr> <tr><td>VL1019A0</td><td></td><td>1</td><td>PZ</td></tr> <tr><td>VL1064A0</td><td></td><td>1</td><td>PZ</td></tr> <tr><td>VL1067A0</td><td></td><td>1</td><td>PZ</td></tr> <tr><td>VL1081A0</td><td></td><td>1</td><td>PZ</td></tr> <tr><td>VM2172A0</td><td></td><td>1</td><td>PZ</td></tr> </tbody> </table>	Código	Descripción	Cant.	UdM	GN1526A0		1	PZ	RC1019A0		4	PZ	RC1130A0		1	PZ	RC1242A0		2	PZ	TB2820A0	TUBO EPDM 6X10	0.120	M	VL1019A0		1	PZ	VL1064A0		1	PZ	VL1067A0		1	PZ	VL1081A0		1	PZ	VM2172A0		1	PZ																																												
Código	Descripción	Cant.	UdM																																																																																										
GN1526A0		1	PZ																																																																																										
RC1019A0		4	PZ																																																																																										
RC1130A0		1	PZ																																																																																										
RC1242A0		2	PZ																																																																																										
TB2820A0	TUBO EPDM 6X10	0.120	M																																																																																										
VL1019A0		1	PZ																																																																																										
VL1064A0		1	PZ																																																																																										
VL1067A0		1	PZ																																																																																										
VL1081A0		1	PZ																																																																																										
VM2172A0		1	PZ																																																																																										
			KVL1072A	KIT BOMBA LAVADO MIND.MAPS ONE	<table border="1"> <thead> <tr> <th>Código</th> <th>Descripción</th> <th>Cant.</th> <th>UdM</th> </tr> </thead> <tbody> <tr><td>GN1526A0</td><td></td><td>1</td><td>PZ</td></tr> <tr><td>RC1019A0</td><td></td><td>3</td><td>PZ</td></tr> <tr><td>RC1242A0</td><td></td><td>2</td><td>PZ</td></tr> </tbody> </table>	Código	Descripción	Cant.	UdM	GN1526A0		1	PZ	RC1019A0		3	PZ	RC1242A0		2	PZ																																																																								
Código	Descripción	Cant.	UdM																																																																																										
GN1526A0		1	PZ																																																																																										
RC1019A0		3	PZ																																																																																										
RC1242A0		2	PZ																																																																																										

COMPONENTE			REPUESTO																																																																																																							
Código	Descripción	Imagen	Código	Descripción	Lista de componentes																																																																																																					
VL1019A			KVL1072A	KIT BOMBA LAVADO MIND.MAPS ONE	<table border="1"> <thead> <tr> <th>Código</th> <th>Descripción</th> <th>Cant.</th> <th>UdM</th> </tr> </thead> <tbody> <tr> <td>TB2820A0</td> <td>TUBO EPDM 6X10</td> <td>0.120</td> <td>M</td> </tr> <tr> <td>VI1220A1</td> <td>VITE AUTOFIL. 4.2X12 TCB MARUTEX</td> <td>1</td> <td>PZ</td> </tr> <tr> <td>VL1019A0</td> <td></td> <td>1</td> <td>PZ</td> </tr> <tr> <td>VL1053B0</td> <td></td> <td>1</td> <td>PZ</td> </tr> <tr> <td>VL1054B0</td> <td></td> <td>1</td> <td>PZ</td> </tr> <tr> <td>VL1081A0</td> <td></td> <td>2</td> <td>PZ</td> </tr> <tr> <td>VM2172A0</td> <td></td> <td>1</td> <td>PZ</td> </tr> </tbody> </table>	Código	Descripción	Cant.	UdM	TB2820A0	TUBO EPDM 6X10	0.120	M	VI1220A1	VITE AUTOFIL. 4.2X12 TCB MARUTEX	1	PZ	VL1019A0		1	PZ	VL1053B0		1	PZ	VL1054B0		1	PZ	VL1081A0		2	PZ	VM2172A0		1	PZ																																																																					
			Código	Descripción	Cant.	UdM																																																																																																				
TB2820A0	TUBO EPDM 6X10	0.120	M																																																																																																							
VI1220A1	VITE AUTOFIL. 4.2X12 TCB MARUTEX	1	PZ																																																																																																							
VL1019A0		1	PZ																																																																																																							
VL1053B0		1	PZ																																																																																																							
VL1054B0		1	PZ																																																																																																							
VL1081A0		2	PZ																																																																																																							
VM2172A0		1	PZ																																																																																																							
KVL0001A	KIT CIRCUITO SISTEMA LAVADO LM TOP	<table border="1"> <thead> <tr> <th>Código</th> <th>Descripción</th> <th>Cant.</th> <th>UdM</th> </tr> </thead> <tbody> <tr> <td>0H1226A0</td> <td>PANEL CIRCUITO DE LIMPIADO LINE MISS</td> <td>1</td> <td>PZ</td> </tr> <tr> <td>0H1226B0</td> <td>PANEL CIRCUITO DE LIMPIADO LINE MISS</td> <td>1</td> <td>PZ</td> </tr> <tr> <td>EL1180A0</td> <td>CONEXION DE RETENCION Ø8 Ø8 HEMBR</td> <td>1</td> <td>PZ</td> </tr> <tr> <td>GN1312A0</td> <td></td> <td>1</td> <td>PZ</td> </tr> <tr> <td>GN1526A0</td> <td></td> <td>1</td> <td>PZ</td> </tr> <tr> <td>RC1008A0</td> <td></td> <td>3</td> <td>PZ</td> </tr> <tr> <td>RC1019A0</td> <td></td> <td>3</td> <td>PZ</td> </tr> <tr> <td>RC1242A0</td> <td></td> <td>2</td> <td>PZ</td> </tr> <tr> <td>RC1381A0</td> <td></td> <td>3</td> <td>PZ</td> </tr> <tr> <td>TB2343A0</td> <td>TUBO TRANSPAREN TE PVC 9X6</td> <td>2.630</td> <td>M</td> </tr> <tr> <td>TB2820A0</td> <td>TUBO EPDM 6X10</td> <td>0.990</td> <td>M</td> </tr> <tr> <td>VI1220A1</td> <td>VITE AUTOFIL. 4.2X12 TCB MARUTEX</td> <td>1</td> <td>PZ</td> </tr> <tr> <td>VL1019A0</td> <td></td> <td>1</td> <td>PZ</td> </tr> <tr> <td>VL1041C0</td> <td>TAPON DETERGENTE PERFORADO Ø12</td> <td>1</td> <td>PZ</td> </tr> <tr> <td>VL1047A1</td> <td>SOPORTE TUBO D6 - D8 EXTREMO J.G.</td> <td>1</td> <td>PZ</td> </tr> <tr> <td>VL1053A1</td> <td></td> <td>1</td> <td>PZ</td> </tr> <tr> <td>VL1053B0</td> <td></td> <td>1</td> <td>PZ</td> </tr> <tr> <td>VL1054A1</td> <td></td> <td>1</td> <td>PZ</td> </tr> <tr> <td>VL1054B0</td> <td></td> <td>1</td> <td>PZ</td> </tr> <tr> <td>VL1061A0</td> <td></td> <td>1</td> <td>PZ</td> </tr> <tr> <td>VL1081A0</td> <td></td> <td>1</td> <td>PZ</td> </tr> <tr> <td>VM1066A0</td> <td></td> <td>3</td> <td>PZ</td> </tr> <tr> <td>VM1088A0</td> <td></td> <td>1</td> <td>PZ</td> </tr> <tr> <td>VM1605A0</td> <td></td> <td>1</td> <td>PZ</td> </tr> <tr> <td>VM2172A0</td> <td></td> <td>1</td> <td>PZ</td> </tr> </tbody> </table>	Código	Descripción	Cant.	UdM	0H1226A0	PANEL CIRCUITO DE LIMPIADO LINE MISS	1	PZ	0H1226B0	PANEL CIRCUITO DE LIMPIADO LINE MISS	1	PZ	EL1180A0	CONEXION DE RETENCION Ø8 Ø8 HEMBR	1	PZ	GN1312A0		1	PZ	GN1526A0		1	PZ	RC1008A0		3	PZ	RC1019A0		3	PZ	RC1242A0		2	PZ	RC1381A0		3	PZ	TB2343A0	TUBO TRANSPAREN TE PVC 9X6	2.630	M	TB2820A0	TUBO EPDM 6X10	0.990	M	VI1220A1	VITE AUTOFIL. 4.2X12 TCB MARUTEX	1	PZ	VL1019A0		1	PZ	VL1041C0	TAPON DETERGENTE PERFORADO Ø12	1	PZ	VL1047A1	SOPORTE TUBO D6 - D8 EXTREMO J.G.	1	PZ	VL1053A1		1	PZ	VL1053B0		1	PZ	VL1054A1		1	PZ	VL1054B0		1	PZ	VL1061A0		1	PZ	VL1081A0		1	PZ	VM1066A0		3	PZ	VM1088A0		1	PZ	VM1605A0		1	PZ	VM2172A0		1	PZ
Código	Descripción	Cant.	UdM																																																																																																							
0H1226A0	PANEL CIRCUITO DE LIMPIADO LINE MISS	1	PZ																																																																																																							
0H1226B0	PANEL CIRCUITO DE LIMPIADO LINE MISS	1	PZ																																																																																																							
EL1180A0	CONEXION DE RETENCION Ø8 Ø8 HEMBR	1	PZ																																																																																																							
GN1312A0		1	PZ																																																																																																							
GN1526A0		1	PZ																																																																																																							
RC1008A0		3	PZ																																																																																																							
RC1019A0		3	PZ																																																																																																							
RC1242A0		2	PZ																																																																																																							
RC1381A0		3	PZ																																																																																																							
TB2343A0	TUBO TRANSPAREN TE PVC 9X6	2.630	M																																																																																																							
TB2820A0	TUBO EPDM 6X10	0.990	M																																																																																																							
VI1220A1	VITE AUTOFIL. 4.2X12 TCB MARUTEX	1	PZ																																																																																																							
VL1019A0		1	PZ																																																																																																							
VL1041C0	TAPON DETERGENTE PERFORADO Ø12	1	PZ																																																																																																							
VL1047A1	SOPORTE TUBO D6 - D8 EXTREMO J.G.	1	PZ																																																																																																							
VL1053A1		1	PZ																																																																																																							
VL1053B0		1	PZ																																																																																																							
VL1054A1		1	PZ																																																																																																							
VL1054B0		1	PZ																																																																																																							
VL1061A0		1	PZ																																																																																																							
VL1081A0		1	PZ																																																																																																							
VM1066A0		3	PZ																																																																																																							
VM1088A0		1	PZ																																																																																																							
VM1605A0		1	PZ																																																																																																							
VM2172A0		1	PZ																																																																																																							



COMPONENTE			REPUESTO														
Código	Descripción	Imagen	Código	Descripción	Lista de componentes												
VM2172A			VM2172A0														
RC1019A			KRC1019A	KIT 5 UDS CLIP ELASTICA DE CINCO Ø10	<table border="1"> <thead> <tr> <th>Código</th> <th>Descripción</th> <th>Cant.</th> <th>UdM</th> </tr> </thead> <tbody> <tr> <td>RC1019A0</td> <td></td> <td>15</td> <td>PZ</td> </tr> </tbody> </table>	Código	Descripción	Cant.	UdM	RC1019A0		15	PZ				
Código	Descripción	Cant.	UdM														
RC1019A0		15	PZ														
RC1356A			KRC1356A		<table border="1"> <thead> <tr> <th>Código</th> <th>Descripción</th> <th>Cant.</th> <th>UdM</th> </tr> </thead> <tbody> <tr> <td>RC1356A0</td> <td></td> <td>1</td> <td>PZ</td> </tr> </tbody> </table>	Código	Descripción	Cant.	UdM	RC1356A0		1	PZ				
Código	Descripción	Cant.	UdM														
RC1356A0		1	PZ														
VL1065A			KVL1065A		<table border="1"> <thead> <tr> <th>Código</th> <th>Descripción</th> <th>Cant.</th> <th>UdM</th> </tr> </thead> <tbody> <tr> <td>VL1065A1</td> <td></td> <td>1</td> <td>PZ</td> </tr> </tbody> </table>	Código	Descripción	Cant.	UdM	VL1065A1		1	PZ				
Código	Descripción	Cant.	UdM														
VL1065A1		1	PZ														
VL1081A			KVL1081A		<table border="1"> <thead> <tr> <th>Código</th> <th>Descripción</th> <th>Cant.</th> <th>UdM</th> </tr> </thead> <tbody> <tr> <td>TB2820A0</td> <td>TUBO EPDM 6X10</td> <td>0.240</td> <td>M</td> </tr> <tr> <td>VL1081A0</td> <td></td> <td>3</td> <td>PZ</td> </tr> </tbody> </table>	Código	Descripción	Cant.	UdM	TB2820A0	TUBO EPDM 6X10	0.240	M	VL1081A0		3	PZ
Código	Descripción	Cant.	UdM														
TB2820A0	TUBO EPDM 6X10	0.240	M														
VL1081A0		3	PZ														



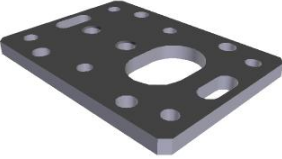

COMPONENTE			REPUESTO																																														
Código	Descripción	Imagen	Código	Descripción	Lista de componentes																																												
VL1083A			VL1083A0																																														
VL1080A			VL1080A0																																														
RC1242A			RC1242A0																																														
VL1064A			KVL1073A	KIT BOMBA LAVADO MIND.MAPS PLUS	<table border="1"> <thead> <tr> <th>Código</th> <th>Descripción</th> <th>Cant.</th> <th>UdM</th> </tr> </thead> <tbody> <tr> <td>GN1526A0</td> <td></td> <td>1</td> <td>PZ</td> </tr> <tr> <td>RC1019A0</td> <td></td> <td>4</td> <td>PZ</td> </tr> <tr> <td>RC1130A0</td> <td></td> <td>1</td> <td>PZ</td> </tr> <tr> <td>RC1242A0</td> <td></td> <td>2</td> <td>PZ</td> </tr> <tr> <td>TB2820A0</td> <td>TUBO EPDM 6X10</td> <td>0.120</td> <td>M</td> </tr> <tr> <td>VL1019A0</td> <td></td> <td>1</td> <td>PZ</td> </tr> <tr> <td>VL1064A0</td> <td></td> <td>1</td> <td>PZ</td> </tr> <tr> <td>VL1067A0</td> <td></td> <td>1</td> <td>PZ</td> </tr> <tr> <td>VL1081A0</td> <td></td> <td>1</td> <td>PZ</td> </tr> <tr> <td>VM2172A0</td> <td></td> <td>1</td> <td>PZ</td> </tr> </tbody> </table>	Código	Descripción	Cant.	UdM	GN1526A0		1	PZ	RC1019A0		4	PZ	RC1130A0		1	PZ	RC1242A0		2	PZ	TB2820A0	TUBO EPDM 6X10	0.120	M	VL1019A0		1	PZ	VL1064A0		1	PZ	VL1067A0		1	PZ	VL1081A0		1	PZ	VM2172A0		1	PZ
Código	Descripción	Cant.	UdM																																														
GN1526A0		1	PZ																																														
RC1019A0		4	PZ																																														
RC1130A0		1	PZ																																														
RC1242A0		2	PZ																																														
TB2820A0	TUBO EPDM 6X10	0.120	M																																														
VL1019A0		1	PZ																																														
VL1064A0		1	PZ																																														
VL1067A0		1	PZ																																														
VL1081A0		1	PZ																																														
VM2172A0		1	PZ																																														
EL1424A			KEL1424A	KIT ELECTROVALVULA JG Ø8 CONEXION Ø	<table border="1"> <thead> <tr> <th>Código</th> <th>Descripción</th> <th>Cant.</th> <th>UdM</th> </tr> </thead> <tbody> <tr> <td>EL1424A0</td> <td></td> <td>1</td> <td>PZ</td> </tr> <tr> <td>VI1095A0</td> <td>ES-VITE AUTOFIL. 3,9X9,5 TCB+ NICHELATA</td> <td>2</td> <td>PZ</td> </tr> </tbody> </table>	Código	Descripción	Cant.	UdM	EL1424A0		1	PZ	VI1095A0	ES-VITE AUTOFIL. 3,9X9,5 TCB+ NICHELATA	2	PZ																																
Código	Descripción	Cant.	UdM																																														
EL1424A0		1	PZ																																														
VI1095A0	ES-VITE AUTOFIL. 3,9X9,5 TCB+ NICHELATA	2	PZ																																														

COMPONENTE			REPUESTO										
Código	Descripción	Imagen	Código	Descripción	Lista de componentes								
EL1252A	ELECTROVALVULA 1 VIA + CONEXION J.		KEL1252A	KIT ELECTROVALVULA 1 VIA J.G. D8-D1	<table border="1"> <thead> <tr> <th>Código</th> <th>Descripción</th> <th>Cant.</th> <th>UdM</th> </tr> </thead> <tbody> <tr> <td>EL1252A1</td> <td>ELECTROVALVULA 1 VIA + CONEXION J.G.</td> <td>1</td> <td>PZ</td> </tr> </tbody> </table>	Código	Descripción	Cant.	UdM	EL1252A1	ELECTROVALVULA 1 VIA + CONEXION J.G.	1	PZ
Código	Descripción	Cant.	UdM										
EL1252A1	ELECTROVALVULA 1 VIA + CONEXION J.G.	1	PZ										
VL1092A			VL1092A0										
EL1020A			KEL1020A	KIT 10 UDS RACOR T Ø8 EL1020A	<table border="1"> <thead> <tr> <th>Código</th> <th>Descripción</th> <th>Cant.</th> <th>UdM</th> </tr> </thead> <tbody> <tr> <td>EL1020A0</td> <td>RACOR INTERMEDIO "T" TUBO Ø8</td> <td>10</td> <td>PZ</td> </tr> </tbody> </table>	Código	Descripción	Cant.	UdM	EL1020A0	RACOR INTERMEDIO "T" TUBO Ø8	10	PZ
Código	Descripción	Cant.	UdM										
EL1020A0	RACOR INTERMEDIO "T" TUBO Ø8	10	PZ										
TB3024A			KTB1349A	KIT TUBO 8X4,75 AZUL ENTRADA AGUA L=30M	<table border="1"> <thead> <tr> <th>Código</th> <th>Descripción</th> <th>Cant.</th> <th>UdM</th> </tr> </thead> <tbody> <tr> <td>TB1818A0</td> <td></td> <td>30</td> <td>M</td> </tr> </tbody> </table>	Código	Descripción	Cant.	UdM	TB1818A0		30	M
Código	Descripción	Cant.	UdM										
TB1818A0		30	M										
TB3025A			KTB1349A	KIT TUBO 8X4,75 AZUL ENTRADA AGUA L=30M	<table border="1"> <thead> <tr> <th>Código</th> <th>Descripción</th> <th>Cant.</th> <th>UdM</th> </tr> </thead> <tbody> <tr> <td>TB1818A0</td> <td></td> <td>30</td> <td>M</td> </tr> </tbody> </table>	Código	Descripción	Cant.	UdM	TB1818A0		30	M
Código	Descripción	Cant.	UdM										
TB1818A0		30	M										

COMPONENTE			REPUESTO										
Código	Descripción	Imagen	Código	Descripción	Lista de componentes								
TB3026A			KTB1349A	KIT TUBO 8X4,75 AZUL ENTRADA AGUA L=30M	<table border="1"> <thead> <tr> <th>Código</th> <th>Descripción</th> <th>Cant.</th> <th>UdM</th> </tr> </thead> <tbody> <tr> <td>TB1818A0</td> <td></td> <td>30</td> <td>M</td> </tr> </tbody> </table>	Código	Descripción	Cant.	UdM	TB1818A0		30	M
Código	Descripción	Cant.	UdM										
TB1818A0		30	M										
EL1436A			KEL1436A	KIT ELECTROVALVULA JG Ø8 CONEXION Ø	<table border="1"> <thead> <tr> <th>Código</th> <th>Descripción</th> <th>Cant.</th> <th>UdM</th> </tr> </thead> <tbody> <tr> <td>EL1436A0</td> <td></td> <td>1</td> <td>PZ</td> </tr> </tbody> </table>	Código	Descripción	Cant.	UdM	EL1436A0		1	PZ
Código	Descripción	Cant.	UdM										
EL1436A0		1	PZ										
0H7232B			0H7232B0										
0H2561A			0H2561A0										
VI1995A			VI1995A0										

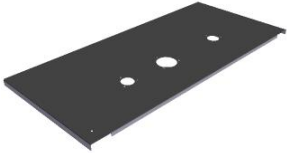



COMPONENTE			REPUESTO																						
Código	Descripción	Imagen	Código	Descripción	Lista de componentes																				
VM2352A			VM2352A0																						
VM2353A			VM2353A0																						
VM1240A			VM1240A0																						
VM2273A			KVM2273A	KIT ESTRIBO INFER. IZQ. PUERTA MIND.MAPS	<table border="1"> <thead> <tr> <th>Código</th> <th>Descripción</th> <th>Cant.</th> <th>UdM</th> </tr> </thead> <tbody> <tr> <td>0H7330A0</td> <td></td> <td>2</td> <td>PZ</td> </tr> <tr> <td>VI1995A0</td> <td></td> <td>4</td> <td>PZ</td> </tr> <tr> <td>VM2273A0</td> <td></td> <td>1</td> <td>PZ</td> </tr> <tr> <td>VM2352A0</td> <td></td> <td>2</td> <td>PZ</td> </tr> </tbody> </table>	Código	Descripción	Cant.	UdM	0H7330A0		2	PZ	VI1995A0		4	PZ	VM2273A0		1	PZ	VM2352A0		2	PZ
Código	Descripción	Cant.	UdM																						
0H7330A0		2	PZ																						
VI1995A0		4	PZ																						
VM2273A0		1	PZ																						
VM2352A0		2	PZ																						
0H2561A			0H2561A0																						



COMPONENTE			REPUESTO																										
Código	Descripción	Imagen	Código	Descripción	Lista de componentes																								
VI1995A			VI1995A0																										
VM1240A			VM1240A0																										
VM2298A			VM2298A0																										
VM2271A			KVM2271A	KIT ESTRIBO SUPER. IZQ. PUERTA MIND.MAP	<table border="1"> <thead> <tr> <th>Código</th> <th>Descripción</th> <th>Cant.</th> <th>UdM</th> </tr> </thead> <tbody> <tr> <td>VI1220A1</td> <td>VITE AUTOFIL. 4.2X12 TCB MARUTEX</td> <td>2</td> <td>PZ</td> </tr> <tr> <td>VI1995A0</td> <td></td> <td>4</td> <td>PZ</td> </tr> <tr> <td>VI1997A0</td> <td></td> <td>4</td> <td>PZ</td> </tr> <tr> <td>VM2271A0</td> <td></td> <td>1</td> <td>PZ</td> </tr> <tr> <td>VM2298A0</td> <td></td> <td>1</td> <td>PZ</td> </tr> </tbody> </table>	Código	Descripción	Cant.	UdM	VI1220A1	VITE AUTOFIL. 4.2X12 TCB MARUTEX	2	PZ	VI1995A0		4	PZ	VI1997A0		4	PZ	VM2271A0		1	PZ	VM2298A0		1	PZ
Código	Descripción	Cant.	UdM																										
VI1220A1	VITE AUTOFIL. 4.2X12 TCB MARUTEX	2	PZ																										
VI1995A0		4	PZ																										
VI1997A0		4	PZ																										
VM2271A0		1	PZ																										
VM2298A0		1	PZ																										
0D2298A	TAPA LATERAL IZQ XEVC-0511		0D2298A1	TAPA LATERAL IZQ XEVC-0511																									

COMPONENTE			REPUESTO		
Código	Descripción	Imagen	Código	Descripción	Lista de componentes
0D2299A	TAPA LATERAL DER XEVC-0511		0D2299A1	TAPA LATERAL DER XEVC-0511	
0D2340A			0D2340A0		
0F1500A			0F1500A0		
ASM1762A	Enlace hídrico		ASM1762A0	Enlace hídrico	
RC1243A			RC1243A0		

COMPONENTE			REPUESTO																																			
Código	Descripción	Imagen	Código	Descripción	Lista de componentes																																	
VL1014A	REDUCTOR DE PRESION CON DISTRIBUIDOR		KVL1014A	KIT REDUCTOR DE PRESION	<table border="1"> <thead> <tr> <th>Código</th> <th>Descripción</th> <th>Cant.</th> <th>UdM</th> </tr> </thead> <tbody> <tr> <td>EL1185A0</td> <td>RACOR CODO J.GUEST Ø8 - Ø8</td> <td>1</td> <td>PZ</td> </tr> <tr> <td>EL1185B0</td> <td>CONEXION A CODO JG Ø8F-Ø8F</td> <td>1</td> <td>PZ</td> </tr> <tr> <td>RC1003A0</td> <td>CONEXION 8M-1/8 BSPP</td> <td>2</td> <td>PZ</td> </tr> <tr> <td>RC1372A0</td> <td>CONEXION RECTA Ø10M-1/4 M CI</td> <td>1</td> <td>PZ</td> </tr> <tr> <td>VL1014A0</td> <td>REDUCTOR DE PRESION CON DISTRIBUIDOR</td> <td>1</td> <td>PZ</td> </tr> <tr> <td>VM2028A0</td> <td>RONDANA GOMA 20X10X</td> <td>1</td> <td>PZ</td> </tr> <tr> <td>VM2059A0</td> <td>TAPON 1/4" CIL CON O-RIN</td> <td>1</td> <td>PZ</td> </tr> </tbody> </table>		Código	Descripción	Cant.	UdM	EL1185A0	RACOR CODO J.GUEST Ø8 - Ø8	1	PZ	EL1185B0	CONEXION A CODO JG Ø8F-Ø8F	1	PZ	RC1003A0	CONEXION 8M-1/8 BSPP	2	PZ	RC1372A0	CONEXION RECTA Ø10M-1/4 M CI	1	PZ	VL1014A0	REDUCTOR DE PRESION CON DISTRIBUIDOR	1	PZ	VM2028A0	RONDANA GOMA 20X10X	1	PZ	VM2059A0	TAPON 1/4" CIL CON O-RIN	1	PZ
			Código	Descripción	Cant.	UdM																																
EL1185A0	RACOR CODO J.GUEST Ø8 - Ø8	1	PZ																																			
EL1185B0	CONEXION A CODO JG Ø8F-Ø8F	1	PZ																																			
RC1003A0	CONEXION 8M-1/8 BSPP	2	PZ																																			
RC1372A0	CONEXION RECTA Ø10M-1/4 M CI	1	PZ																																			
VL1014A0	REDUCTOR DE PRESION CON DISTRIBUIDOR	1	PZ																																			
VM2028A0	RONDANA GOMA 20X10X	1	PZ																																			
VM2059A0	TAPON 1/4" CIL CON O-RIN	1	PZ																																			
KVL0014A	KIT REDUCTOR DE PRESION MIND.MAP	<table border="1"> <thead> <tr> <th>Código</th> <th>Descripción</th> <th>Cant.</th> <th>UdM</th> </tr> </thead> <tbody> <tr> <td>RC1372A0</td> <td>CONEXION RECTA Ø10M-1/4 M CI</td> <td>2</td> <td>PZ</td> </tr> <tr> <td>VL1014A0</td> <td>REDUCTOR DE PRESION CON DISTRIBUIDOR</td> <td>1</td> <td>PZ</td> </tr> <tr> <td>VM1053A0</td> <td></td> <td>2</td> <td>PZ</td> </tr> <tr> <td>VM1054A0</td> <td></td> <td>1</td> <td>PZ</td> </tr> </tbody> </table>		Código	Descripción	Cant.	UdM	RC1372A0	CONEXION RECTA Ø10M-1/4 M CI	2	PZ	VL1014A0	REDUCTOR DE PRESION CON DISTRIBUIDOR	1	PZ	VM1053A0		2	PZ	VM1054A0		1	PZ															
Código	Descripción	Cant.	UdM																																			
RC1372A0	CONEXION RECTA Ø10M-1/4 M CI	2	PZ																																			
VL1014A0	REDUCTOR DE PRESION CON DISTRIBUIDOR	1	PZ																																			
VM1053A0		2	PZ																																			
VM1054A0		1	PZ																																			
RC1372A	CONEXION RECTA Ø10M-1/4 M CIL		RC1372A0	CONEXION RECTA Ø10M-1/4 M CIL																																		
VM1054A			KVM1054A		<table border="1"> <thead> <tr> <th>Código</th> <th>Descripción</th> <th>Cant.</th> <th>UdM</th> </tr> </thead> <tbody> <tr> <td>VM1054A0</td> <td></td> <td>1</td> <td>PZ</td> </tr> </tbody> </table>		Código	Descripción	Cant.	UdM	VM1054A0		1	PZ																								
Código	Descripción	Cant.	UdM																																			
VM1054A0		1	PZ																																			

COMPONENTE			REPUESTO																		
Código	Descripción	Imagen	Código	Descripción	Lista de componentes																
RC1004A			KRC1004A		<table border="1"> <thead> <tr> <th>Código</th> <th>Descripción</th> <th>Cant.</th> <th>UdM</th> </tr> </thead> <tbody> <tr> <td>RC1004A0</td> <td></td> <td>10</td> <td>PZ</td> </tr> </tbody> </table>	Código	Descripción	Cant.	UdM	RC1004A0		10	PZ								
Código	Descripción	Cant.	UdM																		
RC1004A0		10	PZ																		
VL1034C			KVL1034C	KIT FILTRO AGUA Ø10 MESH100	<table border="1"> <thead> <tr> <th>Código</th> <th>Descripción</th> <th>Cant.</th> <th>UdM</th> </tr> </thead> <tbody> <tr> <td>RC1002A0</td> <td></td> <td>2</td> <td>PZ</td> </tr> <tr> <td>VL1034C0</td> <td></td> <td>1</td> <td>PZ</td> </tr> <tr> <td>VL1062C0</td> <td></td> <td>1</td> <td>PZ</td> </tr> </tbody> </table>	Código	Descripción	Cant.	UdM	RC1002A0		2	PZ	VL1034C0		1	PZ	VL1062C0		1	PZ
Código	Descripción	Cant.	UdM																		
RC1002A0		2	PZ																		
VL1034C0		1	PZ																		
VL1062C0		1	PZ																		
VL1062C			KVL1034B	KIT RECAMBIO FILTRO AGUA Ø8 Y Ø10	<table border="1"> <thead> <tr> <th>Código</th> <th>Descripción</th> <th>Cant.</th> <th>UdM</th> </tr> </thead> <tbody> <tr> <td>RC1002A0</td> <td></td> <td>2</td> <td>PZ</td> </tr> <tr> <td>VL1034B0</td> <td></td> <td>1</td> <td>PZ</td> </tr> <tr> <td>VL1062C0</td> <td></td> <td>1</td> <td>PZ</td> </tr> </tbody> </table>	Código	Descripción	Cant.	UdM	RC1002A0		2	PZ	VL1034B0		1	PZ	VL1062C0		1	PZ
Código	Descripción	Cant.	UdM																		
RC1002A0		2	PZ																		
VL1034B0		1	PZ																		
VL1062C0		1	PZ																		
RC1365A			KRC1365A	KIT CONEXION RED DE AGUA PRINCIPA	<table border="1"> <thead> <tr> <th>Código</th> <th>Descripción</th> <th>Cant.</th> <th>UdM</th> </tr> </thead> <tbody> <tr> <td>GN1200A1</td> <td></td> <td>1</td> <td>PZ</td> </tr> <tr> <td>RC1002A0</td> <td></td> <td>1</td> <td>PZ</td> </tr> <tr> <td>RC1365A0</td> <td></td> <td>1</td> <td>PZ</td> </tr> </tbody> </table>	Código	Descripción	Cant.	UdM	GN1200A1		1	PZ	RC1002A0		1	PZ	RC1365A0		1	PZ
Código	Descripción	Cant.	UdM																		
GN1200A1		1	PZ																		
RC1002A0		1	PZ																		
RC1365A0		1	PZ																		
VM2074A			KVM1220A	KIT 4 UDS CLIP SOPORTE CAJONES CT BT	<table border="1"> <thead> <tr> <th>Código</th> <th>Descripción</th> <th>Cant.</th> <th>UdM</th> </tr> </thead> <tbody> <tr> <td>VI1220A1</td> <td>VITE AUTOFIL. 4.2X12 TCB MARUTEX</td> <td>4</td> <td>PZ</td> </tr> <tr> <td>VM1220A0</td> <td>CLIP AJUSTE CAJON RECOGEGOTA</td> <td>4</td> <td>PZ</td> </tr> <tr> <td>VM2074A0</td> <td></td> <td>4</td> <td>PZ</td> </tr> </tbody> </table>	Código	Descripción	Cant.	UdM	VI1220A1	VITE AUTOFIL. 4.2X12 TCB MARUTEX	4	PZ	VM1220A0	CLIP AJUSTE CAJON RECOGEGOTA	4	PZ	VM2074A0		4	PZ
Código	Descripción	Cant.	UdM																		
VI1220A1	VITE AUTOFIL. 4.2X12 TCB MARUTEX	4	PZ																		
VM1220A0	CLIP AJUSTE CAJON RECOGEGOTA	4	PZ																		
VM2074A0		4	PZ																		

COMPONENTE			REPUESTO																										
Código	Descripción	Imagen	Código	Descripción	Lista de componentes																								
VM2249A			VM2249A0																										
VM2061A			KVM1505A		<table border="1"> <thead> <tr> <th>Código</th> <th>Descripción</th> <th>Cant.</th> <th>UdM</th> </tr> </thead> <tbody> <tr> <td>VI1220A1</td> <td>VITE AUTOFIL 4.2X12 TCB MARUTEX</td> <td>1</td> <td>PZ</td> </tr> <tr> <td>VM1505A0</td> <td>PASA-PARED CON DIAFRAGMA</td> <td>3</td> <td>PZ</td> </tr> <tr> <td>VM2061A0</td> <td></td> <td>1</td> <td>PZ</td> </tr> </tbody> </table>	Código	Descripción	Cant.	UdM	VI1220A1	VITE AUTOFIL 4.2X12 TCB MARUTEX	1	PZ	VM1505A0	PASA-PARED CON DIAFRAGMA	3	PZ	VM2061A0		1	PZ								
Código	Descripción	Cant.	UdM																										
VI1220A1	VITE AUTOFIL 4.2X12 TCB MARUTEX	1	PZ																										
VM1505A0	PASA-PARED CON DIAFRAGMA	3	PZ																										
VM2061A0		1	PZ																										
VM1991A			KVM1991A	KIT CAJON RECOGE GOTAS	<table border="1"> <thead> <tr> <th>Código</th> <th>Descripción</th> <th>Cant.</th> <th>UdM</th> </tr> </thead> <tbody> <tr> <td>VM1220A0</td> <td>CLIP AJUSTE CAJON RECOGEGOTA</td> <td>4</td> <td>PZ</td> </tr> <tr> <td>VM1794A0</td> <td>ABRAZADERA NEGRA 250X4.8 PA66</td> <td>2</td> <td>PZ</td> </tr> <tr> <td>VM1991A0</td> <td></td> <td>1</td> <td>PZ</td> </tr> <tr> <td>VM2074A0</td> <td></td> <td>4</td> <td>PZ</td> </tr> <tr> <td>VM2103A0</td> <td>PLAQUETA FIJA ABRAZADERA</td> <td>2</td> <td>PZ</td> </tr> </tbody> </table>	Código	Descripción	Cant.	UdM	VM1220A0	CLIP AJUSTE CAJON RECOGEGOTA	4	PZ	VM1794A0	ABRAZADERA NEGRA 250X4.8 PA66	2	PZ	VM1991A0		1	PZ	VM2074A0		4	PZ	VM2103A0	PLAQUETA FIJA ABRAZADERA	2	PZ
Código	Descripción	Cant.	UdM																										
VM1220A0	CLIP AJUSTE CAJON RECOGEGOTA	4	PZ																										
VM1794A0	ABRAZADERA NEGRA 250X4.8 PA66	2	PZ																										
VM1991A0		1	PZ																										
VM2074A0		4	PZ																										
VM2103A0	PLAQUETA FIJA ABRAZADERA	2	PZ																										
VM2035A			KVM2035A	KIT 2 UDS SOPORTE TUBO DESAGUE	<table border="1"> <thead> <tr> <th>Código</th> <th>Descripción</th> <th>Cant.</th> <th>UdM</th> </tr> </thead> <tbody> <tr> <td>VM2035A0</td> <td></td> <td>2</td> <td>PZ</td> </tr> </tbody> </table>	Código	Descripción	Cant.	UdM	VM2035A0		2	PZ																
Código	Descripción	Cant.	UdM																										
VM2035A0		2	PZ																										
VM1811A			VM1811A0																										

COMPONENTE			REPUESTO		
<i>Código</i>	<i>Descripción</i>	<i>Imagen</i>	<i>Código</i>	<i>Descripción</i>	<i>Lista de componentes</i>
VM2311A			VM2311A0		
VM2308A			VM2308A0		

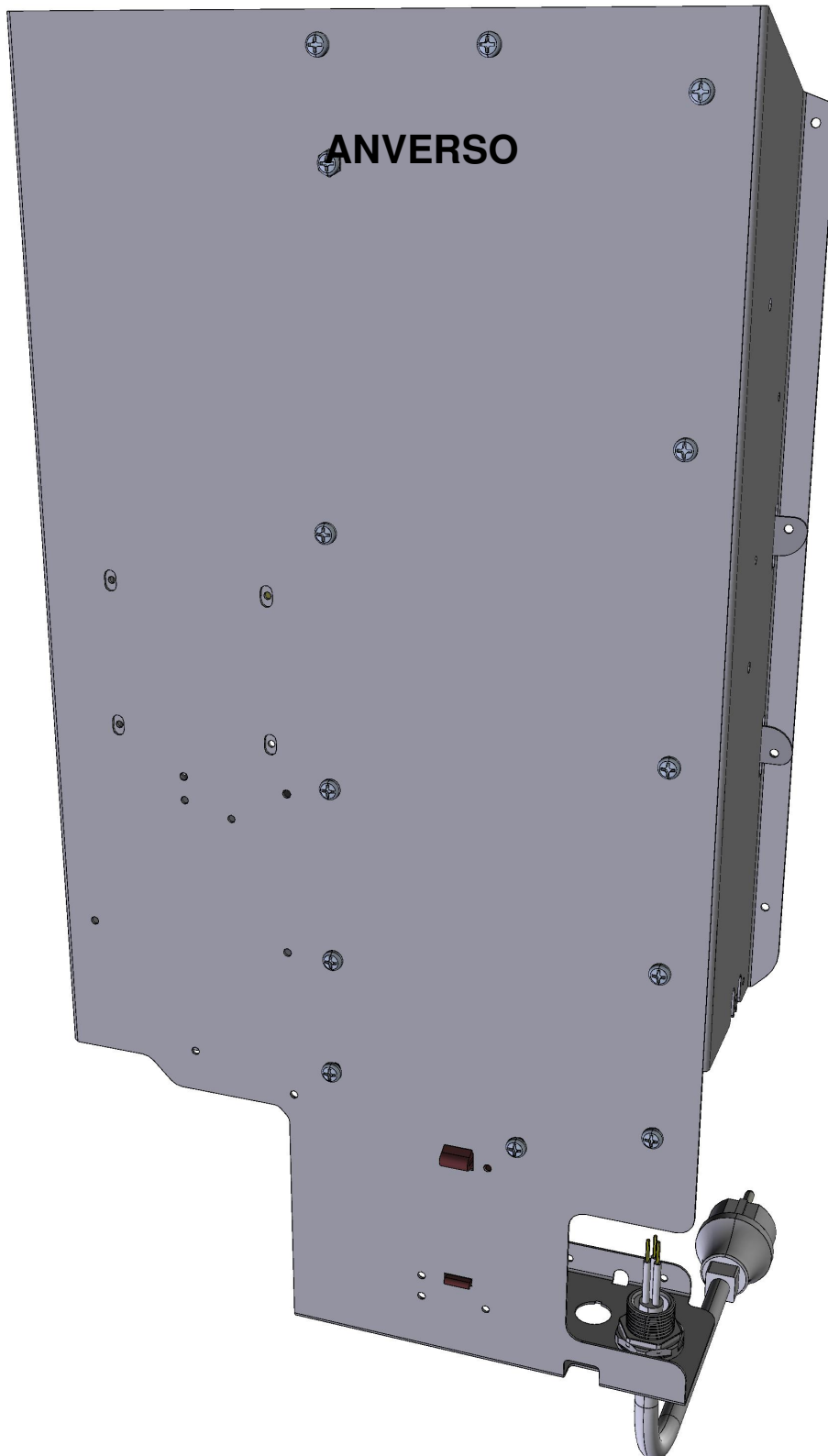

ASM1854A/0.D01 - Conjunto genérico



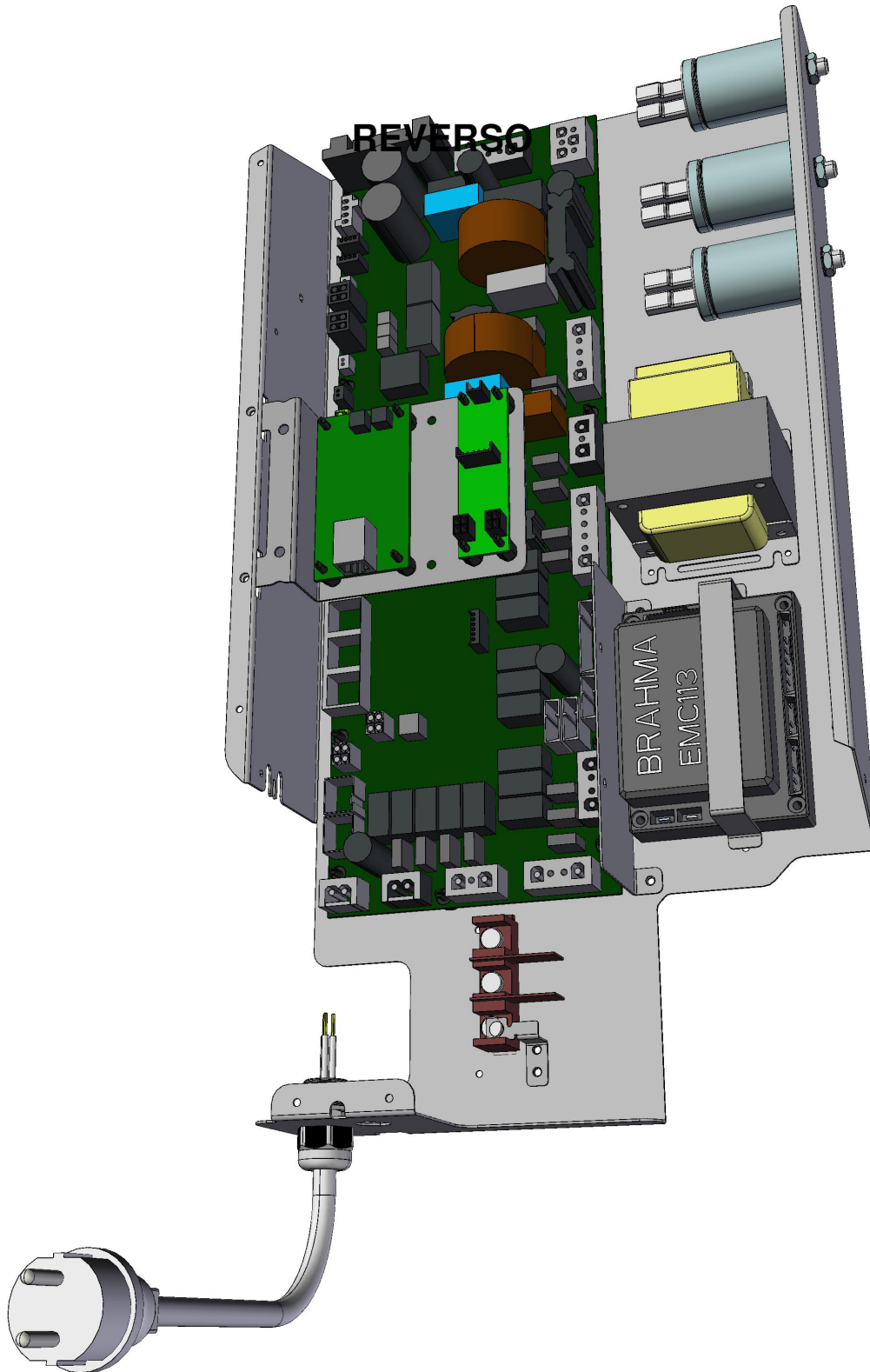

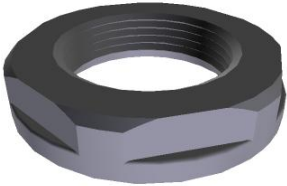
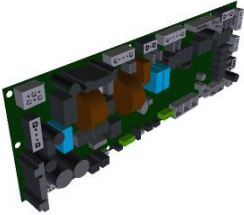
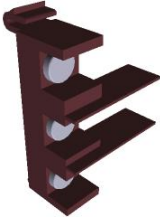

ASM1854A/0.D01 - Conjunto genérico

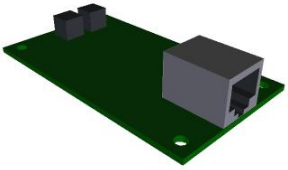
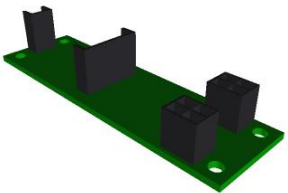

COMPONENTE			REPUESTO																		
Código	Descripción	Imagen	Código	Descripción	Lista de componentes																
CN1003A	CONDENSADOR 6,3 UF		KCN1003A	KIT CONDENSADOR MOTOR	<table border="1"> <thead> <tr> <th>Código</th> <th>Descripción</th> <th>Cant.</th> <th>UdM</th> </tr> </thead> <tbody> <tr> <td>CN1003A0</td> <td>CONDENSADO R 6,3 UF</td> <td>1</td> <td>PZ</td> </tr> <tr> <td>VI1931A0</td> <td></td> <td>1</td> <td>PZ</td> </tr> <tr> <td>VI1932A0</td> <td></td> <td>1</td> <td>PZ</td> </tr> </tbody> </table>	Código	Descripción	Cant.	UdM	CN1003A0	CONDENSADO R 6,3 UF	1	PZ	VI1931A0		1	PZ	VI1932A0		1	PZ
Código	Descripción	Cant.	UdM																		
CN1003A0	CONDENSADO R 6,3 UF	1	PZ																		
VI1931A0		1	PZ																		
VI1932A0		1	PZ																		
VE1026A	TRANSFORMADOR 230-21-12VAC 90VA		KVE1026A	KIT TRANSFORMADOR 230-21-12VAC 90VA	<table border="1"> <thead> <tr> <th>Código</th> <th>Descripción</th> <th>Cant.</th> <th>UdM</th> </tr> </thead> <tbody> <tr> <td>VE1026A0</td> <td>TRANSFORMA DOR 230-21-12VAC 90VA</td> <td>1</td> <td>PZ</td> </tr> <tr> <td>VI1950A0</td> <td></td> <td>4</td> <td>PZ</td> </tr> <tr> <td>VM2147A0</td> <td></td> <td>1</td> <td>PZ</td> </tr> </tbody> </table>	Código	Descripción	Cant.	UdM	VE1026A0	TRANSFORMA DOR 230-21-12VAC 90VA	1	PZ	VI1950A0		4	PZ	VM2147A0		1	PZ
Código	Descripción	Cant.	UdM																		
VE1026A0	TRANSFORMA DOR 230-21-12VAC 90VA	1	PZ																		
VI1950A0		4	PZ																		
VM2147A0		1	PZ																		
OH7293A			OH7293A0																		
OH7374A	LAMINA CABLE SONDA CORAZON		OH7374A0	LAMINA CABLE SONDA CORAZON																	
VE1275A			VE1275A0																		

COMPONENTE			REPUESTO																						
Código	Descripción	Imagen	Código	Descripción	Lista de componentes																				
VE1280A			VE1280A0																						
PE2021A	TARJETA POTENCIA MIND.MAPS GAS		KPE2021A	KIT TARJETA POTENCIA MM GAS	<table border="1"> <thead> <tr> <th>Código</th> <th>Descripción</th> <th>Cant.</th> <th>UdM</th> </tr> </thead> <tbody> <tr> <td>PE2021A0</td> <td>TARJETA POTENCIA MIND.MAPS GAS</td> <td>1</td> <td>PZ</td> </tr> <tr> <td>VI1850A0</td> <td>TORNILLOS DE FIJACION NIQUELADOS M4X6</td> <td>12</td> <td>PZ</td> </tr> <tr> <td>VM1745A0</td> <td>SOPORTE PARA TARJET</td> <td>12</td> <td>PZ</td> </tr> <tr> <td>VM2147A0</td> <td></td> <td>1</td> <td>PZ</td> </tr> </tbody> </table>	Código	Descripción	Cant.	UdM	PE2021A0	TARJETA POTENCIA MIND.MAPS GAS	1	PZ	VI1850A0	TORNILLOS DE FIJACION NIQUELADOS M4X6	12	PZ	VM1745A0	SOPORTE PARA TARJET	12	PZ	VM2147A0		1	PZ
Código	Descripción	Cant.	UdM																						
PE2021A0	TARJETA POTENCIA MIND.MAPS GAS	1	PZ																						
VI1850A0	TORNILLOS DE FIJACION NIQUELADOS M4X6	12	PZ																						
VM1745A0	SOPORTE PARA TARJET	12	PZ																						
VM2147A0		1	PZ																						
CE1575A			CE1575A0																						
0H7462A			0H7462A0																						
VE1636A			KVE1636A	KIT CONTROL LLAMA 240V MULTILLAMA	<table border="1"> <thead> <tr> <th>Código</th> <th>Descripción</th> <th>Cant.</th> <th>UdM</th> </tr> </thead> <tbody> <tr> <td>CE1047A0</td> <td></td> <td>2</td> <td>PZ</td> </tr> <tr> <td>VE1636A0</td> <td></td> <td>1</td> <td>PZ</td> </tr> </tbody> </table>	Código	Descripción	Cant.	UdM	CE1047A0		2	PZ	VE1636A0		1	PZ								
Código	Descripción	Cant.	UdM																						
CE1047A0		2	PZ																						
VE1636A0		1	PZ																						

COMPONENTE			REPUESTO																										
Código	Descripción	Imagen	Código	Descripción	Lista de componentes																								
PE2052A			XEC001	UNOX.LINK KIT CONEXION ETHERNET PARA ONE	<table border="1"> <thead> <tr> <th>Código</th> <th>Descripción</th> <th>Cant.</th> <th>UdM</th> </tr> </thead> <tbody> <tr> <td>CE1065A0</td> <td></td> <td>1</td> <td>PZ</td> </tr> <tr> <td>PE2052A0</td> <td></td> <td>1</td> <td>PZ</td> </tr> <tr> <td>VI1850A0</td> <td>TORNILLOS DE FIJACION NIQUELADOS M4X6</td> <td>6</td> <td>PZ</td> </tr> <tr> <td>VM1745A0</td> <td>SOPORTE PARA TARJET</td> <td>4</td> <td>PZ</td> </tr> <tr> <td>VM2147A0</td> <td></td> <td>1</td> <td>PZ</td> </tr> </tbody> </table>	Código	Descripción	Cant.	UdM	CE1065A0		1	PZ	PE2052A0		1	PZ	VI1850A0	TORNILLOS DE FIJACION NIQUELADOS M4X6	6	PZ	VM1745A0	SOPORTE PARA TARJET	4	PZ	VM2147A0		1	PZ
Código	Descripción	Cant.	UdM																										
CE1065A0		1	PZ																										
PE2052A0		1	PZ																										
VI1850A0	TORNILLOS DE FIJACION NIQUELADOS M4X6	6	PZ																										
VM1745A0	SOPORTE PARA TARJET	4	PZ																										
VM2147A0		1	PZ																										
PE2057A			PE2057A0																										
0H7451A			0H7451A0																										
0H7490A			0H7490A0																										
0H7452A			0H7452A2																										

ASM2921A/0.D01 - Puerta

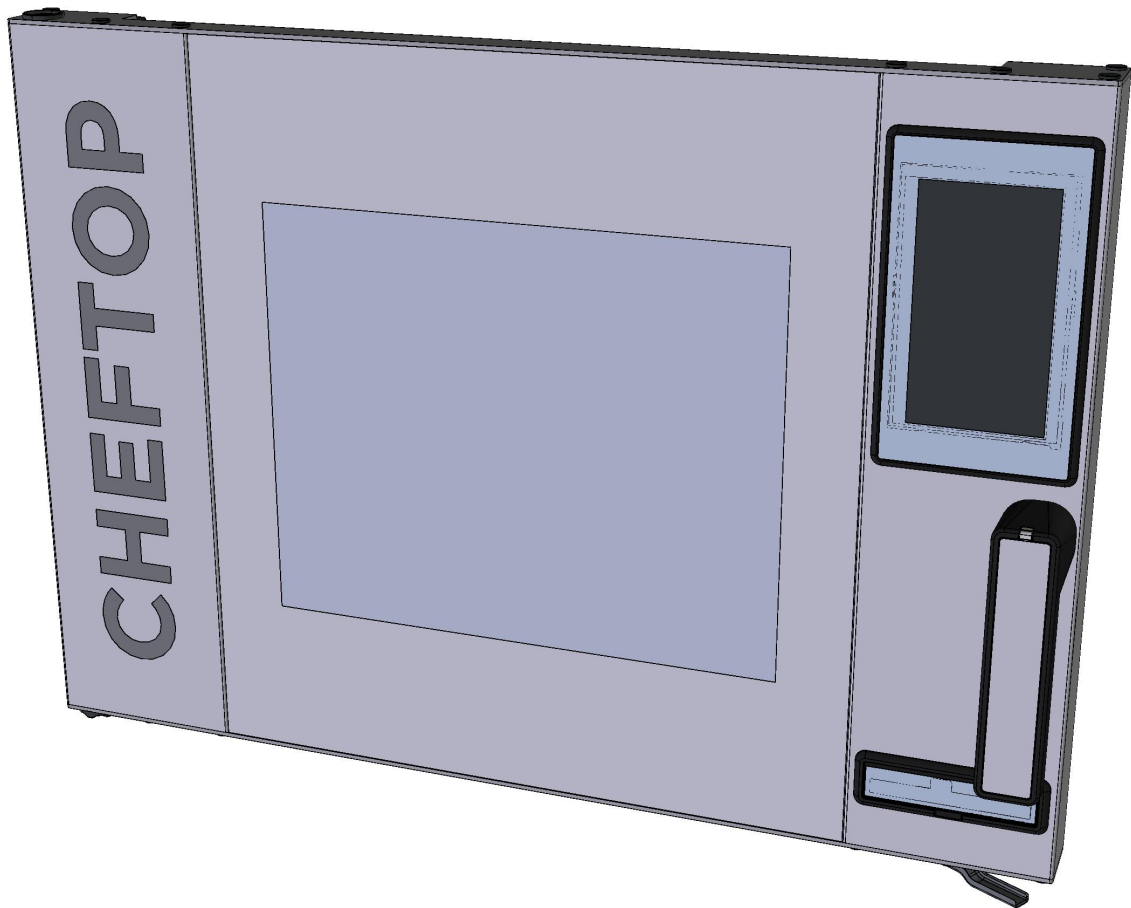

ANVERSO

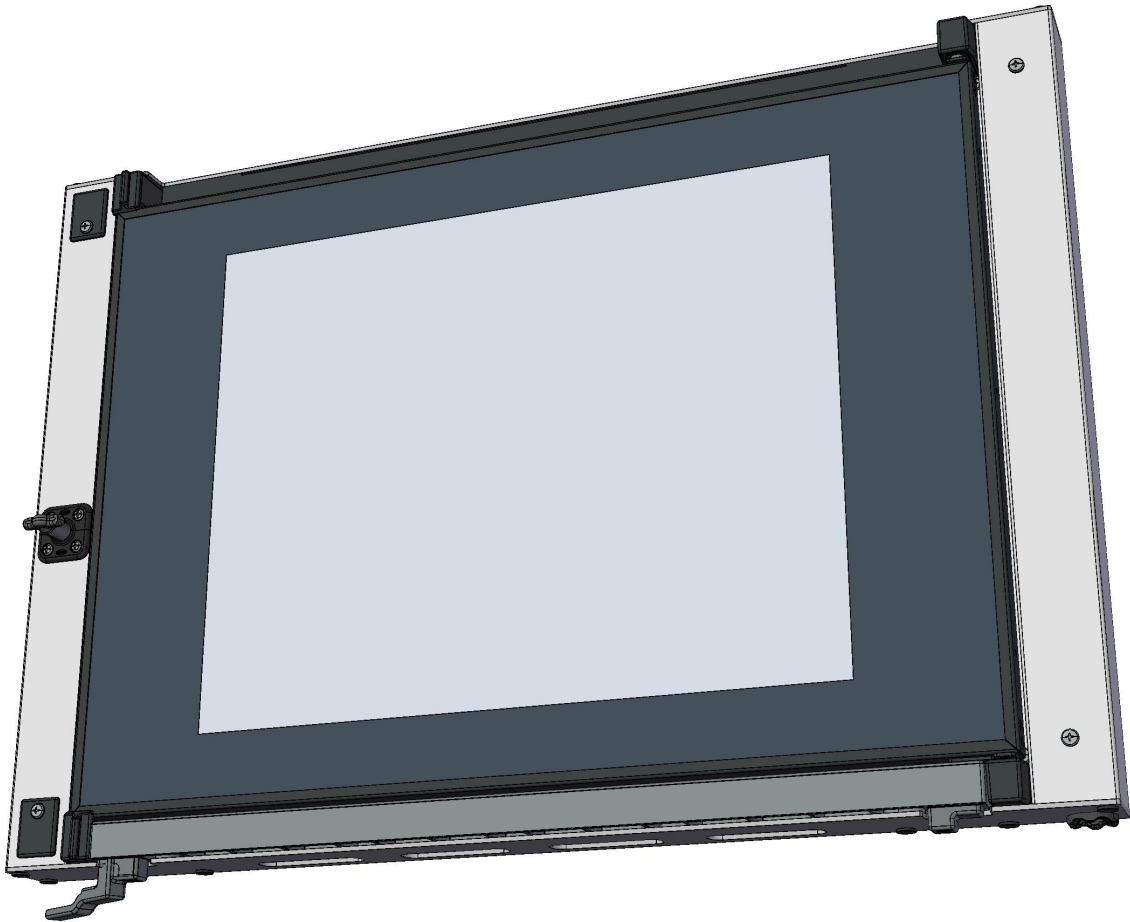

ASM2921A/0.D01 - Puerta

REVERSO

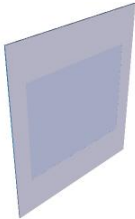





COMPONENTE			REPUESTO																																																						
Código	Descripción	Imagen	Código	Descripción	Lista de componentes																																																				
VT1276A			KVT1276A		<table border="1"> <thead> <tr> <th>Código</th> <th>Descripción</th> <th>Cant.</th> <th>UdM</th> </tr> </thead> <tbody> <tr> <td>0B1166A0</td> <td>PERFIL SOPORTE CRISTAL EXTERIOR</td> <td>2</td> <td>PZ</td> </tr> <tr> <td>IP1508A0</td> <td></td> <td>1</td> <td>PZ</td> </tr> <tr> <td>SL1155A1</td> <td>SILICONA BICOMPONEN TE LOCTITE</td> <td>150</td> <td>ML</td> </tr> <tr> <td>SL1156A0</td> <td>PUNTA PARA PISTOLA SILICONA</td> <td>1</td> <td>PZ</td> </tr> <tr> <td>VM1059A1</td> <td></td> <td>1.500</td> <td>M</td> </tr> <tr> <td>VT1276A0</td> <td></td> <td>1</td> <td>PZ</td> </tr> </tbody> </table>	Código	Descripción	Cant.	UdM	0B1166A0	PERFIL SOPORTE CRISTAL EXTERIOR	2	PZ	IP1508A0		1	PZ	SL1155A1	SILICONA BICOMPONEN TE LOCTITE	150	ML	SL1156A0	PUNTA PARA PISTOLA SILICONA	1	PZ	VM1059A1		1.500	M	VT1276A0		1	PZ																								
Código	Descripción	Cant.	UdM																																																						
0B1166A0	PERFIL SOPORTE CRISTAL EXTERIOR	2	PZ																																																						
IP1508A0		1	PZ																																																						
SL1155A1	SILICONA BICOMPONEN TE LOCTITE	150	ML																																																						
SL1156A0	PUNTA PARA PISTOLA SILICONA	1	PZ																																																						
VM1059A1		1.500	M																																																						
VT1276A0		1	PZ																																																						
MG1083A			KMG1083A	KIT MANETA COMPLETA MIND.MAPS	<table border="1"> <thead> <tr> <th>Código</th> <th>Descripción</th> <th>Cant.</th> <th>UdM</th> </tr> </thead> <tbody> <tr> <td>0H7321A0</td> <td>PLAQUETA TAPA MANETA MM</td> <td>1</td> <td>PZ</td> </tr> <tr> <td>RC1200A0</td> <td>MUELLE COMPRESION DE=4 DFILO=0.</td> <td>4</td> <td>PZ</td> </tr> <tr> <td>VI0239A1</td> <td></td> <td>4</td> <td>PZ</td> </tr> <tr> <td>VI1220A1</td> <td>VITE AUTOFIL. 4.2X12 TCB MARUTEX</td> <td>2</td> <td>PZ</td> </tr> <tr> <td>VM1182B0</td> <td>ENGANCHE AGARRE CON GUIA EJE CT B</td> <td>1</td> <td>PZ</td> </tr> <tr> <td>VM1183A1</td> <td>EJE MANETA CHEFTOP/BAK ERTOP</td> <td>1</td> <td>PZ</td> </tr> <tr> <td>VM1490A0</td> <td>CUBRE TORNILLOS MANETA CHEFTOP/BAK ERTOP</td> <td>2</td> <td>PZ</td> </tr> <tr> <td>VM1695A0</td> <td>EJE POSICION MANETA</td> <td>4</td> <td>PZ</td> </tr> <tr> <td>VM2245A0</td> <td>EJE MANETA CON PESTILL</td> <td>1</td> <td>PZ</td> </tr> <tr> <td>VM2247A0</td> <td>TAPA AGARRE MANETA VM2245-2246</td> <td>1</td> <td>PZ</td> </tr> <tr> <td>VM2248A0</td> <td>LLAVE CIERRE MANETA CON PESTILLO</td> <td>1</td> <td>PZ</td> </tr> <tr> <td>VM2295A0</td> <td>STYLUS PARA CONTROL MM</td> <td>1</td> <td>PZ</td> </tr> </tbody> </table>	Código	Descripción	Cant.	UdM	0H7321A0	PLAQUETA TAPA MANETA MM	1	PZ	RC1200A0	MUELLE COMPRESION DE=4 DFILO=0.	4	PZ	VI0239A1		4	PZ	VI1220A1	VITE AUTOFIL. 4.2X12 TCB MARUTEX	2	PZ	VM1182B0	ENGANCHE AGARRE CON GUIA EJE CT B	1	PZ	VM1183A1	EJE MANETA CHEFTOP/BAK ERTOP	1	PZ	VM1490A0	CUBRE TORNILLOS MANETA CHEFTOP/BAK ERTOP	2	PZ	VM1695A0	EJE POSICION MANETA	4	PZ	VM2245A0	EJE MANETA CON PESTILL	1	PZ	VM2247A0	TAPA AGARRE MANETA VM2245-2246	1	PZ	VM2248A0	LLAVE CIERRE MANETA CON PESTILLO	1	PZ	VM2295A0	STYLUS PARA CONTROL MM	1	PZ
Código	Descripción	Cant.	UdM																																																						
0H7321A0	PLAQUETA TAPA MANETA MM	1	PZ																																																						
RC1200A0	MUELLE COMPRESION DE=4 DFILO=0.	4	PZ																																																						
VI0239A1		4	PZ																																																						
VI1220A1	VITE AUTOFIL. 4.2X12 TCB MARUTEX	2	PZ																																																						
VM1182B0	ENGANCHE AGARRE CON GUIA EJE CT B	1	PZ																																																						
VM1183A1	EJE MANETA CHEFTOP/BAK ERTOP	1	PZ																																																						
VM1490A0	CUBRE TORNILLOS MANETA CHEFTOP/BAK ERTOP	2	PZ																																																						
VM1695A0	EJE POSICION MANETA	4	PZ																																																						
VM2245A0	EJE MANETA CON PESTILL	1	PZ																																																						
VM2247A0	TAPA AGARRE MANETA VM2245-2246	1	PZ																																																						
VM2248A0	LLAVE CIERRE MANETA CON PESTILLO	1	PZ																																																						
VM2295A0	STYLUS PARA CONTROL MM	1	PZ																																																						

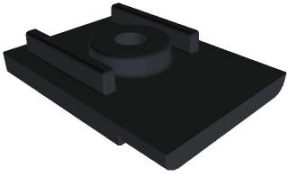

COMPONENTE			REPUESTO		
Código	Descripción	Imagen	Código	Descripción	Lista de componentes
VM2274A			VM2274A0		
VM2305A			VM2305A0		
VI1996A			VI1996A0		
VM2259A			VM2259A0		
VM2305A			VM2305A0		

COMPONENTE			REPUESTO		
Código	Descripción	Imagen	Código	Descripción	Lista de componentes
VM2275A			VM2275A0		
VI1996A			VI1996A0		
VM2260A			VM2260A0		
VM2305A			VM2305A0		
VM2267A			VM2267A0		



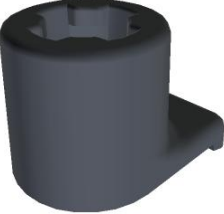

COMPONENTE			REPUESTO														
Código	Descripción	Imagen	Código	Descripción	Lista de componentes												
VM2269A			VM2269A0														
VE1030A	IMAN D=22,9MM PARA MICROPUERT		KVE1020A	KIT MICROPUERTA VE1020A	<table border="1"> <thead> <tr> <th>Código</th> <th>Descripción</th> <th>Cant.</th> <th>UdM</th> </tr> </thead> <tbody> <tr> <td>VE1020A2</td> <td>MICROINTERR UPTOR PUERTA MAGNETICO</td> <td>1</td> <td>PZ</td> </tr> <tr> <td>VE1030A1</td> <td>IMAN D=22,9MM PARA MICROPUERT</td> <td>4</td> <td>PZ</td> </tr> </tbody> </table>	Código	Descripción	Cant.	UdM	VE1020A2	MICROINTERR UPTOR PUERTA MAGNETICO	1	PZ	VE1030A1	IMAN D=22,9MM PARA MICROPUERT	4	PZ
Código	Descripción	Cant.	UdM														
VE1020A2	MICROINTERR UPTOR PUERTA MAGNETICO	1	PZ														
VE1030A1	IMAN D=22,9MM PARA MICROPUERT	4	PZ														
VM2268A			VM2268A0														
VI1996A			VI1996A0														
VM2262A			VM2262A0														



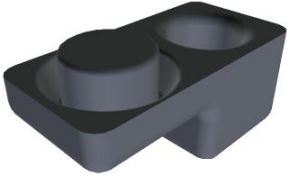

COMPONENTE			REPUESTO														
Código	Descripción	Imagen	Código	Descripción	Lista de componentes												
VM2305A			VM2305A0														
VM2267A			VM2267A0														
VM2269A			VM2269A0														
VE1030A	IMAN D=22,9MM PARA MICROPUERT		KVE1020A	KIT MICROPUERTA VE1020A	<table border="1"> <thead> <tr> <th>Código</th> <th>Descripción</th> <th>Cant.</th> <th>UdM</th> </tr> </thead> <tbody> <tr> <td>VE1020A2</td> <td>MICROINTERR UPTOR PUERTA MAGNETICO</td> <td>1</td> <td>PZ</td> </tr> <tr> <td>VE1030A1</td> <td>IMAN D=22,9MM PARA MICROPUERT</td> <td>4</td> <td>PZ</td> </tr> </tbody> </table>	Código	Descripción	Cant.	UdM	VE1020A2	MICROINTERR UPTOR PUERTA MAGNETICO	1	PZ	VE1030A1	IMAN D=22,9MM PARA MICROPUERT	4	PZ
Código	Descripción	Cant.	UdM														
VE1020A2	MICROINTERR UPTOR PUERTA MAGNETICO	1	PZ														
VE1030A1	IMAN D=22,9MM PARA MICROPUERT	4	PZ														
VM2268A			VM2268A0														

COMPONENTE			REPUESTO																		
Código	Descripción	Imagen	Código	Descripción	Lista de componentes																
VI1996A			VI1996A0																		
VM2261A			VM2261A0																		
PE2044A	MM PLUS VERSION PANEL DE CONTROL		KPE2044A	KIT TARJETA CONTROL MIND.MAPS PLUS	<table border="1"> <thead> <tr> <th>Código</th> <th>Descripción</th> <th>Cant.</th> <th>UdM</th> </tr> </thead> <tbody> <tr> <td>PE2044A0</td> <td>MM PLUS VERSION PANEL DE CONTROL</td> <td>1</td> <td>PZ</td> </tr> <tr> <td>VI2000A0</td> <td></td> <td>4</td> <td>PZ</td> </tr> <tr> <td>VM2147A0</td> <td></td> <td>1</td> <td>PZ</td> </tr> </tbody> </table>	Código	Descripción	Cant.	UdM	PE2044A0	MM PLUS VERSION PANEL DE CONTROL	1	PZ	VI2000A0		4	PZ	VM2147A0		1	PZ
Código	Descripción	Cant.	UdM																		
PE2044A0	MM PLUS VERSION PANEL DE CONTROL	1	PZ																		
VI2000A0		4	PZ																		
VM2147A0		1	PZ																		
PE2046A	CONJUNTO SOPORTE USB-RESET MM		KPE2046A	KIT SOPORTE USB-RESET MIND.MAPS	<table border="1"> <thead> <tr> <th>Código</th> <th>Descripción</th> <th>Cant.</th> <th>UdM</th> </tr> </thead> <tbody> <tr> <td>PE2046A0</td> <td>CONJUNTO SOPORTE USB-RESET M</td> <td>1</td> <td>PZ</td> </tr> <tr> <td>VI1220A1</td> <td>VITE AUTOFIL. 4.2X12 TCB MARUTEX</td> <td>2</td> <td>PZ</td> </tr> </tbody> </table>	Código	Descripción	Cant.	UdM	PE2046A0	CONJUNTO SOPORTE USB-RESET M	1	PZ	VI1220A1	VITE AUTOFIL. 4.2X12 TCB MARUTEX	2	PZ				
Código	Descripción	Cant.	UdM																		
PE2046A0	CONJUNTO SOPORTE USB-RESET M	1	PZ																		
VI1220A1	VITE AUTOFIL. 4.2X12 TCB MARUTEX	2	PZ																		
VM2315A			KVM2315A		<table border="1"> <thead> <tr> <th>Código</th> <th>Descripción</th> <th>Cant.</th> <th>UdM</th> </tr> </thead> <tbody> <tr> <td>VI1220A1</td> <td>VITE AUTOFIL. 4.2X12 TCB MARUTEX</td> <td>3</td> <td>PZ</td> </tr> <tr> <td>VM1630A0</td> <td>TAPON EMPUJA-VIDRI O INTERIOR</td> <td>3</td> <td>PZ</td> </tr> <tr> <td>VM2315A0</td> <td></td> <td>3</td> <td>PZ</td> </tr> </tbody> </table>	Código	Descripción	Cant.	UdM	VI1220A1	VITE AUTOFIL. 4.2X12 TCB MARUTEX	3	PZ	VM1630A0	TAPON EMPUJA-VIDRI O INTERIOR	3	PZ	VM2315A0		3	PZ
Código	Descripción	Cant.	UdM																		
VI1220A1	VITE AUTOFIL. 4.2X12 TCB MARUTEX	3	PZ																		
VM1630A0	TAPON EMPUJA-VIDRI O INTERIOR	3	PZ																		
VM2315A0		3	PZ																		

COMPONENTE			REPUESTO																		
Código	Descripción	Imagen	Código	Descripción	Lista de componentes																
VM1630A	TAPON EMPUJA-VIDRIO INTERIOR		KVM2315A	KIT EMPUJA-VIDRIO INTERIOR H35 S. 5E	<table border="1"> <thead> <tr> <th>Código</th> <th>Descripción</th> <th>Cant.</th> <th>UdM</th> </tr> </thead> <tbody> <tr> <td>VI1220A1</td> <td>VITE AUTOFIL. 4.2X12 TCB MARUTEX</td> <td>3</td> <td>PZ</td> </tr> <tr> <td>VM1630A0</td> <td>TAPON EMPUJA-VIDRI O INTERIOR</td> <td>3</td> <td>PZ</td> </tr> <tr> <td>VM2315A0</td> <td></td> <td>3</td> <td>PZ</td> </tr> </tbody> </table>	Código	Descripción	Cant.	UdM	VI1220A1	VITE AUTOFIL. 4.2X12 TCB MARUTEX	3	PZ	VM1630A0	TAPON EMPUJA-VIDRI O INTERIOR	3	PZ	VM2315A0		3	PZ
			Código		Descripción	Cant.	UdM														
			VI1220A1		VITE AUTOFIL. 4.2X12 TCB MARUTEX	3	PZ														
VM1630A0	TAPON EMPUJA-VIDRI O INTERIOR	3	PZ																		
VM2315A0		3	PZ																		
KVM1591A	<table border="1"> <thead> <tr> <th>Código</th> <th>Descripción</th> <th>Cant.</th> <th>UdM</th> </tr> </thead> <tbody> <tr> <td>VI1220A1</td> <td>VITE AUTOFIL. 4.2X12 TCB MARUTEX</td> <td>2</td> <td>PZ</td> </tr> <tr> <td>VM1591A0</td> <td></td> <td>1</td> <td>PZ</td> </tr> <tr> <td>VM1630A0</td> <td>TAPON EMPUJA-VIDRI O INTERIOR</td> <td>2</td> <td>PZ</td> </tr> </tbody> </table>	Código	Descripción	Cant.	UdM	VI1220A1	VITE AUTOFIL. 4.2X12 TCB MARUTEX	2	PZ	VM1591A0		1	PZ	VM1630A0	TAPON EMPUJA-VIDRI O INTERIOR	2	PZ				
Código	Descripción	Cant.	UdM																		
VI1220A1	VITE AUTOFIL. 4.2X12 TCB MARUTEX	2	PZ																		
VM1591A0		1	PZ																		
VM1630A0	TAPON EMPUJA-VIDRI O INTERIOR	2	PZ																		
KVM1590A	<table border="1"> <thead> <tr> <th>Código</th> <th>Descripción</th> <th>Cant.</th> <th>UdM</th> </tr> </thead> <tbody> <tr> <td>VI1220A1</td> <td>VITE AUTOFIL. 4.2X12 TCB MARUTEX</td> <td>2</td> <td>PZ</td> </tr> <tr> <td>VM1590A0</td> <td></td> <td>1</td> <td>PZ</td> </tr> <tr> <td>VM1630A0</td> <td>TAPON EMPUJA-VIDRI O INTERIOR</td> <td>2</td> <td>PZ</td> </tr> </tbody> </table>	Código	Descripción	Cant.	UdM	VI1220A1	VITE AUTOFIL. 4.2X12 TCB MARUTEX	2	PZ	VM1590A0		1	PZ	VM1630A0	TAPON EMPUJA-VIDRI O INTERIOR	2	PZ				
Código	Descripción	Cant.	UdM																		
VI1220A1	VITE AUTOFIL. 4.2X12 TCB MARUTEX	2	PZ																		
VM1590A0		1	PZ																		
VM1630A0	TAPON EMPUJA-VIDRI O INTERIOR	2	PZ																		
VM2371A			KVM2371A		<table border="1"> <thead> <tr> <th>Código</th> <th>Descripción</th> <th>Cant.</th> <th>UdM</th> </tr> </thead> <tbody> <tr> <td>VI1220A1</td> <td>VITE AUTOFIL. 4.2X12 TCB MARUTEX</td> <td>3</td> <td>PZ</td> </tr> <tr> <td>VM2371A0</td> <td></td> <td>3</td> <td>PZ</td> </tr> </tbody> </table>	Código	Descripción	Cant.	UdM	VI1220A1	VITE AUTOFIL. 4.2X12 TCB MARUTEX	3	PZ	VM2371A0		3	PZ				
Código	Descripción	Cant.	UdM																		
VI1220A1	VITE AUTOFIL. 4.2X12 TCB MARUTEX	3	PZ																		
VM2371A0		3	PZ																		
VM2284A			KVM2284A	KIT PERFIL DE GOTEO SERIE 750	<table border="1"> <thead> <tr> <th>Código</th> <th>Descripción</th> <th>Cant.</th> <th>UdM</th> </tr> </thead> <tbody> <tr> <td>VM2284A0</td> <td></td> <td>1</td> <td>PZ</td> </tr> </tbody> </table>	Código	Descripción	Cant.	UdM	VM2284A0		1	PZ								
Código	Descripción	Cant.	UdM																		
VM2284A0		1	PZ																		

COMPONENTE			REPUESTO																		
Código	Descripción	Imagen	Código	Descripción	Lista de componentes																
VM2314A			VM2314A0																		
VM2313A			VM2313A0																		
LP1019A			KLP1019A	KIT BARRA LUCES LED 0511-04EU	<table border="1"> <thead> <tr> <th>Código</th> <th>Descripción</th> <th>Cant.</th> <th>UdM</th> </tr> </thead> <tbody> <tr> <td>IP1385A1</td> <td></td> <td>0.900</td> <td>M</td> </tr> <tr> <td>LP1019A0</td> <td></td> <td>1</td> <td>PZ</td> </tr> <tr> <td>VM1058A1</td> <td></td> <td>0.900</td> <td>M</td> </tr> </tbody> </table>	Código	Descripción	Cant.	UdM	IP1385A1		0.900	M	LP1019A0		1	PZ	VM1058A1		0.900	M
Código	Descripción	Cant.	UdM																		
IP1385A1		0.900	M																		
LP1019A0		1	PZ																		
VM1058A1		0.900	M																		
LP1025A			KLP1025A	KIT PORTA LUCES LED 0511-04EU	<table border="1"> <thead> <tr> <th>Código</th> <th>Descripción</th> <th>Cant.</th> <th>UdM</th> </tr> </thead> <tbody> <tr> <td>IP1385A1</td> <td></td> <td>0.900</td> <td>M</td> </tr> <tr> <td>LP1025A0</td> <td></td> <td>1</td> <td>PZ</td> </tr> <tr> <td>VM1058A1</td> <td></td> <td>0.900</td> <td>M</td> </tr> </tbody> </table>	Código	Descripción	Cant.	UdM	IP1385A1		0.900	M	LP1025A0		1	PZ	VM1058A1		0.900	M
Código	Descripción	Cant.	UdM																		
IP1385A1		0.900	M																		
LP1025A0		1	PZ																		
VM1058A1		0.900	M																		
VM2316A			VM2316A0																		

COMPONENTE			REPUESTO																														
Código	Descripción	Imagen	Código	Descripción	Lista de componentes																												
VN1177A			KVN1177A	KIT TURBINA REFRIGERACION PANEL CONTROL	<table border="1"> <thead> <tr> <th>Código</th> <th>Descripción</th> <th>Cant.</th> <th>UdM</th> </tr> </thead> <tbody> <tr> <td>VN1177A0</td> <td></td> <td>1</td> <td>PZ</td> </tr> </tbody> </table>	Código	Descripción	Cant.	UdM	VN1177A0		1	PZ																				
Código	Descripción	Cant.	UdM																														
VN1177A0		1	PZ																														
CE1285A	FERRITA EMI ROUND MOD.2643801502																																
CE1275A			KCE1275A	KIT CABLE DE CONEXION CE1275A	<table border="1"> <thead> <tr> <th>Código</th> <th>Descripción</th> <th>Cant.</th> <th>UdM</th> </tr> </thead> <tbody> <tr> <td>CE1285A0</td> <td>FERRITA EMI ROUND MOD.2643801502</td> <td>1</td> <td>PZ</td> </tr> <tr> <td>CE1290A0</td> <td></td> <td>1</td> <td>PZ</td> </tr> <tr> <td>CE1455A0</td> <td></td> <td>4</td> <td>PZ</td> </tr> <tr> <td>CE1725A0</td> <td></td> <td>3</td> <td>M</td> </tr> <tr> <td>CE1735A0</td> <td></td> <td>4</td> <td>PZ</td> </tr> <tr> <td>CE1755A0</td> <td></td> <td>1</td> <td>PZ</td> </tr> </tbody> </table>	Código	Descripción	Cant.	UdM	CE1285A0	FERRITA EMI ROUND MOD.2643801502	1	PZ	CE1290A0		1	PZ	CE1455A0		4	PZ	CE1725A0		3	M	CE1735A0		4	PZ	CE1755A0		1	PZ
Código	Descripción	Cant.	UdM																														
CE1285A0	FERRITA EMI ROUND MOD.2643801502	1	PZ																														
CE1290A0		1	PZ																														
CE1455A0		4	PZ																														
CE1725A0		3	M																														
CE1735A0		4	PZ																														
CE1755A0		1	PZ																														
0B1106A			0B1106A0																														
0B1108A			0B1108A0																														

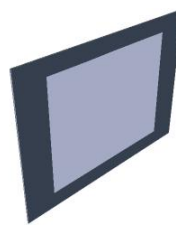
COMPONENTE			REPUESTO																						
Código	Descripción	Imagen	Código	Descripción	Lista de componentes																				
0B1107A			0B1107A0																						
0B1109A			0B1109A0																						
0B1122A			0B1122A0																						
CE1053B																									
VT1284A	CRISTAL INT. SER. 0511 639X454X4 2V		KVT1284A	KIT CRISTAL INTERNO XEVC-0511 2 VIDRIO	<table border="1"> <thead> <tr> <th>Código</th> <th>Descripción</th> <th>Cant.</th> <th>UdM</th> </tr> </thead> <tbody> <tr> <td>IP1508A0</td> <td></td> <td>2</td> <td>PZ</td> </tr> <tr> <td>VM1059A1</td> <td></td> <td>1.500</td> <td>M</td> </tr> <tr> <td>VT1284A0</td> <td>CRISTAL INTERNO XEVC-0511-E 2 VIDRIOS</td> <td>1</td> <td>PZ</td> </tr> <tr> <td>VT1284A1</td> <td>CRISTAL INT. SER. 0511 639X454X4 2V</td> <td>1</td> <td>PZ</td> </tr> </tbody> </table>	Código	Descripción	Cant.	UdM	IP1508A0		2	PZ	VM1059A1		1.500	M	VT1284A0	CRISTAL INTERNO XEVC-0511-E 2 VIDRIOS	1	PZ	VT1284A1	CRISTAL INT. SER. 0511 639X454X4 2V	1	PZ
Código	Descripción	Cant.	UdM																						
IP1508A0		2	PZ																						
VM1059A1		1.500	M																						
VT1284A0	CRISTAL INTERNO XEVC-0511-E 2 VIDRIOS	1	PZ																						
VT1284A1	CRISTAL INT. SER. 0511 639X454X4 2V	1	PZ																						

COMPONENTE			REPUESTO										
Código	Descripción	Imagen	Código	Descripción	Lista de componentes								
CR1105A			CR1105A0										
CR1106A			CR1106A0										
CE1052A			KCE1052A		<table border="1"> <thead> <tr> <th>Código</th> <th>Descripción</th> <th>Cant.</th> <th>UdM</th> </tr> </thead> <tbody> <tr> <td>CE1052A0</td> <td></td> <td>1</td> <td>PZ</td> </tr> </tbody> </table>	Código	Descripción	Cant.	UdM	CE1052A0		1	PZ
Código	Descripción	Cant.	UdM										
CE1052A0		1	PZ										
OB1216A			OB1216A0										
OB1217A			OB1217A0										