

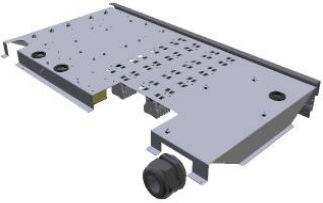





Assembly code	Assembly revision	Assembly image
ASM1809A/0.D01	Electrical system	
ASM1817A/0.D04	Door	
ASM1800A/0.D02	External cover	
ASM1804A/0.D02	Cooking chamber	

ASM1809A/0.D01 - Electrical system

FRONT

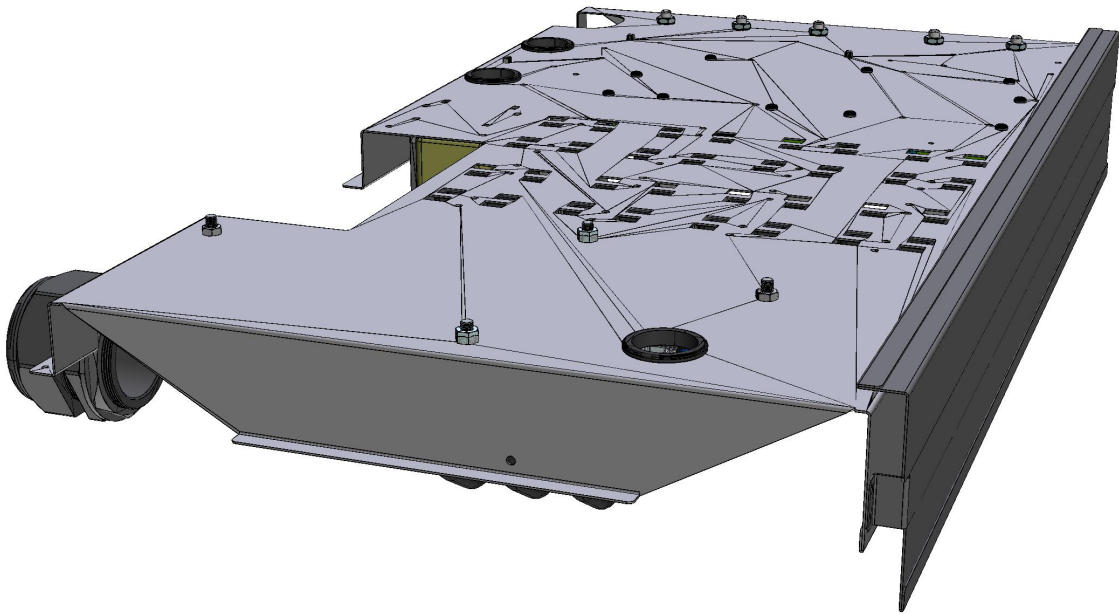



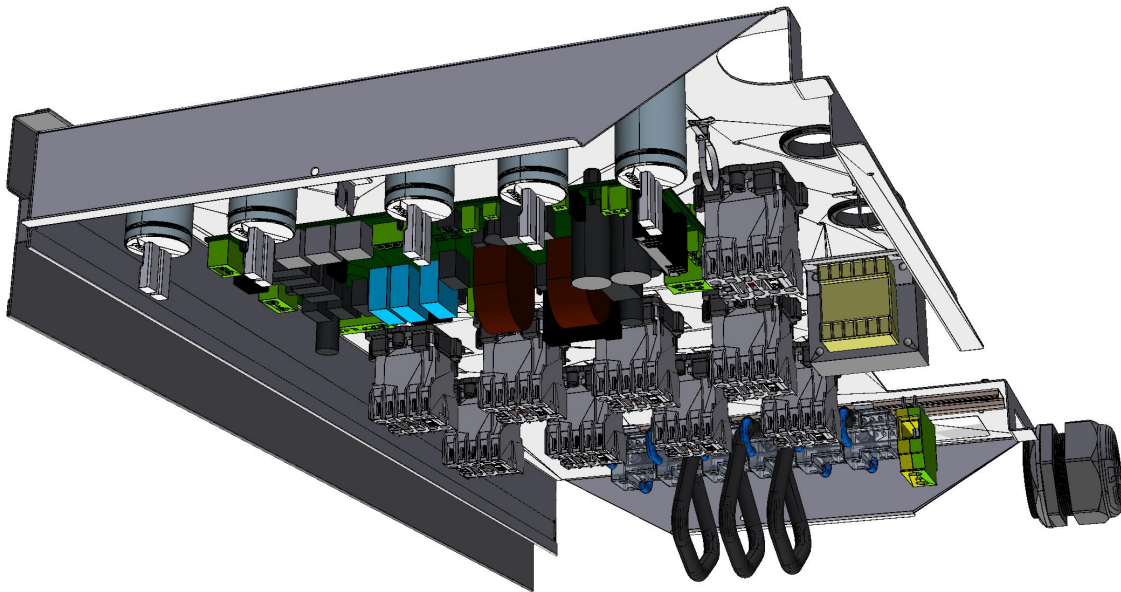

ASM1809A/0.D01 - Electrical system

REAR

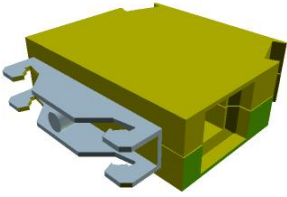

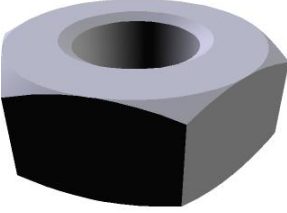
COMPONENT			SPARE PART																		
Code	Description	Image	Code	Description	Components list																
CN1003A	6,3 UF MOTOR CAPACITOR		KCN1003A	6,3 UF MOTOR CAPACITOR KIT	<table border="1"> <thead> <tr> <th>Code</th> <th>Description</th> <th>Qty</th> <th>UOM</th> </tr> </thead> <tbody> <tr> <td>CN1003A0</td> <td>6,3 UF MOTOR CAPACITOR</td> <td>1</td> <td>PZ</td> </tr> <tr> <td>VI1931A0</td> <td>M8 NUT+INDENTE D WASHER D=8 X COND.</td> <td>1</td> <td>PZ</td> </tr> <tr> <td>VI1932A0</td> <td>M8 NUT+INDENTE D WASHER D=8 X COND.</td> <td>1</td> <td>PZ</td> </tr> </tbody> </table>	Code	Description	Qty	UOM	CN1003A0	6,3 UF MOTOR CAPACITOR	1	PZ	VI1931A0	M8 NUT+INDENTE D WASHER D=8 X COND.	1	PZ	VI1932A0	M8 NUT+INDENTE D WASHER D=8 X COND.	1	PZ
Code	Description	Qty	UOM																		
CN1003A0	6,3 UF MOTOR CAPACITOR	1	PZ																		
VI1931A0	M8 NUT+INDENTE D WASHER D=8 X COND.	1	PZ																		
VI1932A0	M8 NUT+INDENTE D WASHER D=8 X COND.	1	PZ																		
VE1115A	20 A 230V 4 POLES MINICONTRACTOR		KVE1115A	20A 230V 4 POLES MINICONTRACTOR KI	<table border="1"> <thead> <tr> <th>Code</th> <th>Description</th> <th>Qty</th> <th>UOM</th> </tr> </thead> <tbody> <tr> <td>VE1115A0</td> <td>20 A 230V 4 POLES MINICONTRACTOR</td> <td>1</td> <td>PZ</td> </tr> <tr> <td>VM1075A1</td> <td>PLASTIC CLIP TO FIX CONTACTORS</td> <td>4</td> <td>PZ</td> </tr> </tbody> </table>	Code	Description	Qty	UOM	VE1115A0	20 A 230V 4 POLES MINICONTRACTOR	1	PZ	VM1075A1	PLASTIC CLIP TO FIX CONTACTORS	4	PZ				
Code	Description	Qty	UOM																		
VE1115A0	20 A 230V 4 POLES MINICONTRACTOR	1	PZ																		
VM1075A1	PLASTIC CLIP TO FIX CONTACTORS	4	PZ																		
VM1056A	SMALL CONTACTOR BRACKET VE1115A		VM1056A0	SMALL CONTACTOR BRACKET VE1115A																	
VE1644A	PG 29 STRAIN RELIEF NUT		VE1644A0	PG 29 STRAIN RELIEF NUT																	
CE1420A	8 WAYS UNIPOLAR TERMINAL BLOCK Z16-8D		KCE1420A	8 WAY Z16-8D UNIPOLAR TERMINAL BOARD KIT	<table border="1"> <thead> <tr> <th>Code</th> <th>Description</th> <th>Qty</th> <th>UOM</th> </tr> </thead> <tbody> <tr> <td>CE1420A0</td> <td>8 WAYS UNIPOLAR TERMINAL BLOCK Z16-8D</td> <td>1</td> <td>PZ</td> </tr> </tbody> </table>	Code	Description	Qty	UOM	CE1420A0	8 WAYS UNIPOLAR TERMINAL BLOCK Z16-8D	1	PZ								
Code	Description	Qty	UOM																		
CE1420A0	8 WAYS UNIPOLAR TERMINAL BLOCK Z16-8D	1	PZ																		

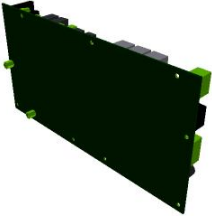
COMPONENT			SPARE PART																						
Code	Description	Image	Code	Description	Components list																				
MR1011A	UL 125A GROUND TERMINAL		KMR1011A	UL 125A GROUND TERMINAL KIT	<table border="1"> <thead> <tr> <th>Code</th> <th>Description</th> <th>Qty</th> <th>UOM</th> </tr> </thead> <tbody> <tr> <td>MR1011A0</td> <td>UL 125A GROUND TERMINAL</td> <td>1</td> <td>PZ</td> </tr> </tbody> </table>	Code	Description	Qty	UOM	MR1011A0	UL 125A GROUND TERMINAL	1	PZ												
Code	Description	Qty	UOM																						
MR1011A0	UL 125A GROUND TERMINAL	1	PZ																						
VE1628A	REDUCED STRAIN RELIEF PG 48		VE1628A0	REDUCED STRAIN RELIEF PG 48																					
VI1327A	M6 ZN H=4 NUT																								
OH7374A	CORE PROBE CABLE PLATE		OH7374A0	CORE PROBE CABLE PLATE																					
PE2037A	MIND.MAPS ONE POWER CARD		KPE2037A	MIND.MAPS ONE POWER BOARD KIT	<table border="1"> <thead> <tr> <th>Code</th> <th>Description</th> <th>Qty</th> <th>UOM</th> </tr> </thead> <tbody> <tr> <td>PE2037A0</td> <td>MIND.MAPS ONE POWER CARD</td> <td>1</td> <td>PZ</td> </tr> <tr> <td>V11850A0</td> <td>M4X6 NICKEL PLATED FIXING SCRE</td> <td>9</td> <td>PZ</td> </tr> <tr> <td>VM1745A0</td> <td>CARD SUPPORT</td> <td>9</td> <td>PZ</td> </tr> <tr> <td>VM2147A0</td> <td>ESD SPONGE PINK SMOOTH 410X343X15 M</td> <td>1</td> <td>PZ</td> </tr> </tbody> </table>	Code	Description	Qty	UOM	PE2037A0	MIND.MAPS ONE POWER CARD	1	PZ	V11850A0	M4X6 NICKEL PLATED FIXING SCRE	9	PZ	VM1745A0	CARD SUPPORT	9	PZ	VM2147A0	ESD SPONGE PINK SMOOTH 410X343X15 M	1	PZ
Code	Description	Qty	UOM																						
PE2037A0	MIND.MAPS ONE POWER CARD	1	PZ																						
V11850A0	M4X6 NICKEL PLATED FIXING SCRE	9	PZ																						
VM1745A0	CARD SUPPORT	9	PZ																						
VM2147A0	ESD SPONGE PINK SMOOTH 410X343X15 M	1	PZ																						

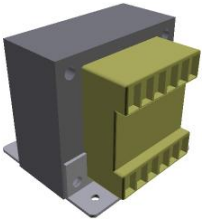

COMPONENT			SPARE PART														
Code	Description	Image	Code	Description	Components list												
VE1639A	TRANSFORMER 230-12VAC 60VA		KVE1639A	230-12VAC 60VA TRANSFORMER KIT	<table border="1"> <thead> <tr> <th>Code</th> <th>Description</th> <th>Qty</th> <th>UOM</th> </tr> </thead> <tbody> <tr> <td>VE1639A0</td> <td>TRANSFORME R 230-12VAC 60VA</td> <td>1</td> <td>PZ</td> </tr> <tr> <td>VI1950A0</td> <td>ST. STEEL 4,2X13 TCB SELF-DRILLIN G SCREW</td> <td>4</td> <td>PZ</td> </tr> </tbody> </table>	Code	Description	Qty	UOM	VE1639A0	TRANSFORME R 230-12VAC 60VA	1	PZ	VI1950A0	ST. STEEL 4,2X13 TCB SELF-DRILLIN G SCREW	4	PZ
Code	Description	Qty	UOM														
VE1639A0	TRANSFORME R 230-12VAC 60VA	1	PZ														
VI1950A0	ST. STEEL 4,2X13 TCB SELF-DRILLIN G SCREW	4	PZ														

ASM1817A/0.D04 - Door

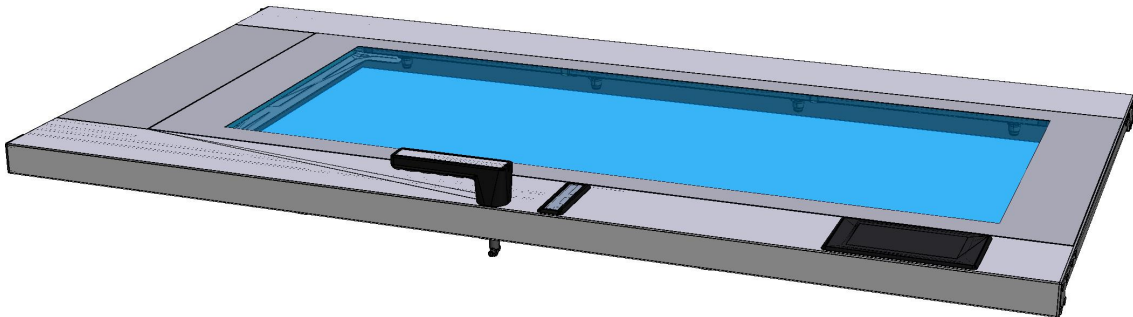

FRONT

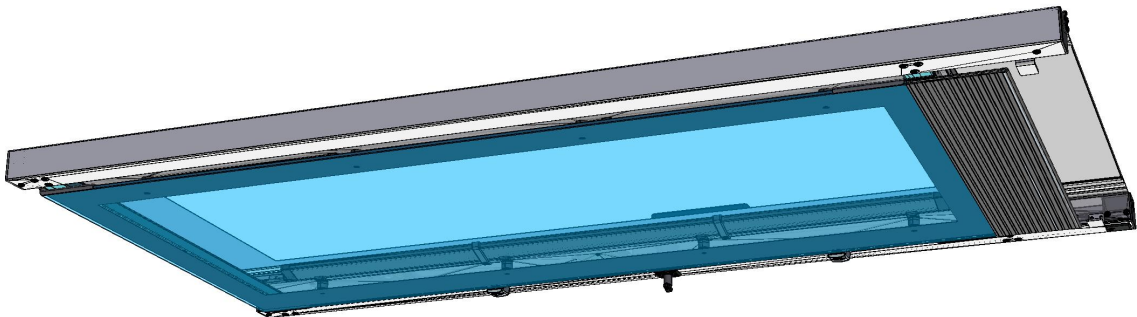

ASM1817A/0.D04 - Door

REAR





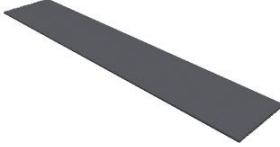

COMPONENT			SPARE PART																																																						
Code	Description	Image	Code	Description	Components list																																																				
MG1083A	MIND.MAPS DOOR COMPLETE HANDLE		KMG1083A	MIND.MAPS SERIES HANDLE KIT	<table border="1"> <thead> <tr> <th>Code</th> <th>Description</th> <th>Qty</th> <th>UOM</th> </tr> </thead> <tbody> <tr> <td>0H7321A0</td> <td>MM STAINLESS STEEL HANDLE COVE</td> <td>1</td> <td>PZ</td> </tr> <tr> <td>RC1200A0</td> <td>ED=4 WIRE D.=0.5 COMPRESSIO N SPRING</td> <td>4</td> <td>PZ</td> </tr> <tr> <td>VI0239A1</td> <td>SELF-TAPPIN G SCREW 4.2X25 TCB+ INOX</td> <td>8</td> <td>PZ</td> </tr> <tr> <td>VI1220A1</td> <td>4,2X12 TCB SELF-TAPPIN G SCREW</td> <td>2</td> <td>PZ</td> </tr> <tr> <td>VM1182B1</td> <td>E S. CT BT HANDLE JUNCTION + PIN GUIDE</td> <td>1</td> <td>PZ</td> </tr> <tr> <td>VM1183B0</td> <td>CHEFTOP/BAK ERTOP HANDLE PIN</td> <td>1</td> <td>PZ</td> </tr> <tr> <td>VM1490A0</td> <td>CHEFTOP/BAK ERTOP HANDLE SCREWS COVER</td> <td>2</td> <td>PZ</td> </tr> <tr> <td>VM1695A0</td> <td>HANDLE POSITION PIN</td> <td>4</td> <td>PZ</td> </tr> <tr> <td>VM2245A0</td> <td>HANDLE SHAFT WITH LATCH</td> <td>1</td> <td>PZ</td> </tr> <tr> <td>VM2247A0</td> <td>HANDLE SHAFT COVER VM2245-2246</td> <td>1</td> <td>PZ</td> </tr> <tr> <td>VM2248B0</td> <td>CLOSING HANDLE KEY WITH LATCH</td> <td>1</td> <td>PZ</td> </tr> <tr> <td>VM2295A0</td> <td>STYLUS PEN FOR MM</td> <td>1</td> <td>PZ</td> </tr> </tbody> </table>	Code	Description	Qty	UOM	0H7321A0	MM STAINLESS STEEL HANDLE COVE	1	PZ	RC1200A0	ED=4 WIRE D.=0.5 COMPRESSIO N SPRING	4	PZ	VI0239A1	SELF-TAPPIN G SCREW 4.2X25 TCB+ INOX	8	PZ	VI1220A1	4,2X12 TCB SELF-TAPPIN G SCREW	2	PZ	VM1182B1	E S. CT BT HANDLE JUNCTION + PIN GUIDE	1	PZ	VM1183B0	CHEFTOP/BAK ERTOP HANDLE PIN	1	PZ	VM1490A0	CHEFTOP/BAK ERTOP HANDLE SCREWS COVER	2	PZ	VM1695A0	HANDLE POSITION PIN	4	PZ	VM2245A0	HANDLE SHAFT WITH LATCH	1	PZ	VM2247A0	HANDLE SHAFT COVER VM2245-2246	1	PZ	VM2248B0	CLOSING HANDLE KEY WITH LATCH	1	PZ	VM2295A0	STYLUS PEN FOR MM	1	PZ
					Code	Description	Qty	UOM																																																	
					0H7321A0	MM STAINLESS STEEL HANDLE COVE	1	PZ																																																	
					RC1200A0	ED=4 WIRE D.=0.5 COMPRESSIO N SPRING	4	PZ																																																	
					VI0239A1	SELF-TAPPIN G SCREW 4.2X25 TCB+ INOX	8	PZ																																																	
					VI1220A1	4,2X12 TCB SELF-TAPPIN G SCREW	2	PZ																																																	
					VM1182B1	E S. CT BT HANDLE JUNCTION + PIN GUIDE	1	PZ																																																	
					VM1183B0	CHEFTOP/BAK ERTOP HANDLE PIN	1	PZ																																																	
					VM1490A0	CHEFTOP/BAK ERTOP HANDLE SCREWS COVER	2	PZ																																																	
					VM1695A0	HANDLE POSITION PIN	4	PZ																																																	
					VM2245A0	HANDLE SHAFT WITH LATCH	1	PZ																																																	
					VM2247A0	HANDLE SHAFT COVER VM2245-2246	1	PZ																																																	
					VM2248B0	CLOSING HANDLE KEY WITH LATCH	1	PZ																																																	
VM2295A0	STYLUS PEN FOR MM	1	PZ																																																						
VM2315A	MIND.MAPS INTERNAL GLASS CAP SUPPORT		KVM2315A	MM INTERNAL GLASS SUPPORT KI	<table border="1"> <thead> <tr> <th>Code</th> <th>Description</th> <th>Qty</th> <th>UOM</th> </tr> </thead> <tbody> <tr> <td>VI1220A1</td> <td>4,2X12 TCB SELF-TAPPIN G SCREW</td> <td>3</td> <td>PZ</td> </tr> <tr> <td>VM1630A0</td> <td>INTERNAL GLASS PUSHING CAP</td> <td>3</td> <td>PZ</td> </tr> <tr> <td>VM2315A0</td> <td>MIND.MAPS INTERNAL GLASS CAP SUPPORT</td> <td>3</td> <td>PZ</td> </tr> </tbody> </table>	Code	Description	Qty	UOM	VI1220A1	4,2X12 TCB SELF-TAPPIN G SCREW	3	PZ	VM1630A0	INTERNAL GLASS PUSHING CAP	3	PZ	VM2315A0	MIND.MAPS INTERNAL GLASS CAP SUPPORT	3	PZ																																				
					Code	Description	Qty	UOM																																																	
					VI1220A1	4,2X12 TCB SELF-TAPPIN G SCREW	3	PZ																																																	
VM1630A0	INTERNAL GLASS PUSHING CAP	3	PZ																																																						
VM2315A0	MIND.MAPS INTERNAL GLASS CAP SUPPORT	3	PZ																																																						

COMPONENT			SPARE PART																						
Code	Description	Image	Code	Description	Components list																				
VM1630A	INTERNAL GLASS PUSHING CAP		KVM1630A	CAP FOR INTERNAL GLASS 10 PCS KIT	<table border="1"> <thead> <tr> <th>Code</th> <th>Description</th> <th>Qty</th> <th>UOM</th> </tr> </thead> <tbody> <tr> <td>VM1630A0</td> <td>INTERNAL GLASS PUSHING CAP</td> <td>10</td> <td>PZ</td> </tr> </tbody> </table>	Code	Description	Qty	UOM	VM1630A0	INTERNAL GLASS PUSHING CAP	10	PZ												
Code	Description	Qty	UOM																						
VM1630A0	INTERNAL GLASS PUSHING CAP	10	PZ																						
VM2371A	DOUBLE GLASS DOOR PUSHING BRACKET		KVM2371A	INTERNAL DOUBLE GLASS SUPPORT 3 PCS KIT	<table border="1"> <thead> <tr> <th>Code</th> <th>Description</th> <th>Qty</th> <th>UOM</th> </tr> </thead> <tbody> <tr> <td>V11220A1</td> <td>4,2X12 TCB SELF-TAPPING SCREW</td> <td>3</td> <td>PZ</td> </tr> <tr> <td>VM2371A0</td> <td>DOUBLE GLASS DOOR PUSHING BRACKET</td> <td>3</td> <td>PZ</td> </tr> <tr> <td>VM2371A0</td> <td>DOUBLE GLASS DOOR PUSHING BRACKET</td> <td>3</td> <td>PZ</td> </tr> </tbody> </table>	Code	Description	Qty	UOM	V11220A1	4,2X12 TCB SELF-TAPPING SCREW	3	PZ	VM2371A0	DOUBLE GLASS DOOR PUSHING BRACKET	3	PZ	VM2371A0	DOUBLE GLASS DOOR PUSHING BRACKET	3	PZ				
Code	Description	Qty	UOM																						
V11220A1	4,2X12 TCB SELF-TAPPING SCREW	3	PZ																						
VM2371A0	DOUBLE GLASS DOOR PUSHING BRACKET	3	PZ																						
VM2371A0	DOUBLE GLASS DOOR PUSHING BRACKET	3	PZ																						
VN1177A	CONTROL BOARD COOLING FAN		KVN1177A	CONTROL BOARD COOLING FAN KIT	<table border="1"> <thead> <tr> <th>Code</th> <th>Description</th> <th>Qty</th> <th>UOM</th> </tr> </thead> <tbody> <tr> <td>VN1177A0</td> <td>CONTROL BOARD COOLING FAN</td> <td>1</td> <td>PZ</td> </tr> <tr> <td>VN1177A0</td> <td>CONTROL BOARD COOLING FAN</td> <td>1</td> <td>PZ</td> </tr> </tbody> </table>	Code	Description	Qty	UOM	VN1177A0	CONTROL BOARD COOLING FAN	1	PZ	VN1177A0	CONTROL BOARD COOLING FAN	1	PZ								
Code	Description	Qty	UOM																						
VN1177A0	CONTROL BOARD COOLING FAN	1	PZ																						
VN1177A0	CONTROL BOARD COOLING FAN	1	PZ																						
VM2316A	CONTROL BOARD COOLING FAN HOLDER		<p>KVM2518A</p> <p>KVM2316A</p>	<p>PANEL COOLING FAN SUPPORT KIT</p> <p>PANEL COOLING FAN SUPPORT KIT</p>	<table border="1"> <thead> <tr> <th>Code</th> <th>Description</th> <th>Qty</th> <th>UOM</th> </tr> </thead> <tbody> <tr> <td>VM2518A0</td> <td>BOARD COOLING FAN SUPPORT</td> <td>1</td> <td>PZ</td> </tr> <tr> <td>VM2518A0</td> <td>BOARD COOLING FAN SUPPORT</td> <td>1</td> <td>PZ</td> </tr> <tr> <th>Code</th> <th>Description</th> <th>Qty</th> <th>UOM</th> </tr> <tr> <td>VM2316A0</td> <td>CONTROL BOARD COOLING FAN HOLDER</td> <td>1</td> <td>PZ</td> </tr> </tbody> </table>	Code	Description	Qty	UOM	VM2518A0	BOARD COOLING FAN SUPPORT	1	PZ	VM2518A0	BOARD COOLING FAN SUPPORT	1	PZ	Code	Description	Qty	UOM	VM2316A0	CONTROL BOARD COOLING FAN HOLDER	1	PZ
Code	Description	Qty	UOM																						
VM2518A0	BOARD COOLING FAN SUPPORT	1	PZ																						
VM2518A0	BOARD COOLING FAN SUPPORT	1	PZ																						
Code	Description	Qty	UOM																						
VM2316A0	CONTROL BOARD COOLING FAN HOLDER	1	PZ																						

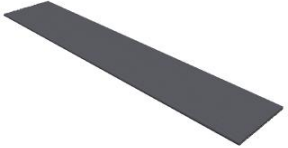
COMPONENT			SPARE PART											
Code	Description	Image	Code	Description	Components list									
VE1030A	MAGNET FOR DOOR MICROSWITCH D=22,9MM		KVE1030A	2 PCS MAGNET KIT FOR DOOR SWITCH	<table border="1"> <thead> <tr> <th>Code</th> <th>Description</th> <th>Qty</th> <th>UOM</th> </tr> </thead> <tbody> <tr> <td>VE1030A1</td> <td>MAGNET FOR DOOR MICROSWITC H D=22,9MM</td> <td>2</td> <td>PZ</td> </tr> </tbody> </table>	Code	Description	Qty	UOM	VE1030A1	MAGNET FOR DOOR MICROSWITC H D=22,9MM	2	PZ	
			Code	Description	Qty	UOM								
VE1030A1	MAGNET FOR DOOR MICROSWITC H D=22,9MM	2	PZ											
KVE1020A	MICROSWITCH KIT	<table border="1"> <thead> <tr> <th>Code</th> <th>Description</th> <th>Qty</th> <th>UOM</th> </tr> </thead> <tbody> <tr> <td>VE1020A2</td> <td>MAGNETIC DOOR MICROSWITC</td> <td>1</td> <td>PZ</td> </tr> <tr> <td>VE1030A1</td> <td>MAGNET FOR DOOR MICROSWITC H D=22,9MM</td> <td>4</td> <td>PZ</td> </tr> </tbody> </table>	Code	Description	Qty	UOM	VE1020A2	MAGNETIC DOOR MICROSWITC	1	PZ	VE1030A1	MAGNET FOR DOOR MICROSWITC H D=22,9MM	4	PZ
Code	Description	Qty	UOM											
VE1020A2	MAGNETIC DOOR MICROSWITC	1	PZ											
VE1030A1	MAGNET FOR DOOR MICROSWITC H D=22,9MM	4	PZ											
0H7242A	XEVC-2011 DOOR GLASS SUPPORT PLATE		0H7242A0	XEVC-2011 DOOR GLASS SUPPORT PLATE										
0H7243A	XEVC-2011 LOWER DOOR PROFILE		0H7243A0	XEVC-2011 LOWER DOOR PROFILE										
0H7244A	XEVC-2011 INT.DOOR GLASS LOWER FRAME		0H7244A0	XEVC-2011 INT.DOOR GLASS LOWER FRAME										
0H7245A	XEVC-2011 INT.DOOR GLASS UPPER FRAME		0H7245A0	XEVC-2011 INT.DOOR GLASS UPPER FRAME										

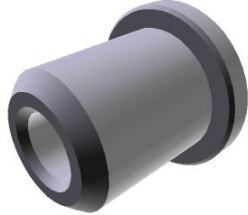
COMPONENT			SPARE PART																																																																					
Code	Description	Image	Code	Description	Components list																																																																			
0H7246A	XEVC-2011 GASKET HOLDER PLATE		<p>KGN1553A</p> <p>MIND.MAPS DOOR-TROLLEY GASKET KIT</p> <p>KGN1341B</p> <p>1005E-4005E TROLLEY DOOR GASKET KIT</p>	<table border="1"> <thead> <tr> <th>Code</th> <th>Description</th> <th>Qty</th> <th>UOM</th> </tr> </thead> <tbody> <tr> <td>0H7246A0</td> <td>XEVC-2011 GASKET HOLDER PLAT</td> <td>1</td> <td>PZ</td> </tr> <tr> <td>GN1341B0</td> <td>DOOR-TROLL EY SEALING</td> <td>0.750</td> <td>M</td> </tr> <tr> <td>SL1170A1</td> <td>S53 BLACK SILICON - 310ML CARTRIDGE</td> <td>280</td> <td>ML</td> </tr> <tr> <td>TB2912A0</td> <td>DOOR GASKET PIN XEVC-2011-E</td> <td>2</td> <td>PZ</td> </tr> <tr> <td>VI1075A0</td> <td>NUT M4 H=4 UNI5587 INOX</td> <td>3</td> <td>PZ</td> </tr> <tr> <td>VI1511A0</td> <td>STAINLESS STEEL WASHER 4.2X12X1</td> <td>3</td> <td>PZ</td> </tr> <tr> <td>VI1925A0</td> <td>ST STEEL STUD BOLT M4X8</td> <td>3</td> <td>PZ</td> </tr> </tbody> </table> <table border="1"> <thead> <tr> <th>Code</th> <th>Description</th> <th>Qty</th> <th>UOM</th> </tr> </thead> <tbody> <tr> <td>0H3178A0</td> <td>SERIE1000-40 00 GASKET HOLDER PLAT</td> <td>1</td> <td>PZ</td> </tr> <tr> <td>0H4936A0</td> <td>DRILL GUIDE</td> <td>1</td> <td>PZ</td> </tr> <tr> <td>GN1341B0</td> <td>DOOR-TROLL EY SEALING</td> <td>0.730</td> <td>M</td> </tr> <tr> <td>SL1170A1</td> <td>S53 BLACK SILICON - 310ML CARTRIDGE</td> <td>280</td> <td>ML</td> </tr> <tr> <td>TB2305A0</td> <td>5E BIG SERIES DOOR PIN</td> <td>2</td> <td>PZ</td> </tr> <tr> <td>VI1075A0</td> <td>NUT M4 H=4 UNI5587 INOX</td> <td>3</td> <td>PZ</td> </tr> <tr> <td>VI1511A0</td> <td>STAINLESS STEEL WASHER 4.2X12X1</td> <td>3</td> <td>PZ</td> </tr> <tr> <td>VI1925A0</td> <td>ST STEEL STUD BOLT M4X8</td> <td>3</td> <td>PZ</td> </tr> </tbody> </table>	Code	Description	Qty	UOM	0H7246A0	XEVC-2011 GASKET HOLDER PLAT	1	PZ	GN1341B0	DOOR-TROLL EY SEALING	0.750	M	SL1170A1	S53 BLACK SILICON - 310ML CARTRIDGE	280	ML	TB2912A0	DOOR GASKET PIN XEVC-2011-E	2	PZ	VI1075A0	NUT M4 H=4 UNI5587 INOX	3	PZ	VI1511A0	STAINLESS STEEL WASHER 4.2X12X1	3	PZ	VI1925A0	ST STEEL STUD BOLT M4X8	3	PZ	Code	Description	Qty	UOM	0H3178A0	SERIE1000-40 00 GASKET HOLDER PLAT	1	PZ	0H4936A0	DRILL GUIDE	1	PZ	GN1341B0	DOOR-TROLL EY SEALING	0.730	M	SL1170A1	S53 BLACK SILICON - 310ML CARTRIDGE	280	ML	TB2305A0	5E BIG SERIES DOOR PIN	2	PZ	VI1075A0	NUT M4 H=4 UNI5587 INOX	3	PZ	VI1511A0	STAINLESS STEEL WASHER 4.2X12X1	3	PZ	VI1925A0	ST STEEL STUD BOLT M4X8	3	PZ
Code	Description	Qty	UOM																																																																					
0H7246A0	XEVC-2011 GASKET HOLDER PLAT	1	PZ																																																																					
GN1341B0	DOOR-TROLL EY SEALING	0.750	M																																																																					
SL1170A1	S53 BLACK SILICON - 310ML CARTRIDGE	280	ML																																																																					
TB2912A0	DOOR GASKET PIN XEVC-2011-E	2	PZ																																																																					
VI1075A0	NUT M4 H=4 UNI5587 INOX	3	PZ																																																																					
VI1511A0	STAINLESS STEEL WASHER 4.2X12X1	3	PZ																																																																					
VI1925A0	ST STEEL STUD BOLT M4X8	3	PZ																																																																					
Code	Description	Qty	UOM																																																																					
0H3178A0	SERIE1000-40 00 GASKET HOLDER PLAT	1	PZ																																																																					
0H4936A0	DRILL GUIDE	1	PZ																																																																					
GN1341B0	DOOR-TROLL EY SEALING	0.730	M																																																																					
SL1170A1	S53 BLACK SILICON - 310ML CARTRIDGE	280	ML																																																																					
TB2305A0	5E BIG SERIES DOOR PIN	2	PZ																																																																					
VI1075A0	NUT M4 H=4 UNI5587 INOX	3	PZ																																																																					
VI1511A0	STAINLESS STEEL WASHER 4.2X12X1	3	PZ																																																																					
VI1925A0	ST STEEL STUD BOLT M4X8	3	PZ																																																																					
GN1553A	XEVC-2011-E DOOR-TROLLEY SEALING		<p>KGN1553A</p> <p>MIND.MAPS DOOR-TROLLEY GASKET KIT</p>	<table border="1"> <thead> <tr> <th>Code</th> <th>Description</th> <th>Qty</th> <th>UOM</th> </tr> </thead> <tbody> <tr> <td>0H7246A0</td> <td>XEVC-2011 GASKET HOLDER PLAT</td> <td>1</td> <td>PZ</td> </tr> <tr> <td>GN1341B0</td> <td>DOOR-TROLL EY SEALING</td> <td>0.750</td> <td>M</td> </tr> <tr> <td>SL1170A1</td> <td>S53 BLACK SILICON - 310ML CARTRIDGE</td> <td>280</td> <td>ML</td> </tr> </tbody> </table>	Code	Description	Qty	UOM	0H7246A0	XEVC-2011 GASKET HOLDER PLAT	1	PZ	GN1341B0	DOOR-TROLL EY SEALING	0.750	M	SL1170A1	S53 BLACK SILICON - 310ML CARTRIDGE	280	ML																																																				
Code	Description	Qty	UOM																																																																					
0H7246A0	XEVC-2011 GASKET HOLDER PLAT	1	PZ																																																																					
GN1341B0	DOOR-TROLL EY SEALING	0.750	M																																																																					
SL1170A1	S53 BLACK SILICON - 310ML CARTRIDGE	280	ML																																																																					

COMPONENT			SPARE PART																						
Code	Description	Image	Code	Description	Components list																				
GN1553A	XEVC-2011-E DOOR-TROLLEY SEALING		KGN1553A	MIND.MAPS DOOR-TROLLEY GASKET KIT	<table border="1"> <thead> <tr> <th>Code</th> <th>Description</th> <th>Qty</th> <th>UOM</th> </tr> </thead> <tbody> <tr> <td>TB2912A0</td> <td>DOOR GASKET PIN XEVC-2011-E</td> <td>2</td> <td>PZ</td> </tr> <tr> <td>VI1075A0</td> <td>NUT M4 H=4 UNI5587 INOX</td> <td>3</td> <td>PZ</td> </tr> <tr> <td>VI1511A0</td> <td>STAINLESS STEEL WASHER 4.2X12X1</td> <td>3</td> <td>PZ</td> </tr> <tr> <td>VI1925A0</td> <td>ST STEEL STUD BOLT M4X8</td> <td>3</td> <td>PZ</td> </tr> </tbody> </table>	Code	Description	Qty	UOM	TB2912A0	DOOR GASKET PIN XEVC-2011-E	2	PZ	VI1075A0	NUT M4 H=4 UNI5587 INOX	3	PZ	VI1511A0	STAINLESS STEEL WASHER 4.2X12X1	3	PZ	VI1925A0	ST STEEL STUD BOLT M4X8	3	PZ
Code	Description	Qty	UOM																						
TB2912A0	DOOR GASKET PIN XEVC-2011-E	2	PZ																						
VI1075A0	NUT M4 H=4 UNI5587 INOX	3	PZ																						
VI1511A0	STAINLESS STEEL WASHER 4.2X12X1	3	PZ																						
VI1925A0	ST STEEL STUD BOLT M4X8	3	PZ																						
TB2912A	DOOR GASKET PIN XEVC-2011-E		TB2912A0	DOOR GASKET PIN XEVC-2011-E																					
VI1995A	M5X25 ST.STEEL SCREW		VI1995A0	M5X25 ST.STEEL SCREW																					
VM2305A	6 SERIES DOOR CAP FIXING PAWL		KVM2305A	MM FIXING DOOR THUB SCREWS 10 PCS KIT	<table border="1"> <thead> <tr> <th>Code</th> <th>Description</th> <th>Qty</th> <th>UOM</th> </tr> </thead> <tbody> <tr> <td>VM2305A0</td> <td>6 SERIES DOOR CAP FIXING PAWL</td> <td>10</td> <td>PZ</td> </tr> </tbody> </table>	Code	Description	Qty	UOM	VM2305A0	6 SERIES DOOR CAP FIXING PAWL	10	PZ												
Code	Description	Qty	UOM																						
VM2305A0	6 SERIES DOOR CAP FIXING PAWL	10	PZ																						
VM2275A	SMOOTH BUSHING		KVM2275A	SMOOTH PIN BUSHING KIT	<table border="1"> <thead> <tr> <th>Code</th> <th>Description</th> <th>Qty</th> <th>UOM</th> </tr> </thead> <tbody> <tr> <td>VM2275A0</td> <td>SMOOTH BUSHING</td> <td>1</td> <td>PZ</td> </tr> </tbody> </table>	Code	Description	Qty	UOM	VM2275A0	SMOOTH BUSHING	1	PZ												
Code	Description	Qty	UOM																						
VM2275A0	SMOOTH BUSHING	1	PZ																						



COMPONENT			SPARE PART																		
Code	Description	Image	Code	Description	Components list																
VM2264A	MM BIG DOOR UPPER CAP		KVM2264A	MM TROLLEY OVEN DOOR LEFT UPPER CAP KIT	<table border="1"> <thead> <tr> <th>Code</th> <th>Description</th> <th>Qty</th> <th>UOM</th> </tr> </thead> <tbody> <tr> <td>VM2264A0</td> <td>MM BIG DOOR UPPER CAP</td> <td>1</td> <td>PZ</td> </tr> </tbody> </table>	Code	Description	Qty	UOM	VM2264A0	MM BIG DOOR UPPER CAP	1	PZ								
Code	Description	Qty	UOM																		
VM2264A0	MM BIG DOOR UPPER CAP	1	PZ																		
VM2266A	MM BIG DOOR UPPER RIGHT CAP		VM2266A0	MM BIG DOOR UPPER RIGHT CAP																	
0H7247A	XEVC-2011 UPPER DOOR PROFILE		0H7247A0	XEVC-2011 UPPER DOOR PROFILE																	
0H7248A	XEVC-2011 DOOR CAM																				
VM2274A	GROOVED BUSHING		KVM2274A	GROOVED PIN BUSHING KIT	<table border="1"> <thead> <tr> <th>Code</th> <th>Description</th> <th>Qty</th> <th>UOM</th> </tr> </thead> <tbody> <tr> <td>VM2274A0</td> <td>GROOVED BUSHING</td> <td>1</td> <td>PZ</td> </tr> </tbody> </table>	Code	Description	Qty	UOM	VM2274A0	GROOVED BUSHING	1	PZ								
Code	Description	Qty	UOM																		
VM2274A0	GROOVED BUSHING	1	PZ																		
			K0B1126AR	BAKERTOP MM RIGHT DOOR LOWER BEAM KIT	<table border="1"> <thead> <tr> <th>Code</th> <th>Description</th> <th>Qty</th> <th>UOM</th> </tr> </thead> <tbody> <tr> <td>0B1126A0</td> <td>DOOR LOWER FRAME SHAPE 860 MM</td> <td>1</td> <td>PZ</td> </tr> <tr> <td>RC1200A0</td> <td>ED=4 WIRE D.=0.5 COMPRESSION SPRING</td> <td>2</td> <td>PZ</td> </tr> <tr> <td>V11220A1</td> <td>4,2X12 TCB SELF-TAPPING SCREW</td> <td>1</td> <td>PZ</td> </tr> </tbody> </table>	Code	Description	Qty	UOM	0B1126A0	DOOR LOWER FRAME SHAPE 860 MM	1	PZ	RC1200A0	ED=4 WIRE D.=0.5 COMPRESSION SPRING	2	PZ	V11220A1	4,2X12 TCB SELF-TAPPING SCREW	1	PZ
Code	Description	Qty	UOM																		
0B1126A0	DOOR LOWER FRAME SHAPE 860 MM	1	PZ																		
RC1200A0	ED=4 WIRE D.=0.5 COMPRESSION SPRING	2	PZ																		
V11220A1	4,2X12 TCB SELF-TAPPING SCREW	1	PZ																		





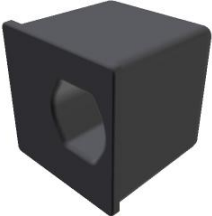

COMPONENT			SPARE PART																																											
Code	Description	Image	Code	Description	Components list																																									
VM2274A	GROOVED BUSHING		K0B1126AR	BAKERTOP MM RIGHT DOOR LOWER BEAM KIT	<table border="1"> <thead> <tr> <th>Code</th> <th>Description</th> <th>Qty</th> <th>UOM</th> </tr> </thead> <tbody> <tr> <td>VI1996A0</td> <td>M5X35 SCREW</td> <td>7</td> <td>PZ</td> </tr> <tr> <td>VM1794A0</td> <td>250X4.8 PA66 BLACK CLAMP</td> <td>2</td> <td>PZ</td> </tr> <tr> <td>VM2103A0</td> <td>CLAMP LOCK</td> <td>2</td> <td>PZ</td> </tr> <tr> <td>VM2259A1</td> <td>6 SERIES DOOR LOWER LEFT CAP</td> <td>1</td> <td>PZ</td> </tr> <tr> <td>VM2261A1</td> <td>6 SERIES DOOR LOWER RIGHT CAP</td> <td>1</td> <td>PZ</td> </tr> <tr> <td>VM2267A0</td> <td>INTERNAL GLASS LOCKING SYSTEM SLIDER</td> <td>1</td> <td>PZ</td> </tr> <tr> <td>VM2269A0</td> <td>INTERNAL GLASS LOCKING SYSTEM CAP</td> <td>1</td> <td>PZ</td> </tr> <tr> <td>VM2274A0</td> <td>GROOVED BUSHING</td> <td>1</td> <td>PZ</td> </tr> <tr> <td>VM2305A0</td> <td>6 SERIES DOOR CAP FIXING PAWL</td> <td>7</td> <td>PZ</td> </tr> </tbody> </table>	Code	Description	Qty	UOM	VI1996A0	M5X35 SCREW	7	PZ	VM1794A0	250X4.8 PA66 BLACK CLAMP	2	PZ	VM2103A0	CLAMP LOCK	2	PZ	VM2259A1	6 SERIES DOOR LOWER LEFT CAP	1	PZ	VM2261A1	6 SERIES DOOR LOWER RIGHT CAP	1	PZ	VM2267A0	INTERNAL GLASS LOCKING SYSTEM SLIDER	1	PZ	VM2269A0	INTERNAL GLASS LOCKING SYSTEM CAP	1	PZ	VM2274A0	GROOVED BUSHING	1	PZ	VM2305A0	6 SERIES DOOR CAP FIXING PAWL	7	PZ	
			Code	Description	Qty	UOM																																								
VI1996A0	M5X35 SCREW	7	PZ																																											
VM1794A0	250X4.8 PA66 BLACK CLAMP	2	PZ																																											
VM2103A0	CLAMP LOCK	2	PZ																																											
VM2259A1	6 SERIES DOOR LOWER LEFT CAP	1	PZ																																											
VM2261A1	6 SERIES DOOR LOWER RIGHT CAP	1	PZ																																											
VM2267A0	INTERNAL GLASS LOCKING SYSTEM SLIDER	1	PZ																																											
VM2269A0	INTERNAL GLASS LOCKING SYSTEM CAP	1	PZ																																											
VM2274A0	GROOVED BUSHING	1	PZ																																											
VM2305A0	6 SERIES DOOR CAP FIXING PAWL	7	PZ																																											
K0B1126AL	EU AND 2/1 MM LEFT DOOR LOWER BEAM KIT	<table border="1"> <thead> <tr> <th>Code</th> <th>Description</th> <th>Qty</th> <th>UOM</th> </tr> </thead> <tbody> <tr> <td>0B1126A0</td> <td>DOOR LOWER FRAME SHAPE 860 MM</td> <td>1</td> <td>PZ</td> </tr> <tr> <td>RC1200A0</td> <td>ED=4 WIRE D.=0.5 COMPRESSION N SPRING</td> <td>2</td> <td>PZ</td> </tr> <tr> <td>VI1220A1</td> <td>4,2X12 TCB SELF-TAPPING G SCREW</td> <td>1</td> <td>PZ</td> </tr> <tr> <td>VI1996A0</td> <td>M5X35 SCREW</td> <td>7</td> <td>PZ</td> </tr> <tr> <td>VM1794A0</td> <td>250X4.8 PA66 BLACK CLAMP</td> <td>2</td> <td>PZ</td> </tr> <tr> <td>VM2103A0</td> <td>CLAMP LOCK</td> <td>2</td> <td>PZ</td> </tr> <tr> <td>VM2267A0</td> <td>INTERNAL GLASS LOCKING SYSTEM SLIDER</td> <td>1</td> <td>PZ</td> </tr> <tr> <td>VM2269A0</td> <td>INTERNAL GLASS LOCKING SYSTEM CAP</td> <td>1</td> <td>PZ</td> </tr> <tr> <td>VM2274A0</td> <td>GROOVED BUSHING</td> <td>1</td> <td>PZ</td> </tr> <tr> <td>VM2305A0</td> <td>6 SERIES DOOR CAP FIXING PAWL</td> <td>7</td> <td>PZ</td> </tr> </tbody> </table>	Code	Description	Qty	UOM	0B1126A0	DOOR LOWER FRAME SHAPE 860 MM	1	PZ	RC1200A0	ED=4 WIRE D.=0.5 COMPRESSION N SPRING	2	PZ	VI1220A1	4,2X12 TCB SELF-TAPPING G SCREW	1	PZ	VI1996A0	M5X35 SCREW	7	PZ	VM1794A0	250X4.8 PA66 BLACK CLAMP	2	PZ	VM2103A0	CLAMP LOCK	2	PZ	VM2267A0	INTERNAL GLASS LOCKING SYSTEM SLIDER	1	PZ	VM2269A0	INTERNAL GLASS LOCKING SYSTEM CAP	1	PZ	VM2274A0	GROOVED BUSHING	1	PZ	VM2305A0	6 SERIES DOOR CAP FIXING PAWL	7	PZ
Code	Description	Qty	UOM																																											
0B1126A0	DOOR LOWER FRAME SHAPE 860 MM	1	PZ																																											
RC1200A0	ED=4 WIRE D.=0.5 COMPRESSION N SPRING	2	PZ																																											
VI1220A1	4,2X12 TCB SELF-TAPPING G SCREW	1	PZ																																											
VI1996A0	M5X35 SCREW	7	PZ																																											
VM1794A0	250X4.8 PA66 BLACK CLAMP	2	PZ																																											
VM2103A0	CLAMP LOCK	2	PZ																																											
VM2267A0	INTERNAL GLASS LOCKING SYSTEM SLIDER	1	PZ																																											
VM2269A0	INTERNAL GLASS LOCKING SYSTEM CAP	1	PZ																																											
VM2274A0	GROOVED BUSHING	1	PZ																																											
VM2305A0	6 SERIES DOOR CAP FIXING PAWL	7	PZ																																											

COMPONENT			SPARE PART																																																			
Code	Description	Image	Code	Description	Components list																																																	
VM2274A	GROOVED BUSHING		K0B1126AL	EU AND 2/1 MM LEFT DOOR LOWER BEAM KIT	<table border="1"> <thead> <tr> <th>Code</th> <th>Description</th> <th>Qty</th> <th>UOM</th> </tr> </thead> <tbody> <tr> <td>VM2384A0</td> <td>LEFT MM DOOR LOWER RIGHT CAP</td> <td>1</td> <td>PZ</td> </tr> <tr> <td>VM2384A0</td> <td>LEFT MM DOOR LOWER RIGHT CAP</td> <td>1</td> <td>PZ</td> </tr> <tr> <td>VM2386A1</td> <td>LEFT MM DOOR LOWER LEFT CAP</td> <td>1</td> <td>PZ</td> </tr> <tr> <td>VM2386A1</td> <td>LEFT MM DOOR LOWER LEFT CAP</td> <td>1</td> <td>PZ</td> </tr> </tbody> </table>	Code	Description	Qty	UOM	VM2384A0	LEFT MM DOOR LOWER RIGHT CAP	1	PZ	VM2384A0	LEFT MM DOOR LOWER RIGHT CAP	1	PZ	VM2386A1	LEFT MM DOOR LOWER LEFT CAP	1	PZ	VM2386A1	LEFT MM DOOR LOWER LEFT CAP	1	PZ																													
			Code	Description	Qty	UOM																																																
			VM2384A0	LEFT MM DOOR LOWER RIGHT CAP	1	PZ																																																
VM2384A0	LEFT MM DOOR LOWER RIGHT CAP	1	PZ																																																			
VM2386A1	LEFT MM DOOR LOWER LEFT CAP	1	PZ																																																			
VM2386A1	LEFT MM DOOR LOWER LEFT CAP	1	PZ																																																			
K0B1122AR	CHEFTOP MM RIGHT DOOR LOWER BEAM KIT	<table border="1"> <thead> <tr> <th>Code</th> <th>Description</th> <th>Qty</th> <th>UOM</th> </tr> </thead> <tbody> <tr> <td>0B1122A0</td> <td>6 SERIES DOOR LOWER FRAME SHAPE</td> <td>1</td> <td>PZ</td> </tr> <tr> <td>RC1200A0</td> <td>ED=4 WIRE D.=0.5 COMPRESSIO N SPRING</td> <td>2</td> <td>PZ</td> </tr> <tr> <td>VI1220A1</td> <td>4,2X12 TCB SELF-TAPPIN G SCREW</td> <td>1</td> <td>PZ</td> </tr> <tr> <td>VI1996A0</td> <td>M5X35 SCREW</td> <td>7</td> <td>PZ</td> </tr> <tr> <td>VM1794A0</td> <td>250X4.8 PA66 BLACK CLAMP</td> <td>2</td> <td>PZ</td> </tr> <tr> <td>VM2103A0</td> <td>CLAMP LOCK</td> <td>2</td> <td>PZ</td> </tr> <tr> <td>VM2259A1</td> <td>6 SERIES DOOR LOWER LEFT CAP</td> <td>1</td> <td>PZ</td> </tr> <tr> <td>VM2261A1</td> <td>6 SERIES DOOR LOWER RIGHT CAP</td> <td>1</td> <td>PZ</td> </tr> <tr> <td>VM2267A0</td> <td>INTERNAL GLASS LOCKING SYSTEM SLIDER</td> <td>1</td> <td>PZ</td> </tr> <tr> <td>VM2269A0</td> <td>INTERNAL GLASS LOCKING SYSTEM CAP</td> <td>1</td> <td>PZ</td> </tr> <tr> <td>VM2274A0</td> <td>GROOVED BUSHING</td> <td>1</td> <td>PZ</td> </tr> <tr> <td>VM2305A0</td> <td>6 SERIES DOOR CAP FIXING PAWL</td> <td>7</td> <td>PZ</td> </tr> </tbody> </table>	Code	Description	Qty	UOM	0B1122A0	6 SERIES DOOR LOWER FRAME SHAPE	1	PZ	RC1200A0	ED=4 WIRE D.=0.5 COMPRESSIO N SPRING	2	PZ	VI1220A1	4,2X12 TCB SELF-TAPPIN G SCREW	1	PZ	VI1996A0	M5X35 SCREW	7	PZ	VM1794A0	250X4.8 PA66 BLACK CLAMP	2	PZ	VM2103A0	CLAMP LOCK	2	PZ	VM2259A1	6 SERIES DOOR LOWER LEFT CAP	1	PZ	VM2261A1	6 SERIES DOOR LOWER RIGHT CAP	1	PZ	VM2267A0	INTERNAL GLASS LOCKING SYSTEM SLIDER	1	PZ	VM2269A0	INTERNAL GLASS LOCKING SYSTEM CAP	1	PZ	VM2274A0	GROOVED BUSHING	1	PZ	VM2305A0	6 SERIES DOOR CAP FIXING PAWL	7	PZ
Code	Description	Qty	UOM																																																			
0B1122A0	6 SERIES DOOR LOWER FRAME SHAPE	1	PZ																																																			
RC1200A0	ED=4 WIRE D.=0.5 COMPRESSIO N SPRING	2	PZ																																																			
VI1220A1	4,2X12 TCB SELF-TAPPIN G SCREW	1	PZ																																																			
VI1996A0	M5X35 SCREW	7	PZ																																																			
VM1794A0	250X4.8 PA66 BLACK CLAMP	2	PZ																																																			
VM2103A0	CLAMP LOCK	2	PZ																																																			
VM2259A1	6 SERIES DOOR LOWER LEFT CAP	1	PZ																																																			
VM2261A1	6 SERIES DOOR LOWER RIGHT CAP	1	PZ																																																			
VM2267A0	INTERNAL GLASS LOCKING SYSTEM SLIDER	1	PZ																																																			
VM2269A0	INTERNAL GLASS LOCKING SYSTEM CAP	1	PZ																																																			
VM2274A0	GROOVED BUSHING	1	PZ																																																			
VM2305A0	6 SERIES DOOR CAP FIXING PAWL	7	PZ																																																			
K0B1122AL	CHEFTOP MM LEFT DOOR LOWER BEAM KIT	<table border="1"> <thead> <tr> <th>Code</th> <th>Description</th> <th>Qty</th> <th>UOM</th> </tr> </thead> <tbody> <tr> <td>0B1122A0</td> <td>6 SERIES DOOR LOWER FRAME SHAPE</td> <td>1</td> <td>PZ</td> </tr> </tbody> </table>	Code	Description	Qty	UOM	0B1122A0	6 SERIES DOOR LOWER FRAME SHAPE	1	PZ																																												
Code	Description	Qty	UOM																																																			
0B1122A0	6 SERIES DOOR LOWER FRAME SHAPE	1	PZ																																																			



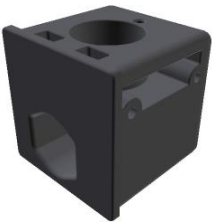

COMPONENT			SPARE PART																																																										
Code	Description	Image	Code	Description	Components list																																																								
VM2274A	GROOVED BUSHING		K0B1122AL	CHEFTOP MM LEFT DOOR LOWER BEAM KIT	<table border="1"> <thead> <tr> <th>Code</th> <th>Description</th> <th>Qty</th> <th>UOM</th> </tr> </thead> <tbody> <tr> <td>RC1200A0</td> <td>ED=4 WIRE D.=0.5 COMPRESSIO N SPRING</td> <td>2</td> <td>PZ</td> </tr> <tr> <td>V11220A1</td> <td>4,2X12 TCB SELF-TAPPIN G SCREW</td> <td>1</td> <td>PZ</td> </tr> <tr> <td>V11996A0</td> <td>M5X35 SCREW</td> <td>7</td> <td>PZ</td> </tr> <tr> <td>VM1794A0</td> <td>250X4.8 PA66 BLACK CLAMP</td> <td>2</td> <td>PZ</td> </tr> <tr> <td>VM2103A0</td> <td>CLAMP LOCK</td> <td>2</td> <td>PZ</td> </tr> <tr> <td>VM2267A0</td> <td>INTERNAL GLASS LOCKING SYSTEM SLIDER</td> <td>1</td> <td>PZ</td> </tr> <tr> <td>VM2269A0</td> <td>INTERNAL GLASS LOCKING SYSTEM CAP</td> <td>1</td> <td>PZ</td> </tr> <tr> <td>VM2274A0</td> <td>GROOVED BUSHING</td> <td>1</td> <td>PZ</td> </tr> <tr> <td>VM2305A0</td> <td>6 SERIES DOOR CAP FIXING PAWL</td> <td>7</td> <td>PZ</td> </tr> <tr> <td>VM2384A0</td> <td>LEFT MM DOOR LOWER RIGHT CAP</td> <td>1</td> <td>PZ</td> </tr> <tr> <td>VM2384A0</td> <td>LEFT MM DOOR LOWER RIGHT CAP</td> <td>1</td> <td>PZ</td> </tr> <tr> <td>VM2386A1</td> <td>LEFT MM DOOR LOWER LEFT CAP</td> <td>1</td> <td>PZ</td> </tr> <tr> <td>VM2386A1</td> <td>LEFT MM DOOR LOWER LEFT CAP</td> <td>1</td> <td>PZ</td> </tr> </tbody> </table>	Code	Description	Qty	UOM	RC1200A0	ED=4 WIRE D.=0.5 COMPRESSIO N SPRING	2	PZ	V11220A1	4,2X12 TCB SELF-TAPPIN G SCREW	1	PZ	V11996A0	M5X35 SCREW	7	PZ	VM1794A0	250X4.8 PA66 BLACK CLAMP	2	PZ	VM2103A0	CLAMP LOCK	2	PZ	VM2267A0	INTERNAL GLASS LOCKING SYSTEM SLIDER	1	PZ	VM2269A0	INTERNAL GLASS LOCKING SYSTEM CAP	1	PZ	VM2274A0	GROOVED BUSHING	1	PZ	VM2305A0	6 SERIES DOOR CAP FIXING PAWL	7	PZ	VM2384A0	LEFT MM DOOR LOWER RIGHT CAP	1	PZ	VM2384A0	LEFT MM DOOR LOWER RIGHT CAP	1	PZ	VM2386A1	LEFT MM DOOR LOWER LEFT CAP	1	PZ	VM2386A1	LEFT MM DOOR LOWER LEFT CAP	1	PZ
Code	Description	Qty	UOM																																																										
RC1200A0	ED=4 WIRE D.=0.5 COMPRESSIO N SPRING	2	PZ																																																										
V11220A1	4,2X12 TCB SELF-TAPPIN G SCREW	1	PZ																																																										
V11996A0	M5X35 SCREW	7	PZ																																																										
VM1794A0	250X4.8 PA66 BLACK CLAMP	2	PZ																																																										
VM2103A0	CLAMP LOCK	2	PZ																																																										
VM2267A0	INTERNAL GLASS LOCKING SYSTEM SLIDER	1	PZ																																																										
VM2269A0	INTERNAL GLASS LOCKING SYSTEM CAP	1	PZ																																																										
VM2274A0	GROOVED BUSHING	1	PZ																																																										
VM2305A0	6 SERIES DOOR CAP FIXING PAWL	7	PZ																																																										
VM2384A0	LEFT MM DOOR LOWER RIGHT CAP	1	PZ																																																										
VM2384A0	LEFT MM DOOR LOWER RIGHT CAP	1	PZ																																																										
VM2386A1	LEFT MM DOOR LOWER LEFT CAP	1	PZ																																																										
VM2386A1	LEFT MM DOOR LOWER LEFT CAP	1	PZ																																																										
VM2263A	MM BIG DOOR LOWER LEFT CAP		KVM2263A	MM BIG DOOR LEFT LOWER CAP KIT	<table border="1"> <thead> <tr> <th>Code</th> <th>Description</th> <th>Qty</th> <th>UOM</th> </tr> </thead> <tbody> <tr> <td>VM2263A0</td> <td>MM BIG DOOR LOWER LEFT CAP</td> <td>1</td> <td>PZ</td> </tr> </tbody> </table>	Code	Description	Qty	UOM	VM2263A0	MM BIG DOOR LOWER LEFT CAP	1	PZ																																																
Code	Description	Qty	UOM																																																										
VM2263A0	MM BIG DOOR LOWER LEFT CAP	1	PZ																																																										



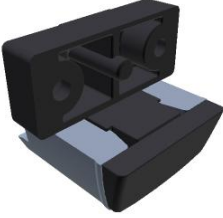

COMPONENT			SPARE PART																		
Code	Description	Image	Code	Description	Components list																
VM2268A	DOOR MAGNET COVER		KVM2268A	DOOR MAGNET COVER KIT	<table border="1"> <thead> <tr> <th>Code</th> <th>Description</th> <th>Qty</th> <th>UOM</th> </tr> </thead> <tbody> <tr> <td>VM2268A0</td> <td>DOOR MAGNET COVER</td> <td>1</td> <td>PZ</td> </tr> </tbody> </table>	Code	Description	Qty	UOM	VM2268A0	DOOR MAGNET COVER	1	PZ								
Code	Description	Qty	UOM																		
VM2268A0	DOOR MAGNET COVER	1	PZ																		
VM2265A	MM BIG DOOR LOWER RIGHT CAP		KVM2265A	MM TROLLEY OVEN DOOR RIGHT LOWER CAP KIT	<table border="1"> <thead> <tr> <th>Code</th> <th>Description</th> <th>Qty</th> <th>UOM</th> </tr> </thead> <tbody> <tr> <td>VM2265A0</td> <td>MM BIG DOOR LOWER RIGHT CAP</td> <td>1</td> <td>PZ</td> </tr> </tbody> </table>	Code	Description	Qty	UOM	VM2265A0	MM BIG DOOR LOWER RIGHT CAP	1	PZ								
Code	Description	Qty	UOM																		
VM2265A0	MM BIG DOOR LOWER RIGHT CAP	1	PZ																		
LP1029A	L=1199 S6 NO LED LIGHT BAR COVER		KLP1029A	L119 MM NO LED LIGHT HOLDER KIT	<table border="1"> <thead> <tr> <th>Code</th> <th>Description</th> <th>Qty</th> <th>UOM</th> </tr> </thead> <tbody> <tr> <td>IP1385A1</td> <td>CORNER POLYSTYREN E PACKING 110X80X2000</td> <td>2.540</td> <td>M</td> </tr> <tr> <td>LP1029A0</td> <td>L=1199 S6 NO LED LIGHT BAR COVER</td> <td>1</td> <td>PZ</td> </tr> <tr> <td>VM1059A1</td> <td>HEAT SHRINK FILM H800</td> <td>2.540</td> <td>M</td> </tr> </tbody> </table>	Code	Description	Qty	UOM	IP1385A1	CORNER POLYSTYREN E PACKING 110X80X2000	2.540	M	LP1029A0	L=1199 S6 NO LED LIGHT BAR COVER	1	PZ	VM1059A1	HEAT SHRINK FILM H800	2.540	M
Code	Description	Qty	UOM																		
IP1385A1	CORNER POLYSTYREN E PACKING 110X80X2000	2.540	M																		
LP1029A0	L=1199 S6 NO LED LIGHT BAR COVER	1	PZ																		
VM1059A1	HEAT SHRINK FILM H800	2.540	M																		
VM2339A			VM2339A0																		
LP1023A	6 SERIES L800 LED LIGHT BAR - E1199		KLP1023A	L800 E1199 LED LIGHT BAR KIT	<table border="1"> <thead> <tr> <th>Code</th> <th>Description</th> <th>Qty</th> <th>UOM</th> </tr> </thead> <tbody> <tr> <td>IP1385A1</td> <td>CORNER POLYSTYREN E PACKING 110X80X2000</td> <td>2.540</td> <td>M</td> </tr> <tr> <td>LP1023A0</td> <td>6 SERIES L800 LED LIGHT BAR - E1199</td> <td>1</td> <td>PZ</td> </tr> <tr> <td>VM1059A1</td> <td>HEAT SHRINK FILM H800</td> <td>2.540</td> <td>M</td> </tr> </tbody> </table>	Code	Description	Qty	UOM	IP1385A1	CORNER POLYSTYREN E PACKING 110X80X2000	2.540	M	LP1023A0	6 SERIES L800 LED LIGHT BAR - E1199	1	PZ	VM1059A1	HEAT SHRINK FILM H800	2.540	M
Code	Description	Qty	UOM																		
IP1385A1	CORNER POLYSTYREN E PACKING 110X80X2000	2.540	M																		
LP1023A0	6 SERIES L800 LED LIGHT BAR - E1199	1	PZ																		
VM1059A1	HEAT SHRINK FILM H800	2.540	M																		



COMPONENT			SPARE PART																		
Code	Description	Image	Code	Description	Components list																
VM2339A			VM2339A0																		
VM2355A	XEVC-2011 INTERNAL GLASS LOCKING KIT		KVM2355A	XEVC-2011 INT. GLASS LOCKING 2 PCS. KIT	<table border="1"> <thead> <tr> <th>Code</th> <th>Description</th> <th>Qty</th> <th>UOM</th> </tr> </thead> <tbody> <tr> <td>V11220A1</td> <td>4,2X12 TCB SELF-TAPPIN G SCREW</td> <td>4</td> <td>PZ</td> </tr> <tr> <td>VM2355A0</td> <td>XEVC-2011 INTERNAL GLASS LOCKING KIT</td> <td>2</td> <td>PZ</td> </tr> <tr> <td>VM2355A0</td> <td>XEVC-2011 INTERNAL GLASS LOCKING KIT</td> <td>2</td> <td>PZ</td> </tr> </tbody> </table>	Code	Description	Qty	UOM	V11220A1	4,2X12 TCB SELF-TAPPIN G SCREW	4	PZ	VM2355A0	XEVC-2011 INTERNAL GLASS LOCKING KIT	2	PZ	VM2355A0	XEVC-2011 INTERNAL GLASS LOCKING KIT	2	PZ
Code	Description	Qty	UOM																		
V11220A1	4,2X12 TCB SELF-TAPPIN G SCREW	4	PZ																		
VM2355A0	XEVC-2011 INTERNAL GLASS LOCKING KIT	2	PZ																		
VM2355A0	XEVC-2011 INTERNAL GLASS LOCKING KIT	2	PZ																		
TB2911A	XEVC-2011-E DOOR BEAM																				
VM2410A	PLATE TO STOP EXTRUDED LED BAR		KVM2410A	PLATE TO STOP EXTRUDED LED BAR 2P KIT	<table border="1"> <thead> <tr> <th>Code</th> <th>Description</th> <th>Qty</th> <th>UOM</th> </tr> </thead> <tbody> <tr> <td>0B1190A0</td> <td>PLATE TO STOP EXTRUDED LED BAR</td> <td>2</td> <td>PZ</td> </tr> <tr> <td>VM2410A0</td> <td>PLATE TO STOP EXTRUDED LED BAR</td> <td>2</td> <td>PZ</td> </tr> <tr> <td>VM2410A0</td> <td>PLATE TO STOP EXTRUDED LED BAR</td> <td>2</td> <td>PZ</td> </tr> </tbody> </table>	Code	Description	Qty	UOM	0B1190A0	PLATE TO STOP EXTRUDED LED BAR	2	PZ	VM2410A0	PLATE TO STOP EXTRUDED LED BAR	2	PZ	VM2410A0	PLATE TO STOP EXTRUDED LED BAR	2	PZ
Code	Description	Qty	UOM																		
0B1190A0	PLATE TO STOP EXTRUDED LED BAR	2	PZ																		
VM2410A0	PLATE TO STOP EXTRUDED LED BAR	2	PZ																		
VM2410A0	PLATE TO STOP EXTRUDED LED BAR	2	PZ																		

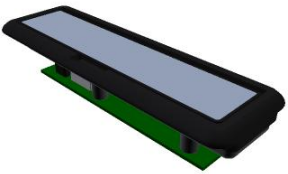

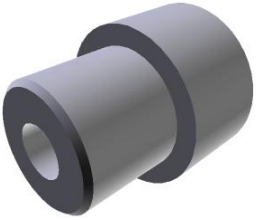
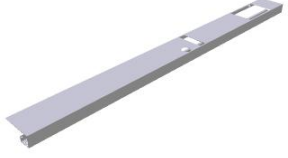
COMPONENT			SPARE PART																		
Code	Description	Image	Code	Description	Components list																
PE2046A	MM POWER SWITCH AND USB BOARD		KPE2046A	MIND.MAPS USB-RESET SUPPORT KIT	<table border="1"> <thead> <tr> <th>Code</th> <th>Description</th> <th>Qty</th> <th>UOM</th> </tr> </thead> <tbody> <tr> <td>PE2046A2</td> <td>MM POWER SWITCH AND USB BOARD</td> <td>1</td> <td>PZ</td> </tr> <tr> <td>V11220A1</td> <td>4,2X12 TCB SELF-TAPPING SCREW</td> <td>2</td> <td>PZ</td> </tr> <tr> <td>VM2147A0</td> <td>ESD SPONGE PINK SMOOTH 410X343X15 M</td> <td>0.250</td> <td>PZ</td> </tr> </tbody> </table>	Code	Description	Qty	UOM	PE2046A2	MM POWER SWITCH AND USB BOARD	1	PZ	V11220A1	4,2X12 TCB SELF-TAPPING SCREW	2	PZ	VM2147A0	ESD SPONGE PINK SMOOTH 410X343X15 M	0.250	PZ
Code	Description	Qty	UOM																		
PE2046A2	MM POWER SWITCH AND USB BOARD	1	PZ																		
V11220A1	4,2X12 TCB SELF-TAPPING SCREW	2	PZ																		
VM2147A0	ESD SPONGE PINK SMOOTH 410X343X15 M	0.250	PZ																		
TB3204A	XEVC-2011-E UPPER DOOR BEAM		TB3204A0	XEVC-2011-E UPPER DOOR BEAM																	
TB3203A																					
VM2437A																					
0H7778A	XEVC-2011 RIGHT EXT DOOR COLUMN		0H7778A0	XEVC-2011 RIGHT EXT DOOR COLUMN																	



COMPONENT			SPARE PART																		
Code	Description	Image	Code	Description	Components list																
0H7779A	XEVC-2011 CT LEFT EXT DOOR COLUMN		0H7779A0	XEVC-2011 CT LEFT EXT DOOR COLUMN																	
0H7240A	XEVC-2011 RIGHT INT DOOR COLUMN																				
0H7241A	XEVC-2011 LEFT INT DOOR COLUMN																				
PE2042A	MM ONE VERSION CONTROL BOARD		KPE2042A	MIND.MAPS ONE CONTROL BOARD KIT	<table border="1"> <thead> <tr> <th>Code</th> <th>Description</th> <th>Qty</th> <th>UOM</th> </tr> </thead> <tbody> <tr> <td>PE2042A4</td> <td>MM ONE VERSION CONTROL BOARD</td> <td>1</td> <td>PZ</td> </tr> <tr> <td>VI2000A0</td> <td>SCREW M4X22 TCB+ INOX</td> <td>4</td> <td>PZ</td> </tr> <tr> <td>VM2147A0</td> <td>ESD SPONGE PINK SMOOTH 410X343X15 M</td> <td>1</td> <td>PZ</td> </tr> </tbody> </table>	Code	Description	Qty	UOM	PE2042A4	MM ONE VERSION CONTROL BOARD	1	PZ	VI2000A0	SCREW M4X22 TCB+ INOX	4	PZ	VM2147A0	ESD SPONGE PINK SMOOTH 410X343X15 M	1	PZ
Code	Description	Qty	UOM																		
PE2042A4	MM ONE VERSION CONTROL BOARD	1	PZ																		
VI2000A0	SCREW M4X22 TCB+ INOX	4	PZ																		
VM2147A0	ESD SPONGE PINK SMOOTH 410X343X15 M	1	PZ																		



ASM1800A/0.D02 - External cover

FRONT

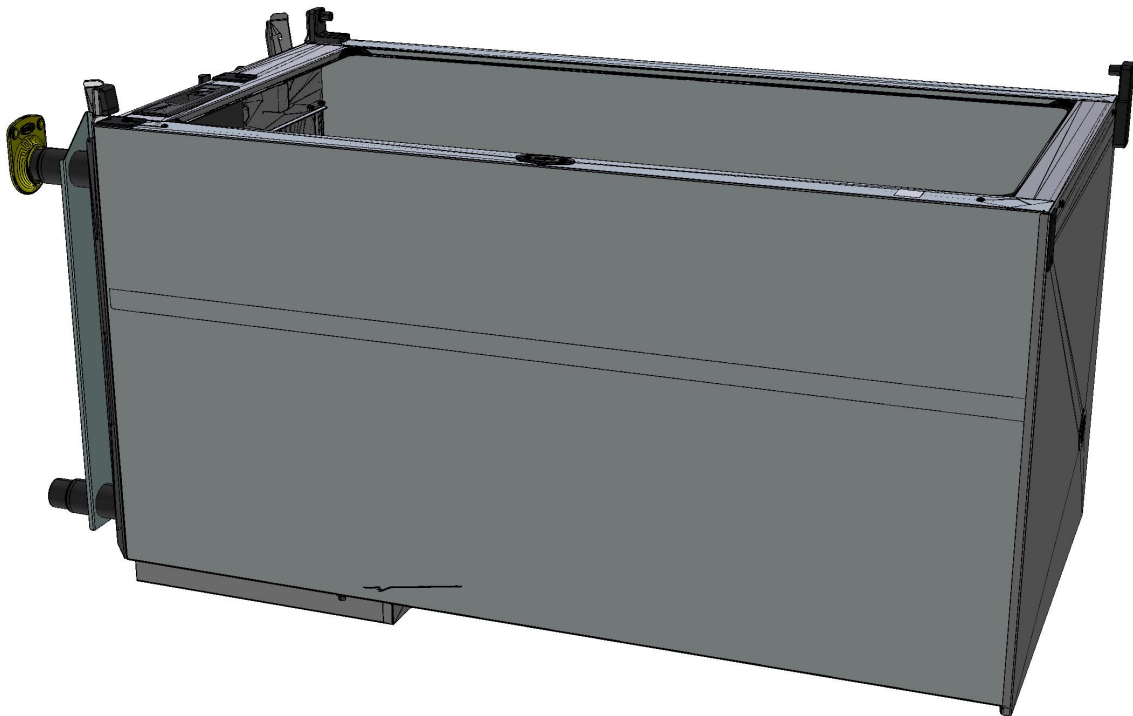



ASM1800A/0.D02 - External cover

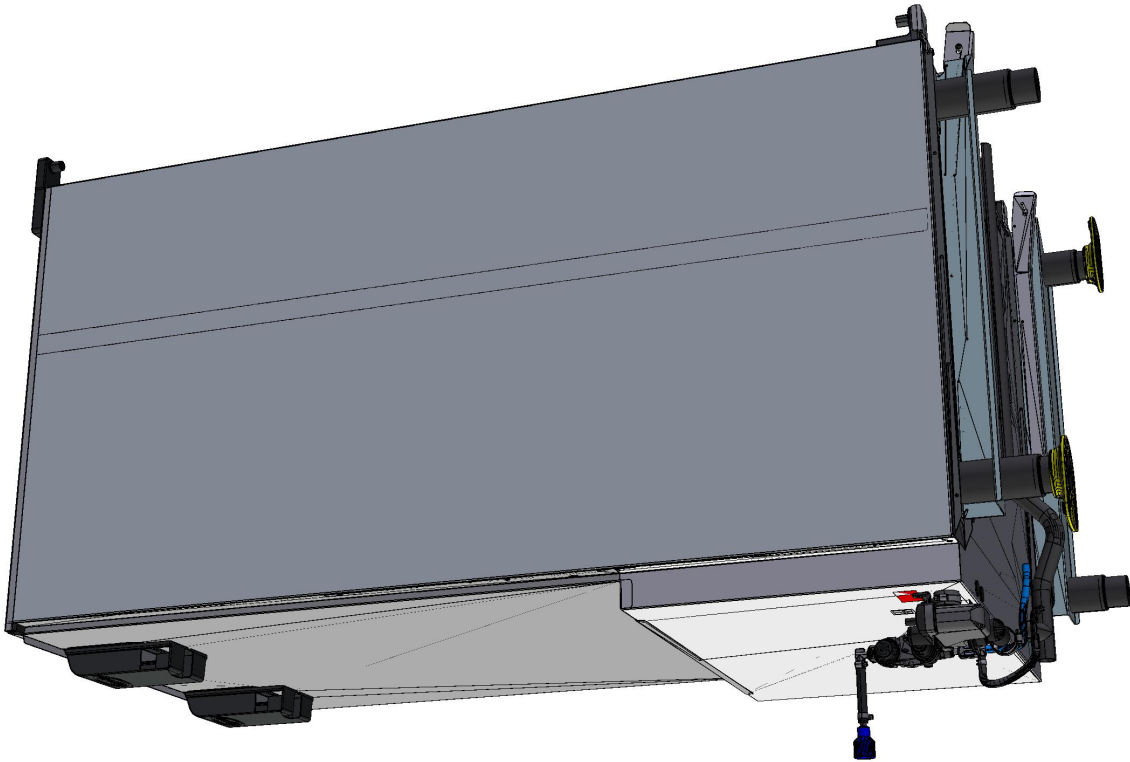

REAR

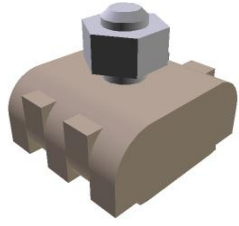
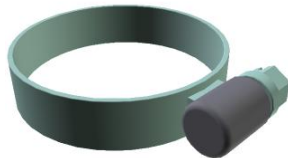



COMPONENT			SPARE PART																																																						
Code	Description	Image	Code	Description	Components list																																																				
VM1750A	BRASS COMB CLAM		KVM1750A	COMB TERMINAL BLOCK KIT	<table border="1"> <thead> <tr> <th>Code</th> <th>Description</th> <th>Qty</th> <th>UOM</th> </tr> </thead> <tbody> <tr> <td>VM1750A0</td> <td>BRASS COMB CLAMP</td> <td>1</td> <td>PZ</td> </tr> </tbody> </table>	Code	Description	Qty	UOM	VM1750A0	BRASS COMB CLAMP	1	PZ																																												
Code	Description	Qty	UOM																																																						
VM1750A0	BRASS COMB CLAMP	1	PZ																																																						
RC1378A	HOSE CLAMP		KVE1135A	SERIES 5/5E VENTURI KIT	<table border="1"> <thead> <tr> <th>Code</th> <th>Description</th> <th>Qty</th> <th>UOM</th> </tr> </thead> <tbody> <tr> <td>GN1556A0</td> <td>MM VENTURI SEAL</td> <td>1</td> <td>PZ</td> </tr> <tr> <td>RC1378A0</td> <td>HOSE CLAMP</td> <td>2</td> <td>PZ</td> </tr> <tr> <td>TB1520A0</td> <td>INT. Ø=38 TH=4 DRAIN BLACK RUBBER PIPE</td> <td>0.050</td> <td>M</td> </tr> <tr> <td>VE1135A0</td> <td>220 V 50/60 HZ VENTURI ACTUATOR</td> <td>1</td> <td>PZ</td> </tr> <tr> <td>VI1032A0</td> <td>SCREW M4X16 TCB+ INOX</td> <td>1</td> <td>PZ</td> </tr> <tr> <td>VI1511A0</td> <td>STAINLESS STEEL WASHER 4.2X12X1</td> <td>2</td> <td>PZ</td> </tr> <tr> <td>VI1850A0</td> <td>M4X6 NICKEL PLATED FIXING SCRE</td> <td>2</td> <td>PZ</td> </tr> <tr> <td>VI1865A0</td> <td>5X10 TCB+ SELF-THREADING SCREW</td> <td>3</td> <td>PZ</td> </tr> <tr> <td>VM1565B0</td> <td>VENTURI LOWER COIL SUPPORT</td> <td>1</td> <td>PZ</td> </tr> <tr> <td>VM1566A0</td> <td>VENTURI UPPER COIL SUPPORT</td> <td>1</td> <td>PZ</td> </tr> <tr> <td>VM1567A0</td> <td>VENTURI LOWER BUSHING</td> <td>1</td> <td>PZ</td> </tr> <tr> <td>VM1568A0</td> <td>VENTURI PLATE SPACE</td> <td>1</td> <td>PZ</td> </tr> </tbody> </table>	Code	Description	Qty	UOM	GN1556A0	MM VENTURI SEAL	1	PZ	RC1378A0	HOSE CLAMP	2	PZ	TB1520A0	INT. Ø=38 TH=4 DRAIN BLACK RUBBER PIPE	0.050	M	VE1135A0	220 V 50/60 HZ VENTURI ACTUATOR	1	PZ	VI1032A0	SCREW M4X16 TCB+ INOX	1	PZ	VI1511A0	STAINLESS STEEL WASHER 4.2X12X1	2	PZ	VI1850A0	M4X6 NICKEL PLATED FIXING SCRE	2	PZ	VI1865A0	5X10 TCB+ SELF-THREADING SCREW	3	PZ	VM1565B0	VENTURI LOWER COIL SUPPORT	1	PZ	VM1566A0	VENTURI UPPER COIL SUPPORT	1	PZ	VM1567A0	VENTURI LOWER BUSHING	1	PZ	VM1568A0	VENTURI PLATE SPACE	1	PZ
Code	Description	Qty	UOM																																																						
GN1556A0	MM VENTURI SEAL	1	PZ																																																						
RC1378A0	HOSE CLAMP	2	PZ																																																						
TB1520A0	INT. Ø=38 TH=4 DRAIN BLACK RUBBER PIPE	0.050	M																																																						
VE1135A0	220 V 50/60 HZ VENTURI ACTUATOR	1	PZ																																																						
VI1032A0	SCREW M4X16 TCB+ INOX	1	PZ																																																						
VI1511A0	STAINLESS STEEL WASHER 4.2X12X1	2	PZ																																																						
VI1850A0	M4X6 NICKEL PLATED FIXING SCRE	2	PZ																																																						
VI1865A0	5X10 TCB+ SELF-THREADING SCREW	3	PZ																																																						
VM1565B0	VENTURI LOWER COIL SUPPORT	1	PZ																																																						
VM1566A0	VENTURI UPPER COIL SUPPORT	1	PZ																																																						
VM1567A0	VENTURI LOWER BUSHING	1	PZ																																																						
VM1568A0	VENTURI PLATE SPACE	1	PZ																																																						
VN1165A	230VAC 50/60HZ COOLING DOWN FA		KVN1165A	S.5E ADVANCE/MM 230V COOLING FAN KIT	<table border="1"> <thead> <tr> <th>Code</th> <th>Description</th> <th>Qty</th> <th>UOM</th> </tr> </thead> <tbody> <tr> <td>VI1099A0</td> <td>SELF-DRILLING G SCREW 4.8X13 TCB+ Z</td> <td>4</td> <td>PZ</td> </tr> <tr> <td>VM1555A2</td> <td>CT BT COOLING FAN SUPPORT</td> <td>1</td> <td>PZ</td> </tr> <tr> <td>VN1165A0</td> <td>230VAC 50/60HZ COOLING DOWN FAN</td> <td>1</td> <td>PZ</td> </tr> <tr> <td>VN1165A0</td> <td>230VAC 50/60HZ COOLING DOWN FAN</td> <td>1</td> <td>PZ</td> </tr> </tbody> </table>	Code	Description	Qty	UOM	VI1099A0	SELF-DRILLING G SCREW 4.8X13 TCB+ Z	4	PZ	VM1555A2	CT BT COOLING FAN SUPPORT	1	PZ	VN1165A0	230VAC 50/60HZ COOLING DOWN FAN	1	PZ	VN1165A0	230VAC 50/60HZ COOLING DOWN FAN	1	PZ																																
Code	Description	Qty	UOM																																																						
VI1099A0	SELF-DRILLING G SCREW 4.8X13 TCB+ Z	4	PZ																																																						
VM1555A2	CT BT COOLING FAN SUPPORT	1	PZ																																																						
VN1165A0	230VAC 50/60HZ COOLING DOWN FAN	1	PZ																																																						
VN1165A0	230VAC 50/60HZ COOLING DOWN FAN	1	PZ																																																						





COMPONENT			SPARE PART																																						
Code	Description	Image	Code	Description	Components list																																				
VM1556A	XBC-XVC COOLING FAN GUARD		KVM1556A	XBC-XVC COOLING FAN GUARD KIT	<table border="1"> <thead> <tr> <th>Code</th> <th>Description</th> <th>Qty</th> <th>UOM</th> </tr> </thead> <tbody> <tr> <td>VM1556A0</td> <td>XBC-XVC COOLING FAN GUARD</td> <td>1</td> <td>PZ</td> </tr> </tbody> </table>	Code	Description	Qty	UOM	VM1556A0	XBC-XVC COOLING FAN GUARD	1	PZ																												
Code	Description	Qty	UOM																																						
VM1556A0	XBC-XVC COOLING FAN GUARD	1	PZ																																						
VM1555A	CT BT COOLING FAN SUPPORT		<p>KVN1165A</p> <p>KVN1164A</p>	<p>S.5E ADVANCE/MM 230V COOLING FAN KIT</p> <p>S.5/5E 12VDC COOLING DOWN FAN KIT</p>	<table border="1"> <thead> <tr> <th>Code</th> <th>Description</th> <th>Qty</th> <th>UOM</th> </tr> </thead> <tbody> <tr> <td>VI1099A0</td> <td>SELF-DRILLIN G SCREW 4.8X13 TCB+ Z</td> <td>4</td> <td>PZ</td> </tr> <tr> <td>VM1555A2</td> <td>CT BT COOLING FAN SUPPORT</td> <td>1</td> <td>PZ</td> </tr> <tr> <td>VN1165A0</td> <td>230VAC 50/60HZ COOLING DOWN FAN</td> <td>1</td> <td>PZ</td> </tr> <tr> <td>VN1165A0</td> <td>230VAC 50/60HZ COOLING DOWN FAN</td> <td>1</td> <td>PZ</td> </tr> <tr> <td>VI1099A0</td> <td>SELF-DRILLIN G SCREW 4.8X13 TCB+ Z</td> <td>4</td> <td>PZ</td> </tr> <tr> <td>VM1555A2</td> <td>CT BT COOLING FAN SUPPORT</td> <td>1</td> <td>PZ</td> </tr> <tr> <td>VN1164A0</td> <td>12VDC COOLING DONW FAN</td> <td>1</td> <td>PZ</td> </tr> <tr> <td>VN1164A0</td> <td>12VDC COOLING DONW FAN</td> <td>1</td> <td>PZ</td> </tr> </tbody> </table>	Code	Description	Qty	UOM	VI1099A0	SELF-DRILLIN G SCREW 4.8X13 TCB+ Z	4	PZ	VM1555A2	CT BT COOLING FAN SUPPORT	1	PZ	VN1165A0	230VAC 50/60HZ COOLING DOWN FAN	1	PZ	VN1165A0	230VAC 50/60HZ COOLING DOWN FAN	1	PZ	VI1099A0	SELF-DRILLIN G SCREW 4.8X13 TCB+ Z	4	PZ	VM1555A2	CT BT COOLING FAN SUPPORT	1	PZ	VN1164A0	12VDC COOLING DONW FAN	1	PZ	VN1164A0	12VDC COOLING DONW FAN	1	PZ
Code	Description	Qty	UOM																																						
VI1099A0	SELF-DRILLIN G SCREW 4.8X13 TCB+ Z	4	PZ																																						
VM1555A2	CT BT COOLING FAN SUPPORT	1	PZ																																						
VN1165A0	230VAC 50/60HZ COOLING DOWN FAN	1	PZ																																						
VN1165A0	230VAC 50/60HZ COOLING DOWN FAN	1	PZ																																						
VI1099A0	SELF-DRILLIN G SCREW 4.8X13 TCB+ Z	4	PZ																																						
VM1555A2	CT BT COOLING FAN SUPPORT	1	PZ																																						
VN1164A0	12VDC COOLING DONW FAN	1	PZ																																						
VN1164A0	12VDC COOLING DONW FAN	1	PZ																																						
GN1558A	EXHAUST SEAL		K0H7291A	GASKET AND SEALING DISC CHIMNEY KIT	<table border="1"> <thead> <tr> <th>Code</th> <th>Description</th> <th>Qty</th> <th>UOM</th> </tr> </thead> <tbody> <tr> <td>0H7291A0</td> <td>CHIMNEY HOLDING DIS</td> <td>1</td> <td>PZ</td> </tr> <tr> <td>GN1558A0</td> <td>EXHAUST SEA</td> <td>1</td> <td>PZ</td> </tr> </tbody> </table>	Code	Description	Qty	UOM	0H7291A0	CHIMNEY HOLDING DIS	1	PZ	GN1558A0	EXHAUST SEA	1	PZ																								
Code	Description	Qty	UOM																																						
0H7291A0	CHIMNEY HOLDING DIS	1	PZ																																						
GN1558A0	EXHAUST SEA	1	PZ																																						



COMPONENT			SPARE PART														
Code	Description	Image	Code	Description	Components list												
0H7291A	CHIMNEY HOLDING DISC		K0H7291A	GASKET AND SEALING DISC CHIMNEY KIT	<table border="1"> <thead> <tr> <th>Code</th> <th>Description</th> <th>Qty</th> <th>UOM</th> </tr> </thead> <tbody> <tr> <td>0H7291A0</td> <td>CHIMNEY HOLDING DISC</td> <td>1</td> <td>PZ</td> </tr> <tr> <td>GN1558A0</td> <td>EXHAUST SEA</td> <td>1</td> <td>PZ</td> </tr> </tbody> </table>	Code	Description	Qty	UOM	0H7291A0	CHIMNEY HOLDING DISC	1	PZ	GN1558A0	EXHAUST SEA	1	PZ
Code	Description	Qty	UOM														
0H7291A0	CHIMNEY HOLDING DISC	1	PZ														
GN1558A0	EXHAUST SEA	1	PZ														
0H2561A	6 S. DOOR COUNTERBRACKET		0H2561A0	6 S. DOOR COUNTERBRACKET													
RC1055A	Ø25-40 H12 STAINLESS STEEL PIPE CLIP		KRC1055A	Ø25-40 PIPE CLAMP 10PCS KIT	<table border="1"> <thead> <tr> <th>Code</th> <th>Description</th> <th>Qty</th> <th>UOM</th> </tr> </thead> <tbody> <tr> <td>RC1055A0</td> <td>Ø25-40 H12 STAINLESS STEEL PIPE CLIP</td> <td>10</td> <td>PZ</td> </tr> </tbody> </table>	Code	Description	Qty	UOM	RC1055A0	Ø25-40 H12 STAINLESS STEEL PIPE CLIP	10	PZ				
Code	Description	Qty	UOM														
RC1055A0	Ø25-40 H12 STAINLESS STEEL PIPE CLIP	10	PZ														
0F1506A	XEVC-2011 EXTERNAL UPPER BACK PANEL		0F1506A0	XEVC-2011 EXTERNAL UPPER BACK PANEL													
PD1078A	2FT ADJUSTABLE FOOT H147-190 PLATE		KPD1078A	2" H147-190 ADJUSTABLE FEET 4 PCS KIT	<table border="1"> <thead> <tr> <th>Code</th> <th>Description</th> <th>Qty</th> <th>UOM</th> </tr> </thead> <tbody> <tr> <td>PD1078A0</td> <td>2FT ADJUSTABLE FOOT H147-190 PLATE</td> <td>4</td> <td>PZ</td> </tr> </tbody> </table>	Code	Description	Qty	UOM	PD1078A0	2FT ADJUSTABLE FOOT H147-190 PLATE	4	PZ				
Code	Description	Qty	UOM														
PD1078A0	2FT ADJUSTABLE FOOT H147-190 PLATE	4	PZ														

COMPONENT			SPARE PART																										
Code	Description	Image	Code	Description	Components list																								
VM1190A	CT BT RIGHT DOOR SPRING LATCH		KVM1190A	CHEFTOP/BAKERTO P DOOR RIGHT LATCH KIT	<table border="1"> <thead> <tr> <th>Code</th> <th>Description</th> <th>Qty</th> <th>UOM</th> </tr> </thead> <tbody> <tr> <td>VI0239A1</td> <td>SELF-TAPPIN G SCREW 4.2X25 TCB+ INOX</td> <td>2</td> <td>PZ</td> </tr> <tr> <td>VI1220A1</td> <td>4,2X12 TCB SELF-TAPPIN G SCREW</td> <td>2</td> <td>PZ</td> </tr> <tr> <td>VM1190A2</td> <td>CT BT RIGHT DOOR SPRING LATCH</td> <td>1</td> <td>PZ</td> </tr> <tr> <td>VM1192A1</td> <td>CT BT DOOR SPRING LATCH BACK COVER</td> <td>1</td> <td>PZ</td> </tr> <tr> <td>VM1460A0</td> <td>XBC/XVC RIGHT DOOR LATCH CAP</td> <td>1</td> <td>PZ</td> </tr> </tbody> </table>	Code	Description	Qty	UOM	VI0239A1	SELF-TAPPIN G SCREW 4.2X25 TCB+ INOX	2	PZ	VI1220A1	4,2X12 TCB SELF-TAPPIN G SCREW	2	PZ	VM1190A2	CT BT RIGHT DOOR SPRING LATCH	1	PZ	VM1192A1	CT BT DOOR SPRING LATCH BACK COVER	1	PZ	VM1460A0	XBC/XVC RIGHT DOOR LATCH CAP	1	PZ
					Code	Description	Qty	UOM																					
VI0239A1	SELF-TAPPIN G SCREW 4.2X25 TCB+ INOX	2	PZ																										
VI1220A1	4,2X12 TCB SELF-TAPPIN G SCREW	2	PZ																										
VM1190A2	CT BT RIGHT DOOR SPRING LATCH	1	PZ																										
VM1192A1	CT BT DOOR SPRING LATCH BACK COVER	1	PZ																										
VM1460A0	XBC/XVC RIGHT DOOR LATCH CAP	1	PZ																										
<table border="1"> <thead> <tr> <th>Code</th> <th>Description</th> <th>Qty</th> <th>UOM</th> </tr> </thead> <tbody> <tr> <td>VI0239A1</td> <td>SELF-TAPPIN G SCREW 4.2X25 TCB+ INOX</td> <td>2</td> <td>PZ</td> </tr> <tr> <td>VI1220A1</td> <td>4,2X12 TCB SELF-TAPPIN G SCREW</td> <td>2</td> <td>PZ</td> </tr> <tr> <td>VM1191A2</td> <td>CT BT LEFT DOOR SPRING LATCH</td> <td>1</td> <td>PZ</td> </tr> <tr> <td>VM1192A1</td> <td>CT BT DOOR SPRING LATCH BACK COVER</td> <td>1</td> <td>PZ</td> </tr> <tr> <td>VM1460A0</td> <td>XBC/XVC RIGHT DOOR LATCH CAP</td> <td>1</td> <td>PZ</td> </tr> </tbody> </table>	Code	Description	Qty	UOM	VI0239A1	SELF-TAPPIN G SCREW 4.2X25 TCB+ INOX	2	PZ	VI1220A1	4,2X12 TCB SELF-TAPPIN G SCREW	2	PZ	VM1191A2	CT BT LEFT DOOR SPRING LATCH	1	PZ	VM1192A1	CT BT DOOR SPRING LATCH BACK COVER	1	PZ	VM1460A0	XBC/XVC RIGHT DOOR LATCH CAP	1	PZ					
Code	Description	Qty	UOM																										
VI0239A1	SELF-TAPPIN G SCREW 4.2X25 TCB+ INOX	2	PZ																										
VI1220A1	4,2X12 TCB SELF-TAPPIN G SCREW	2	PZ																										
VM1191A2	CT BT LEFT DOOR SPRING LATCH	1	PZ																										
VM1192A1	CT BT DOOR SPRING LATCH BACK COVER	1	PZ																										
VM1460A0	XBC/XVC RIGHT DOOR LATCH CAP	1	PZ																										
VM1192A	CT BT DOOR SPRING LATCH BACK COVER		KVM1191A	CHEFTOP/BAKERTO P DOOR LEFT LATCH KIT	<table border="1"> <thead> <tr> <th>Code</th> <th>Description</th> <th>Qty</th> <th>UOM</th> </tr> </thead> <tbody> <tr> <td>VI0239A1</td> <td>SELF-TAPPIN G SCREW 4.2X25 TCB+ INOX</td> <td>2</td> <td>PZ</td> </tr> <tr> <td>VI1220A1</td> <td>4,2X12 TCB SELF-TAPPIN G SCREW</td> <td>2</td> <td>PZ</td> </tr> <tr> <td>VM1191A2</td> <td>CT BT LEFT DOOR SPRING LATCH</td> <td>1</td> <td>PZ</td> </tr> <tr> <td>VM1192A1</td> <td>CT BT DOOR SPRING LATCH BACK COVER</td> <td>1</td> <td>PZ</td> </tr> <tr> <td>VM1460A0</td> <td>XBC/XVC RIGHT DOOR LATCH CAP</td> <td>1</td> <td>PZ</td> </tr> </tbody> </table>	Code	Description	Qty	UOM	VI0239A1	SELF-TAPPIN G SCREW 4.2X25 TCB+ INOX	2	PZ	VI1220A1	4,2X12 TCB SELF-TAPPIN G SCREW	2	PZ	VM1191A2	CT BT LEFT DOOR SPRING LATCH	1	PZ	VM1192A1	CT BT DOOR SPRING LATCH BACK COVER	1	PZ	VM1460A0	XBC/XVC RIGHT DOOR LATCH CAP	1	PZ
					Code	Description	Qty	UOM																					
VI0239A1	SELF-TAPPIN G SCREW 4.2X25 TCB+ INOX	2	PZ																										
VI1220A1	4,2X12 TCB SELF-TAPPIN G SCREW	2	PZ																										
VM1191A2	CT BT LEFT DOOR SPRING LATCH	1	PZ																										
VM1192A1	CT BT DOOR SPRING LATCH BACK COVER	1	PZ																										
VM1460A0	XBC/XVC RIGHT DOOR LATCH CAP	1	PZ																										
<table border="1"> <thead> <tr> <th>Code</th> <th>Description</th> <th>Qty</th> <th>UOM</th> </tr> </thead> <tbody> <tr> <td>VI0239A1</td> <td>SELF-TAPPIN G SCREW 4.2X25 TCB+ INOX</td> <td>2</td> <td>PZ</td> </tr> <tr> <td>VI1220A1</td> <td>4,2X12 TCB SELF-TAPPIN G SCREW</td> <td>2</td> <td>PZ</td> </tr> <tr> <td>VM1190A2</td> <td>CT BT RIGHT DOOR SPRING LATCH</td> <td>1</td> <td>PZ</td> </tr> <tr> <td>VM1192A1</td> <td>CT BT DOOR SPRING LATCH BACK COVER</td> <td>1</td> <td>PZ</td> </tr> <tr> <td>VM1460A0</td> <td>XBC/XVC RIGHT DOOR LATCH CAP</td> <td>1</td> <td>PZ</td> </tr> </tbody> </table>	Code	Description	Qty	UOM	VI0239A1	SELF-TAPPIN G SCREW 4.2X25 TCB+ INOX	2	PZ	VI1220A1	4,2X12 TCB SELF-TAPPIN G SCREW	2	PZ	VM1190A2	CT BT RIGHT DOOR SPRING LATCH	1	PZ	VM1192A1	CT BT DOOR SPRING LATCH BACK COVER	1	PZ	VM1460A0	XBC/XVC RIGHT DOOR LATCH CAP	1	PZ					
Code	Description	Qty	UOM																										
VI0239A1	SELF-TAPPIN G SCREW 4.2X25 TCB+ INOX	2	PZ																										
VI1220A1	4,2X12 TCB SELF-TAPPIN G SCREW	2	PZ																										
VM1190A2	CT BT RIGHT DOOR SPRING LATCH	1	PZ																										
VM1192A1	CT BT DOOR SPRING LATCH BACK COVER	1	PZ																										
VM1460A0	XBC/XVC RIGHT DOOR LATCH CAP	1	PZ																										
			KVM1190A	CHEFTOP/BAKERTO P DOOR RIGHT LATCH KIT	<table border="1"> <thead> <tr> <th>Code</th> <th>Description</th> <th>Qty</th> <th>UOM</th> </tr> </thead> <tbody> <tr> <td>VI0239A1</td> <td>SELF-TAPPIN G SCREW 4.2X25 TCB+ INOX</td> <td>2</td> <td>PZ</td> </tr> <tr> <td>VI1220A1</td> <td>4,2X12 TCB SELF-TAPPIN G SCREW</td> <td>2</td> <td>PZ</td> </tr> <tr> <td>VM1190A2</td> <td>CT BT RIGHT DOOR SPRING LATCH</td> <td>1</td> <td>PZ</td> </tr> <tr> <td>VM1192A1</td> <td>CT BT DOOR SPRING LATCH BACK COVER</td> <td>1</td> <td>PZ</td> </tr> <tr> <td>VM1460A0</td> <td>XBC/XVC RIGHT DOOR LATCH CAP</td> <td>1</td> <td>PZ</td> </tr> </tbody> </table>	Code	Description	Qty	UOM	VI0239A1	SELF-TAPPIN G SCREW 4.2X25 TCB+ INOX	2	PZ	VI1220A1	4,2X12 TCB SELF-TAPPIN G SCREW	2	PZ	VM1190A2	CT BT RIGHT DOOR SPRING LATCH	1	PZ	VM1192A1	CT BT DOOR SPRING LATCH BACK COVER	1	PZ	VM1460A0	XBC/XVC RIGHT DOOR LATCH CAP	1	PZ
Code	Description	Qty	UOM																										
VI0239A1	SELF-TAPPIN G SCREW 4.2X25 TCB+ INOX	2	PZ																										
VI1220A1	4,2X12 TCB SELF-TAPPIN G SCREW	2	PZ																										
VM1190A2	CT BT RIGHT DOOR SPRING LATCH	1	PZ																										
VM1192A1	CT BT DOOR SPRING LATCH BACK COVER	1	PZ																										
VM1460A0	XBC/XVC RIGHT DOOR LATCH CAP	1	PZ																										





COMPONENT			SPARE PART																																																						
Code	Description	Image	Code	Description	Components list																																																				
0H7274A	XEVC-2011 RIGHT TROLLEY GUIDE KIT		0H7274A0	XEVC-2011 RIGHT TROLLEY GUIDE KIT																																																					
0H7275A	XEVC-2011 LEFT TROLLEY GUIDE KIT		0H7275A0	XEVC-2011 LEFT TROLLEY GUIDE KIT																																																					
VL1005A	U-TRAP TANK		XUC001	SINGLE UNIT INSTALLATION KIT	<table border="1"> <thead> <tr> <th>Code</th> <th>Description</th> <th>Qty</th> <th>UOM</th> </tr> </thead> <tbody> <tr> <td>0H6567A0</td> <td>P-TRAP HOLDING PANEL</td> <td>1</td> <td>PZ</td> </tr> <tr> <td>GN1508A0</td> <td>O-RING GASKET COD 2400</td> <td>1</td> <td>PZ</td> </tr> <tr> <td>IL1115A0</td> <td>WOODEN PALET 80X120</td> <td>0.100</td> <td>PZ</td> </tr> <tr> <td>RC1055A0</td> <td>Ø25-40 H12 STAINLESS STEEL PIPE CLIP</td> <td>3</td> <td>PZ</td> </tr> <tr> <td>TB1520A0</td> <td>INT. Ø=38 TH=4 DRAIN BLACK RUBBER PIPE</td> <td>2.500</td> <td>M</td> </tr> <tr> <td>VI1220A1</td> <td>4,2X12 TCB SELF-TAPPIN G SCREW</td> <td>2</td> <td>PZ</td> </tr> <tr> <td>VI1895A0</td> <td>BLIND NUT M4 STAINLESS STEEL DIN 917</td> <td>4</td> <td>PZ</td> </tr> <tr> <td>VI1945A0</td> <td>ENG-VITE M4X20 TCB+ INOX</td> <td>4</td> <td>PZ</td> </tr> <tr> <td>VI1950A0</td> <td>ST. STEEL 4,2X13 TCB SELF-DRILLIN G SCREW</td> <td>2</td> <td>PZ</td> </tr> <tr> <td>VL1005A1</td> <td>U-TRAP TANK</td> <td>1</td> <td>PZ</td> </tr> <tr> <td>VL1006A0</td> <td>SYPHON COVER</td> <td>1</td> <td>PZ</td> </tr> <tr> <td>VM1015A1</td> <td>STAINLESS STEEL Ø30X1.5 90° BEND</td> <td>1</td> <td>PZ</td> </tr> </tbody> </table>	Code	Description	Qty	UOM	0H6567A0	P-TRAP HOLDING PANEL	1	PZ	GN1508A0	O-RING GASKET COD 2400	1	PZ	IL1115A0	WOODEN PALET 80X120	0.100	PZ	RC1055A0	Ø25-40 H12 STAINLESS STEEL PIPE CLIP	3	PZ	TB1520A0	INT. Ø=38 TH=4 DRAIN BLACK RUBBER PIPE	2.500	M	VI1220A1	4,2X12 TCB SELF-TAPPIN G SCREW	2	PZ	VI1895A0	BLIND NUT M4 STAINLESS STEEL DIN 917	4	PZ	VI1945A0	ENG-VITE M4X20 TCB+ INOX	4	PZ	VI1950A0	ST. STEEL 4,2X13 TCB SELF-DRILLIN G SCREW	2	PZ	VL1005A1	U-TRAP TANK	1	PZ	VL1006A0	SYPHON COVER	1	PZ	VM1015A1	STAINLESS STEEL Ø30X1.5 90° BEND	1	PZ
Code	Description	Qty	UOM																																																						
0H6567A0	P-TRAP HOLDING PANEL	1	PZ																																																						
GN1508A0	O-RING GASKET COD 2400	1	PZ																																																						
IL1115A0	WOODEN PALET 80X120	0.100	PZ																																																						
RC1055A0	Ø25-40 H12 STAINLESS STEEL PIPE CLIP	3	PZ																																																						
TB1520A0	INT. Ø=38 TH=4 DRAIN BLACK RUBBER PIPE	2.500	M																																																						
VI1220A1	4,2X12 TCB SELF-TAPPIN G SCREW	2	PZ																																																						
VI1895A0	BLIND NUT M4 STAINLESS STEEL DIN 917	4	PZ																																																						
VI1945A0	ENG-VITE M4X20 TCB+ INOX	4	PZ																																																						
VI1950A0	ST. STEEL 4,2X13 TCB SELF-DRILLIN G SCREW	2	PZ																																																						
VL1005A1	U-TRAP TANK	1	PZ																																																						
VL1006A0	SYPHON COVER	1	PZ																																																						
VM1015A1	STAINLESS STEEL Ø30X1.5 90° BEND	1	PZ																																																						



COMPONENT			SPARE PART																																																																																		
Code	Description	Image	Code	Description	Components list																																																																																
VL1005A	U-TRAP TANK		XC761	3 OVENS LM TOP XFT200 STACKING KIT	<table border="1"> <thead> <tr> <th>Code</th> <th>Description</th> <th>Qty</th> <th>UOM</th> </tr> </thead> <tbody> <tr> <td>0H1237A0</td> <td>LM TOP SIPHON SUPPORT</td> <td>3</td> <td>PZ</td> </tr> <tr> <td>0H7082A0</td> <td>LM 800 XC STACKING KIT FRONT PROFILE</td> <td>2</td> <td>PZ</td> </tr> <tr> <td>0H7083A0</td> <td>LM 800 XC STACKING KIT BACK PROFIL</td> <td>4</td> <td>PZ</td> </tr> <tr> <td>ED1246A0</td> <td>HOT SURFACE LABEL</td> <td>1</td> <td>PZ</td> </tr> <tr> <td>ED1271A0</td> <td>LIQUID FALLS DANGER LABE</td> <td>1</td> <td>PZ</td> </tr> <tr> <td>EL1020A1</td> <td>D8 INTERMEDIAT E T-SHAPED FITTING</td> <td>4</td> <td>PZ</td> </tr> <tr> <td>EL1180A0</td> <td>Ø8-Ø8 FEMALE NON-RETURN CONNECTION</td> <td>3</td> <td>PZ</td> </tr> <tr> <td>GN1508A0</td> <td>O-RING GASKET COD 2400</td> <td>3</td> <td>PZ</td> </tr> <tr> <td>RC1008A0</td> <td>D9 ELASTIC CLIP</td> <td>12</td> <td>PZ</td> </tr> <tr> <td>RC1055A0</td> <td>Ø25-40 H12 STAINLESS STEEL PIPE CLIP</td> <td>15</td> <td>PZ</td> </tr> <tr> <td>RC1297A1</td> <td>D10 T-SHAPED FITTING</td> <td>2</td> <td>PZ</td> </tr> <tr> <td>RC1360A0</td> <td>10 - 10 JG ELBOW FITTIN</td> <td>1</td> <td>PZ</td> </tr> <tr> <td>RC1376A0</td> <td>Ø6 Y-FITTING</td> <td>2</td> <td>PZ</td> </tr> <tr> <td>TB1177A0</td> <td>FOOT PANEL 40X40 H58 OVERLAP LM</td> <td>8</td> <td>PZ</td> </tr> <tr> <td>TB1520A0</td> <td>INT. Ø=38 TH=4 DRAIN BLACK RUBBER PIPE</td> <td>5</td> <td>M</td> </tr> <tr> <td>TB1815A0</td> <td>7,93X4,75 PE TRANSP. PIPE (JG #PE08100N)</td> <td>12</td> <td>M</td> </tr> <tr> <td>TB1816A0</td> <td>CLEAR POLYPROPYL ENE PIPE 6X4MM</td> <td>3</td> <td>M</td> </tr> <tr> <td>TB2243A0</td> <td>Ø10 PET PIPE</td> <td>4</td> <td>M</td> </tr> <tr> <td>VH1220A1</td> <td>4,2X12 TCB SELF-TAPPIN G SCREW</td> <td>30</td> <td>PZ</td> </tr> </tbody> </table>	Code	Description	Qty	UOM	0H1237A0	LM TOP SIPHON SUPPORT	3	PZ	0H7082A0	LM 800 XC STACKING KIT FRONT PROFILE	2	PZ	0H7083A0	LM 800 XC STACKING KIT BACK PROFIL	4	PZ	ED1246A0	HOT SURFACE LABEL	1	PZ	ED1271A0	LIQUID FALLS DANGER LABE	1	PZ	EL1020A1	D8 INTERMEDIAT E T-SHAPED FITTING	4	PZ	EL1180A0	Ø8-Ø8 FEMALE NON-RETURN CONNECTION	3	PZ	GN1508A0	O-RING GASKET COD 2400	3	PZ	RC1008A0	D9 ELASTIC CLIP	12	PZ	RC1055A0	Ø25-40 H12 STAINLESS STEEL PIPE CLIP	15	PZ	RC1297A1	D10 T-SHAPED FITTING	2	PZ	RC1360A0	10 - 10 JG ELBOW FITTIN	1	PZ	RC1376A0	Ø6 Y-FITTING	2	PZ	TB1177A0	FOOT PANEL 40X40 H58 OVERLAP LM	8	PZ	TB1520A0	INT. Ø=38 TH=4 DRAIN BLACK RUBBER PIPE	5	M	TB1815A0	7,93X4,75 PE TRANSP. PIPE (JG #PE08100N)	12	M	TB1816A0	CLEAR POLYPROPYL ENE PIPE 6X4MM	3	M	TB2243A0	Ø10 PET PIPE	4	M	VH1220A1	4,2X12 TCB SELF-TAPPIN G SCREW	30	PZ
Code	Description	Qty	UOM																																																																																		
0H1237A0	LM TOP SIPHON SUPPORT	3	PZ																																																																																		
0H7082A0	LM 800 XC STACKING KIT FRONT PROFILE	2	PZ																																																																																		
0H7083A0	LM 800 XC STACKING KIT BACK PROFIL	4	PZ																																																																																		
ED1246A0	HOT SURFACE LABEL	1	PZ																																																																																		
ED1271A0	LIQUID FALLS DANGER LABE	1	PZ																																																																																		
EL1020A1	D8 INTERMEDIAT E T-SHAPED FITTING	4	PZ																																																																																		
EL1180A0	Ø8-Ø8 FEMALE NON-RETURN CONNECTION	3	PZ																																																																																		
GN1508A0	O-RING GASKET COD 2400	3	PZ																																																																																		
RC1008A0	D9 ELASTIC CLIP	12	PZ																																																																																		
RC1055A0	Ø25-40 H12 STAINLESS STEEL PIPE CLIP	15	PZ																																																																																		
RC1297A1	D10 T-SHAPED FITTING	2	PZ																																																																																		
RC1360A0	10 - 10 JG ELBOW FITTIN	1	PZ																																																																																		
RC1376A0	Ø6 Y-FITTING	2	PZ																																																																																		
TB1177A0	FOOT PANEL 40X40 H58 OVERLAP LM	8	PZ																																																																																		
TB1520A0	INT. Ø=38 TH=4 DRAIN BLACK RUBBER PIPE	5	M																																																																																		
TB1815A0	7,93X4,75 PE TRANSP. PIPE (JG #PE08100N)	12	M																																																																																		
TB1816A0	CLEAR POLYPROPYL ENE PIPE 6X4MM	3	M																																																																																		
TB2243A0	Ø10 PET PIPE	4	M																																																																																		
VH1220A1	4,2X12 TCB SELF-TAPPIN G SCREW	30	PZ																																																																																		

COMPONENT			SPARE PART																																																			
Code	Description	Image	Code	Description	Components list																																																	
VL1005A	U-TRAP TANK		XC761	3 OVENS LM TOP XFT200 STACKING KIT	<table border="1"> <thead> <tr> <th>Code</th> <th>Description</th> <th>Qty</th> <th>UOM</th> </tr> </thead> <tbody> <tr> <td>VI1895A0</td> <td>BLIND NUT M4 STAINLESS STEEL DIN 917</td> <td>12</td> <td>PZ</td> </tr> <tr> <td>VI1945A0</td> <td>ENG-VITE M4X20 TCB+ INOX</td> <td>12</td> <td>PZ</td> </tr> <tr> <td>VI1950A0</td> <td>ST. STEEL 4,2X13 TCB SELF-DRILLIN G SCREW</td> <td>20</td> <td>PZ</td> </tr> <tr> <td>VL1005A1</td> <td>U-TRAP TANK</td> <td>3</td> <td>PZ</td> </tr> <tr> <td>VL1006A0</td> <td>SYPHON COVER</td> <td>3</td> <td>PZ</td> </tr> <tr> <td>VL1046A1</td> <td>D6 PIPE HOLDER - D6 J.G. TERMINAL</td> <td>12</td> <td>PZ</td> </tr> <tr> <td>VM1015A1</td> <td>STAINLESS STEEL Ø30X1.5 90° BEND</td> <td>1</td> <td>PZ</td> </tr> <tr> <td>VM1794A0</td> <td>250X4.8 PA66 BLACK CLAMP</td> <td>3</td> <td>PZ</td> </tr> <tr> <td>VM2035A0</td> <td>DRAIN PIPE SUPPORT</td> <td>3</td> <td>PZ</td> </tr> </tbody> </table>	Code	Description	Qty	UOM	VI1895A0	BLIND NUT M4 STAINLESS STEEL DIN 917	12	PZ	VI1945A0	ENG-VITE M4X20 TCB+ INOX	12	PZ	VI1950A0	ST. STEEL 4,2X13 TCB SELF-DRILLIN G SCREW	20	PZ	VL1005A1	U-TRAP TANK	3	PZ	VL1006A0	SYPHON COVER	3	PZ	VL1046A1	D6 PIPE HOLDER - D6 J.G. TERMINAL	12	PZ	VM1015A1	STAINLESS STEEL Ø30X1.5 90° BEND	1	PZ	VM1794A0	250X4.8 PA66 BLACK CLAMP	3	PZ	VM2035A0	DRAIN PIPE SUPPORT	3	PZ									
			Code	Description	Qty	UOM																																																
VI1895A0	BLIND NUT M4 STAINLESS STEEL DIN 917	12	PZ																																																			
VI1945A0	ENG-VITE M4X20 TCB+ INOX	12	PZ																																																			
VI1950A0	ST. STEEL 4,2X13 TCB SELF-DRILLIN G SCREW	20	PZ																																																			
VL1005A1	U-TRAP TANK	3	PZ																																																			
VL1006A0	SYPHON COVER	3	PZ																																																			
VL1046A1	D6 PIPE HOLDER - D6 J.G. TERMINAL	12	PZ																																																			
VM1015A1	STAINLESS STEEL Ø30X1.5 90° BEND	1	PZ																																																			
VM1794A0	250X4.8 PA66 BLACK CLAMP	3	PZ																																																			
VM2035A0	DRAIN PIPE SUPPORT	3	PZ																																																			
XC757	S. E CHEFTOP GN1/1 STACKING KI	<table border="1"> <thead> <tr> <th>Code</th> <th>Description</th> <th>Qty</th> <th>UOM</th> </tr> </thead> <tbody> <tr> <td>0H6463A0</td> <td>XC757 FRONT PROFILE</td> <td>1</td> <td>PZ</td> </tr> <tr> <td>CE1305A0</td> <td>L=2MT RJ45 - RJ45 CABLE</td> <td>1</td> <td>PZ</td> </tr> <tr> <td>ED1246A0</td> <td>HOT SURFACE LABEL</td> <td>2</td> <td>PZ</td> </tr> <tr> <td>ED1271A0</td> <td>LIQUID FALLS DANGER LABE</td> <td>1</td> <td>PZ</td> </tr> <tr> <td>EL1020A1</td> <td>D8 INTERMEDIAT E T-SHAPED FITTING</td> <td>2</td> <td>PZ</td> </tr> <tr> <td>GN1508A0</td> <td>O-RING GASKET COD 2400</td> <td>2</td> <td>PZ</td> </tr> <tr> <td>PD1069A0</td> <td>FOOT OVERLAP S5 CT-BT-E</td> <td>1</td> <td>PZ</td> </tr> <tr> <td>RC1008A0</td> <td>D9 ELASTIC CLIP</td> <td>3</td> <td>PZ</td> </tr> <tr> <td>RC1055A0</td> <td>Ø25-40 H12 STAINLESS STEEL PIPE CLIP</td> <td>14</td> <td>PZ</td> </tr> <tr> <td>RC1130A0</td> <td>130X2.6 CLAM</td> <td>3</td> <td>PZ</td> </tr> <tr> <td>RC1297A1</td> <td>D10 T-SHAPED FITTING</td> <td>1</td> <td>PZ</td> </tr> <tr> <td>RC1376A0</td> <td>Ø6 Y-FITTING</td> <td>1</td> <td>PZ</td> </tr> </tbody> </table>	Code	Description	Qty	UOM	0H6463A0	XC757 FRONT PROFILE	1	PZ	CE1305A0	L=2MT RJ45 - RJ45 CABLE	1	PZ	ED1246A0	HOT SURFACE LABEL	2	PZ	ED1271A0	LIQUID FALLS DANGER LABE	1	PZ	EL1020A1	D8 INTERMEDIAT E T-SHAPED FITTING	2	PZ	GN1508A0	O-RING GASKET COD 2400	2	PZ	PD1069A0	FOOT OVERLAP S5 CT-BT-E	1	PZ	RC1008A0	D9 ELASTIC CLIP	3	PZ	RC1055A0	Ø25-40 H12 STAINLESS STEEL PIPE CLIP	14	PZ	RC1130A0	130X2.6 CLAM	3	PZ	RC1297A1	D10 T-SHAPED FITTING	1	PZ	RC1376A0	Ø6 Y-FITTING	1	PZ
Code	Description	Qty	UOM																																																			
0H6463A0	XC757 FRONT PROFILE	1	PZ																																																			
CE1305A0	L=2MT RJ45 - RJ45 CABLE	1	PZ																																																			
ED1246A0	HOT SURFACE LABEL	2	PZ																																																			
ED1271A0	LIQUID FALLS DANGER LABE	1	PZ																																																			
EL1020A1	D8 INTERMEDIAT E T-SHAPED FITTING	2	PZ																																																			
GN1508A0	O-RING GASKET COD 2400	2	PZ																																																			
PD1069A0	FOOT OVERLAP S5 CT-BT-E	1	PZ																																																			
RC1008A0	D9 ELASTIC CLIP	3	PZ																																																			
RC1055A0	Ø25-40 H12 STAINLESS STEEL PIPE CLIP	14	PZ																																																			
RC1130A0	130X2.6 CLAM	3	PZ																																																			
RC1297A1	D10 T-SHAPED FITTING	1	PZ																																																			
RC1376A0	Ø6 Y-FITTING	1	PZ																																																			

COMPONENT			SPARE PART																																																																																									
Code	Description	Image	Code	Description	Components list																																																																																							
VL1005A	U-TRAP TANK		XC757	S. E CHEFTOP GN1/1 STACKING KI	<table border="1"> <thead> <tr> <th>Code</th> <th>Description</th> <th>Qty</th> <th>UOM</th> </tr> </thead> <tbody> <tr> <td>TB1520A0</td> <td>INT. Ø=38 TH=4 DRAIN BLACK RUBBER PIPE</td> <td>5</td> <td>M</td> </tr> <tr> <td>TB1765A1</td> <td>STACKING KIT CHIMNEY CONNECTING PIPE</td> <td>2</td> <td>PZ</td> </tr> <tr> <td>TB2243A0</td> <td>Ø10 PET PIPE</td> <td>1.500</td> <td>M</td> </tr> <tr> <td>VI1220A1</td> <td>4,2X12 TCB SELF-TAPPIN G SCREW</td> <td>4</td> <td>PZ</td> </tr> <tr> <td>VI1895A0</td> <td>BLIND NUT M4 STAINLESS STEEL DIN 917</td> <td>8</td> <td>PZ</td> </tr> <tr> <td>VI1945A0</td> <td>ENG-VITE M4X20 TCB+ INOX</td> <td>8</td> <td>PZ</td> </tr> <tr> <td>VI1950A0</td> <td>ST. STEEL 4,2X13 TCB SELF-DRILLIN G SCREW</td> <td>26</td> <td>PZ</td> </tr> <tr> <td>VL1005A1</td> <td>U-TRAP TANK</td> <td>2</td> <td>PZ</td> </tr> <tr> <td>VL1006A0</td> <td>SYPHON COVER</td> <td>2</td> <td>PZ</td> </tr> <tr> <td>VL1043A0</td> <td>D4 PIPE HOLDER - D6 J.G. TERMINAL</td> <td>3</td> <td>PZ</td> </tr> <tr> <td>VL1046A1</td> <td>D6 PIPE HOLDER - D6 J.G. TERMINAL</td> <td>3</td> <td>PZ</td> </tr> <tr> <td>VM1015A1</td> <td>STAINLESS STEEL Ø30X1.5 90° BEND</td> <td>1</td> <td>PZ</td> </tr> <tr> <td>VM1794A0</td> <td>250X4.8 PA66 BLACK CLAMP</td> <td>3</td> <td>PZ</td> </tr> <tr> <td>VM1987A0</td> <td>BRACKET FOR OVENS STACKING</td> <td>1</td> <td>PZ</td> </tr> <tr> <td>VM2035A0</td> <td>DRAIN PIPE SUPPORT</td> <td>2</td> <td>PZ</td> </tr> </tbody> </table>	Code	Description	Qty	UOM	TB1520A0	INT. Ø=38 TH=4 DRAIN BLACK RUBBER PIPE	5	M	TB1765A1	STACKING KIT CHIMNEY CONNECTING PIPE	2	PZ	TB2243A0	Ø10 PET PIPE	1.500	M	VI1220A1	4,2X12 TCB SELF-TAPPIN G SCREW	4	PZ	VI1895A0	BLIND NUT M4 STAINLESS STEEL DIN 917	8	PZ	VI1945A0	ENG-VITE M4X20 TCB+ INOX	8	PZ	VI1950A0	ST. STEEL 4,2X13 TCB SELF-DRILLIN G SCREW	26	PZ	VL1005A1	U-TRAP TANK	2	PZ	VL1006A0	SYPHON COVER	2	PZ	VL1043A0	D4 PIPE HOLDER - D6 J.G. TERMINAL	3	PZ	VL1046A1	D6 PIPE HOLDER - D6 J.G. TERMINAL	3	PZ	VM1015A1	STAINLESS STEEL Ø30X1.5 90° BEND	1	PZ	VM1794A0	250X4.8 PA66 BLACK CLAMP	3	PZ	VM1987A0	BRACKET FOR OVENS STACKING	1	PZ	VM2035A0	DRAIN PIPE SUPPORT	2	PZ	XC756	E SERIES GN 2/3 STACKING KIT	<table border="1"> <thead> <tr> <th>Code</th> <th>Description</th> <th>Qty</th> <th>UOM</th> </tr> </thead> <tbody> <tr> <td>0H6462A0</td> <td>XC756 FRONT PROFILE</td> <td>1</td> <td>PZ</td> </tr> <tr> <td>CE1305A0</td> <td>L=2MT RJ45 - RJ45 CABLE</td> <td>1</td> <td>PZ</td> </tr> <tr> <td>ED1246A0</td> <td>HOT SURFACE LABEL</td> <td>1</td> <td>PZ</td> </tr> <tr> <td>ED1271A0</td> <td>LIQUID FALLS DANGER LABE</td> <td>1</td> <td>PZ</td> </tr> </tbody> </table>	Code	Description	Qty	UOM	0H6462A0	XC756 FRONT PROFILE	1	PZ	CE1305A0	L=2MT RJ45 - RJ45 CABLE	1	PZ	ED1246A0	HOT SURFACE LABEL	1	PZ	ED1271A0	LIQUID FALLS DANGER LABE	1	PZ
			Code	Description	Qty	UOM																																																																																						
TB1520A0	INT. Ø=38 TH=4 DRAIN BLACK RUBBER PIPE	5	M																																																																																									
TB1765A1	STACKING KIT CHIMNEY CONNECTING PIPE	2	PZ																																																																																									
TB2243A0	Ø10 PET PIPE	1.500	M																																																																																									
VI1220A1	4,2X12 TCB SELF-TAPPIN G SCREW	4	PZ																																																																																									
VI1895A0	BLIND NUT M4 STAINLESS STEEL DIN 917	8	PZ																																																																																									
VI1945A0	ENG-VITE M4X20 TCB+ INOX	8	PZ																																																																																									
VI1950A0	ST. STEEL 4,2X13 TCB SELF-DRILLIN G SCREW	26	PZ																																																																																									
VL1005A1	U-TRAP TANK	2	PZ																																																																																									
VL1006A0	SYPHON COVER	2	PZ																																																																																									
VL1043A0	D4 PIPE HOLDER - D6 J.G. TERMINAL	3	PZ																																																																																									
VL1046A1	D6 PIPE HOLDER - D6 J.G. TERMINAL	3	PZ																																																																																									
VM1015A1	STAINLESS STEEL Ø30X1.5 90° BEND	1	PZ																																																																																									
VM1794A0	250X4.8 PA66 BLACK CLAMP	3	PZ																																																																																									
VM1987A0	BRACKET FOR OVENS STACKING	1	PZ																																																																																									
VM2035A0	DRAIN PIPE SUPPORT	2	PZ																																																																																									
Code	Description	Qty	UOM																																																																																									
0H6462A0	XC756 FRONT PROFILE	1	PZ																																																																																									
CE1305A0	L=2MT RJ45 - RJ45 CABLE	1	PZ																																																																																									
ED1246A0	HOT SURFACE LABEL	1	PZ																																																																																									
ED1271A0	LIQUID FALLS DANGER LABE	1	PZ																																																																																									

COMPONENT			SPARE PART																																																																																						
Code	Description	Image	Code	Description	Components list																																																																																				
VL1005A	U-TRAP TANK		XC756	E SERIES GN 2/3 STACKING KIT	<table border="1"> <thead> <tr> <th>Code</th> <th>Description</th> <th>Qty</th> <th>UOM</th> </tr> </thead> <tbody> <tr> <td>EL1020A1</td> <td>D8 INTERMEDIAT E T-SHAPED FITTING</td> <td>2</td> <td>PZ</td> </tr> <tr> <td>GN1508A0</td> <td>O-RING GASKET COD 2400</td> <td>2</td> <td>PZ</td> </tr> <tr> <td>PD1069A0</td> <td>FOOT OVERLAP S5 CT-BT-E</td> <td>1</td> <td>PZ</td> </tr> <tr> <td>RC1008A0</td> <td>D9 ELASTIC CLIP</td> <td>3</td> <td>PZ</td> </tr> <tr> <td>RC1055A0</td> <td>Ø25-40 H12 STAINLESS STEEL PIPE CLIP</td> <td>14</td> <td>PZ</td> </tr> <tr> <td>RC1130A0</td> <td>130X2,6 CLAM</td> <td>3</td> <td>PZ</td> </tr> <tr> <td>RC1297A1</td> <td>D10 T-SHAPED FITTING</td> <td>1</td> <td>PZ</td> </tr> <tr> <td>RC1376A0</td> <td>Ø6 Y-FITTING</td> <td>1</td> <td>PZ</td> </tr> <tr> <td>TB1520A0</td> <td>INT. Ø=38 TH=4 DRAIN BLACK RUBBER PIPE</td> <td>3</td> <td>M</td> </tr> <tr> <td>TB1765A1</td> <td>STACKING KIT CHIMNEY CONNECTING PIPE</td> <td>1</td> <td>PZ</td> </tr> <tr> <td>TB2243A0</td> <td>Ø10 PET PIPE</td> <td>1.500</td> <td>M</td> </tr> <tr> <td>VI1220A1</td> <td>4,2X12 TCB SELF-TAPPIN G SCREW</td> <td>4</td> <td>PZ</td> </tr> <tr> <td>VI1895A0</td> <td>BLIND NUT M4 STAINLESS STEEL DIN 917</td> <td>8</td> <td>PZ</td> </tr> <tr> <td>VI1945A0</td> <td>ENG-VITE M4X20 TCB+ INOX</td> <td>8</td> <td>PZ</td> </tr> <tr> <td>VI1950A0</td> <td>ST. STEEL 4,2X13 TCB SELF-DRILLIN G SCREW</td> <td>26</td> <td>PZ</td> </tr> <tr> <td>VL1005A1</td> <td>U-TRAP TANK</td> <td>2</td> <td>PZ</td> </tr> <tr> <td>VL1006A0</td> <td>SYPHON COVER</td> <td>2</td> <td>PZ</td> </tr> <tr> <td>VL1043A0</td> <td>D4 PIPE HOLDER - D6 J.G. TERMINAL</td> <td>3</td> <td>PZ</td> </tr> <tr> <td>VL1046A1</td> <td>D6 PIPE HOLDER - D6 J.G. TERMINAL</td> <td>3</td> <td>PZ</td> </tr> <tr> <td>VM1015A1</td> <td>STAINLESS STEEL Ø30X1,5 90° BEND</td> <td>1</td> <td>PZ</td> </tr> </tbody> </table>	Code	Description	Qty	UOM	EL1020A1	D8 INTERMEDIAT E T-SHAPED FITTING	2	PZ	GN1508A0	O-RING GASKET COD 2400	2	PZ	PD1069A0	FOOT OVERLAP S5 CT-BT-E	1	PZ	RC1008A0	D9 ELASTIC CLIP	3	PZ	RC1055A0	Ø25-40 H12 STAINLESS STEEL PIPE CLIP	14	PZ	RC1130A0	130X2,6 CLAM	3	PZ	RC1297A1	D10 T-SHAPED FITTING	1	PZ	RC1376A0	Ø6 Y-FITTING	1	PZ	TB1520A0	INT. Ø=38 TH=4 DRAIN BLACK RUBBER PIPE	3	M	TB1765A1	STACKING KIT CHIMNEY CONNECTING PIPE	1	PZ	TB2243A0	Ø10 PET PIPE	1.500	M	VI1220A1	4,2X12 TCB SELF-TAPPIN G SCREW	4	PZ	VI1895A0	BLIND NUT M4 STAINLESS STEEL DIN 917	8	PZ	VI1945A0	ENG-VITE M4X20 TCB+ INOX	8	PZ	VI1950A0	ST. STEEL 4,2X13 TCB SELF-DRILLIN G SCREW	26	PZ	VL1005A1	U-TRAP TANK	2	PZ	VL1006A0	SYPHON COVER	2	PZ	VL1043A0	D4 PIPE HOLDER - D6 J.G. TERMINAL	3	PZ	VL1046A1	D6 PIPE HOLDER - D6 J.G. TERMINAL	3	PZ	VM1015A1	STAINLESS STEEL Ø30X1,5 90° BEND	1	PZ
Code	Description	Qty	UOM																																																																																						
EL1020A1	D8 INTERMEDIAT E T-SHAPED FITTING	2	PZ																																																																																						
GN1508A0	O-RING GASKET COD 2400	2	PZ																																																																																						
PD1069A0	FOOT OVERLAP S5 CT-BT-E	1	PZ																																																																																						
RC1008A0	D9 ELASTIC CLIP	3	PZ																																																																																						
RC1055A0	Ø25-40 H12 STAINLESS STEEL PIPE CLIP	14	PZ																																																																																						
RC1130A0	130X2,6 CLAM	3	PZ																																																																																						
RC1297A1	D10 T-SHAPED FITTING	1	PZ																																																																																						
RC1376A0	Ø6 Y-FITTING	1	PZ																																																																																						
TB1520A0	INT. Ø=38 TH=4 DRAIN BLACK RUBBER PIPE	3	M																																																																																						
TB1765A1	STACKING KIT CHIMNEY CONNECTING PIPE	1	PZ																																																																																						
TB2243A0	Ø10 PET PIPE	1.500	M																																																																																						
VI1220A1	4,2X12 TCB SELF-TAPPIN G SCREW	4	PZ																																																																																						
VI1895A0	BLIND NUT M4 STAINLESS STEEL DIN 917	8	PZ																																																																																						
VI1945A0	ENG-VITE M4X20 TCB+ INOX	8	PZ																																																																																						
VI1950A0	ST. STEEL 4,2X13 TCB SELF-DRILLIN G SCREW	26	PZ																																																																																						
VL1005A1	U-TRAP TANK	2	PZ																																																																																						
VL1006A0	SYPHON COVER	2	PZ																																																																																						
VL1043A0	D4 PIPE HOLDER - D6 J.G. TERMINAL	3	PZ																																																																																						
VL1046A1	D6 PIPE HOLDER - D6 J.G. TERMINAL	3	PZ																																																																																						
VM1015A1	STAINLESS STEEL Ø30X1,5 90° BEND	1	PZ																																																																																						

COMPONENT			SPARE PART																																																																											
Code	Description	Image	Code	Description	Components list																																																																									
VL1005A	U-TRAP TANK		XC756	E SERIES GN 2/3 STACKING KIT	<table border="1"> <thead> <tr> <th>Code</th> <th>Description</th> <th>Qty</th> <th>UOM</th> </tr> </thead> <tbody> <tr> <td>VM1794A0</td> <td>250X4.8 PA66 BLACK CLAMP</td> <td>3</td> <td>PZ</td> </tr> <tr> <td>VM1987A0</td> <td>BRACKET FOR OVENS STACKING</td> <td>1</td> <td>PZ</td> </tr> <tr> <td>VM2035A0</td> <td>DRAIN PIPE SUPPORT</td> <td>1</td> <td>PZ</td> </tr> </tbody> </table>	Code	Description	Qty	UOM	VM1794A0	250X4.8 PA66 BLACK CLAMP	3	PZ	VM1987A0	BRACKET FOR OVENS STACKING	1	PZ	VM2035A0	DRAIN PIPE SUPPORT	1	PZ																																																									
			Code	Description	Qty	UOM																																																																								
VM1794A0	250X4.8 PA66 BLACK CLAMP	3	PZ																																																																											
VM1987A0	BRACKET FOR OVENS STACKING	1	PZ																																																																											
VM2035A0	DRAIN PIPE SUPPORT	1	PZ																																																																											
XC755	E SERIES BT-CT GN 2/1 STACKING KIT	<table border="1"> <thead> <tr> <th>Code</th> <th>Description</th> <th>Qty</th> <th>UOM</th> </tr> </thead> <tbody> <tr> <td>0H6461A0</td> <td>XC755 FRONT PROFILE</td> <td>1</td> <td>PZ</td> </tr> <tr> <td>CE1635A0</td> <td>RJ45 - RJ45 CABLE L=3M</td> <td>1</td> <td>PZ</td> </tr> <tr> <td>ED1246A0</td> <td>HOT SURFACE LABEL</td> <td>2</td> <td>PZ</td> </tr> <tr> <td>ED1271A0</td> <td>LIQUID FALLS DANGER LABE</td> <td>1</td> <td>PZ</td> </tr> <tr> <td>EL1020A1</td> <td>D8 INTERMEDIAT E T-SHAPED FITTING</td> <td>2</td> <td>PZ</td> </tr> <tr> <td>GN1508A0</td> <td>O-RING GASKET COD 2400</td> <td>2</td> <td>PZ</td> </tr> <tr> <td>PD1069A0</td> <td>FOOT OVERLAP S5 CT-BT-E</td> <td>1</td> <td>PZ</td> </tr> <tr> <td>RC1008A0</td> <td>D9 ELASTIC CLIP</td> <td>3</td> <td>PZ</td> </tr> <tr> <td>RC1055A0</td> <td>Ø25-40 H12 STAINLESS STEEL PIPE CLIP</td> <td>14</td> <td>PZ</td> </tr> <tr> <td>RC1130A0</td> <td>130X2.6 CLAM</td> <td>3</td> <td>PZ</td> </tr> <tr> <td>RC1297A1</td> <td>D10 T-SHAPED FITTING</td> <td>1</td> <td>PZ</td> </tr> <tr> <td>RC1376A0</td> <td>Ø6 Y-FITTING</td> <td>1</td> <td>PZ</td> </tr> <tr> <td>TB1520A0</td> <td>INT. Ø=38 TH=4 DRAIN BLACK RUBBER PIPE</td> <td>5</td> <td>M</td> </tr> <tr> <td>TB1765A1</td> <td>STACKING KIT CHIMNEY CONNECTING PIPE</td> <td>2</td> <td>PZ</td> </tr> <tr> <td>TB2243A0</td> <td>Ø10 PET PIPE</td> <td>1.500</td> <td>M</td> </tr> <tr> <td>VI1220A1</td> <td>4,2X12 TCB SELF-TAPPIN G SCREW</td> <td>4</td> <td>PZ</td> </tr> <tr> <td>VI1895A0</td> <td>BLIND NUT M4 STAINLESS STEEL DIN 917</td> <td>8</td> <td>PZ</td> </tr> <tr> <td>VI1945A0</td> <td>ENG-VITE M4X20 TCB+ INOX</td> <td>8</td> <td>PZ</td> </tr> </tbody> </table>	Code	Description	Qty	UOM	0H6461A0	XC755 FRONT PROFILE	1	PZ	CE1635A0	RJ45 - RJ45 CABLE L=3M	1	PZ	ED1246A0	HOT SURFACE LABEL	2	PZ	ED1271A0	LIQUID FALLS DANGER LABE	1	PZ	EL1020A1	D8 INTERMEDIAT E T-SHAPED FITTING	2	PZ	GN1508A0	O-RING GASKET COD 2400	2	PZ	PD1069A0	FOOT OVERLAP S5 CT-BT-E	1	PZ	RC1008A0	D9 ELASTIC CLIP	3	PZ	RC1055A0	Ø25-40 H12 STAINLESS STEEL PIPE CLIP	14	PZ	RC1130A0	130X2.6 CLAM	3	PZ	RC1297A1	D10 T-SHAPED FITTING	1	PZ	RC1376A0	Ø6 Y-FITTING	1	PZ	TB1520A0	INT. Ø=38 TH=4 DRAIN BLACK RUBBER PIPE	5	M	TB1765A1	STACKING KIT CHIMNEY CONNECTING PIPE	2	PZ	TB2243A0	Ø10 PET PIPE	1.500	M	VI1220A1	4,2X12 TCB SELF-TAPPIN G SCREW	4	PZ	VI1895A0	BLIND NUT M4 STAINLESS STEEL DIN 917	8	PZ	VI1945A0	ENG-VITE M4X20 TCB+ INOX	8	PZ
Code	Description	Qty	UOM																																																																											
0H6461A0	XC755 FRONT PROFILE	1	PZ																																																																											
CE1635A0	RJ45 - RJ45 CABLE L=3M	1	PZ																																																																											
ED1246A0	HOT SURFACE LABEL	2	PZ																																																																											
ED1271A0	LIQUID FALLS DANGER LABE	1	PZ																																																																											
EL1020A1	D8 INTERMEDIAT E T-SHAPED FITTING	2	PZ																																																																											
GN1508A0	O-RING GASKET COD 2400	2	PZ																																																																											
PD1069A0	FOOT OVERLAP S5 CT-BT-E	1	PZ																																																																											
RC1008A0	D9 ELASTIC CLIP	3	PZ																																																																											
RC1055A0	Ø25-40 H12 STAINLESS STEEL PIPE CLIP	14	PZ																																																																											
RC1130A0	130X2.6 CLAM	3	PZ																																																																											
RC1297A1	D10 T-SHAPED FITTING	1	PZ																																																																											
RC1376A0	Ø6 Y-FITTING	1	PZ																																																																											
TB1520A0	INT. Ø=38 TH=4 DRAIN BLACK RUBBER PIPE	5	M																																																																											
TB1765A1	STACKING KIT CHIMNEY CONNECTING PIPE	2	PZ																																																																											
TB2243A0	Ø10 PET PIPE	1.500	M																																																																											
VI1220A1	4,2X12 TCB SELF-TAPPIN G SCREW	4	PZ																																																																											
VI1895A0	BLIND NUT M4 STAINLESS STEEL DIN 917	8	PZ																																																																											
VI1945A0	ENG-VITE M4X20 TCB+ INOX	8	PZ																																																																											



COMPONENT			SPARE PART																																															
Code	Description	Image	Code	Description	Components list																																													
VL1005A	U-TRAP TANK		XC755	E SERIES BT-CT GN 2/1 STACKING KIT	<table border="1"> <thead> <tr> <th>Code</th> <th>Description</th> <th>Qty</th> <th>UOM</th> </tr> </thead> <tbody> <tr> <td>VI1950A0</td> <td>ST. STEEL 4,2X13 TCB SELF-DRILLIN G SCREW</td> <td>26</td> <td>PZ</td> </tr> <tr> <td>VL1005A1</td> <td>U-TRAP TANK</td> <td>2</td> <td>PZ</td> </tr> <tr> <td>VL1006A0</td> <td>SYPHON COVER</td> <td>2</td> <td>PZ</td> </tr> <tr> <td>VL1043A0</td> <td>D4 PIPE HOLDER - D6 J.G. TERMINAL</td> <td>3</td> <td>PZ</td> </tr> <tr> <td>VL1046A1</td> <td>D6 PIPE HOLDER - D6 J.G. TERMINAL</td> <td>3</td> <td>PZ</td> </tr> <tr> <td>VM1015A1</td> <td>STAINLESS STEEL Ø30X1.5 90° BEND</td> <td>1</td> <td>PZ</td> </tr> <tr> <td>VM1794A0</td> <td>250X4.8 PA66 BLACK CLAMP</td> <td>3</td> <td>PZ</td> </tr> <tr> <td>VM1987A0</td> <td>BRACKET FOR OVENS STACKING</td> <td>1</td> <td>PZ</td> </tr> <tr> <td>VM2035A0</td> <td>DRAIN PIPE SUPPORT</td> <td>2</td> <td>PZ</td> </tr> </tbody> </table>	Code	Description	Qty	UOM	VI1950A0	ST. STEEL 4,2X13 TCB SELF-DRILLIN G SCREW	26	PZ	VL1005A1	U-TRAP TANK	2	PZ	VL1006A0	SYPHON COVER	2	PZ	VL1043A0	D4 PIPE HOLDER - D6 J.G. TERMINAL	3	PZ	VL1046A1	D6 PIPE HOLDER - D6 J.G. TERMINAL	3	PZ	VM1015A1	STAINLESS STEEL Ø30X1.5 90° BEND	1	PZ	VM1794A0	250X4.8 PA66 BLACK CLAMP	3	PZ	VM1987A0	BRACKET FOR OVENS STACKING	1	PZ	VM2035A0	DRAIN PIPE SUPPORT	2	PZ					
			Code	Description	Qty	UOM																																												
VI1950A0	ST. STEEL 4,2X13 TCB SELF-DRILLIN G SCREW	26	PZ																																															
VL1005A1	U-TRAP TANK	2	PZ																																															
VL1006A0	SYPHON COVER	2	PZ																																															
VL1043A0	D4 PIPE HOLDER - D6 J.G. TERMINAL	3	PZ																																															
VL1046A1	D6 PIPE HOLDER - D6 J.G. TERMINAL	3	PZ																																															
VM1015A1	STAINLESS STEEL Ø30X1.5 90° BEND	1	PZ																																															
VM1794A0	250X4.8 PA66 BLACK CLAMP	3	PZ																																															
VM1987A0	BRACKET FOR OVENS STACKING	1	PZ																																															
VM2035A0	DRAIN PIPE SUPPORT	2	PZ																																															
XC699	LINEMISS TOP FIRST INSTALLATION KIT	<table border="1"> <thead> <tr> <th>Code</th> <th>Description</th> <th>Qty</th> <th>UOM</th> </tr> </thead> <tbody> <tr> <td>0H1237A0</td> <td>LM TOP SIPHON SUPPORT</td> <td>1</td> <td>PZ</td> </tr> <tr> <td>GN1508A0</td> <td>O-RING GASKET COD 2400</td> <td>1</td> <td>PZ</td> </tr> <tr> <td>RC1055A0</td> <td>Ø25-40 H12 STAINLESS STEEL PIPE CLIP</td> <td>4</td> <td>PZ</td> </tr> <tr> <td>TB1520A0</td> <td>INT. Ø=38 TH=4 DRAIN BLACK RUBBER PIPE</td> <td>2.500</td> <td>M</td> </tr> <tr> <td>VI1220A1</td> <td>4,2X12 TCB SELF-TAPPIN G SCREW</td> <td>2</td> <td>PZ</td> </tr> <tr> <td>VI1895A0</td> <td>BLIND NUT M4 STAINLESS STEEL DIN 917</td> <td>4</td> <td>PZ</td> </tr> <tr> <td>VI1945A0</td> <td>ENG-VITE M4X20 TCB+ INOX</td> <td>4</td> <td>PZ</td> </tr> <tr> <td>VI1950A0</td> <td>ST. STEEL 4,2X13 TCB SELF-DRILLIN G SCREW</td> <td>2</td> <td>PZ</td> </tr> <tr> <td>VL1005A1</td> <td>U-TRAP TANK</td> <td>1</td> <td>PZ</td> </tr> <tr> <td>VL1006A0</td> <td>SYPHON COVER</td> <td>1</td> <td>PZ</td> </tr> <tr> <td>VM1015A1</td> <td>STAINLESS STEEL Ø30X1.5 90° BEND</td> <td>1</td> <td>PZ</td> </tr> </tbody> </table>	Code	Description	Qty	UOM	0H1237A0	LM TOP SIPHON SUPPORT	1	PZ	GN1508A0	O-RING GASKET COD 2400	1	PZ	RC1055A0	Ø25-40 H12 STAINLESS STEEL PIPE CLIP	4	PZ	TB1520A0	INT. Ø=38 TH=4 DRAIN BLACK RUBBER PIPE	2.500	M	VI1220A1	4,2X12 TCB SELF-TAPPIN G SCREW	2	PZ	VI1895A0	BLIND NUT M4 STAINLESS STEEL DIN 917	4	PZ	VI1945A0	ENG-VITE M4X20 TCB+ INOX	4	PZ	VI1950A0	ST. STEEL 4,2X13 TCB SELF-DRILLIN G SCREW	2	PZ	VL1005A1	U-TRAP TANK	1	PZ	VL1006A0	SYPHON COVER	1	PZ	VM1015A1	STAINLESS STEEL Ø30X1.5 90° BEND	1	PZ
Code	Description	Qty	UOM																																															
0H1237A0	LM TOP SIPHON SUPPORT	1	PZ																																															
GN1508A0	O-RING GASKET COD 2400	1	PZ																																															
RC1055A0	Ø25-40 H12 STAINLESS STEEL PIPE CLIP	4	PZ																																															
TB1520A0	INT. Ø=38 TH=4 DRAIN BLACK RUBBER PIPE	2.500	M																																															
VI1220A1	4,2X12 TCB SELF-TAPPIN G SCREW	2	PZ																																															
VI1895A0	BLIND NUT M4 STAINLESS STEEL DIN 917	4	PZ																																															
VI1945A0	ENG-VITE M4X20 TCB+ INOX	4	PZ																																															
VI1950A0	ST. STEEL 4,2X13 TCB SELF-DRILLIN G SCREW	2	PZ																																															
VL1005A1	U-TRAP TANK	1	PZ																																															
VL1006A0	SYPHON COVER	1	PZ																																															
VM1015A1	STAINLESS STEEL Ø30X1.5 90° BEND	1	PZ																																															

COMPONENT			SPARE PART																																										
Code	Description	Image	Code	Description	Components list																																								
VL1005A	U-TRAP TANK		XC673	COMPLETE P-TRAP KIT	<table border="1"> <thead> <tr> <th>Code</th> <th>Description</th> <th>Qty</th> <th>UOM</th> </tr> </thead> <tbody> <tr> <td>GN1508A0</td> <td>O-RING GASKET COD 2400</td> <td>1</td> <td>PZ</td> </tr> <tr> <td>RC1055A0</td> <td>Ø25-40 H12 STAINLESS STEEL PIPE CLIP</td> <td>2</td> <td>PZ</td> </tr> <tr> <td>TB1520A0</td> <td>INT. Ø=38 TH=4 DRAIN BLACK RUBBER PIPE</td> <td>0.050</td> <td>M</td> </tr> <tr> <td>VI1220A1</td> <td>4,2X12 TCB SELF-TAPPIN G SCREW</td> <td>2</td> <td>PZ</td> </tr> <tr> <td>VI1895A0</td> <td>BLIND NUT M4 STAINLESS STEEL DIN 917</td> <td>4</td> <td>PZ</td> </tr> <tr> <td>VI1945A0</td> <td>ENG-VITE M4X20 TCB+ INOX</td> <td>4</td> <td>PZ</td> </tr> <tr> <td>VI1950A0</td> <td>ST. STEEL 4,2X13 TCB SELF-DRILLIN G SCREW</td> <td>2</td> <td>PZ</td> </tr> <tr> <td>VL1005A1</td> <td>U-TRAP TANK</td> <td>1</td> <td>PZ</td> </tr> <tr> <td>VL1006A0</td> <td>SYPHON COVER</td> <td>1</td> <td>PZ</td> </tr> </tbody> </table>	Code	Description	Qty	UOM	GN1508A0	O-RING GASKET COD 2400	1	PZ	RC1055A0	Ø25-40 H12 STAINLESS STEEL PIPE CLIP	2	PZ	TB1520A0	INT. Ø=38 TH=4 DRAIN BLACK RUBBER PIPE	0.050	M	VI1220A1	4,2X12 TCB SELF-TAPPIN G SCREW	2	PZ	VI1895A0	BLIND NUT M4 STAINLESS STEEL DIN 917	4	PZ	VI1945A0	ENG-VITE M4X20 TCB+ INOX	4	PZ	VI1950A0	ST. STEEL 4,2X13 TCB SELF-DRILLIN G SCREW	2	PZ	VL1005A1	U-TRAP TANK	1	PZ	VL1006A0	SYPHON COVER	1	PZ
			Code	Description	Qty	UOM																																							
GN1508A0	O-RING GASKET COD 2400	1	PZ																																										
RC1055A0	Ø25-40 H12 STAINLESS STEEL PIPE CLIP	2	PZ																																										
TB1520A0	INT. Ø=38 TH=4 DRAIN BLACK RUBBER PIPE	0.050	M																																										
VI1220A1	4,2X12 TCB SELF-TAPPIN G SCREW	2	PZ																																										
VI1895A0	BLIND NUT M4 STAINLESS STEEL DIN 917	4	PZ																																										
VI1945A0	ENG-VITE M4X20 TCB+ INOX	4	PZ																																										
VI1950A0	ST. STEEL 4,2X13 TCB SELF-DRILLIN G SCREW	2	PZ																																										
VL1005A1	U-TRAP TANK	1	PZ																																										
VL1006A0	SYPHON COVER	1	PZ																																										
XC653	LINEMISSTOP XFT140 STACKING KIT	<table border="1"> <thead> <tr> <th>Code</th> <th>Description</th> <th>Qty</th> <th>UOM</th> </tr> </thead> <tbody> <tr> <td>0H1237A0</td> <td>LM TOP SIPHON SUPPORT</td> <td>2</td> <td>PZ</td> </tr> <tr> <td>0H7084A0</td> <td>XC651 FRONT STACKING PROFILE</td> <td>1</td> <td>PZ</td> </tr> <tr> <td>0H7085A0</td> <td>LM 600 XC STACKING KIT BACK PROFIL</td> <td>2</td> <td>PZ</td> </tr> <tr> <td>ED1246A0</td> <td>HOT SURFACE LABEL</td> <td>1</td> <td>PZ</td> </tr> <tr> <td>ED1271A0</td> <td>LIQUID FALLS DANGER LABE</td> <td>1</td> <td>PZ</td> </tr> <tr> <td>EL1020A1</td> <td>D8 INTERMEDIAT E T-SHAPED FITTING</td> <td>2</td> <td>PZ</td> </tr> <tr> <td>EL1180A0</td> <td>Ø8-Ø8 FEMALE NON-RETURN CONNECTION</td> <td>2</td> <td>PZ</td> </tr> <tr> <td>GN1508A0</td> <td>O-RING GASKET COD 2400</td> <td>2</td> <td>PZ</td> </tr> <tr> <td>RC1008A0</td> <td>D9 ELASTIC CLIP</td> <td>7</td> <td>PZ</td> </tr> </tbody> </table>	Code	Description	Qty	UOM	0H1237A0	LM TOP SIPHON SUPPORT	2	PZ	0H7084A0	XC651 FRONT STACKING PROFILE	1	PZ	0H7085A0	LM 600 XC STACKING KIT BACK PROFIL	2	PZ	ED1246A0	HOT SURFACE LABEL	1	PZ	ED1271A0	LIQUID FALLS DANGER LABE	1	PZ	EL1020A1	D8 INTERMEDIAT E T-SHAPED FITTING	2	PZ	EL1180A0	Ø8-Ø8 FEMALE NON-RETURN CONNECTION	2	PZ	GN1508A0	O-RING GASKET COD 2400	2	PZ	RC1008A0	D9 ELASTIC CLIP	7	PZ			
Code	Description	Qty	UOM																																										
0H1237A0	LM TOP SIPHON SUPPORT	2	PZ																																										
0H7084A0	XC651 FRONT STACKING PROFILE	1	PZ																																										
0H7085A0	LM 600 XC STACKING KIT BACK PROFIL	2	PZ																																										
ED1246A0	HOT SURFACE LABEL	1	PZ																																										
ED1271A0	LIQUID FALLS DANGER LABE	1	PZ																																										
EL1020A1	D8 INTERMEDIAT E T-SHAPED FITTING	2	PZ																																										
EL1180A0	Ø8-Ø8 FEMALE NON-RETURN CONNECTION	2	PZ																																										
GN1508A0	O-RING GASKET COD 2400	2	PZ																																										
RC1008A0	D9 ELASTIC CLIP	7	PZ																																										



COMPONENT			SPARE PART																																																																																		
Code	Description	Image	Code	Description	Components list																																																																																
VL1005A	U-TRAP TANK		XC653	LINEMISSTOP XFT140 STACKING KIT	<table border="1"> <thead> <tr> <th>Code</th> <th>Description</th> <th>Qty</th> <th>UOM</th> </tr> </thead> <tbody> <tr> <td>RC1055A0</td> <td>Ø25-40 H12 STAINLESS STEEL PIPE CLIP</td> <td>10</td> <td>PZ</td> </tr> <tr> <td>RC1297A1</td> <td>D10 T-SHAPED FITTING</td> <td>1</td> <td>PZ</td> </tr> <tr> <td>RC1360A0</td> <td>10 - 10 JG ELBOW FITTING</td> <td>1</td> <td>PZ</td> </tr> <tr> <td>RC1376A0</td> <td>Ø6 Y-FITTING</td> <td>1</td> <td>PZ</td> </tr> <tr> <td>TB1177A0</td> <td>FOOT PANEL 40X40 H58 OVERLAP LM</td> <td>4</td> <td>PZ</td> </tr> <tr> <td>TB1520A0</td> <td>INT. Ø=38 TH=4 DRAIN BLACK RUBBER PIPE</td> <td>2.700</td> <td>M</td> </tr> <tr> <td>TB1815A0</td> <td>7,93X4,75 PE TRANSP. PIPE (JG #PE08100N)</td> <td>2</td> <td>M</td> </tr> <tr> <td>TB2243A0</td> <td>Ø10 PET PIPE</td> <td>1.500</td> <td>M</td> </tr> <tr> <td>VI1220A1</td> <td>4,2X12 TCB SELF-TAPPING G SCREW</td> <td>16</td> <td>PZ</td> </tr> <tr> <td>VI1895A0</td> <td>BLIND NUT M4 STAINLESS STEEL DIN 917</td> <td>8</td> <td>PZ</td> </tr> <tr> <td>VI1945A0</td> <td>ENG-VITE M4X20 TCB+ INOX</td> <td>8</td> <td>PZ</td> </tr> <tr> <td>VI1950A0</td> <td>ST. STEEL 4,2X13 TCB SELF-DRILLING G SCREW</td> <td>10</td> <td>PZ</td> </tr> <tr> <td>VL1005A1</td> <td>U-TRAP TANK</td> <td>2</td> <td>PZ</td> </tr> <tr> <td>VL1006A0</td> <td>SYPHON COVER</td> <td>2</td> <td>PZ</td> </tr> <tr> <td>VL1046A1</td> <td>D6 PIPE HOLDER - D6 J.G. TERMINAL</td> <td>6</td> <td>PZ</td> </tr> <tr> <td>VL1047A1</td> <td>D6 PIPE HOLDER - D8 J.G. TERMINAL</td> <td>2</td> <td>PZ</td> </tr> <tr> <td>VM1015A1</td> <td>STAINLESS STEEL Ø30X1.5 90° BEND</td> <td>1</td> <td>PZ</td> </tr> <tr> <td>VM1794A0</td> <td>250X4.8 PA66 BLACK CLAMP</td> <td>2</td> <td>PZ</td> </tr> <tr> <td>VM2035A0</td> <td>DRAIN PIPE SUPPORT</td> <td>1</td> <td>PZ</td> </tr> </tbody> </table>	Code	Description	Qty	UOM	RC1055A0	Ø25-40 H12 STAINLESS STEEL PIPE CLIP	10	PZ	RC1297A1	D10 T-SHAPED FITTING	1	PZ	RC1360A0	10 - 10 JG ELBOW FITTING	1	PZ	RC1376A0	Ø6 Y-FITTING	1	PZ	TB1177A0	FOOT PANEL 40X40 H58 OVERLAP LM	4	PZ	TB1520A0	INT. Ø=38 TH=4 DRAIN BLACK RUBBER PIPE	2.700	M	TB1815A0	7,93X4,75 PE TRANSP. PIPE (JG #PE08100N)	2	M	TB2243A0	Ø10 PET PIPE	1.500	M	VI1220A1	4,2X12 TCB SELF-TAPPING G SCREW	16	PZ	VI1895A0	BLIND NUT M4 STAINLESS STEEL DIN 917	8	PZ	VI1945A0	ENG-VITE M4X20 TCB+ INOX	8	PZ	VI1950A0	ST. STEEL 4,2X13 TCB SELF-DRILLING G SCREW	10	PZ	VL1005A1	U-TRAP TANK	2	PZ	VL1006A0	SYPHON COVER	2	PZ	VL1046A1	D6 PIPE HOLDER - D6 J.G. TERMINAL	6	PZ	VL1047A1	D6 PIPE HOLDER - D8 J.G. TERMINAL	2	PZ	VM1015A1	STAINLESS STEEL Ø30X1.5 90° BEND	1	PZ	VM1794A0	250X4.8 PA66 BLACK CLAMP	2	PZ	VM2035A0	DRAIN PIPE SUPPORT	1	PZ
Code	Description	Qty	UOM																																																																																		
RC1055A0	Ø25-40 H12 STAINLESS STEEL PIPE CLIP	10	PZ																																																																																		
RC1297A1	D10 T-SHAPED FITTING	1	PZ																																																																																		
RC1360A0	10 - 10 JG ELBOW FITTING	1	PZ																																																																																		
RC1376A0	Ø6 Y-FITTING	1	PZ																																																																																		
TB1177A0	FOOT PANEL 40X40 H58 OVERLAP LM	4	PZ																																																																																		
TB1520A0	INT. Ø=38 TH=4 DRAIN BLACK RUBBER PIPE	2.700	M																																																																																		
TB1815A0	7,93X4,75 PE TRANSP. PIPE (JG #PE08100N)	2	M																																																																																		
TB2243A0	Ø10 PET PIPE	1.500	M																																																																																		
VI1220A1	4,2X12 TCB SELF-TAPPING G SCREW	16	PZ																																																																																		
VI1895A0	BLIND NUT M4 STAINLESS STEEL DIN 917	8	PZ																																																																																		
VI1945A0	ENG-VITE M4X20 TCB+ INOX	8	PZ																																																																																		
VI1950A0	ST. STEEL 4,2X13 TCB SELF-DRILLING G SCREW	10	PZ																																																																																		
VL1005A1	U-TRAP TANK	2	PZ																																																																																		
VL1006A0	SYPHON COVER	2	PZ																																																																																		
VL1046A1	D6 PIPE HOLDER - D6 J.G. TERMINAL	6	PZ																																																																																		
VL1047A1	D6 PIPE HOLDER - D8 J.G. TERMINAL	2	PZ																																																																																		
VM1015A1	STAINLESS STEEL Ø30X1.5 90° BEND	1	PZ																																																																																		
VM1794A0	250X4.8 PA66 BLACK CLAMP	2	PZ																																																																																		
VM2035A0	DRAIN PIPE SUPPORT	1	PZ																																																																																		

COMPONENT			SPARE PART																																																																																		
Code	Description	Image	Code	Description	Components list																																																																																
VL1005A	U-TRAP TANK		XC649	LINEMISS TOP FULL SIZE STACKING KIT	<table border="1"> <thead> <tr> <th>Code</th> <th>Description</th> <th>Qty</th> <th>UOM</th> </tr> </thead> <tbody> <tr> <td>0H1151A0</td> <td>PROOFER-OV EN FIXING BRACKET</td> <td>4</td> <td>PZ</td> </tr> <tr> <td>0H1237A0</td> <td>LM TOP SIPHON SUPPORT</td> <td>2</td> <td>PZ</td> </tr> <tr> <td>ED1335A0</td> <td>CAUTION HOT TRIANGLE LABEL</td> <td>1</td> <td>PZ</td> </tr> <tr> <td>ED1338A0</td> <td>UL LIQUID FALLS DANGER LABE</td> <td>1</td> <td>PZ</td> </tr> <tr> <td>EL1020A1</td> <td>D8 INTERMEDIAT E T-SHAPED FITTING</td> <td>2</td> <td>PZ</td> </tr> <tr> <td>EL1185A0</td> <td>Ø8F - Ø8F ELBOW CONNECTION</td> <td>2</td> <td>PZ</td> </tr> <tr> <td>GN1508A0</td> <td>O-RING GASKET COD 2400</td> <td>2</td> <td>PZ</td> </tr> <tr> <td>RC1008A0</td> <td>D9 ELASTIC CLIP</td> <td>3</td> <td>PZ</td> </tr> <tr> <td>RC1055A0</td> <td>Ø25-40 H12 STAINLESS STEEL PIPE CLIP</td> <td>8</td> <td>PZ</td> </tr> <tr> <td>RC1297A1</td> <td>D10 T-SHAPED FITTING</td> <td>1</td> <td>PZ</td> </tr> <tr> <td>RC1360A0</td> <td>10 - 10 JG ELBOW FITTIN</td> <td>1</td> <td>PZ</td> </tr> <tr> <td>RC1376A0</td> <td>Ø6 Y-FITTING</td> <td>1</td> <td>PZ</td> </tr> <tr> <td>TB1520A0</td> <td>INT. Ø=38 TH=4 DRAIN BLACK RUBBER PIPE</td> <td>2.840</td> <td>M</td> </tr> <tr> <td>TB1815A0</td> <td>7,93X4,75 PE TRANSP. PIPE (JG #PE08100N)</td> <td>2</td> <td>M</td> </tr> <tr> <td>TB2243A0</td> <td>Ø10 PET PIPE</td> <td>1.500</td> <td>M</td> </tr> <tr> <td>VI1220A1</td> <td>4,2X12 TCB SELF-TAPPIN G SCREW</td> <td>7</td> <td>PZ</td> </tr> <tr> <td>VI1895A0</td> <td>BLIND NUT M4 STAINLESS STEEL DIN 917</td> <td>8</td> <td>PZ</td> </tr> <tr> <td>VI1945A0</td> <td>ENG-VITE M4X20 TCB+ INOX</td> <td>8</td> <td>PZ</td> </tr> <tr> <td>VI1950A0</td> <td>ST. STEEL 4,2X13 TCB SELF-DRILLIN G SCREW</td> <td>6</td> <td>PZ</td> </tr> </tbody> </table>	Code	Description	Qty	UOM	0H1151A0	PROOFER-OV EN FIXING BRACKET	4	PZ	0H1237A0	LM TOP SIPHON SUPPORT	2	PZ	ED1335A0	CAUTION HOT TRIANGLE LABEL	1	PZ	ED1338A0	UL LIQUID FALLS DANGER LABE	1	PZ	EL1020A1	D8 INTERMEDIAT E T-SHAPED FITTING	2	PZ	EL1185A0	Ø8F - Ø8F ELBOW CONNECTION	2	PZ	GN1508A0	O-RING GASKET COD 2400	2	PZ	RC1008A0	D9 ELASTIC CLIP	3	PZ	RC1055A0	Ø25-40 H12 STAINLESS STEEL PIPE CLIP	8	PZ	RC1297A1	D10 T-SHAPED FITTING	1	PZ	RC1360A0	10 - 10 JG ELBOW FITTIN	1	PZ	RC1376A0	Ø6 Y-FITTING	1	PZ	TB1520A0	INT. Ø=38 TH=4 DRAIN BLACK RUBBER PIPE	2.840	M	TB1815A0	7,93X4,75 PE TRANSP. PIPE (JG #PE08100N)	2	M	TB2243A0	Ø10 PET PIPE	1.500	M	VI1220A1	4,2X12 TCB SELF-TAPPIN G SCREW	7	PZ	VI1895A0	BLIND NUT M4 STAINLESS STEEL DIN 917	8	PZ	VI1945A0	ENG-VITE M4X20 TCB+ INOX	8	PZ	VI1950A0	ST. STEEL 4,2X13 TCB SELF-DRILLIN G SCREW	6	PZ
Code	Description	Qty	UOM																																																																																		
0H1151A0	PROOFER-OV EN FIXING BRACKET	4	PZ																																																																																		
0H1237A0	LM TOP SIPHON SUPPORT	2	PZ																																																																																		
ED1335A0	CAUTION HOT TRIANGLE LABEL	1	PZ																																																																																		
ED1338A0	UL LIQUID FALLS DANGER LABE	1	PZ																																																																																		
EL1020A1	D8 INTERMEDIAT E T-SHAPED FITTING	2	PZ																																																																																		
EL1185A0	Ø8F - Ø8F ELBOW CONNECTION	2	PZ																																																																																		
GN1508A0	O-RING GASKET COD 2400	2	PZ																																																																																		
RC1008A0	D9 ELASTIC CLIP	3	PZ																																																																																		
RC1055A0	Ø25-40 H12 STAINLESS STEEL PIPE CLIP	8	PZ																																																																																		
RC1297A1	D10 T-SHAPED FITTING	1	PZ																																																																																		
RC1360A0	10 - 10 JG ELBOW FITTIN	1	PZ																																																																																		
RC1376A0	Ø6 Y-FITTING	1	PZ																																																																																		
TB1520A0	INT. Ø=38 TH=4 DRAIN BLACK RUBBER PIPE	2.840	M																																																																																		
TB1815A0	7,93X4,75 PE TRANSP. PIPE (JG #PE08100N)	2	M																																																																																		
TB2243A0	Ø10 PET PIPE	1.500	M																																																																																		
VI1220A1	4,2X12 TCB SELF-TAPPIN G SCREW	7	PZ																																																																																		
VI1895A0	BLIND NUT M4 STAINLESS STEEL DIN 917	8	PZ																																																																																		
VI1945A0	ENG-VITE M4X20 TCB+ INOX	8	PZ																																																																																		
VI1950A0	ST. STEEL 4,2X13 TCB SELF-DRILLIN G SCREW	6	PZ																																																																																		



COMPONENT			SPARE PART																																																															
Code	Description	Image	Code	Description	Components list																																																													
VL1005A	U-TRAP TANK		XC649	LINEMISS TOP FULL SIZE STACKING KIT	<table border="1"> <thead> <tr> <th>Code</th> <th>Description</th> <th>Qty</th> <th>UOM</th> </tr> </thead> <tbody> <tr> <td>VL1005A1</td> <td>U-TRAP TANK</td> <td>2</td> <td>PZ</td> </tr> <tr> <td>VL1006A0</td> <td>SYPHON COVER</td> <td>2</td> <td>PZ</td> </tr> <tr> <td>VL1046A1</td> <td>D6 PIPE HOLDER - D6 J.G. TERMINAL</td> <td>3</td> <td>PZ</td> </tr> <tr> <td>VM1794A0</td> <td>250X4.8 PA66 BLACK CLAMP</td> <td>2</td> <td>PZ</td> </tr> <tr> <td>VM2035A0</td> <td>DRAIN PIPE SUPPORT</td> <td>1</td> <td>PZ</td> </tr> </tbody> </table>	Code	Description	Qty	UOM	VL1005A1	U-TRAP TANK	2	PZ	VL1006A0	SYPHON COVER	2	PZ	VL1046A1	D6 PIPE HOLDER - D6 J.G. TERMINAL	3	PZ	VM1794A0	250X4.8 PA66 BLACK CLAMP	2	PZ	VM2035A0	DRAIN PIPE SUPPORT	1	PZ																																					
			Code	Description	Qty	UOM																																																												
VL1005A1	U-TRAP TANK	2	PZ																																																															
VL1006A0	SYPHON COVER	2	PZ																																																															
VL1046A1	D6 PIPE HOLDER - D6 J.G. TERMINAL	3	PZ																																																															
VM1794A0	250X4.8 PA66 BLACK CLAMP	2	PZ																																																															
VM2035A0	DRAIN PIPE SUPPORT	1	PZ																																																															
XC648	LINEMISS TOP XFT200 STACKING KIT	<table border="1"> <thead> <tr> <th>Code</th> <th>Description</th> <th>Qty</th> <th>UOM</th> </tr> </thead> <tbody> <tr> <td>0H1237A0</td> <td>LM TOP SIPHON SUPPORT</td> <td>2</td> <td>PZ</td> </tr> <tr> <td>0H7082A0</td> <td>LM 800 XC STACKING KIT FRONT PROFILE</td> <td>1</td> <td>PZ</td> </tr> <tr> <td>0H7083A0</td> <td>LM 800 XC STACKING KIT BACK PROFIL</td> <td>2</td> <td>PZ</td> </tr> <tr> <td>ED1246A0</td> <td>HOT SURFACE LABEL</td> <td>1</td> <td>PZ</td> </tr> <tr> <td>ED1271A0</td> <td>LIQUID FALLS DANGER LABE</td> <td>1</td> <td>PZ</td> </tr> <tr> <td>EL1020A1</td> <td>D8 INTERMEDIAT E T-SHAPED FITTING</td> <td>2</td> <td>PZ</td> </tr> <tr> <td>EL1180A0</td> <td>Ø8-Ø8 FEMALE NON-RETURN CONNECTION</td> <td>2</td> <td>PZ</td> </tr> <tr> <td>GN1508A0</td> <td>O-RING GASKET COD 2400</td> <td>2</td> <td>PZ</td> </tr> <tr> <td>RC1008A0</td> <td>D9 ELASTIC CLIP</td> <td>7</td> <td>PZ</td> </tr> <tr> <td>RC1055A0</td> <td>Ø25-40 H12 STAINLESS STEEL PIPE CLIP</td> <td>10</td> <td>PZ</td> </tr> <tr> <td>RC1297A1</td> <td>D10 T-SHAPED FITTING</td> <td>1</td> <td>PZ</td> </tr> <tr> <td>RC1360A0</td> <td>10 - 10 JG ELBOW FITTIN</td> <td>1</td> <td>PZ</td> </tr> <tr> <td>RC1376A0</td> <td>Ø6 Y-FITTING</td> <td>1</td> <td>PZ</td> </tr> <tr> <td>TB1177A0</td> <td>FOOT PANEL 40X40 H58 OVERLAP LM</td> <td>4</td> <td>PZ</td> </tr> <tr> <td>TB1520A0</td> <td>INT. Ø=38 TH=4 DRAIN BLACK RUBBER PIPE</td> <td>2.700</td> <td>M</td> </tr> </tbody> </table>	Code	Description	Qty	UOM	0H1237A0	LM TOP SIPHON SUPPORT	2	PZ	0H7082A0	LM 800 XC STACKING KIT FRONT PROFILE	1	PZ	0H7083A0	LM 800 XC STACKING KIT BACK PROFIL	2	PZ	ED1246A0	HOT SURFACE LABEL	1	PZ	ED1271A0	LIQUID FALLS DANGER LABE	1	PZ	EL1020A1	D8 INTERMEDIAT E T-SHAPED FITTING	2	PZ	EL1180A0	Ø8-Ø8 FEMALE NON-RETURN CONNECTION	2	PZ	GN1508A0	O-RING GASKET COD 2400	2	PZ	RC1008A0	D9 ELASTIC CLIP	7	PZ	RC1055A0	Ø25-40 H12 STAINLESS STEEL PIPE CLIP	10	PZ	RC1297A1	D10 T-SHAPED FITTING	1	PZ	RC1360A0	10 - 10 JG ELBOW FITTIN	1	PZ	RC1376A0	Ø6 Y-FITTING	1	PZ	TB1177A0	FOOT PANEL 40X40 H58 OVERLAP LM	4	PZ	TB1520A0	INT. Ø=38 TH=4 DRAIN BLACK RUBBER PIPE	2.700	M
Code	Description	Qty	UOM																																																															
0H1237A0	LM TOP SIPHON SUPPORT	2	PZ																																																															
0H7082A0	LM 800 XC STACKING KIT FRONT PROFILE	1	PZ																																																															
0H7083A0	LM 800 XC STACKING KIT BACK PROFIL	2	PZ																																																															
ED1246A0	HOT SURFACE LABEL	1	PZ																																																															
ED1271A0	LIQUID FALLS DANGER LABE	1	PZ																																																															
EL1020A1	D8 INTERMEDIAT E T-SHAPED FITTING	2	PZ																																																															
EL1180A0	Ø8-Ø8 FEMALE NON-RETURN CONNECTION	2	PZ																																																															
GN1508A0	O-RING GASKET COD 2400	2	PZ																																																															
RC1008A0	D9 ELASTIC CLIP	7	PZ																																																															
RC1055A0	Ø25-40 H12 STAINLESS STEEL PIPE CLIP	10	PZ																																																															
RC1297A1	D10 T-SHAPED FITTING	1	PZ																																																															
RC1360A0	10 - 10 JG ELBOW FITTIN	1	PZ																																																															
RC1376A0	Ø6 Y-FITTING	1	PZ																																																															
TB1177A0	FOOT PANEL 40X40 H58 OVERLAP LM	4	PZ																																																															
TB1520A0	INT. Ø=38 TH=4 DRAIN BLACK RUBBER PIPE	2.700	M																																																															





COMPONENT			SPARE PART																																																																																					
Code	Description	Image	Code	Description	Components list																																																																																			
VL1005A	U-TRAP TANK		XC648	LINEMISS TOP XFT200 STACKING KIT	<table border="1"> <thead> <tr> <th>Code</th> <th>Description</th> <th>Qty</th> <th>UOM</th> </tr> </thead> <tbody> <tr> <td>TB1815A0</td> <td>7,93X4,75 PE TRANSP. PIPE (JG #PE08100N)</td> <td>2</td> <td>M</td> </tr> <tr> <td>TB2243A0</td> <td>Ø10 PET PIPE</td> <td>1.500</td> <td>M</td> </tr> <tr> <td>VI1220A1</td> <td>4,2X12 TCB SELF-TAPPIN G SCREW</td> <td>16</td> <td>PZ</td> </tr> <tr> <td>VI1895A0</td> <td>BLIND NUT M4 STAINLESS STEEL DIN 917</td> <td>8</td> <td>PZ</td> </tr> <tr> <td>VI1945A0</td> <td>ENG-VITE M4X20 TCB+ INOX</td> <td>8</td> <td>PZ</td> </tr> <tr> <td>VI1950A0</td> <td>ST. STEEL 4,2X13 TCB SELF-DRILLIN G SCREW</td> <td>10</td> <td>PZ</td> </tr> <tr> <td>VL1005A1</td> <td>U-TRAP TANK</td> <td>2</td> <td>PZ</td> </tr> <tr> <td>VL1006A0</td> <td>SYPHON COVER</td> <td>2</td> <td>PZ</td> </tr> <tr> <td>VL1046A1</td> <td>D6 PIPE HOLDER - D6 J.G. TERMINAL</td> <td>6</td> <td>PZ</td> </tr> <tr> <td>VL1047A1</td> <td>D6 PIPE HOLDER - D8 J.G. TERMINAL</td> <td>4</td> <td>PZ</td> </tr> <tr> <td>VM1015A1</td> <td>STAINLESS STEEL Ø30X1,5 90° BEND</td> <td>1</td> <td>PZ</td> </tr> <tr> <td>VM1794A0</td> <td>250X4.8 PA66 BLACK CLAMP</td> <td>2</td> <td>PZ</td> </tr> <tr> <td>VM2035A0</td> <td>DRAIN PIPE SUPPORT</td> <td>1</td> <td>PZ</td> </tr> </tbody> </table>	Code	Description	Qty	UOM	TB1815A0	7,93X4,75 PE TRANSP. PIPE (JG #PE08100N)	2	M	TB2243A0	Ø10 PET PIPE	1.500	M	VI1220A1	4,2X12 TCB SELF-TAPPIN G SCREW	16	PZ	VI1895A0	BLIND NUT M4 STAINLESS STEEL DIN 917	8	PZ	VI1945A0	ENG-VITE M4X20 TCB+ INOX	8	PZ	VI1950A0	ST. STEEL 4,2X13 TCB SELF-DRILLIN G SCREW	10	PZ	VL1005A1	U-TRAP TANK	2	PZ	VL1006A0	SYPHON COVER	2	PZ	VL1046A1	D6 PIPE HOLDER - D6 J.G. TERMINAL	6	PZ	VL1047A1	D6 PIPE HOLDER - D8 J.G. TERMINAL	4	PZ	VM1015A1	STAINLESS STEEL Ø30X1,5 90° BEND	1	PZ	VM1794A0	250X4.8 PA66 BLACK CLAMP	2	PZ	VM2035A0	DRAIN PIPE SUPPORT	1	PZ	KVL1005A	5 /5E SERIES U-TRAP KIT	<table border="1"> <thead> <tr> <th>Code</th> <th>Description</th> <th>Qty</th> <th>UOM</th> </tr> </thead> <tbody> <tr> <td>GN1508A0</td> <td>O-RING GASKET COD 2400</td> <td>1</td> <td>PZ</td> </tr> <tr> <td>VI1895A0</td> <td>BLIND NUT M4 STAINLESS STEEL DIN 917</td> <td>4</td> <td>PZ</td> </tr> <tr> <td>VI1945A0</td> <td>ENG-VITE M4X20 TCB+ INOX</td> <td>4</td> <td>PZ</td> </tr> <tr> <td>VL1005A1</td> <td>U-TRAP TANK</td> <td>1</td> <td>PZ</td> </tr> <tr> <td>VL1006A0</td> <td>SYPHON COVER</td> <td>1</td> <td>PZ</td> </tr> </tbody> </table>	Code	Description	Qty	UOM	GN1508A0	O-RING GASKET COD 2400	1	PZ	VI1895A0	BLIND NUT M4 STAINLESS STEEL DIN 917	4	PZ	VI1945A0	ENG-VITE M4X20 TCB+ INOX	4	PZ	VL1005A1	U-TRAP TANK	1	PZ	VL1006A0	SYPHON COVER	1	PZ
			Code	Description	Qty	UOM																																																																																		
TB1815A0	7,93X4,75 PE TRANSP. PIPE (JG #PE08100N)	2	M																																																																																					
TB2243A0	Ø10 PET PIPE	1.500	M																																																																																					
VI1220A1	4,2X12 TCB SELF-TAPPIN G SCREW	16	PZ																																																																																					
VI1895A0	BLIND NUT M4 STAINLESS STEEL DIN 917	8	PZ																																																																																					
VI1945A0	ENG-VITE M4X20 TCB+ INOX	8	PZ																																																																																					
VI1950A0	ST. STEEL 4,2X13 TCB SELF-DRILLIN G SCREW	10	PZ																																																																																					
VL1005A1	U-TRAP TANK	2	PZ																																																																																					
VL1006A0	SYPHON COVER	2	PZ																																																																																					
VL1046A1	D6 PIPE HOLDER - D6 J.G. TERMINAL	6	PZ																																																																																					
VL1047A1	D6 PIPE HOLDER - D8 J.G. TERMINAL	4	PZ																																																																																					
VM1015A1	STAINLESS STEEL Ø30X1,5 90° BEND	1	PZ																																																																																					
VM1794A0	250X4.8 PA66 BLACK CLAMP	2	PZ																																																																																					
VM2035A0	DRAIN PIPE SUPPORT	1	PZ																																																																																					
Code	Description	Qty	UOM																																																																																					
GN1508A0	O-RING GASKET COD 2400	1	PZ																																																																																					
VI1895A0	BLIND NUT M4 STAINLESS STEEL DIN 917	4	PZ																																																																																					
VI1945A0	ENG-VITE M4X20 TCB+ INOX	4	PZ																																																																																					
VL1005A1	U-TRAP TANK	1	PZ																																																																																					
VL1006A0	SYPHON COVER	1	PZ																																																																																					

COMPONENT			SPARE PART																																																																																	
Code	Description	Image	Code	Description	Components list																																																																															
VL1006A	SYPHON COVER		XUC001	SINGLE UNIT INSTALLATION KIT	<table border="1"> <thead> <tr> <th>Code</th> <th>Description</th> <th>Qty</th> <th>UOM</th> </tr> </thead> <tbody> <tr> <td>0H6567A0</td> <td>P-TRAP HOLDING PANEL</td> <td>1</td> <td>PZ</td> </tr> <tr> <td>GN1508A0</td> <td>O-RING GASKET COD 2400</td> <td>1</td> <td>PZ</td> </tr> <tr> <td>IL1115A0</td> <td>WOODEN PALET 80X120</td> <td>0.100</td> <td>PZ</td> </tr> <tr> <td>RC1055A0</td> <td>Ø25-40 H12 STAINLESS STEEL PIPE CLIP</td> <td>3</td> <td>PZ</td> </tr> <tr> <td>TB1520A0</td> <td>INT. Ø=38 TH=4 DRAIN BLACK RUBBER PIPE</td> <td>2.500</td> <td>M</td> </tr> <tr> <td>VI1220A1</td> <td>4,2X12 TCB SELF-TAPPIN G SCREW</td> <td>2</td> <td>PZ</td> </tr> <tr> <td>VI1895A0</td> <td>BLIND NUT M4 STAINLESS STEEL DIN 917</td> <td>4</td> <td>PZ</td> </tr> <tr> <td>VI1945A0</td> <td>ENG-VITE M4X20 TCB+ INOX</td> <td>4</td> <td>PZ</td> </tr> <tr> <td>VI1950A0</td> <td>ST. STEEL 4,2X13 TCB SELF-DRILLIN G SCREW</td> <td>2</td> <td>PZ</td> </tr> <tr> <td>VL1005A1</td> <td>U-TRAP TANK</td> <td>1</td> <td>PZ</td> </tr> <tr> <td>VL1006A0</td> <td>SYPHON COVER</td> <td>1</td> <td>PZ</td> </tr> <tr> <td>VM1015A1</td> <td>STAINLESS STEEL Ø30X1.5 90° BEND</td> <td>1</td> <td>PZ</td> </tr> </tbody> </table>	Code	Description	Qty	UOM	0H6567A0	P-TRAP HOLDING PANEL	1	PZ	GN1508A0	O-RING GASKET COD 2400	1	PZ	IL1115A0	WOODEN PALET 80X120	0.100	PZ	RC1055A0	Ø25-40 H12 STAINLESS STEEL PIPE CLIP	3	PZ	TB1520A0	INT. Ø=38 TH=4 DRAIN BLACK RUBBER PIPE	2.500	M	VI1220A1	4,2X12 TCB SELF-TAPPIN G SCREW	2	PZ	VI1895A0	BLIND NUT M4 STAINLESS STEEL DIN 917	4	PZ	VI1945A0	ENG-VITE M4X20 TCB+ INOX	4	PZ	VI1950A0	ST. STEEL 4,2X13 TCB SELF-DRILLIN G SCREW	2	PZ	VL1005A1	U-TRAP TANK	1	PZ	VL1006A0	SYPHON COVER	1	PZ	VM1015A1	STAINLESS STEEL Ø30X1.5 90° BEND	1	PZ	XC761	3 OVENS LM TOP XFT200 STACKING KIT	<table border="1"> <thead> <tr> <th>Code</th> <th>Description</th> <th>Qty</th> <th>UOM</th> </tr> </thead> <tbody> <tr> <td>0H1237A0</td> <td>LM TOP SIPHON SUPPORT</td> <td>3</td> <td>PZ</td> </tr> <tr> <td>0H7082A0</td> <td>LM 800 XC STACKING KIT FRONT PROFILE</td> <td>2</td> <td>PZ</td> </tr> <tr> <td>0H7083A0</td> <td>LM 800 XC STACKING KIT BACK PROFIL</td> <td>4</td> <td>PZ</td> </tr> <tr> <td>ED1246A0</td> <td>HOT SURFACE LABEL</td> <td>1</td> <td>PZ</td> </tr> <tr> <td>ED1271A0</td> <td>LIQUID FALLS DANGER LABE</td> <td>1</td> <td>PZ</td> </tr> </tbody> </table>	Code	Description	Qty	UOM	0H1237A0	LM TOP SIPHON SUPPORT	3	PZ	0H7082A0	LM 800 XC STACKING KIT FRONT PROFILE	2	PZ	0H7083A0	LM 800 XC STACKING KIT BACK PROFIL	4	PZ	ED1246A0	HOT SURFACE LABEL	1	PZ	ED1271A0	LIQUID FALLS DANGER LABE	1	PZ
			Code	Description	Qty	UOM																																																																														
0H6567A0	P-TRAP HOLDING PANEL	1	PZ																																																																																	
GN1508A0	O-RING GASKET COD 2400	1	PZ																																																																																	
IL1115A0	WOODEN PALET 80X120	0.100	PZ																																																																																	
RC1055A0	Ø25-40 H12 STAINLESS STEEL PIPE CLIP	3	PZ																																																																																	
TB1520A0	INT. Ø=38 TH=4 DRAIN BLACK RUBBER PIPE	2.500	M																																																																																	
VI1220A1	4,2X12 TCB SELF-TAPPIN G SCREW	2	PZ																																																																																	
VI1895A0	BLIND NUT M4 STAINLESS STEEL DIN 917	4	PZ																																																																																	
VI1945A0	ENG-VITE M4X20 TCB+ INOX	4	PZ																																																																																	
VI1950A0	ST. STEEL 4,2X13 TCB SELF-DRILLIN G SCREW	2	PZ																																																																																	
VL1005A1	U-TRAP TANK	1	PZ																																																																																	
VL1006A0	SYPHON COVER	1	PZ																																																																																	
VM1015A1	STAINLESS STEEL Ø30X1.5 90° BEND	1	PZ																																																																																	
Code	Description	Qty	UOM																																																																																	
0H1237A0	LM TOP SIPHON SUPPORT	3	PZ																																																																																	
0H7082A0	LM 800 XC STACKING KIT FRONT PROFILE	2	PZ																																																																																	
0H7083A0	LM 800 XC STACKING KIT BACK PROFIL	4	PZ																																																																																	
ED1246A0	HOT SURFACE LABEL	1	PZ																																																																																	
ED1271A0	LIQUID FALLS DANGER LABE	1	PZ																																																																																	





COMPONENT			SPARE PART																																																																																		
Code	Description	Image	Code	Description	Components list																																																																																
VL1006A	SYPHON COVER		XC761	3 OVENS LM TOP XFT200 STACKING KIT	<table border="1"> <thead> <tr> <th>Code</th> <th>Description</th> <th>Qty</th> <th>UOM</th> </tr> </thead> <tbody> <tr> <td>EL1020A1</td> <td>D8 INTERMEDIAT E T-SHAPED FITTING</td> <td>4</td> <td>PZ</td> </tr> <tr> <td>EL1180A0</td> <td>Ø8-Ø8 FEMALE NON-RETURN CONNECTION</td> <td>3</td> <td>PZ</td> </tr> <tr> <td>GN1508A0</td> <td>O-RING GASKET COD 2400</td> <td>3</td> <td>PZ</td> </tr> <tr> <td>RC1008A0</td> <td>D9 ELASTIC CLIP</td> <td>12</td> <td>PZ</td> </tr> <tr> <td>RC1055A0</td> <td>Ø25-40 H12 STAINLESS STEEL PIPE CLIP</td> <td>15</td> <td>PZ</td> </tr> <tr> <td>RC1297A1</td> <td>D10 T-SHAPED FITTING</td> <td>2</td> <td>PZ</td> </tr> <tr> <td>RC1360A0</td> <td>10 - 10 JG ELBOW FITTIN</td> <td>1</td> <td>PZ</td> </tr> <tr> <td>RC1376A0</td> <td>Ø6 Y-FITTING</td> <td>2</td> <td>PZ</td> </tr> <tr> <td>TB1177A0</td> <td>FOOT PANEL 40X40 H58 OVERLAP LM</td> <td>8</td> <td>PZ</td> </tr> <tr> <td>TB1520A0</td> <td>INT. Ø=38 TH=4 DRAIN BLACK RUBBER PIPE</td> <td>5</td> <td>M</td> </tr> <tr> <td>TB1815A0</td> <td>7,93X4,75 PE TRANSP. PIPE (JG #PE08100N)</td> <td>12</td> <td>M</td> </tr> <tr> <td>TB1816A0</td> <td>CLEAR POLYPROPYL ENE PIPE 6X4MM</td> <td>3</td> <td>M</td> </tr> <tr> <td>TB2243A0</td> <td>Ø10 PET PIPE</td> <td>4</td> <td>M</td> </tr> <tr> <td>VI1220A1</td> <td>4,2X12 TCB SELF-TAPPIN G SCREW</td> <td>30</td> <td>PZ</td> </tr> <tr> <td>VI1895A0</td> <td>BLIND NUT M4 STAINLESS STEEL DIN 917</td> <td>12</td> <td>PZ</td> </tr> <tr> <td>VI1945A0</td> <td>ENG-VITE M4X20 TCB+ INOX</td> <td>12</td> <td>PZ</td> </tr> <tr> <td>VI1950A0</td> <td>ST. STEEL 4,2X13 TCB SELF-DRILLIN G SCREW</td> <td>20</td> <td>PZ</td> </tr> <tr> <td>VL1005A1</td> <td>U-TRAP TANK</td> <td>3</td> <td>PZ</td> </tr> <tr> <td>VL1006A0</td> <td>SYPHON COVER</td> <td>3</td> <td>PZ</td> </tr> </tbody> </table>	Code	Description	Qty	UOM	EL1020A1	D8 INTERMEDIAT E T-SHAPED FITTING	4	PZ	EL1180A0	Ø8-Ø8 FEMALE NON-RETURN CONNECTION	3	PZ	GN1508A0	O-RING GASKET COD 2400	3	PZ	RC1008A0	D9 ELASTIC CLIP	12	PZ	RC1055A0	Ø25-40 H12 STAINLESS STEEL PIPE CLIP	15	PZ	RC1297A1	D10 T-SHAPED FITTING	2	PZ	RC1360A0	10 - 10 JG ELBOW FITTIN	1	PZ	RC1376A0	Ø6 Y-FITTING	2	PZ	TB1177A0	FOOT PANEL 40X40 H58 OVERLAP LM	8	PZ	TB1520A0	INT. Ø=38 TH=4 DRAIN BLACK RUBBER PIPE	5	M	TB1815A0	7,93X4,75 PE TRANSP. PIPE (JG #PE08100N)	12	M	TB1816A0	CLEAR POLYPROPYL ENE PIPE 6X4MM	3	M	TB2243A0	Ø10 PET PIPE	4	M	VI1220A1	4,2X12 TCB SELF-TAPPIN G SCREW	30	PZ	VI1895A0	BLIND NUT M4 STAINLESS STEEL DIN 917	12	PZ	VI1945A0	ENG-VITE M4X20 TCB+ INOX	12	PZ	VI1950A0	ST. STEEL 4,2X13 TCB SELF-DRILLIN G SCREW	20	PZ	VL1005A1	U-TRAP TANK	3	PZ	VL1006A0	SYPHON COVER	3	PZ
Code	Description	Qty	UOM																																																																																		
EL1020A1	D8 INTERMEDIAT E T-SHAPED FITTING	4	PZ																																																																																		
EL1180A0	Ø8-Ø8 FEMALE NON-RETURN CONNECTION	3	PZ																																																																																		
GN1508A0	O-RING GASKET COD 2400	3	PZ																																																																																		
RC1008A0	D9 ELASTIC CLIP	12	PZ																																																																																		
RC1055A0	Ø25-40 H12 STAINLESS STEEL PIPE CLIP	15	PZ																																																																																		
RC1297A1	D10 T-SHAPED FITTING	2	PZ																																																																																		
RC1360A0	10 - 10 JG ELBOW FITTIN	1	PZ																																																																																		
RC1376A0	Ø6 Y-FITTING	2	PZ																																																																																		
TB1177A0	FOOT PANEL 40X40 H58 OVERLAP LM	8	PZ																																																																																		
TB1520A0	INT. Ø=38 TH=4 DRAIN BLACK RUBBER PIPE	5	M																																																																																		
TB1815A0	7,93X4,75 PE TRANSP. PIPE (JG #PE08100N)	12	M																																																																																		
TB1816A0	CLEAR POLYPROPYL ENE PIPE 6X4MM	3	M																																																																																		
TB2243A0	Ø10 PET PIPE	4	M																																																																																		
VI1220A1	4,2X12 TCB SELF-TAPPIN G SCREW	30	PZ																																																																																		
VI1895A0	BLIND NUT M4 STAINLESS STEEL DIN 917	12	PZ																																																																																		
VI1945A0	ENG-VITE M4X20 TCB+ INOX	12	PZ																																																																																		
VI1950A0	ST. STEEL 4,2X13 TCB SELF-DRILLIN G SCREW	20	PZ																																																																																		
VL1005A1	U-TRAP TANK	3	PZ																																																																																		
VL1006A0	SYPHON COVER	3	PZ																																																																																		

COMPONENT			SPARE PART																																																																							
Code	Description	Image	Code	Description	Components list																																																																					
VL1006A	SYPHON COVER		XC761	3 OVENS LM TOP XFT200 STACKING KIT	<table border="1"> <thead> <tr> <th>Code</th> <th>Description</th> <th>Qty</th> <th>UOM</th> </tr> </thead> <tbody> <tr> <td>VL1046A1</td> <td>D6 PIPE HOLDER - D6 J.G. TERMINAL</td> <td>12</td> <td>PZ</td> </tr> <tr> <td>VM1015A1</td> <td>STAINLESS STEEL Ø30X1.5 90° BEND</td> <td>1</td> <td>PZ</td> </tr> <tr> <td>VM1794A0</td> <td>250X4.8 PA66 BLACK CLAMP</td> <td>3</td> <td>PZ</td> </tr> <tr> <td>VM2035A0</td> <td>DRAIN PIPE SUPPORT</td> <td>3</td> <td>PZ</td> </tr> </tbody> </table>	Code	Description	Qty	UOM	VL1046A1	D6 PIPE HOLDER - D6 J.G. TERMINAL	12	PZ	VM1015A1	STAINLESS STEEL Ø30X1.5 90° BEND	1	PZ	VM1794A0	250X4.8 PA66 BLACK CLAMP	3	PZ	VM2035A0	DRAIN PIPE SUPPORT	3	PZ																																																	
			Code	Description	Qty	UOM																																																																				
VL1046A1	D6 PIPE HOLDER - D6 J.G. TERMINAL	12	PZ																																																																							
VM1015A1	STAINLESS STEEL Ø30X1.5 90° BEND	1	PZ																																																																							
VM1794A0	250X4.8 PA66 BLACK CLAMP	3	PZ																																																																							
VM2035A0	DRAIN PIPE SUPPORT	3	PZ																																																																							
XC757	S. E CHEFTOP GN1/1 STACKING KI	<table border="1"> <thead> <tr> <th>Code</th> <th>Description</th> <th>Qty</th> <th>UOM</th> </tr> </thead> <tbody> <tr> <td>0H6463A0</td> <td>XC757 FRONT PROFILE</td> <td>1</td> <td>PZ</td> </tr> <tr> <td>CE1305A0</td> <td>L=2MT RJ45 - RJ45 CABLE</td> <td>1</td> <td>PZ</td> </tr> <tr> <td>ED1246A0</td> <td>HOT SURFACE LABEL</td> <td>2</td> <td>PZ</td> </tr> <tr> <td>ED1271A0</td> <td>LIQUID FALLS DANGER LABE</td> <td>1</td> <td>PZ</td> </tr> <tr> <td>EL1020A1</td> <td>D8 INTERMEDIAT E T-SHAPED FITTING</td> <td>2</td> <td>PZ</td> </tr> <tr> <td>GN1508A0</td> <td>O-RING GASKET COD 2400</td> <td>2</td> <td>PZ</td> </tr> <tr> <td>PD1069A0</td> <td>FOOT OVERLAP S5 CT-BT-E</td> <td>1</td> <td>PZ</td> </tr> <tr> <td>RC1008A0</td> <td>D9 ELASTIC CLIP</td> <td>3</td> <td>PZ</td> </tr> <tr> <td>RC1055A0</td> <td>Ø25-40 H12 STAINLESS STEEL PIPE CLIP</td> <td>14</td> <td>PZ</td> </tr> <tr> <td>RC1130A0</td> <td>130X2,6 CLAM</td> <td>3</td> <td>PZ</td> </tr> <tr> <td>RC1297A1</td> <td>D10 T-SHAPED FITTING</td> <td>1</td> <td>PZ</td> </tr> <tr> <td>RC1376A0</td> <td>Ø6 Y-FITTING</td> <td>1</td> <td>PZ</td> </tr> <tr> <td>TB1520A0</td> <td>INT. Ø=38 TH=4 DRAIN BLACK RUBBER PIPE</td> <td>5</td> <td>M</td> </tr> <tr> <td>TB1765A1</td> <td>STACKING KIT CHIMNEY CONNECTING PIPE</td> <td>2</td> <td>PZ</td> </tr> <tr> <td>TB2243A0</td> <td>Ø10 PET PIPE</td> <td>1.500</td> <td>M</td> </tr> <tr> <td>VI1220A1</td> <td>4,2X12 TCB SELF-TAPPIN G SCREW</td> <td>4</td> <td>PZ</td> </tr> <tr> <td>VI1895A0</td> <td>BLIND NUT M4 STAINLESS STEEL DIN 917</td> <td>8</td> <td>PZ</td> </tr> </tbody> </table>	Code	Description	Qty	UOM	0H6463A0	XC757 FRONT PROFILE	1	PZ	CE1305A0	L=2MT RJ45 - RJ45 CABLE	1	PZ	ED1246A0	HOT SURFACE LABEL	2	PZ	ED1271A0	LIQUID FALLS DANGER LABE	1	PZ	EL1020A1	D8 INTERMEDIAT E T-SHAPED FITTING	2	PZ	GN1508A0	O-RING GASKET COD 2400	2	PZ	PD1069A0	FOOT OVERLAP S5 CT-BT-E	1	PZ	RC1008A0	D9 ELASTIC CLIP	3	PZ	RC1055A0	Ø25-40 H12 STAINLESS STEEL PIPE CLIP	14	PZ	RC1130A0	130X2,6 CLAM	3	PZ	RC1297A1	D10 T-SHAPED FITTING	1	PZ	RC1376A0	Ø6 Y-FITTING	1	PZ	TB1520A0	INT. Ø=38 TH=4 DRAIN BLACK RUBBER PIPE	5	M	TB1765A1	STACKING KIT CHIMNEY CONNECTING PIPE	2	PZ	TB2243A0	Ø10 PET PIPE	1.500	M	VI1220A1	4,2X12 TCB SELF-TAPPIN G SCREW	4	PZ	VI1895A0	BLIND NUT M4 STAINLESS STEEL DIN 917	8	PZ
Code	Description	Qty	UOM																																																																							
0H6463A0	XC757 FRONT PROFILE	1	PZ																																																																							
CE1305A0	L=2MT RJ45 - RJ45 CABLE	1	PZ																																																																							
ED1246A0	HOT SURFACE LABEL	2	PZ																																																																							
ED1271A0	LIQUID FALLS DANGER LABE	1	PZ																																																																							
EL1020A1	D8 INTERMEDIAT E T-SHAPED FITTING	2	PZ																																																																							
GN1508A0	O-RING GASKET COD 2400	2	PZ																																																																							
PD1069A0	FOOT OVERLAP S5 CT-BT-E	1	PZ																																																																							
RC1008A0	D9 ELASTIC CLIP	3	PZ																																																																							
RC1055A0	Ø25-40 H12 STAINLESS STEEL PIPE CLIP	14	PZ																																																																							
RC1130A0	130X2,6 CLAM	3	PZ																																																																							
RC1297A1	D10 T-SHAPED FITTING	1	PZ																																																																							
RC1376A0	Ø6 Y-FITTING	1	PZ																																																																							
TB1520A0	INT. Ø=38 TH=4 DRAIN BLACK RUBBER PIPE	5	M																																																																							
TB1765A1	STACKING KIT CHIMNEY CONNECTING PIPE	2	PZ																																																																							
TB2243A0	Ø10 PET PIPE	1.500	M																																																																							
VI1220A1	4,2X12 TCB SELF-TAPPIN G SCREW	4	PZ																																																																							
VI1895A0	BLIND NUT M4 STAINLESS STEEL DIN 917	8	PZ																																																																							

COMPONENT			SPARE PART																																															
Code	Description	Image	Code	Description	Components list																																													
VL1006A	SYPHON COVER		XC757	S. E CHEFTOP GN1/1 STACKING KI	<table border="1"> <thead> <tr> <th>Code</th> <th>Description</th> <th>Qty</th> <th>UOM</th> </tr> </thead> <tbody> <tr> <td>VI1945A0</td> <td>ENG-VITE M4X20 TCB+ INOX</td> <td>8</td> <td>PZ</td> </tr> <tr> <td>VI1950A0</td> <td>ST. STEEL 4,2X13 TCB SELF-DRILLIN G SCREW</td> <td>26</td> <td>PZ</td> </tr> <tr> <td>VL1005A1</td> <td>U-TRAP TANK</td> <td>2</td> <td>PZ</td> </tr> <tr> <td>VL1006A0</td> <td>SYPHON COVER</td> <td>2</td> <td>PZ</td> </tr> <tr> <td>VL1043A0</td> <td>D4 PIPE HOLDER - D6 J.G. TERMINAL</td> <td>3</td> <td>PZ</td> </tr> <tr> <td>VL1046A1</td> <td>D6 PIPE HOLDER - D6 J.G. TERMINAL</td> <td>3</td> <td>PZ</td> </tr> <tr> <td>VM1015A1</td> <td>STAINLESS STEEL Ø30X1.5 90° BEND</td> <td>1</td> <td>PZ</td> </tr> <tr> <td>VM1794A0</td> <td>250X4.8 PA66 BLACK CLAMP</td> <td>3</td> <td>PZ</td> </tr> <tr> <td>VM1987A0</td> <td>BRACKET FOR OVENS STACKING</td> <td>1</td> <td>PZ</td> </tr> <tr> <td>VM2035A0</td> <td>DRAIN PIPE SUPPORT</td> <td>2</td> <td>PZ</td> </tr> </tbody> </table>	Code	Description	Qty	UOM	VI1945A0	ENG-VITE M4X20 TCB+ INOX	8	PZ	VI1950A0	ST. STEEL 4,2X13 TCB SELF-DRILLIN G SCREW	26	PZ	VL1005A1	U-TRAP TANK	2	PZ	VL1006A0	SYPHON COVER	2	PZ	VL1043A0	D4 PIPE HOLDER - D6 J.G. TERMINAL	3	PZ	VL1046A1	D6 PIPE HOLDER - D6 J.G. TERMINAL	3	PZ	VM1015A1	STAINLESS STEEL Ø30X1.5 90° BEND	1	PZ	VM1794A0	250X4.8 PA66 BLACK CLAMP	3	PZ	VM1987A0	BRACKET FOR OVENS STACKING	1	PZ	VM2035A0	DRAIN PIPE SUPPORT	2	PZ	
			Code	Description	Qty	UOM																																												
VI1945A0	ENG-VITE M4X20 TCB+ INOX	8	PZ																																															
VI1950A0	ST. STEEL 4,2X13 TCB SELF-DRILLIN G SCREW	26	PZ																																															
VL1005A1	U-TRAP TANK	2	PZ																																															
VL1006A0	SYPHON COVER	2	PZ																																															
VL1043A0	D4 PIPE HOLDER - D6 J.G. TERMINAL	3	PZ																																															
VL1046A1	D6 PIPE HOLDER - D6 J.G. TERMINAL	3	PZ																																															
VM1015A1	STAINLESS STEEL Ø30X1.5 90° BEND	1	PZ																																															
VM1794A0	250X4.8 PA66 BLACK CLAMP	3	PZ																																															
VM1987A0	BRACKET FOR OVENS STACKING	1	PZ																																															
VM2035A0	DRAIN PIPE SUPPORT	2	PZ																																															
XC756	E SERIES GN 2/3 STACKING KIT	<table border="1"> <thead> <tr> <th>Code</th> <th>Description</th> <th>Qty</th> <th>UOM</th> </tr> </thead> <tbody> <tr> <td>0H6462A0</td> <td>XC756 FRONT PROFILE</td> <td>1</td> <td>PZ</td> </tr> <tr> <td>CE1305A0</td> <td>L=2MT RJ45 - RJ45 CABLE</td> <td>1</td> <td>PZ</td> </tr> <tr> <td>ED1246A0</td> <td>HOT SURFACE LABEL</td> <td>1</td> <td>PZ</td> </tr> <tr> <td>ED1271A0</td> <td>LIQUID FALLS DANGER LABE</td> <td>1</td> <td>PZ</td> </tr> <tr> <td>EL1020A1</td> <td>D8 INTERMEDIAT E T-SHAPED FITTING</td> <td>2</td> <td>PZ</td> </tr> <tr> <td>GN1508A0</td> <td>O-RING GASKET COD 2400</td> <td>2</td> <td>PZ</td> </tr> <tr> <td>PD1069A0</td> <td>FOOT OVERLAP S5 CT-BT-E</td> <td>1</td> <td>PZ</td> </tr> <tr> <td>RC1008A0</td> <td>D9 ELASTIC CLIP</td> <td>3</td> <td>PZ</td> </tr> <tr> <td>RC1055A0</td> <td>Ø25-40 H12 STAINLESS STEEL PIPE CLIP</td> <td>14</td> <td>PZ</td> </tr> <tr> <td>RC1130A0</td> <td>130X2,6 CLAM</td> <td>3</td> <td>PZ</td> </tr> <tr> <td>RC1297A1</td> <td>D10 T-SHAPED FITTING</td> <td>1</td> <td>PZ</td> </tr> </tbody> </table>	Code	Description	Qty	UOM	0H6462A0	XC756 FRONT PROFILE	1	PZ	CE1305A0	L=2MT RJ45 - RJ45 CABLE	1	PZ	ED1246A0	HOT SURFACE LABEL	1	PZ	ED1271A0	LIQUID FALLS DANGER LABE	1	PZ	EL1020A1	D8 INTERMEDIAT E T-SHAPED FITTING	2	PZ	GN1508A0	O-RING GASKET COD 2400	2	PZ	PD1069A0	FOOT OVERLAP S5 CT-BT-E	1	PZ	RC1008A0	D9 ELASTIC CLIP	3	PZ	RC1055A0	Ø25-40 H12 STAINLESS STEEL PIPE CLIP	14	PZ	RC1130A0	130X2,6 CLAM	3	PZ	RC1297A1	D10 T-SHAPED FITTING	1	PZ
Code	Description	Qty	UOM																																															
0H6462A0	XC756 FRONT PROFILE	1	PZ																																															
CE1305A0	L=2MT RJ45 - RJ45 CABLE	1	PZ																																															
ED1246A0	HOT SURFACE LABEL	1	PZ																																															
ED1271A0	LIQUID FALLS DANGER LABE	1	PZ																																															
EL1020A1	D8 INTERMEDIAT E T-SHAPED FITTING	2	PZ																																															
GN1508A0	O-RING GASKET COD 2400	2	PZ																																															
PD1069A0	FOOT OVERLAP S5 CT-BT-E	1	PZ																																															
RC1008A0	D9 ELASTIC CLIP	3	PZ																																															
RC1055A0	Ø25-40 H12 STAINLESS STEEL PIPE CLIP	14	PZ																																															
RC1130A0	130X2,6 CLAM	3	PZ																																															
RC1297A1	D10 T-SHAPED FITTING	1	PZ																																															

COMPONENT			SPARE PART																																																																						
Code	Description	Image	Code	Description	Components list																																																																				
VL1006A	SYPHON COVER		XC756	E SERIES GN 2/3 STACKING KIT	<table border="1"> <thead> <tr> <th>Code</th> <th>Description</th> <th>Qty</th> <th>UOM</th> </tr> </thead> <tbody> <tr> <td>RC1376A0</td> <td>Ø6 Y-FITTING</td> <td>1</td> <td>PZ</td> </tr> <tr> <td>TB1520A0</td> <td>INT. Ø=38 TH=4 DRAIN BLACK RUBBER PIPE</td> <td>3</td> <td>M</td> </tr> <tr> <td>TB1765A1</td> <td>STACKING KIT CHIMNEY CONNECTING PIPE</td> <td>1</td> <td>PZ</td> </tr> <tr> <td>TB2243A0</td> <td>Ø10 PET PIPE</td> <td>1.500</td> <td>M</td> </tr> <tr> <td>VI1220A1</td> <td>4,2X12 TCB SELF-TAPPIN G SCREW</td> <td>4</td> <td>PZ</td> </tr> <tr> <td>VI1895A0</td> <td>BLIND NUT M4 STAINLESS STEEL DIN 917</td> <td>8</td> <td>PZ</td> </tr> <tr> <td>VI1945A0</td> <td>ENG-VITE M4X20 TCB+ INOX</td> <td>8</td> <td>PZ</td> </tr> <tr> <td>VI1950A0</td> <td>ST. STEEL 4,2X13 TCB SELF-DRILLIN G SCREW</td> <td>26</td> <td>PZ</td> </tr> <tr> <td>VL1005A1</td> <td>U-TRAP TANK</td> <td>2</td> <td>PZ</td> </tr> <tr> <td>VL1006A0</td> <td>SYPHON COVER</td> <td>2</td> <td>PZ</td> </tr> <tr> <td>VL1043A0</td> <td>D4 PIPE HOLDER - D6 J.G. TERMINAL</td> <td>3</td> <td>PZ</td> </tr> <tr> <td>VL1046A1</td> <td>D6 PIPE HOLDER - D6 J.G. TERMINAL</td> <td>3</td> <td>PZ</td> </tr> <tr> <td>VM1015A1</td> <td>STAINLESS STEEL Ø30X1.5 90° BEND</td> <td>1</td> <td>PZ</td> </tr> <tr> <td>VM1794A0</td> <td>250X4.8 PA66 BLACK CLAMP</td> <td>3</td> <td>PZ</td> </tr> <tr> <td>VM1987A0</td> <td>BRACKET FOR OVENS STACKING</td> <td>1</td> <td>PZ</td> </tr> <tr> <td>VM2035A0</td> <td>DRAIN PIPE SUPPORT</td> <td>1</td> <td>PZ</td> </tr> </tbody> </table>	Code	Description	Qty	UOM	RC1376A0	Ø6 Y-FITTING	1	PZ	TB1520A0	INT. Ø=38 TH=4 DRAIN BLACK RUBBER PIPE	3	M	TB1765A1	STACKING KIT CHIMNEY CONNECTING PIPE	1	PZ	TB2243A0	Ø10 PET PIPE	1.500	M	VI1220A1	4,2X12 TCB SELF-TAPPIN G SCREW	4	PZ	VI1895A0	BLIND NUT M4 STAINLESS STEEL DIN 917	8	PZ	VI1945A0	ENG-VITE M4X20 TCB+ INOX	8	PZ	VI1950A0	ST. STEEL 4,2X13 TCB SELF-DRILLIN G SCREW	26	PZ	VL1005A1	U-TRAP TANK	2	PZ	VL1006A0	SYPHON COVER	2	PZ	VL1043A0	D4 PIPE HOLDER - D6 J.G. TERMINAL	3	PZ	VL1046A1	D6 PIPE HOLDER - D6 J.G. TERMINAL	3	PZ	VM1015A1	STAINLESS STEEL Ø30X1.5 90° BEND	1	PZ	VM1794A0	250X4.8 PA66 BLACK CLAMP	3	PZ	VM1987A0	BRACKET FOR OVENS STACKING	1	PZ	VM2035A0	DRAIN PIPE SUPPORT	1	PZ
Code	Description	Qty	UOM																																																																						
RC1376A0	Ø6 Y-FITTING	1	PZ																																																																						
TB1520A0	INT. Ø=38 TH=4 DRAIN BLACK RUBBER PIPE	3	M																																																																						
TB1765A1	STACKING KIT CHIMNEY CONNECTING PIPE	1	PZ																																																																						
TB2243A0	Ø10 PET PIPE	1.500	M																																																																						
VI1220A1	4,2X12 TCB SELF-TAPPIN G SCREW	4	PZ																																																																						
VI1895A0	BLIND NUT M4 STAINLESS STEEL DIN 917	8	PZ																																																																						
VI1945A0	ENG-VITE M4X20 TCB+ INOX	8	PZ																																																																						
VI1950A0	ST. STEEL 4,2X13 TCB SELF-DRILLIN G SCREW	26	PZ																																																																						
VL1005A1	U-TRAP TANK	2	PZ																																																																						
VL1006A0	SYPHON COVER	2	PZ																																																																						
VL1043A0	D4 PIPE HOLDER - D6 J.G. TERMINAL	3	PZ																																																																						
VL1046A1	D6 PIPE HOLDER - D6 J.G. TERMINAL	3	PZ																																																																						
VM1015A1	STAINLESS STEEL Ø30X1.5 90° BEND	1	PZ																																																																						
VM1794A0	250X4.8 PA66 BLACK CLAMP	3	PZ																																																																						
VM1987A0	BRACKET FOR OVENS STACKING	1	PZ																																																																						
VM2035A0	DRAIN PIPE SUPPORT	1	PZ																																																																						
			XC755	E SERIES BT-CT GN 2/1 STACKING KIT	<table border="1"> <thead> <tr> <th>Code</th> <th>Description</th> <th>Qty</th> <th>UOM</th> </tr> </thead> <tbody> <tr> <td>0H6461A0</td> <td>XC755 FRONT PROFILE</td> <td>1</td> <td>PZ</td> </tr> <tr> <td>CE1635A0</td> <td>RJ45 - RJ45 CABLE L=3M</td> <td>1</td> <td>PZ</td> </tr> <tr> <td>ED1246A0</td> <td>HOT SURFACE LABEL</td> <td>2</td> <td>PZ</td> </tr> <tr> <td>ED1271A0</td> <td>LIQUID FALLS DANGER LABE</td> <td>1</td> <td>PZ</td> </tr> </tbody> </table>	Code	Description	Qty	UOM	0H6461A0	XC755 FRONT PROFILE	1	PZ	CE1635A0	RJ45 - RJ45 CABLE L=3M	1	PZ	ED1246A0	HOT SURFACE LABEL	2	PZ	ED1271A0	LIQUID FALLS DANGER LABE	1	PZ																																																
Code	Description	Qty	UOM																																																																						
0H6461A0	XC755 FRONT PROFILE	1	PZ																																																																						
CE1635A0	RJ45 - RJ45 CABLE L=3M	1	PZ																																																																						
ED1246A0	HOT SURFACE LABEL	2	PZ																																																																						
ED1271A0	LIQUID FALLS DANGER LABE	1	PZ																																																																						

COMPONENT			SPARE PART																																																																																						
Code	Description	Image	Code	Description	Components list																																																																																				
VL1006A	SYPHON COVER		XC755	E SERIES BT-CT GN 2/1 STACKING KIT	<table border="1"> <thead> <tr> <th>Code</th> <th>Description</th> <th>Qty</th> <th>UOM</th> </tr> </thead> <tbody> <tr> <td>EL1020A1</td> <td>D8 INTERMEDIAT E T-SHAPED FITTING</td> <td>2</td> <td>PZ</td> </tr> <tr> <td>GN1508A0</td> <td>O-RING GASKET COD 2400</td> <td>2</td> <td>PZ</td> </tr> <tr> <td>PD1069A0</td> <td>FOOT OVERLAP S5 CT-BT-E</td> <td>1</td> <td>PZ</td> </tr> <tr> <td>RC1008A0</td> <td>D9 ELASTIC CLIP</td> <td>3</td> <td>PZ</td> </tr> <tr> <td>RC1055A0</td> <td>Ø25-40 H12 STAINLESS STEEL PIPE CLIP</td> <td>14</td> <td>PZ</td> </tr> <tr> <td>RC1130A0</td> <td>130X2,6 CLAM</td> <td>3</td> <td>PZ</td> </tr> <tr> <td>RC1297A1</td> <td>D10 T-SHAPED FITTING</td> <td>1</td> <td>PZ</td> </tr> <tr> <td>RC1376A0</td> <td>Ø6 Y-FITTING</td> <td>1</td> <td>PZ</td> </tr> <tr> <td>TB1520A0</td> <td>INT. Ø=38 TH=4 DRAIN BLACK RUBBER PIPE</td> <td>5</td> <td>M</td> </tr> <tr> <td>TB1765A1</td> <td>STACKING KIT CHIMNEY CONNECTING PIPE</td> <td>2</td> <td>PZ</td> </tr> <tr> <td>TB2243A0</td> <td>Ø10 PET PIPE</td> <td>1.500</td> <td>M</td> </tr> <tr> <td>VI1220A1</td> <td>4,2X12 TCB SELF-TAPPIN G SCREW</td> <td>4</td> <td>PZ</td> </tr> <tr> <td>VI1895A0</td> <td>BLIND NUT M4 STAINLESS STEEL DIN 917</td> <td>8</td> <td>PZ</td> </tr> <tr> <td>VI1945A0</td> <td>ENG-VITE M4X20 TCB+ INOX</td> <td>8</td> <td>PZ</td> </tr> <tr> <td>VI1950A0</td> <td>ST. STEEL 4,2X13 TCB SELF-DRILLIN G SCREW</td> <td>26</td> <td>PZ</td> </tr> <tr> <td>VL1005A1</td> <td>U-TRAP TANK</td> <td>2</td> <td>PZ</td> </tr> <tr> <td>VL1006A0</td> <td>SYPHON COVER</td> <td>2</td> <td>PZ</td> </tr> <tr> <td>VL1043A0</td> <td>D4 PIPE HOLDER - D6 J.G. TERMINAL</td> <td>3</td> <td>PZ</td> </tr> <tr> <td>VL1046A1</td> <td>D6 PIPE HOLDER - D6 J.G. TERMINAL</td> <td>3</td> <td>PZ</td> </tr> <tr> <td>VM1015A1</td> <td>STAINLESS STEEL Ø30X1,5 90° BEND</td> <td>1</td> <td>PZ</td> </tr> </tbody> </table>	Code	Description	Qty	UOM	EL1020A1	D8 INTERMEDIAT E T-SHAPED FITTING	2	PZ	GN1508A0	O-RING GASKET COD 2400	2	PZ	PD1069A0	FOOT OVERLAP S5 CT-BT-E	1	PZ	RC1008A0	D9 ELASTIC CLIP	3	PZ	RC1055A0	Ø25-40 H12 STAINLESS STEEL PIPE CLIP	14	PZ	RC1130A0	130X2,6 CLAM	3	PZ	RC1297A1	D10 T-SHAPED FITTING	1	PZ	RC1376A0	Ø6 Y-FITTING	1	PZ	TB1520A0	INT. Ø=38 TH=4 DRAIN BLACK RUBBER PIPE	5	M	TB1765A1	STACKING KIT CHIMNEY CONNECTING PIPE	2	PZ	TB2243A0	Ø10 PET PIPE	1.500	M	VI1220A1	4,2X12 TCB SELF-TAPPIN G SCREW	4	PZ	VI1895A0	BLIND NUT M4 STAINLESS STEEL DIN 917	8	PZ	VI1945A0	ENG-VITE M4X20 TCB+ INOX	8	PZ	VI1950A0	ST. STEEL 4,2X13 TCB SELF-DRILLIN G SCREW	26	PZ	VL1005A1	U-TRAP TANK	2	PZ	VL1006A0	SYPHON COVER	2	PZ	VL1043A0	D4 PIPE HOLDER - D6 J.G. TERMINAL	3	PZ	VL1046A1	D6 PIPE HOLDER - D6 J.G. TERMINAL	3	PZ	VM1015A1	STAINLESS STEEL Ø30X1,5 90° BEND	1	PZ
Code	Description	Qty	UOM																																																																																						
EL1020A1	D8 INTERMEDIAT E T-SHAPED FITTING	2	PZ																																																																																						
GN1508A0	O-RING GASKET COD 2400	2	PZ																																																																																						
PD1069A0	FOOT OVERLAP S5 CT-BT-E	1	PZ																																																																																						
RC1008A0	D9 ELASTIC CLIP	3	PZ																																																																																						
RC1055A0	Ø25-40 H12 STAINLESS STEEL PIPE CLIP	14	PZ																																																																																						
RC1130A0	130X2,6 CLAM	3	PZ																																																																																						
RC1297A1	D10 T-SHAPED FITTING	1	PZ																																																																																						
RC1376A0	Ø6 Y-FITTING	1	PZ																																																																																						
TB1520A0	INT. Ø=38 TH=4 DRAIN BLACK RUBBER PIPE	5	M																																																																																						
TB1765A1	STACKING KIT CHIMNEY CONNECTING PIPE	2	PZ																																																																																						
TB2243A0	Ø10 PET PIPE	1.500	M																																																																																						
VI1220A1	4,2X12 TCB SELF-TAPPIN G SCREW	4	PZ																																																																																						
VI1895A0	BLIND NUT M4 STAINLESS STEEL DIN 917	8	PZ																																																																																						
VI1945A0	ENG-VITE M4X20 TCB+ INOX	8	PZ																																																																																						
VI1950A0	ST. STEEL 4,2X13 TCB SELF-DRILLIN G SCREW	26	PZ																																																																																						
VL1005A1	U-TRAP TANK	2	PZ																																																																																						
VL1006A0	SYPHON COVER	2	PZ																																																																																						
VL1043A0	D4 PIPE HOLDER - D6 J.G. TERMINAL	3	PZ																																																																																						
VL1046A1	D6 PIPE HOLDER - D6 J.G. TERMINAL	3	PZ																																																																																						
VM1015A1	STAINLESS STEEL Ø30X1,5 90° BEND	1	PZ																																																																																						

COMPONENT			SPARE PART																																															
Code	Description	Image	Code	Description	Components list																																													
VL1006A	SYPHON COVER		XC755	E SERIES BT-CT GN 2/1 STACKING KIT	<table border="1"> <thead> <tr> <th>Code</th> <th>Description</th> <th>Qty</th> <th>UOM</th> </tr> </thead> <tbody> <tr> <td>VM1794A0</td> <td>250X4.8 PA66 BLACK CLAMP</td> <td>3</td> <td>PZ</td> </tr> <tr> <td>VM1987A0</td> <td>BRACKET FOR OVENS STACKING</td> <td>1</td> <td>PZ</td> </tr> <tr> <td>VM2035A0</td> <td>DRAIN PIPE SUPPORT</td> <td>2</td> <td>PZ</td> </tr> </tbody> </table>	Code	Description	Qty	UOM	VM1794A0	250X4.8 PA66 BLACK CLAMP	3	PZ	VM1987A0	BRACKET FOR OVENS STACKING	1	PZ	VM2035A0	DRAIN PIPE SUPPORT	2	PZ																													
			Code	Description	Qty	UOM																																												
			VM1794A0	250X4.8 PA66 BLACK CLAMP	3	PZ																																												
VM1987A0	BRACKET FOR OVENS STACKING	1	PZ																																															
VM2035A0	DRAIN PIPE SUPPORT	2	PZ																																															
XC699	LINEMISS TOP FIRST INSTALLATION KIT	<table border="1"> <thead> <tr> <th>Code</th> <th>Description</th> <th>Qty</th> <th>UOM</th> </tr> </thead> <tbody> <tr> <td>0H1237A0</td> <td>LM TOP SIPHON SUPPORT</td> <td>1</td> <td>PZ</td> </tr> <tr> <td>GN1508A0</td> <td>O-RING GASKET COD 2400</td> <td>1</td> <td>PZ</td> </tr> <tr> <td>RC1055A0</td> <td>Ø25-40 H12 STAINLESS STEEL PIPE CLIP</td> <td>4</td> <td>PZ</td> </tr> <tr> <td>TB1520A0</td> <td>INT. Ø=38 TH=4 DRAIN BLACK RUBBER PIPE</td> <td>2.500</td> <td>M</td> </tr> <tr> <td>VI1220A1</td> <td>4,2X12 TCB SELF-TAPPIN G SCREW</td> <td>2</td> <td>PZ</td> </tr> <tr> <td>VI1895A0</td> <td>BLIND NUT M4 STAINLESS STEEL DIN 917</td> <td>4</td> <td>PZ</td> </tr> <tr> <td>VI1945A0</td> <td>ENG-VITE M4X20 TCB+ INOX</td> <td>4</td> <td>PZ</td> </tr> <tr> <td>VI1950A0</td> <td>ST. STEEL 4,2X13 TCB SELF-DRILLIN G SCREW</td> <td>2</td> <td>PZ</td> </tr> <tr> <td>VL1005A1</td> <td>U-TRAP TANK</td> <td>1</td> <td>PZ</td> </tr> <tr> <td>VL1006A0</td> <td>SYPHON COVER</td> <td>1</td> <td>PZ</td> </tr> <tr> <td>VM1015A1</td> <td>STAINLESS STEEL Ø30X1.5 90° BEND</td> <td>1</td> <td>PZ</td> </tr> </tbody> </table>	Code	Description	Qty	UOM	0H1237A0	LM TOP SIPHON SUPPORT	1	PZ	GN1508A0	O-RING GASKET COD 2400	1	PZ	RC1055A0	Ø25-40 H12 STAINLESS STEEL PIPE CLIP	4	PZ	TB1520A0	INT. Ø=38 TH=4 DRAIN BLACK RUBBER PIPE	2.500	M	VI1220A1	4,2X12 TCB SELF-TAPPIN G SCREW	2	PZ	VI1895A0	BLIND NUT M4 STAINLESS STEEL DIN 917	4	PZ	VI1945A0	ENG-VITE M4X20 TCB+ INOX	4	PZ	VI1950A0	ST. STEEL 4,2X13 TCB SELF-DRILLIN G SCREW	2	PZ	VL1005A1	U-TRAP TANK	1	PZ	VL1006A0	SYPHON COVER	1	PZ	VM1015A1	STAINLESS STEEL Ø30X1.5 90° BEND	1	PZ
Code	Description	Qty	UOM																																															
0H1237A0	LM TOP SIPHON SUPPORT	1	PZ																																															
GN1508A0	O-RING GASKET COD 2400	1	PZ																																															
RC1055A0	Ø25-40 H12 STAINLESS STEEL PIPE CLIP	4	PZ																																															
TB1520A0	INT. Ø=38 TH=4 DRAIN BLACK RUBBER PIPE	2.500	M																																															
VI1220A1	4,2X12 TCB SELF-TAPPIN G SCREW	2	PZ																																															
VI1895A0	BLIND NUT M4 STAINLESS STEEL DIN 917	4	PZ																																															
VI1945A0	ENG-VITE M4X20 TCB+ INOX	4	PZ																																															
VI1950A0	ST. STEEL 4,2X13 TCB SELF-DRILLIN G SCREW	2	PZ																																															
VL1005A1	U-TRAP TANK	1	PZ																																															
VL1006A0	SYPHON COVER	1	PZ																																															
VM1015A1	STAINLESS STEEL Ø30X1.5 90° BEND	1	PZ																																															
XC673	COMPLETE P-TRAP KIT	<table border="1"> <thead> <tr> <th>Code</th> <th>Description</th> <th>Qty</th> <th>UOM</th> </tr> </thead> <tbody> <tr> <td>GN1508A0</td> <td>O-RING GASKET COD 2400</td> <td>1</td> <td>PZ</td> </tr> <tr> <td>RC1055A0</td> <td>Ø25-40 H12 STAINLESS STEEL PIPE CLIP</td> <td>2</td> <td>PZ</td> </tr> </tbody> </table>	Code	Description	Qty	UOM	GN1508A0	O-RING GASKET COD 2400	1	PZ	RC1055A0	Ø25-40 H12 STAINLESS STEEL PIPE CLIP	2	PZ																																				
Code	Description	Qty	UOM																																															
GN1508A0	O-RING GASKET COD 2400	1	PZ																																															
RC1055A0	Ø25-40 H12 STAINLESS STEEL PIPE CLIP	2	PZ																																															

COMPONENT			SPARE PART																																																			
Code	Description	Image	Code	Description	Components list																																																	
VL1006A	SYPHON COVER		XC673	COMPLETE P-TRAP KIT	<table border="1"> <thead> <tr> <th>Code</th> <th>Description</th> <th>Qty</th> <th>UOM</th> </tr> </thead> <tbody> <tr> <td>TB1520A0</td> <td>INT. Ø=38 TH=4 DRAIN BLACK RUBBER PIPE</td> <td>0.050</td> <td>M</td> </tr> <tr> <td>VI1220A1</td> <td>4,2X12 TCB SELF-TAPPIN G SCREW</td> <td>2</td> <td>PZ</td> </tr> <tr> <td>VI1895A0</td> <td>BLIND NUT M4 STAINLESS STEEL DIN 917</td> <td>4</td> <td>PZ</td> </tr> <tr> <td>VI1945A0</td> <td>ENG-VITE M4X20 TCB+ INOX</td> <td>4</td> <td>PZ</td> </tr> <tr> <td>VI1950A0</td> <td>ST. STEEL 4,2X13 TCB SELF-DRILLIN G SCREW</td> <td>2</td> <td>PZ</td> </tr> <tr> <td>VL1005A1</td> <td>U-TRAP TANK</td> <td>1</td> <td>PZ</td> </tr> <tr> <td>VL1006A0</td> <td>SYPHON COVER</td> <td>1</td> <td>PZ</td> </tr> </tbody> </table>	Code	Description	Qty	UOM	TB1520A0	INT. Ø=38 TH=4 DRAIN BLACK RUBBER PIPE	0.050	M	VI1220A1	4,2X12 TCB SELF-TAPPIN G SCREW	2	PZ	VI1895A0	BLIND NUT M4 STAINLESS STEEL DIN 917	4	PZ	VI1945A0	ENG-VITE M4X20 TCB+ INOX	4	PZ	VI1950A0	ST. STEEL 4,2X13 TCB SELF-DRILLIN G SCREW	2	PZ	VL1005A1	U-TRAP TANK	1	PZ	VL1006A0	SYPHON COVER	1	PZ																	
			Code	Description	Qty	UOM																																																
TB1520A0	INT. Ø=38 TH=4 DRAIN BLACK RUBBER PIPE	0.050	M																																																			
VI1220A1	4,2X12 TCB SELF-TAPPIN G SCREW	2	PZ																																																			
VI1895A0	BLIND NUT M4 STAINLESS STEEL DIN 917	4	PZ																																																			
VI1945A0	ENG-VITE M4X20 TCB+ INOX	4	PZ																																																			
VI1950A0	ST. STEEL 4,2X13 TCB SELF-DRILLIN G SCREW	2	PZ																																																			
VL1005A1	U-TRAP TANK	1	PZ																																																			
VL1006A0	SYPHON COVER	1	PZ																																																			
XC653	LINEMISSTOP XFT140 STACKING KIT	<table border="1"> <thead> <tr> <th>Code</th> <th>Description</th> <th>Qty</th> <th>UOM</th> </tr> </thead> <tbody> <tr> <td>0H1237A0</td> <td>LM TOP SIPHON SUPPORT</td> <td>2</td> <td>PZ</td> </tr> <tr> <td>0H7084A0</td> <td>XC651 FRONT STACKING PROFILE</td> <td>1</td> <td>PZ</td> </tr> <tr> <td>0H7085A0</td> <td>LM 600 XC STACKING KIT BACK PROFIL</td> <td>2</td> <td>PZ</td> </tr> <tr> <td>ED1246A0</td> <td>HOT SURFACE LABEL</td> <td>1</td> <td>PZ</td> </tr> <tr> <td>ED1271A0</td> <td>LIQUID FALLS DANGER LABE</td> <td>1</td> <td>PZ</td> </tr> <tr> <td>EL1020A1</td> <td>D8 INTERMEDIAT E T-SHAPED FITTING</td> <td>2</td> <td>PZ</td> </tr> <tr> <td>EL1180A0</td> <td>Ø8-Ø8 FEMALE NON-RETURN CONNECTION</td> <td>2</td> <td>PZ</td> </tr> <tr> <td>GN1508A0</td> <td>O-RING GASKET COD 2400</td> <td>2</td> <td>PZ</td> </tr> <tr> <td>RC1008A0</td> <td>D9 ELASTIC CLIP</td> <td>7</td> <td>PZ</td> </tr> <tr> <td>RC1055A0</td> <td>Ø25-40 H12 STAINLESS STEEL PIPE CLIP</td> <td>10</td> <td>PZ</td> </tr> <tr> <td>RC1297A1</td> <td>D10 T-SHAPED FITTING</td> <td>1</td> <td>PZ</td> </tr> <tr> <td>RC1360A0</td> <td>10 - 10 JG ELBOW FITTIN</td> <td>1</td> <td>PZ</td> </tr> </tbody> </table>	Code	Description	Qty	UOM	0H1237A0	LM TOP SIPHON SUPPORT	2	PZ	0H7084A0	XC651 FRONT STACKING PROFILE	1	PZ	0H7085A0	LM 600 XC STACKING KIT BACK PROFIL	2	PZ	ED1246A0	HOT SURFACE LABEL	1	PZ	ED1271A0	LIQUID FALLS DANGER LABE	1	PZ	EL1020A1	D8 INTERMEDIAT E T-SHAPED FITTING	2	PZ	EL1180A0	Ø8-Ø8 FEMALE NON-RETURN CONNECTION	2	PZ	GN1508A0	O-RING GASKET COD 2400	2	PZ	RC1008A0	D9 ELASTIC CLIP	7	PZ	RC1055A0	Ø25-40 H12 STAINLESS STEEL PIPE CLIP	10	PZ	RC1297A1	D10 T-SHAPED FITTING	1	PZ	RC1360A0	10 - 10 JG ELBOW FITTIN	1	PZ
Code	Description	Qty	UOM																																																			
0H1237A0	LM TOP SIPHON SUPPORT	2	PZ																																																			
0H7084A0	XC651 FRONT STACKING PROFILE	1	PZ																																																			
0H7085A0	LM 600 XC STACKING KIT BACK PROFIL	2	PZ																																																			
ED1246A0	HOT SURFACE LABEL	1	PZ																																																			
ED1271A0	LIQUID FALLS DANGER LABE	1	PZ																																																			
EL1020A1	D8 INTERMEDIAT E T-SHAPED FITTING	2	PZ																																																			
EL1180A0	Ø8-Ø8 FEMALE NON-RETURN CONNECTION	2	PZ																																																			
GN1508A0	O-RING GASKET COD 2400	2	PZ																																																			
RC1008A0	D9 ELASTIC CLIP	7	PZ																																																			
RC1055A0	Ø25-40 H12 STAINLESS STEEL PIPE CLIP	10	PZ																																																			
RC1297A1	D10 T-SHAPED FITTING	1	PZ																																																			
RC1360A0	10 - 10 JG ELBOW FITTIN	1	PZ																																																			





COMPONENT			SPARE PART																																																																																									
Code	Description	Image	Code	Description	Components list																																																																																							
VL1006A	SYPHON COVER		XC653	LINEMISSTOP XFT140 STACKING KIT	<table border="1"> <thead> <tr> <th>Code</th> <th>Description</th> <th>Qty</th> <th>UOM</th> </tr> </thead> <tbody> <tr> <td>RC1376A0</td> <td>Ø6 Y-FITTING</td> <td>1</td> <td>PZ</td> </tr> <tr> <td>TB1177A0</td> <td>FOOT PANEL 40X40 H58 OVERLAP LM</td> <td>4</td> <td>PZ</td> </tr> <tr> <td>TB1520A0</td> <td>INT. Ø=38 TH=4 DRAIN BLACK RUBBER PIPE</td> <td>2.700</td> <td>M</td> </tr> <tr> <td>TB1815A0</td> <td>7,93X4,75 PE TRANSP. PIPE (JG #PE08100N)</td> <td>2</td> <td>M</td> </tr> <tr> <td>TB2243A0</td> <td>Ø10 PET PIPE</td> <td>1.500</td> <td>M</td> </tr> <tr> <td>VI1220A1</td> <td>4,2X12 TCB SELF-TAPPIN G SCREW</td> <td>16</td> <td>PZ</td> </tr> <tr> <td>VI1895A0</td> <td>BLIND NUT M4 STAINLESS STEEL DIN 917</td> <td>8</td> <td>PZ</td> </tr> <tr> <td>VI1945A0</td> <td>ENG-VITE M4X20 TCB+ INOX</td> <td>8</td> <td>PZ</td> </tr> <tr> <td>VI1950A0</td> <td>ST. STEEL 4,2X13 TCB SELF-DRILLIN G SCREW</td> <td>10</td> <td>PZ</td> </tr> <tr> <td>VL1005A1</td> <td>U-TRAP TANK</td> <td>2</td> <td>PZ</td> </tr> <tr> <td>VL1006A0</td> <td>SYPHON COVER</td> <td>2</td> <td>PZ</td> </tr> <tr> <td>VL1046A1</td> <td>D6 PIPE HOLDER - D6 J.G. TERMINAL</td> <td>6</td> <td>PZ</td> </tr> <tr> <td>VL1047A1</td> <td>D6 PIPE HOLDER - D6 J.G. TERMINAL</td> <td>2</td> <td>PZ</td> </tr> <tr> <td>VM1015A1</td> <td>STAINLESS STEEL Ø30X1.5 90° BEND</td> <td>1</td> <td>PZ</td> </tr> <tr> <td>VM1794A0</td> <td>250X4.8 PA66 BLACK CLAMP</td> <td>2</td> <td>PZ</td> </tr> <tr> <td>VM2035A0</td> <td>DRAIN PIPE SUPPORT</td> <td>1</td> <td>PZ</td> </tr> </tbody> </table>	Code	Description	Qty	UOM	RC1376A0	Ø6 Y-FITTING	1	PZ	TB1177A0	FOOT PANEL 40X40 H58 OVERLAP LM	4	PZ	TB1520A0	INT. Ø=38 TH=4 DRAIN BLACK RUBBER PIPE	2.700	M	TB1815A0	7,93X4,75 PE TRANSP. PIPE (JG #PE08100N)	2	M	TB2243A0	Ø10 PET PIPE	1.500	M	VI1220A1	4,2X12 TCB SELF-TAPPIN G SCREW	16	PZ	VI1895A0	BLIND NUT M4 STAINLESS STEEL DIN 917	8	PZ	VI1945A0	ENG-VITE M4X20 TCB+ INOX	8	PZ	VI1950A0	ST. STEEL 4,2X13 TCB SELF-DRILLIN G SCREW	10	PZ	VL1005A1	U-TRAP TANK	2	PZ	VL1006A0	SYPHON COVER	2	PZ	VL1046A1	D6 PIPE HOLDER - D6 J.G. TERMINAL	6	PZ	VL1047A1	D6 PIPE HOLDER - D6 J.G. TERMINAL	2	PZ	VM1015A1	STAINLESS STEEL Ø30X1.5 90° BEND	1	PZ	VM1794A0	250X4.8 PA66 BLACK CLAMP	2	PZ	VM2035A0	DRAIN PIPE SUPPORT	1	PZ	XC649	LINEMISS TOP FULL SIZE STACKING KIT	<table border="1"> <thead> <tr> <th>Code</th> <th>Description</th> <th>Qty</th> <th>UOM</th> </tr> </thead> <tbody> <tr> <td>0H1151A0</td> <td>PROOFER-OV EN FIXING BRACKET</td> <td>4</td> <td>PZ</td> </tr> <tr> <td>0H1237A0</td> <td>LM TOP SIPHON SUPPORT</td> <td>2</td> <td>PZ</td> </tr> <tr> <td>ED1335A0</td> <td>CAUTION HOT TRIANGLE LABEL</td> <td>1</td> <td>PZ</td> </tr> </tbody> </table>	Code	Description	Qty	UOM	0H1151A0	PROOFER-OV EN FIXING BRACKET	4	PZ	0H1237A0	LM TOP SIPHON SUPPORT	2	PZ	ED1335A0	CAUTION HOT TRIANGLE LABEL	1	PZ
			Code	Description	Qty	UOM																																																																																						
RC1376A0	Ø6 Y-FITTING	1	PZ																																																																																									
TB1177A0	FOOT PANEL 40X40 H58 OVERLAP LM	4	PZ																																																																																									
TB1520A0	INT. Ø=38 TH=4 DRAIN BLACK RUBBER PIPE	2.700	M																																																																																									
TB1815A0	7,93X4,75 PE TRANSP. PIPE (JG #PE08100N)	2	M																																																																																									
TB2243A0	Ø10 PET PIPE	1.500	M																																																																																									
VI1220A1	4,2X12 TCB SELF-TAPPIN G SCREW	16	PZ																																																																																									
VI1895A0	BLIND NUT M4 STAINLESS STEEL DIN 917	8	PZ																																																																																									
VI1945A0	ENG-VITE M4X20 TCB+ INOX	8	PZ																																																																																									
VI1950A0	ST. STEEL 4,2X13 TCB SELF-DRILLIN G SCREW	10	PZ																																																																																									
VL1005A1	U-TRAP TANK	2	PZ																																																																																									
VL1006A0	SYPHON COVER	2	PZ																																																																																									
VL1046A1	D6 PIPE HOLDER - D6 J.G. TERMINAL	6	PZ																																																																																									
VL1047A1	D6 PIPE HOLDER - D6 J.G. TERMINAL	2	PZ																																																																																									
VM1015A1	STAINLESS STEEL Ø30X1.5 90° BEND	1	PZ																																																																																									
VM1794A0	250X4.8 PA66 BLACK CLAMP	2	PZ																																																																																									
VM2035A0	DRAIN PIPE SUPPORT	1	PZ																																																																																									
Code	Description	Qty	UOM																																																																																									
0H1151A0	PROOFER-OV EN FIXING BRACKET	4	PZ																																																																																									
0H1237A0	LM TOP SIPHON SUPPORT	2	PZ																																																																																									
ED1335A0	CAUTION HOT TRIANGLE LABEL	1	PZ																																																																																									

COMPONENT			SPARE PART																																																																																										
Code	Description	Image	Code	Description	Components list																																																																																								
VL1006A	SYPHON COVER		XC649	LINEMISS TOP FULL SIZE STACKING KIT	<table border="1"> <thead> <tr> <th>Code</th> <th>Description</th> <th>Qty</th> <th>UOM</th> </tr> </thead> <tbody> <tr> <td>ED1338A0</td> <td>UL LIQUID FALLS DANGER LABE</td> <td>1</td> <td>PZ</td> </tr> <tr> <td>EL1020A1</td> <td>D8 INTERMEDIAT E T-SHAPED FITTING</td> <td>2</td> <td>PZ</td> </tr> <tr> <td>EL1185A0</td> <td>Ø8F - Ø8F ELBOW CONNECTION</td> <td>2</td> <td>PZ</td> </tr> <tr> <td>GN1508A0</td> <td>O-RING GASKET COD 2400</td> <td>2</td> <td>PZ</td> </tr> <tr> <td>RC1008A0</td> <td>D9 ELASTIC CLIP</td> <td>3</td> <td>PZ</td> </tr> <tr> <td>RC1055A0</td> <td>Ø25-40 H12 STAINLESS STEEL PIPE CLIP</td> <td>8</td> <td>PZ</td> </tr> <tr> <td>RC1297A1</td> <td>D10 T-SHAPED FITTING</td> <td>1</td> <td>PZ</td> </tr> <tr> <td>RC1360A0</td> <td>10 - 10 JG ELBOW FITTING</td> <td>1</td> <td>PZ</td> </tr> <tr> <td>RC1376A0</td> <td>Ø6 Y-FITTING</td> <td>1</td> <td>PZ</td> </tr> <tr> <td>TB1520A0</td> <td>INT. Ø=38 TH=4 DRAIN BLACK RUBBER PIPE</td> <td>2.840</td> <td>M</td> </tr> <tr> <td>TB1815A0</td> <td>7,93X4,75 PE TRANSP. PIPE (JG #PE08100N)</td> <td>2</td> <td>M</td> </tr> <tr> <td>TB2243A0</td> <td>Ø10 PET PIPE</td> <td>1.500</td> <td>M</td> </tr> <tr> <td>VI1220A1</td> <td>4,2X12 TCB SELF-TAPPIN G SCREW</td> <td>7</td> <td>PZ</td> </tr> <tr> <td>VI1895A0</td> <td>BLIND NUT M4 STAINLESS STEEL DIN 917</td> <td>8</td> <td>PZ</td> </tr> <tr> <td>VI1945A0</td> <td>ENG-VITE M4X20 TCB+ INOX</td> <td>8</td> <td>PZ</td> </tr> <tr> <td>VI1950A0</td> <td>ST. STEEL 4,2X13 TCB SELF-DRILLIN G SCREW</td> <td>6</td> <td>PZ</td> </tr> <tr> <td>VL1005A1</td> <td>U-TRAP TANK</td> <td>2</td> <td>PZ</td> </tr> <tr> <td>VL1006A0</td> <td>SYPHON COVER</td> <td>2</td> <td>PZ</td> </tr> <tr> <td>VL1046A1</td> <td>D6 PIPE HOLDER - D6 J.G. TERMINAL</td> <td>3</td> <td>PZ</td> </tr> <tr> <td>VM1794A0</td> <td>250X4.8 PA66 BLACK CLAMP</td> <td>2</td> <td>PZ</td> </tr> <tr> <td>VM2035A0</td> <td>DRAIN PIPE SUPPORT</td> <td>1</td> <td>PZ</td> </tr> </tbody> </table>	Code	Description	Qty	UOM	ED1338A0	UL LIQUID FALLS DANGER LABE	1	PZ	EL1020A1	D8 INTERMEDIAT E T-SHAPED FITTING	2	PZ	EL1185A0	Ø8F - Ø8F ELBOW CONNECTION	2	PZ	GN1508A0	O-RING GASKET COD 2400	2	PZ	RC1008A0	D9 ELASTIC CLIP	3	PZ	RC1055A0	Ø25-40 H12 STAINLESS STEEL PIPE CLIP	8	PZ	RC1297A1	D10 T-SHAPED FITTING	1	PZ	RC1360A0	10 - 10 JG ELBOW FITTING	1	PZ	RC1376A0	Ø6 Y-FITTING	1	PZ	TB1520A0	INT. Ø=38 TH=4 DRAIN BLACK RUBBER PIPE	2.840	M	TB1815A0	7,93X4,75 PE TRANSP. PIPE (JG #PE08100N)	2	M	TB2243A0	Ø10 PET PIPE	1.500	M	VI1220A1	4,2X12 TCB SELF-TAPPIN G SCREW	7	PZ	VI1895A0	BLIND NUT M4 STAINLESS STEEL DIN 917	8	PZ	VI1945A0	ENG-VITE M4X20 TCB+ INOX	8	PZ	VI1950A0	ST. STEEL 4,2X13 TCB SELF-DRILLIN G SCREW	6	PZ	VL1005A1	U-TRAP TANK	2	PZ	VL1006A0	SYPHON COVER	2	PZ	VL1046A1	D6 PIPE HOLDER - D6 J.G. TERMINAL	3	PZ	VM1794A0	250X4.8 PA66 BLACK CLAMP	2	PZ	VM2035A0	DRAIN PIPE SUPPORT	1	PZ
Code	Description	Qty	UOM																																																																																										
ED1338A0	UL LIQUID FALLS DANGER LABE	1	PZ																																																																																										
EL1020A1	D8 INTERMEDIAT E T-SHAPED FITTING	2	PZ																																																																																										
EL1185A0	Ø8F - Ø8F ELBOW CONNECTION	2	PZ																																																																																										
GN1508A0	O-RING GASKET COD 2400	2	PZ																																																																																										
RC1008A0	D9 ELASTIC CLIP	3	PZ																																																																																										
RC1055A0	Ø25-40 H12 STAINLESS STEEL PIPE CLIP	8	PZ																																																																																										
RC1297A1	D10 T-SHAPED FITTING	1	PZ																																																																																										
RC1360A0	10 - 10 JG ELBOW FITTING	1	PZ																																																																																										
RC1376A0	Ø6 Y-FITTING	1	PZ																																																																																										
TB1520A0	INT. Ø=38 TH=4 DRAIN BLACK RUBBER PIPE	2.840	M																																																																																										
TB1815A0	7,93X4,75 PE TRANSP. PIPE (JG #PE08100N)	2	M																																																																																										
TB2243A0	Ø10 PET PIPE	1.500	M																																																																																										
VI1220A1	4,2X12 TCB SELF-TAPPIN G SCREW	7	PZ																																																																																										
VI1895A0	BLIND NUT M4 STAINLESS STEEL DIN 917	8	PZ																																																																																										
VI1945A0	ENG-VITE M4X20 TCB+ INOX	8	PZ																																																																																										
VI1950A0	ST. STEEL 4,2X13 TCB SELF-DRILLIN G SCREW	6	PZ																																																																																										
VL1005A1	U-TRAP TANK	2	PZ																																																																																										
VL1006A0	SYPHON COVER	2	PZ																																																																																										
VL1046A1	D6 PIPE HOLDER - D6 J.G. TERMINAL	3	PZ																																																																																										
VM1794A0	250X4.8 PA66 BLACK CLAMP	2	PZ																																																																																										
VM2035A0	DRAIN PIPE SUPPORT	1	PZ																																																																																										

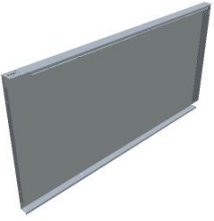

COMPONENT			SPARE PART																																																																																		
Code	Description	Image	Code	Description	Components list																																																																																
VL1006A	SYPHON COVER		XC648	LINEMISS TOP XFT200 STACKING KIT	<table border="1"> <thead> <tr> <th>Code</th> <th>Description</th> <th>Qty</th> <th>UOM</th> </tr> </thead> <tbody> <tr> <td>0H1237A0</td> <td>LM TOP SIPHON SUPPORT</td> <td>2</td> <td>PZ</td> </tr> <tr> <td>0H7082A0</td> <td>LM 800 XC STACKING KIT FRONT PROFILE</td> <td>1</td> <td>PZ</td> </tr> <tr> <td>0H7083A0</td> <td>LM 800 XC STACKING KIT BACK PROFIL</td> <td>2</td> <td>PZ</td> </tr> <tr> <td>ED1246A0</td> <td>HOT SURFACE LABEL</td> <td>1</td> <td>PZ</td> </tr> <tr> <td>ED1271A0</td> <td>LIQUID FALLS DANGER LABE</td> <td>1</td> <td>PZ</td> </tr> <tr> <td>EL1020A1</td> <td>D8 INTERMEDIAT E T-SHAPED FITTING</td> <td>2</td> <td>PZ</td> </tr> <tr> <td>EL1180A0</td> <td>Ø8-Ø8 FEMALE NON-RETURN CONNECTION</td> <td>2</td> <td>PZ</td> </tr> <tr> <td>GN1508A0</td> <td>O-RING GASKET COD 2400</td> <td>2</td> <td>PZ</td> </tr> <tr> <td>RC1008A0</td> <td>D9 ELASTIC CLIP</td> <td>7</td> <td>PZ</td> </tr> <tr> <td>RC1055A0</td> <td>Ø25-40 H12 STAINLESS STEEL PIPE CLIP</td> <td>10</td> <td>PZ</td> </tr> <tr> <td>RC1297A1</td> <td>D10 T-SHAPED FITTING</td> <td>1</td> <td>PZ</td> </tr> <tr> <td>RC1360A0</td> <td>10 - 10 JG ELBOW FITTIN</td> <td>1</td> <td>PZ</td> </tr> <tr> <td>RC1376A0</td> <td>Ø6 Y-FITTING</td> <td>1</td> <td>PZ</td> </tr> <tr> <td>TB1177A0</td> <td>FOOT PANEL 40X40 H58 OVERLAP LM</td> <td>4</td> <td>PZ</td> </tr> <tr> <td>TB1520A0</td> <td>INT. Ø=38 TH=4 DRAIN BLACK RUBBER PIPE</td> <td>2.700</td> <td>M</td> </tr> <tr> <td>TB1815A0</td> <td>7,93X4,75 PE TRANSP. PIPE (JG #PE08100N)</td> <td>2</td> <td>M</td> </tr> <tr> <td>TB2243A0</td> <td>Ø10 PET PIPE</td> <td>1.500</td> <td>M</td> </tr> <tr> <td>VI1220A1</td> <td>4,2X12 TCB SELF-TAPPIN G SCREW</td> <td>16</td> <td>PZ</td> </tr> <tr> <td>VI1895A0</td> <td>BLIND NUT M4 STAINLESS STEEL DIN 917</td> <td>8</td> <td>PZ</td> </tr> </tbody> </table>	Code	Description	Qty	UOM	0H1237A0	LM TOP SIPHON SUPPORT	2	PZ	0H7082A0	LM 800 XC STACKING KIT FRONT PROFILE	1	PZ	0H7083A0	LM 800 XC STACKING KIT BACK PROFIL	2	PZ	ED1246A0	HOT SURFACE LABEL	1	PZ	ED1271A0	LIQUID FALLS DANGER LABE	1	PZ	EL1020A1	D8 INTERMEDIAT E T-SHAPED FITTING	2	PZ	EL1180A0	Ø8-Ø8 FEMALE NON-RETURN CONNECTION	2	PZ	GN1508A0	O-RING GASKET COD 2400	2	PZ	RC1008A0	D9 ELASTIC CLIP	7	PZ	RC1055A0	Ø25-40 H12 STAINLESS STEEL PIPE CLIP	10	PZ	RC1297A1	D10 T-SHAPED FITTING	1	PZ	RC1360A0	10 - 10 JG ELBOW FITTIN	1	PZ	RC1376A0	Ø6 Y-FITTING	1	PZ	TB1177A0	FOOT PANEL 40X40 H58 OVERLAP LM	4	PZ	TB1520A0	INT. Ø=38 TH=4 DRAIN BLACK RUBBER PIPE	2.700	M	TB1815A0	7,93X4,75 PE TRANSP. PIPE (JG #PE08100N)	2	M	TB2243A0	Ø10 PET PIPE	1.500	M	VI1220A1	4,2X12 TCB SELF-TAPPIN G SCREW	16	PZ	VI1895A0	BLIND NUT M4 STAINLESS STEEL DIN 917	8	PZ
Code	Description	Qty	UOM																																																																																		
0H1237A0	LM TOP SIPHON SUPPORT	2	PZ																																																																																		
0H7082A0	LM 800 XC STACKING KIT FRONT PROFILE	1	PZ																																																																																		
0H7083A0	LM 800 XC STACKING KIT BACK PROFIL	2	PZ																																																																																		
ED1246A0	HOT SURFACE LABEL	1	PZ																																																																																		
ED1271A0	LIQUID FALLS DANGER LABE	1	PZ																																																																																		
EL1020A1	D8 INTERMEDIAT E T-SHAPED FITTING	2	PZ																																																																																		
EL1180A0	Ø8-Ø8 FEMALE NON-RETURN CONNECTION	2	PZ																																																																																		
GN1508A0	O-RING GASKET COD 2400	2	PZ																																																																																		
RC1008A0	D9 ELASTIC CLIP	7	PZ																																																																																		
RC1055A0	Ø25-40 H12 STAINLESS STEEL PIPE CLIP	10	PZ																																																																																		
RC1297A1	D10 T-SHAPED FITTING	1	PZ																																																																																		
RC1360A0	10 - 10 JG ELBOW FITTIN	1	PZ																																																																																		
RC1376A0	Ø6 Y-FITTING	1	PZ																																																																																		
TB1177A0	FOOT PANEL 40X40 H58 OVERLAP LM	4	PZ																																																																																		
TB1520A0	INT. Ø=38 TH=4 DRAIN BLACK RUBBER PIPE	2.700	M																																																																																		
TB1815A0	7,93X4,75 PE TRANSP. PIPE (JG #PE08100N)	2	M																																																																																		
TB2243A0	Ø10 PET PIPE	1.500	M																																																																																		
VI1220A1	4,2X12 TCB SELF-TAPPIN G SCREW	16	PZ																																																																																		
VI1895A0	BLIND NUT M4 STAINLESS STEEL DIN 917	8	PZ																																																																																		

COMPONENT			SPARE PART																																										
Code	Description	Image	Code	Description	Components list																																								
VL1006A	SYPHON COVER		XC648	LINEMISS TOP XFT200 STACKING KIT	<table border="1"> <thead> <tr> <th>Code</th> <th>Description</th> <th>Qty</th> <th>UOM</th> </tr> </thead> <tbody> <tr> <td>VI1945A0</td> <td>ENG-VITE M4X20 TCB+ INOX</td> <td>8</td> <td>PZ</td> </tr> <tr> <td>VI1950A0</td> <td>ST. STEEL 4,2X13 TCB SELF-DRILLIN G SCREW</td> <td>10</td> <td>PZ</td> </tr> <tr> <td>VL1005A1</td> <td>U-TRAP TANK</td> <td>2</td> <td>PZ</td> </tr> <tr> <td>VL1006A0</td> <td>SYPHON COVER</td> <td>2</td> <td>PZ</td> </tr> <tr> <td>VL1046A1</td> <td>D6 PIPE HOLDER - D6 J.G. TERMINAL</td> <td>6</td> <td>PZ</td> </tr> <tr> <td>VL1047A1</td> <td>D6 PIPE HOLDER - D8 J.G. TERMINAL</td> <td>4</td> <td>PZ</td> </tr> <tr> <td>VM1015A1</td> <td>STAINLESS STEEL Ø30X1.5 90° BEND</td> <td>1</td> <td>PZ</td> </tr> <tr> <td>VM1794A0</td> <td>250X4.8 PA66 BLACK CLAMP</td> <td>2</td> <td>PZ</td> </tr> <tr> <td>VM2035A0</td> <td>DRAIN PIPE SUPPORT</td> <td>1</td> <td>PZ</td> </tr> </tbody> </table>	Code	Description	Qty	UOM	VI1945A0	ENG-VITE M4X20 TCB+ INOX	8	PZ	VI1950A0	ST. STEEL 4,2X13 TCB SELF-DRILLIN G SCREW	10	PZ	VL1005A1	U-TRAP TANK	2	PZ	VL1006A0	SYPHON COVER	2	PZ	VL1046A1	D6 PIPE HOLDER - D6 J.G. TERMINAL	6	PZ	VL1047A1	D6 PIPE HOLDER - D8 J.G. TERMINAL	4	PZ	VM1015A1	STAINLESS STEEL Ø30X1.5 90° BEND	1	PZ	VM1794A0	250X4.8 PA66 BLACK CLAMP	2	PZ	VM2035A0	DRAIN PIPE SUPPORT	1	PZ
Code	Description	Qty	UOM																																										
VI1945A0	ENG-VITE M4X20 TCB+ INOX	8	PZ																																										
VI1950A0	ST. STEEL 4,2X13 TCB SELF-DRILLIN G SCREW	10	PZ																																										
VL1005A1	U-TRAP TANK	2	PZ																																										
VL1006A0	SYPHON COVER	2	PZ																																										
VL1046A1	D6 PIPE HOLDER - D6 J.G. TERMINAL	6	PZ																																										
VL1047A1	D6 PIPE HOLDER - D8 J.G. TERMINAL	4	PZ																																										
VM1015A1	STAINLESS STEEL Ø30X1.5 90° BEND	1	PZ																																										
VM1794A0	250X4.8 PA66 BLACK CLAMP	2	PZ																																										
VM2035A0	DRAIN PIPE SUPPORT	1	PZ																																										
VM2036A	DRAIN WATER PIPE SUPPORT		KVM2036A	DRAIN WATER PIPE SUPPORT KIT	<table border="1"> <thead> <tr> <th>Code</th> <th>Description</th> <th>Qty</th> <th>UOM</th> </tr> </thead> <tbody> <tr> <td>VI1220A1</td> <td>4,2X12 TCB SELF-TAPPIN G SCREW</td> <td>2</td> <td>PZ</td> </tr> <tr> <td>VM2036A0</td> <td>DRAIN WATER PIPE SUPPOR</td> <td>2</td> <td>PZ</td> </tr> </tbody> </table>	Code	Description	Qty	UOM	VI1220A1	4,2X12 TCB SELF-TAPPIN G SCREW	2	PZ	VM2036A0	DRAIN WATER PIPE SUPPOR	2	PZ																												
Code	Description	Qty	UOM																																										
VI1220A1	4,2X12 TCB SELF-TAPPIN G SCREW	2	PZ																																										
VM2036A0	DRAIN WATER PIPE SUPPOR	2	PZ																																										
TB2939A	XEVC-2011 WATER DRAIN PIPE		TB2939A0	XEVC-2011 WATER DRAIN PIPE																																									







COMPONENT			SPARE PART																						
Code	Description	Image	Code	Description	Components list																				
0H6567A	P-TRAP HOLDING PANEL		0H6567A0	P-TRAP HOLDING PANEL																					
0D2312A	XEVC-2011 LEFT SIDE PANEL		0D2312A0	XEVC-2011 LEFT SIDE PANEL																					
VE1295A	MK 16A 230V DOOR MICROSWITCH		KVE1295A	16A 230V DOOR MICROSWITCH KIT	<table border="1"> <thead> <tr> <th>Code</th> <th>Description</th> <th>Qty</th> <th>UOM</th> </tr> </thead> <tbody> <tr> <td>VE1295A0</td> <td>MK 16A 230V DOOR MICROSWITC</td> <td>1</td> <td>PZ</td> </tr> </tbody> </table>	Code	Description	Qty	UOM	VE1295A0	MK 16A 230V DOOR MICROSWITC	1	PZ												
Code	Description	Qty	UOM																						
VE1295A0	MK 16A 230V DOOR MICROSWITC	1	PZ																						
SB1015A	4L DETERGENT TAN		KSB1015A	4L DETERGENT TANK KIT	<table border="1"> <thead> <tr> <th>Code</th> <th>Description</th> <th>Qty</th> <th>UOM</th> </tr> </thead> <tbody> <tr> <td>IP1385A1</td> <td>CORNER POLYSTYREN E PACKING 110X80X2000</td> <td>1.200</td> <td>M</td> </tr> <tr> <td>IP1410A0</td> <td>POLYSTYREN E PACKING TO PROTECT</td> <td>2</td> <td>PZ</td> </tr> <tr> <td>SB1015A2</td> <td>4L DETERGENT TANK</td> <td>1</td> <td>PZ</td> </tr> <tr> <td>VM1059A1</td> <td>HEAT SHRINK FILM H800</td> <td>1.200</td> <td>M</td> </tr> </tbody> </table>	Code	Description	Qty	UOM	IP1385A1	CORNER POLYSTYREN E PACKING 110X80X2000	1.200	M	IP1410A0	POLYSTYREN E PACKING TO PROTECT	2	PZ	SB1015A2	4L DETERGENT TANK	1	PZ	VM1059A1	HEAT SHRINK FILM H800	1.200	M
Code	Description	Qty	UOM																						
IP1385A1	CORNER POLYSTYREN E PACKING 110X80X2000	1.200	M																						
IP1410A0	POLYSTYREN E PACKING TO PROTECT	2	PZ																						
SB1015A2	4L DETERGENT TANK	1	PZ																						
VM1059A1	HEAT SHRINK FILM H800	1.200	M																						
0D2314A	XEVC-2011-E EXTERNAL TOP COVER		0D2314A0	XEVC-2011-E EXTERNAL TOP COVER																					



COMPONENT			SPARE PART																																		
Code	Description	Image	Code	Description	Components list																																
VM1240A	NYLON SUPPORT CAP		KVM1240A	4 PCS COUNTER BRACKET SUPPORT CAP KIT	<table border="1"> <thead> <tr> <th>Code</th> <th>Description</th> <th>Qty</th> <th>UOM</th> </tr> </thead> <tbody> <tr> <td>VM1240A0</td> <td>NYLON SUPPORT CAP</td> <td>4</td> <td>PZ</td> </tr> </tbody> </table>	Code	Description	Qty	UOM	VM1240A0	NYLON SUPPORT CAP	4	PZ																								
Code	Description	Qty	UOM																																		
VM1240A0	NYLON SUPPORT CAP	4	PZ																																		
VM2282A	MICROSWITCH SUPPORT COVER		KVM2282A	MICROSWITCH SUPPORT PLATE KI	<table border="1"> <thead> <tr> <th>Code</th> <th>Description</th> <th>Qty</th> <th>UOM</th> </tr> </thead> <tbody> <tr> <td>VM2282A0</td> <td>MICROSWITCH SUPPORT COVER</td> <td>1</td> <td>PZ</td> </tr> </tbody> </table>	Code	Description	Qty	UOM	VM2282A0	MICROSWITCH SUPPORT COVER	1	PZ																								
Code	Description	Qty	UOM																																		
VM2282A0	MICROSWITCH SUPPORT COVER	1	PZ																																		
VE1020B	MAGNET DOOR MICROSWITCH		KVE1020B	MICROSWITCH KIT	<table border="1"> <thead> <tr> <th>Code</th> <th>Description</th> <th>Qty</th> <th>UOM</th> </tr> </thead> <tbody> <tr> <td>CE1030A0</td> <td>FEMALE FASTON COVER 6.3X0.8 0,5-1MMQ</td> <td>2</td> <td>PZ</td> </tr> <tr> <td>CE1660A0</td> <td>6,3X0,8 FEMALE FASTON COVER</td> <td>2</td> <td>PZ</td> </tr> <tr> <td>CE1730A0</td> <td>PVC CABLE NP 2 X AWG22 STYLE 2095</td> <td>0.150</td> <td>M</td> </tr> <tr> <td>CE1740A0</td> <td>MINIFIT MALE END FITTING</td> <td>2</td> <td>PZ</td> </tr> <tr> <td>CE1745A0</td> <td>2 WAYS FEMALE MINIFIT CONNECTOR</td> <td>1</td> <td>PZ</td> </tr> <tr> <td>VE1020B0</td> <td>MAGNET DOOR MICROSWITCH</td> <td>1</td> <td>PZ</td> </tr> <tr> <td>VE1030A1</td> <td>MAGNET FOR DOOR MICROSWITCH H D=22,9MM</td> <td>1</td> <td>PZ</td> </tr> </tbody> </table>	Code	Description	Qty	UOM	CE1030A0	FEMALE FASTON COVER 6.3X0.8 0,5-1MMQ	2	PZ	CE1660A0	6,3X0,8 FEMALE FASTON COVER	2	PZ	CE1730A0	PVC CABLE NP 2 X AWG22 STYLE 2095	0.150	M	CE1740A0	MINIFIT MALE END FITTING	2	PZ	CE1745A0	2 WAYS FEMALE MINIFIT CONNECTOR	1	PZ	VE1020B0	MAGNET DOOR MICROSWITCH	1	PZ	VE1030A1	MAGNET FOR DOOR MICROSWITCH H D=22,9MM	1	PZ
Code	Description	Qty	UOM																																		
CE1030A0	FEMALE FASTON COVER 6.3X0.8 0,5-1MMQ	2	PZ																																		
CE1660A0	6,3X0,8 FEMALE FASTON COVER	2	PZ																																		
CE1730A0	PVC CABLE NP 2 X AWG22 STYLE 2095	0.150	M																																		
CE1740A0	MINIFIT MALE END FITTING	2	PZ																																		
CE1745A0	2 WAYS FEMALE MINIFIT CONNECTOR	1	PZ																																		
VE1020B0	MAGNET DOOR MICROSWITCH	1	PZ																																		
VE1030A1	MAGNET FOR DOOR MICROSWITCH H D=22,9MM	1	PZ																																		
0H2561A	6 S. DOOR COUNTERBRACKET		0H2561A0	6 S. DOOR COUNTERBRACKET																																	





COMPONENT			SPARE PART																						
Code	Description	Image	Code	Description	Components list																				
VI1995A	M5X25 ST.STEEL SCREW		VI1995A0	M5X25 ST.STEEL SCREW																					
VM2352A	LOWER DOOR BRACKET SCREW LEFT COVER		VM2352A0	LOWER DOOR BRACKET SCREW LEFT COVER																					
VM2353A	LOWER DOOR BRACKET SCREW RIGHT COVER		VM2353A0	LOWER DOOR BRACKET SCREW RIGHT COVER																					
VM1240A	NYLON SUPPORT CAP		KVM1240A	4 PCS COUNTER BRACKET SUPPORT CAP KIT	<table border="1"> <thead> <tr> <th>Code</th> <th>Description</th> <th>Qty</th> <th>UOM</th> </tr> </thead> <tbody> <tr> <td>VM1240A0</td> <td>NYLON SUPPORT CAP</td> <td>4</td> <td>PZ</td> </tr> </tbody> </table>	Code	Description	Qty	UOM	VM1240A0	NYLON SUPPORT CAP	4	PZ												
Code	Description	Qty	UOM																						
VM1240A0	NYLON SUPPORT CAP	4	PZ																						
VM2273A	6 S. LEFT LOWER DOOR BRACKET		KVM2273A	MIND.MAPS DOOR LOWER LEFT BRACKET KIT	<table border="1"> <thead> <tr> <th>Code</th> <th>Description</th> <th>Qty</th> <th>UOM</th> </tr> </thead> <tbody> <tr> <td>0H7330A0</td> <td>DOOR LOWER BRACKET WASHER</td> <td>2</td> <td>PZ</td> </tr> <tr> <td>VI1995A0</td> <td>M5X25 ST.STEEL SCREW</td> <td>4</td> <td>PZ</td> </tr> <tr> <td>VM2273A1</td> <td>MM LEFT INFERIOR BRACKET DOOR</td> <td>1</td> <td>PZ</td> </tr> <tr> <td>VM2352A0</td> <td>LOWER DOOR BRACKET SCREW LEFT COVER</td> <td>1</td> <td>PZ</td> </tr> </tbody> </table>	Code	Description	Qty	UOM	0H7330A0	DOOR LOWER BRACKET WASHER	2	PZ	VI1995A0	M5X25 ST.STEEL SCREW	4	PZ	VM2273A1	MM LEFT INFERIOR BRACKET DOOR	1	PZ	VM2352A0	LOWER DOOR BRACKET SCREW LEFT COVER	1	PZ
Code	Description	Qty	UOM																						
0H7330A0	DOOR LOWER BRACKET WASHER	2	PZ																						
VI1995A0	M5X25 ST.STEEL SCREW	4	PZ																						
VM2273A1	MM LEFT INFERIOR BRACKET DOOR	1	PZ																						
VM2352A0	LOWER DOOR BRACKET SCREW LEFT COVER	1	PZ																						



COMPONENT			SPARE PART																		
Code	Description	Image	Code	Description	Components list																
VM2273A	6 S. LEFT LOWER DOOR BRACKET		KVM2273A	MIND.MAPS DOOR LOWER LEFT BRACKET KIT	<table border="1"> <thead> <tr> <th>Code</th> <th>Description</th> <th>Qty</th> <th>UOM</th> </tr> </thead> <tbody> <tr> <td>VM2352A0</td> <td>LOWER DOOR BRACKET SCREW LEFT COVER</td> <td>1</td> <td>PZ</td> </tr> <tr> <td>VM2353A0</td> <td>LOWER DOOR BRACKET SCREW RIGHT COVER</td> <td>1</td> <td>PZ</td> </tr> <tr> <td>VM2353A0</td> <td>LOWER DOOR BRACKET SCREW RIGHT COVER</td> <td>1</td> <td>PZ</td> </tr> </tbody> </table>	Code	Description	Qty	UOM	VM2352A0	LOWER DOOR BRACKET SCREW LEFT COVER	1	PZ	VM2353A0	LOWER DOOR BRACKET SCREW RIGHT COVER	1	PZ	VM2353A0	LOWER DOOR BRACKET SCREW RIGHT COVER	1	PZ
Code	Description	Qty	UOM																		
VM2352A0	LOWER DOOR BRACKET SCREW LEFT COVER	1	PZ																		
VM2353A0	LOWER DOOR BRACKET SCREW RIGHT COVER	1	PZ																		
VM2353A0	LOWER DOOR BRACKET SCREW RIGHT COVER	1	PZ																		
0H2561A	6 S. DOOR COUNTERBRACKET		0H2561A0	6 S. DOOR COUNTERBRACKET																	
VI1995A	M5X25 ST.STEEL SCREW		VI1995A0	M5X25 ST.STEEL SCREW																	
VM1240A	NYLON SUPPORT CAP		KVM1240A	4 PCS COUNTER BRACKET SUPPORT CAP KIT	<table border="1"> <thead> <tr> <th>Code</th> <th>Description</th> <th>Qty</th> <th>UOM</th> </tr> </thead> <tbody> <tr> <td>VM1240A0</td> <td>NYLON SUPPORT CAP</td> <td>4</td> <td>PZ</td> </tr> </tbody> </table>	Code	Description	Qty	UOM	VM1240A0	NYLON SUPPORT CAP	4	PZ								
Code	Description	Qty	UOM																		
VM1240A0	NYLON SUPPORT CAP	4	PZ																		
VM2298A	DOOR BRACKET UPPER COVER		KVM2298A	MIND.MAPS DOOR UPPER BRACKET COVER KIT	<table border="1"> <thead> <tr> <th>Code</th> <th>Description</th> <th>Qty</th> <th>UOM</th> </tr> </thead> <tbody> <tr> <td>VI1220A0</td> <td>SELF-TAPPIN G SCREW 4,2X12 TCB</td> <td>2</td> <td>PZ</td> </tr> <tr> <td>VM2298A0</td> <td>DOOR BRACKET UPPER COVER</td> <td>1</td> <td>PZ</td> </tr> </tbody> </table>	Code	Description	Qty	UOM	VI1220A0	SELF-TAPPIN G SCREW 4,2X12 TCB	2	PZ	VM2298A0	DOOR BRACKET UPPER COVER	1	PZ				
Code	Description	Qty	UOM																		
VI1220A0	SELF-TAPPIN G SCREW 4,2X12 TCB	2	PZ																		
VM2298A0	DOOR BRACKET UPPER COVER	1	PZ																		

COMPONENT			SPARE PART																										
Code	Description	Image	Code	Description	Components list																								
VM2271A	LEFT DOOR UPPER BRACKET		KVM2271A	MIND.MAPS UPPER LEFT DOOR BRACKET KIT	<table border="1"> <thead> <tr> <th>Code</th> <th>Description</th> <th>Qty</th> <th>UOM</th> </tr> </thead> <tbody> <tr> <td>VI1220A1</td> <td>4,2X12 TCB SELF-TAPPING SCREW</td> <td>2</td> <td>PZ</td> </tr> <tr> <td>VI1995A0</td> <td>M5X25 ST.STEEL SCREW</td> <td>4</td> <td>PZ</td> </tr> <tr> <td>VI1997A0</td> <td>5X10X1 FLAT WASHER</td> <td>4</td> <td>PZ</td> </tr> <tr> <td>VM2271A0</td> <td>LEFT DOOR UPPER BRACKET</td> <td>1</td> <td>PZ</td> </tr> <tr> <td>VM2298A0</td> <td>DOOR BRACKET UPPER COVER</td> <td>1</td> <td>PZ</td> </tr> </tbody> </table>	Code	Description	Qty	UOM	VI1220A1	4,2X12 TCB SELF-TAPPING SCREW	2	PZ	VI1995A0	M5X25 ST.STEEL SCREW	4	PZ	VI1997A0	5X10X1 FLAT WASHER	4	PZ	VM2271A0	LEFT DOOR UPPER BRACKET	1	PZ	VM2298A0	DOOR BRACKET UPPER COVER	1	PZ
Code	Description	Qty	UOM																										
VI1220A1	4,2X12 TCB SELF-TAPPING SCREW	2	PZ																										
VI1995A0	M5X25 ST.STEEL SCREW	4	PZ																										
VI1997A0	5X10X1 FLAT WASHER	4	PZ																										
VM2271A0	LEFT DOOR UPPER BRACKET	1	PZ																										
VM2298A0	DOOR BRACKET UPPER COVER	1	PZ																										
RC1365A	3/4"-10 JG FEMALE CONNECTION		KRC1365A	3/4"-10 OR 8 JG WATER CONNECTION KIT	<table border="1"> <thead> <tr> <th>Code</th> <th>Description</th> <th>Qty</th> <th>UOM</th> </tr> </thead> <tbody> <tr> <td>GN1200A1</td> <td>3/4 CONNECTION SEAL D=24 RUBBER+NET</td> <td>1</td> <td>PZ</td> </tr> <tr> <td>RC1002A0</td> <td>JG 10M-8F TERMINAL REDUCTION FITTING</td> <td>1</td> <td>PZ</td> </tr> <tr> <td>RC1365A0</td> <td>3/4"-10 JG FEMALE CONNECTION</td> <td>1</td> <td>PZ</td> </tr> </tbody> </table>	Code	Description	Qty	UOM	GN1200A1	3/4 CONNECTION SEAL D=24 RUBBER+NET	1	PZ	RC1002A0	JG 10M-8F TERMINAL REDUCTION FITTING	1	PZ	RC1365A0	3/4"-10 JG FEMALE CONNECTION	1	PZ								
Code	Description	Qty	UOM																										
GN1200A1	3/4 CONNECTION SEAL D=24 RUBBER+NET	1	PZ																										
RC1002A0	JG 10M-8F TERMINAL REDUCTION FITTING	1	PZ																										
RC1365A0	3/4"-10 JG FEMALE CONNECTION	1	PZ																										
VL1086A	LIMESCALE REMOVER NEODYMIUM MAGNET		KVL1086A	NEODYMIUM MAGNET ANTI-LIMESCALE KI	<table border="1"> <thead> <tr> <th>Code</th> <th>Description</th> <th>Qty</th> <th>UOM</th> </tr> </thead> <tbody> <tr> <td>VL1086A0</td> <td>LIMESCALE REMOVER NEODYMIUM MAGNET</td> <td>2</td> <td>PZ</td> </tr> </tbody> </table>	Code	Description	Qty	UOM	VL1086A0	LIMESCALE REMOVER NEODYMIUM MAGNET	2	PZ																
Code	Description	Qty	UOM																										
VL1086A0	LIMESCALE REMOVER NEODYMIUM MAGNET	2	PZ																										
VM1054A	H7.8 PRESSURE REDUCER RING NUT		KVM1054A KVL1117A	H7.8 PRESSURE REDUCER DIAL KIT EUR MM 2016+LMT FILTER+PRESS. RED. KIT	<table border="1"> <thead> <tr> <th>Code</th> <th>Description</th> <th>Qty</th> <th>UOM</th> </tr> </thead> <tbody> <tr> <td>VM1054A0</td> <td>H7.8 PRESSURE REDUCER RING NUT</td> <td>1</td> <td>PZ</td> </tr> </tbody> </table> <table border="1"> <thead> <tr> <th>Code</th> <th>Description</th> <th>Qty</th> <th>UOM</th> </tr> </thead> <tbody> <tr> <td>0H7472A1</td> <td>DISTRIBUTOR SUPPORT PLATE</td> <td>1</td> <td>PZ</td> </tr> <tr> <td>RC1004A0</td> <td>Ø10-Ø8-8 Y CONNECTION</td> <td>1</td> <td>PZ</td> </tr> <tr> <td>RC1243A0</td> <td>Ø10F-Ø10M ELBOW CONNECTION + JG END KIT</td> <td>1</td> <td>PZ</td> </tr> </tbody> </table>	Code	Description	Qty	UOM	VM1054A0	H7.8 PRESSURE REDUCER RING NUT	1	PZ	Code	Description	Qty	UOM	0H7472A1	DISTRIBUTOR SUPPORT PLATE	1	PZ	RC1004A0	Ø10-Ø8-8 Y CONNECTION	1	PZ	RC1243A0	Ø10F-Ø10M ELBOW CONNECTION + JG END KIT	1	PZ
Code	Description	Qty	UOM																										
VM1054A0	H7.8 PRESSURE REDUCER RING NUT	1	PZ																										
Code	Description	Qty	UOM																										
0H7472A1	DISTRIBUTOR SUPPORT PLATE	1	PZ																										
RC1004A0	Ø10-Ø8-8 Y CONNECTION	1	PZ																										
RC1243A0	Ø10F-Ø10M ELBOW CONNECTION + JG END KIT	1	PZ																										

COMPONENT			SPARE PART																																										
Code	Description	Image	Code	Description	Components list																																								
VM1054A	H7.8 PRESSURE REDUCER RING NUT		KVL1117A	EUR MM 2016+LMT FILTER+PRESS. RED. KIT	<table border="1"> <thead> <tr> <th>Code</th> <th>Description</th> <th>Qty</th> <th>UOM</th> </tr> </thead> <tbody> <tr> <td>RC1372A0</td> <td>Ø10M-1/4 M CIL. STRAIGHT FITTING</td> <td>2</td> <td>PZ</td> </tr> <tr> <td>VI1220A1</td> <td>4,2X12 TCB SELF-TAPPIN G SCREW</td> <td>4</td> <td>PZ</td> </tr> <tr> <td>VL1014B1</td> <td>PRESSURE REDUCER WITH DISTRIBUTOR</td> <td>1</td> <td>PZ</td> </tr> <tr> <td>VL1034C0</td> <td>MESH WATER FILTER D10</td> <td>1</td> <td>PZ</td> </tr> <tr> <td>VL1062C0</td> <td>PRESSURE REDUCER-FILTER LOCKING FORK</td> <td>1</td> <td>PZ</td> </tr> <tr> <td>VM1054A0</td> <td>H7.8 PRESSURE REDUCER RING NUT</td> <td>1</td> <td>PZ</td> </tr> </tbody> </table>	Code	Description	Qty	UOM	RC1372A0	Ø10M-1/4 M CIL. STRAIGHT FITTING	2	PZ	VI1220A1	4,2X12 TCB SELF-TAPPIN G SCREW	4	PZ	VL1014B1	PRESSURE REDUCER WITH DISTRIBUTOR	1	PZ	VL1034C0	MESH WATER FILTER D10	1	PZ	VL1062C0	PRESSURE REDUCER-FILTER LOCKING FORK	1	PZ	VM1054A0	H7.8 PRESSURE REDUCER RING NUT	1	PZ												
					Code	Description	Qty	UOM																																					
RC1372A0	Ø10M-1/4 M CIL. STRAIGHT FITTING	2	PZ																																										
VI1220A1	4,2X12 TCB SELF-TAPPIN G SCREW	4	PZ																																										
VL1014B1	PRESSURE REDUCER WITH DISTRIBUTOR	1	PZ																																										
VL1034C0	MESH WATER FILTER D10	1	PZ																																										
VL1062C0	PRESSURE REDUCER-FILTER LOCKING FORK	1	PZ																																										
VM1054A0	H7.8 PRESSURE REDUCER RING NUT	1	PZ																																										
VL1034C	MESH WATER FILTER D10		KVL1117A	EUR MM 2016+LMT FILTER+PRESS. RED. KIT	<table border="1"> <thead> <tr> <th>Code</th> <th>Description</th> <th>Qty</th> <th>UOM</th> </tr> </thead> <tbody> <tr> <td>0H17472A1</td> <td>DISTRIBUTOR SUPPORT PLATE</td> <td>1</td> <td>PZ</td> </tr> <tr> <td>RC1004A0</td> <td>Ø10-Ø8-8 Y CONNECTION</td> <td>1</td> <td>PZ</td> </tr> <tr> <td>RC1243A0</td> <td>Ø10F-Ø10M ELBOW CONNECTION + JG END KIT</td> <td>1</td> <td>PZ</td> </tr> <tr> <td>RC1372A0</td> <td>Ø10M-1/4 M CIL. STRAIGHT FITTING</td> <td>2</td> <td>PZ</td> </tr> <tr> <td>VI1220A1</td> <td>4,2X12 TCB SELF-TAPPIN G SCREW</td> <td>4</td> <td>PZ</td> </tr> <tr> <td>VL1014B1</td> <td>PRESSURE REDUCER WITH DISTRIBUTOR</td> <td>1</td> <td>PZ</td> </tr> <tr> <td>VL1034C0</td> <td>MESH WATER FILTER D10</td> <td>1</td> <td>PZ</td> </tr> <tr> <td>VL1062C0</td> <td>PRESSURE REDUCER-FILTER LOCKING FORK</td> <td>1</td> <td>PZ</td> </tr> <tr> <td>VM1054A0</td> <td>H7.8 PRESSURE REDUCER RING NUT</td> <td>1</td> <td>PZ</td> </tr> </tbody> </table>	Code	Description	Qty	UOM	0H17472A1	DISTRIBUTOR SUPPORT PLATE	1	PZ	RC1004A0	Ø10-Ø8-8 Y CONNECTION	1	PZ	RC1243A0	Ø10F-Ø10M ELBOW CONNECTION + JG END KIT	1	PZ	RC1372A0	Ø10M-1/4 M CIL. STRAIGHT FITTING	2	PZ	VI1220A1	4,2X12 TCB SELF-TAPPIN G SCREW	4	PZ	VL1014B1	PRESSURE REDUCER WITH DISTRIBUTOR	1	PZ	VL1034C0	MESH WATER FILTER D10	1	PZ	VL1062C0	PRESSURE REDUCER-FILTER LOCKING FORK	1	PZ	VM1054A0	H7.8 PRESSURE REDUCER RING NUT	1	PZ
					Code	Description	Qty	UOM																																					
0H17472A1	DISTRIBUTOR SUPPORT PLATE	1	PZ																																										
RC1004A0	Ø10-Ø8-8 Y CONNECTION	1	PZ																																										
RC1243A0	Ø10F-Ø10M ELBOW CONNECTION + JG END KIT	1	PZ																																										
RC1372A0	Ø10M-1/4 M CIL. STRAIGHT FITTING	2	PZ																																										
VI1220A1	4,2X12 TCB SELF-TAPPIN G SCREW	4	PZ																																										
VL1014B1	PRESSURE REDUCER WITH DISTRIBUTOR	1	PZ																																										
VL1034C0	MESH WATER FILTER D10	1	PZ																																										
VL1062C0	PRESSURE REDUCER-FILTER LOCKING FORK	1	PZ																																										
VM1054A0	H7.8 PRESSURE REDUCER RING NUT	1	PZ																																										

COMPONENT			SPARE PART																																										
Code	Description	Image	Code	Description	Components list																																								
VL1034C	MESH WATER FILTER D10		KVL1034C	Ø8-Ø10 MESH100 WATER FILTER KIT	<table border="1"> <thead> <tr> <th>Code</th> <th>Description</th> <th>Qty</th> <th>UOM</th> </tr> </thead> <tbody> <tr> <td>RC1002A0</td> <td>JG 10M-8F TERMINAL REDUCTION FITTING</td> <td>2</td> <td>PZ</td> </tr> <tr> <td>VL1034C0</td> <td>MESH WATER FILTER D10</td> <td>1</td> <td>PZ</td> </tr> <tr> <td>VL1062C0</td> <td>PRESSURE REDUCER-FIL TER LOCKING FORK</td> <td>1</td> <td>PZ</td> </tr> </tbody> </table>	Code	Description	Qty	UOM	RC1002A0	JG 10M-8F TERMINAL REDUCTION FITTING	2	PZ	VL1034C0	MESH WATER FILTER D10	1	PZ	VL1062C0	PRESSURE REDUCER-FIL TER LOCKING FORK	1	PZ																								
					Code	Description	Qty	UOM																																					
RC1002A0	JG 10M-8F TERMINAL REDUCTION FITTING	2	PZ																																										
VL1034C0	MESH WATER FILTER D10	1	PZ																																										
VL1062C0	PRESSURE REDUCER-FIL TER LOCKING FORK	1	PZ																																										
VL1062C	PRESSURE REDUCER-FILTER LOCKING FORK		KVL1117A	EUR MM 2016+LMT FILTER+PRESS. RED. KIT	<table border="1"> <thead> <tr> <th>Code</th> <th>Description</th> <th>Qty</th> <th>UOM</th> </tr> </thead> <tbody> <tr> <td>0H7472A1</td> <td>DISTRIBUTOR SUPPORT PLATE</td> <td>1</td> <td>PZ</td> </tr> <tr> <td>RC1004A0</td> <td>Ø10-Ø8-8 Y CONNECTION</td> <td>1</td> <td>PZ</td> </tr> <tr> <td>RC1243A0</td> <td>Ø10F-Ø10M ELBOW CONNECTION + JG END KIT</td> <td>1</td> <td>PZ</td> </tr> <tr> <td>RC1372A0</td> <td>Ø10M-1/4 M CIL. STRAIGHT FITTING</td> <td>2</td> <td>PZ</td> </tr> <tr> <td>VI1220A1</td> <td>4,2X12 TCB SELF-TAPPIN G SCREW</td> <td>4</td> <td>PZ</td> </tr> <tr> <td>VL1014B1</td> <td>PRESSURE REDUCER WITH DISTRIBUTOR</td> <td>1</td> <td>PZ</td> </tr> <tr> <td>VL1034C0</td> <td>MESH WATER FILTER D10</td> <td>1</td> <td>PZ</td> </tr> <tr> <td>VL1062C0</td> <td>PRESSURE REDUCER-FIL TER LOCKING FORK</td> <td>1</td> <td>PZ</td> </tr> <tr> <td>VM1054A0</td> <td>H7.8 PRESSURE REDUCER RING NUT</td> <td>1</td> <td>PZ</td> </tr> </tbody> </table>	Code	Description	Qty	UOM	0H7472A1	DISTRIBUTOR SUPPORT PLATE	1	PZ	RC1004A0	Ø10-Ø8-8 Y CONNECTION	1	PZ	RC1243A0	Ø10F-Ø10M ELBOW CONNECTION + JG END KIT	1	PZ	RC1372A0	Ø10M-1/4 M CIL. STRAIGHT FITTING	2	PZ	VI1220A1	4,2X12 TCB SELF-TAPPIN G SCREW	4	PZ	VL1014B1	PRESSURE REDUCER WITH DISTRIBUTOR	1	PZ	VL1034C0	MESH WATER FILTER D10	1	PZ	VL1062C0	PRESSURE REDUCER-FIL TER LOCKING FORK	1	PZ	VM1054A0	H7.8 PRESSURE REDUCER RING NUT	1	PZ
					Code	Description	Qty	UOM																																					
					0H7472A1	DISTRIBUTOR SUPPORT PLATE	1	PZ																																					
					RC1004A0	Ø10-Ø8-8 Y CONNECTION	1	PZ																																					
					RC1243A0	Ø10F-Ø10M ELBOW CONNECTION + JG END KIT	1	PZ																																					
					RC1372A0	Ø10M-1/4 M CIL. STRAIGHT FITTING	2	PZ																																					
					VI1220A1	4,2X12 TCB SELF-TAPPIN G SCREW	4	PZ																																					
					VL1014B1	PRESSURE REDUCER WITH DISTRIBUTOR	1	PZ																																					
					VL1034C0	MESH WATER FILTER D10	1	PZ																																					
					VL1062C0	PRESSURE REDUCER-FIL TER LOCKING FORK	1	PZ																																					
VM1054A0	H7.8 PRESSURE REDUCER RING NUT	1	PZ																																										
VL1125A	BENDED FITTING M-M RUBBER-HOLDER D8-END		KTB2237A	1,5M D10 TB2243A CONNECTION PIPE KIT	<table border="1"> <thead> <tr> <th>Code</th> <th>Description</th> <th>Qty</th> <th>UOM</th> </tr> </thead> <tbody> <tr> <td>TB2243A0</td> <td>Ø10 PET PIPE</td> <td>1.500</td> <td>M</td> </tr> </tbody> </table>	Code	Description	Qty	UOM	TB2243A0	Ø10 PET PIPE	1.500	M																																
					Code	Description	Qty	UOM																																					
TB2243A0	Ø10 PET PIPE	1.500	M																																										



COMPONENT			SPARE PART																																										
Code	Description	Image	Code	Description	Components list																																								
RC1372A	Ø10M-1/4 M CIL. STRAIGHT FITTING		KVL1117A	EUR MM 2016+LMT FILTER+PRESS. RED. KIT	<table border="1"> <thead> <tr> <th>Code</th> <th>Description</th> <th>Qty</th> <th>UOM</th> </tr> </thead> <tbody> <tr> <td>0H7472A1</td> <td>DISTRIBUTOR SUPPORT PLATE</td> <td>1</td> <td>PZ</td> </tr> <tr> <td>RC1004A0</td> <td>Ø10-Ø8-8 Y CONNECTION</td> <td>1</td> <td>PZ</td> </tr> <tr> <td>RC1243A0</td> <td>Ø10F-Ø10M ELBOW CONNECTION + JG END KIT</td> <td>1</td> <td>PZ</td> </tr> <tr> <td>RC1372A0</td> <td>Ø10M-1/4 M CIL. STRAIGHT FITTING</td> <td>2</td> <td>PZ</td> </tr> <tr> <td>VI1220A1</td> <td>4,2X12 TCB SELF-TAPPIN G SCREW</td> <td>4</td> <td>PZ</td> </tr> <tr> <td>VL1014B1</td> <td>PRESSURE REDUCER WITH DISTRIBUTOR</td> <td>1</td> <td>PZ</td> </tr> <tr> <td>VL1034C0</td> <td>MESH WATER FILTER D10</td> <td>1</td> <td>PZ</td> </tr> <tr> <td>VL1062C0</td> <td>PRESSURE REDUCER-FIL TER LOCKING FORK</td> <td>1</td> <td>PZ</td> </tr> <tr> <td>VM1054A0</td> <td>H7.8 PRESSURE REDUCER RING NUT</td> <td>1</td> <td>PZ</td> </tr> </tbody> </table>	Code	Description	Qty	UOM	0H7472A1	DISTRIBUTOR SUPPORT PLATE	1	PZ	RC1004A0	Ø10-Ø8-8 Y CONNECTION	1	PZ	RC1243A0	Ø10F-Ø10M ELBOW CONNECTION + JG END KIT	1	PZ	RC1372A0	Ø10M-1/4 M CIL. STRAIGHT FITTING	2	PZ	VI1220A1	4,2X12 TCB SELF-TAPPIN G SCREW	4	PZ	VL1014B1	PRESSURE REDUCER WITH DISTRIBUTOR	1	PZ	VL1034C0	MESH WATER FILTER D10	1	PZ	VL1062C0	PRESSURE REDUCER-FIL TER LOCKING FORK	1	PZ	VM1054A0	H7.8 PRESSURE REDUCER RING NUT	1	PZ
			Code	Description	Qty	UOM																																							
0H7472A1	DISTRIBUTOR SUPPORT PLATE	1	PZ																																										
RC1004A0	Ø10-Ø8-8 Y CONNECTION	1	PZ																																										
RC1243A0	Ø10F-Ø10M ELBOW CONNECTION + JG END KIT	1	PZ																																										
RC1372A0	Ø10M-1/4 M CIL. STRAIGHT FITTING	2	PZ																																										
VI1220A1	4,2X12 TCB SELF-TAPPIN G SCREW	4	PZ																																										
VL1014B1	PRESSURE REDUCER WITH DISTRIBUTOR	1	PZ																																										
VL1034C0	MESH WATER FILTER D10	1	PZ																																										
VL1062C0	PRESSURE REDUCER-FIL TER LOCKING FORK	1	PZ																																										
VM1054A0	H7.8 PRESSURE REDUCER RING NUT	1	PZ																																										
KRC1372A	D 10M-1/4 M CIL STRAIGHT CONNECTION KIT	<table border="1"> <thead> <tr> <th>Code</th> <th>Description</th> <th>Qty</th> <th>UOM</th> </tr> </thead> <tbody> <tr> <td>RC1372A0</td> <td>Ø10M-1/4 M CIL. STRAIGHT FITTING</td> <td>1</td> <td>PZ</td> </tr> </tbody> </table>	Code	Description	Qty	UOM	RC1372A0	Ø10M-1/4 M CIL. STRAIGHT FITTING	1	PZ																																			
Code	Description	Qty	UOM																																										
RC1372A0	Ø10M-1/4 M CIL. STRAIGHT FITTING	1	PZ																																										
VL1014B	PRESSURE REDUCER WITH DISTRIBUTOR		KVL1117A	EUR MM 2016+LMT FILTER+PRESS. RED. KIT	<table border="1"> <thead> <tr> <th>Code</th> <th>Description</th> <th>Qty</th> <th>UOM</th> </tr> </thead> <tbody> <tr> <td>0H7472A1</td> <td>DISTRIBUTOR SUPPORT PLATE</td> <td>1</td> <td>PZ</td> </tr> <tr> <td>RC1004A0</td> <td>Ø10-Ø8-8 Y CONNECTION</td> <td>1</td> <td>PZ</td> </tr> <tr> <td>RC1243A0</td> <td>Ø10F-Ø10M ELBOW CONNECTION + JG END KIT</td> <td>1</td> <td>PZ</td> </tr> <tr> <td>RC1372A0</td> <td>Ø10M-1/4 M CIL. STRAIGHT FITTING</td> <td>2</td> <td>PZ</td> </tr> <tr> <td>VI1220A1</td> <td>4,2X12 TCB SELF-TAPPIN G SCREW</td> <td>4</td> <td>PZ</td> </tr> <tr> <td>VL1014B1</td> <td>PRESSURE REDUCER WITH DISTRIBUTOR</td> <td>1</td> <td>PZ</td> </tr> </tbody> </table>	Code	Description	Qty	UOM	0H7472A1	DISTRIBUTOR SUPPORT PLATE	1	PZ	RC1004A0	Ø10-Ø8-8 Y CONNECTION	1	PZ	RC1243A0	Ø10F-Ø10M ELBOW CONNECTION + JG END KIT	1	PZ	RC1372A0	Ø10M-1/4 M CIL. STRAIGHT FITTING	2	PZ	VI1220A1	4,2X12 TCB SELF-TAPPIN G SCREW	4	PZ	VL1014B1	PRESSURE REDUCER WITH DISTRIBUTOR	1	PZ												
Code	Description	Qty	UOM																																										
0H7472A1	DISTRIBUTOR SUPPORT PLATE	1	PZ																																										
RC1004A0	Ø10-Ø8-8 Y CONNECTION	1	PZ																																										
RC1243A0	Ø10F-Ø10M ELBOW CONNECTION + JG END KIT	1	PZ																																										
RC1372A0	Ø10M-1/4 M CIL. STRAIGHT FITTING	2	PZ																																										
VI1220A1	4,2X12 TCB SELF-TAPPIN G SCREW	4	PZ																																										
VL1014B1	PRESSURE REDUCER WITH DISTRIBUTOR	1	PZ																																										

COMPONENT			SPARE PART																						
Code	Description	Image	Code	Description	Components list																				
VL1014B	PRESSURE REDUCER WITH DISTRIBUTOR		KVL1117A	EUR MM 2016+LMT FILTER+PRESS. RED. KIT	<table border="1"> <thead> <tr> <th>Code</th> <th>Description</th> <th>Qty</th> <th>UOM</th> </tr> </thead> <tbody> <tr> <td>VL1034C0</td> <td>MESH WATER FILTER D10</td> <td>1</td> <td>PZ</td> </tr> <tr> <td>VL1062C0</td> <td>PRESSURE REDUCER-FILTER LOCKING FORK</td> <td>1</td> <td>PZ</td> </tr> <tr> <td>VM1054A0</td> <td>H7.8 PRESSURE REDUCER RING NUT</td> <td>1</td> <td>PZ</td> </tr> </tbody> </table>	Code	Description	Qty	UOM	VL1034C0	MESH WATER FILTER D10	1	PZ	VL1062C0	PRESSURE REDUCER-FILTER LOCKING FORK	1	PZ	VM1054A0	H7.8 PRESSURE REDUCER RING NUT	1	PZ				
			Code	Description	Qty	UOM																			
			VL1034C0	MESH WATER FILTER D10	1	PZ																			
			VL1062C0	PRESSURE REDUCER-FILTER LOCKING FORK	1	PZ																			
			VM1054A0	H7.8 PRESSURE REDUCER RING NUT	1	PZ																			
			KVL0014B	EUR 2017 MIND.MAPS PRESSURE REDUCER KIT	<table border="1"> <thead> <tr> <th>Code</th> <th>Description</th> <th>Qty</th> <th>UOM</th> </tr> </thead> <tbody> <tr> <td>RC1372A0</td> <td>Ø10M-1/4 M CIL. STRAIGHT FITTING</td> <td>1</td> <td>PZ</td> </tr> <tr> <td>RC1396A0</td> <td>JG D10-1/4 STRAIGHT END FITTING</td> <td>1</td> <td>PZ</td> </tr> <tr> <td>VL1014B1</td> <td>PRESSURE REDUCER WITH DISTRIBUTOR</td> <td>1</td> <td>PZ</td> </tr> <tr> <td>VM1054A0</td> <td>H7.8 PRESSURE REDUCER RING NUT</td> <td>1</td> <td>PZ</td> </tr> </tbody> </table>	Code	Description	Qty	UOM	RC1372A0	Ø10M-1/4 M CIL. STRAIGHT FITTING	1	PZ	RC1396A0	JG D10-1/4 STRAIGHT END FITTING	1	PZ	VL1014B1	PRESSURE REDUCER WITH DISTRIBUTOR	1	PZ	VM1054A0	H7.8 PRESSURE REDUCER RING NUT	1	PZ
			Code	Description	Qty	UOM																			
			RC1372A0	Ø10M-1/4 M CIL. STRAIGHT FITTING	1	PZ																			
			RC1396A0	JG D10-1/4 STRAIGHT END FITTING	1	PZ																			
			VL1014B1	PRESSURE REDUCER WITH DISTRIBUTOR	1	PZ																			
			VM1054A0	H7.8 PRESSURE REDUCER RING NUT	1	PZ																			
			KVL0014A	EUR MIND.MAPS PRESSURE REDUCER KIT	<table border="1"> <thead> <tr> <th>Code</th> <th>Description</th> <th>Qty</th> <th>UOM</th> </tr> </thead> <tbody> <tr> <td>RC1372A0</td> <td>Ø10M-1/4 M CIL. STRAIGHT FITTING</td> <td>2</td> <td>PZ</td> </tr> <tr> <td>VL1014B1</td> <td>PRESSURE REDUCER WITH DISTRIBUTOR</td> <td>1</td> <td>PZ</td> </tr> <tr> <td>VM1054A0</td> <td>H7.8 PRESSURE REDUCER RING NUT</td> <td>1</td> <td>PZ</td> </tr> </tbody> </table>	Code	Description	Qty	UOM	RC1372A0	Ø10M-1/4 M CIL. STRAIGHT FITTING	2	PZ	VL1014B1	PRESSURE REDUCER WITH DISTRIBUTOR	1	PZ	VM1054A0	H7.8 PRESSURE REDUCER RING NUT	1	PZ				
Code	Description	Qty	UOM																						
RC1372A0	Ø10M-1/4 M CIL. STRAIGHT FITTING	2	PZ																						
VL1014B1	PRESSURE REDUCER WITH DISTRIBUTOR	1	PZ																						
VM1054A0	H7.8 PRESSURE REDUCER RING NUT	1	PZ																						
KVL0010A	S.4 - 5 WATER PRESSURE REDUCER KIT	<table border="1"> <thead> <tr> <th>Code</th> <th>Description</th> <th>Qty</th> <th>UOM</th> </tr> </thead> <tbody> <tr> <td>EL1210A0</td> <td>D8-BSP1/4 JG STRAIGHT END CONNECTION</td> <td>2</td> <td>PZ</td> </tr> <tr> <td>VL1014B1</td> <td>PRESSURE REDUCER WITH DISTRIBUTOR</td> <td>1</td> <td>PZ</td> </tr> </tbody> </table>	Code	Description	Qty	UOM	EL1210A0	D8-BSP1/4 JG STRAIGHT END CONNECTION	2	PZ	VL1014B1	PRESSURE REDUCER WITH DISTRIBUTOR	1	PZ											
Code	Description	Qty	UOM																						
EL1210A0	D8-BSP1/4 JG STRAIGHT END CONNECTION	2	PZ																						
VL1014B1	PRESSURE REDUCER WITH DISTRIBUTOR	1	PZ																						

COMPONENT			SPARE PART																						
Code	Description	Image	Code	Description	Components list																				
RC1396A	JG D10-1/4 STRAIGHT END FITTING		KVL0014B	EUR 2017 MIND.MAPS PRESSURE REDUCER KIT	<table border="1"> <thead> <tr> <th>Code</th> <th>Description</th> <th>Qty</th> <th>UOM</th> </tr> </thead> <tbody> <tr> <td>RC1372A0</td> <td>Ø10M-1/4 M CIL. STRAIGHT FITTING</td> <td>1</td> <td>PZ</td> </tr> <tr> <td>RC1396A0</td> <td>JG D10-1/4 STRAIGHT END FITTING</td> <td>1</td> <td>PZ</td> </tr> <tr> <td>VL1014B1</td> <td>PRESSURE REDUCER WITH DISTRIBUTOR</td> <td>1</td> <td>PZ</td> </tr> <tr> <td>VM1054A0</td> <td>H7.8 PRESSURE REDUCER RING NUT</td> <td>1</td> <td>PZ</td> </tr> </tbody> </table>	Code	Description	Qty	UOM	RC1372A0	Ø10M-1/4 M CIL. STRAIGHT FITTING	1	PZ	RC1396A0	JG D10-1/4 STRAIGHT END FITTING	1	PZ	VL1014B1	PRESSURE REDUCER WITH DISTRIBUTOR	1	PZ	VM1054A0	H7.8 PRESSURE REDUCER RING NUT	1	PZ
Code	Description	Qty	UOM																						
RC1372A0	Ø10M-1/4 M CIL. STRAIGHT FITTING	1	PZ																						
RC1396A0	JG D10-1/4 STRAIGHT END FITTING	1	PZ																						
VL1014B1	PRESSURE REDUCER WITH DISTRIBUTOR	1	PZ																						
VM1054A0	H7.8 PRESSURE REDUCER RING NUT	1	PZ																						
VL1063A	HOSE D8 TANG D10		KVL1063A	Ø8 PIPE HOLDER+Ø10 JG TERMINAL 10PCS KI	<table border="1"> <thead> <tr> <th>Code</th> <th>Description</th> <th>Qty</th> <th>UOM</th> </tr> </thead> <tbody> <tr> <td>VL1063A0</td> <td>HOSE D8 TANG D10</td> <td>10</td> <td>PZ</td> </tr> </tbody> </table>	Code	Description	Qty	UOM	VL1063A0	HOSE D8 TANG D10	10	PZ												
Code	Description	Qty	UOM																						
VL1063A0	HOSE D8 TANG D10	10	PZ																						
RC1046A	D10-16 H9 ST STEEL HOSE CLAMP		KTB2237A	1,5M D10 TB2243A CONNECTION PIPE KIT	<table border="1"> <thead> <tr> <th>Code</th> <th>Description</th> <th>Qty</th> <th>UOM</th> </tr> </thead> <tbody> <tr> <td>TB2243A0</td> <td>Ø10 PET PIPE</td> <td>1.500</td> <td>M</td> </tr> </tbody> </table>	Code	Description	Qty	UOM	TB2243A0	Ø10 PET PIPE	1.500	M												
Code	Description	Qty	UOM																						
TB2243A0	Ø10 PET PIPE	1.500	M																						
VL1096A	T SHAPED FITTING 2X RUBBER HOLDER D6-D10		KVL1096A	T - SHAPED FIT-D6-D10 HOLD-2 MAGNETS KIT	<table border="1"> <thead> <tr> <th>Code</th> <th>Description</th> <th>Qty</th> <th>UOM</th> </tr> </thead> <tbody> <tr> <td>RC1018A0</td> <td>ZINC PLATED D12 ELASTIC CLAMP</td> <td>2</td> <td>PZ</td> </tr> <tr> <td>VL1086A0</td> <td>LIMESCALE REMOVER NEODYMIUM MAGNET</td> <td>2</td> <td>PZ</td> </tr> <tr> <td>VL1096A1</td> <td>2PCS T-SHAPED FIT-D6-D10 HOLD-MAGNE</td> <td>1</td> <td>PZ</td> </tr> </tbody> </table>	Code	Description	Qty	UOM	RC1018A0	ZINC PLATED D12 ELASTIC CLAMP	2	PZ	VL1086A0	LIMESCALE REMOVER NEODYMIUM MAGNET	2	PZ	VL1096A1	2PCS T-SHAPED FIT-D6-D10 HOLD-MAGNE	1	PZ				
Code	Description	Qty	UOM																						
RC1018A0	ZINC PLATED D12 ELASTIC CLAMP	2	PZ																						
VL1086A0	LIMESCALE REMOVER NEODYMIUM MAGNET	2	PZ																						
VL1096A1	2PCS T-SHAPED FIT-D6-D10 HOLD-MAGNE	1	PZ																						

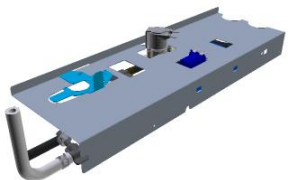

COMPONENT			SPARE PART										
Code	Description	Image	Code	Description	Components list								
0F1507B	XEVC-2011 SERIES LOWER BACK												
VL1047A	HOSE D6 TANG D8												
VL1095A	FITTING M-M RUBBER HOLDER D7,8-D10		KVL1095A	STRAIGHT CONNECT-HOLDER D7-D10 10PCS KIT	<table border="1"> <thead> <tr> <th>Code</th> <th>Description</th> <th>Qty</th> <th>UOM</th> </tr> </thead> <tbody> <tr> <td>VL1095A0</td> <td>FITTING M-M RUBBER HOLDER D7,8-D10</td> <td>10</td> <td>PZ</td> </tr> </tbody> </table>	Code	Description	Qty	UOM	VL1095A0	FITTING M-M RUBBER HOLDER D7,8-D10	10	PZ
Code	Description	Qty	UOM										
VL1095A0	FITTING M-M RUBBER HOLDER D7,8-D10	10	PZ										
0H7515A	XEVC-2011-E1R DOUBLE WASHING SYS PLATE		0H7515A0	XEVC-2011-E1R DOUBLE WASHING SYS PLATE									
VL1127A	T SHAPED BARBED FITTING D=6		KVL1127A	6MM BARBED T-SHAPED FITTING 10 PCS KIT	<table border="1"> <thead> <tr> <th>Code</th> <th>Description</th> <th>Qty</th> <th>UOM</th> </tr> </thead> <tbody> <tr> <td>VL1127A1</td> <td>6MM BARBED T-SHAPED FITTING</td> <td>10</td> <td>PZ</td> </tr> </tbody> </table>	Code	Description	Qty	UOM	VL1127A1	6MM BARBED T-SHAPED FITTING	10	PZ
Code	Description	Qty	UOM										
VL1127A1	6MM BARBED T-SHAPED FITTING	10	PZ										

COMPONENT			SPARE PART																																																						
Code	Description	Image	Code	Description	Components list																																																				
VL1106B			KVL1106A	EUR 1 ROTOR ARM ONE CLEANING SYSTEM KIT	<table border="1"> <thead> <tr> <th>Code</th> <th>Description</th> <th>Qty</th> <th>UOM</th> </tr> </thead> <tbody> <tr> <td>0H7819A0</td> <td>ONE WASHING SYS SUPPORT WITH STEAM VALVE</td> <td>1</td> <td>PZ</td> </tr> <tr> <td>EL1436A0</td> <td>H2O SOLENOID JG D8 CHECK VALVE</td> <td>1</td> <td>PZ</td> </tr> <tr> <td>GN1526A0</td> <td>INT. D.=6.9 TH=1.8 O-RIN</td> <td>1</td> <td>PZ</td> </tr> <tr> <td>RC1242A0</td> <td>D=10 CLOSED CAP</td> <td>2</td> <td>PZ</td> </tr> <tr> <td>TB2820A0</td> <td>PIPE EPDM FOR WASHING SYSTEM</td> <td>1.420</td> <td>M</td> </tr> <tr> <td>VI1220A1</td> <td>4,2X12 TCB SELF-TAPPIN G SCREW</td> <td>1</td> <td>PZ</td> </tr> <tr> <td>VL1019A0</td> <td>VIBRATION PUMP</td> <td>1</td> <td>PZ</td> </tr> <tr> <td>VL1053B0</td> <td>ONE WASHING SYS EXT DISTRIBUTOR</td> <td>1</td> <td>PZ</td> </tr> <tr> <td>VL1054B0</td> <td>ONE WASHING SYS INLET DISTRIBUTOR</td> <td>1</td> <td>PZ</td> </tr> <tr> <td>VL1102A1</td> <td>DETERGENT LINE FILTER + BARBED VNR 6 MM</td> <td>1</td> <td>PZ</td> </tr> <tr> <td>VL1128A0</td> <td>BARBED CHECK VALVE D6</td> <td>1</td> <td>PZ</td> </tr> <tr> <td>VM2172A0</td> <td>PUMP LOCKING CLIP</td> <td>1</td> <td>PZ</td> </tr> </tbody> </table>	Code	Description	Qty	UOM	0H7819A0	ONE WASHING SYS SUPPORT WITH STEAM VALVE	1	PZ	EL1436A0	H2O SOLENOID JG D8 CHECK VALVE	1	PZ	GN1526A0	INT. D.=6.9 TH=1.8 O-RIN	1	PZ	RC1242A0	D=10 CLOSED CAP	2	PZ	TB2820A0	PIPE EPDM FOR WASHING SYSTEM	1.420	M	VI1220A1	4,2X12 TCB SELF-TAPPIN G SCREW	1	PZ	VL1019A0	VIBRATION PUMP	1	PZ	VL1053B0	ONE WASHING SYS EXT DISTRIBUTOR	1	PZ	VL1054B0	ONE WASHING SYS INLET DISTRIBUTOR	1	PZ	VL1102A1	DETERGENT LINE FILTER + BARBED VNR 6 MM	1	PZ	VL1128A0	BARBED CHECK VALVE D6	1	PZ	VM2172A0	PUMP LOCKING CLIP	1	PZ
					Code	Description	Qty	UOM																																																	
0H7819A0	ONE WASHING SYS SUPPORT WITH STEAM VALVE	1	PZ																																																						
EL1436A0	H2O SOLENOID JG D8 CHECK VALVE	1	PZ																																																						
GN1526A0	INT. D.=6.9 TH=1.8 O-RIN	1	PZ																																																						
RC1242A0	D=10 CLOSED CAP	2	PZ																																																						
TB2820A0	PIPE EPDM FOR WASHING SYSTEM	1.420	M																																																						
VI1220A1	4,2X12 TCB SELF-TAPPIN G SCREW	1	PZ																																																						
VL1019A0	VIBRATION PUMP	1	PZ																																																						
VL1053B0	ONE WASHING SYS EXT DISTRIBUTOR	1	PZ																																																						
VL1054B0	ONE WASHING SYS INLET DISTRIBUTOR	1	PZ																																																						
VL1102A1	DETERGENT LINE FILTER + BARBED VNR 6 MM	1	PZ																																																						
VL1128A0	BARBED CHECK VALVE D6	1	PZ																																																						
VM2172A0	PUMP LOCKING CLIP	1	PZ																																																						
RC1019A	D=10 ELASTIC CLAM		KRC1019A	Ø10 ZINC PLATED ELASTIC CLAMP 15 PCS KIT	<table border="1"> <thead> <tr> <th>Code</th> <th>Description</th> <th>Qty</th> <th>UOM</th> </tr> </thead> <tbody> <tr> <td>RC1019A0</td> <td>D=10 ELASTIC CLAMP</td> <td>17</td> <td>PZ</td> </tr> </tbody> </table>	Code	Description	Qty	UOM	RC1019A0	D=10 ELASTIC CLAMP	17	PZ																																												
Code	Description	Qty	UOM																																																						
RC1019A0	D=10 ELASTIC CLAMP	17	PZ																																																						

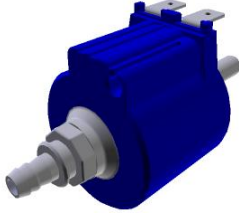

COMPONENT			SPARE PART										
Code	Description	Image	Code	Description	Components list								
TB3007A	TB2820A-DETERGENT ONE COIL		KTB3007A	MIND.MAPS ONE DETERGENT PIPE COIL KIT	<table border="1"> <thead> <tr> <th>Code</th> <th>Description</th> <th>Qty</th> <th>UOM</th> </tr> </thead> <tbody> <tr> <td>TB2820A0</td> <td>PIPE EPDM FOR WASHING SYSTEM</td> <td>0.550</td> <td>M</td> </tr> </tbody> </table>	Code	Description	Qty	UOM	TB2820A0	PIPE EPDM FOR WASHING SYSTEM	0.550	M
Code	Description	Qty	UOM										
TB2820A0	PIPE EPDM FOR WASHING SYSTEM	0.550	M										
TB3225B	TB2820A-TANK-WASHING SYS CONNECTION		TB3225B0	TB2820A-TANK-WASHING SYS CONNECTION									
VL1127A	T SHAPED BARBED FITTING D=6		KVL1127A	6MM BARBED T-SHAPED FITTING 10 PCS KIT	<table border="1"> <thead> <tr> <th>Code</th> <th>Description</th> <th>Qty</th> <th>UOM</th> </tr> </thead> <tbody> <tr> <td>VL1127A1</td> <td>6MM BARBED T-SHAPED FITTING</td> <td>10</td> <td>PZ</td> </tr> </tbody> </table>	Code	Description	Qty	UOM	VL1127A1	6MM BARBED T-SHAPED FITTING	10	PZ
Code	Description	Qty	UOM										
VL1127A1	6MM BARBED T-SHAPED FITTING	10	PZ										
VL1047A	HOSE D6 TANG D8												
TB3254A	TB3132A-USA H2O STEAM INLET PIPE		TB3254A0	TB3132A-USA H2O STEAM INLET PIPE									

COMPONENT			SPARE PART																																																																		
Code	Description	Image	Code	Description	Components list																																																																
VL1019A	VIBRATION PUMP		KVL1121A	EUR MIND.MAPS HOOD CLEANING SYSTEM KIT	<table border="1"> <thead> <tr> <th>Code</th> <th>Description</th> <th>Qty</th> <th>UOM</th> </tr> </thead> <tbody> <tr> <td>0H7368A0</td> <td>S6 HOOD WATER SYSTEM PLAT</td> <td>1</td> <td>PZ</td> </tr> <tr> <td>EL1424A0</td> <td>D8 CONNECTION WATER SOLENOID VALVE</td> <td>1</td> <td>PZ</td> </tr> <tr> <td>EL1436A0</td> <td>H2O SOLENOID JG D8 CHECK VALVE</td> <td>1</td> <td>PZ</td> </tr> <tr> <td>GN1526A0</td> <td>INT. D.=6.9 TH=1.8 O-RIN</td> <td>1</td> <td>PZ</td> </tr> <tr> <td>RC1019A0</td> <td>D=10 ELASTIC CLAMP</td> <td>12</td> <td>PZ</td> </tr> <tr> <td>RC1242A0</td> <td>D=10 CLOSED CAP</td> <td>2</td> <td>PZ</td> </tr> <tr> <td>RC1408A0</td> <td>DOUBLE WIRE SPRING CLAMP D10.8 ZN</td> <td>2</td> <td>PZ</td> </tr> <tr> <td>TB2820A0</td> <td>PIPE EPDM FOR WASHING SYSTEM</td> <td>2.200</td> <td>M</td> </tr> <tr> <td>VH1220A1</td> <td>4,2X12 TCB SELF-TAPPIN G SCREW</td> <td>5</td> <td>PZ</td> </tr> <tr> <td>VL1019A0</td> <td>VIBRATION PUMP</td> <td>1</td> <td>PZ</td> </tr> <tr> <td>VL1053B0</td> <td>ONE WASHING SYS EXT DISTRIBUTOR</td> <td>1</td> <td>PZ</td> </tr> <tr> <td>VL1054B0</td> <td>ONE WASHING SYS INLET DISTRIBUTOR</td> <td>1</td> <td>PZ</td> </tr> <tr> <td>VL1102A1</td> <td>DETERGENT LINE FILTER + BARBED VNR 6 MM</td> <td>1</td> <td>PZ</td> </tr> <tr> <td>VL1128A0</td> <td>BARBED CHECK VALVE D6</td> <td>1</td> <td>PZ</td> </tr> <tr> <td>VM2172A0</td> <td>PUMP LOCKING CLIP</td> <td>1</td> <td>PZ</td> </tr> </tbody> </table>	Code	Description	Qty	UOM	0H7368A0	S6 HOOD WATER SYSTEM PLAT	1	PZ	EL1424A0	D8 CONNECTION WATER SOLENOID VALVE	1	PZ	EL1436A0	H2O SOLENOID JG D8 CHECK VALVE	1	PZ	GN1526A0	INT. D.=6.9 TH=1.8 O-RIN	1	PZ	RC1019A0	D=10 ELASTIC CLAMP	12	PZ	RC1242A0	D=10 CLOSED CAP	2	PZ	RC1408A0	DOUBLE WIRE SPRING CLAMP D10.8 ZN	2	PZ	TB2820A0	PIPE EPDM FOR WASHING SYSTEM	2.200	M	VH1220A1	4,2X12 TCB SELF-TAPPIN G SCREW	5	PZ	VL1019A0	VIBRATION PUMP	1	PZ	VL1053B0	ONE WASHING SYS EXT DISTRIBUTOR	1	PZ	VL1054B0	ONE WASHING SYS INLET DISTRIBUTOR	1	PZ	VL1102A1	DETERGENT LINE FILTER + BARBED VNR 6 MM	1	PZ	VL1128A0	BARBED CHECK VALVE D6	1	PZ	VM2172A0	PUMP LOCKING CLIP	1	PZ
Code	Description	Qty	UOM																																																																		
0H7368A0	S6 HOOD WATER SYSTEM PLAT	1	PZ																																																																		
EL1424A0	D8 CONNECTION WATER SOLENOID VALVE	1	PZ																																																																		
EL1436A0	H2O SOLENOID JG D8 CHECK VALVE	1	PZ																																																																		
GN1526A0	INT. D.=6.9 TH=1.8 O-RIN	1	PZ																																																																		
RC1019A0	D=10 ELASTIC CLAMP	12	PZ																																																																		
RC1242A0	D=10 CLOSED CAP	2	PZ																																																																		
RC1408A0	DOUBLE WIRE SPRING CLAMP D10.8 ZN	2	PZ																																																																		
TB2820A0	PIPE EPDM FOR WASHING SYSTEM	2.200	M																																																																		
VH1220A1	4,2X12 TCB SELF-TAPPIN G SCREW	5	PZ																																																																		
VL1019A0	VIBRATION PUMP	1	PZ																																																																		
VL1053B0	ONE WASHING SYS EXT DISTRIBUTOR	1	PZ																																																																		
VL1054B0	ONE WASHING SYS INLET DISTRIBUTOR	1	PZ																																																																		
VL1102A1	DETERGENT LINE FILTER + BARBED VNR 6 MM	1	PZ																																																																		
VL1128A0	BARBED CHECK VALVE D6	1	PZ																																																																		
VM2172A0	PUMP LOCKING CLIP	1	PZ																																																																		
			KVL1120A	USA COMPACT PLUS CLEANING SYSTEM KIT	<table border="1"> <thead> <tr> <th>Code</th> <th>Description</th> <th>Qty</th> <th>UOM</th> </tr> </thead> <tbody> <tr> <td>0H7553D0</td> <td>XECC PLUS WASHING SYSTEM PLAT</td> <td>1</td> <td>PZ</td> </tr> </tbody> </table>	Code	Description	Qty	UOM	0H7553D0	XECC PLUS WASHING SYSTEM PLAT	1	PZ																																																								
Code	Description	Qty	UOM																																																																		
0H7553D0	XECC PLUS WASHING SYSTEM PLAT	1	PZ																																																																		

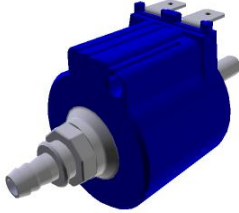
COMPONENT			SPARE PART																																																																										
Code	Description	Image	Code	Description	Components list																																																																								
VL1019A	VIBRATION PUMP		KVL1120A	USA COMPACT PLUS CLEANING SYSTEM KIT	<table border="1"> <thead> <tr> <th>Code</th> <th>Description</th> <th>Qty</th> <th>UOM</th> </tr> </thead> <tbody> <tr> <td>EL1422A1</td> <td>1 WAY SOLENOID VALVE + D8-D10 REDUCTION</td> <td>1</td> <td>PZ</td> </tr> <tr> <td>EL1426A0</td> <td>H2O UL SOLENOID JG D8-PIPE HOLDER</td> <td>1</td> <td>PZ</td> </tr> <tr> <td>EL1437A0</td> <td>H2O SOLENOID JG D6 UL CHECK VALVE</td> <td>1</td> <td>PZ</td> </tr> <tr> <td>GN1312A0</td> <td>RUBBER CABLE-PASSI NG DE=26 DI=15 SP=10</td> <td>1</td> <td>PZ</td> </tr> <tr> <td>GN1526A0</td> <td>INT. D.=6.9 TH=1.8 O-RIN</td> <td>1</td> <td>PZ</td> </tr> <tr> <td>RC1019A0</td> <td>D=10 ELASTIC CLAMP</td> <td>10</td> <td>PZ</td> </tr> <tr> <td>RC1242A0</td> <td>D=10 CLOSED CAP</td> <td>2</td> <td>PZ</td> </tr> <tr> <td>RC1356A0</td> <td>STRAIGHT THREADED FEMALE END 8X1/4" BSP</td> <td>1</td> <td>PZ</td> </tr> <tr> <td>TB2820A0</td> <td>PIPE EPDM FOR WASHING SYSTEM</td> <td>1.200</td> <td>M</td> </tr> <tr> <td>VI1220A1</td> <td>4,2X12 TCB SELF-TAPPIN G SCREW</td> <td>9</td> <td>PZ</td> </tr> <tr> <td>VL1019A0</td> <td>VIBRATION PUMP</td> <td>1</td> <td>PZ</td> </tr> <tr> <td>VL1054B0</td> <td>ONE WASHING SYS INLET DISTRIBUTOR</td> <td>1</td> <td>PZ</td> </tr> <tr> <td>VL1064A0</td> <td>WASHING SYSTEM OUTLETS DISTRIBUTOR</td> <td>1</td> <td>PZ</td> </tr> <tr> <td>VL1065A1</td> <td>1/4 MALE N.O. PRESSURE SWITCH</td> <td>1</td> <td>PZ</td> </tr> <tr> <td>VL1102A1</td> <td>DETERGENT LINE FILTER + BARBED VNR 6 MM</td> <td>1</td> <td>PZ</td> </tr> <tr> <td>VL1128A0</td> <td>BARBED CHECK VALVE D6</td> <td>1</td> <td>PZ</td> </tr> <tr> <td>VM2172A0</td> <td>PUMP LOCKING CLIP</td> <td>1</td> <td>PZ</td> </tr> </tbody> </table>	Code	Description	Qty	UOM	EL1422A1	1 WAY SOLENOID VALVE + D8-D10 REDUCTION	1	PZ	EL1426A0	H2O UL SOLENOID JG D8-PIPE HOLDER	1	PZ	EL1437A0	H2O SOLENOID JG D6 UL CHECK VALVE	1	PZ	GN1312A0	RUBBER CABLE-PASSI NG DE=26 DI=15 SP=10	1	PZ	GN1526A0	INT. D.=6.9 TH=1.8 O-RIN	1	PZ	RC1019A0	D=10 ELASTIC CLAMP	10	PZ	RC1242A0	D=10 CLOSED CAP	2	PZ	RC1356A0	STRAIGHT THREADED FEMALE END 8X1/4" BSP	1	PZ	TB2820A0	PIPE EPDM FOR WASHING SYSTEM	1.200	M	VI1220A1	4,2X12 TCB SELF-TAPPIN G SCREW	9	PZ	VL1019A0	VIBRATION PUMP	1	PZ	VL1054B0	ONE WASHING SYS INLET DISTRIBUTOR	1	PZ	VL1064A0	WASHING SYSTEM OUTLETS DISTRIBUTOR	1	PZ	VL1065A1	1/4 MALE N.O. PRESSURE SWITCH	1	PZ	VL1102A1	DETERGENT LINE FILTER + BARBED VNR 6 MM	1	PZ	VL1128A0	BARBED CHECK VALVE D6	1	PZ	VM2172A0	PUMP LOCKING CLIP	1	PZ
Code	Description	Qty	UOM																																																																										
EL1422A1	1 WAY SOLENOID VALVE + D8-D10 REDUCTION	1	PZ																																																																										
EL1426A0	H2O UL SOLENOID JG D8-PIPE HOLDER	1	PZ																																																																										
EL1437A0	H2O SOLENOID JG D6 UL CHECK VALVE	1	PZ																																																																										
GN1312A0	RUBBER CABLE-PASSI NG DE=26 DI=15 SP=10	1	PZ																																																																										
GN1526A0	INT. D.=6.9 TH=1.8 O-RIN	1	PZ																																																																										
RC1019A0	D=10 ELASTIC CLAMP	10	PZ																																																																										
RC1242A0	D=10 CLOSED CAP	2	PZ																																																																										
RC1356A0	STRAIGHT THREADED FEMALE END 8X1/4" BSP	1	PZ																																																																										
TB2820A0	PIPE EPDM FOR WASHING SYSTEM	1.200	M																																																																										
VI1220A1	4,2X12 TCB SELF-TAPPIN G SCREW	9	PZ																																																																										
VL1019A0	VIBRATION PUMP	1	PZ																																																																										
VL1054B0	ONE WASHING SYS INLET DISTRIBUTOR	1	PZ																																																																										
VL1064A0	WASHING SYSTEM OUTLETS DISTRIBUTOR	1	PZ																																																																										
VL1065A1	1/4 MALE N.O. PRESSURE SWITCH	1	PZ																																																																										
VL1102A1	DETERGENT LINE FILTER + BARBED VNR 6 MM	1	PZ																																																																										
VL1128A0	BARBED CHECK VALVE D6	1	PZ																																																																										
VM2172A0	PUMP LOCKING CLIP	1	PZ																																																																										

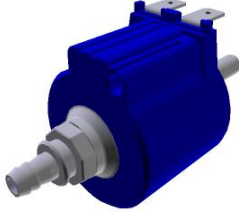
COMPONENT			SPARE PART																																																																														
Code	Description	Image	Code	Description	Components list																																																																												
VL1019A	VIBRATION PUMP		KVL1119A	EUR COMPACT PLUS CLEANING SYSTEM KIT	<table border="1"> <thead> <tr> <th>Code</th> <th>Description</th> <th>Qty</th> <th>UOM</th> </tr> </thead> <tbody> <tr> <td>0H7553D0</td> <td>XECC PLUS WASHING SYSTEM PLAT</td> <td>1</td> <td>PZ</td> </tr> <tr> <td>EL1252A1</td> <td>1 WAY WATER VALVE + J.G. CONNECTION</td> <td>1</td> <td>PZ</td> </tr> <tr> <td>EL1424A0</td> <td>D8 CONNECTION WATER SOLENOID VALVE</td> <td>1</td> <td>PZ</td> </tr> <tr> <td>EL1436A0</td> <td>H2O SOLENOID JG D8 CHECK VALVE</td> <td>1</td> <td>PZ</td> </tr> <tr> <td>GN1312A0</td> <td>RUBBER CABLE-PASSI NG DE=26 DI=15 SP=10</td> <td>1</td> <td>PZ</td> </tr> <tr> <td>GN1526A0</td> <td>INT. D.=6.9 TH=1.8 O-RIN</td> <td>1</td> <td>PZ</td> </tr> <tr> <td>RC1019A0</td> <td>D=10 ELASTIC CLAMP</td> <td>11</td> <td>PZ</td> </tr> <tr> <td>RC1242A0</td> <td>D=10 CLOSED CAP</td> <td>2</td> <td>PZ</td> </tr> <tr> <td>RC1356A0</td> <td>STRAIGHT THREADED FEMALE END 8X1/4" BSP</td> <td>1</td> <td>PZ</td> </tr> <tr> <td>TB2820A0</td> <td>PIPE EPDM FOR WASHING SYSTEM</td> <td>1.200</td> <td>M</td> </tr> <tr> <td>VI1220A1</td> <td>4,2X12 TCB SELF-TAPPIN G SCREW</td> <td>16</td> <td>PZ</td> </tr> <tr> <td>VL1019A0</td> <td>VIBRATION PUMP</td> <td>1</td> <td>PZ</td> </tr> <tr> <td>VL1054B0</td> <td>ONE WASHING SYS INLET DISTRIBUTOR</td> <td>1</td> <td>PZ</td> </tr> <tr> <td>VL1064A0</td> <td>WASHING SYSTEM OUTLETS DISTRIBUTOR</td> <td>1</td> <td>PZ</td> </tr> <tr> <td>VL1065A1</td> <td>1/4 MALE N.O. PRESSURE SWITCH</td> <td>1</td> <td>PZ</td> </tr> <tr> <td>VL1102A1</td> <td>DETERGENT LINE FILTER + BARBED VNR 6 MM</td> <td>1</td> <td>PZ</td> </tr> <tr> <td>VL1128A0</td> <td>BARBED CHECK VALVE D6</td> <td>1</td> <td>PZ</td> </tr> <tr> <td>VM2172A0</td> <td>PUMP LOCKING CLIP</td> <td>1</td> <td>PZ</td> </tr> </tbody> </table>	Code	Description	Qty	UOM	0H7553D0	XECC PLUS WASHING SYSTEM PLAT	1	PZ	EL1252A1	1 WAY WATER VALVE + J.G. CONNECTION	1	PZ	EL1424A0	D8 CONNECTION WATER SOLENOID VALVE	1	PZ	EL1436A0	H2O SOLENOID JG D8 CHECK VALVE	1	PZ	GN1312A0	RUBBER CABLE-PASSI NG DE=26 DI=15 SP=10	1	PZ	GN1526A0	INT. D.=6.9 TH=1.8 O-RIN	1	PZ	RC1019A0	D=10 ELASTIC CLAMP	11	PZ	RC1242A0	D=10 CLOSED CAP	2	PZ	RC1356A0	STRAIGHT THREADED FEMALE END 8X1/4" BSP	1	PZ	TB2820A0	PIPE EPDM FOR WASHING SYSTEM	1.200	M	VI1220A1	4,2X12 TCB SELF-TAPPIN G SCREW	16	PZ	VL1019A0	VIBRATION PUMP	1	PZ	VL1054B0	ONE WASHING SYS INLET DISTRIBUTOR	1	PZ	VL1064A0	WASHING SYSTEM OUTLETS DISTRIBUTOR	1	PZ	VL1065A1	1/4 MALE N.O. PRESSURE SWITCH	1	PZ	VL1102A1	DETERGENT LINE FILTER + BARBED VNR 6 MM	1	PZ	VL1128A0	BARBED CHECK VALVE D6	1	PZ	VM2172A0	PUMP LOCKING CLIP	1	PZ
Code	Description	Qty	UOM																																																																														
0H7553D0	XECC PLUS WASHING SYSTEM PLAT	1	PZ																																																																														
EL1252A1	1 WAY WATER VALVE + J.G. CONNECTION	1	PZ																																																																														
EL1424A0	D8 CONNECTION WATER SOLENOID VALVE	1	PZ																																																																														
EL1436A0	H2O SOLENOID JG D8 CHECK VALVE	1	PZ																																																																														
GN1312A0	RUBBER CABLE-PASSI NG DE=26 DI=15 SP=10	1	PZ																																																																														
GN1526A0	INT. D.=6.9 TH=1.8 O-RIN	1	PZ																																																																														
RC1019A0	D=10 ELASTIC CLAMP	11	PZ																																																																														
RC1242A0	D=10 CLOSED CAP	2	PZ																																																																														
RC1356A0	STRAIGHT THREADED FEMALE END 8X1/4" BSP	1	PZ																																																																														
TB2820A0	PIPE EPDM FOR WASHING SYSTEM	1.200	M																																																																														
VI1220A1	4,2X12 TCB SELF-TAPPIN G SCREW	16	PZ																																																																														
VL1019A0	VIBRATION PUMP	1	PZ																																																																														
VL1054B0	ONE WASHING SYS INLET DISTRIBUTOR	1	PZ																																																																														
VL1064A0	WASHING SYSTEM OUTLETS DISTRIBUTOR	1	PZ																																																																														
VL1065A1	1/4 MALE N.O. PRESSURE SWITCH	1	PZ																																																																														
VL1102A1	DETERGENT LINE FILTER + BARBED VNR 6 MM	1	PZ																																																																														
VL1128A0	BARBED CHECK VALVE D6	1	PZ																																																																														
VM2172A0	PUMP LOCKING CLIP	1	PZ																																																																														

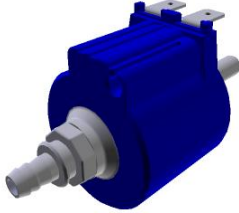
COMPONENT			SPARE PART																																																										
Code	Description	Image	Code	Description	Components list																																																								
VL1019A	VIBRATION PUMP		KVL1118A	EUR COMPACT ONE CLEANING SYSTEM KIT	<table border="1"> <thead> <tr> <th>Code</th> <th>Description</th> <th>Qty</th> <th>UOM</th> </tr> </thead> <tbody> <tr> <td>0H7173C0</td> <td>XECC ONE WASHING SYSTEM PLAT</td> <td>1</td> <td>PZ</td> </tr> <tr> <td>EL1436A0</td> <td>H2O SOLENOID JG D8 CHECK VALVE</td> <td>1</td> <td>PZ</td> </tr> <tr> <td>GN1526A0</td> <td>INT. D.=6.9 TH=1.8 O-RIN</td> <td>1</td> <td>PZ</td> </tr> <tr> <td>RC1019A0</td> <td>D=10 ELASTIC CLAMP</td> <td>12</td> <td>PZ</td> </tr> <tr> <td>RC1242A0</td> <td>D=10 CLOSED CAP</td> <td>2</td> <td>PZ</td> </tr> <tr> <td>TB2820A0</td> <td>PIPE EPDM FOR WASHING SYSTEM</td> <td>1.200</td> <td>M</td> </tr> <tr> <td>VI1220A1</td> <td>4,2X12 TCB SELF-TAPPIN G SCREW</td> <td>6</td> <td>PZ</td> </tr> <tr> <td>VL1019A0</td> <td>VIBRATION PUMP</td> <td>1</td> <td>PZ</td> </tr> <tr> <td>VL1053B0</td> <td>ONE WASHING SYS EXT DISTRIBUTOR</td> <td>1</td> <td>PZ</td> </tr> <tr> <td>VL1054B0</td> <td>ONE WASHING SYS INLET DISTRIBUTOR</td> <td>1</td> <td>PZ</td> </tr> <tr> <td>VL1102A1</td> <td>DETERGENT LINE FILTER + BARBED VNR 6 MM</td> <td>1</td> <td>PZ</td> </tr> <tr> <td>VL1128A0</td> <td>BARBED CHECK VALVE D6</td> <td>1</td> <td>PZ</td> </tr> <tr> <td>VM2172A0</td> <td>PUMP LOCKING CLIP</td> <td>1</td> <td>PZ</td> </tr> </tbody> </table>	Code	Description	Qty	UOM	0H7173C0	XECC ONE WASHING SYSTEM PLAT	1	PZ	EL1436A0	H2O SOLENOID JG D8 CHECK VALVE	1	PZ	GN1526A0	INT. D.=6.9 TH=1.8 O-RIN	1	PZ	RC1019A0	D=10 ELASTIC CLAMP	12	PZ	RC1242A0	D=10 CLOSED CAP	2	PZ	TB2820A0	PIPE EPDM FOR WASHING SYSTEM	1.200	M	VI1220A1	4,2X12 TCB SELF-TAPPIN G SCREW	6	PZ	VL1019A0	VIBRATION PUMP	1	PZ	VL1053B0	ONE WASHING SYS EXT DISTRIBUTOR	1	PZ	VL1054B0	ONE WASHING SYS INLET DISTRIBUTOR	1	PZ	VL1102A1	DETERGENT LINE FILTER + BARBED VNR 6 MM	1	PZ	VL1128A0	BARBED CHECK VALVE D6	1	PZ	VM2172A0	PUMP LOCKING CLIP	1	PZ
			Code	Description	Qty	UOM																																																							
0H7173C0	XECC ONE WASHING SYSTEM PLAT	1	PZ																																																										
EL1436A0	H2O SOLENOID JG D8 CHECK VALVE	1	PZ																																																										
GN1526A0	INT. D.=6.9 TH=1.8 O-RIN	1	PZ																																																										
RC1019A0	D=10 ELASTIC CLAMP	12	PZ																																																										
RC1242A0	D=10 CLOSED CAP	2	PZ																																																										
TB2820A0	PIPE EPDM FOR WASHING SYSTEM	1.200	M																																																										
VI1220A1	4,2X12 TCB SELF-TAPPIN G SCREW	6	PZ																																																										
VL1019A0	VIBRATION PUMP	1	PZ																																																										
VL1053B0	ONE WASHING SYS EXT DISTRIBUTOR	1	PZ																																																										
VL1054B0	ONE WASHING SYS INLET DISTRIBUTOR	1	PZ																																																										
VL1102A1	DETERGENT LINE FILTER + BARBED VNR 6 MM	1	PZ																																																										
VL1128A0	BARBED CHECK VALVE D6	1	PZ																																																										
VM2172A0	PUMP LOCKING CLIP	1	PZ																																																										
KVL1109A	EUR 2 ROTOR ARMS ONE CLEANING SYSTEM KIT	<table border="1"> <thead> <tr> <th>Code</th> <th>Description</th> <th>Qty</th> <th>UOM</th> </tr> </thead> <tbody> <tr> <td>0H7324A0</td> <td>ONE OVENS WASHING SYST HOLDING PLATE</td> <td>2</td> <td>PZ</td> </tr> <tr> <td>0H7515A0</td> <td>XEVC-2011-E1 R DOUBLE WASHING SYS PLATE</td> <td>1</td> <td>PZ</td> </tr> <tr> <td>CH1000A0</td> <td>SNIP PIPE CUTTER</td> <td>1</td> <td>PZ</td> </tr> <tr> <td>EL1115A0</td> <td>Ø8 Y CONNECTION</td> <td>1</td> <td>PZ</td> </tr> </tbody> </table>	Code	Description	Qty	UOM	0H7324A0	ONE OVENS WASHING SYST HOLDING PLATE	2	PZ	0H7515A0	XEVC-2011-E1 R DOUBLE WASHING SYS PLATE	1	PZ	CH1000A0	SNIP PIPE CUTTER	1	PZ	EL1115A0	Ø8 Y CONNECTION	1	PZ																																							
Code	Description	Qty	UOM																																																										
0H7324A0	ONE OVENS WASHING SYST HOLDING PLATE	2	PZ																																																										
0H7515A0	XEVC-2011-E1 R DOUBLE WASHING SYS PLATE	1	PZ																																																										
CH1000A0	SNIP PIPE CUTTER	1	PZ																																																										
EL1115A0	Ø8 Y CONNECTION	1	PZ																																																										

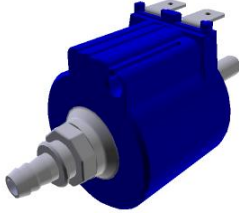
COMPONENT			SPARE PART																																																																																					
Code	Description	Image	Code	Description	Components list																																																																																			
VL1019A	VIBRATION PUMP		KVL1109A	EUR 2 ROTOR ARMS ONE CLEANING SYSTEM KIT	<table border="1"> <thead> <tr> <th>Code</th> <th>Description</th> <th>Qty</th> <th>UOM</th> </tr> </thead> <tbody> <tr> <td>EL1436A0</td> <td>H2O SOLENOID JG D8 CHECK VALVE</td> <td>2</td> <td>PZ</td> </tr> <tr> <td>GN1526A0</td> <td>INT. D.=6.9 TH=1.8 O-RIN</td> <td>2</td> <td>PZ</td> </tr> <tr> <td>RC1006A0</td> <td>D8 PET PIPE GUIDE BEND</td> <td>4</td> <td>PZ</td> </tr> <tr> <td>RC1019A0</td> <td>D=10 ELASTIC CLAMP</td> <td>26</td> <td>PZ</td> </tr> <tr> <td>RC1242A0</td> <td>D=10 CLOSED CAP</td> <td>4</td> <td>PZ</td> </tr> <tr> <td>TB1818A0</td> <td>JG Ø8 BLUE PE PIPE</td> <td>1.640</td> <td>M</td> </tr> <tr> <td>TB2820A0</td> <td>PIPE EPDM FOR WASHING SYSTEM</td> <td>3.940</td> <td>M</td> </tr> <tr> <td>VI1220A1</td> <td>4,2X12 TCB SELF-TAPPIN G SCREW</td> <td>8</td> <td>PZ</td> </tr> <tr> <td>VL1019A0</td> <td>VIBRATION PUMP</td> <td>2</td> <td>PZ</td> </tr> <tr> <td>VL1053B0</td> <td>ONE WASHING SYS EXT DISTRIBUTOR</td> <td>2</td> <td>PZ</td> </tr> <tr> <td>VL1054B0</td> <td>ONE WASHING SYS INLET DISTRIBUTOR</td> <td>2</td> <td>PZ</td> </tr> <tr> <td>VL1102A1</td> <td>DETERGENT LINE FILTER + BARBED VNR 6 MM</td> <td>2</td> <td>PZ</td> </tr> <tr> <td>VL1128A0</td> <td>BARBED CHECK VALVE D6</td> <td>2</td> <td>PZ</td> </tr> <tr> <td>VM2172A0</td> <td>PUMP LOCKING CLIP</td> <td>2</td> <td>PZ</td> </tr> </tbody> </table>	Code	Description	Qty	UOM	EL1436A0	H2O SOLENOID JG D8 CHECK VALVE	2	PZ	GN1526A0	INT. D.=6.9 TH=1.8 O-RIN	2	PZ	RC1006A0	D8 PET PIPE GUIDE BEND	4	PZ	RC1019A0	D=10 ELASTIC CLAMP	26	PZ	RC1242A0	D=10 CLOSED CAP	4	PZ	TB1818A0	JG Ø8 BLUE PE PIPE	1.640	M	TB2820A0	PIPE EPDM FOR WASHING SYSTEM	3.940	M	VI1220A1	4,2X12 TCB SELF-TAPPIN G SCREW	8	PZ	VL1019A0	VIBRATION PUMP	2	PZ	VL1053B0	ONE WASHING SYS EXT DISTRIBUTOR	2	PZ	VL1054B0	ONE WASHING SYS INLET DISTRIBUTOR	2	PZ	VL1102A1	DETERGENT LINE FILTER + BARBED VNR 6 MM	2	PZ	VL1128A0	BARBED CHECK VALVE D6	2	PZ	VM2172A0	PUMP LOCKING CLIP	2	PZ	KVL1108A	04EU ONE EUR 1 ROTOR CLEANING SYSTEM KIT	<table border="1"> <thead> <tr> <th>Code</th> <th>Description</th> <th>Qty</th> <th>UOM</th> </tr> </thead> <tbody> <tr> <td>0H7511A0</td> <td>ONE OVENS WASHING SYST HOLDING PLATE</td> <td>1</td> <td>PZ</td> </tr> <tr> <td>EL1436A0</td> <td>H2O SOLENOID JG D8 CHECK VALVE</td> <td>1</td> <td>PZ</td> </tr> <tr> <td>GN1526A0</td> <td>INT. D.=6.9 TH=1.8 O-RIN</td> <td>1</td> <td>PZ</td> </tr> <tr> <td>RC1006A0</td> <td>D8 PET PIPE GUIDE BEND</td> <td>2</td> <td>PZ</td> </tr> </tbody> </table>	Code	Description	Qty	UOM	0H7511A0	ONE OVENS WASHING SYST HOLDING PLATE	1	PZ	EL1436A0	H2O SOLENOID JG D8 CHECK VALVE	1	PZ	GN1526A0	INT. D.=6.9 TH=1.8 O-RIN	1	PZ	RC1006A0	D8 PET PIPE GUIDE BEND	2	PZ
			Code	Description	Qty	UOM																																																																																		
EL1436A0	H2O SOLENOID JG D8 CHECK VALVE	2	PZ																																																																																					
GN1526A0	INT. D.=6.9 TH=1.8 O-RIN	2	PZ																																																																																					
RC1006A0	D8 PET PIPE GUIDE BEND	4	PZ																																																																																					
RC1019A0	D=10 ELASTIC CLAMP	26	PZ																																																																																					
RC1242A0	D=10 CLOSED CAP	4	PZ																																																																																					
TB1818A0	JG Ø8 BLUE PE PIPE	1.640	M																																																																																					
TB2820A0	PIPE EPDM FOR WASHING SYSTEM	3.940	M																																																																																					
VI1220A1	4,2X12 TCB SELF-TAPPIN G SCREW	8	PZ																																																																																					
VL1019A0	VIBRATION PUMP	2	PZ																																																																																					
VL1053B0	ONE WASHING SYS EXT DISTRIBUTOR	2	PZ																																																																																					
VL1054B0	ONE WASHING SYS INLET DISTRIBUTOR	2	PZ																																																																																					
VL1102A1	DETERGENT LINE FILTER + BARBED VNR 6 MM	2	PZ																																																																																					
VL1128A0	BARBED CHECK VALVE D6	2	PZ																																																																																					
VM2172A0	PUMP LOCKING CLIP	2	PZ																																																																																					
Code	Description	Qty	UOM																																																																																					
0H7511A0	ONE OVENS WASHING SYST HOLDING PLATE	1	PZ																																																																																					
EL1436A0	H2O SOLENOID JG D8 CHECK VALVE	1	PZ																																																																																					
GN1526A0	INT. D.=6.9 TH=1.8 O-RIN	1	PZ																																																																																					
RC1006A0	D8 PET PIPE GUIDE BEND	2	PZ																																																																																					

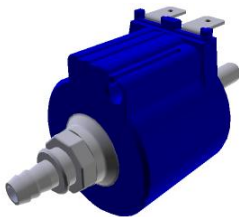
COMPONENT			SPARE PART																																														
Code	Description	Image	Code	Description	Components list																																												
VL1019A	VIBRATION PUMP		KVL1108A	04EU ONE EUR 1 ROTOR CLEANING SYSTEM KIT	<table border="1"> <thead> <tr> <th>Code</th> <th>Description</th> <th>Qty</th> <th>UOM</th> </tr> </thead> <tbody> <tr> <td>RC1019A0</td> <td>D=10 ELASTIC CLAMP</td> <td>17</td> <td>PZ</td> </tr> <tr> <td>RC1242A0</td> <td>D=10 CLOSED CAP</td> <td>2</td> <td>PZ</td> </tr> <tr> <td>TB1818A0</td> <td>JG Ø8 BLUE PE PIPE</td> <td>0.320</td> <td>M</td> </tr> <tr> <td>TB2820A0</td> <td>PIPE EPDM FOR WASHING SYSTEM</td> <td>1.380</td> <td>M</td> </tr> <tr> <td>VI1220A1</td> <td>4,2X12 TCB SELF-TAPPIN G SCREW</td> <td>1</td> <td>PZ</td> </tr> <tr> <td>VL1019A0</td> <td>VIBRATION PUMP</td> <td>2</td> <td>PZ</td> </tr> <tr> <td>VL1053B0</td> <td>ONE WASHING SYS EXT DISTRIBUTOR</td> <td>1</td> <td>PZ</td> </tr> <tr> <td>VL1054B0</td> <td>ONE WASHING SYS INLET DISTRIBUTOR</td> <td>1</td> <td>PZ</td> </tr> <tr> <td>VL1128A0</td> <td>BARBED CHECK VALVE D6</td> <td>1</td> <td>PZ</td> </tr> <tr> <td>VM2172A0</td> <td>PUMP LOCKING CLIP</td> <td>1</td> <td>PZ</td> </tr> </tbody> </table>	Code	Description	Qty	UOM	RC1019A0	D=10 ELASTIC CLAMP	17	PZ	RC1242A0	D=10 CLOSED CAP	2	PZ	TB1818A0	JG Ø8 BLUE PE PIPE	0.320	M	TB2820A0	PIPE EPDM FOR WASHING SYSTEM	1.380	M	VI1220A1	4,2X12 TCB SELF-TAPPIN G SCREW	1	PZ	VL1019A0	VIBRATION PUMP	2	PZ	VL1053B0	ONE WASHING SYS EXT DISTRIBUTOR	1	PZ	VL1054B0	ONE WASHING SYS INLET DISTRIBUTOR	1	PZ	VL1128A0	BARBED CHECK VALVE D6	1	PZ	VM2172A0	PUMP LOCKING CLIP	1	PZ
			Code	Description	Qty	UOM																																											
RC1019A0	D=10 ELASTIC CLAMP	17	PZ																																														
RC1242A0	D=10 CLOSED CAP	2	PZ																																														
TB1818A0	JG Ø8 BLUE PE PIPE	0.320	M																																														
TB2820A0	PIPE EPDM FOR WASHING SYSTEM	1.380	M																																														
VI1220A1	4,2X12 TCB SELF-TAPPIN G SCREW	1	PZ																																														
VL1019A0	VIBRATION PUMP	2	PZ																																														
VL1053B0	ONE WASHING SYS EXT DISTRIBUTOR	1	PZ																																														
VL1054B0	ONE WASHING SYS INLET DISTRIBUTOR	1	PZ																																														
VL1128A0	BARBED CHECK VALVE D6	1	PZ																																														
VM2172A0	PUMP LOCKING CLIP	1	PZ																																														
KVL1107A	04EU PLUS EUR 1ROTOR CLEANING SYSTEM KIT	<table border="1"> <thead> <tr> <th>Code</th> <th>Description</th> <th>Qty</th> <th>UOM</th> </tr> </thead> <tbody> <tr> <td>0H7323A0</td> <td>WASHING SYSTEM HOLDING PLATE</td> <td>1</td> <td>PZ</td> </tr> <tr> <td>EL1252A1</td> <td>1 WAY WATER VALVE + J.G. CONNECTION</td> <td>1</td> <td>PZ</td> </tr> <tr> <td>EL1424A0</td> <td>D8 CONNECTION WATER SOLENOID VALVE</td> <td>1</td> <td>PZ</td> </tr> <tr> <td>EL1436A0</td> <td>H2O SOLENOID JG D8 CHECK VALVE</td> <td>1</td> <td>PZ</td> </tr> <tr> <td>GN1526A0</td> <td>INT. D.=6.9 TH=1.8 O-RIN</td> <td>1</td> <td>PZ</td> </tr> <tr> <td>RC1019A0</td> <td>D=10 ELASTIC CLAMP</td> <td>13</td> <td>PZ</td> </tr> <tr> <td>RC1130A0</td> <td>130X2,6 CLAM</td> <td>1</td> <td>PZ</td> </tr> <tr> <td>RC1242A0</td> <td>D=10 CLOSED CAP</td> <td>2</td> <td>PZ</td> </tr> <tr> <td>RC1310A0</td> <td>140X4 CLAMP WITH CLIP</td> <td>2</td> <td>PZ</td> </tr> </tbody> </table>	Code	Description	Qty	UOM	0H7323A0	WASHING SYSTEM HOLDING PLATE	1	PZ	EL1252A1	1 WAY WATER VALVE + J.G. CONNECTION	1	PZ	EL1424A0	D8 CONNECTION WATER SOLENOID VALVE	1	PZ	EL1436A0	H2O SOLENOID JG D8 CHECK VALVE	1	PZ	GN1526A0	INT. D.=6.9 TH=1.8 O-RIN	1	PZ	RC1019A0	D=10 ELASTIC CLAMP	13	PZ	RC1130A0	130X2,6 CLAM	1	PZ	RC1242A0	D=10 CLOSED CAP	2	PZ	RC1310A0	140X4 CLAMP WITH CLIP	2	PZ							
Code	Description	Qty	UOM																																														
0H7323A0	WASHING SYSTEM HOLDING PLATE	1	PZ																																														
EL1252A1	1 WAY WATER VALVE + J.G. CONNECTION	1	PZ																																														
EL1424A0	D8 CONNECTION WATER SOLENOID VALVE	1	PZ																																														
EL1436A0	H2O SOLENOID JG D8 CHECK VALVE	1	PZ																																														
GN1526A0	INT. D.=6.9 TH=1.8 O-RIN	1	PZ																																														
RC1019A0	D=10 ELASTIC CLAMP	13	PZ																																														
RC1130A0	130X2,6 CLAM	1	PZ																																														
RC1242A0	D=10 CLOSED CAP	2	PZ																																														
RC1310A0	140X4 CLAMP WITH CLIP	2	PZ																																														

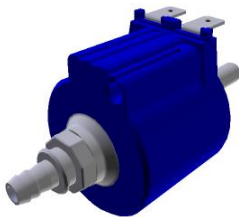

COMPONENT			SPARE PART																																																		
Code	Description	Image	Code	Description	Components list																																																
VL1019A	VIBRATION PUMP		KVL1107A	04EU PLUS EUR 1 ROTOR CLEANING SYSTEM KIT	<table border="1"> <thead> <tr> <th>Code</th> <th>Description</th> <th>Qty</th> <th>UOM</th> </tr> </thead> <tbody> <tr> <td>RC1356A0</td> <td>STRAIGHT THREADED FEMALE END 8X1/4" BSP</td> <td>1</td> <td>PZ</td> </tr> <tr> <td>TB2820A0</td> <td>PIPE EPDM FOR WASHING SYSTEM</td> <td>2.670</td> <td>M</td> </tr> <tr> <td>VI1220A1</td> <td>4,2X12 TCB SELF-TAPPIN G SCREW</td> <td>2</td> <td>PZ</td> </tr> <tr> <td>VL1019A0</td> <td>VIBRATION PUMP</td> <td>1</td> <td>PZ</td> </tr> <tr> <td>VL1064A0</td> <td>WASHING SYSTEM OUTLETS DISTRIBUTOR</td> <td>1</td> <td>PZ</td> </tr> <tr> <td>VL1065A1</td> <td>1/4 MALE N.O. PRESSURE SWITCH</td> <td>1</td> <td>PZ</td> </tr> <tr> <td>VL1067A0</td> <td>WASHING SYSTEM INLETS DISTRIBUTOR</td> <td>1</td> <td>PZ</td> </tr> <tr> <td>VL1083A0</td> <td>D=10 CONNECTION - D=6 PIPE FITTING</td> <td>1</td> <td>PZ</td> </tr> <tr> <td>VL1102A1</td> <td>DETERGENT LINE FILTER + BARBED VNR 6 MM</td> <td>1</td> <td>PZ</td> </tr> <tr> <td>VL1128A0</td> <td>BARBED CHECK VALVE D6</td> <td>1</td> <td>PZ</td> </tr> <tr> <td>VM2172A0</td> <td>PUMP LOCKING CLIP</td> <td>1</td> <td>PZ</td> </tr> </tbody> </table>	Code	Description	Qty	UOM	RC1356A0	STRAIGHT THREADED FEMALE END 8X1/4" BSP	1	PZ	TB2820A0	PIPE EPDM FOR WASHING SYSTEM	2.670	M	VI1220A1	4,2X12 TCB SELF-TAPPIN G SCREW	2	PZ	VL1019A0	VIBRATION PUMP	1	PZ	VL1064A0	WASHING SYSTEM OUTLETS DISTRIBUTOR	1	PZ	VL1065A1	1/4 MALE N.O. PRESSURE SWITCH	1	PZ	VL1067A0	WASHING SYSTEM INLETS DISTRIBUTOR	1	PZ	VL1083A0	D=10 CONNECTION - D=6 PIPE FITTING	1	PZ	VL1102A1	DETERGENT LINE FILTER + BARBED VNR 6 MM	1	PZ	VL1128A0	BARBED CHECK VALVE D6	1	PZ	VM2172A0	PUMP LOCKING CLIP	1	PZ
			Code	Description	Qty	UOM																																															
RC1356A0	STRAIGHT THREADED FEMALE END 8X1/4" BSP	1	PZ																																																		
TB2820A0	PIPE EPDM FOR WASHING SYSTEM	2.670	M																																																		
VI1220A1	4,2X12 TCB SELF-TAPPIN G SCREW	2	PZ																																																		
VL1019A0	VIBRATION PUMP	1	PZ																																																		
VL1064A0	WASHING SYSTEM OUTLETS DISTRIBUTOR	1	PZ																																																		
VL1065A1	1/4 MALE N.O. PRESSURE SWITCH	1	PZ																																																		
VL1067A0	WASHING SYSTEM INLETS DISTRIBUTOR	1	PZ																																																		
VL1083A0	D=10 CONNECTION - D=6 PIPE FITTING	1	PZ																																																		
VL1102A1	DETERGENT LINE FILTER + BARBED VNR 6 MM	1	PZ																																																		
VL1128A0	BARBED CHECK VALVE D6	1	PZ																																																		
VM2172A0	PUMP LOCKING CLIP	1	PZ																																																		
KVL1106A	EUR 1 ROTOR ARM ONE CLEANING SYSTEM KIT	<table border="1"> <thead> <tr> <th>Code</th> <th>Description</th> <th>Qty</th> <th>UOM</th> </tr> </thead> <tbody> <tr> <td>0H7819A0</td> <td>ONE WASHING SYS SUPPORT WITH STEAM VALVE</td> <td>1</td> <td>PZ</td> </tr> <tr> <td>EL1436A0</td> <td>H2O SOLENOID JG D8 CHECK VALVE</td> <td>1</td> <td>PZ</td> </tr> <tr> <td>GN1526A0</td> <td>INT. D.=6.9 TH=1.8 O-RIN</td> <td>1</td> <td>PZ</td> </tr> <tr> <td>RC1242A0</td> <td>D=10 CLOSED CAP</td> <td>2</td> <td>PZ</td> </tr> <tr> <td>TB2820A0</td> <td>PIPE EPDM FOR WASHING SYSTEM</td> <td>1.420</td> <td>M</td> </tr> </tbody> </table>	Code	Description	Qty	UOM	0H7819A0	ONE WASHING SYS SUPPORT WITH STEAM VALVE	1	PZ	EL1436A0	H2O SOLENOID JG D8 CHECK VALVE	1	PZ	GN1526A0	INT. D.=6.9 TH=1.8 O-RIN	1	PZ	RC1242A0	D=10 CLOSED CAP	2	PZ	TB2820A0	PIPE EPDM FOR WASHING SYSTEM	1.420	M																											
Code	Description	Qty	UOM																																																		
0H7819A0	ONE WASHING SYS SUPPORT WITH STEAM VALVE	1	PZ																																																		
EL1436A0	H2O SOLENOID JG D8 CHECK VALVE	1	PZ																																																		
GN1526A0	INT. D.=6.9 TH=1.8 O-RIN	1	PZ																																																		
RC1242A0	D=10 CLOSED CAP	2	PZ																																																		
TB2820A0	PIPE EPDM FOR WASHING SYSTEM	1.420	M																																																		

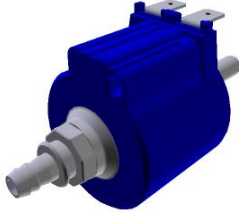

COMPONENT			SPARE PART																																							
Code	Description	Image	Code	Description	Components list																																					
VL1019A	VIBRATION PUMP		KVL1106A	EUR 1 ROTOR ARM ONE CLEANING SYSTEM KIT	<table border="1"> <thead> <tr> <th>Code</th> <th>Description</th> <th>Qty</th> <th>UOM</th> </tr> </thead> <tbody> <tr> <td>VI1220A1</td> <td>4,2X12 TCB SELF-TAPPIN G SCREW</td> <td>1</td> <td>PZ</td> </tr> <tr> <td>VL1019A0</td> <td>VIBRATION PUMP</td> <td>1</td> <td>PZ</td> </tr> <tr> <td>VL1053B0</td> <td>ONE WASHING SYS EXT DISTRIBUTOR</td> <td>1</td> <td>PZ</td> </tr> <tr> <td>VL1054B0</td> <td>ONE WASHING SYS INLET DISTRIBUTOR</td> <td>1</td> <td>PZ</td> </tr> <tr> <td>VL1102A1</td> <td>DETERGENT LINE FILTER + BARBED VNR 6 MM</td> <td>1</td> <td>PZ</td> </tr> <tr> <td>VL1128A0</td> <td>BARBED CHECK VALVE D6</td> <td>1</td> <td>PZ</td> </tr> <tr> <td>VM2172A0</td> <td>PUMP LOCKING CLIP</td> <td>1</td> <td>PZ</td> </tr> </tbody> </table>	Code	Description	Qty	UOM	VI1220A1	4,2X12 TCB SELF-TAPPIN G SCREW	1	PZ	VL1019A0	VIBRATION PUMP	1	PZ	VL1053B0	ONE WASHING SYS EXT DISTRIBUTOR	1	PZ	VL1054B0	ONE WASHING SYS INLET DISTRIBUTOR	1	PZ	VL1102A1	DETERGENT LINE FILTER + BARBED VNR 6 MM	1	PZ	VL1128A0	BARBED CHECK VALVE D6	1	PZ	VM2172A0	PUMP LOCKING CLIP	1	PZ					
			Code	Description	Qty	UOM																																				
VI1220A1	4,2X12 TCB SELF-TAPPIN G SCREW	1	PZ																																							
VL1019A0	VIBRATION PUMP	1	PZ																																							
VL1053B0	ONE WASHING SYS EXT DISTRIBUTOR	1	PZ																																							
VL1054B0	ONE WASHING SYS INLET DISTRIBUTOR	1	PZ																																							
VL1102A1	DETERGENT LINE FILTER + BARBED VNR 6 MM	1	PZ																																							
VL1128A0	BARBED CHECK VALVE D6	1	PZ																																							
VM2172A0	PUMP LOCKING CLIP	1	PZ																																							
KVL1105A	USA 2ROTOR ARMS PLUS CLEANING SYSTEM KIT	<table border="1"> <thead> <tr> <th>Code</th> <th>Description</th> <th>Qty</th> <th>UOM</th> </tr> </thead> <tbody> <tr> <td>0H7820A0</td> <td>PLUS WASHING SY SUPPORT WITH STEAM VALVE</td> <td>1</td> <td>PZ</td> </tr> <tr> <td>EL1422A1</td> <td>1 WAY SOLENOID VALVE + D8-D10 REDUCTION</td> <td>1</td> <td>PZ</td> </tr> <tr> <td>EL1426A0</td> <td>H2O UL SOLENOID JG D8-PIPE HOLDER</td> <td>2</td> <td>PZ</td> </tr> <tr> <td>EL1437A0</td> <td>H2O SOLENOID JG D6 UL CHECK VALVE</td> <td>1</td> <td>PZ</td> </tr> <tr> <td>GN1526A0</td> <td>INT. D.=6.9 TH=1.8 O-RIN</td> <td>1</td> <td>PZ</td> </tr> <tr> <td>RC1019A0</td> <td>D=10 ELASTIC CLAMP</td> <td>12</td> <td>PZ</td> </tr> <tr> <td>RC1130A0</td> <td>130X2,6 CLAM</td> <td>1</td> <td>PZ</td> </tr> <tr> <td>RC1242A0</td> <td>D=10 CLOSED CAP</td> <td>2</td> <td>PZ</td> </tr> <tr> <td>RC1356A0</td> <td>STRAIGHT THREADED FEMALE END 8X1/4" BSP</td> <td>1</td> <td>PZ</td> </tr> </tbody> </table>	Code	Description	Qty	UOM	0H7820A0	PLUS WASHING SY SUPPORT WITH STEAM VALVE	1	PZ	EL1422A1	1 WAY SOLENOID VALVE + D8-D10 REDUCTION	1	PZ	EL1426A0	H2O UL SOLENOID JG D8-PIPE HOLDER	2	PZ	EL1437A0	H2O SOLENOID JG D6 UL CHECK VALVE	1	PZ	GN1526A0	INT. D.=6.9 TH=1.8 O-RIN	1	PZ	RC1019A0	D=10 ELASTIC CLAMP	12	PZ	RC1130A0	130X2,6 CLAM	1	PZ	RC1242A0	D=10 CLOSED CAP	2	PZ	RC1356A0	STRAIGHT THREADED FEMALE END 8X1/4" BSP	1	PZ
Code	Description	Qty	UOM																																							
0H7820A0	PLUS WASHING SY SUPPORT WITH STEAM VALVE	1	PZ																																							
EL1422A1	1 WAY SOLENOID VALVE + D8-D10 REDUCTION	1	PZ																																							
EL1426A0	H2O UL SOLENOID JG D8-PIPE HOLDER	2	PZ																																							
EL1437A0	H2O SOLENOID JG D6 UL CHECK VALVE	1	PZ																																							
GN1526A0	INT. D.=6.9 TH=1.8 O-RIN	1	PZ																																							
RC1019A0	D=10 ELASTIC CLAMP	12	PZ																																							
RC1130A0	130X2,6 CLAM	1	PZ																																							
RC1242A0	D=10 CLOSED CAP	2	PZ																																							
RC1356A0	STRAIGHT THREADED FEMALE END 8X1/4" BSP	1	PZ																																							

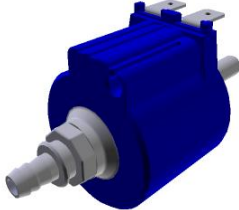

COMPONENT			SPARE PART																																										
Code	Description	Image	Code	Description	Components list																																								
VL1019A	VIBRATION PUMP		KVL1105A	USA 2 ROTOR ARMS PLUS CLEANING SYSTEM KIT	<table border="1"> <thead> <tr> <th>Code</th> <th>Description</th> <th>Qty</th> <th>UOM</th> </tr> </thead> <tbody> <tr> <td>TB2820A0</td> <td>PIPE EPDM FOR WASHING SYSTEM</td> <td>1.410</td> <td>M</td> </tr> <tr> <td>VI1220A1</td> <td>4,2X12 TCB SELF-TAPPIN G SCREW</td> <td>3</td> <td>PZ</td> </tr> <tr> <td>VL1019A0</td> <td>VIBRATION PUMP</td> <td>1</td> <td>PZ</td> </tr> <tr> <td>VL1065A1</td> <td>1/4 MALE N.O. PRESSURE SWITCH</td> <td>1</td> <td>PZ</td> </tr> <tr> <td>VL1067A0</td> <td>WASHING SYSTEM INLETS DISTRIBUTOR</td> <td>1</td> <td>PZ</td> </tr> <tr> <td>VL1092A0</td> <td>WASHING SYSTEM OUTLET DOUBLE DISTRIBUTOR</td> <td>1</td> <td>PZ</td> </tr> <tr> <td>VL1102A1</td> <td>DETERGENT LINE FILTER + BARBED VNR 6 MM</td> <td>1</td> <td>PZ</td> </tr> <tr> <td>VL1128A0</td> <td>BARBED CHECK VALVE D6</td> <td>1</td> <td>PZ</td> </tr> <tr> <td>VM2172A0</td> <td>PUMP LOCKING CLIP</td> <td>1</td> <td>PZ</td> </tr> </tbody> </table>	Code	Description	Qty	UOM	TB2820A0	PIPE EPDM FOR WASHING SYSTEM	1.410	M	VI1220A1	4,2X12 TCB SELF-TAPPIN G SCREW	3	PZ	VL1019A0	VIBRATION PUMP	1	PZ	VL1065A1	1/4 MALE N.O. PRESSURE SWITCH	1	PZ	VL1067A0	WASHING SYSTEM INLETS DISTRIBUTOR	1	PZ	VL1092A0	WASHING SYSTEM OUTLET DOUBLE DISTRIBUTOR	1	PZ	VL1102A1	DETERGENT LINE FILTER + BARBED VNR 6 MM	1	PZ	VL1128A0	BARBED CHECK VALVE D6	1	PZ	VM2172A0	PUMP LOCKING CLIP	1	PZ
			Code	Description	Qty	UOM																																							
TB2820A0	PIPE EPDM FOR WASHING SYSTEM	1.410	M																																										
VI1220A1	4,2X12 TCB SELF-TAPPIN G SCREW	3	PZ																																										
VL1019A0	VIBRATION PUMP	1	PZ																																										
VL1065A1	1/4 MALE N.O. PRESSURE SWITCH	1	PZ																																										
VL1067A0	WASHING SYSTEM INLETS DISTRIBUTOR	1	PZ																																										
VL1092A0	WASHING SYSTEM OUTLET DOUBLE DISTRIBUTOR	1	PZ																																										
VL1102A1	DETERGENT LINE FILTER + BARBED VNR 6 MM	1	PZ																																										
VL1128A0	BARBED CHECK VALVE D6	1	PZ																																										
VM2172A0	PUMP LOCKING CLIP	1	PZ																																										
KVL1104A	USA 1 ROTOR ARM PLUS CLEANING SYSTEM KIT	<table border="1"> <thead> <tr> <th>Code</th> <th>Description</th> <th>Qty</th> <th>UOM</th> </tr> </thead> <tbody> <tr> <td>0H7820A0</td> <td>PLUS WASHING SY SUPPORT WITH STEAM VALVE</td> <td>1</td> <td>PZ</td> </tr> <tr> <td>EL1422A1</td> <td>1 WAY SOLENOID VALVE + D8-D10 REDUCTION</td> <td>1</td> <td>PZ</td> </tr> <tr> <td>EL1426A0</td> <td>H2O UL SOLENOID JG D8-PIPE HOLDER</td> <td>1</td> <td>PZ</td> </tr> <tr> <td>EL1437A0</td> <td>H2O SOLENOID JG D6 UL CHECK VALVE</td> <td>1</td> <td>PZ</td> </tr> <tr> <td>GN1526A0</td> <td>INT. D.=6.9 TH=1.8 O-RIN</td> <td>1</td> <td>PZ</td> </tr> <tr> <td>RC1019A0</td> <td>D=10 ELASTIC CLAMP</td> <td>12</td> <td>PZ</td> </tr> <tr> <td>RC1130A0</td> <td>130X2,6 CLAM</td> <td>1</td> <td>PZ</td> </tr> </tbody> </table>	Code	Description	Qty	UOM	0H7820A0	PLUS WASHING SY SUPPORT WITH STEAM VALVE	1	PZ	EL1422A1	1 WAY SOLENOID VALVE + D8-D10 REDUCTION	1	PZ	EL1426A0	H2O UL SOLENOID JG D8-PIPE HOLDER	1	PZ	EL1437A0	H2O SOLENOID JG D6 UL CHECK VALVE	1	PZ	GN1526A0	INT. D.=6.9 TH=1.8 O-RIN	1	PZ	RC1019A0	D=10 ELASTIC CLAMP	12	PZ	RC1130A0	130X2,6 CLAM	1	PZ											
Code	Description	Qty	UOM																																										
0H7820A0	PLUS WASHING SY SUPPORT WITH STEAM VALVE	1	PZ																																										
EL1422A1	1 WAY SOLENOID VALVE + D8-D10 REDUCTION	1	PZ																																										
EL1426A0	H2O UL SOLENOID JG D8-PIPE HOLDER	1	PZ																																										
EL1437A0	H2O SOLENOID JG D6 UL CHECK VALVE	1	PZ																																										
GN1526A0	INT. D.=6.9 TH=1.8 O-RIN	1	PZ																																										
RC1019A0	D=10 ELASTIC CLAMP	12	PZ																																										
RC1130A0	130X2,6 CLAM	1	PZ																																										

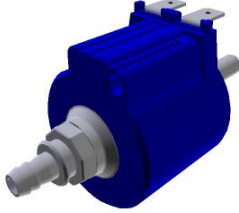

COMPONENT			SPARE PART																																																		
Code	Description	Image	Code	Description	Components list																																																
VL1019A	VIBRATION PUMP		KVL1104A	USA 1 ROTOR ARM PLUS CLEANING SYSTEM KIT	<table border="1"> <thead> <tr> <th>Code</th> <th>Description</th> <th>Qty</th> <th>UOM</th> </tr> </thead> <tbody> <tr> <td>RC1242A0</td> <td>D=10 CLOSED CAP</td> <td>2</td> <td>PZ</td> </tr> <tr> <td>RC1356A0</td> <td>STRAIGHT THREADED FEMALE END 8X1/4" BSP</td> <td>1</td> <td>PZ</td> </tr> <tr> <td>TB2820A0</td> <td>PIPE EPDM FOR WASHING SYSTEM</td> <td>1.410</td> <td>M</td> </tr> <tr> <td>VI1220A1</td> <td>4,2X12 TCB SELF-TAPPING SCREW</td> <td>3</td> <td>PZ</td> </tr> <tr> <td>VL1019A0</td> <td>VIBRATION PUMP</td> <td>1</td> <td>PZ</td> </tr> <tr> <td>VL1064A0</td> <td>WASHING SYSTEM OUTLETS DISTRIBUTOR</td> <td>1</td> <td>PZ</td> </tr> <tr> <td>VL1065A1</td> <td>1/4 MALE N.O. PRESSURE SWITCH</td> <td>1</td> <td>PZ</td> </tr> <tr> <td>VL1067A0</td> <td>WASHING SYSTEM INLETS DISTRIBUTOR</td> <td>1</td> <td>PZ</td> </tr> <tr> <td>VL1102A1</td> <td>DETERGENT LINE FILTER + BARBED VNR 6 MM</td> <td>1</td> <td>PZ</td> </tr> <tr> <td>VL1128A0</td> <td>BARBED CHECK VALVE D6</td> <td>1</td> <td>PZ</td> </tr> <tr> <td>VM2172A0</td> <td>PUMP LOCKING CLIP</td> <td>1</td> <td>PZ</td> </tr> </tbody> </table>	Code	Description	Qty	UOM	RC1242A0	D=10 CLOSED CAP	2	PZ	RC1356A0	STRAIGHT THREADED FEMALE END 8X1/4" BSP	1	PZ	TB2820A0	PIPE EPDM FOR WASHING SYSTEM	1.410	M	VI1220A1	4,2X12 TCB SELF-TAPPING SCREW	3	PZ	VL1019A0	VIBRATION PUMP	1	PZ	VL1064A0	WASHING SYSTEM OUTLETS DISTRIBUTOR	1	PZ	VL1065A1	1/4 MALE N.O. PRESSURE SWITCH	1	PZ	VL1067A0	WASHING SYSTEM INLETS DISTRIBUTOR	1	PZ	VL1102A1	DETERGENT LINE FILTER + BARBED VNR 6 MM	1	PZ	VL1128A0	BARBED CHECK VALVE D6	1	PZ	VM2172A0	PUMP LOCKING CLIP	1	PZ
			Code	Description	Qty	UOM																																															
RC1242A0	D=10 CLOSED CAP	2	PZ																																																		
RC1356A0	STRAIGHT THREADED FEMALE END 8X1/4" BSP	1	PZ																																																		
TB2820A0	PIPE EPDM FOR WASHING SYSTEM	1.410	M																																																		
VI1220A1	4,2X12 TCB SELF-TAPPING SCREW	3	PZ																																																		
VL1019A0	VIBRATION PUMP	1	PZ																																																		
VL1064A0	WASHING SYSTEM OUTLETS DISTRIBUTOR	1	PZ																																																		
VL1065A1	1/4 MALE N.O. PRESSURE SWITCH	1	PZ																																																		
VL1067A0	WASHING SYSTEM INLETS DISTRIBUTOR	1	PZ																																																		
VL1102A1	DETERGENT LINE FILTER + BARBED VNR 6 MM	1	PZ																																																		
VL1128A0	BARBED CHECK VALVE D6	1	PZ																																																		
VM2172A0	PUMP LOCKING CLIP	1	PZ																																																		
KVL1103A	EUR 2 ROTOR ARMS PLUS CLEANING SYSTEM KIT	<table border="1"> <thead> <tr> <th>Code</th> <th>Description</th> <th>Qty</th> <th>UOM</th> </tr> </thead> <tbody> <tr> <td>0H7820A0</td> <td>PLUS WASHING SY SUPPORT WITH STEAM VALVE</td> <td>1</td> <td>PZ</td> </tr> <tr> <td>EL1252A1</td> <td>1 WAY WATER VALVE + J.G. CONNECTION</td> <td>1</td> <td>PZ</td> </tr> <tr> <td>EL1424A0</td> <td>D8 CONNECTION WATER SOLENOID VALVE</td> <td>2</td> <td>PZ</td> </tr> <tr> <td>EL1436A0</td> <td>H2O SOLENOID JG D8 CHECK VALVE</td> <td>1</td> <td>PZ</td> </tr> <tr> <td>GN1526A0</td> <td>INT. D.=6.9 TH=1.8 O-RIN</td> <td>1</td> <td>PZ</td> </tr> </tbody> </table>	Code	Description	Qty	UOM	0H7820A0	PLUS WASHING SY SUPPORT WITH STEAM VALVE	1	PZ	EL1252A1	1 WAY WATER VALVE + J.G. CONNECTION	1	PZ	EL1424A0	D8 CONNECTION WATER SOLENOID VALVE	2	PZ	EL1436A0	H2O SOLENOID JG D8 CHECK VALVE	1	PZ	GN1526A0	INT. D.=6.9 TH=1.8 O-RIN	1	PZ																											
Code	Description	Qty	UOM																																																		
0H7820A0	PLUS WASHING SY SUPPORT WITH STEAM VALVE	1	PZ																																																		
EL1252A1	1 WAY WATER VALVE + J.G. CONNECTION	1	PZ																																																		
EL1424A0	D8 CONNECTION WATER SOLENOID VALVE	2	PZ																																																		
EL1436A0	H2O SOLENOID JG D8 CHECK VALVE	1	PZ																																																		
GN1526A0	INT. D.=6.9 TH=1.8 O-RIN	1	PZ																																																		

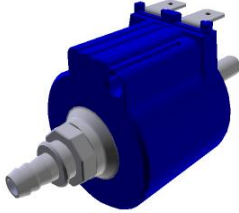

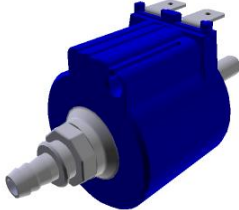

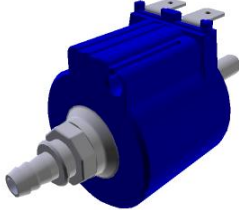
COMPONENT			SPARE PART																																																																													
Code	Description	Image	Code	Description	Components list																																																																											
VL1019A	VIBRATION PUMP		KVL1103A	EUR 2 ROTOR ARMS PLUS CLEANING SYSTEM KIT	<table border="1"> <thead> <tr> <th>Code</th> <th>Description</th> <th>Qty</th> <th>UOM</th> </tr> </thead> <tbody> <tr> <td>RC1019A0</td> <td>D=10 ELASTIC CLAMP</td> <td>12</td> <td>PZ</td> </tr> <tr> <td>RC1130A0</td> <td>130X2,6 CLAM</td> <td>1</td> <td>PZ</td> </tr> <tr> <td>RC1242A0</td> <td>D=10 CLOSED CAP</td> <td>2</td> <td>PZ</td> </tr> <tr> <td>RC1356A0</td> <td>STRAIGHT THREADED FEMALE END 8X1/4" BSP</td> <td>1</td> <td>PZ</td> </tr> <tr> <td>TB2820A0</td> <td>PIPE EPDM FOR WASHING SYSTEM</td> <td>1.410</td> <td>M</td> </tr> <tr> <td>VI1220A1</td> <td>4,2X12 TCB SELF-TAPPIN G SCREW</td> <td>3</td> <td>PZ</td> </tr> <tr> <td>VL1019A0</td> <td>VIBRATION PUMP</td> <td>1</td> <td>PZ</td> </tr> <tr> <td>VL1065A1</td> <td>1/4 MALE N.O. PRESSURE SWITCH</td> <td>1</td> <td>PZ</td> </tr> <tr> <td>VL1067A0</td> <td>WASHING SYSTEM INLETS DISTRIBUTOR</td> <td>1</td> <td>PZ</td> </tr> <tr> <td>VL1092A0</td> <td>WASHING SYSTEM OUTLET DOUBLE DISTRIBUTOR</td> <td>1</td> <td>PZ</td> </tr> <tr> <td>VL1102A1</td> <td>DETERGENT LINE FILTER + BARBED VNR 6 MM</td> <td>1</td> <td>PZ</td> </tr> <tr> <td>VL1128A0</td> <td>BARBED CHECK VALVE D6</td> <td>1</td> <td>PZ</td> </tr> <tr> <td>VM2172A0</td> <td>PUMP LOCKING CLIP</td> <td>1</td> <td>PZ</td> </tr> </tbody> </table>	Code	Description	Qty	UOM	RC1019A0	D=10 ELASTIC CLAMP	12	PZ	RC1130A0	130X2,6 CLAM	1	PZ	RC1242A0	D=10 CLOSED CAP	2	PZ	RC1356A0	STRAIGHT THREADED FEMALE END 8X1/4" BSP	1	PZ	TB2820A0	PIPE EPDM FOR WASHING SYSTEM	1.410	M	VI1220A1	4,2X12 TCB SELF-TAPPIN G SCREW	3	PZ	VL1019A0	VIBRATION PUMP	1	PZ	VL1065A1	1/4 MALE N.O. PRESSURE SWITCH	1	PZ	VL1067A0	WASHING SYSTEM INLETS DISTRIBUTOR	1	PZ	VL1092A0	WASHING SYSTEM OUTLET DOUBLE DISTRIBUTOR	1	PZ	VL1102A1	DETERGENT LINE FILTER + BARBED VNR 6 MM	1	PZ	VL1128A0	BARBED CHECK VALVE D6	1	PZ	VM2172A0	PUMP LOCKING CLIP	1	PZ	KVL1101A	EUR 1 ROTOR ARM PLUS CLEANING SYSTEM KIT	<table border="1"> <thead> <tr> <th>Code</th> <th>Description</th> <th>Qty</th> <th>UOM</th> </tr> </thead> <tbody> <tr> <td>0H7820A0</td> <td>PLUS WASHING SY SUPPORT WITH STEAM VALVE</td> <td>1</td> <td>PZ</td> </tr> <tr> <td>EL1252A1</td> <td>1 WAY WATER VALVE + J.G. CONNECTION</td> <td>1</td> <td>PZ</td> </tr> <tr> <td>EL1424A0</td> <td>D8 CONNECTION WATER SOLENOID VALVE</td> <td>1</td> <td>PZ</td> </tr> </tbody> </table>	Code	Description	Qty	UOM	0H7820A0	PLUS WASHING SY SUPPORT WITH STEAM VALVE	1	PZ	EL1252A1	1 WAY WATER VALVE + J.G. CONNECTION	1	PZ	EL1424A0	D8 CONNECTION WATER SOLENOID VALVE	1	PZ
			Code	Description	Qty	UOM																																																																										
RC1019A0	D=10 ELASTIC CLAMP	12	PZ																																																																													
RC1130A0	130X2,6 CLAM	1	PZ																																																																													
RC1242A0	D=10 CLOSED CAP	2	PZ																																																																													
RC1356A0	STRAIGHT THREADED FEMALE END 8X1/4" BSP	1	PZ																																																																													
TB2820A0	PIPE EPDM FOR WASHING SYSTEM	1.410	M																																																																													
VI1220A1	4,2X12 TCB SELF-TAPPIN G SCREW	3	PZ																																																																													
VL1019A0	VIBRATION PUMP	1	PZ																																																																													
VL1065A1	1/4 MALE N.O. PRESSURE SWITCH	1	PZ																																																																													
VL1067A0	WASHING SYSTEM INLETS DISTRIBUTOR	1	PZ																																																																													
VL1092A0	WASHING SYSTEM OUTLET DOUBLE DISTRIBUTOR	1	PZ																																																																													
VL1102A1	DETERGENT LINE FILTER + BARBED VNR 6 MM	1	PZ																																																																													
VL1128A0	BARBED CHECK VALVE D6	1	PZ																																																																													
VM2172A0	PUMP LOCKING CLIP	1	PZ																																																																													
Code	Description	Qty	UOM																																																																													
0H7820A0	PLUS WASHING SY SUPPORT WITH STEAM VALVE	1	PZ																																																																													
EL1252A1	1 WAY WATER VALVE + J.G. CONNECTION	1	PZ																																																																													
EL1424A0	D8 CONNECTION WATER SOLENOID VALVE	1	PZ																																																																													

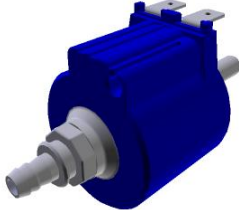
COMPONENT			SPARE PART																																																																																	
Code	Description	Image	Code	Description	Components list																																																																															
VL1019A	VIBRATION PUMP		KVL1101A	EUR 1 ROTOR ARM PLUS CLEANING SYSTEM KIT	<table border="1"> <thead> <tr> <th>Code</th> <th>Description</th> <th>Qty</th> <th>UOM</th> </tr> </thead> <tbody> <tr> <td>EL1436A0</td> <td>H2O SOLENOID JG D8 CHECK VALVE</td> <td>1</td> <td>PZ</td> </tr> <tr> <td>GN1526A0</td> <td>INT. D.=6.9 TH=1.8 O-RIN</td> <td>1</td> <td>PZ</td> </tr> <tr> <td>RC1019A0</td> <td>D=10 ELASTIC CLAMP</td> <td>12</td> <td>PZ</td> </tr> <tr> <td>RC1130A0</td> <td>130X2,6 CLAM</td> <td>1</td> <td>PZ</td> </tr> <tr> <td>RC1242A0</td> <td>D=10 CLOSED CAP</td> <td>2</td> <td>PZ</td> </tr> <tr> <td>RC1356A0</td> <td>STRAIGHT THREADED FEMALE END 8X1/4" BSP</td> <td>1</td> <td>PZ</td> </tr> <tr> <td>TB2820A0</td> <td>PIPE EPDM FOR WASHING SYSTEM</td> <td>1.410</td> <td>M</td> </tr> <tr> <td>VI1220A1</td> <td>4,2X12 TCB SELF-TAPPIN G SCREW</td> <td>3</td> <td>PZ</td> </tr> <tr> <td>VL1019A0</td> <td>VIBRATION PUMP</td> <td>1</td> <td>PZ</td> </tr> <tr> <td>VL1064A0</td> <td>WASHING SYSTEM OUTLETS DISTRIBUTOR</td> <td>1</td> <td>PZ</td> </tr> <tr> <td>VL1065A1</td> <td>1/4 MALE N.O. PRESSURE SWITCH</td> <td>1</td> <td>PZ</td> </tr> <tr> <td>VL1067A0</td> <td>WASHING SYSTEM INLETS DISTRIBUTOR</td> <td>1</td> <td>PZ</td> </tr> <tr> <td>VL1102A1</td> <td>DETERGENT LINE FILTER + BARBED VNR 6 MM</td> <td>1</td> <td>PZ</td> </tr> <tr> <td>VL1128A0</td> <td>BARBED CHECK VALVE D6</td> <td>1</td> <td>PZ</td> </tr> <tr> <td>VM2172A0</td> <td>PUMP LOCKING CLIP</td> <td>1</td> <td>PZ</td> </tr> </tbody> </table>	Code	Description	Qty	UOM	EL1436A0	H2O SOLENOID JG D8 CHECK VALVE	1	PZ	GN1526A0	INT. D.=6.9 TH=1.8 O-RIN	1	PZ	RC1019A0	D=10 ELASTIC CLAMP	12	PZ	RC1130A0	130X2,6 CLAM	1	PZ	RC1242A0	D=10 CLOSED CAP	2	PZ	RC1356A0	STRAIGHT THREADED FEMALE END 8X1/4" BSP	1	PZ	TB2820A0	PIPE EPDM FOR WASHING SYSTEM	1.410	M	VI1220A1	4,2X12 TCB SELF-TAPPIN G SCREW	3	PZ	VL1019A0	VIBRATION PUMP	1	PZ	VL1064A0	WASHING SYSTEM OUTLETS DISTRIBUTOR	1	PZ	VL1065A1	1/4 MALE N.O. PRESSURE SWITCH	1	PZ	VL1067A0	WASHING SYSTEM INLETS DISTRIBUTOR	1	PZ	VL1102A1	DETERGENT LINE FILTER + BARBED VNR 6 MM	1	PZ	VL1128A0	BARBED CHECK VALVE D6	1	PZ	VM2172A0	PUMP LOCKING CLIP	1	PZ	KVL1094A	0311 EUR CLEANING SYSTEM KIT	<table border="1"> <thead> <tr> <th>Code</th> <th>Description</th> <th>Qty</th> <th>UOM</th> </tr> </thead> <tbody> <tr> <td>0H7494B0</td> <td>ONE-03 WASHING SYST HOLDING PLATE</td> <td>1</td> <td>PZ</td> </tr> <tr> <td>EL1436A0</td> <td>H2O SOLENOID JG D8 CHECK VALVE</td> <td>1</td> <td>PZ</td> </tr> </tbody> </table>	Code	Description	Qty	UOM	0H7494B0	ONE-03 WASHING SYST HOLDING PLATE	1	PZ	EL1436A0	H2O SOLENOID JG D8 CHECK VALVE	1	PZ
			Code	Description	Qty	UOM																																																																														
EL1436A0	H2O SOLENOID JG D8 CHECK VALVE	1	PZ																																																																																	
GN1526A0	INT. D.=6.9 TH=1.8 O-RIN	1	PZ																																																																																	
RC1019A0	D=10 ELASTIC CLAMP	12	PZ																																																																																	
RC1130A0	130X2,6 CLAM	1	PZ																																																																																	
RC1242A0	D=10 CLOSED CAP	2	PZ																																																																																	
RC1356A0	STRAIGHT THREADED FEMALE END 8X1/4" BSP	1	PZ																																																																																	
TB2820A0	PIPE EPDM FOR WASHING SYSTEM	1.410	M																																																																																	
VI1220A1	4,2X12 TCB SELF-TAPPIN G SCREW	3	PZ																																																																																	
VL1019A0	VIBRATION PUMP	1	PZ																																																																																	
VL1064A0	WASHING SYSTEM OUTLETS DISTRIBUTOR	1	PZ																																																																																	
VL1065A1	1/4 MALE N.O. PRESSURE SWITCH	1	PZ																																																																																	
VL1067A0	WASHING SYSTEM INLETS DISTRIBUTOR	1	PZ																																																																																	
VL1102A1	DETERGENT LINE FILTER + BARBED VNR 6 MM	1	PZ																																																																																	
VL1128A0	BARBED CHECK VALVE D6	1	PZ																																																																																	
VM2172A0	PUMP LOCKING CLIP	1	PZ																																																																																	
Code	Description	Qty	UOM																																																																																	
0H7494B0	ONE-03 WASHING SYST HOLDING PLATE	1	PZ																																																																																	
EL1436A0	H2O SOLENOID JG D8 CHECK VALVE	1	PZ																																																																																	

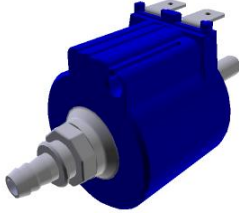

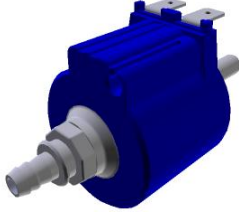
COMPONENT			SPARE PART																																														
Code	Description	Image	Code	Description	Components list																																												
VL1019A	VIBRATION PUMP		KVL1094A	0311 EUR CLEANING SYSTEM KIT	<table border="1"> <thead> <tr> <th>Code</th> <th>Description</th> <th>Qty</th> <th>UOM</th> </tr> </thead> <tbody> <tr> <td>GN1526A0</td> <td>INT. D.=6.9 TH=1.8 O-RIN</td> <td>1</td> <td>PZ</td> </tr> <tr> <td>RC1242A0</td> <td>D=10 CLOSED CAP</td> <td>2</td> <td>PZ</td> </tr> <tr> <td>TB2820A0</td> <td>PIPE EPDM FOR WASHING SYSTEM</td> <td>1.420</td> <td>M</td> </tr> <tr> <td>VI1220A1</td> <td>4,2X12 TCB SELF-TAPPIN G SCREW</td> <td>1</td> <td>PZ</td> </tr> <tr> <td>VL1019A0</td> <td>VIBRATION PUMP</td> <td>1</td> <td>PZ</td> </tr> <tr> <td>VL1053B0</td> <td>ONE WASHING SYS EXT DISTRIBUTOR</td> <td>1</td> <td>PZ</td> </tr> <tr> <td>VL1054B0</td> <td>ONE WASHING SYS INLET DISTRIBUTOR</td> <td>1</td> <td>PZ</td> </tr> <tr> <td>VL1102A1</td> <td>DETERGENT LINE FILTER + BARBED VNR 6 MM</td> <td>1</td> <td>PZ</td> </tr> <tr> <td>VL1128A0</td> <td>BARBED CHECK VALVE D6</td> <td>1</td> <td>PZ</td> </tr> <tr> <td>VM2172A0</td> <td>PUMP LOCKING CLIP</td> <td>1</td> <td>PZ</td> </tr> </tbody> </table>	Code	Description	Qty	UOM	GN1526A0	INT. D.=6.9 TH=1.8 O-RIN	1	PZ	RC1242A0	D=10 CLOSED CAP	2	PZ	TB2820A0	PIPE EPDM FOR WASHING SYSTEM	1.420	M	VI1220A1	4,2X12 TCB SELF-TAPPIN G SCREW	1	PZ	VL1019A0	VIBRATION PUMP	1	PZ	VL1053B0	ONE WASHING SYS EXT DISTRIBUTOR	1	PZ	VL1054B0	ONE WASHING SYS INLET DISTRIBUTOR	1	PZ	VL1102A1	DETERGENT LINE FILTER + BARBED VNR 6 MM	1	PZ	VL1128A0	BARBED CHECK VALVE D6	1	PZ	VM2172A0	PUMP LOCKING CLIP	1	PZ
			Code	Description	Qty	UOM																																											
GN1526A0	INT. D.=6.9 TH=1.8 O-RIN	1	PZ																																														
RC1242A0	D=10 CLOSED CAP	2	PZ																																														
TB2820A0	PIPE EPDM FOR WASHING SYSTEM	1.420	M																																														
VI1220A1	4,2X12 TCB SELF-TAPPIN G SCREW	1	PZ																																														
VL1019A0	VIBRATION PUMP	1	PZ																																														
VL1053B0	ONE WASHING SYS EXT DISTRIBUTOR	1	PZ																																														
VL1054B0	ONE WASHING SYS INLET DISTRIBUTOR	1	PZ																																														
VL1102A1	DETERGENT LINE FILTER + BARBED VNR 6 MM	1	PZ																																														
VL1128A0	BARBED CHECK VALVE D6	1	PZ																																														
VM2172A0	PUMP LOCKING CLIP	1	PZ																																														
KVL1092A	EUR 2 ROTOR ARMS PLUS CHEMICAL PUMP KIT	<table border="1"> <thead> <tr> <th>Code</th> <th>Description</th> <th>Qty</th> <th>UOM</th> </tr> </thead> <tbody> <tr> <td>GN1526A0</td> <td>INT. D.=6.9 TH=1.8 O-RIN</td> <td>1</td> <td>PZ</td> </tr> <tr> <td>RC1019A0</td> <td>D=10 ELASTIC CLAMP</td> <td>6</td> <td>PZ</td> </tr> <tr> <td>RC1130A0</td> <td>130X2,6 CLAM</td> <td>1</td> <td>PZ</td> </tr> <tr> <td>RC1242A0</td> <td>D=10 CLOSED CAP</td> <td>2</td> <td>PZ</td> </tr> <tr> <td>TB2820A0</td> <td>PIPE EPDM FOR WASHING SYSTEM</td> <td>0.120</td> <td>M</td> </tr> <tr> <td>VL1019A0</td> <td>VIBRATION PUMP</td> <td>1</td> <td>PZ</td> </tr> <tr> <td>VL1067A0</td> <td>WASHING SYSTEM INLETS DISTRIBUTOR</td> <td>1</td> <td>PZ</td> </tr> <tr> <td>VL1092A0</td> <td>WASHING SYSTEM OUTLET DOUBLE DISTRIBUTOR</td> <td>1</td> <td>PZ</td> </tr> <tr> <td>VL1128A0</td> <td>BARBED CHECK VALVE D6</td> <td>1</td> <td>PZ</td> </tr> <tr> <td>VM2172A0</td> <td>PUMP LOCKING CLIP</td> <td>1</td> <td>PZ</td> </tr> </tbody> </table>	Code	Description	Qty	UOM	GN1526A0	INT. D.=6.9 TH=1.8 O-RIN	1	PZ	RC1019A0	D=10 ELASTIC CLAMP	6	PZ	RC1130A0	130X2,6 CLAM	1	PZ	RC1242A0	D=10 CLOSED CAP	2	PZ	TB2820A0	PIPE EPDM FOR WASHING SYSTEM	0.120	M	VL1019A0	VIBRATION PUMP	1	PZ	VL1067A0	WASHING SYSTEM INLETS DISTRIBUTOR	1	PZ	VL1092A0	WASHING SYSTEM OUTLET DOUBLE DISTRIBUTOR	1	PZ	VL1128A0	BARBED CHECK VALVE D6	1	PZ	VM2172A0	PUMP LOCKING CLIP	1	PZ			
Code	Description	Qty	UOM																																														
GN1526A0	INT. D.=6.9 TH=1.8 O-RIN	1	PZ																																														
RC1019A0	D=10 ELASTIC CLAMP	6	PZ																																														
RC1130A0	130X2,6 CLAM	1	PZ																																														
RC1242A0	D=10 CLOSED CAP	2	PZ																																														
TB2820A0	PIPE EPDM FOR WASHING SYSTEM	0.120	M																																														
VL1019A0	VIBRATION PUMP	1	PZ																																														
VL1067A0	WASHING SYSTEM INLETS DISTRIBUTOR	1	PZ																																														
VL1092A0	WASHING SYSTEM OUTLET DOUBLE DISTRIBUTOR	1	PZ																																														
VL1128A0	BARBED CHECK VALVE D6	1	PZ																																														
VM2172A0	PUMP LOCKING CLIP	1	PZ																																														





COMPONENT			SPARE PART																																														
Code	Description	Image	Code	Description	Components list																																												
VL1019A	VIBRATION PUMP		KVL1073A	EUR 1 ROTOR ARM PLUS CHEMICAL PUMP KIT	<table border="1"> <thead> <tr> <th>Code</th> <th>Description</th> <th>Qty</th> <th>UOM</th> </tr> </thead> <tbody> <tr> <td>GN1526A0</td> <td>INT. D.=6.9 TH=1.8 O-RIN</td> <td>1</td> <td>PZ</td> </tr> <tr> <td>RC1019A0</td> <td>D=10 ELASTIC CLAMP</td> <td>6</td> <td>PZ</td> </tr> <tr> <td>RC1130A0</td> <td>130X2,6 CLAM</td> <td>1</td> <td>PZ</td> </tr> <tr> <td>RC1242A0</td> <td>D=10 CLOSED CAP</td> <td>2</td> <td>PZ</td> </tr> <tr> <td>TB2820A0</td> <td>PIPE EPDM FOR WASHING SYSTEM</td> <td>0.120</td> <td>M</td> </tr> <tr> <td>VL1019A0</td> <td>VIBRATION PUMP</td> <td>1</td> <td>PZ</td> </tr> <tr> <td>VL1064A0</td> <td>WASHING SYSTEM OUTLETS DISTRIBUTOR</td> <td>1</td> <td>PZ</td> </tr> <tr> <td>VL1067A0</td> <td>WASHING SYSTEM INLETS DISTRIBUTOR</td> <td>1</td> <td>PZ</td> </tr> <tr> <td>VL1128A0</td> <td>BARBED CHECK VALVE D6</td> <td>1</td> <td>PZ</td> </tr> <tr> <td>VM2172A0</td> <td>PUMP LOCKING CLIP</td> <td>1</td> <td>PZ</td> </tr> </tbody> </table>	Code	Description	Qty	UOM	GN1526A0	INT. D.=6.9 TH=1.8 O-RIN	1	PZ	RC1019A0	D=10 ELASTIC CLAMP	6	PZ	RC1130A0	130X2,6 CLAM	1	PZ	RC1242A0	D=10 CLOSED CAP	2	PZ	TB2820A0	PIPE EPDM FOR WASHING SYSTEM	0.120	M	VL1019A0	VIBRATION PUMP	1	PZ	VL1064A0	WASHING SYSTEM OUTLETS DISTRIBUTOR	1	PZ	VL1067A0	WASHING SYSTEM INLETS DISTRIBUTOR	1	PZ	VL1128A0	BARBED CHECK VALVE D6	1	PZ	VM2172A0	PUMP LOCKING CLIP	1	PZ
			Code	Description	Qty	UOM																																											
GN1526A0	INT. D.=6.9 TH=1.8 O-RIN	1	PZ																																														
RC1019A0	D=10 ELASTIC CLAMP	6	PZ																																														
RC1130A0	130X2,6 CLAM	1	PZ																																														
RC1242A0	D=10 CLOSED CAP	2	PZ																																														
TB2820A0	PIPE EPDM FOR WASHING SYSTEM	0.120	M																																														
VL1019A0	VIBRATION PUMP	1	PZ																																														
VL1064A0	WASHING SYSTEM OUTLETS DISTRIBUTOR	1	PZ																																														
VL1067A0	WASHING SYSTEM INLETS DISTRIBUTOR	1	PZ																																														
VL1128A0	BARBED CHECK VALVE D6	1	PZ																																														
VM2172A0	PUMP LOCKING CLIP	1	PZ																																														
KVL1072A	ONE SERIES CHEMICAL PUMP KI	<table border="1"> <thead> <tr> <th>Code</th> <th>Description</th> <th>Qty</th> <th>UOM</th> </tr> </thead> <tbody> <tr> <td>GN1526A0</td> <td>INT. D.=6.9 TH=1.8 O-RIN</td> <td>1</td> <td>PZ</td> </tr> <tr> <td>RC1019A0</td> <td>D=10 ELASTIC CLAMP</td> <td>6</td> <td>PZ</td> </tr> <tr> <td>RC1242A0</td> <td>D=10 CLOSED CAP</td> <td>2</td> <td>PZ</td> </tr> <tr> <td>TB2820A0</td> <td>PIPE EPDM FOR WASHING SYSTEM</td> <td>0.120</td> <td>M</td> </tr> <tr> <td>VI1220A1</td> <td>4,2X12 TCB SELF-TAPPIN G SCREW</td> <td>1</td> <td>PZ</td> </tr> <tr> <td>VL1019A0</td> <td>VIBRATION PUMP</td> <td>1</td> <td>PZ</td> </tr> <tr> <td>VL1053B0</td> <td>ONE WASHING SYS EXT DISTRIBUTOR</td> <td>1</td> <td>PZ</td> </tr> <tr> <td>VL1054B0</td> <td>ONE WASHING SYS INLET DISTRIBUTOR</td> <td>1</td> <td>PZ</td> </tr> <tr> <td>VL1128A0</td> <td>BARBED CHECK VALVE D6</td> <td>1</td> <td>PZ</td> </tr> <tr> <td>VM2172A0</td> <td>PUMP LOCKING CLIP</td> <td>1</td> <td>PZ</td> </tr> </tbody> </table>	Code	Description	Qty	UOM	GN1526A0	INT. D.=6.9 TH=1.8 O-RIN	1	PZ	RC1019A0	D=10 ELASTIC CLAMP	6	PZ	RC1242A0	D=10 CLOSED CAP	2	PZ	TB2820A0	PIPE EPDM FOR WASHING SYSTEM	0.120	M	VI1220A1	4,2X12 TCB SELF-TAPPIN G SCREW	1	PZ	VL1019A0	VIBRATION PUMP	1	PZ	VL1053B0	ONE WASHING SYS EXT DISTRIBUTOR	1	PZ	VL1054B0	ONE WASHING SYS INLET DISTRIBUTOR	1	PZ	VL1128A0	BARBED CHECK VALVE D6	1	PZ	VM2172A0	PUMP LOCKING CLIP	1	PZ			
Code	Description	Qty	UOM																																														
GN1526A0	INT. D.=6.9 TH=1.8 O-RIN	1	PZ																																														
RC1019A0	D=10 ELASTIC CLAMP	6	PZ																																														
RC1242A0	D=10 CLOSED CAP	2	PZ																																														
TB2820A0	PIPE EPDM FOR WASHING SYSTEM	0.120	M																																														
VI1220A1	4,2X12 TCB SELF-TAPPIN G SCREW	1	PZ																																														
VL1019A0	VIBRATION PUMP	1	PZ																																														
VL1053B0	ONE WASHING SYS EXT DISTRIBUTOR	1	PZ																																														
VL1054B0	ONE WASHING SYS INLET DISTRIBUTOR	1	PZ																																														
VL1128A0	BARBED CHECK VALVE D6	1	PZ																																														
VM2172A0	PUMP LOCKING CLIP	1	PZ																																														





COMPONENT			SPARE PART																																																																														
Code	Description	Image	Code	Description	Components list																																																																												
VL1019A	VIBRATION PUMP		KVL0001A	LM TOP CLEANING SYSTEM KIT	<table border="1"> <thead> <tr> <th>Code</th> <th>Description</th> <th>Qty</th> <th>UOM</th> </tr> </thead> <tbody> <tr> <td>0H1226B0</td> <td>LINEMISSTOP WASHING SYTEM CIRCUIT COVE</td> <td>1</td> <td>PZ</td> </tr> <tr> <td>GN1312A0</td> <td>RUBBER CABLE-PASSI NG DE=26 DI=15 SP=10</td> <td>1</td> <td>PZ</td> </tr> <tr> <td>GN1526A0</td> <td>INT. D.=6.9 TH=1.8 O-RIN</td> <td>1</td> <td>PZ</td> </tr> <tr> <td>RC1019A0</td> <td>D=10 ELASTIC CLAMP</td> <td>5</td> <td>PZ</td> </tr> <tr> <td>RC1242A0</td> <td>D=10 CLOSED CAP</td> <td>2</td> <td>PZ</td> </tr> <tr> <td>RC1381A0</td> <td>BIFILAR PIPE CLIP D10.7</td> <td>3</td> <td>PZ</td> </tr> <tr> <td>TB2343A0</td> <td>9X6 PVC TRANSPAREN T PIPE</td> <td>1.650</td> <td>M</td> </tr> <tr> <td>TB2820A0</td> <td>PIPE EPDM FOR WASHING SYSTEM</td> <td>0.990</td> <td>M</td> </tr> <tr> <td>VH1220A1</td> <td>4,2X12 TCB SELF-TAPPIN G SCREW</td> <td>1</td> <td>PZ</td> </tr> <tr> <td>VL1019A0</td> <td>VIBRATION PUMP</td> <td>1</td> <td>PZ</td> </tr> <tr> <td>VL1041C0</td> <td>DETERGENT CAP WITH Ø12 HOLE</td> <td>1</td> <td>PZ</td> </tr> <tr> <td>VL1047A1</td> <td>D6 PIPE HOLDER - D8 J.G. TERMINAL</td> <td>1</td> <td>PZ</td> </tr> <tr> <td>VL1053B0</td> <td>ONE WASHING SYS EXT DISTRIBUTOR</td> <td>1</td> <td>PZ</td> </tr> <tr> <td>VL1054B0</td> <td>ONE WASHING SYS INLET DISTRIBUTOR</td> <td>1</td> <td>PZ</td> </tr> <tr> <td>VL1061A0</td> <td>HOLD DOWN WEIGHT+NET FILTER+NON-RET. V.</td> <td>1</td> <td>PZ</td> </tr> <tr> <td>VL1128A0</td> <td>BARBED CHECK VALVE D6</td> <td>2</td> <td>PZ</td> </tr> <tr> <td>VM1066A0</td> <td>SADDLE CLIP FOR CABLES PASSING</td> <td>3</td> <td>PZ</td> </tr> <tr> <td>VM1088A0</td> <td>NYLON CLICK CLAMP D7.9-D9.2</td> <td>1</td> <td>PZ</td> </tr> </tbody> </table>	Code	Description	Qty	UOM	0H1226B0	LINEMISSTOP WASHING SYTEM CIRCUIT COVE	1	PZ	GN1312A0	RUBBER CABLE-PASSI NG DE=26 DI=15 SP=10	1	PZ	GN1526A0	INT. D.=6.9 TH=1.8 O-RIN	1	PZ	RC1019A0	D=10 ELASTIC CLAMP	5	PZ	RC1242A0	D=10 CLOSED CAP	2	PZ	RC1381A0	BIFILAR PIPE CLIP D10.7	3	PZ	TB2343A0	9X6 PVC TRANSPAREN T PIPE	1.650	M	TB2820A0	PIPE EPDM FOR WASHING SYSTEM	0.990	M	VH1220A1	4,2X12 TCB SELF-TAPPIN G SCREW	1	PZ	VL1019A0	VIBRATION PUMP	1	PZ	VL1041C0	DETERGENT CAP WITH Ø12 HOLE	1	PZ	VL1047A1	D6 PIPE HOLDER - D8 J.G. TERMINAL	1	PZ	VL1053B0	ONE WASHING SYS EXT DISTRIBUTOR	1	PZ	VL1054B0	ONE WASHING SYS INLET DISTRIBUTOR	1	PZ	VL1061A0	HOLD DOWN WEIGHT+NET FILTER+NON-RET. V.	1	PZ	VL1128A0	BARBED CHECK VALVE D6	2	PZ	VM1066A0	SADDLE CLIP FOR CABLES PASSING	3	PZ	VM1088A0	NYLON CLICK CLAMP D7.9-D9.2	1	PZ
Code	Description	Qty	UOM																																																																														
0H1226B0	LINEMISSTOP WASHING SYTEM CIRCUIT COVE	1	PZ																																																																														
GN1312A0	RUBBER CABLE-PASSI NG DE=26 DI=15 SP=10	1	PZ																																																																														
GN1526A0	INT. D.=6.9 TH=1.8 O-RIN	1	PZ																																																																														
RC1019A0	D=10 ELASTIC CLAMP	5	PZ																																																																														
RC1242A0	D=10 CLOSED CAP	2	PZ																																																																														
RC1381A0	BIFILAR PIPE CLIP D10.7	3	PZ																																																																														
TB2343A0	9X6 PVC TRANSPAREN T PIPE	1.650	M																																																																														
TB2820A0	PIPE EPDM FOR WASHING SYSTEM	0.990	M																																																																														
VH1220A1	4,2X12 TCB SELF-TAPPIN G SCREW	1	PZ																																																																														
VL1019A0	VIBRATION PUMP	1	PZ																																																																														
VL1041C0	DETERGENT CAP WITH Ø12 HOLE	1	PZ																																																																														
VL1047A1	D6 PIPE HOLDER - D8 J.G. TERMINAL	1	PZ																																																																														
VL1053B0	ONE WASHING SYS EXT DISTRIBUTOR	1	PZ																																																																														
VL1054B0	ONE WASHING SYS INLET DISTRIBUTOR	1	PZ																																																																														
VL1061A0	HOLD DOWN WEIGHT+NET FILTER+NON-RET. V.	1	PZ																																																																														
VL1128A0	BARBED CHECK VALVE D6	2	PZ																																																																														
VM1066A0	SADDLE CLIP FOR CABLES PASSING	3	PZ																																																																														
VM1088A0	NYLON CLICK CLAMP D7.9-D9.2	1	PZ																																																																														

COMPONENT			SPARE PART																		
Code	Description	Image	Code	Description	Components list																
VL1019A	VIBRATION PUMP		KVL0001A	LM TOP CLEANING SYSTEM KIT	<table border="1"> <thead> <tr> <th>Code</th> <th>Description</th> <th>Qty</th> <th>UOM</th> </tr> </thead> <tbody> <tr> <td>VM1605A0</td> <td>CLIP TWIST LOCK DIAM. 10,2-12,7 MM</td> <td>1</td> <td>PZ</td> </tr> <tr> <td>VM2172A0</td> <td>PUMP LOCKING CLIP</td> <td>1</td> <td>PZ</td> </tr> </tbody> </table>	Code	Description	Qty	UOM	VM1605A0	CLIP TWIST LOCK DIAM. 10,2-12,7 MM	1	PZ	VM2172A0	PUMP LOCKING CLIP	1	PZ				
Code	Description	Qty	UOM																		
VM1605A0	CLIP TWIST LOCK DIAM. 10,2-12,7 MM	1	PZ																		
VM2172A0	PUMP LOCKING CLIP	1	PZ																		
VM2172A	PUMP LOCKING CLI		VM2172A0	PUMP LOCKING CLI																	
RC1019A	D=10 ELASTIC CLAM		KRC1019A	Ø10 ZINC PLATED ELASTIC CLAMP 15 PCS KIT	<table border="1"> <thead> <tr> <th>Code</th> <th>Description</th> <th>Qty</th> <th>UOM</th> </tr> </thead> <tbody> <tr> <td>RC1019A0</td> <td>D=10 ELASTIC CLAMP</td> <td>17</td> <td>PZ</td> </tr> </tbody> </table>	Code	Description	Qty	UOM	RC1019A0	D=10 ELASTIC CLAMP	17	PZ								
Code	Description	Qty	UOM																		
RC1019A0	D=10 ELASTIC CLAMP	17	PZ																		
VL1081A	D6 BARBED NO RETURN VALVE		KVL1128A	D6 VNR BARBED VALVE KIT	<table border="1"> <thead> <tr> <th>Code</th> <th>Description</th> <th>Qty</th> <th>UOM</th> </tr> </thead> <tbody> <tr> <td>RC1019A0</td> <td>D=10 ELASTIC CLAMP</td> <td>4</td> <td>PZ</td> </tr> <tr> <td>TB2820A0</td> <td>PIPE EPDM FOR WASHING SYSTEM</td> <td>0.080</td> <td>M</td> </tr> <tr> <td>VL1128A0</td> <td>BARBED CHECK VALVE D6</td> <td>1</td> <td>PZ</td> </tr> </tbody> </table>	Code	Description	Qty	UOM	RC1019A0	D=10 ELASTIC CLAMP	4	PZ	TB2820A0	PIPE EPDM FOR WASHING SYSTEM	0.080	M	VL1128A0	BARBED CHECK VALVE D6	1	PZ
Code	Description	Qty	UOM																		
RC1019A0	D=10 ELASTIC CLAMP	4	PZ																		
TB2820A0	PIPE EPDM FOR WASHING SYSTEM	0.080	M																		
VL1128A0	BARBED CHECK VALVE D6	1	PZ																		
RC1242A	D=10 CLOSED CAP		KRC1242A	Ø10 CLOSED CONNECTION 20PCS KIT	<table border="1"> <thead> <tr> <th>Code</th> <th>Description</th> <th>Qty</th> <th>UOM</th> </tr> </thead> <tbody> <tr> <td>RC1242A0</td> <td>D=10 CLOSED CAP</td> <td>20</td> <td>PZ</td> </tr> </tbody> </table>	Code	Description	Qty	UOM	RC1242A0	D=10 CLOSED CAP	20	PZ								
Code	Description	Qty	UOM																		
RC1242A0	D=10 CLOSED CAP	20	PZ																		







COMPONENT			SPARE PART																																														
Code	Description	Image	Code	Description	Components list																																												
VL1054B	ONE WASHING SYS INLET DISTRIBUTOR		KVL1054B	ONE WASHING SYST INLETS DISTRIBUTOR KIT	<table border="1"> <thead> <tr> <th>Code</th> <th>Description</th> <th>Qty</th> <th>UOM</th> </tr> </thead> <tbody> <tr> <td>VL1054B0</td> <td>ONE WASHING SYS INLET DISTRIBUTOR</td> <td>1</td> <td>PZ</td> </tr> </tbody> </table>	Code	Description	Qty	UOM	VL1054B0	ONE WASHING SYS INLET DISTRIBUTOR	1	PZ																																				
Code	Description	Qty	UOM																																														
VL1054B0	ONE WASHING SYS INLET DISTRIBUTOR	1	PZ																																														
VL1053B	ONE WASHING SYS EXT DISTRIBUTOR		KVL1072A	ONE SERIES CHEMICAL PUMP KI	<table border="1"> <thead> <tr> <th>Code</th> <th>Description</th> <th>Qty</th> <th>UOM</th> </tr> </thead> <tbody> <tr> <td>GN1526A0</td> <td>INT. D.=6.9 TH=1.8 O-RIN</td> <td>1</td> <td>PZ</td> </tr> <tr> <td>RC1019A0</td> <td>D=10 ELASTIC CLAMP</td> <td>6</td> <td>PZ</td> </tr> <tr> <td>RC1242A0</td> <td>D=10 CLOSED CAP</td> <td>2</td> <td>PZ</td> </tr> <tr> <td>TB2820A0</td> <td>PIPE EPDM FOR WASHING SYSTEM</td> <td>0.120</td> <td>M</td> </tr> <tr> <td>VI1220A1</td> <td>4,2X12 TCB SELF-TAPPIN G SCREW</td> <td>1</td> <td>PZ</td> </tr> <tr> <td>VL1019A0</td> <td>VIBRATION PUMP</td> <td>1</td> <td>PZ</td> </tr> <tr> <td>VL1053B0</td> <td>ONE WASHING SYS EXT DISTRIBUTOR</td> <td>1</td> <td>PZ</td> </tr> <tr> <td>VL1054B0</td> <td>ONE WASHING SYS INLET DISTRIBUTOR</td> <td>1</td> <td>PZ</td> </tr> <tr> <td>VL1128A0</td> <td>BARBED CHECK VALVE D6</td> <td>1</td> <td>PZ</td> </tr> <tr> <td>VM2172A0</td> <td>PUMP LOCKING CLIP</td> <td>1</td> <td>PZ</td> </tr> </tbody> </table>	Code	Description	Qty	UOM	GN1526A0	INT. D.=6.9 TH=1.8 O-RIN	1	PZ	RC1019A0	D=10 ELASTIC CLAMP	6	PZ	RC1242A0	D=10 CLOSED CAP	2	PZ	TB2820A0	PIPE EPDM FOR WASHING SYSTEM	0.120	M	VI1220A1	4,2X12 TCB SELF-TAPPIN G SCREW	1	PZ	VL1019A0	VIBRATION PUMP	1	PZ	VL1053B0	ONE WASHING SYS EXT DISTRIBUTOR	1	PZ	VL1054B0	ONE WASHING SYS INLET DISTRIBUTOR	1	PZ	VL1128A0	BARBED CHECK VALVE D6	1	PZ	VM2172A0	PUMP LOCKING CLIP	1	PZ
Code	Description	Qty	UOM																																														
GN1526A0	INT. D.=6.9 TH=1.8 O-RIN	1	PZ																																														
RC1019A0	D=10 ELASTIC CLAMP	6	PZ																																														
RC1242A0	D=10 CLOSED CAP	2	PZ																																														
TB2820A0	PIPE EPDM FOR WASHING SYSTEM	0.120	M																																														
VI1220A1	4,2X12 TCB SELF-TAPPIN G SCREW	1	PZ																																														
VL1019A0	VIBRATION PUMP	1	PZ																																														
VL1053B0	ONE WASHING SYS EXT DISTRIBUTOR	1	PZ																																														
VL1054B0	ONE WASHING SYS INLET DISTRIBUTOR	1	PZ																																														
VL1128A0	BARBED CHECK VALVE D6	1	PZ																																														
VM2172A0	PUMP LOCKING CLIP	1	PZ																																														
RC1408A	DOUBLE WIRE SPRING CLAMP D10.8 ZN		KRC1408A	4 PCS D10.8 DOUBLE WIRE SPRING CLAMP KIT	<table border="1"> <thead> <tr> <th>Code</th> <th>Description</th> <th>Qty</th> <th>UOM</th> </tr> </thead> <tbody> <tr> <td>RC1408A0</td> <td>DOUBLE WIRE SPRING CLAMP D10.8 ZN</td> <td>4</td> <td>PZ</td> </tr> </tbody> </table>	Code	Description	Qty	UOM	RC1408A0	DOUBLE WIRE SPRING CLAMP D10.8 ZN	4	PZ																																				
Code	Description	Qty	UOM																																														
RC1408A0	DOUBLE WIRE SPRING CLAMP D10.8 ZN	4	PZ																																														



COMPONENT			SPARE PART																		
Code	Description	Image	Code	Description	Components list																
EL1436A	H2O SOLENOID JG D8 CHECK VALVE		KEL1436A	D8 CONNECTION D6 SOLENOID VALVE KIT	<table border="1"> <thead> <tr> <th>Code</th> <th>Description</th> <th>Qty</th> <th>UOM</th> </tr> </thead> <tbody> <tr> <td>EL1436A0</td> <td>H2O SOLENOID JG D8 CHECK VALVE</td> <td>1</td> <td>PZ</td> </tr> </tbody> </table>	Code	Description	Qty	UOM	EL1436A0	H2O SOLENOID JG D8 CHECK VALVE	1	PZ								
Code	Description	Qty	UOM																		
EL1436A0	H2O SOLENOID JG D8 CHECK VALVE	1	PZ																		
TB3009B	TB3132A-ONE OVEN WASHING INLET		KTB1349A	JGØ8 TB1818A WATER INLET PIPE L30M KIT	<table border="1"> <thead> <tr> <th>Code</th> <th>Description</th> <th>Qty</th> <th>UOM</th> </tr> </thead> <tbody> <tr> <td>TB1818A0</td> <td>JG Ø8 BLUE PE PIPE</td> <td>30</td> <td>M</td> </tr> </tbody> </table>	Code	Description	Qty	UOM	TB1818A0	JG Ø8 BLUE PE PIPE	30	M								
Code	Description	Qty	UOM																		
TB1818A0	JG Ø8 BLUE PE PIPE	30	M																		
0H7819A	ONE WASHING SYS SUPPORT WITH STEAM VALVE		0H7819A0	ONE WASHING SYS SUPPORT WITH STEAM VALVE																	
VL1102A	DETERGENT LINE FILTER + BARBED VNR 6 MM		KVL1102A	DETERGENT FILTER + NRV KIT	<table border="1"> <thead> <tr> <th>Code</th> <th>Description</th> <th>Qty</th> <th>UOM</th> </tr> </thead> <tbody> <tr> <td>RC1019A0</td> <td>D=10 ELASTIC CLAMP</td> <td>5</td> <td>PZ</td> </tr> <tr> <td>TB2820A0</td> <td>PIPE EPDM FOR WASHING SYSTEM</td> <td>0.710</td> <td>M</td> </tr> <tr> <td>VL1102A1</td> <td>DETERGENT LINE FILTER + BARBED VNR 6 MM</td> <td>1</td> <td>PZ</td> </tr> </tbody> </table>	Code	Description	Qty	UOM	RC1019A0	D=10 ELASTIC CLAMP	5	PZ	TB2820A0	PIPE EPDM FOR WASHING SYSTEM	0.710	M	VL1102A1	DETERGENT LINE FILTER + BARBED VNR 6 MM	1	PZ
Code	Description	Qty	UOM																		
RC1019A0	D=10 ELASTIC CLAMP	5	PZ																		
TB2820A0	PIPE EPDM FOR WASHING SYSTEM	0.710	M																		
VL1102A1	DETERGENT LINE FILTER + BARBED VNR 6 MM	1	PZ																		
TB3256A			TB3256A0																		

COMPONENT			SPARE PART																										
Code	Description	Image	Code	Description	Components list																								
0E1352B	XEVC-2011-E EXTERNAL BOTTOM PANEL		0E1352B0	XEVC-2011-E EXTERNAL BOTTOM PANEL																									
TR1136A	330 °C 1 POLE SAFETY THERMOSTAT		KTR1136A	330 °C SAFETY THERMOSTAT KIT	<table border="1"> <thead> <tr> <th>Code</th> <th>Description</th> <th>Qty</th> <th>UOM</th> </tr> </thead> <tbody> <tr> <td>0H7030A0</td> <td>THERMOSTAT BULB INLET COVER</td> <td>1</td> <td>PZ</td> </tr> <tr> <td>GN1531A0</td> <td>THERMOSTAT BULB INLET SEALING</td> <td>1</td> <td>PZ</td> </tr> <tr> <td>SL1045A0</td> <td>S53 BLACK SILICONE - 80ML CARTRIDGE</td> <td>1</td> <td>PZ</td> </tr> <tr> <td>TR1136A0</td> <td>330 °C 1 POLE SAFETY THERMOSTAT</td> <td>1</td> <td>PZ</td> </tr> <tr> <td>VI1220A1</td> <td>4,2X12 TCB SELF-TAPPIN G SCREW</td> <td>3</td> <td>PZ</td> </tr> </tbody> </table>	Code	Description	Qty	UOM	0H7030A0	THERMOSTAT BULB INLET COVER	1	PZ	GN1531A0	THERMOSTAT BULB INLET SEALING	1	PZ	SL1045A0	S53 BLACK SILICONE - 80ML CARTRIDGE	1	PZ	TR1136A0	330 °C 1 POLE SAFETY THERMOSTAT	1	PZ	VI1220A1	4,2X12 TCB SELF-TAPPIN G SCREW	3	PZ
Code	Description	Qty	UOM																										
0H7030A0	THERMOSTAT BULB INLET COVER	1	PZ																										
GN1531A0	THERMOSTAT BULB INLET SEALING	1	PZ																										
SL1045A0	S53 BLACK SILICONE - 80ML CARTRIDGE	1	PZ																										
TR1136A0	330 °C 1 POLE SAFETY THERMOSTAT	1	PZ																										
VI1220A1	4,2X12 TCB SELF-TAPPIN G SCREW	3	PZ																										
VM2249A	COOKING CHAMBER FRONT CORNER		KVM2249A	CHAMBER FRONT PROFILE CORNER KIT	<table border="1"> <thead> <tr> <th>Code</th> <th>Description</th> <th>Qty</th> <th>UOM</th> </tr> </thead> <tbody> <tr> <td>VM2249A0</td> <td>COOKING CHAMBER FRONT CORNER</td> <td>1</td> <td>PZ</td> </tr> </tbody> </table>	Code	Description	Qty	UOM	VM2249A0	COOKING CHAMBER FRONT CORNER	1	PZ																
Code	Description	Qty	UOM																										
VM2249A0	COOKING CHAMBER FRONT CORNER	1	PZ																										
VM1810A	WATER RIGHT SEALING CAP		VM1810A0	WATER RIGHT SEALING CAP																									



COMPONENT			SPARE PART																						
Code	Description	Image	Code	Description	Components list																				
VM1811A	WATER LEFT SEALING CAP		VM1811A0	WATER LEFT SEALING CAP																					
VM2281A	DOOR LATCH HOLES COVER		KVM2281A	HOLE PLATE COVER KIT	<table border="1"> <thead> <tr> <th>Code</th> <th>Description</th> <th>Qty</th> <th>UOM</th> </tr> </thead> <tbody> <tr> <td>VM2281A0</td> <td>DOOR LATCH HOLES COVER</td> <td>1</td> <td>PZ</td> </tr> </tbody> </table>	Code	Description	Qty	UOM	VM2281A0	DOOR LATCH HOLES COVER	1	PZ												
Code	Description	Qty	UOM																						
VM2281A0	DOOR LATCH HOLES COVER	1	PZ																						
VL1026A	BEND FOR DRAIN PIPE		KVL1026A	DRAIN PIPE BEND KIT	<table border="1"> <thead> <tr> <th>Code</th> <th>Description</th> <th>Qty</th> <th>UOM</th> </tr> </thead> <tbody> <tr> <td>GN1400A0</td> <td>U-TRAP SEAL</td> <td>1</td> <td>PZ</td> </tr> <tr> <td>VL1026A0</td> <td>BEND FOR DRAIN PIPE</td> <td>1</td> <td>PZ</td> </tr> <tr> <td>VM2039A0</td> <td>DRAIN BEND FIXING RING</td> <td>1</td> <td>PZ</td> </tr> </tbody> </table>	Code	Description	Qty	UOM	GN1400A0	U-TRAP SEAL	1	PZ	VL1026A0	BEND FOR DRAIN PIPE	1	PZ	VM2039A0	DRAIN BEND FIXING RING	1	PZ				
Code	Description	Qty	UOM																						
GN1400A0	U-TRAP SEAL	1	PZ																						
VL1026A0	BEND FOR DRAIN PIPE	1	PZ																						
VM2039A0	DRAIN BEND FIXING RING	1	PZ																						
VM1505A	WALL PASSING WITH DIAPHRAGM		KVM1505A	THROUGH-WALL CONNECTION+DIAPHRAGM KIT	<table border="1"> <thead> <tr> <th>Code</th> <th>Description</th> <th>Qty</th> <th>UOM</th> </tr> </thead> <tbody> <tr> <td>VI1220A1</td> <td>4,2X12 TCB SELF-TAPPING SCREW</td> <td>1</td> <td>PZ</td> </tr> <tr> <td>VM1505A0</td> <td>WALL PASSING WITH DIAPHRAGM</td> <td>3</td> <td>PZ</td> </tr> <tr> <td>VM2055A0</td> <td>UPPER THROUGH-WALL CONNECTION</td> <td>1</td> <td>PZ</td> </tr> <tr> <td>VM2056A0</td> <td>LOWER THROUGH-WALL CONNECTION</td> <td>1</td> <td>PZ</td> </tr> </tbody> </table>	Code	Description	Qty	UOM	VI1220A1	4,2X12 TCB SELF-TAPPING SCREW	1	PZ	VM1505A0	WALL PASSING WITH DIAPHRAGM	3	PZ	VM2055A0	UPPER THROUGH-WALL CONNECTION	1	PZ	VM2056A0	LOWER THROUGH-WALL CONNECTION	1	PZ
Code	Description	Qty	UOM																						
VI1220A1	4,2X12 TCB SELF-TAPPING SCREW	1	PZ																						
VM1505A0	WALL PASSING WITH DIAPHRAGM	3	PZ																						
VM2055A0	UPPER THROUGH-WALL CONNECTION	1	PZ																						
VM2056A0	LOWER THROUGH-WALL CONNECTION	1	PZ																						



COMPONENT			SPARE PART										
Code	Description	Image	Code	Description	Components list								
VM1014A	RING MOUNTING OVEN TO THE FLOOR		KVM1014A	BRACKETS TO FIX OVEN TO FLOOR 4PCS KIT	<table border="1"> <thead> <tr> <th>Code</th> <th>Description</th> <th>Qty</th> <th>UOM</th> </tr> </thead> <tbody> <tr> <td>VM1014A0</td> <td>RING MOUNTING OVEN TO THE FLOOR</td> <td>4</td> <td>PZ</td> </tr> </tbody> </table>	Code	Description	Qty	UOM	VM1014A0	RING MOUNTING OVEN TO THE FLOOR	4	PZ
Code	Description	Qty	UOM										
VM1014A0	RING MOUNTING OVEN TO THE FLOOR	4	PZ										
VM2319A	DOOR SUPPORT PLASTIC BRACKET		KVM2319A	DOOR SUPPORT CAP KIT	<table border="1"> <thead> <tr> <th>Code</th> <th>Description</th> <th>Qty</th> <th>UOM</th> </tr> </thead> <tbody> <tr> <td>VM2319A0</td> <td>DOOR SUPPORT PLASTIC BRACKET</td> <td>1</td> <td>PZ</td> </tr> </tbody> </table>	Code	Description	Qty	UOM	VM2319A0	DOOR SUPPORT PLASTIC BRACKET	1	PZ
Code	Description	Qty	UOM										
VM2319A0	DOOR SUPPORT PLASTIC BRACKET	1	PZ										



ASM1804A/0.D02 - Cooking chamber

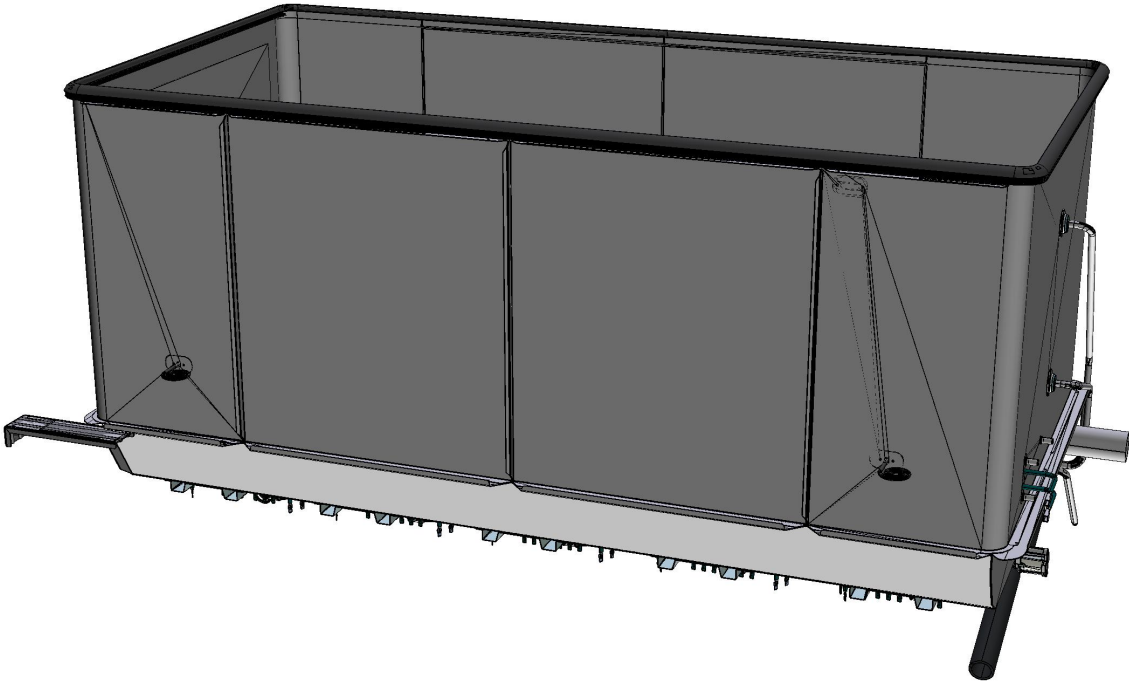

FRONT



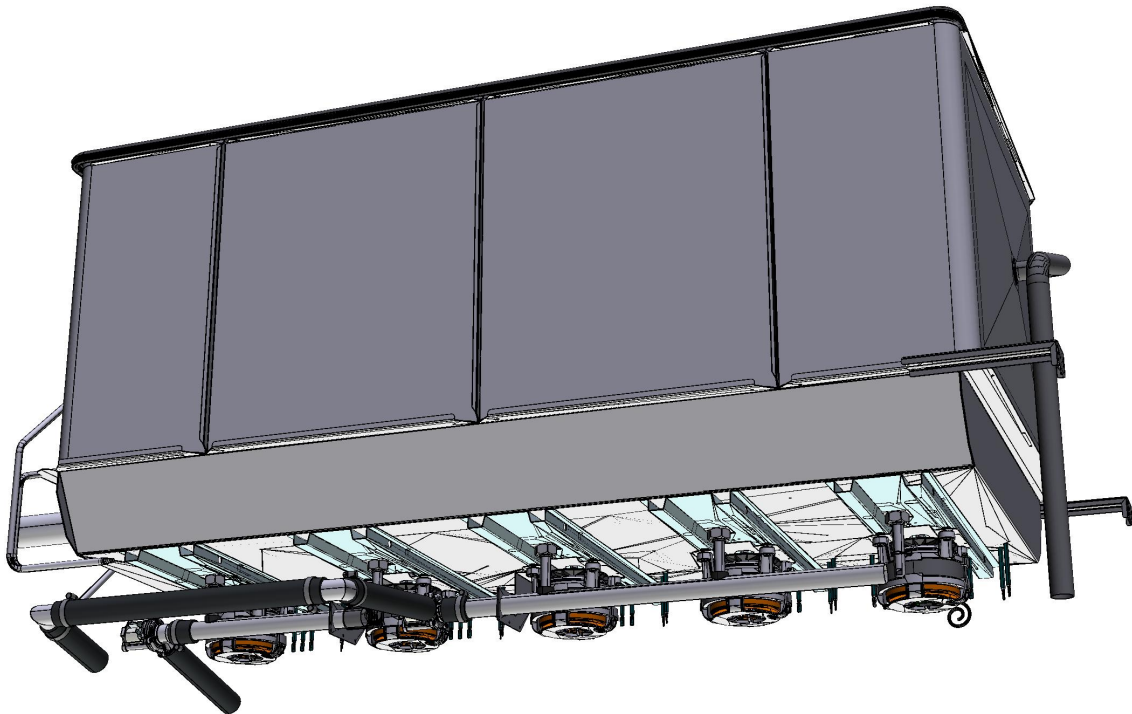

ASM1804A/0.D02 - Cooking chamber

REAR





COMPONENT			SPARE PART																										
Code	Description	Image	Code	Description	Components list																								
RS1215A	147W 105V BRAKING ELEMENT		KRS1215A	147W MOTOR BRAKING ELEMENT KIT	<table border="1"> <thead> <tr> <th>Code</th> <th>Description</th> <th>Qty</th> <th>UOM</th> </tr> </thead> <tbody> <tr> <td>GN1326A1</td> <td>ELEMENT SEALING</td> <td>1</td> <td>PZ</td> </tr> <tr> <td>RS1215A1</td> <td>147W 105V BRAKING ELEMENT</td> <td>1</td> <td>PZ</td> </tr> <tr> <td>SL1045A0</td> <td>S53 BLACK SILICONE - 80ML CARTRIDGE</td> <td>1</td> <td>PZ</td> </tr> <tr> <td>VI1220A1</td> <td>4,2X12 TCB SELF-TAPPIN G SCREW</td> <td>2</td> <td>PZ</td> </tr> </tbody> </table>	Code	Description	Qty	UOM	GN1326A1	ELEMENT SEALING	1	PZ	RS1215A1	147W 105V BRAKING ELEMENT	1	PZ	SL1045A0	S53 BLACK SILICONE - 80ML CARTRIDGE	1	PZ	VI1220A1	4,2X12 TCB SELF-TAPPIN G SCREW	2	PZ				
Code	Description	Qty	UOM																										
GN1326A1	ELEMENT SEALING	1	PZ																										
RS1215A1	147W 105V BRAKING ELEMENT	1	PZ																										
SL1045A0	S53 BLACK SILICONE - 80ML CARTRIDGE	1	PZ																										
VI1220A1	4,2X12 TCB SELF-TAPPIN G SCREW	2	PZ																										
GN1326A	ELEMENT SEALING		KRS1274A	100W MOTOR BRAKING ELEMENT KIT	<table border="1"> <thead> <tr> <th>Code</th> <th>Description</th> <th>Qty</th> <th>UOM</th> </tr> </thead> <tbody> <tr> <td>GN1326A1</td> <td>ELEMENT SEALING</td> <td>1</td> <td>PZ</td> </tr> <tr> <td>RS1274A0</td> <td>100W 60V 1 TURN FLAT ELEMENT</td> <td>1</td> <td>PZ</td> </tr> <tr> <td>SL1045A0</td> <td>S53 BLACK SILICONE - 80ML CARTRIDGE</td> <td>1</td> <td>PZ</td> </tr> <tr> <td>VI1220A1</td> <td>4,2X12 TCB SELF-TAPPIN G SCREW</td> <td>2</td> <td>PZ</td> </tr> </tbody> </table>	Code	Description	Qty	UOM	GN1326A1	ELEMENT SEALING	1	PZ	RS1274A0	100W 60V 1 TURN FLAT ELEMENT	1	PZ	SL1045A0	S53 BLACK SILICONE - 80ML CARTRIDGE	1	PZ	VI1220A1	4,2X12 TCB SELF-TAPPIN G SCREW	2	PZ				
Code	Description	Qty	UOM																										
GN1326A1	ELEMENT SEALING	1	PZ																										
RS1274A0	100W 60V 1 TURN FLAT ELEMENT	1	PZ																										
SL1045A0	S53 BLACK SILICONE - 80ML CARTRIDGE	1	PZ																										
VI1220A1	4,2X12 TCB SELF-TAPPIN G SCREW	2	PZ																										
			KRS1261A	122W MOTOR BREAKING ELEMENT KIT	<table border="1"> <thead> <tr> <th>Code</th> <th>Description</th> <th>Qty</th> <th>UOM</th> </tr> </thead> <tbody> <tr> <td>GN1326A1</td> <td>ELEMENT SEALING</td> <td>1</td> <td>PZ</td> </tr> <tr> <td>RS1261A0</td> <td>BAKERLUX\CH EFLUX MOTOR BREAKING ELEMENT</td> <td>1</td> <td>PZ</td> </tr> <tr> <td>SL1045A0</td> <td>S53 BLACK SILICONE - 80ML CARTRIDGE</td> <td>1</td> <td>PZ</td> </tr> <tr> <td>VI1220A1</td> <td>4,2X12 TCB SELF-TAPPIN G SCREW</td> <td>2</td> <td>PZ</td> </tr> <tr> <td>VM2147A0</td> <td>ESD SPONGE PINK SMOOTH 410X343X15 M</td> <td>1</td> <td>PZ</td> </tr> </tbody> </table>	Code	Description	Qty	UOM	GN1326A1	ELEMENT SEALING	1	PZ	RS1261A0	BAKERLUX\CH EFLUX MOTOR BREAKING ELEMENT	1	PZ	SL1045A0	S53 BLACK SILICONE - 80ML CARTRIDGE	1	PZ	VI1220A1	4,2X12 TCB SELF-TAPPIN G SCREW	2	PZ	VM2147A0	ESD SPONGE PINK SMOOTH 410X343X15 M	1	PZ
Code	Description	Qty	UOM																										
GN1326A1	ELEMENT SEALING	1	PZ																										
RS1261A0	BAKERLUX\CH EFLUX MOTOR BREAKING ELEMENT	1	PZ																										
SL1045A0	S53 BLACK SILICONE - 80ML CARTRIDGE	1	PZ																										
VI1220A1	4,2X12 TCB SELF-TAPPIN G SCREW	2	PZ																										
VM2147A0	ESD SPONGE PINK SMOOTH 410X343X15 M	1	PZ																										
			KRS1215A	147W MOTOR BRAKING ELEMENT KIT	<table border="1"> <thead> <tr> <th>Code</th> <th>Description</th> <th>Qty</th> <th>UOM</th> </tr> </thead> <tbody> <tr> <td>GN1326A1</td> <td>ELEMENT SEALING</td> <td>1</td> <td>PZ</td> </tr> <tr> <td>RS1215A1</td> <td>147W 105V BRAKING ELEMENT</td> <td>1</td> <td>PZ</td> </tr> </tbody> </table>	Code	Description	Qty	UOM	GN1326A1	ELEMENT SEALING	1	PZ	RS1215A1	147W 105V BRAKING ELEMENT	1	PZ												
Code	Description	Qty	UOM																										
GN1326A1	ELEMENT SEALING	1	PZ																										
RS1215A1	147W 105V BRAKING ELEMENT	1	PZ																										

COMPONENT			SPARE PART																														
Code	Description	Image	Code	Description	Components list																												
GN1326A	ELEMENT SEALING		KRS1215A	147W MOTOR BRAKING ELEMENT KIT	<table border="1"> <thead> <tr> <th>Code</th> <th>Description</th> <th>Qty</th> <th>UOM</th> </tr> </thead> <tbody> <tr> <td>SL1045A0</td> <td>S53 BLACK SILICONE - 80ML CARTRIDGE</td> <td>1</td> <td>PZ</td> </tr> <tr> <td>VI1220A1</td> <td>4,2X12 TCB SELF-TAPPIN G SCREW</td> <td>2</td> <td>PZ</td> </tr> </tbody> </table>	Code	Description	Qty	UOM	SL1045A0	S53 BLACK SILICONE - 80ML CARTRIDGE	1	PZ	VI1220A1	4,2X12 TCB SELF-TAPPIN G SCREW	2	PZ																
			Code	Description	Qty	UOM																											
			SL1045A0	S53 BLACK SILICONE - 80ML CARTRIDGE	1	PZ																											
			VI1220A1	4,2X12 TCB SELF-TAPPIN G SCREW	2	PZ																											
			KRS1095A	1.2KW HEATING ELEMENT KIT	<table border="1"> <thead> <tr> <th>Code</th> <th>Description</th> <th>Qty</th> <th>UOM</th> </tr> </thead> <tbody> <tr> <td>GN1326A1</td> <td>ELEMENT SEALING</td> <td>1</td> <td>PZ</td> </tr> <tr> <td>IP1385A1</td> <td>CORNER POLYSTYREN E PACKING 110X80X2000</td> <td>0.500</td> <td>M</td> </tr> <tr> <td>RS1095A1</td> <td>HEATING ELEMENT 1200W 230V</td> <td>1</td> <td>PZ</td> </tr> <tr> <td>SL1045A0</td> <td>S53 BLACK SILICONE - 80ML CARTRIDGE</td> <td>1</td> <td>PZ</td> </tr> <tr> <td>VI1220A1</td> <td>4,2X12 TCB SELF-TAPPIN G SCREW</td> <td>2</td> <td>PZ</td> </tr> <tr> <td>VM1059A1</td> <td>HEAT SHRINK FILM H800</td> <td>1.200</td> <td>M</td> </tr> </tbody> </table>	Code	Description	Qty	UOM	GN1326A1	ELEMENT SEALING	1	PZ	IP1385A1	CORNER POLYSTYREN E PACKING 110X80X2000	0.500	M	RS1095A1	HEATING ELEMENT 1200W 230V	1	PZ	SL1045A0	S53 BLACK SILICONE - 80ML CARTRIDGE	1	PZ	VI1220A1	4,2X12 TCB SELF-TAPPIN G SCREW	2	PZ	VM1059A1	HEAT SHRINK FILM H800	1.200	M
			Code	Description	Qty	UOM																											
			GN1326A1	ELEMENT SEALING	1	PZ																											
			IP1385A1	CORNER POLYSTYREN E PACKING 110X80X2000	0.500	M																											
			RS1095A1	HEATING ELEMENT 1200W 230V	1	PZ																											
			SL1045A0	S53 BLACK SILICONE - 80ML CARTRIDGE	1	PZ																											
			VI1220A1	4,2X12 TCB SELF-TAPPIN G SCREW	2	PZ																											
			VM1059A1	HEAT SHRINK FILM H800	1.200	M																											
KRS1012A	1365W 120V HEATING ELEMENT KIT	<table border="1"> <thead> <tr> <th>Code</th> <th>Description</th> <th>Qty</th> <th>UOM</th> </tr> </thead> <tbody> <tr> <td>GN1326A1</td> <td>ELEMENT SEALING</td> <td>1</td> <td>PZ</td> </tr> <tr> <td>RS1012A0</td> <td>CIRCULAR ELEMENT 1365W 120V</td> <td>1</td> <td>PZ</td> </tr> <tr> <td>VI1220A1</td> <td>4,2X12 TCB SELF-TAPPIN G SCREW</td> <td>5</td> <td>PZ</td> </tr> <tr> <td>VM1794A0</td> <td>250X4.8 PA66 BLACK CLAMP</td> <td>2</td> <td>PZ</td> </tr> <tr> <td>VM2103A0</td> <td>CLAMP LOCK</td> <td>2</td> <td>PZ</td> </tr> </tbody> </table>	Code	Description	Qty	UOM	GN1326A1	ELEMENT SEALING	1	PZ	RS1012A0	CIRCULAR ELEMENT 1365W 120V	1	PZ	VI1220A1	4,2X12 TCB SELF-TAPPIN G SCREW	5	PZ	VM1794A0	250X4.8 PA66 BLACK CLAMP	2	PZ	VM2103A0	CLAMP LOCK	2	PZ							
Code	Description	Qty	UOM																														
GN1326A1	ELEMENT SEALING	1	PZ																														
RS1012A0	CIRCULAR ELEMENT 1365W 120V	1	PZ																														
VI1220A1	4,2X12 TCB SELF-TAPPIN G SCREW	5	PZ																														
VM1794A0	250X4.8 PA66 BLACK CLAMP	2	PZ																														
VM2103A0	CLAMP LOCK	2	PZ																														
KRS1011A	ROBERTA/LISA HEATING ELEMENT KIT	<table border="1"> <thead> <tr> <th>Code</th> <th>Description</th> <th>Qty</th> <th>UOM</th> </tr> </thead> <tbody> <tr> <td>GN1326A1</td> <td>ELEMENT SEALING</td> <td>1</td> <td>PZ</td> </tr> <tr> <td>RS1011A0</td> <td>2560W 220-230V HEATING ELEMENT</td> <td>1</td> <td>PZ</td> </tr> <tr> <td>SL1045A0</td> <td>S53 BLACK SILICONE - 80ML CARTRIDGE</td> <td>1</td> <td>PZ</td> </tr> <tr> <td>VI1220A1</td> <td>4,2X12 TCB SELF-TAPPIN G SCREW</td> <td>5</td> <td>PZ</td> </tr> </tbody> </table>	Code	Description	Qty	UOM	GN1326A1	ELEMENT SEALING	1	PZ	RS1011A0	2560W 220-230V HEATING ELEMENT	1	PZ	SL1045A0	S53 BLACK SILICONE - 80ML CARTRIDGE	1	PZ	VI1220A1	4,2X12 TCB SELF-TAPPIN G SCREW	5	PZ											
Code	Description	Qty	UOM																														
GN1326A1	ELEMENT SEALING	1	PZ																														
RS1011A0	2560W 220-230V HEATING ELEMENT	1	PZ																														
SL1045A0	S53 BLACK SILICONE - 80ML CARTRIDGE	1	PZ																														
VI1220A1	4,2X12 TCB SELF-TAPPIN G SCREW	5	PZ																														



COMPONENT			SPARE PART																							
Code	Description	Image	Code	Description	Components list																					
GN1326A	ELEMENT SEALING		KRS1011A	ROBERTA/LISA HEATING ELEMENT KIT	<table border="1"> <thead> <tr> <th>Code</th> <th>Description</th> <th>Qty</th> <th>UOM</th> </tr> </thead> <tbody> <tr> <td>VM1794A0</td> <td>250X4.8 PA66 BLACK CLAMP</td> <td>2</td> <td>PZ</td> </tr> <tr> <td>VM2103A0</td> <td>CLAMP LOCK</td> <td>2</td> <td>PZ</td> </tr> </tbody> </table>	Code	Description	Qty	UOM	VM1794A0	250X4.8 PA66 BLACK CLAMP	2	PZ	VM2103A0	CLAMP LOCK	2	PZ									
			Code	Description	Qty	UOM																				
			VM1794A0	250X4.8 PA66 BLACK CLAMP	2	PZ																				
VM2103A0	CLAMP LOCK	2	PZ																							
KRS0090A	HEATING ELEMENT 1.26KW	<table border="1"> <thead> <tr> <th>Code</th> <th>Description</th> <th>Qty</th> <th>UOM</th> </tr> </thead> <tbody> <tr> <td>GN1326A1</td> <td>ELEMENT SEALING</td> <td>1</td> <td>PZ</td> </tr> <tr> <td>RS0090A0</td> <td>CIRC. HEAT. ELEMENT 1260W 220-230</td> <td>1</td> <td>PZ</td> </tr> <tr> <td>VI1220A1</td> <td>4,2X12 TCB SELF-TAPPIN G SCREW</td> <td>3</td> <td>PZ</td> </tr> <tr> <td>VM1794A0</td> <td>250X4.8 PA66 BLACK CLAMP</td> <td>2</td> <td>PZ</td> </tr> <tr> <td>VM2103A0</td> <td>CLAMP LOCK</td> <td>2</td> <td>PZ</td> </tr> </tbody> </table>	Code	Description	Qty	UOM	GN1326A1	ELEMENT SEALING	1	PZ	RS0090A0	CIRC. HEAT. ELEMENT 1260W 220-230	1	PZ	VI1220A1	4,2X12 TCB SELF-TAPPIN G SCREW	3	PZ	VM1794A0	250X4.8 PA66 BLACK CLAMP	2	PZ	VM2103A0	CLAMP LOCK	2	PZ
Code	Description	Qty	UOM																							
GN1326A1	ELEMENT SEALING	1	PZ																							
RS0090A0	CIRC. HEAT. ELEMENT 1260W 220-230	1	PZ																							
VI1220A1	4,2X12 TCB SELF-TAPPIN G SCREW	3	PZ																							
VM1794A0	250X4.8 PA66 BLACK CLAMP	2	PZ																							
VM2103A0	CLAMP LOCK	2	PZ																							
KRS0050A	HEATING ELEMENT KIT 0.5KW	<table border="1"> <thead> <tr> <th>Code</th> <th>Description</th> <th>Qty</th> <th>UOM</th> </tr> </thead> <tbody> <tr> <td>GN1326A1</td> <td>ELEMENT SEALING</td> <td>1</td> <td>PZ</td> </tr> <tr> <td>IP1075A1</td> <td></td> <td>1</td> <td>PZ</td> </tr> <tr> <td>IP1080A1</td> <td></td> <td>1</td> <td>PZ</td> </tr> <tr> <td>RS0050A0</td> <td>HEAT. ELEMENT 500W 220-230V LIEV</td> <td>1</td> <td>PZ</td> </tr> <tr> <td>VI1220A1</td> <td>4,2X12 TCB SELF-TAPPIN G SCREW</td> <td>2</td> <td>PZ</td> </tr> </tbody> </table>	Code	Description	Qty	UOM	GN1326A1	ELEMENT SEALING	1	PZ	IP1075A1		1	PZ	IP1080A1		1	PZ	RS0050A0	HEAT. ELEMENT 500W 220-230V LIEV	1	PZ	VI1220A1	4,2X12 TCB SELF-TAPPIN G SCREW	2	PZ
Code	Description	Qty	UOM																							
GN1326A1	ELEMENT SEALING	1	PZ																							
IP1075A1		1	PZ																							
IP1080A1		1	PZ																							
RS0050A0	HEAT. ELEMENT 500W 220-230V LIEV	1	PZ																							
VI1220A1	4,2X12 TCB SELF-TAPPIN G SCREW	2	PZ																							
KRS0011A	HEATING ELEMENT 1.465KW RS0011A	<table border="1"> <thead> <tr> <th>Code</th> <th>Description</th> <th>Qty</th> <th>UOM</th> </tr> </thead> <tbody> <tr> <td>GN1326A1</td> <td>ELEMENT SEALING</td> <td>1</td> <td>PZ</td> </tr> <tr> <td>RS0011A0</td> <td>CIRC.HEAT. ELEMENT 1465W 220-230</td> <td>1</td> <td>PZ</td> </tr> <tr> <td>VI1220A1</td> <td>4,2X12 TCB SELF-TAPPIN G SCREW</td> <td>3</td> <td>PZ</td> </tr> <tr> <td>VM1794A0</td> <td>250X4.8 PA66 BLACK CLAMP</td> <td>2</td> <td>PZ</td> </tr> <tr> <td>VM2103A0</td> <td>CLAMP LOCK</td> <td>2</td> <td>PZ</td> </tr> </tbody> </table>	Code	Description	Qty	UOM	GN1326A1	ELEMENT SEALING	1	PZ	RS0011A0	CIRC.HEAT. ELEMENT 1465W 220-230	1	PZ	VI1220A1	4,2X12 TCB SELF-TAPPIN G SCREW	3	PZ	VM1794A0	250X4.8 PA66 BLACK CLAMP	2	PZ	VM2103A0	CLAMP LOCK	2	PZ
Code	Description	Qty	UOM																							
GN1326A1	ELEMENT SEALING	1	PZ																							
RS0011A0	CIRC.HEAT. ELEMENT 1465W 220-230	1	PZ																							
VI1220A1	4,2X12 TCB SELF-TAPPIN G SCREW	3	PZ																							
VM1794A0	250X4.8 PA66 BLACK CLAMP	2	PZ																							
VM2103A0	CLAMP LOCK	2	PZ																							
KRS0010A	KIT HEATING ELEMENT RS10010A	<table border="1"> <thead> <tr> <th>Code</th> <th>Description</th> <th>Qty</th> <th>UOM</th> </tr> </thead> <tbody> <tr> <td>GN1326A1</td> <td>ELEMENT SEALING</td> <td>1</td> <td>PZ</td> </tr> <tr> <td>IP1075A1</td> <td></td> <td>1</td> <td>PZ</td> </tr> <tr> <td>IP1080A1</td> <td></td> <td>5</td> <td>PZ</td> </tr> <tr> <td>RS0010A0</td> <td>CIRC.HEAT. ELEMENT 2560W - 220-230 V</td> <td>1</td> <td>PZ</td> </tr> <tr> <td>VI1220A1</td> <td>4,2X12 TCB SELF-TAPPIN G SCREW</td> <td>3</td> <td>PZ</td> </tr> </tbody> </table>	Code	Description	Qty	UOM	GN1326A1	ELEMENT SEALING	1	PZ	IP1075A1		1	PZ	IP1080A1		5	PZ	RS0010A0	CIRC.HEAT. ELEMENT 2560W - 220-230 V	1	PZ	VI1220A1	4,2X12 TCB SELF-TAPPIN G SCREW	3	PZ
Code	Description	Qty	UOM																							
GN1326A1	ELEMENT SEALING	1	PZ																							
IP1075A1		1	PZ																							
IP1080A1		5	PZ																							
RS0010A0	CIRC.HEAT. ELEMENT 2560W - 220-230 V	1	PZ																							
VI1220A1	4,2X12 TCB SELF-TAPPIN G SCREW	3	PZ																							





COMPONENT			SPARE PART																										
Code	Description	Image	Code	Description	Components list																								
GN1326A	ELEMENT SEALING		KGN1326A	HEATING ELEMENT GASKET 5 PCS KIT	<table border="1"> <thead> <tr> <th>Code</th> <th>Description</th> <th>Qty</th> <th>UOM</th> </tr> </thead> <tbody> <tr> <td>GN1326A1</td> <td>ELEMENT SEALING</td> <td>5</td> <td>PZ</td> </tr> </tbody> </table>	Code	Description	Qty	UOM	GN1326A1	ELEMENT SEALING	5	PZ																
Code	Description	Qty	UOM																										
GN1326A1	ELEMENT SEALING	5	PZ																										
GN1326A	ELEMENT SEALING		KRS1274A	100W MOTOR BRAKING ELEMENT KIT	<table border="1"> <thead> <tr> <th>Code</th> <th>Description</th> <th>Qty</th> <th>UOM</th> </tr> </thead> <tbody> <tr> <td>GN1326A1</td> <td>ELEMENT SEALING</td> <td>1</td> <td>PZ</td> </tr> <tr> <td>RS1274A0</td> <td>100W 60V 1 TURN FLAT ELEMENT</td> <td>1</td> <td>PZ</td> </tr> <tr> <td>SL1045A0</td> <td>S53 BLACK SILICONE - 80ML CARTRIDGE</td> <td>1</td> <td>PZ</td> </tr> <tr> <td>VI1220A1</td> <td>4,2X12 TCB SELF-TAPPIN G SCREW</td> <td>2</td> <td>PZ</td> </tr> </tbody> </table>	Code	Description	Qty	UOM	GN1326A1	ELEMENT SEALING	1	PZ	RS1274A0	100W 60V 1 TURN FLAT ELEMENT	1	PZ	SL1045A0	S53 BLACK SILICONE - 80ML CARTRIDGE	1	PZ	VI1220A1	4,2X12 TCB SELF-TAPPIN G SCREW	2	PZ				
Code	Description	Qty	UOM																										
GN1326A1	ELEMENT SEALING	1	PZ																										
RS1274A0	100W 60V 1 TURN FLAT ELEMENT	1	PZ																										
SL1045A0	S53 BLACK SILICONE - 80ML CARTRIDGE	1	PZ																										
VI1220A1	4,2X12 TCB SELF-TAPPIN G SCREW	2	PZ																										
			KRS1261A	122W MOTOR BRAKING ELEMENT KIT	<table border="1"> <thead> <tr> <th>Code</th> <th>Description</th> <th>Qty</th> <th>UOM</th> </tr> </thead> <tbody> <tr> <td>GN1326A1</td> <td>ELEMENT SEALING</td> <td>1</td> <td>PZ</td> </tr> <tr> <td>RS1261A0</td> <td>BAKERLUX/CH EFLUX MOTOR BRAKING ELEMENT</td> <td>1</td> <td>PZ</td> </tr> <tr> <td>SL1045A0</td> <td>S53 BLACK SILICONE - 80ML CARTRIDGE</td> <td>1</td> <td>PZ</td> </tr> <tr> <td>VI1220A1</td> <td>4,2X12 TCB SELF-TAPPIN G SCREW</td> <td>2</td> <td>PZ</td> </tr> <tr> <td>VM2147A0</td> <td>ESD SPONGE PINK SMOOTH 410X343X15 M</td> <td>1</td> <td>PZ</td> </tr> </tbody> </table>	Code	Description	Qty	UOM	GN1326A1	ELEMENT SEALING	1	PZ	RS1261A0	BAKERLUX/CH EFLUX MOTOR BRAKING ELEMENT	1	PZ	SL1045A0	S53 BLACK SILICONE - 80ML CARTRIDGE	1	PZ	VI1220A1	4,2X12 TCB SELF-TAPPIN G SCREW	2	PZ	VM2147A0	ESD SPONGE PINK SMOOTH 410X343X15 M	1	PZ
Code	Description	Qty	UOM																										
GN1326A1	ELEMENT SEALING	1	PZ																										
RS1261A0	BAKERLUX/CH EFLUX MOTOR BRAKING ELEMENT	1	PZ																										
SL1045A0	S53 BLACK SILICONE - 80ML CARTRIDGE	1	PZ																										
VI1220A1	4,2X12 TCB SELF-TAPPIN G SCREW	2	PZ																										
VM2147A0	ESD SPONGE PINK SMOOTH 410X343X15 M	1	PZ																										
			KRS1215A	147W MOTOR BRAKING ELEMENT KIT	<table border="1"> <thead> <tr> <th>Code</th> <th>Description</th> <th>Qty</th> <th>UOM</th> </tr> </thead> <tbody> <tr> <td>GN1326A1</td> <td>ELEMENT SEALING</td> <td>1</td> <td>PZ</td> </tr> <tr> <td>RS1215A1</td> <td>147W 105V BRAKING ELEMENT</td> <td>1</td> <td>PZ</td> </tr> <tr> <td>SL1045A0</td> <td>S53 BLACK SILICONE - 80ML CARTRIDGE</td> <td>1</td> <td>PZ</td> </tr> <tr> <td>VI1220A1</td> <td>4,2X12 TCB SELF-TAPPIN G SCREW</td> <td>2</td> <td>PZ</td> </tr> </tbody> </table>	Code	Description	Qty	UOM	GN1326A1	ELEMENT SEALING	1	PZ	RS1215A1	147W 105V BRAKING ELEMENT	1	PZ	SL1045A0	S53 BLACK SILICONE - 80ML CARTRIDGE	1	PZ	VI1220A1	4,2X12 TCB SELF-TAPPIN G SCREW	2	PZ				
Code	Description	Qty	UOM																										
GN1326A1	ELEMENT SEALING	1	PZ																										
RS1215A1	147W 105V BRAKING ELEMENT	1	PZ																										
SL1045A0	S53 BLACK SILICONE - 80ML CARTRIDGE	1	PZ																										
VI1220A1	4,2X12 TCB SELF-TAPPIN G SCREW	2	PZ																										

COMPONENT			SPARE PART																														
Code	Description	Image	Code	Description	Components list																												
GN1326A	ELEMENT SEALING		KRS1095A	1.2KW HEATING ELEMENT KIT	<table border="1"> <thead> <tr> <th>Code</th> <th>Description</th> <th>Qty</th> <th>UOM</th> </tr> </thead> <tbody> <tr> <td>GN1326A1</td> <td>ELEMENT SEALING</td> <td>1</td> <td>PZ</td> </tr> <tr> <td>IP1385A1</td> <td>CORNER POLYSTYRENE PACKING 110X80X2000</td> <td>0.500</td> <td>M</td> </tr> <tr> <td>RS1095A1</td> <td>HEATING ELEMENT 1200W 230V</td> <td>1</td> <td>PZ</td> </tr> <tr> <td>SL1045A0</td> <td>S53 BLACK SILICONE - 80ML CARTRIDGE</td> <td>1</td> <td>PZ</td> </tr> <tr> <td>VI1220A1</td> <td>4,2X12 TCB SELF-TAPPING SCREW</td> <td>2</td> <td>PZ</td> </tr> <tr> <td>VM1059A1</td> <td>HEAT SHRINK FILM H800</td> <td>1.200</td> <td>M</td> </tr> </tbody> </table>	Code	Description	Qty	UOM	GN1326A1	ELEMENT SEALING	1	PZ	IP1385A1	CORNER POLYSTYRENE PACKING 110X80X2000	0.500	M	RS1095A1	HEATING ELEMENT 1200W 230V	1	PZ	SL1045A0	S53 BLACK SILICONE - 80ML CARTRIDGE	1	PZ	VI1220A1	4,2X12 TCB SELF-TAPPING SCREW	2	PZ	VM1059A1	HEAT SHRINK FILM H800	1.200	M
					Code	Description	Qty	UOM																									
					GN1326A1	ELEMENT SEALING	1	PZ																									
					IP1385A1	CORNER POLYSTYRENE PACKING 110X80X2000	0.500	M																									
					RS1095A1	HEATING ELEMENT 1200W 230V	1	PZ																									
					SL1045A0	S53 BLACK SILICONE - 80ML CARTRIDGE	1	PZ																									
			VI1220A1	4,2X12 TCB SELF-TAPPING SCREW	2	PZ																											
			VM1059A1	HEAT SHRINK FILM H800	1.200	M																											
			KRS1012A	1365W 120V HEATING ELEMENT KIT	<table border="1"> <thead> <tr> <th>Code</th> <th>Description</th> <th>Qty</th> <th>UOM</th> </tr> </thead> <tbody> <tr> <td>GN1326A1</td> <td>ELEMENT SEALING</td> <td>1</td> <td>PZ</td> </tr> <tr> <td>RS1012A0</td> <td>CIRCULAR HEATING ELEMENT 1365W 120V</td> <td>1</td> <td>PZ</td> </tr> <tr> <td>VI1220A1</td> <td>4,2X12 TCB SELF-TAPPING SCREW</td> <td>5</td> <td>PZ</td> </tr> <tr> <td>VM1794A0</td> <td>250X4.8 PA66 BLACK CLAMP</td> <td>2</td> <td>PZ</td> </tr> <tr> <td>VM2103A0</td> <td>CLAMP LOCK</td> <td>2</td> <td>PZ</td> </tr> </tbody> </table>	Code	Description	Qty	UOM	GN1326A1	ELEMENT SEALING	1	PZ	RS1012A0	CIRCULAR HEATING ELEMENT 1365W 120V	1	PZ	VI1220A1	4,2X12 TCB SELF-TAPPING SCREW	5	PZ	VM1794A0	250X4.8 PA66 BLACK CLAMP	2	PZ	VM2103A0	CLAMP LOCK	2	PZ				
					Code	Description	Qty	UOM																									
					GN1326A1	ELEMENT SEALING	1	PZ																									
					RS1012A0	CIRCULAR HEATING ELEMENT 1365W 120V	1	PZ																									
VI1220A1	4,2X12 TCB SELF-TAPPING SCREW	5			PZ																												
VM1794A0	250X4.8 PA66 BLACK CLAMP	2			PZ																												
VM2103A0	CLAMP LOCK	2	PZ																														
KRS1011A	ROBERTA/LISA HEATING ELEMENT KIT	<table border="1"> <thead> <tr> <th>Code</th> <th>Description</th> <th>Qty</th> <th>UOM</th> </tr> </thead> <tbody> <tr> <td>GN1326A1</td> <td>ELEMENT SEALING</td> <td>1</td> <td>PZ</td> </tr> <tr> <td>RS1011A0</td> <td>2560W HEATING ELEMENT</td> <td>1</td> <td>PZ</td> </tr> <tr> <td>SL1045A0</td> <td>S53 BLACK SILICONE - 80ML CARTRIDGE</td> <td>1</td> <td>PZ</td> </tr> <tr> <td>VI1220A1</td> <td>4,2X12 TCB SELF-TAPPING SCREW</td> <td>5</td> <td>PZ</td> </tr> <tr> <td>VM1794A0</td> <td>250X4.8 PA66 BLACK CLAMP</td> <td>2</td> <td>PZ</td> </tr> <tr> <td>VM2103A0</td> <td>CLAMP LOCK</td> <td>2</td> <td>PZ</td> </tr> </tbody> </table>	Code	Description	Qty	UOM	GN1326A1	ELEMENT SEALING	1	PZ	RS1011A0	2560W HEATING ELEMENT	1	PZ	SL1045A0	S53 BLACK SILICONE - 80ML CARTRIDGE	1	PZ	VI1220A1	4,2X12 TCB SELF-TAPPING SCREW	5	PZ	VM1794A0	250X4.8 PA66 BLACK CLAMP	2	PZ	VM2103A0	CLAMP LOCK	2	PZ			
		Code	Description	Qty	UOM																												
		GN1326A1	ELEMENT SEALING	1	PZ																												
		RS1011A0	2560W HEATING ELEMENT	1	PZ																												
		SL1045A0	S53 BLACK SILICONE - 80ML CARTRIDGE	1	PZ																												
		VI1220A1	4,2X12 TCB SELF-TAPPING SCREW	5	PZ																												
VM1794A0	250X4.8 PA66 BLACK CLAMP	2	PZ																														
VM2103A0	CLAMP LOCK	2	PZ																														
KRS0090A	HEATING ELEMENT 1.26KW	<table border="1"> <thead> <tr> <th>Code</th> <th>Description</th> <th>Qty</th> <th>UOM</th> </tr> </thead> <tbody> <tr> <td>GN1326A1</td> <td>ELEMENT SEALING</td> <td>1</td> <td>PZ</td> </tr> </tbody> </table>	Code	Description	Qty	UOM	GN1326A1	ELEMENT SEALING	1	PZ																							
		Code	Description	Qty	UOM																												
GN1326A1	ELEMENT SEALING	1	PZ																														

COMPONENT			SPARE PART																							
Code	Description	Image	Code	Description	Components list																					
GN1326A	ELEMENT SEALING		KRS0090A	HEATING ELEMENT 1.26KW	<table border="1"> <thead> <tr> <th>Code</th> <th>Description</th> <th>Qty</th> <th>UOM</th> </tr> </thead> <tbody> <tr> <td>RS0090A0</td> <td>CIRC. HEAT. ELEMENT 1260W 220-230</td> <td>1</td> <td>PZ</td> </tr> <tr> <td>VI1220A1</td> <td>4,2X12 TCB SELF-TAPPIN G SCREW</td> <td>3</td> <td>PZ</td> </tr> <tr> <td>VM1794A0</td> <td>250X4.8 PA66 BLACK CLAMP</td> <td>2</td> <td>PZ</td> </tr> <tr> <td>VM2103A0</td> <td>CLAMP LOCK</td> <td>2</td> <td>PZ</td> </tr> </tbody> </table>	Code	Description	Qty	UOM	RS0090A0	CIRC. HEAT. ELEMENT 1260W 220-230	1	PZ	VI1220A1	4,2X12 TCB SELF-TAPPIN G SCREW	3	PZ	VM1794A0	250X4.8 PA66 BLACK CLAMP	2	PZ	VM2103A0	CLAMP LOCK	2	PZ	
			Code	Description	Qty	UOM																				
			RS0090A0	CIRC. HEAT. ELEMENT 1260W 220-230	1	PZ																				
			VI1220A1	4,2X12 TCB SELF-TAPPIN G SCREW	3	PZ																				
VM1794A0	250X4.8 PA66 BLACK CLAMP	2	PZ																							
VM2103A0	CLAMP LOCK	2	PZ																							
KRS0050A	HEATING ELEMENT KIT 0.5KW	<table border="1"> <thead> <tr> <th>Code</th> <th>Description</th> <th>Qty</th> <th>UOM</th> </tr> </thead> <tbody> <tr> <td>GN1326A1</td> <td>ELEMENT SEALING</td> <td>1</td> <td>PZ</td> </tr> <tr> <td>IP1075A1</td> <td></td> <td>1</td> <td>PZ</td> </tr> <tr> <td>IP1080A1</td> <td></td> <td>1</td> <td>PZ</td> </tr> <tr> <td>RS0050A0</td> <td>HEAT. ELEMENT 500W 220-230V LIEV</td> <td>1</td> <td>PZ</td> </tr> <tr> <td>VI1220A1</td> <td>4,2X12 TCB SELF-TAPPIN G SCREW</td> <td>2</td> <td>PZ</td> </tr> </tbody> </table>	Code	Description	Qty	UOM	GN1326A1	ELEMENT SEALING	1	PZ	IP1075A1		1	PZ	IP1080A1		1	PZ	RS0050A0	HEAT. ELEMENT 500W 220-230V LIEV	1	PZ	VI1220A1	4,2X12 TCB SELF-TAPPIN G SCREW	2	PZ
Code	Description	Qty	UOM																							
GN1326A1	ELEMENT SEALING	1	PZ																							
IP1075A1		1	PZ																							
IP1080A1		1	PZ																							
RS0050A0	HEAT. ELEMENT 500W 220-230V LIEV	1	PZ																							
VI1220A1	4,2X12 TCB SELF-TAPPIN G SCREW	2	PZ																							
KRS0011A	HEATING ELEMENT 1.465KW RS0011A	<table border="1"> <thead> <tr> <th>Code</th> <th>Description</th> <th>Qty</th> <th>UOM</th> </tr> </thead> <tbody> <tr> <td>GN1326A1</td> <td>ELEMENT SEALING</td> <td>1</td> <td>PZ</td> </tr> <tr> <td>RS0011A0</td> <td>CIRC.HEAT. ELEMENT 1465W 220-230</td> <td>1</td> <td>PZ</td> </tr> <tr> <td>VI1220A1</td> <td>4,2X12 TCB SELF-TAPPIN G SCREW</td> <td>3</td> <td>PZ</td> </tr> <tr> <td>VM1794A0</td> <td>250X4.8 PA66 BLACK CLAMP</td> <td>2</td> <td>PZ</td> </tr> <tr> <td>VM2103A0</td> <td>CLAMP LOCK</td> <td>2</td> <td>PZ</td> </tr> </tbody> </table>	Code	Description	Qty	UOM	GN1326A1	ELEMENT SEALING	1	PZ	RS0011A0	CIRC.HEAT. ELEMENT 1465W 220-230	1	PZ	VI1220A1	4,2X12 TCB SELF-TAPPIN G SCREW	3	PZ	VM1794A0	250X4.8 PA66 BLACK CLAMP	2	PZ	VM2103A0	CLAMP LOCK	2	PZ
Code	Description	Qty	UOM																							
GN1326A1	ELEMENT SEALING	1	PZ																							
RS0011A0	CIRC.HEAT. ELEMENT 1465W 220-230	1	PZ																							
VI1220A1	4,2X12 TCB SELF-TAPPIN G SCREW	3	PZ																							
VM1794A0	250X4.8 PA66 BLACK CLAMP	2	PZ																							
VM2103A0	CLAMP LOCK	2	PZ																							
KRS0010A	KIT HEATING ELEMENT RS10010A	<table border="1"> <thead> <tr> <th>Code</th> <th>Description</th> <th>Qty</th> <th>UOM</th> </tr> </thead> <tbody> <tr> <td>GN1326A1</td> <td>ELEMENT SEALING</td> <td>1</td> <td>PZ</td> </tr> <tr> <td>IP1075A1</td> <td></td> <td>1</td> <td>PZ</td> </tr> <tr> <td>IP1080A1</td> <td></td> <td>5</td> <td>PZ</td> </tr> <tr> <td>RS0010A0</td> <td>CIRC.HEAT. ELEMENT 2560W - 220-230 V</td> <td>1</td> <td>PZ</td> </tr> <tr> <td>VI1220A1</td> <td>4,2X12 TCB SELF-TAPPIN G SCREW</td> <td>3</td> <td>PZ</td> </tr> </tbody> </table>	Code	Description	Qty	UOM	GN1326A1	ELEMENT SEALING	1	PZ	IP1075A1		1	PZ	IP1080A1		5	PZ	RS0010A0	CIRC.HEAT. ELEMENT 2560W - 220-230 V	1	PZ	VI1220A1	4,2X12 TCB SELF-TAPPIN G SCREW	3	PZ
Code	Description	Qty	UOM																							
GN1326A1	ELEMENT SEALING	1	PZ																							
IP1075A1		1	PZ																							
IP1080A1		5	PZ																							
RS0010A0	CIRC.HEAT. ELEMENT 2560W - 220-230 V	1	PZ																							
VI1220A1	4,2X12 TCB SELF-TAPPIN G SCREW	3	PZ																							
KG1326A	HEATING ELEMENT GASKET 5 PCS KIT	<table border="1"> <thead> <tr> <th>Code</th> <th>Description</th> <th>Qty</th> <th>UOM</th> </tr> </thead> <tbody> <tr> <td>GN1326A1</td> <td>ELEMENT SEALING</td> <td>5</td> <td>PZ</td> </tr> </tbody> </table>	Code	Description	Qty	UOM	GN1326A1	ELEMENT SEALING	5	PZ																
Code	Description	Qty	UOM																							
GN1326A1	ELEMENT SEALING	5	PZ																							

COMPONENT			SPARE PART																										
Code	Description	Image	Code	Description	Components list																								
RS1274A	100W 60V 1 TURN FLAT ELEMENT		KRS1274A	100W MOTOR BRAKING ELEMENT KIT	<table border="1"> <thead> <tr> <th>Code</th> <th>Description</th> <th>Qty</th> <th>UOM</th> </tr> </thead> <tbody> <tr> <td>GN1326A1</td> <td>ELEMENT SEALING</td> <td>1</td> <td>PZ</td> </tr> <tr> <td>RS1274A0</td> <td>100W 60V 1 TURN FLAT ELEMENT</td> <td>1</td> <td>PZ</td> </tr> <tr> <td>SL1045A0</td> <td>S53 BLACK SILICONE - 80ML CARTRIDGE</td> <td>1</td> <td>PZ</td> </tr> <tr> <td>VI1220A1</td> <td>4,2X12 TCB SELF-TAPPIN G SCREW</td> <td>2</td> <td>PZ</td> </tr> </tbody> </table>	Code	Description	Qty	UOM	GN1326A1	ELEMENT SEALING	1	PZ	RS1274A0	100W 60V 1 TURN FLAT ELEMENT	1	PZ	SL1045A0	S53 BLACK SILICONE - 80ML CARTRIDGE	1	PZ	VI1220A1	4,2X12 TCB SELF-TAPPIN G SCREW	2	PZ				
Code	Description	Qty	UOM																										
GN1326A1	ELEMENT SEALING	1	PZ																										
RS1274A0	100W 60V 1 TURN FLAT ELEMENT	1	PZ																										
SL1045A0	S53 BLACK SILICONE - 80ML CARTRIDGE	1	PZ																										
VI1220A1	4,2X12 TCB SELF-TAPPIN G SCREW	2	PZ																										
GN1285A	NTC TEMPERATURE PROBE SEALING		KTR1106A	5-5E S. L2000 CHAMBER TEMP. PROBE KIT	<table border="1"> <thead> <tr> <th>Code</th> <th>Description</th> <th>Qty</th> <th>UOM</th> </tr> </thead> <tbody> <tr> <td>GN1285A0</td> <td>NTC TEMPERATUR E PROBE SEALING</td> <td>1</td> <td>PZ</td> </tr> <tr> <td>SL1045A0</td> <td>S53 BLACK SILICONE - 80ML CARTRIDGE</td> <td>1</td> <td>PZ</td> </tr> <tr> <td>TR1106A3</td> <td>PT100 L=2000 TEMPERATUR E PROBE</td> <td>1</td> <td>PZ</td> </tr> <tr> <td>VI1220A1</td> <td>4,2X12 TCB SELF-TAPPIN G SCREW</td> <td>2</td> <td>PZ</td> </tr> <tr> <td>VM1465A0</td> <td>CHEFTOP TEMPERATUR E PROBE COVER</td> <td>1</td> <td>PZ</td> </tr> </tbody> </table>	Code	Description	Qty	UOM	GN1285A0	NTC TEMPERATUR E PROBE SEALING	1	PZ	SL1045A0	S53 BLACK SILICONE - 80ML CARTRIDGE	1	PZ	TR1106A3	PT100 L=2000 TEMPERATUR E PROBE	1	PZ	VI1220A1	4,2X12 TCB SELF-TAPPIN G SCREW	2	PZ	VM1465A0	CHEFTOP TEMPERATUR E PROBE COVER	1	PZ
Code	Description	Qty	UOM																										
GN1285A0	NTC TEMPERATUR E PROBE SEALING	1	PZ																										
SL1045A0	S53 BLACK SILICONE - 80ML CARTRIDGE	1	PZ																										
TR1106A3	PT100 L=2000 TEMPERATUR E PROBE	1	PZ																										
VI1220A1	4,2X12 TCB SELF-TAPPIN G SCREW	2	PZ																										
VM1465A0	CHEFTOP TEMPERATUR E PROBE COVER	1	PZ																										
			KTR1105A	PT100 L1000 TEMPERATURE PROBE KIT	<table border="1"> <thead> <tr> <th>Code</th> <th>Description</th> <th>Qty</th> <th>UOM</th> </tr> </thead> <tbody> <tr> <td>GN1120A0</td> <td>TEMPERATUR E PROBE NTC SEAL</td> <td>1</td> <td>PZ</td> </tr> <tr> <td>GN1285A0</td> <td>NTC TEMPERATUR E PROBE SEALING</td> <td>1</td> <td>PZ</td> </tr> <tr> <td>SL1045A0</td> <td>S53 BLACK SILICONE - 80ML CARTRIDGE</td> <td>1</td> <td>PZ</td> </tr> <tr> <td>TR1105A4</td> <td></td> <td>1</td> <td>PZ</td> </tr> <tr> <td>VI1220A1</td> <td>4,2X12 TCB SELF-TAPPIN G SCREW</td> <td>2</td> <td>PZ</td> </tr> </tbody> </table>	Code	Description	Qty	UOM	GN1120A0	TEMPERATUR E PROBE NTC SEAL	1	PZ	GN1285A0	NTC TEMPERATUR E PROBE SEALING	1	PZ	SL1045A0	S53 BLACK SILICONE - 80ML CARTRIDGE	1	PZ	TR1105A4		1	PZ	VI1220A1	4,2X12 TCB SELF-TAPPIN G SCREW	2	PZ
Code	Description	Qty	UOM																										
GN1120A0	TEMPERATUR E PROBE NTC SEAL	1	PZ																										
GN1285A0	NTC TEMPERATUR E PROBE SEALING	1	PZ																										
SL1045A0	S53 BLACK SILICONE - 80ML CARTRIDGE	1	PZ																										
TR1105A4		1	PZ																										
VI1220A1	4,2X12 TCB SELF-TAPPIN G SCREW	2	PZ																										
			KTR1096A	NTC 150 L=1500 TEMPERATURE PROBE KIT	<table border="1"> <thead> <tr> <th>Code</th> <th>Description</th> <th>Qty</th> <th>UOM</th> </tr> </thead> <tbody> <tr> <td>GN1120A0</td> <td>TEMPERATUR E PROBE NTC SEAL</td> <td>1</td> <td>PZ</td> </tr> </tbody> </table>	Code	Description	Qty	UOM	GN1120A0	TEMPERATUR E PROBE NTC SEAL	1	PZ																
Code	Description	Qty	UOM																										
GN1120A0	TEMPERATUR E PROBE NTC SEAL	1	PZ																										



COMPONENT			SPARE PART																											
Code	Description	Image	Code	Description	Components list																									
GN1285A	NTC TEMPERATURE PROBE SEALING		KTR1096A	NTC 150 L=1500 TEMPERATURE PROBE KIT	<table border="1"> <thead> <tr> <th>Code</th> <th>Description</th> <th>Qty</th> <th>UOM</th> </tr> </thead> <tbody> <tr> <td>GN1285A0</td> <td>NTC TEMPERATUR E PROBE SEALING</td> <td>2</td> <td>PZ</td> </tr> <tr> <td>SL1045A0</td> <td>S53 BLACK SILICONE - 80ML CARTRIDGE</td> <td>1</td> <td>PZ</td> </tr> <tr> <td>TR1096A0</td> <td>TEMPERATUR E PROBE NTC 150 L=1500</td> <td>1</td> <td>PZ</td> </tr> <tr> <td>VI1220A1</td> <td>4,2X12 TCB SELF-TAPPIN G SCREW</td> <td>2</td> <td>PZ</td> </tr> <tr> <td>VM1465A0</td> <td>CHEFTOP TEMPERATUR E PROBE COVER</td> <td>1</td> <td>PZ</td> </tr> </tbody> </table>	Code	Description	Qty	UOM	GN1285A0	NTC TEMPERATUR E PROBE SEALING	2	PZ	SL1045A0	S53 BLACK SILICONE - 80ML CARTRIDGE	1	PZ	TR1096A0	TEMPERATUR E PROBE NTC 150 L=1500	1	PZ	VI1220A1	4,2X12 TCB SELF-TAPPIN G SCREW	2	PZ	VM1465A0	CHEFTOP TEMPERATUR E PROBE COVER	1	PZ	
			Code	Description	Qty	UOM																								
			GN1285A0	NTC TEMPERATUR E PROBE SEALING	2	PZ																								
SL1045A0	S53 BLACK SILICONE - 80ML CARTRIDGE	1	PZ																											
TR1096A0	TEMPERATUR E PROBE NTC 150 L=1500	1	PZ																											
VI1220A1	4,2X12 TCB SELF-TAPPIN G SCREW	2	PZ																											
VM1465A0	CHEFTOP TEMPERATUR E PROBE COVER	1	PZ																											
KTR1095A	NTC 150 L=1050 TEMPERATURE PROBE KIT	<table border="1"> <thead> <tr> <th>Code</th> <th>Description</th> <th>Qty</th> <th>UOM</th> </tr> </thead> <tbody> <tr> <td>GN1120A0</td> <td>TEMPERATUR E PROBE NTC SEAL</td> <td>1</td> <td>PZ</td> </tr> <tr> <td>GN1285A0</td> <td>NTC TEMPERATUR E PROBE SEALING</td> <td>1</td> <td>PZ</td> </tr> <tr> <td>SL1045A0</td> <td>S53 BLACK SILICONE - 80ML CARTRIDGE</td> <td>1</td> <td>PZ</td> </tr> <tr> <td>TR1095A0</td> <td>TEMPERATUR E PROBE NTC 150 L=1050</td> <td>1</td> <td>PZ</td> </tr> <tr> <td>VI1220A1</td> <td>4,2X12 TCB SELF-TAPPIN G SCREW</td> <td>2</td> <td>PZ</td> </tr> <tr> <td>VM1465A0</td> <td>CHEFTOP TEMPERATUR E PROBE COVER</td> <td>1</td> <td>PZ</td> </tr> </tbody> </table>	Code	Description	Qty	UOM	GN1120A0	TEMPERATUR E PROBE NTC SEAL	1	PZ	GN1285A0	NTC TEMPERATUR E PROBE SEALING	1	PZ	SL1045A0	S53 BLACK SILICONE - 80ML CARTRIDGE	1	PZ	TR1095A0	TEMPERATUR E PROBE NTC 150 L=1050	1	PZ	VI1220A1	4,2X12 TCB SELF-TAPPIN G SCREW	2	PZ	VM1465A0	CHEFTOP TEMPERATUR E PROBE COVER	1	PZ
Code	Description	Qty	UOM																											
GN1120A0	TEMPERATUR E PROBE NTC SEAL	1	PZ																											
GN1285A0	NTC TEMPERATUR E PROBE SEALING	1	PZ																											
SL1045A0	S53 BLACK SILICONE - 80ML CARTRIDGE	1	PZ																											
TR1095A0	TEMPERATUR E PROBE NTC 150 L=1050	1	PZ																											
VI1220A1	4,2X12 TCB SELF-TAPPIN G SCREW	2	PZ																											
VM1465A0	CHEFTOP TEMPERATUR E PROBE COVER	1	PZ																											
KTR1002A	PT100 L1000 UL TEMPERATURE PROBE KIT	<table border="1"> <thead> <tr> <th>Code</th> <th>Description</th> <th>Qty</th> <th>UOM</th> </tr> </thead> <tbody> <tr> <td>GN1285A0</td> <td>NTC TEMPERATUR E PROBE SEALING</td> <td>2</td> <td>PZ</td> </tr> <tr> <td>SL1045A0</td> <td>S53 BLACK SILICONE - 80ML CARTRIDGE</td> <td>1</td> <td>PZ</td> </tr> <tr> <td>TR1002A1</td> <td></td> <td>1</td> <td>PZ</td> </tr> <tr> <td>VI1220A1</td> <td>4,2X12 TCB SELF-TAPPIN G SCREW</td> <td>2</td> <td>PZ</td> </tr> <tr> <td>VM1465A0</td> <td>CHEFTOP TEMPERATUR E PROBE COVER</td> <td>1</td> <td>PZ</td> </tr> </tbody> </table>	Code	Description	Qty	UOM	GN1285A0	NTC TEMPERATUR E PROBE SEALING	2	PZ	SL1045A0	S53 BLACK SILICONE - 80ML CARTRIDGE	1	PZ	TR1002A1		1	PZ	VI1220A1	4,2X12 TCB SELF-TAPPIN G SCREW	2	PZ	VM1465A0	CHEFTOP TEMPERATUR E PROBE COVER	1	PZ				
Code	Description	Qty	UOM																											
GN1285A0	NTC TEMPERATUR E PROBE SEALING	2	PZ																											
SL1045A0	S53 BLACK SILICONE - 80ML CARTRIDGE	1	PZ																											
TR1002A1		1	PZ																											
VI1220A1	4,2X12 TCB SELF-TAPPIN G SCREW	2	PZ																											
VM1465A0	CHEFTOP TEMPERATUR E PROBE COVER	1	PZ																											

COMPONENT			SPARE PART																														
Code	Description	Image	Code	Description	Components list																												
TR1106A	PT100 L=2000 TEMPERATURE PROBE		KTR1106B	MIND.MAPS L2000 CHAMBER TEMP. PROBE KIT	<table border="1"> <thead> <tr> <th>Code</th> <th>Description</th> <th>Qty</th> <th>UOM</th> </tr> </thead> <tbody> <tr> <td>GN1285A0</td> <td>NTC TEMPERATUR E PROBE SEALING</td> <td>1</td> <td>PZ</td> </tr> <tr> <td>SL1045A0</td> <td>S53 BLACK SILICONE - 80ML CARTRIDGE</td> <td>1</td> <td>PZ</td> </tr> <tr> <td>TR1106B0</td> <td></td> <td>1</td> <td>PZ</td> </tr> <tr> <td>VI1220A1</td> <td>4,2X12 TCB SELF-TAPPIN G SCREW</td> <td>2</td> <td>PZ</td> </tr> <tr> <td>VM1464A1</td> <td>CT BT TEMPERATUR E PROBE COVER</td> <td>1</td> <td>PZ</td> </tr> <tr> <td>VM1465A0</td> <td>CHEFTOP TEMPERATUR E PROBE COVER</td> <td>1</td> <td>PZ</td> </tr> </tbody> </table>	Code	Description	Qty	UOM	GN1285A0	NTC TEMPERATUR E PROBE SEALING	1	PZ	SL1045A0	S53 BLACK SILICONE - 80ML CARTRIDGE	1	PZ	TR1106B0		1	PZ	VI1220A1	4,2X12 TCB SELF-TAPPIN G SCREW	2	PZ	VM1464A1	CT BT TEMPERATUR E PROBE COVER	1	PZ	VM1465A0	CHEFTOP TEMPERATUR E PROBE COVER	1	PZ
			Code	Description	Qty	UOM																											
GN1285A0	NTC TEMPERATUR E PROBE SEALING	1	PZ																														
SL1045A0	S53 BLACK SILICONE - 80ML CARTRIDGE	1	PZ																														
TR1106B0		1	PZ																														
VI1220A1	4,2X12 TCB SELF-TAPPIN G SCREW	2	PZ																														
VM1464A1	CT BT TEMPERATUR E PROBE COVER	1	PZ																														
VM1465A0	CHEFTOP TEMPERATUR E PROBE COVER	1	PZ																														
KTR1106A	5-5E S. L2000 CHAMBER TEMP. PROBE KIT	<table border="1"> <thead> <tr> <th>Code</th> <th>Description</th> <th>Qty</th> <th>UOM</th> </tr> </thead> <tbody> <tr> <td>GN1285A0</td> <td>NTC TEMPERATUR E PROBE SEALING</td> <td>1</td> <td>PZ</td> </tr> <tr> <td>SL1045A0</td> <td>S53 BLACK SILICONE - 80ML CARTRIDGE</td> <td>1</td> <td>PZ</td> </tr> <tr> <td>TR1106A3</td> <td>PT100 L=2000 TEMPERATUR E PROBE</td> <td>1</td> <td>PZ</td> </tr> <tr> <td>VI1220A1</td> <td>4,2X12 TCB SELF-TAPPIN G SCREW</td> <td>2</td> <td>PZ</td> </tr> <tr> <td>VM1465A0</td> <td>CHEFTOP TEMPERATUR E PROBE COVER</td> <td>1</td> <td>PZ</td> </tr> </tbody> </table>	Code	Description	Qty	UOM	GN1285A0	NTC TEMPERATUR E PROBE SEALING	1	PZ	SL1045A0	S53 BLACK SILICONE - 80ML CARTRIDGE	1	PZ	TR1106A3	PT100 L=2000 TEMPERATUR E PROBE	1	PZ	VI1220A1	4,2X12 TCB SELF-TAPPIN G SCREW	2	PZ	VM1465A0	CHEFTOP TEMPERATUR E PROBE COVER	1	PZ							
Code	Description	Qty	UOM																														
GN1285A0	NTC TEMPERATUR E PROBE SEALING	1	PZ																														
SL1045A0	S53 BLACK SILICONE - 80ML CARTRIDGE	1	PZ																														
TR1106A3	PT100 L=2000 TEMPERATUR E PROBE	1	PZ																														
VI1220A1	4,2X12 TCB SELF-TAPPIN G SCREW	2	PZ																														
VM1465A0	CHEFTOP TEMPERATUR E PROBE COVER	1	PZ																														
VM1464A	CT BT TEMPERATURE PROBE COVER		KVM1464A	CT BT TEMPERATURE PROBE COVER KIT	<table border="1"> <thead> <tr> <th>Code</th> <th>Description</th> <th>Qty</th> <th>UOM</th> </tr> </thead> <tbody> <tr> <td>VM1464A1</td> <td>CT BT TEMPERATUR E PROBE COVER</td> <td>1</td> <td>PZ</td> </tr> </tbody> </table>	Code	Description	Qty	UOM	VM1464A1	CT BT TEMPERATUR E PROBE COVER	1	PZ																				
Code	Description	Qty	UOM																														
VM1464A1	CT BT TEMPERATUR E PROBE COVER	1	PZ																														

COMPONENT			SPARE PART																														
Code	Description	Image	Code	Description	Components list																												
TR1003A	PT100 L2000 TEMPERATURE PROBE-US VERSION		KTR1003B	US MM L2000 CHAMBER TEMP. PROBE KIT	<table border="1"> <thead> <tr> <th>Code</th> <th>Description</th> <th>Qty</th> <th>UOM</th> </tr> </thead> <tbody> <tr> <td>GN1285A0</td> <td>NTC TEMPERATUR E PROBE SEALING</td> <td>1</td> <td>PZ</td> </tr> <tr> <td>SL1045A0</td> <td>S53 BLACK SILICONE - 80ML CARTRIDGE</td> <td>1</td> <td>PZ</td> </tr> <tr> <td>TR1003B0</td> <td></td> <td>1</td> <td>PZ</td> </tr> <tr> <td>VI1220A1</td> <td>4,2X12 TCB SELF-TAPPIN G SCREW</td> <td>2</td> <td>PZ</td> </tr> <tr> <td>VM1464A1</td> <td>CT BT TEMPERATUR E PROBE COVER</td> <td>1</td> <td>PZ</td> </tr> <tr> <td>VM1465A0</td> <td>CHEFTOP TEMPERATUR E PROBE COVER</td> <td>1</td> <td>PZ</td> </tr> </tbody> </table>	Code	Description	Qty	UOM	GN1285A0	NTC TEMPERATUR E PROBE SEALING	1	PZ	SL1045A0	S53 BLACK SILICONE - 80ML CARTRIDGE	1	PZ	TR1003B0		1	PZ	VI1220A1	4,2X12 TCB SELF-TAPPIN G SCREW	2	PZ	VM1464A1	CT BT TEMPERATUR E PROBE COVER	1	PZ	VM1465A0	CHEFTOP TEMPERATUR E PROBE COVER	1	PZ
Code	Description	Qty	UOM																														
GN1285A0	NTC TEMPERATUR E PROBE SEALING	1	PZ																														
SL1045A0	S53 BLACK SILICONE - 80ML CARTRIDGE	1	PZ																														
TR1003B0		1	PZ																														
VI1220A1	4,2X12 TCB SELF-TAPPIN G SCREW	2	PZ																														
VM1464A1	CT BT TEMPERATUR E PROBE COVER	1	PZ																														
VM1465A0	CHEFTOP TEMPERATUR E PROBE COVER	1	PZ																														
GN1531A	THERMOSTAT BULB INLET SEALING		KTR1136A	330 °C SAFETY THERMOSTAT KIT	<table border="1"> <thead> <tr> <th>Code</th> <th>Description</th> <th>Qty</th> <th>UOM</th> </tr> </thead> <tbody> <tr> <td>0H7030A0</td> <td>THERMOSTAT BULB INLET COVER</td> <td>1</td> <td>PZ</td> </tr> <tr> <td>GN1531A0</td> <td>THERMOSTAT BULB INLET SEALING</td> <td>1</td> <td>PZ</td> </tr> <tr> <td>SL1045A0</td> <td>S53 BLACK SILICONE - 80ML CARTRIDGE</td> <td>1</td> <td>PZ</td> </tr> <tr> <td>TR1136A0</td> <td>330 °C 1 POLE SAFETY THERMOSTAT</td> <td>1</td> <td>PZ</td> </tr> <tr> <td>VI1220A1</td> <td>4,2X12 TCB SELF-TAPPIN G SCREW</td> <td>3</td> <td>PZ</td> </tr> </tbody> </table>	Code	Description	Qty	UOM	0H7030A0	THERMOSTAT BULB INLET COVER	1	PZ	GN1531A0	THERMOSTAT BULB INLET SEALING	1	PZ	SL1045A0	S53 BLACK SILICONE - 80ML CARTRIDGE	1	PZ	TR1136A0	330 °C 1 POLE SAFETY THERMOSTAT	1	PZ	VI1220A1	4,2X12 TCB SELF-TAPPIN G SCREW	3	PZ				
Code	Description	Qty	UOM																														
0H7030A0	THERMOSTAT BULB INLET COVER	1	PZ																														
GN1531A0	THERMOSTAT BULB INLET SEALING	1	PZ																														
SL1045A0	S53 BLACK SILICONE - 80ML CARTRIDGE	1	PZ																														
TR1136A0	330 °C 1 POLE SAFETY THERMOSTAT	1	PZ																														
VI1220A1	4,2X12 TCB SELF-TAPPIN G SCREW	3	PZ																														
0H7030A	THERMOSTAT BULB INLET COVER		K0H7030A	THERMOSTAT BULB INLET COVER KIT	<table border="1"> <thead> <tr> <th>Code</th> <th>Description</th> <th>Qty</th> <th>UOM</th> </tr> </thead> <tbody> <tr> <td>0H7030A0</td> <td>THERMOSTAT BULB INLET COVER</td> <td>1</td> <td>PZ</td> </tr> </tbody> </table>	Code	Description	Qty	UOM	0H7030A0	THERMOSTAT BULB INLET COVER	1	PZ																				
Code	Description	Qty	UOM																														
0H7030A0	THERMOSTAT BULB INLET COVER	1	PZ																														



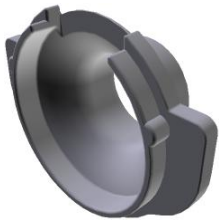
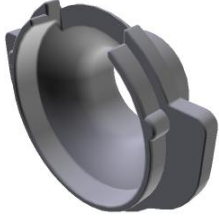



COMPONENT			SPARE PART										
Code	Description	Image	Code	Description	Components list								
0H2551A	XBC/XVC ST.STEEL DRAIN COVER		0H2551A0	XBC/XVC ST.STEEL DRAIN COVER									
0H7320A	6 S. VENTURI PIPE SUPPORT		0H7320A0	6 S. VENTURI PIPE SUPPORT									
VM1820A	LATERAL SUPPORTS M6 FIXING BOLT		KVM1820A	THUMB SCREW 10PCS KIT	<table border="1"> <thead> <tr> <th>Code</th> <th>Description</th> <th>Qty</th> <th>UOM</th> </tr> </thead> <tbody> <tr> <td>VM1820A0</td> <td>LATERAL SUPPORTS M6 FIXING BOLT</td> <td>10</td> <td>PZ</td> </tr> </tbody> </table>	Code	Description	Qty	UOM	VM1820A0	LATERAL SUPPORTS M6 FIXING BOLT	10	PZ
Code	Description	Qty	UOM										
VM1820A0	LATERAL SUPPORTS M6 FIXING BOLT	10	PZ										
0G1577A	XEVC-2011-E FAN GUARD												
TB2917A	XEVC-2011-E 5 WAYS WATER PIPE ASSEMBLY		KTB2917A	XEVC-2011-E 5 WAY WATER PIPE KIT	<table border="1"> <thead> <tr> <th>Code</th> <th>Description</th> <th>Qty</th> <th>UOM</th> </tr> </thead> <tbody> <tr> <td>TB2917A0</td> <td>XEVC-2011-E 5 WAYS WATER PIPE ASSEMBLY</td> <td>1</td> <td>PZ</td> </tr> </tbody> </table>	Code	Description	Qty	UOM	TB2917A0	XEVC-2011-E 5 WAYS WATER PIPE ASSEMBLY	1	PZ
Code	Description	Qty	UOM										
TB2917A0	XEVC-2011-E 5 WAYS WATER PIPE ASSEMBLY	1	PZ										

COMPONENT			SPARE PART														
Code	Description	Image	Code	Description	Components list												
VM2251A	STEAM WATER INLET UPPER DISTRIBUTOR		KVM2251A	STEAM WATER INLET UP+LO DISTRIBUTORS KIT	<table border="1"> <thead> <tr> <th>Code</th> <th>Description</th> <th>Qty</th> <th>UOM</th> </tr> </thead> <tbody> <tr> <td>VM2251A0</td> <td>STEAM WATER INLET UPPER DISTRIBUTOR</td> <td>1</td> <td>PZ</td> </tr> <tr> <td>VM2252A0</td> <td>STEAM WATER INLET LOWER DISTRIBUTOR</td> <td>1</td> <td>PZ</td> </tr> </tbody> </table>	Code	Description	Qty	UOM	VM2251A0	STEAM WATER INLET UPPER DISTRIBUTOR	1	PZ	VM2252A0	STEAM WATER INLET LOWER DISTRIBUTOR	1	PZ
Code	Description	Qty	UOM														
VM2251A0	STEAM WATER INLET UPPER DISTRIBUTOR	1	PZ														
VM2252A0	STEAM WATER INLET LOWER DISTRIBUTOR	1	PZ														
VM2252A	STEAM WATER INLET LOWER DISTRIBUTOR		KVM2251A	STEAM WATER INLET UP+LO DISTRIBUTORS KIT	<table border="1"> <thead> <tr> <th>Code</th> <th>Description</th> <th>Qty</th> <th>UOM</th> </tr> </thead> <tbody> <tr> <td>VM2251A0</td> <td>STEAM WATER INLET UPPER DISTRIBUTOR</td> <td>1</td> <td>PZ</td> </tr> <tr> <td>VM2252A0</td> <td>STEAM WATER INLET LOWER DISTRIBUTOR</td> <td>1</td> <td>PZ</td> </tr> </tbody> </table>	Code	Description	Qty	UOM	VM2251A0	STEAM WATER INLET UPPER DISTRIBUTOR	1	PZ	VM2252A0	STEAM WATER INLET LOWER DISTRIBUTOR	1	PZ
Code	Description	Qty	UOM														
VM2251A0	STEAM WATER INLET UPPER DISTRIBUTOR	1	PZ														
VM2252A0	STEAM WATER INLET LOWER DISTRIBUTOR	1	PZ														
VM2251A	STEAM WATER INLET UPPER DISTRIBUTOR		KVM2251A	STEAM WATER INLET UP+LO DISTRIBUTORS KIT	<table border="1"> <thead> <tr> <th>Code</th> <th>Description</th> <th>Qty</th> <th>UOM</th> </tr> </thead> <tbody> <tr> <td>VM2251A0</td> <td>STEAM WATER INLET UPPER DISTRIBUTOR</td> <td>1</td> <td>PZ</td> </tr> <tr> <td>VM2252A0</td> <td>STEAM WATER INLET LOWER DISTRIBUTOR</td> <td>1</td> <td>PZ</td> </tr> </tbody> </table>	Code	Description	Qty	UOM	VM2251A0	STEAM WATER INLET UPPER DISTRIBUTOR	1	PZ	VM2252A0	STEAM WATER INLET LOWER DISTRIBUTOR	1	PZ
Code	Description	Qty	UOM														
VM2251A0	STEAM WATER INLET UPPER DISTRIBUTOR	1	PZ														
VM2252A0	STEAM WATER INLET LOWER DISTRIBUTOR	1	PZ														
VM2252A	STEAM WATER INLET LOWER DISTRIBUTOR		KVM2251A	STEAM WATER INLET UP+LO DISTRIBUTORS KIT	<table border="1"> <thead> <tr> <th>Code</th> <th>Description</th> <th>Qty</th> <th>UOM</th> </tr> </thead> <tbody> <tr> <td>VM2251A0</td> <td>STEAM WATER INLET UPPER DISTRIBUTOR</td> <td>1</td> <td>PZ</td> </tr> <tr> <td>VM2252A0</td> <td>STEAM WATER INLET LOWER DISTRIBUTOR</td> <td>1</td> <td>PZ</td> </tr> </tbody> </table>	Code	Description	Qty	UOM	VM2251A0	STEAM WATER INLET UPPER DISTRIBUTOR	1	PZ	VM2252A0	STEAM WATER INLET LOWER DISTRIBUTOR	1	PZ
Code	Description	Qty	UOM														
VM2251A0	STEAM WATER INLET UPPER DISTRIBUTOR	1	PZ														
VM2252A0	STEAM WATER INLET LOWER DISTRIBUTOR	1	PZ														
TB2918A	XEVC-2011-E 4 WAYS WATER PIPE ASSEMBLY		TB2918A0	XEVC-2011-E 4 WAYS WATER PIPE ASSEMBLY													



COMPONENT			SPARE PART														
Code	Description	Image	Code	Description	Components list												
VM2251A	STEAM WATER INLET UPPER DISTRIBUTOR		KVM2251A	STEAM WATER INLET UP+LO DISTRIBUTORS KIT	<table border="1"> <thead> <tr> <th>Code</th> <th>Description</th> <th>Qty</th> <th>UOM</th> </tr> </thead> <tbody> <tr> <td>VM2251A0</td> <td>STEAM WATER INLET UPPER DISTRIBUTOR</td> <td>1</td> <td>PZ</td> </tr> <tr> <td>VM2252A0</td> <td>STEAM WATER INLET LOWER DISTRIBUTOR</td> <td>1</td> <td>PZ</td> </tr> </tbody> </table>	Code	Description	Qty	UOM	VM2251A0	STEAM WATER INLET UPPER DISTRIBUTOR	1	PZ	VM2252A0	STEAM WATER INLET LOWER DISTRIBUTOR	1	PZ
Code	Description	Qty	UOM														
VM2251A0	STEAM WATER INLET UPPER DISTRIBUTOR	1	PZ														
VM2252A0	STEAM WATER INLET LOWER DISTRIBUTOR	1	PZ														
VM2252A	STEAM WATER INLET LOWER DISTRIBUTOR		KVM2251A	STEAM WATER INLET UP+LO DISTRIBUTORS KIT	<table border="1"> <thead> <tr> <th>Code</th> <th>Description</th> <th>Qty</th> <th>UOM</th> </tr> </thead> <tbody> <tr> <td>VM2251A0</td> <td>STEAM WATER INLET UPPER DISTRIBUTOR</td> <td>1</td> <td>PZ</td> </tr> <tr> <td>VM2252A0</td> <td>STEAM WATER INLET LOWER DISTRIBUTOR</td> <td>1</td> <td>PZ</td> </tr> </tbody> </table>	Code	Description	Qty	UOM	VM2251A0	STEAM WATER INLET UPPER DISTRIBUTOR	1	PZ	VM2252A0	STEAM WATER INLET LOWER DISTRIBUTOR	1	PZ
Code	Description	Qty	UOM														
VM2251A0	STEAM WATER INLET UPPER DISTRIBUTOR	1	PZ														
VM2252A0	STEAM WATER INLET LOWER DISTRIBUTOR	1	PZ														
TB2919A	XEVC-2011-E 3 WAYS WATER PIPE ASSEMBLY		TB2919A0	XEVC-2011-E 3 WAYS WATER PIPE ASSEMBLY													
VM2251A	STEAM WATER INLET UPPER DISTRIBUTOR		KVM2251A	STEAM WATER INLET UP+LO DISTRIBUTORS KIT	<table border="1"> <thead> <tr> <th>Code</th> <th>Description</th> <th>Qty</th> <th>UOM</th> </tr> </thead> <tbody> <tr> <td>VM2251A0</td> <td>STEAM WATER INLET UPPER DISTRIBUTOR</td> <td>1</td> <td>PZ</td> </tr> <tr> <td>VM2252A0</td> <td>STEAM WATER INLET LOWER DISTRIBUTOR</td> <td>1</td> <td>PZ</td> </tr> </tbody> </table>	Code	Description	Qty	UOM	VM2251A0	STEAM WATER INLET UPPER DISTRIBUTOR	1	PZ	VM2252A0	STEAM WATER INLET LOWER DISTRIBUTOR	1	PZ
Code	Description	Qty	UOM														
VM2251A0	STEAM WATER INLET UPPER DISTRIBUTOR	1	PZ														
VM2252A0	STEAM WATER INLET LOWER DISTRIBUTOR	1	PZ														
VM2252A	STEAM WATER INLET LOWER DISTRIBUTOR		KVM2251A	STEAM WATER INLET UP+LO DISTRIBUTORS KIT	<table border="1"> <thead> <tr> <th>Code</th> <th>Description</th> <th>Qty</th> <th>UOM</th> </tr> </thead> <tbody> <tr> <td>VM2251A0</td> <td>STEAM WATER INLET UPPER DISTRIBUTOR</td> <td>1</td> <td>PZ</td> </tr> <tr> <td>VM2252A0</td> <td>STEAM WATER INLET LOWER DISTRIBUTOR</td> <td>1</td> <td>PZ</td> </tr> </tbody> </table>	Code	Description	Qty	UOM	VM2251A0	STEAM WATER INLET UPPER DISTRIBUTOR	1	PZ	VM2252A0	STEAM WATER INLET LOWER DISTRIBUTOR	1	PZ
Code	Description	Qty	UOM														
VM2251A0	STEAM WATER INLET UPPER DISTRIBUTOR	1	PZ														
VM2252A0	STEAM WATER INLET LOWER DISTRIBUTOR	1	PZ														









COMPONENT			SPARE PART																		
Code	Description	Image	Code	Description	Components list																
TB2920A	XEVC-2011-E 2 WAYS WATER PIPE ASSEMBLY		TB2920A0	XEVC-2011-E 2 WAYS WATER PIPE ASSEMBLY																	
TB2921A	XEVC-2011-E LOWER WATER PIP		TB2921A0	XEVC-2011-E LOWER WATER PIP																	
VM2332A	WATER PIPE BUSHING		KVM2332A	WATER PIPE BUSHING KIT VM2332A0	<table border="1"> <thead> <tr> <th>Code</th> <th>Description</th> <th>Qty</th> <th>UOM</th> </tr> </thead> <tbody> <tr> <td>VM2332A0</td> <td>WATER PIPE BUSHING</td> <td>1</td> <td>PZ</td> </tr> <tr> <td>VM2332A0</td> <td>WATER PIPE BUSHING</td> <td>1</td> <td>PZ</td> </tr> </tbody> </table>	Code	Description	Qty	UOM	VM2332A0	WATER PIPE BUSHING	1	PZ	VM2332A0	WATER PIPE BUSHING	1	PZ				
Code	Description	Qty	UOM																		
VM2332A0	WATER PIPE BUSHING	1	PZ																		
VM2332A0	WATER PIPE BUSHING	1	PZ																		
VM2350A	CORE PROBE SUPPORT		KVM2350A	CORE PROBE SUPPORT KIT	<table border="1"> <thead> <tr> <th>Code</th> <th>Description</th> <th>Qty</th> <th>UOM</th> </tr> </thead> <tbody> <tr> <td>V11220A1</td> <td>4,2X12 TCB SELF-TAPPIN G SCREW</td> <td>2</td> <td>PZ</td> </tr> <tr> <td>VM2350A0</td> <td>CORE PROBE SUPPORT</td> <td>1</td> <td>PZ</td> </tr> <tr> <td>VM2350A0</td> <td>CORE PROBE SUPPORT</td> <td>1</td> <td>PZ</td> </tr> </tbody> </table>	Code	Description	Qty	UOM	V11220A1	4,2X12 TCB SELF-TAPPIN G SCREW	2	PZ	VM2350A0	CORE PROBE SUPPORT	1	PZ	VM2350A0	CORE PROBE SUPPORT	1	PZ
Code	Description	Qty	UOM																		
V11220A1	4,2X12 TCB SELF-TAPPIN G SCREW	2	PZ																		
VM2350A0	CORE PROBE SUPPORT	1	PZ																		
VM2350A0	CORE PROBE SUPPORT	1	PZ																		
GN1085A	141X24 HEATING ELEMENT GASKET		KG1085A	HEATING ELEMENT GASKET KIT	<table border="1"> <thead> <tr> <th>Code</th> <th>Description</th> <th>Qty</th> <th>UOM</th> </tr> </thead> <tbody> <tr> <td>GN1085A2</td> <td>141X24 HEATING ELEMENT GASKET</td> <td>1</td> <td>PZ</td> </tr> </tbody> </table>	Code	Description	Qty	UOM	GN1085A2	141X24 HEATING ELEMENT GASKET	1	PZ								
Code	Description	Qty	UOM																		
GN1085A2	141X24 HEATING ELEMENT GASKET	1	PZ																		

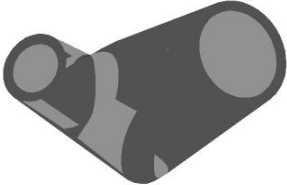

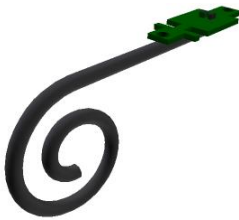

COMPONENT			SPARE PART																																										
Code	Description	Image	Code	Description	Components list																																								
RS1205A	6 TURNS 5.6KW 230 HEATING ELEMENT		KRS1205A	5.6KW HEATING ELEMENT KIT	<table border="1"> <thead> <tr> <th>Code</th> <th>Description</th> <th>Qty</th> <th>UOM</th> </tr> </thead> <tbody> <tr> <td>GN1085A2</td> <td>141X24 HEATING ELEMENT GASKET</td> <td>1</td> <td>PZ</td> </tr> <tr> <td>RS1205A1</td> <td>6 TURNS 5.6KW 230 HEATING ELEMENT</td> <td>1</td> <td>PZ</td> </tr> <tr> <td>SL1045A0</td> <td>S53 BLACK SILICONE - 80ML CARTRIDGE</td> <td>1</td> <td>PZ</td> </tr> <tr> <td>VI1032A0</td> <td>SCREW M4X16 TCB+ INOX</td> <td>1</td> <td>PZ</td> </tr> <tr> <td>VI1075A0</td> <td>NUT M4 H=4 UNI5587 INOX</td> <td>1</td> <td>PZ</td> </tr> <tr> <td>VI1220A1</td> <td>4,2X12 TCB SELF-TAPPING SCREW</td> <td>6</td> <td>PZ</td> </tr> <tr> <td>VI1511A0</td> <td>STAINLESS STEEL WASHER 4.2X12X1</td> <td>1</td> <td>PZ</td> </tr> <tr> <td>VM1794A0</td> <td>250X4.8 PA66 BLACK CLAMP</td> <td>2</td> <td>PZ</td> </tr> <tr> <td>VM2103A0</td> <td>CLAMP LOCK</td> <td>2</td> <td>PZ</td> </tr> </tbody> </table>	Code	Description	Qty	UOM	GN1085A2	141X24 HEATING ELEMENT GASKET	1	PZ	RS1205A1	6 TURNS 5.6KW 230 HEATING ELEMENT	1	PZ	SL1045A0	S53 BLACK SILICONE - 80ML CARTRIDGE	1	PZ	VI1032A0	SCREW M4X16 TCB+ INOX	1	PZ	VI1075A0	NUT M4 H=4 UNI5587 INOX	1	PZ	VI1220A1	4,2X12 TCB SELF-TAPPING SCREW	6	PZ	VI1511A0	STAINLESS STEEL WASHER 4.2X12X1	1	PZ	VM1794A0	250X4.8 PA66 BLACK CLAMP	2	PZ	VM2103A0	CLAMP LOCK	2	PZ
					Code	Description	Qty	UOM																																					
					GN1085A2	141X24 HEATING ELEMENT GASKET	1	PZ																																					
					RS1205A1	6 TURNS 5.6KW 230 HEATING ELEMENT	1	PZ																																					
					SL1045A0	S53 BLACK SILICONE - 80ML CARTRIDGE	1	PZ																																					
					VI1032A0	SCREW M4X16 TCB+ INOX	1	PZ																																					
					VI1075A0	NUT M4 H=4 UNI5587 INOX	1	PZ																																					
					VI1220A1	4,2X12 TCB SELF-TAPPING SCREW	6	PZ																																					
					VI1511A0	STAINLESS STEEL WASHER 4.2X12X1	1	PZ																																					
					VM1794A0	250X4.8 PA66 BLACK CLAMP	2	PZ																																					
VM2103A0	CLAMP LOCK	2	PZ																																										
SN1016A	100MM CORE PROBE KIT L2750		KSN1016A	100MM CORE PROBE KIT L2730	<table border="1"> <thead> <tr> <th>Code</th> <th>Description</th> <th>Qty</th> <th>UOM</th> </tr> </thead> <tbody> <tr> <td>SN1016A1</td> <td>100MM CORE PROBE KIT L2750</td> <td>1</td> <td>PZ</td> </tr> </tbody> </table>	Code	Description	Qty	UOM	SN1016A1	100MM CORE PROBE KIT L2750	1	PZ																																
Code	Description	Qty	UOM																																										
SN1016A1	100MM CORE PROBE KIT L2750	1	PZ																																										
0H2730A	ZINC PLATED MUFFLE SUPPORT BRACKET																																												

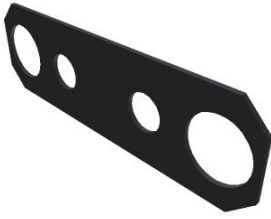
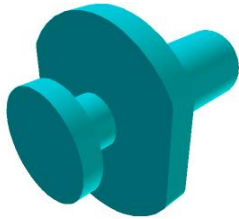
COMPONENT			SPARE PART										
Code	Description	Image	Code	Description	Components list								
GN1544A	AIR INLET GASKET		GN1544A0	AIR INLET GASKET									
RC1055A	Ø25-40 H12 STAINLESS STEEL PIPE CLIP		KRC1055A	Ø25-40 PIPE CLAMP 10PCS KIT	<table border="1"> <thead> <tr> <th>Code</th> <th>Description</th> <th>Qty</th> <th>UOM</th> </tr> </thead> <tbody> <tr> <td>RC1055A0</td> <td>Ø25-40 H12 STAINLESS STEEL PIPE CLIP</td> <td>10</td> <td>PZ</td> </tr> </tbody> </table>	Code	Description	Qty	UOM	RC1055A0	Ø25-40 H12 STAINLESS STEEL PIPE CLIP	10	PZ
Code	Description	Qty	UOM										
RC1055A0	Ø25-40 H12 STAINLESS STEEL PIPE CLIP	10	PZ										
TB3020A	TB1520A-BLACK EPDM PIPE L=275M		TB3020A0	TB1520A-BLACK EPDM PIPE L=275M									
TB3021A	TB1520A-BLACK EPDM PIPE L=448M		TB3021A0	TB1520A-BLACK EPDM PIPE L=448M									
TB3022A	TB1520A-BLACK EPDM PIPE L=140M		TB3022A0	TB1520A-BLACK EPDM PIPE L=140M									



COMPONENT			SPARE PART																																																																						
Code	Description	Image	Code	Description	Components list																																																																				
TB3023A	TB1520A-BLACK EPDM PIPE L=230M		TB3023A0	TB1520A-BLACK EPDM PIPE L=230M																																																																					
VM2377A	220 V 50/60 HZ VENTURI KIT		KVM2377A	MM 220 V VENTURI ACTUATOR SYSTEM KIT	<table border="1"> <thead> <tr> <th>Code</th> <th>Description</th> <th>Qty</th> <th>UOM</th> </tr> </thead> <tbody> <tr> <td>GN1556A0</td> <td>MM VENTURI SEAL</td> <td>1</td> <td>PZ</td> </tr> <tr> <td>RC1378A0</td> <td>HOSE CLAMP</td> <td>3</td> <td>PZ</td> </tr> <tr> <td>TB1520A0</td> <td>INT. Ø=38 TH=4 DRAIN BLACK RUBBER PIPE</td> <td>0.170</td> <td>M</td> </tr> <tr> <td>VE1135A0</td> <td>220 V 50/60 HZ VENTURI ACTUATOR</td> <td>1</td> <td>PZ</td> </tr> <tr> <td>VI1032A0</td> <td>SCREW M4X16 TCB+ INOX</td> <td>1</td> <td>PZ</td> </tr> <tr> <td>VI1220A1</td> <td>4,2X12 TCB SELF-TAPPIN G SCREW</td> <td>6</td> <td>PZ</td> </tr> <tr> <td>VM2345A0</td> <td>MM VENTURI UPPER HALF</td> <td>1</td> <td>PZ</td> </tr> <tr> <td>VM2345A0</td> <td>MM VENTURI UPPER HALF</td> <td>1</td> <td>PZ</td> </tr> <tr> <td>VM2346A0</td> <td>MM VENTURI LOWER HALF</td> <td>1</td> <td>PZ</td> </tr> <tr> <td>VM2346A0</td> <td>MM VENTURI LOWER HALF</td> <td>1</td> <td>PZ</td> </tr> <tr> <td>VM2347A0</td> <td>MIND.MAPS VENTURI COVER</td> <td>1</td> <td>PZ</td> </tr> <tr> <td>VM2347A0</td> <td>MIND.MAPS VENTURI COVER</td> <td>1</td> <td>PZ</td> </tr> <tr> <td>VM2348A0</td> <td>VENTURI PLATE SPACE</td> <td>1</td> <td>PZ</td> </tr> <tr> <td>VM2348A0</td> <td>VENTURI PLATE SPACE</td> <td>1</td> <td>PZ</td> </tr> <tr> <td>VM2349A0</td> <td>VENTURI LOWER BUSHING</td> <td>1</td> <td>PZ</td> </tr> <tr> <td>VM2349A0</td> <td>VENTURI LOWER BUSHING</td> <td>1</td> <td>PZ</td> </tr> </tbody> </table>	Code	Description	Qty	UOM	GN1556A0	MM VENTURI SEAL	1	PZ	RC1378A0	HOSE CLAMP	3	PZ	TB1520A0	INT. Ø=38 TH=4 DRAIN BLACK RUBBER PIPE	0.170	M	VE1135A0	220 V 50/60 HZ VENTURI ACTUATOR	1	PZ	VI1032A0	SCREW M4X16 TCB+ INOX	1	PZ	VI1220A1	4,2X12 TCB SELF-TAPPIN G SCREW	6	PZ	VM2345A0	MM VENTURI UPPER HALF	1	PZ	VM2345A0	MM VENTURI UPPER HALF	1	PZ	VM2346A0	MM VENTURI LOWER HALF	1	PZ	VM2346A0	MM VENTURI LOWER HALF	1	PZ	VM2347A0	MIND.MAPS VENTURI COVER	1	PZ	VM2347A0	MIND.MAPS VENTURI COVER	1	PZ	VM2348A0	VENTURI PLATE SPACE	1	PZ	VM2348A0	VENTURI PLATE SPACE	1	PZ	VM2349A0	VENTURI LOWER BUSHING	1	PZ	VM2349A0	VENTURI LOWER BUSHING	1	PZ
Code	Description	Qty	UOM																																																																						
GN1556A0	MM VENTURI SEAL	1	PZ																																																																						
RC1378A0	HOSE CLAMP	3	PZ																																																																						
TB1520A0	INT. Ø=38 TH=4 DRAIN BLACK RUBBER PIPE	0.170	M																																																																						
VE1135A0	220 V 50/60 HZ VENTURI ACTUATOR	1	PZ																																																																						
VI1032A0	SCREW M4X16 TCB+ INOX	1	PZ																																																																						
VI1220A1	4,2X12 TCB SELF-TAPPIN G SCREW	6	PZ																																																																						
VM2345A0	MM VENTURI UPPER HALF	1	PZ																																																																						
VM2345A0	MM VENTURI UPPER HALF	1	PZ																																																																						
VM2346A0	MM VENTURI LOWER HALF	1	PZ																																																																						
VM2346A0	MM VENTURI LOWER HALF	1	PZ																																																																						
VM2347A0	MIND.MAPS VENTURI COVER	1	PZ																																																																						
VM2347A0	MIND.MAPS VENTURI COVER	1	PZ																																																																						
VM2348A0	VENTURI PLATE SPACE	1	PZ																																																																						
VM2348A0	VENTURI PLATE SPACE	1	PZ																																																																						
VM2349A0	VENTURI LOWER BUSHING	1	PZ																																																																						
VM2349A0	VENTURI LOWER BUSHING	1	PZ																																																																						

COMPONENT			SPARE PART																																		
Code	Description	Image	Code	Description	Components list																																
GN1584A	CORNER FITTING D30-D16		KG1584A	D30-D16 CORNER FITTING KIT	<table border="1"> <thead> <tr> <th>Code</th> <th>Description</th> <th>Qty</th> <th>UOM</th> </tr> </thead> <tbody> <tr> <td>GN1584A0</td> <td>CORNER FITTING D30-D16</td> <td>1</td> <td>PZ</td> </tr> </tbody> </table>	Code	Description	Qty	UOM	GN1584A0	CORNER FITTING D30-D16	1	PZ																								
Code	Description	Qty	UOM																																		
GN1584A0	CORNER FITTING D30-D16	1	PZ																																		
TB1956A	TB1520A-GREY SILICONE PIPE L=0,04M		KTB1002A KTB1001A KTB1000A	BLACK TUBE KIT EPDM 60MT TB1520 BLACK TUBE KIT EPDM 10MT TB1520 BLACK TUBE KIT EPDM 2MT TB1520A	<table border="1"> <thead> <tr> <th>Code</th> <th>Description</th> <th>Qty</th> <th>UOM</th> </tr> </thead> <tbody> <tr> <td>IL1206C0</td> <td>968X1053 H126 XBC WOOD PALLE</td> <td>1</td> <td>PZ</td> </tr> <tr> <td>TB1520A0</td> <td>INT. Ø=38 TH=4 DRAIN BLACK RUBBER PIPE</td> <td>60</td> <td>M</td> </tr> <tr> <td>TB1520A0</td> <td>INT. Ø=38 TH=4 DRAIN BLACK RUBBER PIPE</td> <td>10</td> <td>M</td> </tr> <tr> <td>VM1794A0</td> <td>250X4.8 PA66 BLACK CLAMP</td> <td>3</td> <td>PZ</td> </tr> <tr> <td>RC1055A0</td> <td>Ø25-40 H12 STAINLESS STEEL PIPE CLIP</td> <td>2</td> <td>PZ</td> </tr> <tr> <td>TB1520A0</td> <td>INT. Ø=38 TH=4 DRAIN BLACK RUBBER PIPE</td> <td>2</td> <td>M</td> </tr> <tr> <td>VM1059A1</td> <td>HEAT SHRINK FILM H800</td> <td>1.500</td> <td>M</td> </tr> </tbody> </table>	Code	Description	Qty	UOM	IL1206C0	968X1053 H126 XBC WOOD PALLE	1	PZ	TB1520A0	INT. Ø=38 TH=4 DRAIN BLACK RUBBER PIPE	60	M	TB1520A0	INT. Ø=38 TH=4 DRAIN BLACK RUBBER PIPE	10	M	VM1794A0	250X4.8 PA66 BLACK CLAMP	3	PZ	RC1055A0	Ø25-40 H12 STAINLESS STEEL PIPE CLIP	2	PZ	TB1520A0	INT. Ø=38 TH=4 DRAIN BLACK RUBBER PIPE	2	M	VM1059A1	HEAT SHRINK FILM H800	1.500	M
Code	Description	Qty	UOM																																		
IL1206C0	968X1053 H126 XBC WOOD PALLE	1	PZ																																		
TB1520A0	INT. Ø=38 TH=4 DRAIN BLACK RUBBER PIPE	60	M																																		
TB1520A0	INT. Ø=38 TH=4 DRAIN BLACK RUBBER PIPE	10	M																																		
VM1794A0	250X4.8 PA66 BLACK CLAMP	3	PZ																																		
RC1055A0	Ø25-40 H12 STAINLESS STEEL PIPE CLIP	2	PZ																																		
TB1520A0	INT. Ø=38 TH=4 DRAIN BLACK RUBBER PIPE	2	M																																		
VM1059A1	HEAT SHRINK FILM H800	1.500	M																																		
RC1042A	DOUBLE WIRE SPRING CLAMP D21.5-22.6		RC1042A0	DOUBLE WIRE SPRING CLAMP D21.5-22.6																																	

COMPONENT			SPARE PART																						
Code	Description	Image	Code	Description	Components list																				
PE1710B	MOTOR REVOLUTION AND DIRECTION SENSO		KPE1710B	MOTOR REVOLUTIONS SENSOR KIT	<table border="1"> <thead> <tr> <th>Code</th> <th>Description</th> <th>Qty</th> <th>UOM</th> </tr> </thead> <tbody> <tr> <td>PE1710B0</td> <td>MOTOR REVOLUTION AND DIRECTION SENSOR</td> <td>1</td> <td>PZ</td> </tr> <tr> <td>VE1550A0</td> <td>5X3 MM NEODYMIUM MAGNET</td> <td>1</td> <td>PZ</td> </tr> <tr> <td>VI1966A0</td> <td>M4X14 FLATHEAD SCREW</td> <td>1</td> <td>PZ</td> </tr> <tr> <td>VM1635A0</td> <td>MAGNET HOLDING DIS</td> <td>1</td> <td>PZ</td> </tr> </tbody> </table>	Code	Description	Qty	UOM	PE1710B0	MOTOR REVOLUTION AND DIRECTION SENSOR	1	PZ	VE1550A0	5X3 MM NEODYMIUM MAGNET	1	PZ	VI1966A0	M4X14 FLATHEAD SCREW	1	PZ	VM1635A0	MAGNET HOLDING DIS	1	PZ
Code	Description	Qty	UOM																						
PE1710B0	MOTOR REVOLUTION AND DIRECTION SENSOR	1	PZ																						
VE1550A0	5X3 MM NEODYMIUM MAGNET	1	PZ																						
VI1966A0	M4X14 FLATHEAD SCREW	1	PZ																						
VM1635A0	MAGNET HOLDING DIS	1	PZ																						
VE1550A	5X3 MM NEODYMIUM MAGNET		VE1550A0	5X3 MM NEODYMIUM MAGNET																					
GN1588A	78X28 G6.25 HEATING ELEMENT GASKET		GN1588A0	78X28 G6.25 HEATING ELEMENT GASKET																					
VM2416A	SMOKER BLOCKING GUIDE PIN		VM2416A0	SMOKER BLOCKING GUIDE PIN																					
MT1012A	330W 230V MOTOR		KMT1012A	MIND.MAPS 330W 230V MOTOR KIT	<table border="1"> <thead> <tr> <th>Code</th> <th>Description</th> <th>Qty</th> <th>UOM</th> </tr> </thead> <tbody> <tr> <td>0H4305A1</td> <td>ST. STEEL MOTOR SHAFT SEALING DISC</td> <td>1</td> <td>PZ</td> </tr> <tr> <td>GN1140A2</td> <td>MOTOR HOLDER GASKET</td> <td>1</td> <td>PZ</td> </tr> <tr> <td>MT1012A0</td> <td>330W 230V MOTOR</td> <td>1</td> <td>PZ</td> </tr> </tbody> </table>	Code	Description	Qty	UOM	0H4305A1	ST. STEEL MOTOR SHAFT SEALING DISC	1	PZ	GN1140A2	MOTOR HOLDER GASKET	1	PZ	MT1012A0	330W 230V MOTOR	1	PZ				
Code	Description	Qty	UOM																						
0H4305A1	ST. STEEL MOTOR SHAFT SEALING DISC	1	PZ																						
GN1140A2	MOTOR HOLDER GASKET	1	PZ																						
MT1012A0	330W 230V MOTOR	1	PZ																						

COMPONENT			SPARE PART																																		
Code	Description	Image	Code	Description	Components list																																
MT1012A	330W 230V MOTOR		KMT1012A	MIND.MAPS 330W 230V MOTOR KIT	<table border="1"> <thead> <tr> <th>Code</th> <th>Description</th> <th>Qty</th> <th>UOM</th> </tr> </thead> <tbody> <tr> <td>VE1550A0</td> <td>5X3 MM NEODYMIUM MAGNET</td> <td>1</td> <td>PZ</td> </tr> <tr> <td>VI1077A1</td> <td>SCREW M6X12 TE INOX</td> <td>1</td> <td>PZ</td> </tr> <tr> <td>VI1521A0</td> <td>STAINLESS STEEL WASHER D=6 6592</td> <td>1</td> <td>PZ</td> </tr> <tr> <td>VI1966A0</td> <td>M4X14 FLATHEAD SCREW</td> <td>1</td> <td>PZ</td> </tr> <tr> <td>VM1635A0</td> <td>MAGNET HOLDING DIS</td> <td>1</td> <td>PZ</td> </tr> <tr> <td>VM1794A0</td> <td>250X4.8 PA66 BLACK CLAMP</td> <td>4</td> <td>PZ</td> </tr> <tr> <td>VM2103A0</td> <td>CLAMP LOCK</td> <td>4</td> <td>PZ</td> </tr> </tbody> </table>	Code	Description	Qty	UOM	VE1550A0	5X3 MM NEODYMIUM MAGNET	1	PZ	VI1077A1	SCREW M6X12 TE INOX	1	PZ	VI1521A0	STAINLESS STEEL WASHER D=6 6592	1	PZ	VI1966A0	M4X14 FLATHEAD SCREW	1	PZ	VM1635A0	MAGNET HOLDING DIS	1	PZ	VM1794A0	250X4.8 PA66 BLACK CLAMP	4	PZ	VM2103A0	CLAMP LOCK	4	PZ
					Code	Description	Qty	UOM																													
					VE1550A0	5X3 MM NEODYMIUM MAGNET	1	PZ																													
					VI1077A1	SCREW M6X12 TE INOX	1	PZ																													
					VI1521A0	STAINLESS STEEL WASHER D=6 6592	1	PZ																													
					VI1966A0	M4X14 FLATHEAD SCREW	1	PZ																													
					VM1635A0	MAGNET HOLDING DIS	1	PZ																													
					VM1794A0	250X4.8 PA66 BLACK CLAMP	4	PZ																													
VM2103A0	CLAMP LOCK	4	PZ																																		
0H7170A	MM MOTOR GLASS WOOL PLATE		0H7170A0	MM MOTOR GLASS WOOL PLATE																																	
GN1140A	MOTOR HOLDER GASKET		KGN1140A	5 PCS. MOTOR HOLDER GASKET KI	<table border="1"> <thead> <tr> <th>Code</th> <th>Description</th> <th>Qty</th> <th>UOM</th> </tr> </thead> <tbody> <tr> <td>GN1140A2</td> <td>MOTOR HOLDER GASKET</td> <td>5</td> <td>PZ</td> </tr> </tbody> </table>	Code	Description	Qty	UOM	GN1140A2	MOTOR HOLDER GASKET	5	PZ																								
					Code	Description	Qty	UOM																													
GN1140A2	MOTOR HOLDER GASKET	5	PZ																																		
0H4305A	ST. STEEL MOTOR SHAFT SEALING DIS		K0H4305A	SEALING DISC FOR MOTOR SHAFT KIT	<table border="1"> <thead> <tr> <th>Code</th> <th>Description</th> <th>Qty</th> <th>UOM</th> </tr> </thead> <tbody> <tr> <td>0H4305A1</td> <td>ST. STEEL MOTOR SHAFT SEALING DISC</td> <td>1</td> <td>PZ</td> </tr> <tr> <td>GN1140A2</td> <td>MOTOR HOLDER GASKET</td> <td>1</td> <td>PZ</td> </tr> <tr> <td>SL1045A0</td> <td>S53 BLACK SILICONE - 80ML CARTRIDGE</td> <td>1</td> <td>PZ</td> </tr> <tr> <td>VI1220A1</td> <td>4,2X12 TCB SELF-TAPPIN G SCREW</td> <td>3</td> <td>PZ</td> </tr> </tbody> </table>	Code	Description	Qty	UOM	0H4305A1	ST. STEEL MOTOR SHAFT SEALING DISC	1	PZ	GN1140A2	MOTOR HOLDER GASKET	1	PZ	SL1045A0	S53 BLACK SILICONE - 80ML CARTRIDGE	1	PZ	VI1220A1	4,2X12 TCB SELF-TAPPIN G SCREW	3	PZ												
Code	Description	Qty	UOM																																		
0H4305A1	ST. STEEL MOTOR SHAFT SEALING DISC	1	PZ																																		
GN1140A2	MOTOR HOLDER GASKET	1	PZ																																		
SL1045A0	S53 BLACK SILICONE - 80ML CARTRIDGE	1	PZ																																		
VI1220A1	4,2X12 TCB SELF-TAPPIN G SCREW	3	PZ																																		

COMPONENT			SPARE PART																										
Code	Description	Image	Code	Description	Components list																								
VN1170B	D195 H80 8 BLADES FAN+RING		KVN1170B	D195 H80 8 BLADES FAN + RING KIT	<table border="1"> <thead> <tr> <th>Code</th> <th>Description</th> <th>Qty</th> <th>UOM</th> </tr> </thead> <tbody> <tr> <td>VI1077A1</td> <td>SCREW M6X12 TE INOX</td> <td>1</td> <td>PZ</td> </tr> <tr> <td>VI1521A0</td> <td>STAINLESS STEEL WASHER D=6 6592</td> <td>1</td> <td>PZ</td> </tr> <tr> <td>VN1170B0</td> <td>D195 H80 8 BLADES FAN+RING</td> <td>1</td> <td>PZ</td> </tr> <tr> <td>VN1170B0</td> <td>D195 H80 8 BLADES FAN+RING</td> <td>1</td> <td>PZ</td> </tr> </tbody> </table>	Code	Description	Qty	UOM	VI1077A1	SCREW M6X12 TE INOX	1	PZ	VI1521A0	STAINLESS STEEL WASHER D=6 6592	1	PZ	VN1170B0	D195 H80 8 BLADES FAN+RING	1	PZ	VN1170B0	D195 H80 8 BLADES FAN+RING	1	PZ				
					Code	Description	Qty	UOM																					
					VI1077A1	SCREW M6X12 TE INOX	1	PZ																					
					VI1521A0	STAINLESS STEEL WASHER D=6 6592	1	PZ																					
VN1170B0	D195 H80 8 BLADES FAN+RING	1	PZ																										
VN1170B0	D195 H80 8 BLADES FAN+RING	1	PZ																										
GN1555A			KGN1555B	16EU/2011/2021 DOOR GASKET KIT	<table border="1"> <thead> <tr> <th>Code</th> <th>Description</th> <th>Qty</th> <th>UOM</th> </tr> </thead> <tbody> <tr> <td>0H1604A0</td> <td></td> <td>2</td> <td>PZ</td> </tr> <tr> <td>GN1006A1</td> <td>DOOR GASKE</td> <td>4.190</td> <td>M</td> </tr> <tr> <td>GN1008A0</td> <td>DOOR SEAL INTERNAL CONNECTION</td> <td>0.030</td> <td>M</td> </tr> <tr> <td>SL1025A0</td> <td>CLEAR SILICON DOW CORNING 734</td> <td>0.010</td> <td>PZ</td> </tr> <tr> <td>VM2277A0</td> <td>DOOR SEAL KIT INTERNAL CONNECTION</td> <td>1</td> <td>PZ</td> </tr> </tbody> </table>	Code	Description	Qty	UOM	0H1604A0		2	PZ	GN1006A1	DOOR GASKE	4.190	M	GN1008A0	DOOR SEAL INTERNAL CONNECTION	0.030	M	SL1025A0	CLEAR SILICON DOW CORNING 734	0.010	PZ	VM2277A0	DOOR SEAL KIT INTERNAL CONNECTION	1	PZ
					Code	Description	Qty	UOM																					
					0H1604A0		2	PZ																					
GN1006A1	DOOR GASKE	4.190	M																										
GN1008A0	DOOR SEAL INTERNAL CONNECTION	0.030	M																										
SL1025A0	CLEAR SILICON DOW CORNING 734	0.010	PZ																										
VM2277A0	DOOR SEAL KIT INTERNAL CONNECTION	1	PZ																										
RC1170A	STAINLESS STEEL NUT M14 H=8 CH=22		KRC1170A	M14 H8 CH22 NUT - 10 PCS. KIT	<table border="1"> <thead> <tr> <th>Code</th> <th>Description</th> <th>Qty</th> <th>UOM</th> </tr> </thead> <tbody> <tr> <td>RC1170A1</td> <td>STAINLESS STEEL NUT M14 H=8 CH=2</td> <td>10</td> <td>PZ</td> </tr> </tbody> </table>	Code	Description	Qty	UOM	RC1170A1	STAINLESS STEEL NUT M14 H=8 CH=2	10	PZ																
					Code	Description	Qty	UOM																					
RC1170A1	STAINLESS STEEL NUT M14 H=8 CH=2	10	PZ																										
TB2937B	XEBC EXTERNAL WATER PIPE D10+CONNECTION		TB2937B0	XEBC EXTERNAL WATER PIPE D10+CONNECTION																									

COMPONENT			SPARE PART																																										
Code	Description	Image	Code	Description	Components list																																								
VL1037A	WASHING SYSTEM ROTOR		KVL1037A	WASHING SYSTEM ROTOR KIT	<table border="1"> <thead> <tr> <th>Code</th> <th>Description</th> <th>Qty</th> <th>UOM</th> </tr> </thead> <tbody> <tr> <td>GN1416B0</td> <td>WASHING SYSTEM ROTOR BEARING</td> <td>1</td> <td>PZ</td> </tr> <tr> <td>TF1065B0</td> <td>WASHING SYSTEM ROTOR PIVOT</td> <td>1</td> <td>PZ</td> </tr> <tr> <td>TF1066A1</td> <td>WASHING SYSTEM ROTOR BUSH</td> <td>1</td> <td>PZ</td> </tr> <tr> <td>UG1005B1</td> <td>LONG RAY ROTOR WATER NOZZL</td> <td>1</td> <td>PZ</td> </tr> <tr> <td>UG1006B3</td> <td>LONG RAY ROTOR WATER NOZZL</td> <td>1</td> <td>PZ</td> </tr> <tr> <td>VI1220A1</td> <td>4,2X12 TCB SELF-TAPPIN G SCREW</td> <td>8</td> <td>PZ</td> </tr> <tr> <td>VM1955C0</td> <td>WASHING SYSTEM ROTOR</td> <td>1</td> <td>PZ</td> </tr> <tr> <td>VM1985C1</td> <td>WASHING SYSTEM ROTOR COVE</td> <td>1</td> <td>PZ</td> </tr> <tr> <td>VM1986A0</td> <td>NOZZLE COVE</td> <td>2</td> <td>PZ</td> </tr> </tbody> </table>	Code	Description	Qty	UOM	GN1416B0	WASHING SYSTEM ROTOR BEARING	1	PZ	TF1065B0	WASHING SYSTEM ROTOR PIVOT	1	PZ	TF1066A1	WASHING SYSTEM ROTOR BUSH	1	PZ	UG1005B1	LONG RAY ROTOR WATER NOZZL	1	PZ	UG1006B3	LONG RAY ROTOR WATER NOZZL	1	PZ	VI1220A1	4,2X12 TCB SELF-TAPPIN G SCREW	8	PZ	VM1955C0	WASHING SYSTEM ROTOR	1	PZ	VM1985C1	WASHING SYSTEM ROTOR COVE	1	PZ	VM1986A0	NOZZLE COVE	2	PZ
Code	Description	Qty	UOM																																										
GN1416B0	WASHING SYSTEM ROTOR BEARING	1	PZ																																										
TF1065B0	WASHING SYSTEM ROTOR PIVOT	1	PZ																																										
TF1066A1	WASHING SYSTEM ROTOR BUSH	1	PZ																																										
UG1005B1	LONG RAY ROTOR WATER NOZZL	1	PZ																																										
UG1006B3	LONG RAY ROTOR WATER NOZZL	1	PZ																																										
VI1220A1	4,2X12 TCB SELF-TAPPIN G SCREW	8	PZ																																										
VM1955C0	WASHING SYSTEM ROTOR	1	PZ																																										
VM1985C1	WASHING SYSTEM ROTOR COVE	1	PZ																																										
VM1986A0	NOZZLE COVE	2	PZ																																										
VL1037A	WASHING SYSTEM ROTOR		KVL1037A	WASHING SYSTEM ROTOR KIT	<table border="1"> <thead> <tr> <th>Code</th> <th>Description</th> <th>Qty</th> <th>UOM</th> </tr> </thead> <tbody> <tr> <td>GN1416B0</td> <td>WASHING SYSTEM ROTOR BEARING</td> <td>1</td> <td>PZ</td> </tr> <tr> <td>TF1065B0</td> <td>WASHING SYSTEM ROTOR PIVOT</td> <td>1</td> <td>PZ</td> </tr> <tr> <td>TF1066A1</td> <td>WASHING SYSTEM ROTOR BUSH</td> <td>1</td> <td>PZ</td> </tr> <tr> <td>UG1005B1</td> <td>LONG RAY ROTOR WATER NOZZL</td> <td>1</td> <td>PZ</td> </tr> <tr> <td>UG1006B3</td> <td>LONG RAY ROTOR WATER NOZZL</td> <td>1</td> <td>PZ</td> </tr> <tr> <td>VI1220A1</td> <td>4,2X12 TCB SELF-TAPPIN G SCREW</td> <td>8</td> <td>PZ</td> </tr> <tr> <td>VM1955C0</td> <td>WASHING SYSTEM ROTOR</td> <td>1</td> <td>PZ</td> </tr> <tr> <td>VM1985C1</td> <td>WASHING SYSTEM ROTOR COVE</td> <td>1</td> <td>PZ</td> </tr> <tr> <td>VM1986A0</td> <td>NOZZLE COVE</td> <td>2</td> <td>PZ</td> </tr> </tbody> </table>	Code	Description	Qty	UOM	GN1416B0	WASHING SYSTEM ROTOR BEARING	1	PZ	TF1065B0	WASHING SYSTEM ROTOR PIVOT	1	PZ	TF1066A1	WASHING SYSTEM ROTOR BUSH	1	PZ	UG1005B1	LONG RAY ROTOR WATER NOZZL	1	PZ	UG1006B3	LONG RAY ROTOR WATER NOZZL	1	PZ	VI1220A1	4,2X12 TCB SELF-TAPPIN G SCREW	8	PZ	VM1955C0	WASHING SYSTEM ROTOR	1	PZ	VM1985C1	WASHING SYSTEM ROTOR COVE	1	PZ	VM1986A0	NOZZLE COVE	2	PZ
Code	Description	Qty	UOM																																										
GN1416B0	WASHING SYSTEM ROTOR BEARING	1	PZ																																										
TF1065B0	WASHING SYSTEM ROTOR PIVOT	1	PZ																																										
TF1066A1	WASHING SYSTEM ROTOR BUSH	1	PZ																																										
UG1005B1	LONG RAY ROTOR WATER NOZZL	1	PZ																																										
UG1006B3	LONG RAY ROTOR WATER NOZZL	1	PZ																																										
VI1220A1	4,2X12 TCB SELF-TAPPIN G SCREW	8	PZ																																										
VM1955C0	WASHING SYSTEM ROTOR	1	PZ																																										
VM1985C1	WASHING SYSTEM ROTOR COVE	1	PZ																																										
VM1986A0	NOZZLE COVE	2	PZ																																										