







Assembly code	Assembly revision	Assembly image
ASM2825A/0.D00	General overview	
ASM1312A/0.D02	General overview	
ASM1333A/0.D00	General overview	
ASM1311A/0.D01	External cover	



ASM2825A/0.D00 - General overview

FRONT





ASM2825A/0.D00 - General overview

REAR

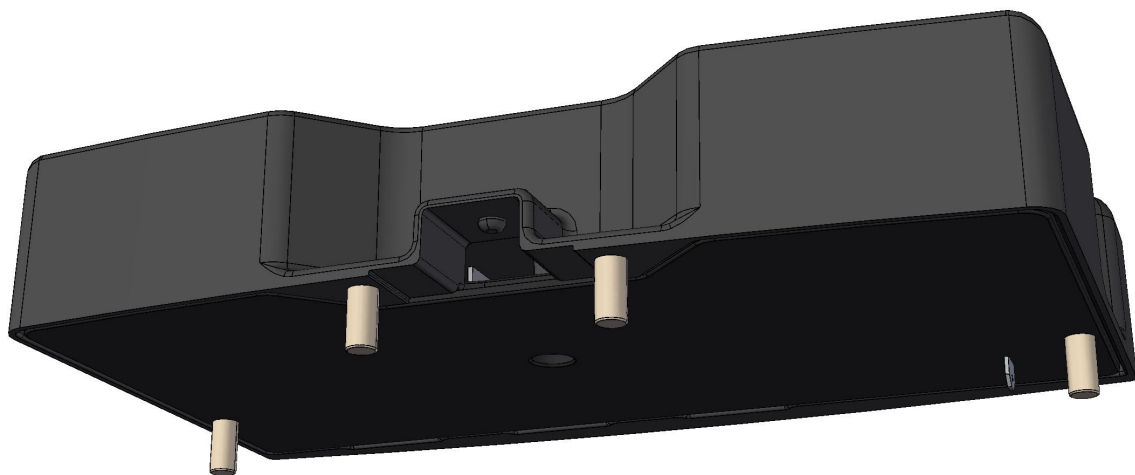





COMPONENT			SPARE PART																						
Code	Description	Image	Code	Description	Components list																				
TR1141A	THERMOSTAT KIT 2-72°C		KTR1141A	THERMOSTAT KIT TR1141A	<table border="1"> <thead> <tr> <th>Code</th> <th>Description</th> <th>Qty</th> <th>UOM</th> </tr> </thead> <tbody> <tr> <td>TR1141A0</td> <td>THERMOSTAT KIT 2-72°C</td> <td>1.500</td> <td>PZ</td> </tr> <tr> <td>VI1850A0</td> <td>M4X6 NICKEL PLATED FIXING SCRE</td> <td>2</td> <td>PZ</td> </tr> </tbody> </table>	Code	Description	Qty	UOM	TR1141A0	THERMOSTAT KIT 2-72°C	1.500	PZ	VI1850A0	M4X6 NICKEL PLATED FIXING SCRE	2	PZ								
Code	Description	Qty	UOM																						
TR1141A0	THERMOSTAT KIT 2-72°C	1.500	PZ																						
VI1850A0	M4X6 NICKEL PLATED FIXING SCRE	2	PZ																						
VM1019B	MANUAL PROOVER PLASTIC CONTROL PANEL		KVM1019B	MANUAL PROVER CONTROL BOARD KIT	<table border="1"> <thead> <tr> <th>Code</th> <th>Description</th> <th>Qty</th> <th>UOM</th> </tr> </thead> <tbody> <tr> <td>MS1018B0</td> <td>MANUAL PROOFER CONTROL BOARD STICKER</td> <td>1</td> <td>PZ</td> </tr> <tr> <td>VE1585A0</td> <td>BLUE LIGHT COVER GOLD SINUSOID</td> <td>1</td> <td>PZ</td> </tr> <tr> <td>VM1019B0</td> <td>MANUAL PROOVER PLASTIC CONTROL PANEL</td> <td>1</td> <td>PZ</td> </tr> <tr> <td>VM2009A0</td> <td>ELLIPTICAL SILVER SUPPORT D16</td> <td>3</td> <td>PZ</td> </tr> </tbody> </table>	Code	Description	Qty	UOM	MS1018B0	MANUAL PROOFER CONTROL BOARD STICKER	1	PZ	VE1585A0	BLUE LIGHT COVER GOLD SINUSOID	1	PZ	VM1019B0	MANUAL PROOVER PLASTIC CONTROL PANEL	1	PZ	VM2009A0	ELLIPTICAL SILVER SUPPORT D16	3	PZ
Code	Description	Qty	UOM																						
MS1018B0	MANUAL PROOFER CONTROL BOARD STICKER	1	PZ																						
VE1585A0	BLUE LIGHT COVER GOLD SINUSOID	1	PZ																						
VM1019B0	MANUAL PROOVER PLASTIC CONTROL PANEL	1	PZ																						
VM2009A0	ELLIPTICAL SILVER SUPPORT D16	3	PZ																						
VM1028A	MANUAL PROVER CONTROL BOARD TRAY		KVM1028A	MANUAL PROOFER CONTROL BOARD TRAY VM1028	<table border="1"> <thead> <tr> <th>Code</th> <th>Description</th> <th>Qty</th> <th>UOM</th> </tr> </thead> <tbody> <tr> <td>VM1028A0</td> <td>MANUAL PROVER CONTROL BOARD TRAY</td> <td>1</td> <td>PZ</td> </tr> </tbody> </table>	Code	Description	Qty	UOM	VM1028A0	MANUAL PROVER CONTROL BOARD TRAY	1	PZ												
Code	Description	Qty	UOM																						
VM1028A0	MANUAL PROVER CONTROL BOARD TRAY	1	PZ																						
MN1003A	PROVER THERMOSTAT 0-70°C KNOB		MN1003A0	PROVER THERMOSTAT 0-70°C KNOB																					

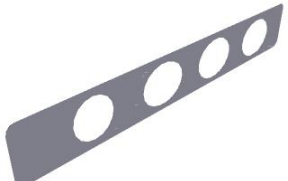
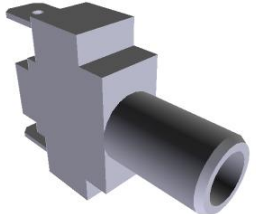

COMPONENT			SPARE PART																														
Code	Description	Image	Code	Description	Components list																												
MS1018B	MANUAL PROOFER CONTROL BOARD STICKER																																
VE1562A	UNIPOLAR NA PUSH BUTTON		KVE0107A	SILVER CLOUD LIGHT COVER KIT	<table border="1"> <thead> <tr> <th>Code</th> <th>Description</th> <th>Qty</th> <th>UOM</th> </tr> </thead> <tbody> <tr> <td>VE1170A0</td> <td>D16 OPAQUE NICKEL ELLIPTICAL SUPPORT</td> <td>1</td> <td>PZ</td> </tr> <tr> <td>VE1562A0</td> <td>UNIPOLAR NA PUSH BUTTO</td> <td>1</td> <td>PZ</td> </tr> <tr> <td>VM1761A0</td> <td>D16 BLACK ELLIPTICAL SUPPORT</td> <td>1</td> <td>PZ</td> </tr> <tr> <td>VM1775A0</td> <td>OPAQUE SILVER KEY WITH GOLD "CLOUD"</td> <td>1</td> <td>PZ</td> </tr> </tbody> </table>	Code	Description	Qty	UOM	VE1170A0	D16 OPAQUE NICKEL ELLIPTICAL SUPPORT	1	PZ	VE1562A0	UNIPOLAR NA PUSH BUTTO	1	PZ	VM1761A0	D16 BLACK ELLIPTICAL SUPPORT	1	PZ	VM1775A0	OPAQUE SILVER KEY WITH GOLD "CLOUD"	1	PZ								
Code	Description	Qty	UOM																														
VE1170A0	D16 OPAQUE NICKEL ELLIPTICAL SUPPORT	1	PZ																														
VE1562A0	UNIPOLAR NA PUSH BUTTO	1	PZ																														
VM1761A0	D16 BLACK ELLIPTICAL SUPPORT	1	PZ																														
VM1775A0	OPAQUE SILVER KEY WITH GOLD "CLOUD"	1	PZ																														
			KVE0106A	SILVER FLAME LIGHT COVER KIT	<table border="1"> <thead> <tr> <th>Code</th> <th>Description</th> <th>Qty</th> <th>UOM</th> </tr> </thead> <tbody> <tr> <td>VE1562A0</td> <td>UNIPOLAR NA PUSH BUTTO</td> <td>1</td> <td>PZ</td> </tr> <tr> <td>VM1761A0</td> <td>D16 BLACK ELLIPTICAL SUPPORT</td> <td>1</td> <td>PZ</td> </tr> <tr> <td>VM1774A0</td> <td>SILVER OPAQUE KEY W/ GOLD FLAME</td> <td>1</td> <td>PZ</td> </tr> </tbody> </table>	Code	Description	Qty	UOM	VE1562A0	UNIPOLAR NA PUSH BUTTO	1	PZ	VM1761A0	D16 BLACK ELLIPTICAL SUPPORT	1	PZ	VM1774A0	SILVER OPAQUE KEY W/ GOLD FLAME	1	PZ												
Code	Description	Qty	UOM																														
VE1562A0	UNIPOLAR NA PUSH BUTTO	1	PZ																														
VM1761A0	D16 BLACK ELLIPTICAL SUPPORT	1	PZ																														
VM1774A0	SILVER OPAQUE KEY W/ GOLD FLAME	1	PZ																														
			KVE0008A	XL PILOT BLUE LIGHTS KIT	<table border="1"> <thead> <tr> <th>Code</th> <th>Description</th> <th>Qty</th> <th>UOM</th> </tr> </thead> <tbody> <tr> <td>VE1530A0</td> <td>GOLD THERMOMETE R BLUE LIGHT COVER</td> <td>1</td> <td>PZ</td> </tr> <tr> <td>VE1535A1</td> <td>230V WHITE LED</td> <td>1</td> <td>PZ</td> </tr> <tr> <td>VE1561A0</td> <td>NA/NA BIPOLAR SWITCH</td> <td>1</td> <td>PZ</td> </tr> <tr> <td>VE1562A0</td> <td>UNIPOLAR NA PUSH BUTTO</td> <td>1</td> <td>PZ</td> </tr> <tr> <td>VM1761A0</td> <td>D16 BLACK ELLIPTICAL SUPPORT</td> <td>3</td> <td>PZ</td> </tr> <tr> <td>VM1762A0</td> <td>INNER LAMP SUPPORT</td> <td>1</td> <td>PZ</td> </tr> </tbody> </table>	Code	Description	Qty	UOM	VE1530A0	GOLD THERMOMETE R BLUE LIGHT COVER	1	PZ	VE1535A1	230V WHITE LED	1	PZ	VE1561A0	NA/NA BIPOLAR SWITCH	1	PZ	VE1562A0	UNIPOLAR NA PUSH BUTTO	1	PZ	VM1761A0	D16 BLACK ELLIPTICAL SUPPORT	3	PZ	VM1762A0	INNER LAMP SUPPORT	1	PZ
Code	Description	Qty	UOM																														
VE1530A0	GOLD THERMOMETE R BLUE LIGHT COVER	1	PZ																														
VE1535A1	230V WHITE LED	1	PZ																														
VE1561A0	NA/NA BIPOLAR SWITCH	1	PZ																														
VE1562A0	UNIPOLAR NA PUSH BUTTO	1	PZ																														
VM1761A0	D16 BLACK ELLIPTICAL SUPPORT	3	PZ																														
VM1762A0	INNER LAMP SUPPORT	1	PZ																														

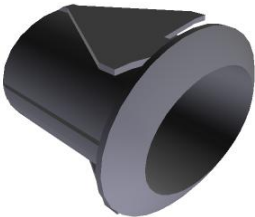

COMPONENT			SPARE PART																																															
Code	Description	Image	Code	Description	Components list																																													
VE1562A	UNIPOLAR NA PUSH BUTTON		KVE0008A	XL PILOT BLUE LIGHTS KIT	<table border="1"> <thead> <tr> <th>Code</th> <th>Description</th> <th>Qty</th> <th>UOM</th> </tr> </thead> <tbody> <tr> <td>VM1775A0</td> <td>OPAQUE SILVER KEY WITH GOLD "CLOUD"</td> <td>1</td> <td>PZ</td> </tr> <tr> <td>VM1776A0</td> <td>GOLD "0-1" MATT SILVER KEY</td> <td>1</td> <td>PZ</td> </tr> </tbody> </table>	Code	Description	Qty	UOM	VM1775A0	OPAQUE SILVER KEY WITH GOLD "CLOUD"	1	PZ	VM1776A0	GOLD "0-1" MATT SILVER KEY	1	PZ																																	
			Code	Description	Qty	UOM																																												
VM1775A0	OPAQUE SILVER KEY WITH GOLD "CLOUD"	1	PZ																																															
VM1776A0	GOLD "0-1" MATT SILVER KEY	1	PZ																																															
KVE0007A	XF-XG LED AND LED COVERS KIT	<table border="1"> <thead> <tr> <th>Code</th> <th>Description</th> <th>Qty</th> <th>UOM</th> </tr> </thead> <tbody> <tr> <td>VE1530A0</td> <td>GOLD THERMOMETE R BLUE LIGHT COVER</td> <td>1</td> <td>PZ</td> </tr> <tr> <td>VE1535A1</td> <td>230V WHITE LED</td> <td>1</td> <td>PZ</td> </tr> <tr> <td>VE1562A0</td> <td>UNIPOLAR NA PUSH BUTTO</td> <td>1</td> <td>PZ</td> </tr> <tr> <td>VE1585A0</td> <td>BLUE LIGHT COVER GOLD SINUSOID</td> <td>1</td> <td>PZ</td> </tr> <tr> <td>VM1761A0</td> <td>D16 BLACK ELLIPTICAL SUPPORT</td> <td>5</td> <td>PZ</td> </tr> <tr> <td>VM1762A0</td> <td>INNER LAMP SUPPORT</td> <td>4</td> <td>PZ</td> </tr> <tr> <td>VM1767A0</td> <td>GREEN PILOT LIGHT W/ GOLD FLAME</td> <td>1</td> <td>PZ</td> </tr> <tr> <td>VM1774A0</td> <td>SILVER OPAQUE KEY W/ GOLD FLAME</td> <td>1</td> <td>PZ</td> </tr> <tr> <td>VM1775A0</td> <td>OPAQUE SILVER KEY WITH GOLD "CLOUD"</td> <td>1</td> <td>PZ</td> </tr> <tr> <td>VM1902A0</td> <td>NEUTRAL GREEN PLASTIC COVER FOR</td> <td>1</td> <td>PZ</td> </tr> <tr> <td>VM1903A0</td> <td>GREEN PILOT WITH GOLD "CLOUD"</td> <td>1</td> <td>PZ</td> </tr> </tbody> </table>	Code	Description	Qty	UOM	VE1530A0	GOLD THERMOMETE R BLUE LIGHT COVER	1	PZ	VE1535A1	230V WHITE LED	1	PZ	VE1562A0	UNIPOLAR NA PUSH BUTTO	1	PZ	VE1585A0	BLUE LIGHT COVER GOLD SINUSOID	1	PZ	VM1761A0	D16 BLACK ELLIPTICAL SUPPORT	5	PZ	VM1762A0	INNER LAMP SUPPORT	4	PZ	VM1767A0	GREEN PILOT LIGHT W/ GOLD FLAME	1	PZ	VM1774A0	SILVER OPAQUE KEY W/ GOLD FLAME	1	PZ	VM1775A0	OPAQUE SILVER KEY WITH GOLD "CLOUD"	1	PZ	VM1902A0	NEUTRAL GREEN PLASTIC COVER FOR	1	PZ	VM1903A0	GREEN PILOT WITH GOLD "CLOUD"	1	PZ
Code	Description	Qty	UOM																																															
VE1530A0	GOLD THERMOMETE R BLUE LIGHT COVER	1	PZ																																															
VE1535A1	230V WHITE LED	1	PZ																																															
VE1562A0	UNIPOLAR NA PUSH BUTTO	1	PZ																																															
VE1585A0	BLUE LIGHT COVER GOLD SINUSOID	1	PZ																																															
VM1761A0	D16 BLACK ELLIPTICAL SUPPORT	5	PZ																																															
VM1762A0	INNER LAMP SUPPORT	4	PZ																																															
VM1767A0	GREEN PILOT LIGHT W/ GOLD FLAME	1	PZ																																															
VM1774A0	SILVER OPAQUE KEY W/ GOLD FLAME	1	PZ																																															
VM1775A0	OPAQUE SILVER KEY WITH GOLD "CLOUD"	1	PZ																																															
VM1902A0	NEUTRAL GREEN PLASTIC COVER FOR	1	PZ																																															
VM1903A0	GREEN PILOT WITH GOLD "CLOUD"	1	PZ																																															
VM1775A	OPAQUE SILVER KEY WITH GOLD "CLOUD"		KVE0107A	SILVER CLOUD LIGHT COVER KIT	<table border="1"> <thead> <tr> <th>Code</th> <th>Description</th> <th>Qty</th> <th>UOM</th> </tr> </thead> <tbody> <tr> <td>VE1170A0</td> <td>D16 OPAQUE NICKEL ELLIPTICAL SUPPORT</td> <td>1</td> <td>PZ</td> </tr> <tr> <td>VE1562A0</td> <td>UNIPOLAR NA PUSH BUTTO</td> <td>1</td> <td>PZ</td> </tr> <tr> <td>VM1761A0</td> <td>D16 BLACK ELLIPTICAL SUPPORT</td> <td>1</td> <td>PZ</td> </tr> <tr> <td>VM1775A0</td> <td>OPAQUE SILVER KEY WITH GOLD "CLOUD"</td> <td>1</td> <td>PZ</td> </tr> </tbody> </table>	Code	Description	Qty	UOM	VE1170A0	D16 OPAQUE NICKEL ELLIPTICAL SUPPORT	1	PZ	VE1562A0	UNIPOLAR NA PUSH BUTTO	1	PZ	VM1761A0	D16 BLACK ELLIPTICAL SUPPORT	1	PZ	VM1775A0	OPAQUE SILVER KEY WITH GOLD "CLOUD"	1	PZ																									
Code	Description	Qty	UOM																																															
VE1170A0	D16 OPAQUE NICKEL ELLIPTICAL SUPPORT	1	PZ																																															
VE1562A0	UNIPOLAR NA PUSH BUTTO	1	PZ																																															
VM1761A0	D16 BLACK ELLIPTICAL SUPPORT	1	PZ																																															
VM1775A0	OPAQUE SILVER KEY WITH GOLD "CLOUD"	1	PZ																																															

COMPONENT			SPARE PART																																																														
Code	Description	Image	Code	Description	Components list																																																												
VM2009A	ELLIPTICAL SILVER SUPPORT D16		KVM2009A	D16 SILVER ELLIPTICAL SUPPORT KIT	<table border="1"> <thead> <tr> <th>Code</th> <th>Description</th> <th>Qty</th> <th>UOM</th> </tr> </thead> <tbody> <tr> <td>VM2009A0</td> <td>ELLIPTICAL SILVER SUPPORT D16</td> <td>1</td> <td>PZ</td> </tr> </tbody> </table>	Code	Description	Qty	UOM	VM2009A0	ELLIPTICAL SILVER SUPPORT D16	1	PZ																																																				
Code	Description	Qty	UOM																																																														
VM2009A0	ELLIPTICAL SILVER SUPPORT D16	1	PZ																																																														
VM1762A	INNER LAMP SUPPORT		KVM1762A	LAMP INTERNAL SUPPORT KIT	<table border="1"> <thead> <tr> <th>Code</th> <th>Description</th> <th>Qty</th> <th>UOM</th> </tr> </thead> <tbody> <tr> <td>VM1762A0</td> <td>INNER LAMP SUPPORT</td> <td>1</td> <td>PZ</td> </tr> </tbody> </table>	Code	Description	Qty	UOM	VM1762A0	INNER LAMP SUPPORT	1	PZ																																																				
Code	Description	Qty	UOM																																																														
VM1762A0	INNER LAMP SUPPORT	1	PZ																																																														
VE1535A	230V WHITE LED		<p>KVE1535A</p> <p>KVE0105A</p> <p>KVE0104A</p> <p>KVE0102A</p>	<p>LED LIGHT 1 PC. KIT</p> <p>CLOUD LED LIGHT+COVER+SUPPORT KIT</p> <p>NEUTRAL GREEN LIGHT KIT</p> <p>GOLDEN FLAME LIGHT COVER KIT</p>	<table border="1"> <thead> <tr> <th>Code</th> <th>Description</th> <th>Qty</th> <th>UOM</th> </tr> </thead> <tbody> <tr> <td>VE1535A1</td> <td>230V WHITE LED</td> <td>10</td> <td>PZ</td> </tr> </tbody> </table> <table border="1"> <thead> <tr> <th>Code</th> <th>Description</th> <th>Qty</th> <th>UOM</th> </tr> </thead> <tbody> <tr> <td>VE1535A1</td> <td>230V WHITE LED</td> <td>1</td> <td>PZ</td> </tr> <tr> <td>VM1761A0</td> <td>D16 BLACK ELLIPTICAL SUPPORT</td> <td>1</td> <td>PZ</td> </tr> <tr> <td>VM1762A0</td> <td>INNER LAMP SUPPORT</td> <td>1</td> <td>PZ</td> </tr> <tr> <td>VM1903A0</td> <td>GREEN PILOT WITH GOLD "CLOUD"</td> <td>1</td> <td>PZ</td> </tr> </tbody> </table> <table border="1"> <thead> <tr> <th>Code</th> <th>Description</th> <th>Qty</th> <th>UOM</th> </tr> </thead> <tbody> <tr> <td>VE1535A1</td> <td>230V WHITE LED</td> <td>1</td> <td>PZ</td> </tr> <tr> <td>VM1761A0</td> <td>D16 BLACK ELLIPTICAL SUPPORT</td> <td>1</td> <td>PZ</td> </tr> <tr> <td>VM1762A0</td> <td>INNER LAMP SUPPORT</td> <td>1</td> <td>PZ</td> </tr> <tr> <td>VM1902A0</td> <td>NEUTRAL GREEN PLASTIC COVER FOR</td> <td>1</td> <td>PZ</td> </tr> </tbody> </table> <table border="1"> <thead> <tr> <th>Code</th> <th>Description</th> <th>Qty</th> <th>UOM</th> </tr> </thead> <tbody> <tr> <td>VE1535A1</td> <td>230V WHITE LED</td> <td>1</td> <td>PZ</td> </tr> <tr> <td>VM1761A0</td> <td>D16 BLACK ELLIPTICAL SUPPORT</td> <td>1</td> <td>PZ</td> </tr> </tbody> </table>	Code	Description	Qty	UOM	VE1535A1	230V WHITE LED	10	PZ	Code	Description	Qty	UOM	VE1535A1	230V WHITE LED	1	PZ	VM1761A0	D16 BLACK ELLIPTICAL SUPPORT	1	PZ	VM1762A0	INNER LAMP SUPPORT	1	PZ	VM1903A0	GREEN PILOT WITH GOLD "CLOUD"	1	PZ	Code	Description	Qty	UOM	VE1535A1	230V WHITE LED	1	PZ	VM1761A0	D16 BLACK ELLIPTICAL SUPPORT	1	PZ	VM1762A0	INNER LAMP SUPPORT	1	PZ	VM1902A0	NEUTRAL GREEN PLASTIC COVER FOR	1	PZ	Code	Description	Qty	UOM	VE1535A1	230V WHITE LED	1	PZ	VM1761A0	D16 BLACK ELLIPTICAL SUPPORT	1	PZ
Code	Description	Qty	UOM																																																														
VE1535A1	230V WHITE LED	10	PZ																																																														
Code	Description	Qty	UOM																																																														
VE1535A1	230V WHITE LED	1	PZ																																																														
VM1761A0	D16 BLACK ELLIPTICAL SUPPORT	1	PZ																																																														
VM1762A0	INNER LAMP SUPPORT	1	PZ																																																														
VM1903A0	GREEN PILOT WITH GOLD "CLOUD"	1	PZ																																																														
Code	Description	Qty	UOM																																																														
VE1535A1	230V WHITE LED	1	PZ																																																														
VM1761A0	D16 BLACK ELLIPTICAL SUPPORT	1	PZ																																																														
VM1762A0	INNER LAMP SUPPORT	1	PZ																																																														
VM1902A0	NEUTRAL GREEN PLASTIC COVER FOR	1	PZ																																																														
Code	Description	Qty	UOM																																																														
VE1535A1	230V WHITE LED	1	PZ																																																														
VM1761A0	D16 BLACK ELLIPTICAL SUPPORT	1	PZ																																																														



COMPONENT			SPARE PART																																			
Code	Description	Image	Code	Description	Components list																																	
VE1535A	230V WHITE LED		KVE0102A	GOLDEN FLAME LIGHT COVER KIT	<table border="1"> <thead> <tr> <th>Code</th> <th>Description</th> <th>Qty</th> <th>UOM</th> </tr> </thead> <tbody> <tr> <td>VM1782A0</td> <td>INNER LAMP SUPPORT</td> <td>1</td> <td>PZ</td> </tr> <tr> <td>VM1767A0</td> <td>GREEN PILOT LIGHT W/ GOLD FLAME</td> <td>1</td> <td>PZ</td> </tr> </tbody> </table>	Code	Description	Qty	UOM	VM1782A0	INNER LAMP SUPPORT	1	PZ	VM1767A0	GREEN PILOT LIGHT W/ GOLD FLAME	1	PZ																					
			Code	Description	Qty	UOM																																
			VM1782A0	INNER LAMP SUPPORT	1	PZ																																
VM1767A0	GREEN PILOT LIGHT W/ GOLD FLAME	1	PZ																																			
KVE0101A	SINUSOID LIGHT GREEN COVER KIT	<table border="1"> <thead> <tr> <th>Code</th> <th>Description</th> <th>Qty</th> <th>UOM</th> </tr> </thead> <tbody> <tr> <td>VE1535A1</td> <td>230V WHITE LED</td> <td>1</td> <td>PZ</td> </tr> <tr> <td>VM1761A0</td> <td>D16 BLACK ELLIPTICAL SUPPORT</td> <td>1</td> <td>PZ</td> </tr> <tr> <td>VM1782A0</td> <td>INNER LAMP SUPPORT</td> <td>1</td> <td>PZ</td> </tr> <tr> <td>VM1765A0</td> <td>GREEN PILOT WITH GOLD SINUSOIDE</td> <td>1</td> <td>PZ</td> </tr> </tbody> </table>	Code	Description	Qty	UOM	VE1535A1	230V WHITE LED	1	PZ	VM1761A0	D16 BLACK ELLIPTICAL SUPPORT	1	PZ	VM1782A0	INNER LAMP SUPPORT	1	PZ	VM1765A0	GREEN PILOT WITH GOLD SINUSOIDE	1	PZ																
Code	Description	Qty	UOM																																			
VE1535A1	230V WHITE LED	1	PZ																																			
VM1761A0	D16 BLACK ELLIPTICAL SUPPORT	1	PZ																																			
VM1782A0	INNER LAMP SUPPORT	1	PZ																																			
VM1765A0	GREEN PILOT WITH GOLD SINUSOIDE	1	PZ																																			
KVE0100A	THERMOMETER LIGHT COVER KIT	<table border="1"> <thead> <tr> <th>Code</th> <th>Description</th> <th>Qty</th> <th>UOM</th> </tr> </thead> <tbody> <tr> <td>VE1530A0</td> <td>GOLD THERMOMETE R BLUE LIGHT COVER</td> <td>1</td> <td>PZ</td> </tr> <tr> <td>VE1535A1</td> <td>230V WHITE LED</td> <td>1</td> <td>PZ</td> </tr> <tr> <td>VM1761A0</td> <td>D16 BLACK ELLIPTICAL SUPPORT</td> <td>1</td> <td>PZ</td> </tr> <tr> <td>VM1782A0</td> <td>INNER LAMP SUPPORT</td> <td>1</td> <td>PZ</td> </tr> </tbody> </table>	Code	Description	Qty	UOM	VE1530A0	GOLD THERMOMETE R BLUE LIGHT COVER	1	PZ	VE1535A1	230V WHITE LED	1	PZ	VM1761A0	D16 BLACK ELLIPTICAL SUPPORT	1	PZ	VM1782A0	INNER LAMP SUPPORT	1	PZ																
Code	Description	Qty	UOM																																			
VE1530A0	GOLD THERMOMETE R BLUE LIGHT COVER	1	PZ																																			
VE1535A1	230V WHITE LED	1	PZ																																			
VM1761A0	D16 BLACK ELLIPTICAL SUPPORT	1	PZ																																			
VM1782A0	INNER LAMP SUPPORT	1	PZ																																			
KVE0011A	XP KNOBS AND LIGHTS KIT	<table border="1"> <thead> <tr> <th>Code</th> <th>Description</th> <th>Qty</th> <th>UOM</th> </tr> </thead> <tbody> <tr> <td>MN1105A0</td> <td>120-400C XP THERMOSTAT KNOB</td> <td>1</td> <td>PZ</td> </tr> <tr> <td>MN1110A0</td> <td>XP NEUTRAL INDEX DIAL</td> <td>1</td> <td>PZ</td> </tr> <tr> <td>VE1530A0</td> <td>GOLD THERMOMETE R BLUE LIGHT COVER</td> <td>1</td> <td>PZ</td> </tr> <tr> <td>VE1535A1</td> <td>230V WHITE LED</td> <td>1</td> <td>PZ</td> </tr> <tr> <td>VE1561A0</td> <td>NA/NA BIPOLAR SWITCH</td> <td>1</td> <td>PZ</td> </tr> <tr> <td>VM1761A0</td> <td>D16 BLACK ELLIPTICAL SUPPORT</td> <td>2</td> <td>PZ</td> </tr> <tr> <td>VM1782A0</td> <td>INNER LAMP SUPPORT</td> <td>1</td> <td>PZ</td> </tr> <tr> <td>VM1776A0</td> <td>GOLD "0-1" MATT SILVER KEY</td> <td>1</td> <td>PZ</td> </tr> </tbody> </table>	Code	Description	Qty	UOM	MN1105A0	120-400C XP THERMOSTAT KNOB	1	PZ	MN1110A0	XP NEUTRAL INDEX DIAL	1	PZ	VE1530A0	GOLD THERMOMETE R BLUE LIGHT COVER	1	PZ	VE1535A1	230V WHITE LED	1	PZ	VE1561A0	NA/NA BIPOLAR SWITCH	1	PZ	VM1761A0	D16 BLACK ELLIPTICAL SUPPORT	2	PZ	VM1782A0	INNER LAMP SUPPORT	1	PZ	VM1776A0	GOLD "0-1" MATT SILVER KEY	1	PZ
Code	Description	Qty	UOM																																			
MN1105A0	120-400C XP THERMOSTAT KNOB	1	PZ																																			
MN1110A0	XP NEUTRAL INDEX DIAL	1	PZ																																			
VE1530A0	GOLD THERMOMETE R BLUE LIGHT COVER	1	PZ																																			
VE1535A1	230V WHITE LED	1	PZ																																			
VE1561A0	NA/NA BIPOLAR SWITCH	1	PZ																																			
VM1761A0	D16 BLACK ELLIPTICAL SUPPORT	2	PZ																																			
VM1782A0	INNER LAMP SUPPORT	1	PZ																																			
VM1776A0	GOLD "0-1" MATT SILVER KEY	1	PZ																																			





COMPONENT			SPARE PART																																															
Code	Description	Image	Code	Description	Components list																																													
VE1535A	230V WHITE LED		KVE0008A	XL PILOT BLUE LIGHTS KIT	<table border="1"> <thead> <tr> <th>Code</th> <th>Description</th> <th>Qty</th> <th>UOM</th> </tr> </thead> <tbody> <tr> <td>VE1530A0</td> <td>GOLD THERMOMETE R BLUE LIGHT COVER</td> <td>1</td> <td>PZ</td> </tr> <tr> <td>VE1535A1</td> <td>230V WHITE LED</td> <td>1</td> <td>PZ</td> </tr> <tr> <td>VE1561A0</td> <td>NA/NA BIPOLAR SWITCH</td> <td>1</td> <td>PZ</td> </tr> <tr> <td>VE1562A0</td> <td>UNIPOLAR NA PUSH BUTTO</td> <td>1</td> <td>PZ</td> </tr> <tr> <td>VM1761A0</td> <td>D16 BLACK ELLIPTICAL SUPPORT</td> <td>3</td> <td>PZ</td> </tr> <tr> <td>VM1762A0</td> <td>INNER LAMP SUPPORT</td> <td>1</td> <td>PZ</td> </tr> <tr> <td>VM1775A0</td> <td>OPAQUE SILVER KEY WITH GOLD "CLOUD"</td> <td>1</td> <td>PZ</td> </tr> <tr> <td>VM1776A0</td> <td>GOLD "0-1" MATT SILVER KEY</td> <td>1</td> <td>PZ</td> </tr> </tbody> </table>	Code	Description	Qty	UOM	VE1530A0	GOLD THERMOMETE R BLUE LIGHT COVER	1	PZ	VE1535A1	230V WHITE LED	1	PZ	VE1561A0	NA/NA BIPOLAR SWITCH	1	PZ	VE1562A0	UNIPOLAR NA PUSH BUTTO	1	PZ	VM1761A0	D16 BLACK ELLIPTICAL SUPPORT	3	PZ	VM1762A0	INNER LAMP SUPPORT	1	PZ	VM1775A0	OPAQUE SILVER KEY WITH GOLD "CLOUD"	1	PZ	VM1776A0	GOLD "0-1" MATT SILVER KEY	1	PZ									
			Code	Description	Qty	UOM																																												
VE1530A0	GOLD THERMOMETE R BLUE LIGHT COVER	1	PZ																																															
VE1535A1	230V WHITE LED	1	PZ																																															
VE1561A0	NA/NA BIPOLAR SWITCH	1	PZ																																															
VE1562A0	UNIPOLAR NA PUSH BUTTO	1	PZ																																															
VM1761A0	D16 BLACK ELLIPTICAL SUPPORT	3	PZ																																															
VM1762A0	INNER LAMP SUPPORT	1	PZ																																															
VM1775A0	OPAQUE SILVER KEY WITH GOLD "CLOUD"	1	PZ																																															
VM1776A0	GOLD "0-1" MATT SILVER KEY	1	PZ																																															
KVE0007A	XF-XG LED AND LED COVERS KIT	<table border="1"> <thead> <tr> <th>Code</th> <th>Description</th> <th>Qty</th> <th>UOM</th> </tr> </thead> <tbody> <tr> <td>VE1530A0</td> <td>GOLD THERMOMETE R BLUE LIGHT COVER</td> <td>1</td> <td>PZ</td> </tr> <tr> <td>VE1535A1</td> <td>230V WHITE LED</td> <td>1</td> <td>PZ</td> </tr> <tr> <td>VE1562A0</td> <td>UNIPOLAR NA PUSH BUTTO</td> <td>1</td> <td>PZ</td> </tr> <tr> <td>VE1585A0</td> <td>BLUE LIGHT COVER GOLD SINUSOID</td> <td>1</td> <td>PZ</td> </tr> <tr> <td>VM1761A0</td> <td>D16 BLACK ELLIPTICAL SUPPORT</td> <td>5</td> <td>PZ</td> </tr> <tr> <td>VM1762A0</td> <td>INNER LAMP SUPPORT</td> <td>4</td> <td>PZ</td> </tr> <tr> <td>VM1767A0</td> <td>GREEN PILOT LIGHT W/ GOLD FLAME</td> <td>1</td> <td>PZ</td> </tr> <tr> <td>VM1774A0</td> <td>SILVER OPAQUE KEY W/ GOLD FLAME</td> <td>1</td> <td>PZ</td> </tr> <tr> <td>VM1775A0</td> <td>OPAQUE SILVER KEY WITH GOLD "CLOUD"</td> <td>1</td> <td>PZ</td> </tr> <tr> <td>VM1902A0</td> <td>NEUTRAL GREEN PLASTIC COVER FOR</td> <td>1</td> <td>PZ</td> </tr> <tr> <td>VM1903A0</td> <td>GREEN PILOT LIGHT WITH GOLD "CLOUD"</td> <td>1</td> <td>PZ</td> </tr> </tbody> </table>	Code	Description	Qty	UOM	VE1530A0	GOLD THERMOMETE R BLUE LIGHT COVER	1	PZ	VE1535A1	230V WHITE LED	1	PZ	VE1562A0	UNIPOLAR NA PUSH BUTTO	1	PZ	VE1585A0	BLUE LIGHT COVER GOLD SINUSOID	1	PZ	VM1761A0	D16 BLACK ELLIPTICAL SUPPORT	5	PZ	VM1762A0	INNER LAMP SUPPORT	4	PZ	VM1767A0	GREEN PILOT LIGHT W/ GOLD FLAME	1	PZ	VM1774A0	SILVER OPAQUE KEY W/ GOLD FLAME	1	PZ	VM1775A0	OPAQUE SILVER KEY WITH GOLD "CLOUD"	1	PZ	VM1902A0	NEUTRAL GREEN PLASTIC COVER FOR	1	PZ	VM1903A0	GREEN PILOT LIGHT WITH GOLD "CLOUD"	1	PZ
Code	Description	Qty	UOM																																															
VE1530A0	GOLD THERMOMETE R BLUE LIGHT COVER	1	PZ																																															
VE1535A1	230V WHITE LED	1	PZ																																															
VE1562A0	UNIPOLAR NA PUSH BUTTO	1	PZ																																															
VE1585A0	BLUE LIGHT COVER GOLD SINUSOID	1	PZ																																															
VM1761A0	D16 BLACK ELLIPTICAL SUPPORT	5	PZ																																															
VM1762A0	INNER LAMP SUPPORT	4	PZ																																															
VM1767A0	GREEN PILOT LIGHT W/ GOLD FLAME	1	PZ																																															
VM1774A0	SILVER OPAQUE KEY W/ GOLD FLAME	1	PZ																																															
VM1775A0	OPAQUE SILVER KEY WITH GOLD "CLOUD"	1	PZ																																															
VM1902A0	NEUTRAL GREEN PLASTIC COVER FOR	1	PZ																																															
VM1903A0	GREEN PILOT LIGHT WITH GOLD "CLOUD"	1	PZ																																															

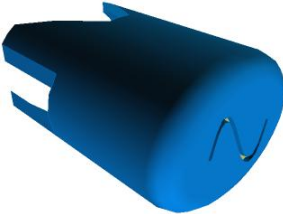

COMPONENT			SPARE PART																										
Code	Description	Image	Code	Description	Components list																								
VE1535A	230V WHITE LED		KLP1014A	SINUSOID LED LIGHT+COVER+SUPPORT KIT	<table border="1"> <thead> <tr> <th>Code</th> <th>Description</th> <th>Qty</th> <th>UOM</th> </tr> </thead> <tbody> <tr> <td>VE1170A0</td> <td>D16 OPAQUE NICKEL ELLIPTICAL SUPPORT</td> <td>2</td> <td>PZ</td> </tr> <tr> <td>VE1535A1</td> <td>230V WHITE LED</td> <td>2</td> <td>PZ</td> </tr> <tr> <td>VE1585A0</td> <td>BLUE LIGHT COVER GOLD SINUSOID</td> <td>2</td> <td>PZ</td> </tr> <tr> <td>VM1782A0</td> <td>INNER LAMP SUPPORT</td> <td>2</td> <td>PZ</td> </tr> <tr> <td>VM2009A0</td> <td>ELLIPTICAL SILVER SUPPORT D16</td> <td>1</td> <td>PZ</td> </tr> </tbody> </table>	Code	Description	Qty	UOM	VE1170A0	D16 OPAQUE NICKEL ELLIPTICAL SUPPORT	2	PZ	VE1535A1	230V WHITE LED	2	PZ	VE1585A0	BLUE LIGHT COVER GOLD SINUSOID	2	PZ	VM1782A0	INNER LAMP SUPPORT	2	PZ	VM2009A0	ELLIPTICAL SILVER SUPPORT D16	1	PZ
			Code	Description	Qty	UOM																							
			VE1170A0	D16 OPAQUE NICKEL ELLIPTICAL SUPPORT	2	PZ																							
VE1535A1	230V WHITE LED	2	PZ																										
VE1585A0	BLUE LIGHT COVER GOLD SINUSOID	2	PZ																										
VM1782A0	INNER LAMP SUPPORT	2	PZ																										
VM2009A0	ELLIPTICAL SILVER SUPPORT D16	1	PZ																										
KLP1012A	BLUE LIGHT THERMOMETER KIT	<table border="1"> <thead> <tr> <th>Code</th> <th>Description</th> <th>Qty</th> <th>UOM</th> </tr> </thead> <tbody> <tr> <td>VE1170A0</td> <td>D16 OPAQUE NICKEL ELLIPTICAL SUPPORT</td> <td>2</td> <td>PZ</td> </tr> <tr> <td>VE1530A0</td> <td>GOLD THERMOMETE R BLUE LIGHT COVER</td> <td>2</td> <td>PZ</td> </tr> <tr> <td>VE1535A1</td> <td>230V WHITE LED</td> <td>2</td> <td>PZ</td> </tr> <tr> <td>VM1782A0</td> <td>INNER LAMP SUPPORT</td> <td>2</td> <td>PZ</td> </tr> </tbody> </table>	Code	Description	Qty	UOM	VE1170A0	D16 OPAQUE NICKEL ELLIPTICAL SUPPORT	2	PZ	VE1530A0	GOLD THERMOMETE R BLUE LIGHT COVER	2	PZ	VE1535A1	230V WHITE LED	2	PZ	VM1782A0	INNER LAMP SUPPORT	2	PZ							
Code	Description	Qty	UOM																										
VE1170A0	D16 OPAQUE NICKEL ELLIPTICAL SUPPORT	2	PZ																										
VE1530A0	GOLD THERMOMETE R BLUE LIGHT COVER	2	PZ																										
VE1535A1	230V WHITE LED	2	PZ																										
VM1782A0	INNER LAMP SUPPORT	2	PZ																										
KLP1010A	THERMOSTAT GREEN LIGHT KIT	<table border="1"> <thead> <tr> <th>Code</th> <th>Description</th> <th>Qty</th> <th>UOM</th> </tr> </thead> <tbody> <tr> <td>VE1170A0</td> <td>D16 OPAQUE NICKEL ELLIPTICAL SUPPORT</td> <td>1</td> <td>PZ</td> </tr> <tr> <td>VE1535A1</td> <td>230V WHITE LED</td> <td>1</td> <td>PZ</td> </tr> <tr> <td>VM1782A0</td> <td>INNER LAMP SUPPORT</td> <td>1</td> <td>PZ</td> </tr> <tr> <td>VM1784A0</td> <td>GREEN PILOT WITH GOLD THERMOMETE</td> <td>1</td> <td>PZ</td> </tr> </tbody> </table>	Code	Description	Qty	UOM	VE1170A0	D16 OPAQUE NICKEL ELLIPTICAL SUPPORT	1	PZ	VE1535A1	230V WHITE LED	1	PZ	VM1782A0	INNER LAMP SUPPORT	1	PZ	VM1784A0	GREEN PILOT WITH GOLD THERMOMETE	1	PZ							
Code	Description	Qty	UOM																										
VE1170A0	D16 OPAQUE NICKEL ELLIPTICAL SUPPORT	1	PZ																										
VE1535A1	230V WHITE LED	1	PZ																										
VM1782A0	INNER LAMP SUPPORT	1	PZ																										
VM1784A0	GREEN PILOT WITH GOLD THERMOMETE	1	PZ																										
VE1585A	BLUE LIGHT COVER GOLD SINUSOID		KLP1014A	SINUSOID LED LIGHT+COVER+SUPPORT KIT	<table border="1"> <thead> <tr> <th>Code</th> <th>Description</th> <th>Qty</th> <th>UOM</th> </tr> </thead> <tbody> <tr> <td>VE1170A0</td> <td>D16 OPAQUE NICKEL ELLIPTICAL SUPPORT</td> <td>2</td> <td>PZ</td> </tr> <tr> <td>VE1535A1</td> <td>230V WHITE LED</td> <td>2</td> <td>PZ</td> </tr> <tr> <td>VE1585A0</td> <td>BLUE LIGHT COVER GOLD SINUSOID</td> <td>2</td> <td>PZ</td> </tr> <tr> <td>VM1782A0</td> <td>INNER LAMP SUPPORT</td> <td>2</td> <td>PZ</td> </tr> <tr> <td>VM2009A0</td> <td>ELLIPTICAL SILVER SUPPORT D16</td> <td>1</td> <td>PZ</td> </tr> </tbody> </table>	Code	Description	Qty	UOM	VE1170A0	D16 OPAQUE NICKEL ELLIPTICAL SUPPORT	2	PZ	VE1535A1	230V WHITE LED	2	PZ	VE1585A0	BLUE LIGHT COVER GOLD SINUSOID	2	PZ	VM1782A0	INNER LAMP SUPPORT	2	PZ	VM2009A0	ELLIPTICAL SILVER SUPPORT D16	1	PZ
			Code	Description	Qty	UOM																							
			VE1170A0	D16 OPAQUE NICKEL ELLIPTICAL SUPPORT	2	PZ																							
			VE1535A1	230V WHITE LED	2	PZ																							
			VE1585A0	BLUE LIGHT COVER GOLD SINUSOID	2	PZ																							
VM1782A0	INNER LAMP SUPPORT	2	PZ																										
VM2009A0	ELLIPTICAL SILVER SUPPORT D16	1	PZ																										

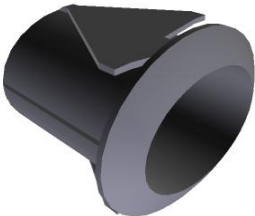

COMPONENT			SPARE PART																						
Code	Description	Image	Code	Description	Components list																				
VM2009A	ELLIPTICAL SILVER SUPPORT D16		KVM2009A	D16 SILVER ELLIPTICAL SUPPORT KIT	<table border="1"> <thead> <tr> <th>Code</th> <th>Description</th> <th>Qty</th> <th>UOM</th> </tr> </thead> <tbody> <tr> <td>VM2009A0</td> <td>ELLIPTICAL SILVER SUPPORT D16</td> <td>1</td> <td>PZ</td> </tr> </tbody> </table>	Code	Description	Qty	UOM	VM2009A0	ELLIPTICAL SILVER SUPPORT D16	1	PZ												
Code	Description	Qty	UOM																						
VM2009A0	ELLIPTICAL SILVER SUPPORT D16	1	PZ																						
VM2009A	ELLIPTICAL SILVER SUPPORT D16		KVM2009A	D16 SILVER ELLIPTICAL SUPPORT KIT	<table border="1"> <thead> <tr> <th>Code</th> <th>Description</th> <th>Qty</th> <th>UOM</th> </tr> </thead> <tbody> <tr> <td>VM2009A0</td> <td>ELLIPTICAL SILVER SUPPORT D16</td> <td>1</td> <td>PZ</td> </tr> </tbody> </table>	Code	Description	Qty	UOM	VM2009A0	ELLIPTICAL SILVER SUPPORT D16	1	PZ												
Code	Description	Qty	UOM																						
VM2009A0	ELLIPTICAL SILVER SUPPORT D16	1	PZ																						
VM1776A	GOLD "0-1" MATT SILVER KEY		KVE0108A	XP ON-OFF SWITCH KIT	<table border="1"> <thead> <tr> <th>Code</th> <th>Description</th> <th>Qty</th> <th>UOM</th> </tr> </thead> <tbody> <tr> <td>VE1170A0</td> <td>D16 OPAQUE NICKEL ELLIPTICAL SUPPORT</td> <td>1</td> <td>PZ</td> </tr> <tr> <td>VE1561A0</td> <td>NA/NA BIPOLAR SWITCH</td> <td>1</td> <td>PZ</td> </tr> <tr> <td>VM1761A0</td> <td>D16 BLACK ELLIPTICAL SUPPORT</td> <td>1</td> <td>PZ</td> </tr> <tr> <td>VM1776A0</td> <td>GOLD "0-1" MATT SILVER KEY</td> <td>1</td> <td>PZ</td> </tr> </tbody> </table>	Code	Description	Qty	UOM	VE1170A0	D16 OPAQUE NICKEL ELLIPTICAL SUPPORT	1	PZ	VE1561A0	NA/NA BIPOLAR SWITCH	1	PZ	VM1761A0	D16 BLACK ELLIPTICAL SUPPORT	1	PZ	VM1776A0	GOLD "0-1" MATT SILVER KEY	1	PZ
Code	Description	Qty	UOM																						
VE1170A0	D16 OPAQUE NICKEL ELLIPTICAL SUPPORT	1	PZ																						
VE1561A0	NA/NA BIPOLAR SWITCH	1	PZ																						
VM1761A0	D16 BLACK ELLIPTICAL SUPPORT	1	PZ																						
VM1776A0	GOLD "0-1" MATT SILVER KEY	1	PZ																						
VE1561A	NA/NA BIPOLAR SWITCH		KVE0108A	XP ON-OFF SWITCH KIT	<table border="1"> <thead> <tr> <th>Code</th> <th>Description</th> <th>Qty</th> <th>UOM</th> </tr> </thead> <tbody> <tr> <td>VE1170A0</td> <td>D16 OPAQUE NICKEL ELLIPTICAL SUPPORT</td> <td>1</td> <td>PZ</td> </tr> <tr> <td>VE1561A0</td> <td>NA/NA BIPOLAR SWITCH</td> <td>1</td> <td>PZ</td> </tr> <tr> <td>VM1761A0</td> <td>D16 BLACK ELLIPTICAL SUPPORT</td> <td>1</td> <td>PZ</td> </tr> <tr> <td>VM1776A0</td> <td>GOLD "0-1" MATT SILVER KEY</td> <td>1</td> <td>PZ</td> </tr> </tbody> </table>	Code	Description	Qty	UOM	VE1170A0	D16 OPAQUE NICKEL ELLIPTICAL SUPPORT	1	PZ	VE1561A0	NA/NA BIPOLAR SWITCH	1	PZ	VM1761A0	D16 BLACK ELLIPTICAL SUPPORT	1	PZ	VM1776A0	GOLD "0-1" MATT SILVER KEY	1	PZ
Code	Description	Qty	UOM																						
VE1170A0	D16 OPAQUE NICKEL ELLIPTICAL SUPPORT	1	PZ																						
VE1561A0	NA/NA BIPOLAR SWITCH	1	PZ																						
VM1761A0	D16 BLACK ELLIPTICAL SUPPORT	1	PZ																						
VM1776A0	GOLD "0-1" MATT SILVER KEY	1	PZ																						

ASM1312A/0.D02 - General overview



FRONT

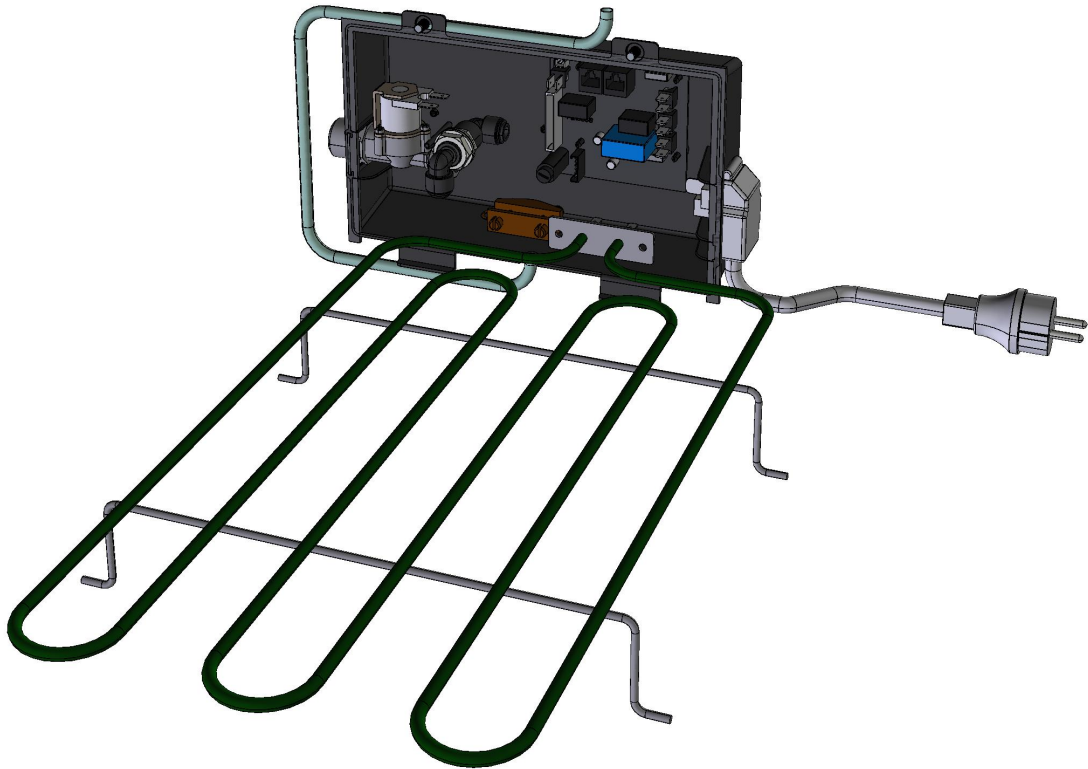



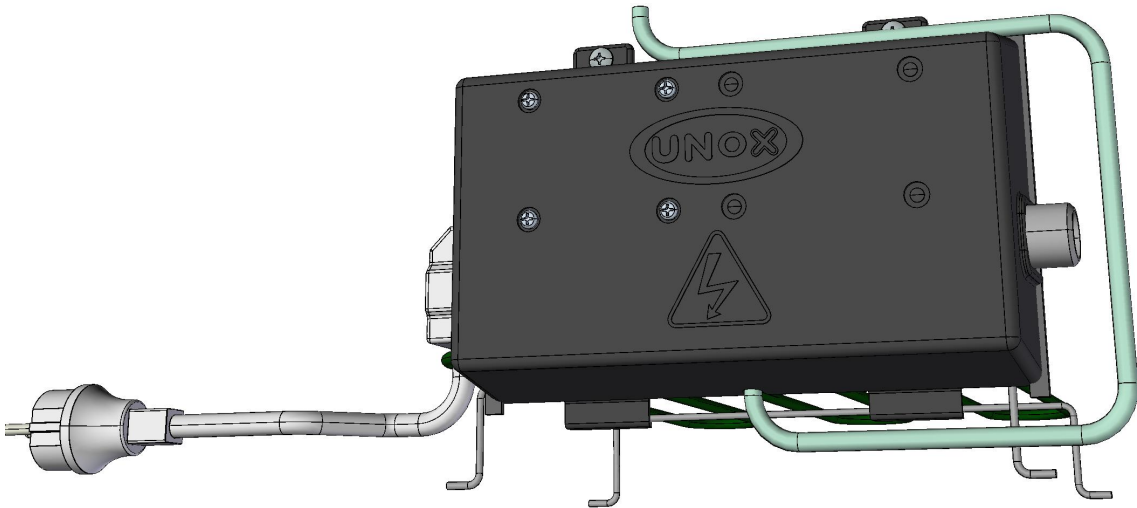

ASM1312A/0.D02 - General overview

REAR

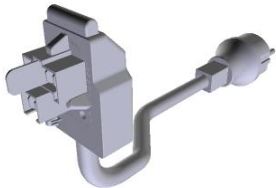
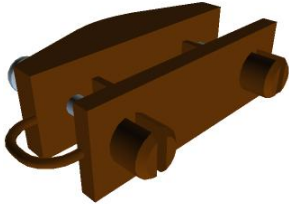
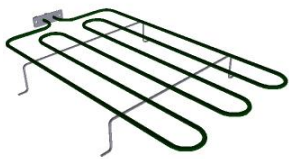

COMPONENT			SPARE PART																																		
Code	Description	Image	Code	Description	Components list																																
MR1000A	CABLE 3X1,5 H07RN-F MT1,5+K2/3+SCHUK		KMR1000A	KIT CABLE 3X1,5 H07RN-F +K2/3+SCHUKO	<table border="1"> <thead> <tr> <th>Code</th> <th>Description</th> <th>Qty</th> <th>UOM</th> </tr> </thead> <tbody> <tr> <td>MR1000A0</td> <td>CABLE 3X1,5 H07RN-F MT1,5+K2/3+S CHUKO</td> <td>1</td> <td>PZ</td> </tr> </tbody> </table>	Code	Description	Qty	UOM	MR1000A0	CABLE 3X1,5 H07RN-F MT1,5+K2/3+S CHUKO	1	PZ																								
Code	Description	Qty	UOM																																		
MR1000A0	CABLE 3X1,5 H07RN-F MT1,5+K2/3+S CHUKO	1	PZ																																		
VE1075A	STRAIN RELIEF FV 268 RO + FIXING SCREWS		VE1075A0	STRAIN RELIEF FV 268 RO + FIXING SCREWS																																	
RS1095A	HEATING ELEMENT 1200W 230V		KRS1095A	1.2KW HEATING ELEMENT KIT	<table border="1"> <thead> <tr> <th>Code</th> <th>Description</th> <th>Qty</th> <th>UOM</th> </tr> </thead> <tbody> <tr> <td>GN1326A1</td> <td>ELEMENT SEALING</td> <td>1</td> <td>PZ</td> </tr> <tr> <td>IP1385A0</td> <td></td> <td>1.200</td> <td>PZ</td> </tr> <tr> <td>IP1385A1</td> <td>CORNER POLYSTYREN E PACKING 110X80X2000</td> <td>0.500</td> <td>M</td> </tr> <tr> <td>RS1095A1</td> <td>HEATING ELEMENT 1200W 230V</td> <td>1</td> <td>PZ</td> </tr> <tr> <td>SL1045A0</td> <td>S53 BLACK SILICONE - 80ML CARTRIDGE</td> <td>1</td> <td>PZ</td> </tr> <tr> <td>VI1220A1</td> <td>4,2X12 TCB SELF-TAPPIN G SCREW</td> <td>2</td> <td>PZ</td> </tr> <tr> <td>VM1059A1</td> <td>HEAT SHRINK FILM H800</td> <td>1.200</td> <td>M</td> </tr> </tbody> </table>	Code	Description	Qty	UOM	GN1326A1	ELEMENT SEALING	1	PZ	IP1385A0		1.200	PZ	IP1385A1	CORNER POLYSTYREN E PACKING 110X80X2000	0.500	M	RS1095A1	HEATING ELEMENT 1200W 230V	1	PZ	SL1045A0	S53 BLACK SILICONE - 80ML CARTRIDGE	1	PZ	VI1220A1	4,2X12 TCB SELF-TAPPIN G SCREW	2	PZ	VM1059A1	HEAT SHRINK FILM H800	1.200	M
Code	Description	Qty	UOM																																		
GN1326A1	ELEMENT SEALING	1	PZ																																		
IP1385A0		1.200	PZ																																		
IP1385A1	CORNER POLYSTYREN E PACKING 110X80X2000	0.500	M																																		
RS1095A1	HEATING ELEMENT 1200W 230V	1	PZ																																		
SL1045A0	S53 BLACK SILICONE - 80ML CARTRIDGE	1	PZ																																		
VI1220A1	4,2X12 TCB SELF-TAPPIN G SCREW	2	PZ																																		
VM1059A1	HEAT SHRINK FILM H800	1.200	M																																		
EL1140A	SINGLE WATER ELECTROVALVE W/ J.GUEST		KEL1140A	1 WAY WATER SOLENOID VALVE KI	<table border="1"> <thead> <tr> <th>Code</th> <th>Description</th> <th>Qty</th> <th>UOM</th> </tr> </thead> <tbody> <tr> <td>EL1140A0</td> <td>SINGLE WATER ELECTROVAL VE W/ J.GUES</td> <td>1</td> <td>PZ</td> </tr> </tbody> </table>	Code	Description	Qty	UOM	EL1140A0	SINGLE WATER ELECTROVAL VE W/ J.GUES	1	PZ																								
Code	Description	Qty	UOM																																		
EL1140A0	SINGLE WATER ELECTROVAL VE W/ J.GUES	1	PZ																																		



COMPONENT			SPARE PART														
Code	Description	Image	Code	Description	Components list												
EL1195B	Ø8F-Ø8M ELBOW CONNECTION		KEL1195B	Ø8F-Ø8M ELBOW FITTING 10 PCS KIT	<table border="1"> <thead> <tr> <th>Code</th> <th>Description</th> <th>Qty</th> <th>UOM</th> </tr> </thead> <tbody> <tr> <td>EL1195A0</td> <td>ELBOW UNION Ø8F-Ø8M</td> <td>10</td> <td>PZ</td> </tr> <tr> <td>EL1195B0</td> <td>Ø8F-Ø8M ELBOW CONNECTION</td> <td>10</td> <td>PZ</td> </tr> </tbody> </table>	Code	Description	Qty	UOM	EL1195A0	ELBOW UNION Ø8F-Ø8M	10	PZ	EL1195B0	Ø8F-Ø8M ELBOW CONNECTION	10	PZ
			Code	Description	Qty	UOM											
EL1195A0	ELBOW UNION Ø8F-Ø8M	10	PZ														
EL1195B0	Ø8F-Ø8M ELBOW CONNECTION	10	PZ														
KEL1195A	Ø8F-Ø8M ELBOW FITTING 10 PCS KIT	<table border="1"> <thead> <tr> <th>Code</th> <th>Description</th> <th>Qty</th> <th>UOM</th> </tr> </thead> <tbody> <tr> <td>EL1195A0</td> <td>ELBOW UNION Ø8F-Ø8M</td> <td>10</td> <td>PZ</td> </tr> </tbody> </table>	Code	Description	Qty	UOM	EL1195A0	ELBOW UNION Ø8F-Ø8M	10	PZ							
Code	Description	Qty	UOM														
EL1195A0	ELBOW UNION Ø8F-Ø8M	10	PZ														
EL1125A	WALL PASSING SEAL Ø8		EL1125A0	WALL PASSING SEAL Ø8													
0H4820A	BULB HOLDING BRACKET		0H4820A1	BULB HOLDING BRACKET													
CE1024A	MANUAL PROVER FRONT THERMOSTAT UL CABLE																
GN1523A	XLT COMPONENTS BOX SEAL		KGN1328A	BLACK RUBBER SEALING PROFILE KIT	<table border="1"> <thead> <tr> <th>Code</th> <th>Description</th> <th>Qty</th> <th>UOM</th> </tr> </thead> <tbody> <tr> <td>GN1328A1</td> <td>BACK BLACK ADESIVE GASKET 8X3</td> <td>4.500</td> <td>M</td> </tr> </tbody> </table>	Code	Description	Qty	UOM	GN1328A1	BACK BLACK ADESIVE GASKET 8X3	4.500	M				
					Code	Description	Qty	UOM									
GN1328A1	BACK BLACK ADESIVE GASKET 8X3	4.500	M														

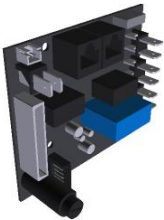

COMPONENT			SPARE PART																						
Code	Description	Image	Code	Description	Components list																				
PE1065B	LINE MISS PROVER CONTROL CARD		KPE1065B	LINEMISS PROVER POWER CARD	<table border="1"> <thead> <tr> <th>Code</th> <th>Description</th> <th>Qty</th> <th>UOM</th> </tr> </thead> <tbody> <tr> <td>PE1065B0</td> <td>LINE MISS PROVER CONTROL CARD</td> <td>1</td> <td>PZ</td> </tr> <tr> <td>V11850A0</td> <td>M4X6 NICKEL PLATED FIXING SCRE</td> <td>4</td> <td>PZ</td> </tr> <tr> <td>VM1745A0</td> <td>CARD SUPPORT</td> <td>4</td> <td>PZ</td> </tr> <tr> <td>VM2147A0</td> <td>ESD SPONGE PINK SMOOTH 410X343X15 M</td> <td>1</td> <td>PZ</td> </tr> </tbody> </table>	Code	Description	Qty	UOM	PE1065B0	LINE MISS PROVER CONTROL CARD	1	PZ	V11850A0	M4X6 NICKEL PLATED FIXING SCRE	4	PZ	VM1745A0	CARD SUPPORT	4	PZ	VM2147A0	ESD SPONGE PINK SMOOTH 410X343X15 M	1	PZ
					Code	Description	Qty	UOM																	
					PE1065B0	LINE MISS PROVER CONTROL CARD	1	PZ																	
					V11850A0	M4X6 NICKEL PLATED FIXING SCRE	4	PZ																	
					VM1745A0	CARD SUPPORT	4	PZ																	
VM2147A0	ESD SPONGE PINK SMOOTH 410X343X15 M	1	PZ																						



ASM1333A/0.D00 - General overview

FRONT

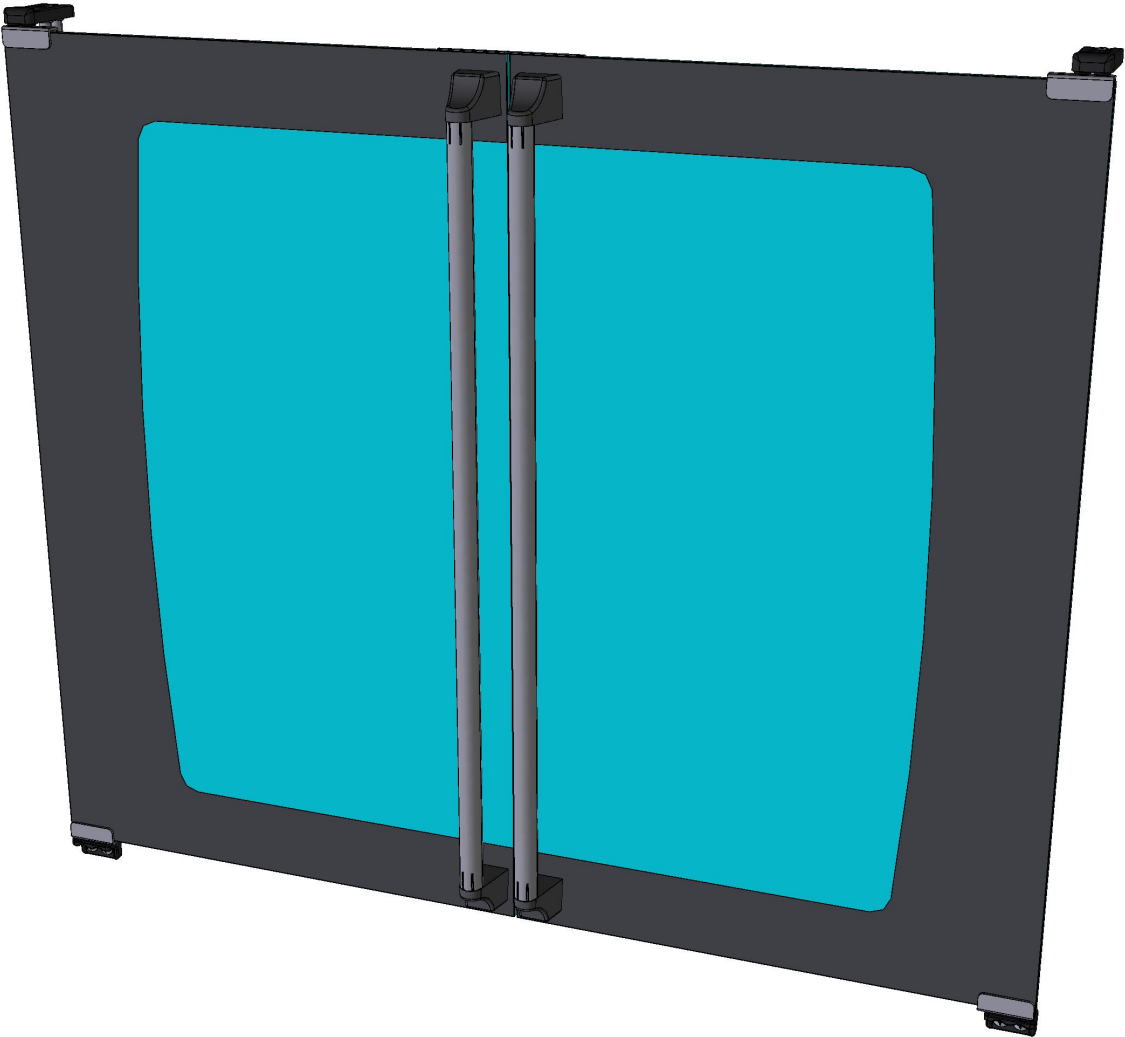



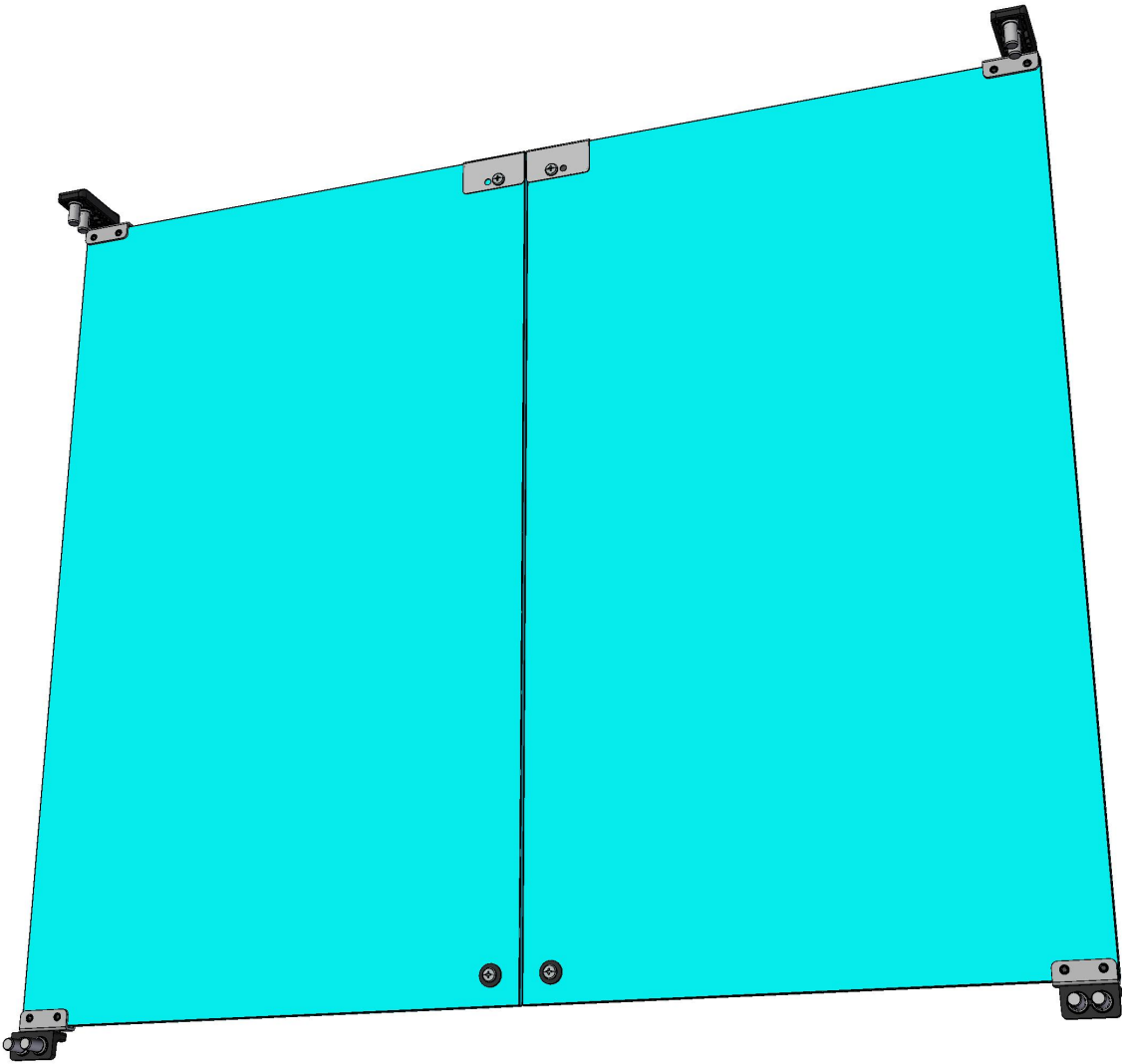

ASM1333A/0.D00 - General overview

REAR



COMPONENT			SPARE PART																																		
Code	Description	Image	Code	Description	Components list																																
VM1022B	PROOFER DOOR UPPER BRACKET		KVM1022B	PROVER DOOR UPPER BRACKET	<table border="1"> <thead> <tr> <th>Code</th> <th>Description</th> <th>Qty</th> <th>UOM</th> </tr> </thead> <tbody> <tr> <td>VM1022B0</td> <td>PROOFER DOOR UPPER BRACKET</td> <td>1</td> <td>PZ</td> </tr> </tbody> </table>	Code	Description	Qty	UOM	VM1022B0	PROOFER DOOR UPPER BRACKET	1	PZ																								
Code	Description	Qty	UOM																																		
VM1022B0	PROOFER DOOR UPPER BRACKET	1	PZ																																		
VM1024B	PROOFER DOOR LEFT LOWER BRACKET		KVM1024B	PROVER DOOR LEFT+RIGHT LOWER BRACKET KI	<table border="1"> <thead> <tr> <th>Code</th> <th>Description</th> <th>Qty</th> <th>UOM</th> </tr> </thead> <tbody> <tr> <td>VM1023B0</td> <td>PROOFER DOOR RIGHT LOWER BRACKET</td> <td>1</td> <td>PZ</td> </tr> <tr> <td>VM1024B0</td> <td>PROOFER DOOR LEFT LOWER BRACKET</td> <td>1</td> <td>PZ</td> </tr> </tbody> </table>	Code	Description	Qty	UOM	VM1023B0	PROOFER DOOR RIGHT LOWER BRACKET	1	PZ	VM1024B0	PROOFER DOOR LEFT LOWER BRACKET	1	PZ																				
Code	Description	Qty	UOM																																		
VM1023B0	PROOFER DOOR RIGHT LOWER BRACKET	1	PZ																																		
VM1024B0	PROOFER DOOR LEFT LOWER BRACKET	1	PZ																																		
CR1081A	XV-XL-XB ST. STEEL LEFT HINGE		KCR1080A	RIGHT/LEFT HINGES KIT CR1080A+CR1081A	<table border="1"> <thead> <tr> <th>Code</th> <th>Description</th> <th>Qty</th> <th>UOM</th> </tr> </thead> <tbody> <tr> <td>CR1080A0</td> <td>XV-XL-XB ST. STEEL RIGHT HINGE</td> <td>1</td> <td>PZ</td> </tr> <tr> <td>CR1081A0</td> <td>XV-XL-XB ST. STEEL LEFT HINGE</td> <td>1</td> <td>PZ</td> </tr> <tr> <td>GN1320A0</td> <td>DOOR GLASS HINGE GASKE</td> <td>2</td> <td>PZ</td> </tr> <tr> <td>GN1320A1</td> <td>DOOR GLASS GASKET</td> <td>2</td> <td>PZ</td> </tr> <tr> <td>VI1685A0</td> <td>M6X6 STAINLESS STEEL SCREW</td> <td>4</td> <td>PZ</td> </tr> <tr> <td>VM1790A0</td> <td>HINGE BUSH 12X6.5 DI5.3</td> <td>2</td> <td>PZ</td> </tr> </tbody> </table>	Code	Description	Qty	UOM	CR1080A0	XV-XL-XB ST. STEEL RIGHT HINGE	1	PZ	CR1081A0	XV-XL-XB ST. STEEL LEFT HINGE	1	PZ	GN1320A0	DOOR GLASS HINGE GASKE	2	PZ	GN1320A1	DOOR GLASS GASKET	2	PZ	VI1685A0	M6X6 STAINLESS STEEL SCREW	4	PZ	VM1790A0	HINGE BUSH 12X6.5 DI5.3	2	PZ				
Code	Description	Qty	UOM																																		
CR1080A0	XV-XL-XB ST. STEEL RIGHT HINGE	1	PZ																																		
CR1081A0	XV-XL-XB ST. STEEL LEFT HINGE	1	PZ																																		
GN1320A0	DOOR GLASS HINGE GASKE	2	PZ																																		
GN1320A1	DOOR GLASS GASKET	2	PZ																																		
VI1685A0	M6X6 STAINLESS STEEL SCREW	4	PZ																																		
VM1790A0	HINGE BUSH 12X6.5 DI5.3	2	PZ																																		
GN1320A	DOOR GLASS HINGE GASKET		KGN1320A KCR1081A	DOOR GLASS SEAL 4 PCS. KIT LEFT LOWER HINGE KIT CR1018A	<table border="1"> <thead> <tr> <th>Code</th> <th>Description</th> <th>Qty</th> <th>UOM</th> </tr> </thead> <tbody> <tr> <td>GN1320A0</td> <td>DOOR GLASS HINGE GASKE</td> <td>4</td> <td>PZ</td> </tr> <tr> <td>GN1320A1</td> <td>DOOR GLASS GASKET</td> <td>4</td> <td>PZ</td> </tr> </tbody> </table> <table border="1"> <thead> <tr> <th>Code</th> <th>Description</th> <th>Qty</th> <th>UOM</th> </tr> </thead> <tbody> <tr> <td>CR1081A0</td> <td>XV-XL-XB ST. STEEL LEFT HINGE</td> <td>1</td> <td>PZ</td> </tr> <tr> <td>GN1320A0</td> <td>DOOR GLASS HINGE GASKE</td> <td>1</td> <td>PZ</td> </tr> <tr> <td>VI1083A0</td> <td>SCREW M6X6 TC1/2T INOX A</td> <td>2</td> <td>PZ</td> </tr> <tr> <td>VM1790A0</td> <td>HINGE BUSH 12X6.5 DI5.3</td> <td>1</td> <td>PZ</td> </tr> </tbody> </table>	Code	Description	Qty	UOM	GN1320A0	DOOR GLASS HINGE GASKE	4	PZ	GN1320A1	DOOR GLASS GASKET	4	PZ	Code	Description	Qty	UOM	CR1081A0	XV-XL-XB ST. STEEL LEFT HINGE	1	PZ	GN1320A0	DOOR GLASS HINGE GASKE	1	PZ	VI1083A0	SCREW M6X6 TC1/2T INOX A	2	PZ	VM1790A0	HINGE BUSH 12X6.5 DI5.3	1	PZ
Code	Description	Qty	UOM																																		
GN1320A0	DOOR GLASS HINGE GASKE	4	PZ																																		
GN1320A1	DOOR GLASS GASKET	4	PZ																																		
Code	Description	Qty	UOM																																		
CR1081A0	XV-XL-XB ST. STEEL LEFT HINGE	1	PZ																																		
GN1320A0	DOOR GLASS HINGE GASKE	1	PZ																																		
VI1083A0	SCREW M6X6 TC1/2T INOX A	2	PZ																																		
VM1790A0	HINGE BUSH 12X6.5 DI5.3	1	PZ																																		

COMPONENT			SPARE PART																														
Code	Description	Image	Code	Description	Components list																												
GN1320A	DOOR GLASS HINGE GASKET		KCR1080A	RIGHT/LEFT HINGES KIT CR1080A+CR1081A	<table border="1"> <thead> <tr> <th>Code</th> <th>Description</th> <th>Qty</th> <th>UOM</th> </tr> </thead> <tbody> <tr> <td>CR1080A0</td> <td>XV-XL-XB ST. STEEL RIGHT HINGE</td> <td>1</td> <td>PZ</td> </tr> <tr> <td>CR1081A0</td> <td>XV-XL-XB ST. STEEL LEFT HINGE</td> <td>1</td> <td>PZ</td> </tr> <tr> <td>GN1320A0</td> <td>DOOR GLASS HINGE GASKE</td> <td>2</td> <td>PZ</td> </tr> <tr> <td>GN1320A1</td> <td>DOOR GLASS GASKET</td> <td>2</td> <td>PZ</td> </tr> <tr> <td>V11685A0</td> <td>M6X6 STAINLESS STEEL SCREW</td> <td>4</td> <td>PZ</td> </tr> <tr> <td>VM1790A0</td> <td>HINGE BUSH 12X6.5 DI5.3</td> <td>2</td> <td>PZ</td> </tr> </tbody> </table>	Code	Description	Qty	UOM	CR1080A0	XV-XL-XB ST. STEEL RIGHT HINGE	1	PZ	CR1081A0	XV-XL-XB ST. STEEL LEFT HINGE	1	PZ	GN1320A0	DOOR GLASS HINGE GASKE	2	PZ	GN1320A1	DOOR GLASS GASKET	2	PZ	V11685A0	M6X6 STAINLESS STEEL SCREW	4	PZ	VM1790A0	HINGE BUSH 12X6.5 DI5.3	2	PZ
					Code	Description	Qty	UOM																									
					CR1080A0	XV-XL-XB ST. STEEL RIGHT HINGE	1	PZ																									
					CR1081A0	XV-XL-XB ST. STEEL LEFT HINGE	1	PZ																									
					GN1320A0	DOOR GLASS HINGE GASKE	2	PZ																									
					GN1320A1	DOOR GLASS GASKET	2	PZ																									
					V11685A0	M6X6 STAINLESS STEEL SCREW	4	PZ																									
VM1790A0	HINGE BUSH 12X6.5 DI5.3	2	PZ																														
CR1080A	XV-XL-XB ST. STEEL RIGHT HINGE		KCR1080A	RIGHT/LEFT HINGES KIT CR1080A+CR1081A	<table border="1"> <thead> <tr> <th>Code</th> <th>Description</th> <th>Qty</th> <th>UOM</th> </tr> </thead> <tbody> <tr> <td>CR1080A0</td> <td>XV-XL-XB ST. STEEL RIGHT HINGE</td> <td>1</td> <td>PZ</td> </tr> <tr> <td>CR1081A0</td> <td>XV-XL-XB ST. STEEL LEFT HINGE</td> <td>1</td> <td>PZ</td> </tr> <tr> <td>GN1320A0</td> <td>DOOR GLASS HINGE GASKE</td> <td>2</td> <td>PZ</td> </tr> <tr> <td>GN1320A1</td> <td>DOOR GLASS GASKET</td> <td>2</td> <td>PZ</td> </tr> <tr> <td>V11685A0</td> <td>M6X6 STAINLESS STEEL SCREW</td> <td>4</td> <td>PZ</td> </tr> <tr> <td>VM1790A0</td> <td>HINGE BUSH 12X6.5 DI5.3</td> <td>2</td> <td>PZ</td> </tr> </tbody> </table>	Code	Description	Qty	UOM	CR1080A0	XV-XL-XB ST. STEEL RIGHT HINGE	1	PZ	CR1081A0	XV-XL-XB ST. STEEL LEFT HINGE	1	PZ	GN1320A0	DOOR GLASS HINGE GASKE	2	PZ	GN1320A1	DOOR GLASS GASKET	2	PZ	V11685A0	M6X6 STAINLESS STEEL SCREW	4	PZ	VM1790A0	HINGE BUSH 12X6.5 DI5.3	2	PZ
					Code	Description	Qty	UOM																									
					CR1080A0	XV-XL-XB ST. STEEL RIGHT HINGE	1	PZ																									
					CR1081A0	XV-XL-XB ST. STEEL LEFT HINGE	1	PZ																									
					GN1320A0	DOOR GLASS HINGE GASKE	2	PZ																									
					GN1320A1	DOOR GLASS GASKET	2	PZ																									
					V11685A0	M6X6 STAINLESS STEEL SCREW	4	PZ																									
VM1790A0	HINGE BUSH 12X6.5 DI5.3	2	PZ																														
GN1320A	DOOR GLASS HINGE GASKET		KGN1320A	DOOR GLASS SEAL 4 PCS. KIT	<table border="1"> <thead> <tr> <th>Code</th> <th>Description</th> <th>Qty</th> <th>UOM</th> </tr> </thead> <tbody> <tr> <td>GN1320A0</td> <td>DOOR GLASS HINGE GASKE</td> <td>4</td> <td>PZ</td> </tr> <tr> <td>GN1320A1</td> <td>DOOR GLASS GASKET</td> <td>4</td> <td>PZ</td> </tr> </tbody> </table>	Code	Description	Qty	UOM	GN1320A0	DOOR GLASS HINGE GASKE	4	PZ	GN1320A1	DOOR GLASS GASKET	4	PZ																
					Code	Description	Qty	UOM																									
					GN1320A0	DOOR GLASS HINGE GASKE	4	PZ																									
			GN1320A1	DOOR GLASS GASKET	4	PZ																											
			KCR1081A	LEFT LOWER HINGE KIT CR1018A	<table border="1"> <thead> <tr> <th>Code</th> <th>Description</th> <th>Qty</th> <th>UOM</th> </tr> </thead> <tbody> <tr> <td>CR1081A0</td> <td>XV-XL-XB ST. STEEL LEFT HINGE</td> <td>1</td> <td>PZ</td> </tr> <tr> <td>GN1320A0</td> <td>DOOR GLASS HINGE GASKE</td> <td>1</td> <td>PZ</td> </tr> <tr> <td>V11083A0</td> <td>SCREW M6X6 TC1/2T INOX A</td> <td>2</td> <td>PZ</td> </tr> </tbody> </table>	Code	Description	Qty	UOM	CR1081A0	XV-XL-XB ST. STEEL LEFT HINGE	1	PZ	GN1320A0	DOOR GLASS HINGE GASKE	1	PZ	V11083A0	SCREW M6X6 TC1/2T INOX A	2	PZ												
					Code	Description	Qty	UOM																									
					CR1081A0	XV-XL-XB ST. STEEL LEFT HINGE	1	PZ																									
GN1320A0	DOOR GLASS HINGE GASKE	1			PZ																												
V11083A0	SCREW M6X6 TC1/2T INOX A	2	PZ																														
VM1790A0	HINGE BUSH 12X6.5 DI5.3	1	PZ																														

COMPONENT			SPARE PART																														
Code	Description	Image	Code	Description	Components list																												
GN1320A	DOOR GLASS HINGE GASKET		KCR1080A	RIGHT/LEFT HINGES KIT CR1080A+CR1081A	<table border="1"> <thead> <tr> <th>Code</th> <th>Description</th> <th>Qty</th> <th>UOM</th> </tr> </thead> <tbody> <tr> <td>CR1080A0</td> <td>XV-XL-XB ST. STEEL RIGHT HINGE</td> <td>1</td> <td>PZ</td> </tr> <tr> <td>CR1081A0</td> <td>XV-XL-XB ST. STEEL LEFT HINGE</td> <td>1</td> <td>PZ</td> </tr> <tr> <td>GN1320A0</td> <td>DOOR GLASS HINGE GASKE</td> <td>2</td> <td>PZ</td> </tr> <tr> <td>GN1320A1</td> <td>DOOR GLASS GASKET</td> <td>2</td> <td>PZ</td> </tr> <tr> <td>V11685A0</td> <td>M6X6 STAINLESS STEEL SCREW</td> <td>4</td> <td>PZ</td> </tr> <tr> <td>VM1790A0</td> <td>HINGE BUSH 12X6.5 DI5.3</td> <td>2</td> <td>PZ</td> </tr> </tbody> </table>	Code	Description	Qty	UOM	CR1080A0	XV-XL-XB ST. STEEL RIGHT HINGE	1	PZ	CR1081A0	XV-XL-XB ST. STEEL LEFT HINGE	1	PZ	GN1320A0	DOOR GLASS HINGE GASKE	2	PZ	GN1320A1	DOOR GLASS GASKET	2	PZ	V11685A0	M6X6 STAINLESS STEEL SCREW	4	PZ	VM1790A0	HINGE BUSH 12X6.5 DI5.3	2	PZ
					Code	Description	Qty	UOM																									
					CR1080A0	XV-XL-XB ST. STEEL RIGHT HINGE	1	PZ																									
					CR1081A0	XV-XL-XB ST. STEEL LEFT HINGE	1	PZ																									
					GN1320A0	DOOR GLASS HINGE GASKE	2	PZ																									
					GN1320A1	DOOR GLASS GASKET	2	PZ																									
					V11685A0	M6X6 STAINLESS STEEL SCREW	4	PZ																									
VM1790A0	HINGE BUSH 12X6.5 DI5.3	2	PZ																														
MG1015B	L.MISS/L.MICRO/CH EFTOP HANDLE END		KMG1015B	2 PCS. HANDLE END KIT	<table border="1"> <thead> <tr> <th>Code</th> <th>Description</th> <th>Qty</th> <th>UOM</th> </tr> </thead> <tbody> <tr> <td>MG1015B0</td> <td>L.MISS/L.MICR O/CHEFTOP HANDLE END</td> <td>2</td> <td>PZ</td> </tr> <tr> <td>V11855A0</td> <td>5X25 SELF-TAPPIN G SCREW</td> <td>2</td> <td>PZ</td> </tr> <tr> <td>V11870A0</td> <td>50X50 SELF-THREADI NG SCREW FOR PLASTIC</td> <td>2</td> <td>PZ</td> </tr> <tr> <td>VM1025A0</td> <td>Ø16 GREY NYLON LID</td> <td>2</td> <td>PZ</td> </tr> </tbody> </table>	Code	Description	Qty	UOM	MG1015B0	L.MISS/L.MICR O/CHEFTOP HANDLE END	2	PZ	V11855A0	5X25 SELF-TAPPIN G SCREW	2	PZ	V11870A0	50X50 SELF-THREADI NG SCREW FOR PLASTIC	2	PZ	VM1025A0	Ø16 GREY NYLON LID	2	PZ								
					Code	Description	Qty	UOM																									
					MG1015B0	L.MISS/L.MICR O/CHEFTOP HANDLE END	2	PZ																									
					V11855A0	5X25 SELF-TAPPIN G SCREW	2	PZ																									
V11870A0	50X50 SELF-THREADI NG SCREW FOR PLASTIC	2	PZ																														
VM1025A0	Ø16 GREY NYLON LID	2	PZ																														
VM1720A	XL405 DOOR WASKER		VM1720A0	XL405 DOOR WASKER																													
TB1077A	XLT135/XLT195 Ø18X1 HANDLE TUB		KTB1077A	XLT135/XLT195 HANDLE TUBE KIT	<table border="1"> <thead> <tr> <th>Code</th> <th>Description</th> <th>Qty</th> <th>UOM</th> </tr> </thead> <tbody> <tr> <td>TB1077A0</td> <td>XLT135/XLT19 5 Ø18X1 HANDLE TUBE</td> <td>1</td> <td>PZ</td> </tr> <tr> <td>V11220A1</td> <td>4,2X12 TCB SELF-TAPPIN G SCREW</td> <td>4</td> <td>PZ</td> </tr> <tr> <td>VM1794A0</td> <td>250X4.8 PA66 BLACK CLAMP</td> <td>2</td> <td>PZ</td> </tr> <tr> <td>VM2103A0</td> <td>CLAMP LOCK</td> <td>2</td> <td>PZ</td> </tr> </tbody> </table>	Code	Description	Qty	UOM	TB1077A0	XLT135/XLT19 5 Ø18X1 HANDLE TUBE	1	PZ	V11220A1	4,2X12 TCB SELF-TAPPIN G SCREW	4	PZ	VM1794A0	250X4.8 PA66 BLACK CLAMP	2	PZ	VM2103A0	CLAMP LOCK	2	PZ								
					Code	Description	Qty	UOM																									
					TB1077A0	XLT135/XLT19 5 Ø18X1 HANDLE TUBE	1	PZ																									
					V11220A1	4,2X12 TCB SELF-TAPPIN G SCREW	4	PZ																									
VM1794A0	250X4.8 PA66 BLACK CLAMP	2	PZ																														
VM2103A0	CLAMP LOCK	2	PZ																														

COMPONENT			SPARE PART																																																						
Code	Description	Image	Code	Description	Components list																																																				
0H4540A	DOOR PLATES MAGNET XL405		0H4540A0	DOOR PLATES MAGNET XL405																																																					
GN1330A	FERRITIC PLATE GASKET XL405		KVT1086BR	XLT195/XLT193 RIGHT COMPLETE DOOR KIT	<table border="1"> <thead> <tr> <th>Code</th> <th>Description</th> <th>Qty</th> <th>UOM</th> </tr> </thead> <tbody> <tr> <td>0H4540A0</td> <td>DOOR PLATES MAGNET XL40</td> <td>1</td> <td>PZ</td> </tr> <tr> <td>CR1080A0</td> <td>XV-XL-XB ST. STEEL RIGHT HINGE</td> <td>1</td> <td>PZ</td> </tr> <tr> <td>CR1081A0</td> <td>XV-XL-XB ST. STEEL LEFT HINGE</td> <td>1</td> <td>PZ</td> </tr> <tr> <td>GN1320A0</td> <td>DOOR GLASS HINGE GASKE</td> <td>2</td> <td>PZ</td> </tr> <tr> <td>GN1320A1</td> <td>DOOR GLASS GASKET</td> <td>2</td> <td>PZ</td> </tr> <tr> <td>GN1330A0</td> <td>FERRITIC PLATE GASKET XL40</td> <td>1</td> <td>PZ</td> </tr> <tr> <td>MG1015B0</td> <td>L.MISS/L.MICR O/CHEFTOP HANDLE END</td> <td>2</td> <td>PZ</td> </tr> <tr> <td>TB1077A0</td> <td>XLT135/XLT19 5 Ø18X1 HANDLE TUBE</td> <td>1</td> <td>PZ</td> </tr> <tr> <td>VI1685A0</td> <td>M6X6 STAINLESS STEEL SCREW</td> <td>4</td> <td>PZ</td> </tr> <tr> <td>VI1930A0</td> <td>5X25 ST. STEEL SCREW CHIP</td> <td>2</td> <td>PZ</td> </tr> <tr> <td>VM1720A0</td> <td>XL405 DOOR WASKER</td> <td>1</td> <td>PZ</td> </tr> <tr> <td>VT1086B0</td> <td>XLT195/XLT19 3 DOOR BLACK GLASS 399X661</td> <td>1</td> <td>PZ</td> </tr> </tbody> </table>	Code	Description	Qty	UOM	0H4540A0	DOOR PLATES MAGNET XL40	1	PZ	CR1080A0	XV-XL-XB ST. STEEL RIGHT HINGE	1	PZ	CR1081A0	XV-XL-XB ST. STEEL LEFT HINGE	1	PZ	GN1320A0	DOOR GLASS HINGE GASKE	2	PZ	GN1320A1	DOOR GLASS GASKET	2	PZ	GN1330A0	FERRITIC PLATE GASKET XL40	1	PZ	MG1015B0	L.MISS/L.MICR O/CHEFTOP HANDLE END	2	PZ	TB1077A0	XLT135/XLT19 5 Ø18X1 HANDLE TUBE	1	PZ	VI1685A0	M6X6 STAINLESS STEEL SCREW	4	PZ	VI1930A0	5X25 ST. STEEL SCREW CHIP	2	PZ	VM1720A0	XL405 DOOR WASKER	1	PZ	VT1086B0	XLT195/XLT19 3 DOOR BLACK GLASS 399X661	1	PZ
Code	Description	Qty	UOM																																																						
0H4540A0	DOOR PLATES MAGNET XL40	1	PZ																																																						
CR1080A0	XV-XL-XB ST. STEEL RIGHT HINGE	1	PZ																																																						
CR1081A0	XV-XL-XB ST. STEEL LEFT HINGE	1	PZ																																																						
GN1320A0	DOOR GLASS HINGE GASKE	2	PZ																																																						
GN1320A1	DOOR GLASS GASKET	2	PZ																																																						
GN1330A0	FERRITIC PLATE GASKET XL40	1	PZ																																																						
MG1015B0	L.MISS/L.MICR O/CHEFTOP HANDLE END	2	PZ																																																						
TB1077A0	XLT135/XLT19 5 Ø18X1 HANDLE TUBE	1	PZ																																																						
VI1685A0	M6X6 STAINLESS STEEL SCREW	4	PZ																																																						
VI1930A0	5X25 ST. STEEL SCREW CHIP	2	PZ																																																						
VM1720A0	XL405 DOOR WASKER	1	PZ																																																						
VT1086B0	XLT195/XLT19 3 DOOR BLACK GLASS 399X661	1	PZ																																																						
			KVT1086BL	XLT195/XLT193 LEFT COMPLETE DOOR KIT	<table border="1"> <thead> <tr> <th>Code</th> <th>Description</th> <th>Qty</th> <th>UOM</th> </tr> </thead> <tbody> <tr> <td>0H4540A0</td> <td>DOOR PLATES MAGNET XL40</td> <td>1</td> <td>PZ</td> </tr> <tr> <td>CR1080A0</td> <td>XV-XL-XB ST. STEEL RIGHT HINGE</td> <td>1</td> <td>PZ</td> </tr> <tr> <td>CR1081A0</td> <td>XV-XL-XB ST. STEEL LEFT HINGE</td> <td>1</td> <td>PZ</td> </tr> <tr> <td>GN1320A0</td> <td>DOOR GLASS HINGE GASKE</td> <td>2</td> <td>PZ</td> </tr> </tbody> </table>	Code	Description	Qty	UOM	0H4540A0	DOOR PLATES MAGNET XL40	1	PZ	CR1080A0	XV-XL-XB ST. STEEL RIGHT HINGE	1	PZ	CR1081A0	XV-XL-XB ST. STEEL LEFT HINGE	1	PZ	GN1320A0	DOOR GLASS HINGE GASKE	2	PZ																																
Code	Description	Qty	UOM																																																						
0H4540A0	DOOR PLATES MAGNET XL40	1	PZ																																																						
CR1080A0	XV-XL-XB ST. STEEL RIGHT HINGE	1	PZ																																																						
CR1081A0	XV-XL-XB ST. STEEL LEFT HINGE	1	PZ																																																						
GN1320A0	DOOR GLASS HINGE GASKE	2	PZ																																																						





COMPONENT			SPARE PART																																															
Code	Description	Image	Code	Description	Components list																																													
GN1330A	FERRITIC PLATE GASKET XL405		KVT1086BL	XLT195/XLT193 LEFT COMPLETE DOOR KIT	<table border="1"> <thead> <tr> <th>Code</th> <th>Description</th> <th>Qty</th> <th>UOM</th> </tr> </thead> <tbody> <tr> <td>GN1320A1</td> <td>DOOR GLASS GASKET</td> <td>2</td> <td>PZ</td> </tr> <tr> <td>GN1330A0</td> <td>FERRITIC PLATE GASKET XL40</td> <td>1</td> <td>PZ</td> </tr> <tr> <td>MG1015B0</td> <td>L.MISS/L.MICR O/CHEFTOP HANDLE END</td> <td>2</td> <td>PZ</td> </tr> <tr> <td>TB1077A0</td> <td>XLT135/XLT19 5 Ø18X1 HANDLE TUBE</td> <td>1</td> <td>PZ</td> </tr> <tr> <td>VI1685A0</td> <td>M6X6 STAINLESS STEEL SCREW</td> <td>4</td> <td>PZ</td> </tr> <tr> <td>VI1930A0</td> <td>5X25 ST. STEEL SCREW CHIP</td> <td>2</td> <td>PZ</td> </tr> <tr> <td>VM1720A0</td> <td>XL405 DOOR WASKER</td> <td>1</td> <td>PZ</td> </tr> <tr> <td>VT1086B0</td> <td>XLT195/XLT19 3 DOOR BLACK GLASS 399X661</td> <td>1</td> <td>PZ</td> </tr> </tbody> </table>	Code	Description	Qty	UOM	GN1320A1	DOOR GLASS GASKET	2	PZ	GN1330A0	FERRITIC PLATE GASKET XL40	1	PZ	MG1015B0	L.MISS/L.MICR O/CHEFTOP HANDLE END	2	PZ	TB1077A0	XLT135/XLT19 5 Ø18X1 HANDLE TUBE	1	PZ	VI1685A0	M6X6 STAINLESS STEEL SCREW	4	PZ	VI1930A0	5X25 ST. STEEL SCREW CHIP	2	PZ	VM1720A0	XL405 DOOR WASKER	1	PZ	VT1086B0	XLT195/XLT19 3 DOOR BLACK GLASS 399X661	1	PZ									
			Code	Description	Qty	UOM																																												
GN1320A1	DOOR GLASS GASKET	2	PZ																																															
GN1330A0	FERRITIC PLATE GASKET XL40	1	PZ																																															
MG1015B0	L.MISS/L.MICR O/CHEFTOP HANDLE END	2	PZ																																															
TB1077A0	XLT135/XLT19 5 Ø18X1 HANDLE TUBE	1	PZ																																															
VI1685A0	M6X6 STAINLESS STEEL SCREW	4	PZ																																															
VI1930A0	5X25 ST. STEEL SCREW CHIP	2	PZ																																															
VM1720A0	XL405 DOOR WASKER	1	PZ																																															
VT1086B0	XLT195/XLT19 3 DOOR BLACK GLASS 399X661	1	PZ																																															
KVT1076BR	XLT135/XLT133 RIGHT COMPLETE DOOR KIT	<table border="1"> <thead> <tr> <th>Code</th> <th>Description</th> <th>Qty</th> <th>UOM</th> </tr> </thead> <tbody> <tr> <td>OH4540A0</td> <td>DOOR PLATES MAGNET XL40</td> <td>1</td> <td>PZ</td> </tr> <tr> <td>CR1080A0</td> <td>XV-XL-XB ST. STEEL RIGHT HINGE</td> <td>1</td> <td>PZ</td> </tr> <tr> <td>CR1081A0</td> <td>XV-XL-XB ST. STEEL LEFT HINGE</td> <td>1</td> <td>PZ</td> </tr> <tr> <td>GN1320A0</td> <td>DOOR GLASS HINGE GASKE</td> <td>2</td> <td>PZ</td> </tr> <tr> <td>GN1320A1</td> <td>DOOR GLASS GASKET</td> <td>2</td> <td>PZ</td> </tr> <tr> <td>GN1330A0</td> <td>FERRITIC PLATE GASKET XL40</td> <td>1</td> <td>PZ</td> </tr> <tr> <td>IP1385A1</td> <td>CORNER POLYSTYREN E PACKING 110X80X2000</td> <td>1.400</td> <td>M</td> </tr> <tr> <td>IP1508A0</td> <td></td> <td>0.300</td> <td>PZ</td> </tr> <tr> <td>IP1508A1</td> <td>POLYSTYREN E U SHAPED PROFILE 2000X60X60</td> <td>2</td> <td>M</td> </tr> <tr> <td>MG1015B0</td> <td>L.MISS/L.MICR O/CHEFTOP HANDLE END</td> <td>2</td> <td>PZ</td> </tr> <tr> <td>TB1077A0</td> <td>XLT135/XLT19 5 Ø18X1 HANDLE TUBE</td> <td>1</td> <td>PZ</td> </tr> </tbody> </table>	Code	Description	Qty	UOM	OH4540A0	DOOR PLATES MAGNET XL40	1	PZ	CR1080A0	XV-XL-XB ST. STEEL RIGHT HINGE	1	PZ	CR1081A0	XV-XL-XB ST. STEEL LEFT HINGE	1	PZ	GN1320A0	DOOR GLASS HINGE GASKE	2	PZ	GN1320A1	DOOR GLASS GASKET	2	PZ	GN1330A0	FERRITIC PLATE GASKET XL40	1	PZ	IP1385A1	CORNER POLYSTYREN E PACKING 110X80X2000	1.400	M	IP1508A0		0.300	PZ	IP1508A1	POLYSTYREN E U SHAPED PROFILE 2000X60X60	2	M	MG1015B0	L.MISS/L.MICR O/CHEFTOP HANDLE END	2	PZ	TB1077A0	XLT135/XLT19 5 Ø18X1 HANDLE TUBE	1	PZ
Code	Description	Qty	UOM																																															
OH4540A0	DOOR PLATES MAGNET XL40	1	PZ																																															
CR1080A0	XV-XL-XB ST. STEEL RIGHT HINGE	1	PZ																																															
CR1081A0	XV-XL-XB ST. STEEL LEFT HINGE	1	PZ																																															
GN1320A0	DOOR GLASS HINGE GASKE	2	PZ																																															
GN1320A1	DOOR GLASS GASKET	2	PZ																																															
GN1330A0	FERRITIC PLATE GASKET XL40	1	PZ																																															
IP1385A1	CORNER POLYSTYREN E PACKING 110X80X2000	1.400	M																																															
IP1508A0		0.300	PZ																																															
IP1508A1	POLYSTYREN E U SHAPED PROFILE 2000X60X60	2	M																																															
MG1015B0	L.MISS/L.MICR O/CHEFTOP HANDLE END	2	PZ																																															
TB1077A0	XLT135/XLT19 5 Ø18X1 HANDLE TUBE	1	PZ																																															



COMPONENT			SPARE PART																																																															
Code	Description	Image	Code	Description	Components list																																																													
GN1330A	FERRITIC PLATE GASKET XL405		KVT1076BR	XLT135/XLT133 RIGHT COMPLETE DOOR KIT	<table border="1"> <thead> <tr> <th>Code</th> <th>Description</th> <th>Qty</th> <th>UOM</th> </tr> </thead> <tbody> <tr> <td>VI1685A0</td> <td>M6X6 STAINLESS STEEL SCREW</td> <td>4</td> <td>PZ</td> </tr> <tr> <td>VI1930A0</td> <td>5X25 ST. STEEL SCREW CHIP</td> <td>2</td> <td>PZ</td> </tr> <tr> <td>VM1059A1</td> <td>HEAT SHRINK FILM H800</td> <td>1.500</td> <td>M</td> </tr> <tr> <td>VM1720A0</td> <td>XL405 DOOR WASKER</td> <td>1</td> <td>PZ</td> </tr> <tr> <td>VT1076B0</td> <td>XLT135/XLT13 3 BLACK DOOR GLASS 299X661</td> <td>1</td> <td>PZ</td> </tr> </tbody> </table>	Code	Description	Qty	UOM	VI1685A0	M6X6 STAINLESS STEEL SCREW	4	PZ	VI1930A0	5X25 ST. STEEL SCREW CHIP	2	PZ	VM1059A1	HEAT SHRINK FILM H800	1.500	M	VM1720A0	XL405 DOOR WASKER	1	PZ	VT1076B0	XLT135/XLT13 3 BLACK DOOR GLASS 299X661	1	PZ																																					
			Code	Description	Qty	UOM																																																												
VI1685A0	M6X6 STAINLESS STEEL SCREW	4	PZ																																																															
VI1930A0	5X25 ST. STEEL SCREW CHIP	2	PZ																																																															
VM1059A1	HEAT SHRINK FILM H800	1.500	M																																																															
VM1720A0	XL405 DOOR WASKER	1	PZ																																																															
VT1076B0	XLT135/XLT13 3 BLACK DOOR GLASS 299X661	1	PZ																																																															
KVT1076BL	XLT135/XLT133 LEFT COMPLETE DOOR KIT	<table border="1"> <thead> <tr> <th>Code</th> <th>Description</th> <th>Qty</th> <th>UOM</th> </tr> </thead> <tbody> <tr> <td>OH4540A0</td> <td>DOOR PLATES MAGNET XL40</td> <td>1</td> <td>PZ</td> </tr> <tr> <td>CR1080A0</td> <td>XV-XL-XB ST. STEEL RIGHT HINGE</td> <td>1</td> <td>PZ</td> </tr> <tr> <td>CR1081A0</td> <td>XV-XL-XB ST. STEEL LEFT HINGE</td> <td>1</td> <td>PZ</td> </tr> <tr> <td>GN1320A0</td> <td>DOOR GLASS HINGE GASKE</td> <td>2</td> <td>PZ</td> </tr> <tr> <td>GN1320A1</td> <td>DOOR GLASS GASKET</td> <td>2</td> <td>PZ</td> </tr> <tr> <td>GN1330A0</td> <td>FERRITIC PLATE GASKET XL40</td> <td>1</td> <td>PZ</td> </tr> <tr> <td>IP1385A1</td> <td>CORNER POLYSTYREN E PACKING 110X80X2000</td> <td>1.400</td> <td>M</td> </tr> <tr> <td>IP1508A1</td> <td>POLYSTYREN E U SHAPED PROFILE 2000X60X60</td> <td>0.300</td> <td>M</td> </tr> <tr> <td>MG1015B0</td> <td>L.MISS/L.MICR O/CHEFTOP HANDLE END</td> <td>2</td> <td>PZ</td> </tr> <tr> <td>TB1077A0</td> <td>XLT135/XLT19 5 Ø18X1 HANDLE TUBE</td> <td>1</td> <td>PZ</td> </tr> <tr> <td>VI1685A0</td> <td>M6X6 STAINLESS STEEL SCREW</td> <td>4</td> <td>PZ</td> </tr> <tr> <td>VI1930A0</td> <td>5X25 ST. STEEL SCREW CHIP</td> <td>2</td> <td>PZ</td> </tr> <tr> <td>VM1059A1</td> <td>HEAT SHRINK FILM H800</td> <td>1.500</td> <td>M</td> </tr> <tr> <td>VM1720A0</td> <td>XL405 DOOR WASKER</td> <td>1</td> <td>PZ</td> </tr> <tr> <td>VT1076B0</td> <td>XLT135/XLT13 3 BLACK DOOR GLASS 299X661</td> <td>1</td> <td>PZ</td> </tr> </tbody> </table>	Code	Description	Qty	UOM	OH4540A0	DOOR PLATES MAGNET XL40	1	PZ	CR1080A0	XV-XL-XB ST. STEEL RIGHT HINGE	1	PZ	CR1081A0	XV-XL-XB ST. STEEL LEFT HINGE	1	PZ	GN1320A0	DOOR GLASS HINGE GASKE	2	PZ	GN1320A1	DOOR GLASS GASKET	2	PZ	GN1330A0	FERRITIC PLATE GASKET XL40	1	PZ	IP1385A1	CORNER POLYSTYREN E PACKING 110X80X2000	1.400	M	IP1508A1	POLYSTYREN E U SHAPED PROFILE 2000X60X60	0.300	M	MG1015B0	L.MISS/L.MICR O/CHEFTOP HANDLE END	2	PZ	TB1077A0	XLT135/XLT19 5 Ø18X1 HANDLE TUBE	1	PZ	VI1685A0	M6X6 STAINLESS STEEL SCREW	4	PZ	VI1930A0	5X25 ST. STEEL SCREW CHIP	2	PZ	VM1059A1	HEAT SHRINK FILM H800	1.500	M	VM1720A0	XL405 DOOR WASKER	1	PZ	VT1076B0	XLT135/XLT13 3 BLACK DOOR GLASS 299X661	1	PZ
Code	Description	Qty	UOM																																																															
OH4540A0	DOOR PLATES MAGNET XL40	1	PZ																																																															
CR1080A0	XV-XL-XB ST. STEEL RIGHT HINGE	1	PZ																																																															
CR1081A0	XV-XL-XB ST. STEEL LEFT HINGE	1	PZ																																																															
GN1320A0	DOOR GLASS HINGE GASKE	2	PZ																																																															
GN1320A1	DOOR GLASS GASKET	2	PZ																																																															
GN1330A0	FERRITIC PLATE GASKET XL40	1	PZ																																																															
IP1385A1	CORNER POLYSTYREN E PACKING 110X80X2000	1.400	M																																																															
IP1508A1	POLYSTYREN E U SHAPED PROFILE 2000X60X60	0.300	M																																																															
MG1015B0	L.MISS/L.MICR O/CHEFTOP HANDLE END	2	PZ																																																															
TB1077A0	XLT135/XLT19 5 Ø18X1 HANDLE TUBE	1	PZ																																																															
VI1685A0	M6X6 STAINLESS STEEL SCREW	4	PZ																																																															
VI1930A0	5X25 ST. STEEL SCREW CHIP	2	PZ																																																															
VM1059A1	HEAT SHRINK FILM H800	1.500	M																																																															
VM1720A0	XL405 DOOR WASKER	1	PZ																																																															
VT1076B0	XLT135/XLT13 3 BLACK DOOR GLASS 299X661	1	PZ																																																															





COMPONENT			SPARE PART																																																																																													
Code	Description	Image	Code	Description	Components list																																																																																											
GN1330A	FERRITIC PLATE GASKET XL405		KDR1210AR	XL405 COMPLETE RIGHT DOOR	<table border="1"> <thead> <tr> <th>Code</th> <th>Description</th> <th>Qty</th> <th>UOM</th> </tr> </thead> <tbody> <tr> <td>0H4530C0</td> <td>RIGHT DOOR DRIPPING TRAY XL415</td> <td>1</td> <td>PZ</td> </tr> <tr> <td>0H4540A0</td> <td>DOOR PLATES MAGNET XL40</td> <td>1</td> <td>PZ</td> </tr> <tr> <td>CR1080A0</td> <td>XV-XL-XB ST. STEEL RIGHT HINGE</td> <td>1</td> <td>PZ</td> </tr> <tr> <td>CR1081A0</td> <td>XV-XL-XB ST. STEEL LEFT HINGE</td> <td>1</td> <td>PZ</td> </tr> <tr> <td>GN1320A0</td> <td>DOOR GLASS HINGE GASKE</td> <td>2</td> <td>PZ</td> </tr> <tr> <td>GN1320A1</td> <td>DOOR GLASS GASKET</td> <td>2</td> <td>PZ</td> </tr> <tr> <td>GN1330A0</td> <td>FERRITIC PLATE GASKET XL40</td> <td>1</td> <td>PZ</td> </tr> <tr> <td>IP1385A1</td> <td>CORNER POLYSTYREN E PACKING 110X80X2000</td> <td>1.300</td> <td>M</td> </tr> <tr> <td>IP1508A0</td> <td></td> <td>0.570</td> <td>PZ</td> </tr> <tr> <td>IP1508A1</td> <td>POLYSTYREN E U SHAPED PROFILE 2000X60X60</td> <td>2</td> <td>M</td> </tr> <tr> <td>MG1015B0</td> <td>L.MISS/L.MICR O/CHEFTOP HANDLE END</td> <td>2</td> <td>PZ</td> </tr> <tr> <td>TB1730A0</td> <td>XL405-413-415 HANDLE TUBE</td> <td>1</td> <td>PZ</td> </tr> <tr> <td>VI1685A0</td> <td>M6X6 STAINLESS STEEL SCREW</td> <td>4</td> <td>PZ</td> </tr> <tr> <td>VI1930A0</td> <td>5X25 ST. STEEL SCREW CHIP</td> <td>2</td> <td>PZ</td> </tr> <tr> <td>VM1059A1</td> <td>HEAT SHRINK FILM H800</td> <td>1.300</td> <td>M</td> </tr> <tr> <td>VM1720A0</td> <td>XL405 DOOR WASKER</td> <td>1</td> <td>PZ</td> </tr> <tr> <td>VM1790A0</td> <td>HINGE BUSH 12X6.5 DI5.3</td> <td>2</td> <td>PZ</td> </tr> <tr> <td>VT1210A0</td> <td>XL405-413-415 DOOR GLASS</td> <td>1</td> <td>PZ</td> </tr> </tbody> </table>	Code	Description	Qty	UOM	0H4530C0	RIGHT DOOR DRIPPING TRAY XL415	1	PZ	0H4540A0	DOOR PLATES MAGNET XL40	1	PZ	CR1080A0	XV-XL-XB ST. STEEL RIGHT HINGE	1	PZ	CR1081A0	XV-XL-XB ST. STEEL LEFT HINGE	1	PZ	GN1320A0	DOOR GLASS HINGE GASKE	2	PZ	GN1320A1	DOOR GLASS GASKET	2	PZ	GN1330A0	FERRITIC PLATE GASKET XL40	1	PZ	IP1385A1	CORNER POLYSTYREN E PACKING 110X80X2000	1.300	M	IP1508A0		0.570	PZ	IP1508A1	POLYSTYREN E U SHAPED PROFILE 2000X60X60	2	M	MG1015B0	L.MISS/L.MICR O/CHEFTOP HANDLE END	2	PZ	TB1730A0	XL405-413-415 HANDLE TUBE	1	PZ	VI1685A0	M6X6 STAINLESS STEEL SCREW	4	PZ	VI1930A0	5X25 ST. STEEL SCREW CHIP	2	PZ	VM1059A1	HEAT SHRINK FILM H800	1.300	M	VM1720A0	XL405 DOOR WASKER	1	PZ	VM1790A0	HINGE BUSH 12X6.5 DI5.3	2	PZ	VT1210A0	XL405-413-415 DOOR GLASS	1	PZ	KDR1210AL	XL405 COMPLETE LEFT DOOR	<table border="1"> <thead> <tr> <th>Code</th> <th>Description</th> <th>Qty</th> <th>UOM</th> </tr> </thead> <tbody> <tr> <td>0H4535C0</td> <td>LEFT DOOR DRIPPING TRAY XL415</td> <td>1</td> <td>PZ</td> </tr> <tr> <td>0H4540A0</td> <td>DOOR PLATES MAGNET XL40</td> <td>1</td> <td>PZ</td> </tr> </tbody> </table>	Code	Description	Qty	UOM	0H4535C0	LEFT DOOR DRIPPING TRAY XL415	1	PZ	0H4540A0	DOOR PLATES MAGNET XL40	1	PZ
			Code	Description	Qty	UOM																																																																																										
0H4530C0	RIGHT DOOR DRIPPING TRAY XL415	1	PZ																																																																																													
0H4540A0	DOOR PLATES MAGNET XL40	1	PZ																																																																																													
CR1080A0	XV-XL-XB ST. STEEL RIGHT HINGE	1	PZ																																																																																													
CR1081A0	XV-XL-XB ST. STEEL LEFT HINGE	1	PZ																																																																																													
GN1320A0	DOOR GLASS HINGE GASKE	2	PZ																																																																																													
GN1320A1	DOOR GLASS GASKET	2	PZ																																																																																													
GN1330A0	FERRITIC PLATE GASKET XL40	1	PZ																																																																																													
IP1385A1	CORNER POLYSTYREN E PACKING 110X80X2000	1.300	M																																																																																													
IP1508A0		0.570	PZ																																																																																													
IP1508A1	POLYSTYREN E U SHAPED PROFILE 2000X60X60	2	M																																																																																													
MG1015B0	L.MISS/L.MICR O/CHEFTOP HANDLE END	2	PZ																																																																																													
TB1730A0	XL405-413-415 HANDLE TUBE	1	PZ																																																																																													
VI1685A0	M6X6 STAINLESS STEEL SCREW	4	PZ																																																																																													
VI1930A0	5X25 ST. STEEL SCREW CHIP	2	PZ																																																																																													
VM1059A1	HEAT SHRINK FILM H800	1.300	M																																																																																													
VM1720A0	XL405 DOOR WASKER	1	PZ																																																																																													
VM1790A0	HINGE BUSH 12X6.5 DI5.3	2	PZ																																																																																													
VT1210A0	XL405-413-415 DOOR GLASS	1	PZ																																																																																													
Code	Description	Qty	UOM																																																																																													
0H4535C0	LEFT DOOR DRIPPING TRAY XL415	1	PZ																																																																																													
0H4540A0	DOOR PLATES MAGNET XL40	1	PZ																																																																																													

COMPONENT			SPARE PART																																																																						
Code	Description	Image	Code	Description	Components list																																																																				
GN1330A	FERRITIC PLATE GASKET XL405		KDR1210AL	XL405 COMPLETE LEFT DOOR	<table border="1"> <thead> <tr> <th>Code</th> <th>Description</th> <th>Qty</th> <th>UOM</th> </tr> </thead> <tbody> <tr> <td>CR1080A0</td> <td>XV-XL-XB ST. STEEL RIGHT HINGE</td> <td>1</td> <td>PZ</td> </tr> <tr> <td>CR1081A0</td> <td>XV-XL-XB ST. STEEL LEFT HINGE</td> <td>1</td> <td>PZ</td> </tr> <tr> <td>GN1320A0</td> <td>DOOR GLASS HINGE GASKE</td> <td>2</td> <td>PZ</td> </tr> <tr> <td>GN1320A1</td> <td>DOOR GLASS GASKET</td> <td>2</td> <td>PZ</td> </tr> <tr> <td>GN1330A0</td> <td>FERRITIC PLATE GASKET XL40</td> <td>1</td> <td>PZ</td> </tr> <tr> <td>IP1385A1</td> <td>CORNER POLYSTYREN E PACKING 110X80X2000</td> <td>1.300</td> <td>M</td> </tr> <tr> <td>IP1508A0</td> <td></td> <td>0.570</td> <td>PZ</td> </tr> <tr> <td>IP1508A1</td> <td>POLYSTYREN E U SHAPED PROFILE 2000X60X60</td> <td>2</td> <td>M</td> </tr> <tr> <td>MG1015B0</td> <td>L.MISS/L.MICR O/CHEFTOP HANDLE END</td> <td>2</td> <td>PZ</td> </tr> <tr> <td>TB1730A0</td> <td>XL405-413-415 HANDLE TUBE</td> <td>1</td> <td>PZ</td> </tr> <tr> <td>VI1685A0</td> <td>M6X6 STAINLESS STEEL SCREW</td> <td>4</td> <td>PZ</td> </tr> <tr> <td>VI1930A0</td> <td>5X25 ST. STEEL SCREW CHIP</td> <td>2</td> <td>PZ</td> </tr> <tr> <td>VM1059A1</td> <td>HEAT SHRINK FILM H800</td> <td>1.300</td> <td>M</td> </tr> <tr> <td>VM1720A0</td> <td>XL405 DOOR WASKER</td> <td>1</td> <td>PZ</td> </tr> <tr> <td>VM1790A0</td> <td>HINGE BUSH 12X6.5 DI5.3</td> <td>2</td> <td>PZ</td> </tr> <tr> <td>VT1210A0</td> <td>XL405-413-415 DOOR GLASS</td> <td>1</td> <td>PZ</td> </tr> </tbody> </table>	Code	Description	Qty	UOM	CR1080A0	XV-XL-XB ST. STEEL RIGHT HINGE	1	PZ	CR1081A0	XV-XL-XB ST. STEEL LEFT HINGE	1	PZ	GN1320A0	DOOR GLASS HINGE GASKE	2	PZ	GN1320A1	DOOR GLASS GASKET	2	PZ	GN1330A0	FERRITIC PLATE GASKET XL40	1	PZ	IP1385A1	CORNER POLYSTYREN E PACKING 110X80X2000	1.300	M	IP1508A0		0.570	PZ	IP1508A1	POLYSTYREN E U SHAPED PROFILE 2000X60X60	2	M	MG1015B0	L.MISS/L.MICR O/CHEFTOP HANDLE END	2	PZ	TB1730A0	XL405-413-415 HANDLE TUBE	1	PZ	VI1685A0	M6X6 STAINLESS STEEL SCREW	4	PZ	VI1930A0	5X25 ST. STEEL SCREW CHIP	2	PZ	VM1059A1	HEAT SHRINK FILM H800	1.300	M	VM1720A0	XL405 DOOR WASKER	1	PZ	VM1790A0	HINGE BUSH 12X6.5 DI5.3	2	PZ	VT1210A0	XL405-413-415 DOOR GLASS	1	PZ
					Code	Description	Qty	UOM																																																																	
					CR1080A0	XV-XL-XB ST. STEEL RIGHT HINGE	1	PZ																																																																	
					CR1081A0	XV-XL-XB ST. STEEL LEFT HINGE	1	PZ																																																																	
					GN1320A0	DOOR GLASS HINGE GASKE	2	PZ																																																																	
					GN1320A1	DOOR GLASS GASKET	2	PZ																																																																	
					GN1330A0	FERRITIC PLATE GASKET XL40	1	PZ																																																																	
					IP1385A1	CORNER POLYSTYREN E PACKING 110X80X2000	1.300	M																																																																	
					IP1508A0		0.570	PZ																																																																	
					IP1508A1	POLYSTYREN E U SHAPED PROFILE 2000X60X60	2	M																																																																	
					MG1015B0	L.MISS/L.MICR O/CHEFTOP HANDLE END	2	PZ																																																																	
					TB1730A0	XL405-413-415 HANDLE TUBE	1	PZ																																																																	
					VI1685A0	M6X6 STAINLESS STEEL SCREW	4	PZ																																																																	
					VI1930A0	5X25 ST. STEEL SCREW CHIP	2	PZ																																																																	
					VM1059A1	HEAT SHRINK FILM H800	1.300	M																																																																	
VM1720A0	XL405 DOOR WASKER	1	PZ																																																																						
VM1790A0	HINGE BUSH 12X6.5 DI5.3	2	PZ																																																																						
VT1210A0	XL405-413-415 DOOR GLASS	1	PZ																																																																						
VT1086B	XLT195\XLT193 DOOR BLACK GLASS 399X661		KVT1086BR	XLT195/XLT193 RIGHT COMPLETE DOOR KIT	<table border="1"> <thead> <tr> <th>Code</th> <th>Description</th> <th>Qty</th> <th>UOM</th> </tr> </thead> <tbody> <tr> <td>OH4540A0</td> <td>DOOR PLATES MAGNET XL40</td> <td>1</td> <td>PZ</td> </tr> <tr> <td>CR1080A0</td> <td>XV-XL-XB ST. STEEL RIGHT HINGE</td> <td>1</td> <td>PZ</td> </tr> <tr> <td>CR1081A0</td> <td>XV-XL-XB ST. STEEL LEFT HINGE</td> <td>1</td> <td>PZ</td> </tr> <tr> <td>GN1320A0</td> <td>DOOR GLASS HINGE GASKE</td> <td>2</td> <td>PZ</td> </tr> <tr> <td>GN1320A1</td> <td>DOOR GLASS GASKET</td> <td>2</td> <td>PZ</td> </tr> </tbody> </table>	Code	Description	Qty	UOM	OH4540A0	DOOR PLATES MAGNET XL40	1	PZ	CR1080A0	XV-XL-XB ST. STEEL RIGHT HINGE	1	PZ	CR1081A0	XV-XL-XB ST. STEEL LEFT HINGE	1	PZ	GN1320A0	DOOR GLASS HINGE GASKE	2	PZ	GN1320A1	DOOR GLASS GASKET	2	PZ																																												
					Code	Description	Qty	UOM																																																																	
					OH4540A0	DOOR PLATES MAGNET XL40	1	PZ																																																																	
					CR1080A0	XV-XL-XB ST. STEEL RIGHT HINGE	1	PZ																																																																	
					CR1081A0	XV-XL-XB ST. STEEL LEFT HINGE	1	PZ																																																																	
GN1320A0	DOOR GLASS HINGE GASKE	2	PZ																																																																						
GN1320A1	DOOR GLASS GASKET	2	PZ																																																																						

COMPONENT			SPARE PART																																																			
Code	Description	Image	Code	Description	Components list																																																	
VT1086B	XLT195\XLT193 DOOR BLACK GLASS 399X661		KVT1086BR	XLT195/XLT193 RIGHT COMPLETE DOOR KIT	<table border="1"> <thead> <tr> <th>Code</th> <th>Description</th> <th>Qty</th> <th>UOM</th> </tr> </thead> <tbody> <tr> <td>GN1330A0</td> <td>FERRITIC PLATE GASKET XL40</td> <td>1</td> <td>PZ</td> </tr> <tr> <td>MG1015B0</td> <td>L.MISS/L.MICR O/CHEFTOP HANDLE END</td> <td>2</td> <td>PZ</td> </tr> <tr> <td>TB1077A0</td> <td>XLT135/XLT19 5 Ø18X1 HANDLE TUBE</td> <td>1</td> <td>PZ</td> </tr> <tr> <td>VI1685A0</td> <td>M6X6 STAINLESS STEEL SCREW</td> <td>4</td> <td>PZ</td> </tr> <tr> <td>VI1930A0</td> <td>5X25 ST. STEEL SCREW CHIP</td> <td>2</td> <td>PZ</td> </tr> <tr> <td>VM1720A0</td> <td>XL405 DOOR WASKER</td> <td>1</td> <td>PZ</td> </tr> <tr> <td>VT1086B0</td> <td>XLT195\XLT19 3 DOOR BLACK GLASS 399X661</td> <td>1</td> <td>PZ</td> </tr> </tbody> </table>	Code	Description	Qty	UOM	GN1330A0	FERRITIC PLATE GASKET XL40	1	PZ	MG1015B0	L.MISS/L.MICR O/CHEFTOP HANDLE END	2	PZ	TB1077A0	XLT135/XLT19 5 Ø18X1 HANDLE TUBE	1	PZ	VI1685A0	M6X6 STAINLESS STEEL SCREW	4	PZ	VI1930A0	5X25 ST. STEEL SCREW CHIP	2	PZ	VM1720A0	XL405 DOOR WASKER	1	PZ	VT1086B0	XLT195\XLT19 3 DOOR BLACK GLASS 399X661	1	PZ																	
			Code	Description	Qty	UOM																																																
GN1330A0	FERRITIC PLATE GASKET XL40	1	PZ																																																			
MG1015B0	L.MISS/L.MICR O/CHEFTOP HANDLE END	2	PZ																																																			
TB1077A0	XLT135/XLT19 5 Ø18X1 HANDLE TUBE	1	PZ																																																			
VI1685A0	M6X6 STAINLESS STEEL SCREW	4	PZ																																																			
VI1930A0	5X25 ST. STEEL SCREW CHIP	2	PZ																																																			
VM1720A0	XL405 DOOR WASKER	1	PZ																																																			
VT1086B0	XLT195\XLT19 3 DOOR BLACK GLASS 399X661	1	PZ																																																			
KVT1086BL	XLT195/XLT193 LEFT COMPLETE DOOR KIT	<table border="1"> <thead> <tr> <th>Code</th> <th>Description</th> <th>Qty</th> <th>UOM</th> </tr> </thead> <tbody> <tr> <td>0H4540A0</td> <td>DOOR PLATES MAGNET XL40</td> <td>1</td> <td>PZ</td> </tr> <tr> <td>CR1080A0</td> <td>XV-XL-XB ST. STEEL RIGHT HINGE</td> <td>1</td> <td>PZ</td> </tr> <tr> <td>CR1081A0</td> <td>XV-XL-XB ST. STEEL LEFT HINGE</td> <td>1</td> <td>PZ</td> </tr> <tr> <td>GN1320A0</td> <td>DOOR GLASS HINGE GASKE</td> <td>2</td> <td>PZ</td> </tr> <tr> <td>GN1320A1</td> <td>DOOR GLASS GASKET</td> <td>2</td> <td>PZ</td> </tr> <tr> <td>GN1330A0</td> <td>FERRITIC PLATE GASKET XL40</td> <td>1</td> <td>PZ</td> </tr> <tr> <td>MG1015B0</td> <td>L.MISS/L.MICR O/CHEFTOP HANDLE END</td> <td>2</td> <td>PZ</td> </tr> <tr> <td>TB1077A0</td> <td>XLT135/XLT19 5 Ø18X1 HANDLE TUBE</td> <td>1</td> <td>PZ</td> </tr> <tr> <td>VI1685A0</td> <td>M6X6 STAINLESS STEEL SCREW</td> <td>4</td> <td>PZ</td> </tr> <tr> <td>VI1930A0</td> <td>5X25 ST. STEEL SCREW CHIP</td> <td>2</td> <td>PZ</td> </tr> <tr> <td>VM1720A0</td> <td>XL405 DOOR WASKER</td> <td>1</td> <td>PZ</td> </tr> <tr> <td>VT1086B0</td> <td>XLT195\XLT19 3 DOOR BLACK GLASS 399X661</td> <td>1</td> <td>PZ</td> </tr> </tbody> </table>	Code	Description	Qty	UOM	0H4540A0	DOOR PLATES MAGNET XL40	1	PZ	CR1080A0	XV-XL-XB ST. STEEL RIGHT HINGE	1	PZ	CR1081A0	XV-XL-XB ST. STEEL LEFT HINGE	1	PZ	GN1320A0	DOOR GLASS HINGE GASKE	2	PZ	GN1320A1	DOOR GLASS GASKET	2	PZ	GN1330A0	FERRITIC PLATE GASKET XL40	1	PZ	MG1015B0	L.MISS/L.MICR O/CHEFTOP HANDLE END	2	PZ	TB1077A0	XLT135/XLT19 5 Ø18X1 HANDLE TUBE	1	PZ	VI1685A0	M6X6 STAINLESS STEEL SCREW	4	PZ	VI1930A0	5X25 ST. STEEL SCREW CHIP	2	PZ	VM1720A0	XL405 DOOR WASKER	1	PZ	VT1086B0	XLT195\XLT19 3 DOOR BLACK GLASS 399X661	1	PZ
Code	Description	Qty	UOM																																																			
0H4540A0	DOOR PLATES MAGNET XL40	1	PZ																																																			
CR1080A0	XV-XL-XB ST. STEEL RIGHT HINGE	1	PZ																																																			
CR1081A0	XV-XL-XB ST. STEEL LEFT HINGE	1	PZ																																																			
GN1320A0	DOOR GLASS HINGE GASKE	2	PZ																																																			
GN1320A1	DOOR GLASS GASKET	2	PZ																																																			
GN1330A0	FERRITIC PLATE GASKET XL40	1	PZ																																																			
MG1015B0	L.MISS/L.MICR O/CHEFTOP HANDLE END	2	PZ																																																			
TB1077A0	XLT135/XLT19 5 Ø18X1 HANDLE TUBE	1	PZ																																																			
VI1685A0	M6X6 STAINLESS STEEL SCREW	4	PZ																																																			
VI1930A0	5X25 ST. STEEL SCREW CHIP	2	PZ																																																			
VM1720A0	XL405 DOOR WASKER	1	PZ																																																			
VT1086B0	XLT195\XLT19 3 DOOR BLACK GLASS 399X661	1	PZ																																																			

COMPONENT			SPARE PART																																		
Code	Description	Image	Code	Description	Components list																																
VM1022B	PROOFER DOOR UPPER BRACKET		KVM1022B	PROOFER DOOR UPPER BRACKET	<table border="1"> <thead> <tr> <th>Code</th> <th>Description</th> <th>Qty</th> <th>UOM</th> </tr> </thead> <tbody> <tr> <td>VM1022B0</td> <td>PROOFER DOOR UPPER BRACKET</td> <td>1</td> <td>PZ</td> </tr> </tbody> </table>	Code	Description	Qty	UOM	VM1022B0	PROOFER DOOR UPPER BRACKET	1	PZ																								
Code	Description	Qty	UOM																																		
VM1022B0	PROOFER DOOR UPPER BRACKET	1	PZ																																		
VM1023B	PROOFER DOOR RIGHT LOWER BRACKET		KVM1024A	PROOFER LF/RG DOOR LOWER BRACKET KIT	<table border="1"> <thead> <tr> <th>Code</th> <th>Description</th> <th>Qty</th> <th>UOM</th> </tr> </thead> <tbody> <tr> <td>VM1023A0</td> <td>PROOFER DOOR RIGHT LOWER BRACKET</td> <td>1</td> <td>PZ</td> </tr> <tr> <td>VM1024A0</td> <td>PROOFER DOOR LEFT LOWER BRACKET</td> <td>1</td> <td>PZ</td> </tr> </tbody> </table>	Code	Description	Qty	UOM	VM1023A0	PROOFER DOOR RIGHT LOWER BRACKET	1	PZ	VM1024A0	PROOFER DOOR LEFT LOWER BRACKET	1	PZ																				
Code	Description	Qty	UOM																																		
VM1023A0	PROOFER DOOR RIGHT LOWER BRACKET	1	PZ																																		
VM1024A0	PROOFER DOOR LEFT LOWER BRACKET	1	PZ																																		
CR1081A	XV-XL-XB ST. STEEL LEFT HINGE		KCR1080A	RIGHT/LEFT HINGES KIT CR1080A+CR1081A	<table border="1"> <thead> <tr> <th>Code</th> <th>Description</th> <th>Qty</th> <th>UOM</th> </tr> </thead> <tbody> <tr> <td>CR1080A0</td> <td>XV-XL-XB ST. STEEL RIGHT HINGE</td> <td>1</td> <td>PZ</td> </tr> <tr> <td>CR1081A0</td> <td>XV-XL-XB ST. STEEL LEFT HINGE</td> <td>1</td> <td>PZ</td> </tr> <tr> <td>GN1320A0</td> <td>DOOR GLASS HINGE GASKE</td> <td>2</td> <td>PZ</td> </tr> <tr> <td>GN1320A1</td> <td>DOOR GLASS GASKET</td> <td>2</td> <td>PZ</td> </tr> <tr> <td>VI1685A0</td> <td>M6X6 STAINLESS STEEL SCREW</td> <td>4</td> <td>PZ</td> </tr> <tr> <td>VM1790A0</td> <td>HINGE BUSH 12X6.5 DI5.3</td> <td>2</td> <td>PZ</td> </tr> </tbody> </table>	Code	Description	Qty	UOM	CR1080A0	XV-XL-XB ST. STEEL RIGHT HINGE	1	PZ	CR1081A0	XV-XL-XB ST. STEEL LEFT HINGE	1	PZ	GN1320A0	DOOR GLASS HINGE GASKE	2	PZ	GN1320A1	DOOR GLASS GASKET	2	PZ	VI1685A0	M6X6 STAINLESS STEEL SCREW	4	PZ	VM1790A0	HINGE BUSH 12X6.5 DI5.3	2	PZ				
Code	Description	Qty	UOM																																		
CR1080A0	XV-XL-XB ST. STEEL RIGHT HINGE	1	PZ																																		
CR1081A0	XV-XL-XB ST. STEEL LEFT HINGE	1	PZ																																		
GN1320A0	DOOR GLASS HINGE GASKE	2	PZ																																		
GN1320A1	DOOR GLASS GASKET	2	PZ																																		
VI1685A0	M6X6 STAINLESS STEEL SCREW	4	PZ																																		
VM1790A0	HINGE BUSH 12X6.5 DI5.3	2	PZ																																		
GN1320A	DOOR GLASS HINGE GASKET		KGN1320A KCR1081A	DOOR GLASS SEAL 4 PCS. KIT LEFT LOWER HINGE KIT CR1018A	<table border="1"> <thead> <tr> <th>Code</th> <th>Description</th> <th>Qty</th> <th>UOM</th> </tr> </thead> <tbody> <tr> <td>GN1320A0</td> <td>DOOR GLASS HINGE GASKE</td> <td>4</td> <td>PZ</td> </tr> <tr> <td>GN1320A1</td> <td>DOOR GLASS GASKET</td> <td>4</td> <td>PZ</td> </tr> </tbody> </table> <table border="1"> <thead> <tr> <th>Code</th> <th>Description</th> <th>Qty</th> <th>UOM</th> </tr> </thead> <tbody> <tr> <td>CR1081A0</td> <td>XV-XL-XB ST. STEEL LEFT HINGE</td> <td>1</td> <td>PZ</td> </tr> <tr> <td>GN1320A0</td> <td>DOOR GLASS HINGE GASKE</td> <td>1</td> <td>PZ</td> </tr> <tr> <td>VI1083A0</td> <td>SCREW M6X6 TC1/2T INOX A</td> <td>2</td> <td>PZ</td> </tr> <tr> <td>VM1790A0</td> <td>HINGE BUSH 12X6.5 DI5.3</td> <td>1</td> <td>PZ</td> </tr> </tbody> </table>	Code	Description	Qty	UOM	GN1320A0	DOOR GLASS HINGE GASKE	4	PZ	GN1320A1	DOOR GLASS GASKET	4	PZ	Code	Description	Qty	UOM	CR1081A0	XV-XL-XB ST. STEEL LEFT HINGE	1	PZ	GN1320A0	DOOR GLASS HINGE GASKE	1	PZ	VI1083A0	SCREW M6X6 TC1/2T INOX A	2	PZ	VM1790A0	HINGE BUSH 12X6.5 DI5.3	1	PZ
Code	Description	Qty	UOM																																		
GN1320A0	DOOR GLASS HINGE GASKE	4	PZ																																		
GN1320A1	DOOR GLASS GASKET	4	PZ																																		
Code	Description	Qty	UOM																																		
CR1081A0	XV-XL-XB ST. STEEL LEFT HINGE	1	PZ																																		
GN1320A0	DOOR GLASS HINGE GASKE	1	PZ																																		
VI1083A0	SCREW M6X6 TC1/2T INOX A	2	PZ																																		
VM1790A0	HINGE BUSH 12X6.5 DI5.3	1	PZ																																		

COMPONENT			SPARE PART																														
Code	Description	Image	Code	Description	Components list																												
GN1320A	DOOR GLASS HINGE GASKET		KCR1080A	RIGHT/LEFT HINGES KIT CR1080A+CR1081A	<table border="1"> <thead> <tr> <th>Code</th> <th>Description</th> <th>Qty</th> <th>UOM</th> </tr> </thead> <tbody> <tr> <td>CR1080A0</td> <td>XV-XL-XB ST. STEEL RIGHT HINGE</td> <td>1</td> <td>PZ</td> </tr> <tr> <td>CR1081A0</td> <td>XV-XL-XB ST. STEEL LEFT HINGE</td> <td>1</td> <td>PZ</td> </tr> <tr> <td>GN1320A0</td> <td>DOOR GLASS HINGE GASKE</td> <td>2</td> <td>PZ</td> </tr> <tr> <td>GN1320A1</td> <td>DOOR GLASS GASKET</td> <td>2</td> <td>PZ</td> </tr> <tr> <td>V11685A0</td> <td>M6X6 STAINLESS STEEL SCREW</td> <td>4</td> <td>PZ</td> </tr> <tr> <td>VM1790A0</td> <td>HINGE BUSH 12X6.5 DI5.3</td> <td>2</td> <td>PZ</td> </tr> </tbody> </table>	Code	Description	Qty	UOM	CR1080A0	XV-XL-XB ST. STEEL RIGHT HINGE	1	PZ	CR1081A0	XV-XL-XB ST. STEEL LEFT HINGE	1	PZ	GN1320A0	DOOR GLASS HINGE GASKE	2	PZ	GN1320A1	DOOR GLASS GASKET	2	PZ	V11685A0	M6X6 STAINLESS STEEL SCREW	4	PZ	VM1790A0	HINGE BUSH 12X6.5 DI5.3	2	PZ
					Code	Description	Qty	UOM																									
					CR1080A0	XV-XL-XB ST. STEEL RIGHT HINGE	1	PZ																									
					CR1081A0	XV-XL-XB ST. STEEL LEFT HINGE	1	PZ																									
					GN1320A0	DOOR GLASS HINGE GASKE	2	PZ																									
					GN1320A1	DOOR GLASS GASKET	2	PZ																									
					V11685A0	M6X6 STAINLESS STEEL SCREW	4	PZ																									
VM1790A0	HINGE BUSH 12X6.5 DI5.3	2	PZ																														
CR1080A	XV-XL-XB ST. STEEL RIGHT HINGE		KCR1080A	RIGHT/LEFT HINGES KIT CR1080A+CR1081A	<table border="1"> <thead> <tr> <th>Code</th> <th>Description</th> <th>Qty</th> <th>UOM</th> </tr> </thead> <tbody> <tr> <td>CR1080A0</td> <td>XV-XL-XB ST. STEEL RIGHT HINGE</td> <td>1</td> <td>PZ</td> </tr> <tr> <td>CR1081A0</td> <td>XV-XL-XB ST. STEEL LEFT HINGE</td> <td>1</td> <td>PZ</td> </tr> <tr> <td>GN1320A0</td> <td>DOOR GLASS HINGE GASKE</td> <td>2</td> <td>PZ</td> </tr> <tr> <td>GN1320A1</td> <td>DOOR GLASS GASKET</td> <td>2</td> <td>PZ</td> </tr> <tr> <td>V11685A0</td> <td>M6X6 STAINLESS STEEL SCREW</td> <td>4</td> <td>PZ</td> </tr> <tr> <td>VM1790A0</td> <td>HINGE BUSH 12X6.5 DI5.3</td> <td>2</td> <td>PZ</td> </tr> </tbody> </table>	Code	Description	Qty	UOM	CR1080A0	XV-XL-XB ST. STEEL RIGHT HINGE	1	PZ	CR1081A0	XV-XL-XB ST. STEEL LEFT HINGE	1	PZ	GN1320A0	DOOR GLASS HINGE GASKE	2	PZ	GN1320A1	DOOR GLASS GASKET	2	PZ	V11685A0	M6X6 STAINLESS STEEL SCREW	4	PZ	VM1790A0	HINGE BUSH 12X6.5 DI5.3	2	PZ
					Code	Description	Qty	UOM																									
					CR1080A0	XV-XL-XB ST. STEEL RIGHT HINGE	1	PZ																									
					CR1081A0	XV-XL-XB ST. STEEL LEFT HINGE	1	PZ																									
					GN1320A0	DOOR GLASS HINGE GASKE	2	PZ																									
					GN1320A1	DOOR GLASS GASKET	2	PZ																									
					V11685A0	M6X6 STAINLESS STEEL SCREW	4	PZ																									
VM1790A0	HINGE BUSH 12X6.5 DI5.3	2	PZ																														
GN1320A	DOOR GLASS HINGE GASKET		KGN1320A	DOOR GLASS SEAL 4 PCS. KIT	<table border="1"> <thead> <tr> <th>Code</th> <th>Description</th> <th>Qty</th> <th>UOM</th> </tr> </thead> <tbody> <tr> <td>GN1320A0</td> <td>DOOR GLASS HINGE GASKE</td> <td>4</td> <td>PZ</td> </tr> <tr> <td>GN1320A1</td> <td>DOOR GLASS GASKET</td> <td>4</td> <td>PZ</td> </tr> </tbody> </table>	Code	Description	Qty	UOM	GN1320A0	DOOR GLASS HINGE GASKE	4	PZ	GN1320A1	DOOR GLASS GASKET	4	PZ																
					Code	Description	Qty	UOM																									
					GN1320A0	DOOR GLASS HINGE GASKE	4	PZ																									
			GN1320A1	DOOR GLASS GASKET	4	PZ																											
			KCR1081A	LEFT LOWER HINGE KIT CR1018A	<table border="1"> <thead> <tr> <th>Code</th> <th>Description</th> <th>Qty</th> <th>UOM</th> </tr> </thead> <tbody> <tr> <td>CR1081A0</td> <td>XV-XL-XB ST. STEEL LEFT HINGE</td> <td>1</td> <td>PZ</td> </tr> <tr> <td>GN1320A0</td> <td>DOOR GLASS HINGE GASKE</td> <td>1</td> <td>PZ</td> </tr> <tr> <td>V11083A0</td> <td>SCREW M6X6 TC1/2T INOX A</td> <td>2</td> <td>PZ</td> </tr> <tr> <td>VM1790A0</td> <td>HINGE BUSH 12X6.5 DI5.3</td> <td>1</td> <td>PZ</td> </tr> </tbody> </table>	Code	Description	Qty	UOM	CR1081A0	XV-XL-XB ST. STEEL LEFT HINGE	1	PZ	GN1320A0	DOOR GLASS HINGE GASKE	1	PZ	V11083A0	SCREW M6X6 TC1/2T INOX A	2	PZ	VM1790A0	HINGE BUSH 12X6.5 DI5.3	1	PZ								
					Code	Description	Qty	UOM																									
					CR1081A0	XV-XL-XB ST. STEEL LEFT HINGE	1	PZ																									
GN1320A0	DOOR GLASS HINGE GASKE	1			PZ																												
V11083A0	SCREW M6X6 TC1/2T INOX A	2	PZ																														
VM1790A0	HINGE BUSH 12X6.5 DI5.3	1	PZ																														

COMPONENT			SPARE PART																														
Code	Description	Image	Code	Description	Components list																												
GN1320A	DOOR GLASS HINGE GASKET		KCR1080A	RIGHT/LEFT HINGES KIT CR1080A+CR1081A	<table border="1"> <thead> <tr> <th>Code</th> <th>Description</th> <th>Qty</th> <th>UOM</th> </tr> </thead> <tbody> <tr> <td>CR1080A0</td> <td>XV-XL-XB ST. STEEL RIGHT HINGE</td> <td>1</td> <td>PZ</td> </tr> <tr> <td>CR1081A0</td> <td>XV-XL-XB ST. STEEL LEFT HINGE</td> <td>1</td> <td>PZ</td> </tr> <tr> <td>GN1320A0</td> <td>DOOR GLASS HINGE GASKE</td> <td>2</td> <td>PZ</td> </tr> <tr> <td>GN1320A1</td> <td>DOOR GLASS GASKET</td> <td>2</td> <td>PZ</td> </tr> <tr> <td>VI1685A0</td> <td>M6X6 STAINLESS STEEL SCREW</td> <td>4</td> <td>PZ</td> </tr> <tr> <td>VM1790A0</td> <td>HINGE BUSH 12X6.5 DI5.3</td> <td>2</td> <td>PZ</td> </tr> </tbody> </table>	Code	Description	Qty	UOM	CR1080A0	XV-XL-XB ST. STEEL RIGHT HINGE	1	PZ	CR1081A0	XV-XL-XB ST. STEEL LEFT HINGE	1	PZ	GN1320A0	DOOR GLASS HINGE GASKE	2	PZ	GN1320A1	DOOR GLASS GASKET	2	PZ	VI1685A0	M6X6 STAINLESS STEEL SCREW	4	PZ	VM1790A0	HINGE BUSH 12X6.5 DI5.3	2	PZ
					Code	Description	Qty	UOM																									
					CR1080A0	XV-XL-XB ST. STEEL RIGHT HINGE	1	PZ																									
					CR1081A0	XV-XL-XB ST. STEEL LEFT HINGE	1	PZ																									
					GN1320A0	DOOR GLASS HINGE GASKE	2	PZ																									
					GN1320A1	DOOR GLASS GASKET	2	PZ																									
					VI1685A0	M6X6 STAINLESS STEEL SCREW	4	PZ																									
VM1790A0	HINGE BUSH 12X6.5 DI5.3	2	PZ																														
MG1015B	L.MISS/L.MICRO/CH EFTOP HANDLE END		KMG1015B	2 PCS. HANDLE END KIT	<table border="1"> <thead> <tr> <th>Code</th> <th>Description</th> <th>Qty</th> <th>UOM</th> </tr> </thead> <tbody> <tr> <td>MG1015B0</td> <td>L.MISS/L.MICR O/CHEFTOP HANDLE END</td> <td>2</td> <td>PZ</td> </tr> <tr> <td>VI1855A0</td> <td>5X25 SELF-TAPPIN G SCREW</td> <td>2</td> <td>PZ</td> </tr> <tr> <td>VI1870A0</td> <td>50X50 SELF-THREADI NG SCREW FOR PLASTIC</td> <td>2</td> <td>PZ</td> </tr> <tr> <td>VM1025A0</td> <td>Ø16 GREY NYLON LID</td> <td>2</td> <td>PZ</td> </tr> </tbody> </table>	Code	Description	Qty	UOM	MG1015B0	L.MISS/L.MICR O/CHEFTOP HANDLE END	2	PZ	VI1855A0	5X25 SELF-TAPPIN G SCREW	2	PZ	VI1870A0	50X50 SELF-THREADI NG SCREW FOR PLASTIC	2	PZ	VM1025A0	Ø16 GREY NYLON LID	2	PZ								
					Code	Description	Qty	UOM																									
					MG1015B0	L.MISS/L.MICR O/CHEFTOP HANDLE END	2	PZ																									
					VI1855A0	5X25 SELF-TAPPIN G SCREW	2	PZ																									
VI1870A0	50X50 SELF-THREADI NG SCREW FOR PLASTIC	2	PZ																														
VM1025A0	Ø16 GREY NYLON LID	2	PZ																														
VM1720A	XL405 DOOR WASKER		VM1720A0	XL405 DOOR WASKER																													
TB1077A	XLT135/XLT195 Ø18X1 HANDLE TUB		KTB1077A	XLT135/XLT195 HANDLE TUBE KIT	<table border="1"> <thead> <tr> <th>Code</th> <th>Description</th> <th>Qty</th> <th>UOM</th> </tr> </thead> <tbody> <tr> <td>TB1077A0</td> <td>XLT135/XLT19 5 Ø18X1 HANDLE TUBE</td> <td>1</td> <td>PZ</td> </tr> <tr> <td>VI1220A1</td> <td>4,2X12 TCB SELF-TAPPIN G SCREW</td> <td>4</td> <td>PZ</td> </tr> <tr> <td>VM1794A0</td> <td>250X4.8 PA66 BLACK CLAMP</td> <td>2</td> <td>PZ</td> </tr> <tr> <td>VM2103A0</td> <td>CLAMP LOCK</td> <td>2</td> <td>PZ</td> </tr> </tbody> </table>	Code	Description	Qty	UOM	TB1077A0	XLT135/XLT19 5 Ø18X1 HANDLE TUBE	1	PZ	VI1220A1	4,2X12 TCB SELF-TAPPIN G SCREW	4	PZ	VM1794A0	250X4.8 PA66 BLACK CLAMP	2	PZ	VM2103A0	CLAMP LOCK	2	PZ								
					Code	Description	Qty	UOM																									
					TB1077A0	XLT135/XLT19 5 Ø18X1 HANDLE TUBE	1	PZ																									
					VI1220A1	4,2X12 TCB SELF-TAPPIN G SCREW	4	PZ																									
VM1794A0	250X4.8 PA66 BLACK CLAMP	2	PZ																														
VM2103A0	CLAMP LOCK	2	PZ																														



COMPONENT			SPARE PART																																																						
Code	Description	Image	Code	Description	Components list																																																				
0H4540A	DOOR PLATES MAGNET XL405		0H4540A0	DOOR PLATES MAGNET XL405																																																					
GN1330A	FERRITIC PLATE GASKET XL405		KVT1086BR	XLT195/XLT193 RIGHT COMPLETE DOOR KIT	<table border="1"> <thead> <tr> <th>Code</th> <th>Description</th> <th>Qty</th> <th>UOM</th> </tr> </thead> <tbody> <tr> <td>0H4540A0</td> <td>DOOR PLATES MAGNET XL40</td> <td>1</td> <td>PZ</td> </tr> <tr> <td>CR1080A0</td> <td>XV-XL-XB ST. STEEL RIGHT HINGE</td> <td>1</td> <td>PZ</td> </tr> <tr> <td>CR1081A0</td> <td>XV-XL-XB ST. STEEL LEFT HINGE</td> <td>1</td> <td>PZ</td> </tr> <tr> <td>GN1320A0</td> <td>DOOR GLASS HINGE GASKE</td> <td>2</td> <td>PZ</td> </tr> <tr> <td>GN1320A1</td> <td>DOOR GLASS GASKET</td> <td>2</td> <td>PZ</td> </tr> <tr> <td>GN1330A0</td> <td>FERRITIC PLATE GASKET XL40</td> <td>1</td> <td>PZ</td> </tr> <tr> <td>MG1015B0</td> <td>L.MISS/L.MICR O/CHEFTOP HANDLE END</td> <td>2</td> <td>PZ</td> </tr> <tr> <td>TB1077A0</td> <td>XLT135/XLT19 5 Ø18X1 HANDLE TUBE</td> <td>1</td> <td>PZ</td> </tr> <tr> <td>VI1685A0</td> <td>M6X6 STAINLESS STEEL SCREW</td> <td>4</td> <td>PZ</td> </tr> <tr> <td>VI1930A0</td> <td>5X25 ST. STEEL SCREW CHIP</td> <td>2</td> <td>PZ</td> </tr> <tr> <td>VM1720A0</td> <td>XL405 DOOR WASKER</td> <td>1</td> <td>PZ</td> </tr> <tr> <td>VT1086B0</td> <td>XLT195/XLT19 3 DOOR BLACK GLASS 399X661</td> <td>1</td> <td>PZ</td> </tr> </tbody> </table>	Code	Description	Qty	UOM	0H4540A0	DOOR PLATES MAGNET XL40	1	PZ	CR1080A0	XV-XL-XB ST. STEEL RIGHT HINGE	1	PZ	CR1081A0	XV-XL-XB ST. STEEL LEFT HINGE	1	PZ	GN1320A0	DOOR GLASS HINGE GASKE	2	PZ	GN1320A1	DOOR GLASS GASKET	2	PZ	GN1330A0	FERRITIC PLATE GASKET XL40	1	PZ	MG1015B0	L.MISS/L.MICR O/CHEFTOP HANDLE END	2	PZ	TB1077A0	XLT135/XLT19 5 Ø18X1 HANDLE TUBE	1	PZ	VI1685A0	M6X6 STAINLESS STEEL SCREW	4	PZ	VI1930A0	5X25 ST. STEEL SCREW CHIP	2	PZ	VM1720A0	XL405 DOOR WASKER	1	PZ	VT1086B0	XLT195/XLT19 3 DOOR BLACK GLASS 399X661	1	PZ
Code	Description	Qty	UOM																																																						
0H4540A0	DOOR PLATES MAGNET XL40	1	PZ																																																						
CR1080A0	XV-XL-XB ST. STEEL RIGHT HINGE	1	PZ																																																						
CR1081A0	XV-XL-XB ST. STEEL LEFT HINGE	1	PZ																																																						
GN1320A0	DOOR GLASS HINGE GASKE	2	PZ																																																						
GN1320A1	DOOR GLASS GASKET	2	PZ																																																						
GN1330A0	FERRITIC PLATE GASKET XL40	1	PZ																																																						
MG1015B0	L.MISS/L.MICR O/CHEFTOP HANDLE END	2	PZ																																																						
TB1077A0	XLT135/XLT19 5 Ø18X1 HANDLE TUBE	1	PZ																																																						
VI1685A0	M6X6 STAINLESS STEEL SCREW	4	PZ																																																						
VI1930A0	5X25 ST. STEEL SCREW CHIP	2	PZ																																																						
VM1720A0	XL405 DOOR WASKER	1	PZ																																																						
VT1086B0	XLT195/XLT19 3 DOOR BLACK GLASS 399X661	1	PZ																																																						
			KVT1086BL	XLT195/XLT193 LEFT COMPLETE DOOR KIT	<table border="1"> <thead> <tr> <th>Code</th> <th>Description</th> <th>Qty</th> <th>UOM</th> </tr> </thead> <tbody> <tr> <td>0H4540A0</td> <td>DOOR PLATES MAGNET XL40</td> <td>1</td> <td>PZ</td> </tr> <tr> <td>CR1080A0</td> <td>XV-XL-XB ST. STEEL RIGHT HINGE</td> <td>1</td> <td>PZ</td> </tr> <tr> <td>CR1081A0</td> <td>XV-XL-XB ST. STEEL LEFT HINGE</td> <td>1</td> <td>PZ</td> </tr> <tr> <td>GN1320A0</td> <td>DOOR GLASS HINGE GASKE</td> <td>2</td> <td>PZ</td> </tr> </tbody> </table>	Code	Description	Qty	UOM	0H4540A0	DOOR PLATES MAGNET XL40	1	PZ	CR1080A0	XV-XL-XB ST. STEEL RIGHT HINGE	1	PZ	CR1081A0	XV-XL-XB ST. STEEL LEFT HINGE	1	PZ	GN1320A0	DOOR GLASS HINGE GASKE	2	PZ																																
Code	Description	Qty	UOM																																																						
0H4540A0	DOOR PLATES MAGNET XL40	1	PZ																																																						
CR1080A0	XV-XL-XB ST. STEEL RIGHT HINGE	1	PZ																																																						
CR1081A0	XV-XL-XB ST. STEEL LEFT HINGE	1	PZ																																																						
GN1320A0	DOOR GLASS HINGE GASKE	2	PZ																																																						

COMPONENT			SPARE PART																																															
Code	Description	Image	Code	Description	Components list																																													
GN1330A	FERRITIC PLATE GASKET XL405		KVT1086BL	XLT195/XLT193 LEFT COMPLETE DOOR KIT	<table border="1"> <thead> <tr> <th>Code</th> <th>Description</th> <th>Qty</th> <th>UOM</th> </tr> </thead> <tbody> <tr> <td>GN1320A1</td> <td>DOOR GLASS GASKET</td> <td>2</td> <td>PZ</td> </tr> <tr> <td>GN1330A0</td> <td>FERRITIC PLATE GASKET XL40</td> <td>1</td> <td>PZ</td> </tr> <tr> <td>MG1015B0</td> <td>L.MISS/L.MICR O/CHEFTOP HANDLE END</td> <td>2</td> <td>PZ</td> </tr> <tr> <td>TB1077A0</td> <td>XLT135/XLT19 5 Ø18X1 HANDLE TUBE</td> <td>1</td> <td>PZ</td> </tr> <tr> <td>VI1685A0</td> <td>M6X6 STAINLESS STEEL SCREW</td> <td>4</td> <td>PZ</td> </tr> <tr> <td>VI1930A0</td> <td>5X25 ST. STEEL SCREW CHIP</td> <td>2</td> <td>PZ</td> </tr> <tr> <td>VM1720A0</td> <td>XL405 DOOR WASKER</td> <td>1</td> <td>PZ</td> </tr> <tr> <td>VT1086B0</td> <td>XLT195/XLT19 3 DOOR BLACK GLASS 399X661</td> <td>1</td> <td>PZ</td> </tr> </tbody> </table>	Code	Description	Qty	UOM	GN1320A1	DOOR GLASS GASKET	2	PZ	GN1330A0	FERRITIC PLATE GASKET XL40	1	PZ	MG1015B0	L.MISS/L.MICR O/CHEFTOP HANDLE END	2	PZ	TB1077A0	XLT135/XLT19 5 Ø18X1 HANDLE TUBE	1	PZ	VI1685A0	M6X6 STAINLESS STEEL SCREW	4	PZ	VI1930A0	5X25 ST. STEEL SCREW CHIP	2	PZ	VM1720A0	XL405 DOOR WASKER	1	PZ	VT1086B0	XLT195/XLT19 3 DOOR BLACK GLASS 399X661	1	PZ									
			Code	Description	Qty	UOM																																												
GN1320A1	DOOR GLASS GASKET	2	PZ																																															
GN1330A0	FERRITIC PLATE GASKET XL40	1	PZ																																															
MG1015B0	L.MISS/L.MICR O/CHEFTOP HANDLE END	2	PZ																																															
TB1077A0	XLT135/XLT19 5 Ø18X1 HANDLE TUBE	1	PZ																																															
VI1685A0	M6X6 STAINLESS STEEL SCREW	4	PZ																																															
VI1930A0	5X25 ST. STEEL SCREW CHIP	2	PZ																																															
VM1720A0	XL405 DOOR WASKER	1	PZ																																															
VT1086B0	XLT195/XLT19 3 DOOR BLACK GLASS 399X661	1	PZ																																															
KVT1076BR	XLT135/XLT133 RIGHT COMPLETE DOOR KIT	<table border="1"> <thead> <tr> <th>Code</th> <th>Description</th> <th>Qty</th> <th>UOM</th> </tr> </thead> <tbody> <tr> <td>OH4540A0</td> <td>DOOR PLATES MAGNET XL40</td> <td>1</td> <td>PZ</td> </tr> <tr> <td>CR1080A0</td> <td>XV-XL-XB ST. STEEL RIGHT HINGE</td> <td>1</td> <td>PZ</td> </tr> <tr> <td>CR1081A0</td> <td>XV-XL-XB ST. STEEL LEFT HINGE</td> <td>1</td> <td>PZ</td> </tr> <tr> <td>GN1320A0</td> <td>DOOR GLASS HINGE GASKE</td> <td>2</td> <td>PZ</td> </tr> <tr> <td>GN1320A1</td> <td>DOOR GLASS GASKET</td> <td>2</td> <td>PZ</td> </tr> <tr> <td>GN1330A0</td> <td>FERRITIC PLATE GASKET XL40</td> <td>1</td> <td>PZ</td> </tr> <tr> <td>IP1385A1</td> <td>CORNER POLYSTYREN E PACKING 110X80X2000</td> <td>1.400</td> <td>M</td> </tr> <tr> <td>IP1508A0</td> <td></td> <td>0.300</td> <td>PZ</td> </tr> <tr> <td>IP1508A1</td> <td>POLYSTYREN E U SHAPED PROFILE 2000X60X60</td> <td>2</td> <td>M</td> </tr> <tr> <td>MG1015B0</td> <td>L.MISS/L.MICR O/CHEFTOP HANDLE END</td> <td>2</td> <td>PZ</td> </tr> <tr> <td>TB1077A0</td> <td>XLT135/XLT19 5 Ø18X1 HANDLE TUBE</td> <td>1</td> <td>PZ</td> </tr> </tbody> </table>	Code	Description	Qty	UOM	OH4540A0	DOOR PLATES MAGNET XL40	1	PZ	CR1080A0	XV-XL-XB ST. STEEL RIGHT HINGE	1	PZ	CR1081A0	XV-XL-XB ST. STEEL LEFT HINGE	1	PZ	GN1320A0	DOOR GLASS HINGE GASKE	2	PZ	GN1320A1	DOOR GLASS GASKET	2	PZ	GN1330A0	FERRITIC PLATE GASKET XL40	1	PZ	IP1385A1	CORNER POLYSTYREN E PACKING 110X80X2000	1.400	M	IP1508A0		0.300	PZ	IP1508A1	POLYSTYREN E U SHAPED PROFILE 2000X60X60	2	M	MG1015B0	L.MISS/L.MICR O/CHEFTOP HANDLE END	2	PZ	TB1077A0	XLT135/XLT19 5 Ø18X1 HANDLE TUBE	1	PZ
Code	Description	Qty	UOM																																															
OH4540A0	DOOR PLATES MAGNET XL40	1	PZ																																															
CR1080A0	XV-XL-XB ST. STEEL RIGHT HINGE	1	PZ																																															
CR1081A0	XV-XL-XB ST. STEEL LEFT HINGE	1	PZ																																															
GN1320A0	DOOR GLASS HINGE GASKE	2	PZ																																															
GN1320A1	DOOR GLASS GASKET	2	PZ																																															
GN1330A0	FERRITIC PLATE GASKET XL40	1	PZ																																															
IP1385A1	CORNER POLYSTYREN E PACKING 110X80X2000	1.400	M																																															
IP1508A0		0.300	PZ																																															
IP1508A1	POLYSTYREN E U SHAPED PROFILE 2000X60X60	2	M																																															
MG1015B0	L.MISS/L.MICR O/CHEFTOP HANDLE END	2	PZ																																															
TB1077A0	XLT135/XLT19 5 Ø18X1 HANDLE TUBE	1	PZ																																															

COMPONENT			SPARE PART																																																															
Code	Description	Image	Code	Description	Components list																																																													
GN1330A	FERRITIC PLATE GASKET XL405		KVT1076BR	XLT135/XLT133 RIGHT COMPLETE DOOR KIT	<table border="1"> <thead> <tr> <th>Code</th> <th>Description</th> <th>Qty</th> <th>UOM</th> </tr> </thead> <tbody> <tr> <td>VI1685A0</td> <td>M6X6 STAINLESS STEEL SCREW</td> <td>4</td> <td>PZ</td> </tr> <tr> <td>VI1930A0</td> <td>5X25 ST. STEEL SCREW CHIP</td> <td>2</td> <td>PZ</td> </tr> <tr> <td>VM1059A1</td> <td>HEAT SHRINK FILM H800</td> <td>1.500</td> <td>M</td> </tr> <tr> <td>VM1720A0</td> <td>XL405 DOOR WASKER</td> <td>1</td> <td>PZ</td> </tr> <tr> <td>VT1076B0</td> <td>XLT135/XLT13 3 BLACK DOOR GLASS 299X661</td> <td>1</td> <td>PZ</td> </tr> </tbody> </table>	Code	Description	Qty	UOM	VI1685A0	M6X6 STAINLESS STEEL SCREW	4	PZ	VI1930A0	5X25 ST. STEEL SCREW CHIP	2	PZ	VM1059A1	HEAT SHRINK FILM H800	1.500	M	VM1720A0	XL405 DOOR WASKER	1	PZ	VT1076B0	XLT135/XLT13 3 BLACK DOOR GLASS 299X661	1	PZ																																					
			Code	Description	Qty	UOM																																																												
VI1685A0	M6X6 STAINLESS STEEL SCREW	4	PZ																																																															
VI1930A0	5X25 ST. STEEL SCREW CHIP	2	PZ																																																															
VM1059A1	HEAT SHRINK FILM H800	1.500	M																																																															
VM1720A0	XL405 DOOR WASKER	1	PZ																																																															
VT1076B0	XLT135/XLT13 3 BLACK DOOR GLASS 299X661	1	PZ																																																															
KVT1076BL	XLT135/XLT133 LEFT COMPLETE DOOR KIT	<table border="1"> <thead> <tr> <th>Code</th> <th>Description</th> <th>Qty</th> <th>UOM</th> </tr> </thead> <tbody> <tr> <td>OH4540A0</td> <td>DOOR PLATES MAGNET XL40</td> <td>1</td> <td>PZ</td> </tr> <tr> <td>CR1080A0</td> <td>XV-XL-XB ST. STEEL RIGHT HINGE</td> <td>1</td> <td>PZ</td> </tr> <tr> <td>CR1081A0</td> <td>XV-XL-XB ST. STEEL LEFT HINGE</td> <td>1</td> <td>PZ</td> </tr> <tr> <td>GN1320A0</td> <td>DOOR GLASS HINGE GASKE</td> <td>2</td> <td>PZ</td> </tr> <tr> <td>GN1320A1</td> <td>DOOR GLASS GASKET</td> <td>2</td> <td>PZ</td> </tr> <tr> <td>GN1330A0</td> <td>FERRITIC PLATE GASKET XL40</td> <td>1</td> <td>PZ</td> </tr> <tr> <td>IP1385A1</td> <td>CORNER POLYSTYREN E PACKING 110X80X2000</td> <td>1.400</td> <td>M</td> </tr> <tr> <td>IP1508A1</td> <td>POLYSTYREN E U SHAPED PROFILE 2000X60X60</td> <td>0.300</td> <td>M</td> </tr> <tr> <td>MG1015B0</td> <td>L.MISS/L.MICR O/CHEFTOP HANDLE END</td> <td>2</td> <td>PZ</td> </tr> <tr> <td>TB1077A0</td> <td>XLT135/XLT19 5 Ø18X1 HANDLE TUBE</td> <td>1</td> <td>PZ</td> </tr> <tr> <td>VI1685A0</td> <td>M6X6 STAINLESS STEEL SCREW</td> <td>4</td> <td>PZ</td> </tr> <tr> <td>VI1930A0</td> <td>5X25 ST. STEEL SCREW CHIP</td> <td>2</td> <td>PZ</td> </tr> <tr> <td>VM1059A1</td> <td>HEAT SHRINK FILM H800</td> <td>1.500</td> <td>M</td> </tr> <tr> <td>VM1720A0</td> <td>XL405 DOOR WASKER</td> <td>1</td> <td>PZ</td> </tr> <tr> <td>VT1076B0</td> <td>XLT135/XLT13 3 BLACK DOOR GLASS 299X661</td> <td>1</td> <td>PZ</td> </tr> </tbody> </table>	Code	Description	Qty	UOM	OH4540A0	DOOR PLATES MAGNET XL40	1	PZ	CR1080A0	XV-XL-XB ST. STEEL RIGHT HINGE	1	PZ	CR1081A0	XV-XL-XB ST. STEEL LEFT HINGE	1	PZ	GN1320A0	DOOR GLASS HINGE GASKE	2	PZ	GN1320A1	DOOR GLASS GASKET	2	PZ	GN1330A0	FERRITIC PLATE GASKET XL40	1	PZ	IP1385A1	CORNER POLYSTYREN E PACKING 110X80X2000	1.400	M	IP1508A1	POLYSTYREN E U SHAPED PROFILE 2000X60X60	0.300	M	MG1015B0	L.MISS/L.MICR O/CHEFTOP HANDLE END	2	PZ	TB1077A0	XLT135/XLT19 5 Ø18X1 HANDLE TUBE	1	PZ	VI1685A0	M6X6 STAINLESS STEEL SCREW	4	PZ	VI1930A0	5X25 ST. STEEL SCREW CHIP	2	PZ	VM1059A1	HEAT SHRINK FILM H800	1.500	M	VM1720A0	XL405 DOOR WASKER	1	PZ	VT1076B0	XLT135/XLT13 3 BLACK DOOR GLASS 299X661	1	PZ
Code	Description	Qty	UOM																																																															
OH4540A0	DOOR PLATES MAGNET XL40	1	PZ																																																															
CR1080A0	XV-XL-XB ST. STEEL RIGHT HINGE	1	PZ																																																															
CR1081A0	XV-XL-XB ST. STEEL LEFT HINGE	1	PZ																																																															
GN1320A0	DOOR GLASS HINGE GASKE	2	PZ																																																															
GN1320A1	DOOR GLASS GASKET	2	PZ																																																															
GN1330A0	FERRITIC PLATE GASKET XL40	1	PZ																																																															
IP1385A1	CORNER POLYSTYREN E PACKING 110X80X2000	1.400	M																																																															
IP1508A1	POLYSTYREN E U SHAPED PROFILE 2000X60X60	0.300	M																																																															
MG1015B0	L.MISS/L.MICR O/CHEFTOP HANDLE END	2	PZ																																																															
TB1077A0	XLT135/XLT19 5 Ø18X1 HANDLE TUBE	1	PZ																																																															
VI1685A0	M6X6 STAINLESS STEEL SCREW	4	PZ																																																															
VI1930A0	5X25 ST. STEEL SCREW CHIP	2	PZ																																																															
VM1059A1	HEAT SHRINK FILM H800	1.500	M																																																															
VM1720A0	XL405 DOOR WASKER	1	PZ																																																															
VT1076B0	XLT135/XLT13 3 BLACK DOOR GLASS 299X661	1	PZ																																																															



COMPONENT			SPARE PART																																																																																													
Code	Description	Image	Code	Description	Components list																																																																																											
GN1330A	FERRITIC PLATE GASKET XL405		KDR1210AR	XL405 COMPLETE RIGHT DOOR	<table border="1"> <thead> <tr> <th>Code</th> <th>Description</th> <th>Qty</th> <th>UOM</th> </tr> </thead> <tbody> <tr> <td>0H4530C0</td> <td>RIGHT DOOR DRIPPING TRAY XL415</td> <td>1</td> <td>PZ</td> </tr> <tr> <td>0H4540A0</td> <td>DOOR PLATES MAGNET XL40</td> <td>1</td> <td>PZ</td> </tr> <tr> <td>CR1080A0</td> <td>XV-XL-XB ST. STEEL RIGHT HINGE</td> <td>1</td> <td>PZ</td> </tr> <tr> <td>CR1081A0</td> <td>XV-XL-XB ST. STEEL LEFT HINGE</td> <td>1</td> <td>PZ</td> </tr> <tr> <td>GN1320A0</td> <td>DOOR GLASS HINGE GASKE</td> <td>2</td> <td>PZ</td> </tr> <tr> <td>GN1320A1</td> <td>DOOR GLASS GASKET</td> <td>2</td> <td>PZ</td> </tr> <tr> <td>GN1330A0</td> <td>FERRITIC PLATE GASKET XL40</td> <td>1</td> <td>PZ</td> </tr> <tr> <td>IP1385A1</td> <td>CORNER POLYSTYREN E PACKING 110X80X2000</td> <td>1.300</td> <td>M</td> </tr> <tr> <td>IP1508A0</td> <td></td> <td>0.570</td> <td>PZ</td> </tr> <tr> <td>IP1508A1</td> <td>POLYSTYREN E U SHAPED PROFILE 2000X60X60</td> <td>2</td> <td>M</td> </tr> <tr> <td>MG1015B0</td> <td>L.MISS/L.MICR O/CHEFTOP HANDLE END</td> <td>2</td> <td>PZ</td> </tr> <tr> <td>TB1730A0</td> <td>XL405-413-415 HANDLE TUBE</td> <td>1</td> <td>PZ</td> </tr> <tr> <td>VI1685A0</td> <td>M6X6 STAINLESS STEEL SCREW</td> <td>4</td> <td>PZ</td> </tr> <tr> <td>VI1930A0</td> <td>5X25 ST. STEEL SCREW CHIP</td> <td>2</td> <td>PZ</td> </tr> <tr> <td>VM1059A1</td> <td>HEAT SHRINK FILM H800</td> <td>1.300</td> <td>M</td> </tr> <tr> <td>VM1720A0</td> <td>XL405 DOOR WASKER</td> <td>1</td> <td>PZ</td> </tr> <tr> <td>VM1790A0</td> <td>HINGE BUSH 12X6.5 DI5.3</td> <td>2</td> <td>PZ</td> </tr> <tr> <td>VT1210A0</td> <td>XL405-413-415 DOOR GLASS</td> <td>1</td> <td>PZ</td> </tr> </tbody> </table>	Code	Description	Qty	UOM	0H4530C0	RIGHT DOOR DRIPPING TRAY XL415	1	PZ	0H4540A0	DOOR PLATES MAGNET XL40	1	PZ	CR1080A0	XV-XL-XB ST. STEEL RIGHT HINGE	1	PZ	CR1081A0	XV-XL-XB ST. STEEL LEFT HINGE	1	PZ	GN1320A0	DOOR GLASS HINGE GASKE	2	PZ	GN1320A1	DOOR GLASS GASKET	2	PZ	GN1330A0	FERRITIC PLATE GASKET XL40	1	PZ	IP1385A1	CORNER POLYSTYREN E PACKING 110X80X2000	1.300	M	IP1508A0		0.570	PZ	IP1508A1	POLYSTYREN E U SHAPED PROFILE 2000X60X60	2	M	MG1015B0	L.MISS/L.MICR O/CHEFTOP HANDLE END	2	PZ	TB1730A0	XL405-413-415 HANDLE TUBE	1	PZ	VI1685A0	M6X6 STAINLESS STEEL SCREW	4	PZ	VI1930A0	5X25 ST. STEEL SCREW CHIP	2	PZ	VM1059A1	HEAT SHRINK FILM H800	1.300	M	VM1720A0	XL405 DOOR WASKER	1	PZ	VM1790A0	HINGE BUSH 12X6.5 DI5.3	2	PZ	VT1210A0	XL405-413-415 DOOR GLASS	1	PZ	KDR1210AL	XL405 COMPLETE LEFT DOOR	<table border="1"> <thead> <tr> <th>Code</th> <th>Description</th> <th>Qty</th> <th>UOM</th> </tr> </thead> <tbody> <tr> <td>0H4535C0</td> <td>LEFT DOOR DRIPPING TRAY XL415</td> <td>1</td> <td>PZ</td> </tr> <tr> <td>0H4540A0</td> <td>DOOR PLATES MAGNET XL40</td> <td>1</td> <td>PZ</td> </tr> </tbody> </table>	Code	Description	Qty	UOM	0H4535C0	LEFT DOOR DRIPPING TRAY XL415	1	PZ	0H4540A0	DOOR PLATES MAGNET XL40	1	PZ
			Code	Description	Qty	UOM																																																																																										
0H4530C0	RIGHT DOOR DRIPPING TRAY XL415	1	PZ																																																																																													
0H4540A0	DOOR PLATES MAGNET XL40	1	PZ																																																																																													
CR1080A0	XV-XL-XB ST. STEEL RIGHT HINGE	1	PZ																																																																																													
CR1081A0	XV-XL-XB ST. STEEL LEFT HINGE	1	PZ																																																																																													
GN1320A0	DOOR GLASS HINGE GASKE	2	PZ																																																																																													
GN1320A1	DOOR GLASS GASKET	2	PZ																																																																																													
GN1330A0	FERRITIC PLATE GASKET XL40	1	PZ																																																																																													
IP1385A1	CORNER POLYSTYREN E PACKING 110X80X2000	1.300	M																																																																																													
IP1508A0		0.570	PZ																																																																																													
IP1508A1	POLYSTYREN E U SHAPED PROFILE 2000X60X60	2	M																																																																																													
MG1015B0	L.MISS/L.MICR O/CHEFTOP HANDLE END	2	PZ																																																																																													
TB1730A0	XL405-413-415 HANDLE TUBE	1	PZ																																																																																													
VI1685A0	M6X6 STAINLESS STEEL SCREW	4	PZ																																																																																													
VI1930A0	5X25 ST. STEEL SCREW CHIP	2	PZ																																																																																													
VM1059A1	HEAT SHRINK FILM H800	1.300	M																																																																																													
VM1720A0	XL405 DOOR WASKER	1	PZ																																																																																													
VM1790A0	HINGE BUSH 12X6.5 DI5.3	2	PZ																																																																																													
VT1210A0	XL405-413-415 DOOR GLASS	1	PZ																																																																																													
Code	Description	Qty	UOM																																																																																													
0H4535C0	LEFT DOOR DRIPPING TRAY XL415	1	PZ																																																																																													
0H4540A0	DOOR PLATES MAGNET XL40	1	PZ																																																																																													

COMPONENT			SPARE PART																																																																						
Code	Description	Image	Code	Description	Components list																																																																				
GN1330A	FERRITIC PLATE GASKET XL405		KDR1210AL	XL405 COMPLETE LEFT DOOR	<table border="1"> <thead> <tr> <th>Code</th> <th>Description</th> <th>Qty</th> <th>UOM</th> </tr> </thead> <tbody> <tr> <td>CR1080A0</td> <td>XV-XL-XB ST. STEEL RIGHT HINGE</td> <td>1</td> <td>PZ</td> </tr> <tr> <td>CR1081A0</td> <td>XV-XL-XB ST. STEEL LEFT HINGE</td> <td>1</td> <td>PZ</td> </tr> <tr> <td>GN1320A0</td> <td>DOOR GLASS HINGE GASKE</td> <td>2</td> <td>PZ</td> </tr> <tr> <td>GN1320A1</td> <td>DOOR GLASS GASKET</td> <td>2</td> <td>PZ</td> </tr> <tr> <td>GN1330A0</td> <td>FERRITIC PLATE GASKET XL40</td> <td>1</td> <td>PZ</td> </tr> <tr> <td>IP1385A1</td> <td>CORNER POLYSTYREN E PACKING 110X80X2000</td> <td>1.300</td> <td>M</td> </tr> <tr> <td>IP1508A0</td> <td></td> <td>0.570</td> <td>PZ</td> </tr> <tr> <td>IP1508A1</td> <td>POLYSTYREN E U SHAPED PROFILE 2000X60X60</td> <td>2</td> <td>M</td> </tr> <tr> <td>MG1015B0</td> <td>L.MISS/L.MICR O/CHEFTOP HANDLE END</td> <td>2</td> <td>PZ</td> </tr> <tr> <td>TB1730A0</td> <td>XL405-413-415 HANDLE TUBE</td> <td>1</td> <td>PZ</td> </tr> <tr> <td>VI1685A0</td> <td>M6X6 STAINLESS STEEL SCREW</td> <td>4</td> <td>PZ</td> </tr> <tr> <td>VI1930A0</td> <td>5X25 ST. STEEL SCREW CHIP</td> <td>2</td> <td>PZ</td> </tr> <tr> <td>VM1059A1</td> <td>HEAT SHRINK FILM H800</td> <td>1.300</td> <td>M</td> </tr> <tr> <td>VM1720A0</td> <td>XL405 DOOR WASKER</td> <td>1</td> <td>PZ</td> </tr> <tr> <td>VM1790A0</td> <td>HINGE BUSH 12X6.5 DI5.3</td> <td>2</td> <td>PZ</td> </tr> <tr> <td>VT1210A0</td> <td>XL405-413-415 DOOR GLASS</td> <td>1</td> <td>PZ</td> </tr> </tbody> </table>	Code	Description	Qty	UOM	CR1080A0	XV-XL-XB ST. STEEL RIGHT HINGE	1	PZ	CR1081A0	XV-XL-XB ST. STEEL LEFT HINGE	1	PZ	GN1320A0	DOOR GLASS HINGE GASKE	2	PZ	GN1320A1	DOOR GLASS GASKET	2	PZ	GN1330A0	FERRITIC PLATE GASKET XL40	1	PZ	IP1385A1	CORNER POLYSTYREN E PACKING 110X80X2000	1.300	M	IP1508A0		0.570	PZ	IP1508A1	POLYSTYREN E U SHAPED PROFILE 2000X60X60	2	M	MG1015B0	L.MISS/L.MICR O/CHEFTOP HANDLE END	2	PZ	TB1730A0	XL405-413-415 HANDLE TUBE	1	PZ	VI1685A0	M6X6 STAINLESS STEEL SCREW	4	PZ	VI1930A0	5X25 ST. STEEL SCREW CHIP	2	PZ	VM1059A1	HEAT SHRINK FILM H800	1.300	M	VM1720A0	XL405 DOOR WASKER	1	PZ	VM1790A0	HINGE BUSH 12X6.5 DI5.3	2	PZ	VT1210A0	XL405-413-415 DOOR GLASS	1	PZ
					Code	Description	Qty	UOM																																																																	
					CR1080A0	XV-XL-XB ST. STEEL RIGHT HINGE	1	PZ																																																																	
					CR1081A0	XV-XL-XB ST. STEEL LEFT HINGE	1	PZ																																																																	
					GN1320A0	DOOR GLASS HINGE GASKE	2	PZ																																																																	
					GN1320A1	DOOR GLASS GASKET	2	PZ																																																																	
					GN1330A0	FERRITIC PLATE GASKET XL40	1	PZ																																																																	
					IP1385A1	CORNER POLYSTYREN E PACKING 110X80X2000	1.300	M																																																																	
					IP1508A0		0.570	PZ																																																																	
					IP1508A1	POLYSTYREN E U SHAPED PROFILE 2000X60X60	2	M																																																																	
					MG1015B0	L.MISS/L.MICR O/CHEFTOP HANDLE END	2	PZ																																																																	
					TB1730A0	XL405-413-415 HANDLE TUBE	1	PZ																																																																	
					VI1685A0	M6X6 STAINLESS STEEL SCREW	4	PZ																																																																	
					VI1930A0	5X25 ST. STEEL SCREW CHIP	2	PZ																																																																	
					VM1059A1	HEAT SHRINK FILM H800	1.300	M																																																																	
VM1720A0	XL405 DOOR WASKER	1	PZ																																																																						
VM1790A0	HINGE BUSH 12X6.5 DI5.3	2	PZ																																																																						
VT1210A0	XL405-413-415 DOOR GLASS	1	PZ																																																																						
VT1086B	XLT195\XLT193 DOOR BLACK GLASS 399X661		KVT1086BR	XLT195/XLT193 RIGHT COMPLETE DOOR KIT	<table border="1"> <thead> <tr> <th>Code</th> <th>Description</th> <th>Qty</th> <th>UOM</th> </tr> </thead> <tbody> <tr> <td>OH4540A0</td> <td>DOOR PLATES MAGNET XL40</td> <td>1</td> <td>PZ</td> </tr> <tr> <td>CR1080A0</td> <td>XV-XL-XB ST. STEEL RIGHT HINGE</td> <td>1</td> <td>PZ</td> </tr> <tr> <td>CR1081A0</td> <td>XV-XL-XB ST. STEEL LEFT HINGE</td> <td>1</td> <td>PZ</td> </tr> <tr> <td>GN1320A0</td> <td>DOOR GLASS HINGE GASKE</td> <td>2</td> <td>PZ</td> </tr> <tr> <td>GN1320A1</td> <td>DOOR GLASS GASKET</td> <td>2</td> <td>PZ</td> </tr> </tbody> </table>	Code	Description	Qty	UOM	OH4540A0	DOOR PLATES MAGNET XL40	1	PZ	CR1080A0	XV-XL-XB ST. STEEL RIGHT HINGE	1	PZ	CR1081A0	XV-XL-XB ST. STEEL LEFT HINGE	1	PZ	GN1320A0	DOOR GLASS HINGE GASKE	2	PZ	GN1320A1	DOOR GLASS GASKET	2	PZ																																												
					Code	Description	Qty	UOM																																																																	
					OH4540A0	DOOR PLATES MAGNET XL40	1	PZ																																																																	
					CR1080A0	XV-XL-XB ST. STEEL RIGHT HINGE	1	PZ																																																																	
					CR1081A0	XV-XL-XB ST. STEEL LEFT HINGE	1	PZ																																																																	
					GN1320A0	DOOR GLASS HINGE GASKE	2	PZ																																																																	
GN1320A1	DOOR GLASS GASKET	2	PZ																																																																						

COMPONENT			SPARE PART																																																			
Code	Description	Image	Code	Description	Components list																																																	
VT1086B	XLT195\XLT193 DOOR BLACK GLASS 399X661		KVT1086BR	XLT195/XLT193 RIGHT COMPLETE DOOR KIT	<table border="1"> <thead> <tr> <th>Code</th> <th>Description</th> <th>Qty</th> <th>UOM</th> </tr> </thead> <tbody> <tr> <td>GN1330A0</td> <td>FERRITIC PLATE GASKET XL40</td> <td>1</td> <td>PZ</td> </tr> <tr> <td>MG1015B0</td> <td>L.MISS/L.MICR O/CHEFTOP HANDLE END</td> <td>2</td> <td>PZ</td> </tr> <tr> <td>TB1077A0</td> <td>XLT135/XLT19 5 Ø18X1 HANDLE TUBE</td> <td>1</td> <td>PZ</td> </tr> <tr> <td>VI1685A0</td> <td>M6X6 STAINLESS STEEL SCREW</td> <td>4</td> <td>PZ</td> </tr> <tr> <td>VI1930A0</td> <td>5X25 ST. STEEL SCREW CHIP</td> <td>2</td> <td>PZ</td> </tr> <tr> <td>VM1720A0</td> <td>XL405 DOOR WASKER</td> <td>1</td> <td>PZ</td> </tr> <tr> <td>VT1086B0</td> <td>XLT195\XLT19 3 DOOR BLACK GLASS 399X661</td> <td>1</td> <td>PZ</td> </tr> </tbody> </table>	Code	Description	Qty	UOM	GN1330A0	FERRITIC PLATE GASKET XL40	1	PZ	MG1015B0	L.MISS/L.MICR O/CHEFTOP HANDLE END	2	PZ	TB1077A0	XLT135/XLT19 5 Ø18X1 HANDLE TUBE	1	PZ	VI1685A0	M6X6 STAINLESS STEEL SCREW	4	PZ	VI1930A0	5X25 ST. STEEL SCREW CHIP	2	PZ	VM1720A0	XL405 DOOR WASKER	1	PZ	VT1086B0	XLT195\XLT19 3 DOOR BLACK GLASS 399X661	1	PZ																	
			Code	Description	Qty	UOM																																																
GN1330A0	FERRITIC PLATE GASKET XL40	1	PZ																																																			
MG1015B0	L.MISS/L.MICR O/CHEFTOP HANDLE END	2	PZ																																																			
TB1077A0	XLT135/XLT19 5 Ø18X1 HANDLE TUBE	1	PZ																																																			
VI1685A0	M6X6 STAINLESS STEEL SCREW	4	PZ																																																			
VI1930A0	5X25 ST. STEEL SCREW CHIP	2	PZ																																																			
VM1720A0	XL405 DOOR WASKER	1	PZ																																																			
VT1086B0	XLT195\XLT19 3 DOOR BLACK GLASS 399X661	1	PZ																																																			
KVT1086BL	XLT195/XLT193 LEFT COMPLETE DOOR KIT	<table border="1"> <thead> <tr> <th>Code</th> <th>Description</th> <th>Qty</th> <th>UOM</th> </tr> </thead> <tbody> <tr> <td>0H4540A0</td> <td>DOOR PLATES MAGNET XL40</td> <td>1</td> <td>PZ</td> </tr> <tr> <td>CR1080A0</td> <td>XV-XL-XB ST. STEEL RIGHT HINGE</td> <td>1</td> <td>PZ</td> </tr> <tr> <td>CR1081A0</td> <td>XV-XL-XB ST. STEEL LEFT HINGE</td> <td>1</td> <td>PZ</td> </tr> <tr> <td>GN1320A0</td> <td>DOOR GLASS HINGE GASKE</td> <td>2</td> <td>PZ</td> </tr> <tr> <td>GN1320A1</td> <td>DOOR GLASS GASKET</td> <td>2</td> <td>PZ</td> </tr> <tr> <td>GN1330A0</td> <td>FERRITIC PLATE GASKET XL40</td> <td>1</td> <td>PZ</td> </tr> <tr> <td>MG1015B0</td> <td>L.MISS/L.MICR O/CHEFTOP HANDLE END</td> <td>2</td> <td>PZ</td> </tr> <tr> <td>TB1077A0</td> <td>XLT135/XLT19 5 Ø18X1 HANDLE TUBE</td> <td>1</td> <td>PZ</td> </tr> <tr> <td>VI1685A0</td> <td>M6X6 STAINLESS STEEL SCREW</td> <td>4</td> <td>PZ</td> </tr> <tr> <td>VI1930A0</td> <td>5X25 ST. STEEL SCREW CHIP</td> <td>2</td> <td>PZ</td> </tr> <tr> <td>VM1720A0</td> <td>XL405 DOOR WASKER</td> <td>1</td> <td>PZ</td> </tr> <tr> <td>VT1086B0</td> <td>XLT195\XLT19 3 DOOR BLACK GLASS 399X661</td> <td>1</td> <td>PZ</td> </tr> </tbody> </table>	Code	Description	Qty	UOM	0H4540A0	DOOR PLATES MAGNET XL40	1	PZ	CR1080A0	XV-XL-XB ST. STEEL RIGHT HINGE	1	PZ	CR1081A0	XV-XL-XB ST. STEEL LEFT HINGE	1	PZ	GN1320A0	DOOR GLASS HINGE GASKE	2	PZ	GN1320A1	DOOR GLASS GASKET	2	PZ	GN1330A0	FERRITIC PLATE GASKET XL40	1	PZ	MG1015B0	L.MISS/L.MICR O/CHEFTOP HANDLE END	2	PZ	TB1077A0	XLT135/XLT19 5 Ø18X1 HANDLE TUBE	1	PZ	VI1685A0	M6X6 STAINLESS STEEL SCREW	4	PZ	VI1930A0	5X25 ST. STEEL SCREW CHIP	2	PZ	VM1720A0	XL405 DOOR WASKER	1	PZ	VT1086B0	XLT195\XLT19 3 DOOR BLACK GLASS 399X661	1	PZ
Code	Description	Qty	UOM																																																			
0H4540A0	DOOR PLATES MAGNET XL40	1	PZ																																																			
CR1080A0	XV-XL-XB ST. STEEL RIGHT HINGE	1	PZ																																																			
CR1081A0	XV-XL-XB ST. STEEL LEFT HINGE	1	PZ																																																			
GN1320A0	DOOR GLASS HINGE GASKE	2	PZ																																																			
GN1320A1	DOOR GLASS GASKET	2	PZ																																																			
GN1330A0	FERRITIC PLATE GASKET XL40	1	PZ																																																			
MG1015B0	L.MISS/L.MICR O/CHEFTOP HANDLE END	2	PZ																																																			
TB1077A0	XLT135/XLT19 5 Ø18X1 HANDLE TUBE	1	PZ																																																			
VI1685A0	M6X6 STAINLESS STEEL SCREW	4	PZ																																																			
VI1930A0	5X25 ST. STEEL SCREW CHIP	2	PZ																																																			
VM1720A0	XL405 DOOR WASKER	1	PZ																																																			
VT1086B0	XLT195\XLT19 3 DOOR BLACK GLASS 399X661	1	PZ																																																			



ASM1311A/0.D01 - External cover

FRONT

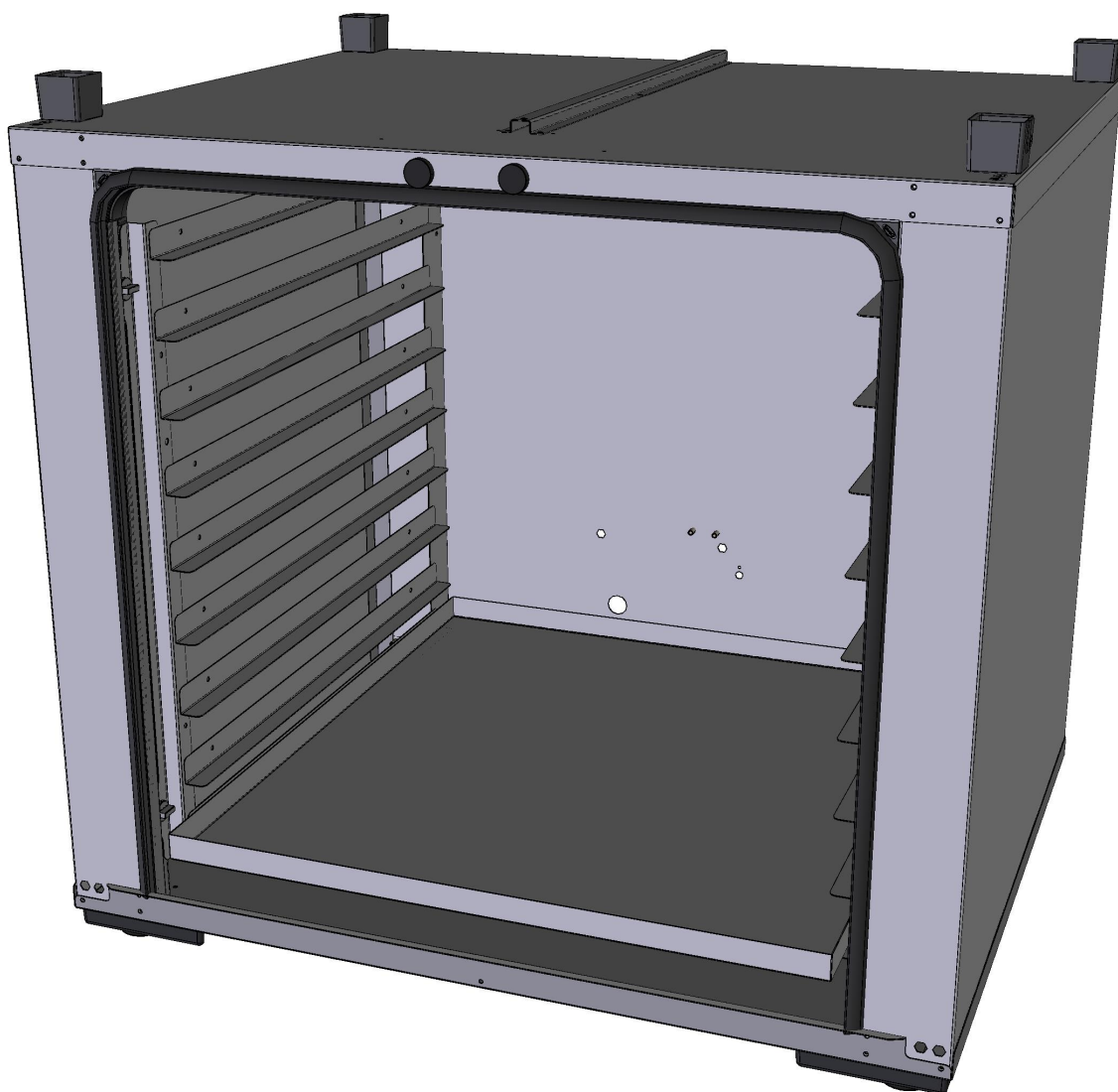



ASM1311A/0.D01 - External cover



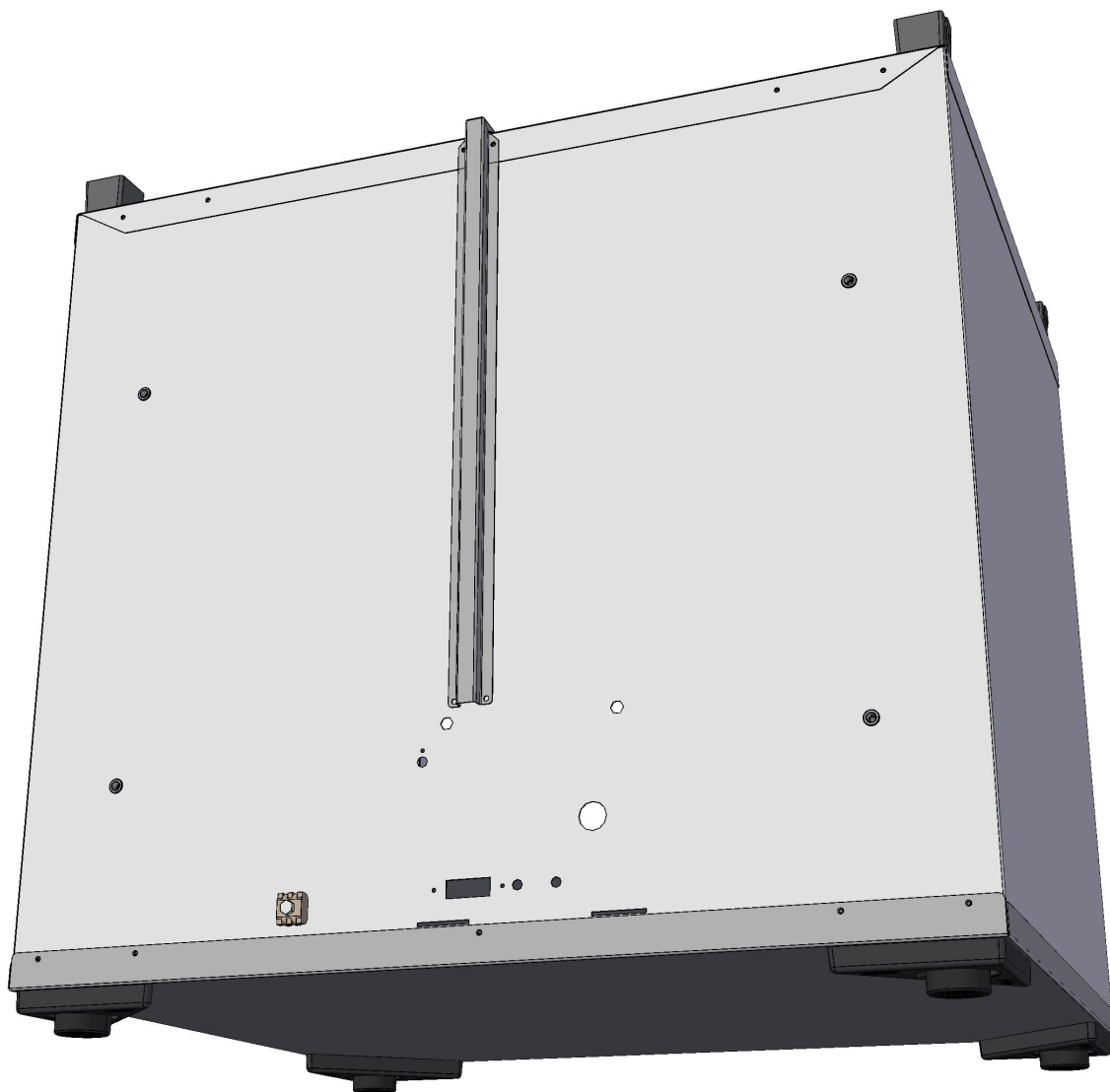

REAR









COMPONENT			SPARE PART														
Code	Description	Image	Code	Description	Components list												
VM1750A	BRASS COMB CLAM		KVM1750A	COMB TERMINAL BLOCK KIT	<table border="1"> <thead> <tr> <th>Code</th> <th>Description</th> <th>Qty</th> <th>UOM</th> </tr> </thead> <tbody> <tr> <td>VM1750A0</td> <td>BRASS COMB CLAMP</td> <td>1</td> <td>PZ</td> </tr> </tbody> </table>	Code	Description	Qty	UOM	VM1750A0	BRASS COMB CLAMP	1	PZ				
Code	Description	Qty	UOM														
VM1750A0	BRASS COMB CLAMP	1	PZ														
VM1820A	LATERAL SUPPORTS M6 FIXING BOLT		KVM1820A	THUMB SCREW 10PCS KIT	<table border="1"> <thead> <tr> <th>Code</th> <th>Description</th> <th>Qty</th> <th>UOM</th> </tr> </thead> <tbody> <tr> <td>VM1820A0</td> <td>LATERAL SUPPORTS M6 FIXING BOLT</td> <td>10</td> <td>PZ</td> </tr> </tbody> </table>	Code	Description	Qty	UOM	VM1820A0	LATERAL SUPPORTS M6 FIXING BOLT	10	PZ				
Code	Description	Qty	UOM														
VM1820A0	LATERAL SUPPORTS M6 FIXING BOLT	10	PZ														
VM1281A	TRIANGULAR BRACKET FOR FOOT AND WHEEL																
VM1645A	XL405 PROOFER CORNER GASKET																
VE1607A	RUBBER MAGNETIC SUCTION CUP		KVE1607A	MAGNETIC SUCTION CUP	<table border="1"> <thead> <tr> <th>Code</th> <th>Description</th> <th>Qty</th> <th>UOM</th> </tr> </thead> <tbody> <tr> <td>VE1607A1</td> <td>RUBBER MAGNETIC SUCTION CUP</td> <td>4</td> <td>PZ</td> </tr> <tr> <td>V11700A0</td> <td>18X6.4X1.5 STAINLESS STEEL FLAT WASHER</td> <td>4</td> <td>PZ</td> </tr> </tbody> </table>	Code	Description	Qty	UOM	VE1607A1	RUBBER MAGNETIC SUCTION CUP	4	PZ	V11700A0	18X6.4X1.5 STAINLESS STEEL FLAT WASHER	4	PZ
Code	Description	Qty	UOM														
VE1607A1	RUBBER MAGNETIC SUCTION CUP	4	PZ														
V11700A0	18X6.4X1.5 STAINLESS STEEL FLAT WASHER	4	PZ														

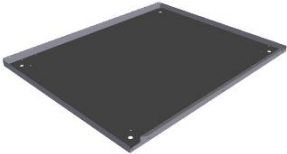
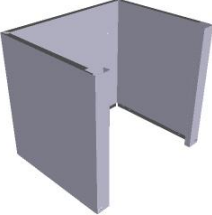

COMPONENT			SPARE PART										
Code	Description	Image	Code	Description	Components list								
PD1065A	ACCESSORY FOOT D45 H20 M10X40		KPD1065A	H20 M10X37 D45 FEET 4PCS KIT	<table border="1"> <thead> <tr> <th>Code</th> <th>Description</th> <th>Qty</th> <th>UOM</th> </tr> </thead> <tbody> <tr> <td>PD1065A0</td> <td>ACCESSORY FOOT D45 H20 M10X40</td> <td>4</td> <td>PZ</td> </tr> </tbody> </table>	Code	Description	Qty	UOM	PD1065A0	ACCESSORY FOOT D45 H20 M10X40	4	PZ
Code	Description	Qty	UOM										
PD1065A0	ACCESSORY FOOT D45 H20 M10X40	4	PZ										
0H1187A	XLT193 CABLES COVER		0H1187A1	XLT193 CABLES COVER									
0H1181A	GASKET LATERAL PROFILE XLT135/13		0H1181A2	GASKET LATERAL PROFILE XLT135/13									
GRL1324A	LMISS 800 PROOFER LEFT LATERAL GRID		GRL1324A0	LMISS 800 PROOFER LEFT LATERAL GRID									
GRL1325A	LMISS 800 PROOFER RIGHT LATERAL GRID		GRL1325A0	LMISS 800 PROOFER RIGHT LATERAL GRID									



COMPONENT			SPARE PART														
Code	Description	Image	Code	Description	Components list												
0E1004B	XLT195\XLT193 EXTERNAL BOTTOM PANEL		0E1004B0	XLT195\XLT193 EXTERNAL BOTTOM PANEL													
0D1034B	XLT195\XLT193 EXTERNAL CASING		0D1034B0	XLT195\XLT193 EXTERNAL CASING													
VM1029A	L.MISS STACKING FOOT RISE		KVM1029A	L.MISS STACKING FOOT RISE 50 PCS KIT	<table border="1"> <thead> <tr> <th>Code</th> <th>Description</th> <th>Qty</th> <th>UOM</th> </tr> </thead> <tbody> <tr> <td>VM1029A0</td> <td>L.MISS STACKING FOOT RISE</td> <td>50</td> <td>PZ</td> </tr> </tbody> </table>	Code	Description	Qty	UOM	VM1029A0	L.MISS STACKING FOOT RISE	50	PZ				
Code	Description	Qty	UOM														
VM1029A0	L.MISS STACKING FOOT RISE	50	PZ														
0H1188A	GASKET UPPER PROFILE XLT195 XLT193		0H1188A2	GASKET UPPER PROFILE XLT195 XLT193													
GN1521A	XFT ROSSELLA OVEN DOOR GASKE		KGN1521A KGN0010A	XLT193/XLT195 DOOR GASKET KIT 2,5M GN1007A DOOR SEAL KIT	<table border="1"> <thead> <tr> <th>Code</th> <th>Description</th> <th>Qty</th> <th>UOM</th> </tr> </thead> <tbody> <tr> <td>GN1110A2</td> <td>LINE MISS/XVC105- 055/XK/XL DOOR GASKE</td> <td>1.830</td> <td>M</td> </tr> <tr> <td>GN1110A2</td> <td>LINE MISS/XVC105- 055/XK/XL DOOR GASKE</td> <td>2.500</td> <td>M</td> </tr> </tbody> </table>	Code	Description	Qty	UOM	GN1110A2	LINE MISS/XVC105- 055/XK/XL DOOR GASKE	1.830	M	GN1110A2	LINE MISS/XVC105- 055/XK/XL DOOR GASKE	2.500	M
Code	Description	Qty	UOM														
GN1110A2	LINE MISS/XVC105- 055/XK/XL DOOR GASKE	1.830	M														
GN1110A2	LINE MISS/XVC105- 055/XK/XL DOOR GASKE	2.500	M														

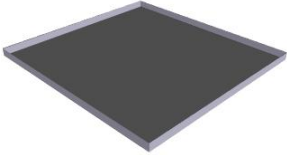

COMPONENT			SPARE PART		
<i>Code</i>	<i>Description</i>	<i>Image</i>	<i>Code</i>	<i>Description</i>	<i>Components list</i>
0H1192A	XLT195 WATER TRA		0H1192A0	XLT195 WATER TRA	
0D1038A	XLT193 COVER	