

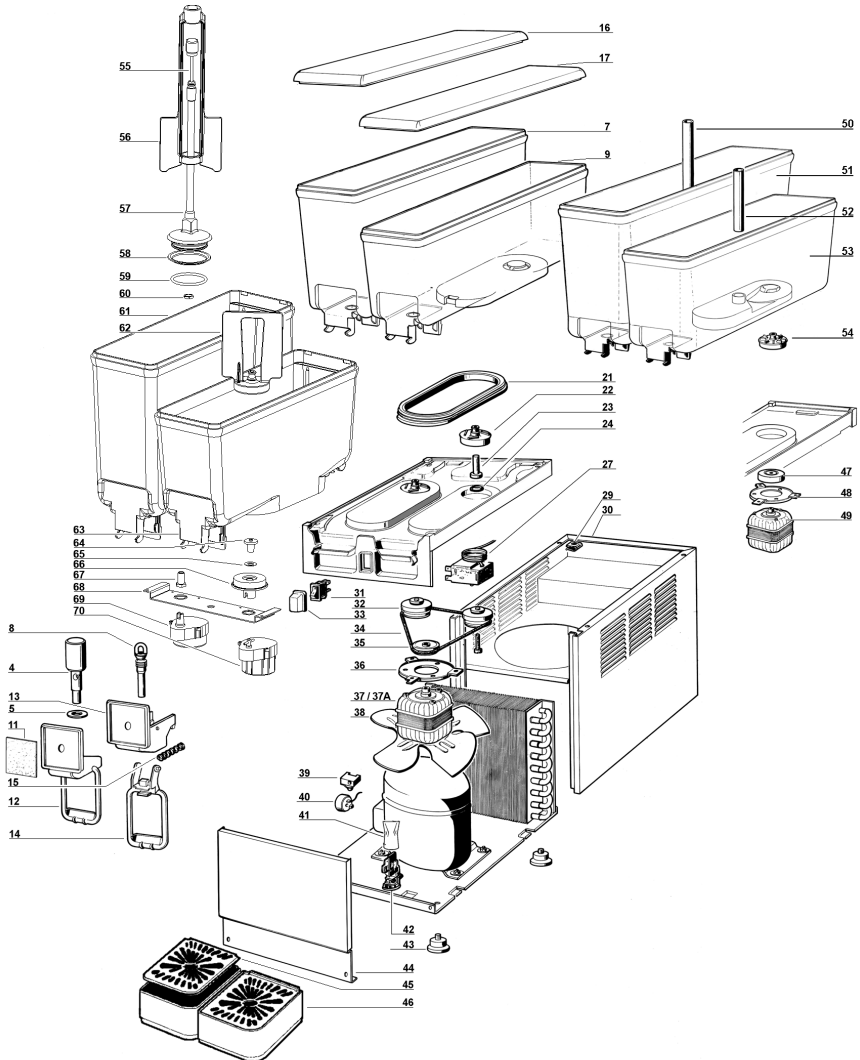













- I** ELENCO RICAMBI
- GB** SPARE PARTS LIST
- F** LISTE DES PIECES DE RECHANGE
- D** ERSATZTEILLISTE
- E** DESCRIPCION PIEZAS DE REPUESTO



4	22800-21900	Pistone rubinetto	Faucet piston	Piston du robinet	Kolben für Hahn	Pistón del grifo
5	10028-02500	Guarnizione rubinetto	Faucet gasket	Joint du robinet	Dichtung	Junta del grifo
7	22900-02010	Contentitore 8 lt.	8 lt bowl	Réservoir 8 lt	Behälter 8 lt	Contenedor 8 lt
8	21703-00000	Gommino rubinetto	Pinch tube	Tuyau du robinet	Ausgabeventilrohr	Goma de grifo
9	22900-01910	Contentitore 5 lt.	5 lt bowl	Réservoir 5 lt	Behälter 5 lt	Contenedor 5 lt
11	10029-00020	Fotografia	Picture	Photo	Dia	Fotografia
12	22900-00500	Leva comando rubinetto	Push handle	Levier du robinet	Ausgabe	Placa de mando grifo
13	22900-00800	Coprirubinetto	Faucet cover	Couvercle du robinet	Ventilkappe	Cubre grifo
14	22900-00501	Leva comando rubinetto	Push handle	Levier de débit	Zapfhebel	Palanca de mando grifo
15	22800-02600	Molla rubinetto	Faucet spring	Ressort du robinet	Ventilfeder	Muelle grifo
16	22900-01300	Coperchio contenit. 8 lt.	8 lt bowl cover	Couvercle réservoir 8 lt	Behälterdeckel 8 lt	Tapa contenedor 8 lt
17	22900-01300	Coperchio contenit. 5 lt.	5 lt bowl cover	Couvercle réservoir 5 lt	Behälterdeckel 5 lt	Tapa contenedor 5 lt
21	22800-17200	Guarnizione contenitore	Bowl gasket	Joint du réservoir	Behälterdichtung	Junta contenedor
22	33900-01201	Girante pompa	Impeller	Turbine de la pompe	Pumpenrad	Turbina bomba
23	22900-00600	Perno centrale	Central pivot	Pivot central	Mittescharnierstift	Pivote central
24	22040-00000	OR per perno centrale	Central pivot OR	OR du pivot central	Mittescharnierstift OR	OR del pivote central
27	21087-00000	Termostato	Thermostat	Thermostat	Thermostat	Termostato
29	10554-45000	Clip	Clip	Clip	Clip	Clip
30a		Mobile	Cabinet	Carrosserie	Gehäuse	Caja
30b		Mobile bianco	White cabinet	Carrosserie blanc	Gehäuse weiß	Caja blanco
31	21125-00000	Interruttore	Switch	Interrupteur	Schalter	Interruptor
32	33900-01052	Puleggia con cuscinetto, magnete e distanziale	Pulley, magnet and spacer assembly	Ensemble poulie, aimant et entretoise	Scheibe mit Kugellager, Magnet und Büchse	Polea con magneto y distancial
33	22800-05100	Protezione interruttore	Switch cap	Capuchon interrupteur	Schalterabdeckung	Protección interruptor
34	22900-03602	Cinghia	Belt	Courroie	Reimen	Correa
35	22800-02201	Puleggia per motore	Driving pulley	Poulie motrice	Scheibe für Motor	Polea motora
36	22800-04800	Staffa supporto motore	Motor bracket	Support du moteur	Motorhaltebuegel	Placa soporte motor
37		Motore ventilatore/pompa per 1 vasca	Fan/pump motor for 1 bowl	Moteur ventilateur/pompe pour 1 réservoir	Lüftermotor/pumpe für 1 behälter	Motor ventilador/bomba por 1 contenedor
37A		Motore ventilatore/pompa per 2, 4 vasche	Fan/pump motor for 2, 4 bowls	Moteur ventilateur/pompe pour 2, 4 réservoir	Lüftermotor/pumpe für 2, 4 ehälter	Motor ventilador/bomba por 2, 4 contenedor
38		Ventola	Fan	Hélice	Lüfterflügel	Aspas
39		Relé	Relay	Relais	Start-Relais	Relé
40		Salvamotore	Overload protector	Protège moteur	Motorsicherung	Guardamotor
41	22800-12700	Protezione passabloccacavo	Terminal block cover	Protection borne	Schutzkappe	Protección pasacable
42		Passabloccacavo	Terminal block with cable clamp	Borne et fixation du câble	Anschlussklemme m. Kabeleinführung	Pasacable
43	22800-10000	Piedino	Rubber leg	Petit pied	Justierfüße	Pie nivelador
44a		Pannello lato rubinetto	Dispensing side panel	Panneau côté robinet	Front	Panel lado grifo
44b		Pannello lato rubinetto bianco	White dispensing side panel	Panneau côté robinet blanc	Front weiß	Panel lado grifo blanco
45a		Griglia cassetto raccogli-gocce	Drip tray cover	Couvercle tiroir égouttoir	Tropfgitter	Rejilla cajón
45b		Griglia cassetto raccogli-gocce bianco	White drip tray cover	Couvercle tiroir égouttoir blanc	Tropfgitter weiß	Rejilla cajón blanco
46a		Cassetto raccogli-gocce	Drip tray	Tiroir égouttoir	Tropfschale	Cajón recoge-gotas
46b		Cassetto raccogli-gocce bianco	White drip tray	Tiroir égouttoir blanc	Tropfschale weiß	Cajón recoge-gotas blanco
47	33800-00803	Magnete motore per 1, 3 vasche	Motor magnet for 1, 3 bowls	Aimant du moteur pour 1, 3 réservoir	Motorrad für 1, 3 behälter	Embrague magnético por 1, 3 contenedor

Arctic Compact 5-8

48	22800-04800	Staffa supporto motore	Motor bracket	Support du moteur	Motorhaltebuegel	Placa soporte motor
49	○○○	Motore per 3 vasche	Pump motor 3 bowls	Moteur de la pompe 3 réservoir	Pumpenmotor für 3 behälter	Motor bomba por 3 contenedor
50	22900-00203	Tubo mandata 8lt	8lt Spray tube	Tube refolement pompe 8lt	Sprührohr 8lt	Tubo bomba para contenedor 8 l
51	22900-02000	Contenitore 8 lt.	8 lt bowl	Réservoir 8 lt	Behälter 8 lt	Contenedor 8 l linea P
52	22900-00202	Tubo mandata 5lt	5lt Spray tube	Tube refolement pompe 5lt	Sprührohr 5lt	Tubo bomba para contenedor 5 l
53	22900-01900	Contenitore 5 lt.	5 lt bowl	Réservoir 5 lt	Behälter 5 lt	Contenedor 5 l linea P
54	○○○	Girante pompa 5-8lt	Pump impeller for 5-8lt	Turbine de la pompe 5-8lt	Pumpenrad für 5-8lt	Turbina bomba linea P
55	22900-05603	Albero trascinamento 8lt	Driving shaft 8lt	Arbre d'entraînement 8lt	Antriebswelle 8lt	Eje transmisión 8lt
56	22900-05410	Agitatore 8lt	Stirrer 8lt	Brasseur 8lt	Rührwerk 8lt	Agitador 8lt
57	22900-05503	Albero centrale 8lt	Central shaft 8lt	Arbre central 8lt	Zentralwelle 8lt	Eje central 8lt
58	22900-05710	Guarnizione albero centrale	Central shaft seal	Joint d'arbre centrale	Zentral-Wellendichtung	Sello del eje central
59	22900-05700	OR per albero centrale	Central shaft OR.	Joint OR pour arbre central	O-Ring für Zentralwelle	OR para eje central
60	10533-01303	Dado d'ottone	brass nut	écrou en laiton	Messingnuß	dado d'ottone
61	22900-02020	Contenitore 8lt. per agitatore	8 l bowl for stirrer	Cuve 8 l pour brasseur	Behälter 8 l für Rührwerk	Contenedor 8 l para agitador
62	33900-01203	Agitatore	Stirrer	Brasseur	Rührwerk	Agitador
63	22900-00020	Contenitore 5lt. per agitatore	5 l bowl for stirrer	Cuve 5l pour brasseur	Behälter 5 l für Rührwerk	Contenedor 5 l para agitador
64	22900-02502	Perno centrale	Central pivot	Pivot central	Mittescharnierstift	Pivote central
65	22900-02503	Ranella di rasamento	Washer	Rondelle	Scheibe	Arandela
66	33900-01011	Girante motore agitatore	Impeller mixer motor	Turbine de moteur du mélangeur	Rad Rührwerkmotor	Turbina motor agitador
67	22900-05800	Perno filettato per albero centrale	Threaded bolt shaft Central	Boulon fileté du Central	Gewindebolzen Welle Central	Perno roscado del eje central
68	□□□	Staffa supporto motore	Pump motor bracket	Support du moteur de la pompe	Motorhaltebuegel	Placa soporte motor bomba
69	○○○	Motore agitatore	Mixer motor	Moteur du mélangeur	Rührwerkmotor	Motor agitador
70	○○○	Motore agitatore	Mixer motor	Moteur du mélangeur	Rührwerkmotor	Motor agitador

○○○/□□□ **Vedere tabella**
*** **Ordinare con sigla riportata sul pezzo**

See table
Please order what printed on piece

Voir tableau
Mentionner indicatif imprimé sur la pièce

Siehe Tabelle
Diese Teile bitte anhand der aufgedruckten Nummern bestellen

Ver tabla
Pedir con la identificación marcada en la pieza

○○○

	230-240V 50Hz	115V 60Hz	220V 60Hz
37	22800-18980	22800-18981	22800-18982
37A	22900-03010	22900-03011	22900-03012
41	22800-05501	22800-05500	22800-05500
42	22800-05501	22800-05500	22800-05500
49	22800-04705	22800-04706	22800-04708
54	33900-01204	33900-01205	33900-01205
69	33800-06700	33800-06701	33800-06700
70	22900-03500	22900-03501	22900-03500

□□□

	1/..	2/..	3/..	4/..
30a	22900-03210	22900-03211	22900-03212	22900-03213
30b	22911-03210	22911-03211	22911-03212	22911-03213
38	22900-00403	22900-00401	22900-00401	22900-00401
44a	22900-03110	22900-03111	22900-03112	22900-03113
44b	-	22900-03121	-	-
45a	22800-00500	22800-00510	22800-00510	22800-00510
45b	22800-00561	22800-00562	22800-00562	22800-00562
46a	22800-00602	22800-00611	22800-00611	22800-00611
46b	22800-00601	22800-00662	22800-00662	22800-00662
68	22900-02505	22900-02510	-	2 x 22900-02510