

Service manual

Version: 2.00

Ident: B1-EBO 064

Series: EBO

Part-Number: 500186

This part can be ordered.



Chapter

500196 - Baking Chamber EBO64 400V 50Hz - V:2.00

500174 - Control EBO - V:2.00

500195 - Door EBO64/68 - V:2.00

500183 - Electric-Installation digital/MAN - V:2.00

500184 - Electric-Installation IS 500/600 - V:2.00

500176 - Frame EBO - V:2.00

500197 - Installationroom EBO64 400V 50Hz - V:2.00

Service manual

Baking Chamber EBO64 400V 50Hz

Version: 2.00

Ident: B1-EBO 064

Series: EBO

Part-Number: 500196

This part can be ordered.

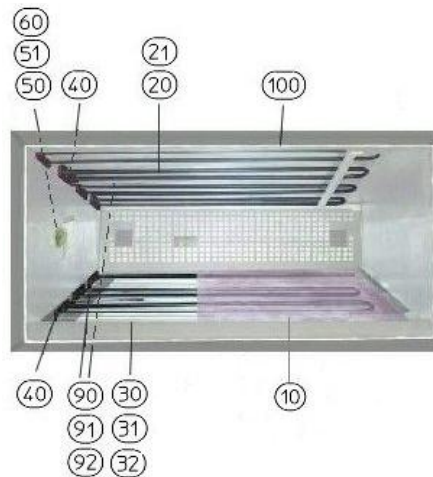

Chapter

- 70508 - EBO Frame for lamps-lower part
- 70509 - EBO protective glass f. lamps-lower part
- [010] - 105688 - Stone baking plate EBO64
- [020] - 402527 - Tube Heater infrared 400W / 230V
- [021] - 402528 - Tube Heater infrared 450W / 230V
- [030] - 70533 - Tube Heater 450W / 230V
- [031] - 70531 - Tube Heater 250W / 230V
- [032] - 70530 - Tube Heater 350W / 230V
- [040] - 105683 - Seal for tube heater
- [050] - 70179 - Halogen Lamp 12V 50W
- [051] - 70510 - Seal for bottom part of the lamp
- [060] - 70176 - Socket 8-pole Halogen Lamp
- [090] - 400263 - Type K thermocouple
- [091] - 105679 - Resistance thermometer PT500
- [092] - 400266 - Temperature probe
- [100] - 105686 - Sealing rope

Part: EBO Frame for lamps-lower part

Part-Number: 70508

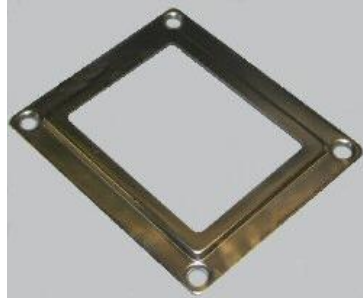

Part: EBO protective glass f. lamps-lower part

Part-Number: 70509



Part: Stone baking plate EBO64

Part-Number: 105688

Part: Tube Heater infrared 400W / 230V

Part-Number: 402527

Part: Tube Heater infrared 450W / 230V

Part-Number: 402528

Part: Tube Heater 450W / 230V

Part-Number: 70533



Part: Tube Heater 250W / 230V

Part-Number: 70531



Part: Tube Heater 350W / 230V

Part-Number: 70530



Part: Seal for tube heater

Part-Number: 105683



Part: Halogen Lamp 12V 50W

Part-Number: 70179



Part: Seal for bottom part of the lamp

Part-Number: 70510



Part: Socket 8-pole Halogen Lamp

Part-Number: 70176

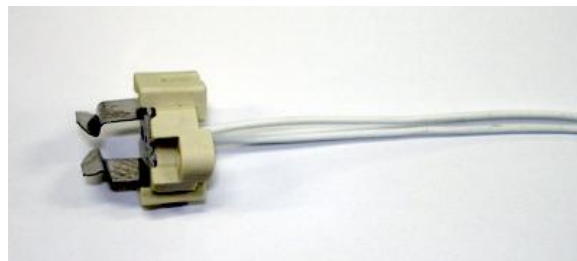

Part: Type K thermocouple

Part-Number: 400263



Part: Resistance thermometer PT500

Part-Number: 105679



Part: Temperature probe

Part-Number: 400266



Part: Sealing rope

Part-Number: 105686



Service manual Control EBO

Version: 2.00

Ident: B1-EBO 124

Series: EBO

Part-Number: 500174

This part can be ordered.



Chapter

- 500203 - Control Unit digital with Night start - V:2.00
- 500180 - Operating Unit Honeywell - V:2.00
- 500179 - Operating Unit IS 400 (Panel-Format) - V:2.00
- 400502 - Operating Unit IS 500 EBO - V:2.00
- 101347 - Operating Unit IS 600 EBO - V:2.00

Service manual Control Unit digital with Night start

Version: 2.00

Ident: B1-EBO 128

Series: EBO

Part-Number: 500203

This part can be ordered.



Chapter

38099 - Control digital with Night start, complete

Part: Control digital with Night start, complete

Part-Number: 38099

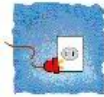

Vor Arbeitsbeginn bitte Netztrennung vornehmen.

Service manual Operating Unit Honeywell

Version: 2.00

Ident: B1-EBO 128

Series: EBO

Part-Number: 500180

This part can be ordered.

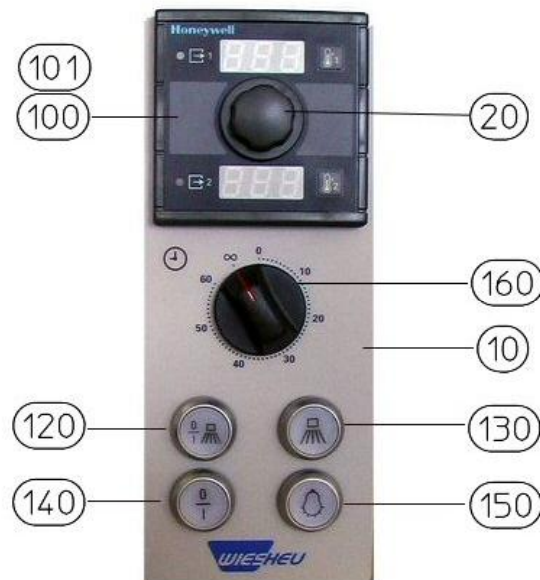

Chapter

78012 - Timer

36058 - Buzzer

400266 - Temperature probe

400769 - Illuminated notch

400770 - Illuminated notch

400771 - Illuminated key attachment adapter

400772 - Illuminated key LED 230 V

400773 - Illuminated key closing contact

[010] - 400232 - Operating Foil honeywell

[020] - 9040-155-001 - Dial knob Honeywell -Regulator

[100] - 70046 - Honeywell control (max. 300°C)

[101] - 70048 - Honeywell control (max. 400°C)

[120] - 400777 - Push button "baking chamber illuminating"

[130] - 400778 - Illuminated push button "steam"

[140] - 400774 - Illuminated push button "On-/Off"

[150] - 400776 - Push button "baking chamber illuminating"

[160] - 36691 - Knob timer

Part: Timer

Part-Number: 78012



Part: Buzzer

Part-Number: 36058



Part: Temperature probe

Part-Number: 400266



Part: Illuminated notch

Part-Number: 400769



Part: Illuminated notch

Part-Number: 400770



Part: Illuminated key attachment adapter

Part-Number: 400771

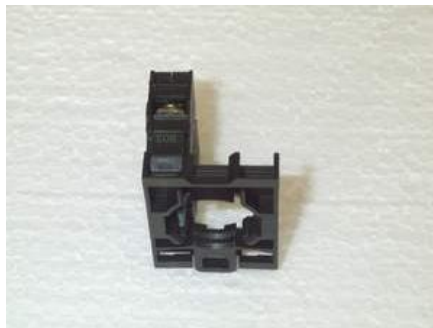

Part: Illuminated key LED 230 V

Part-Number: 400772



Part: Illuminated key closing contact

Part-Number: 400773

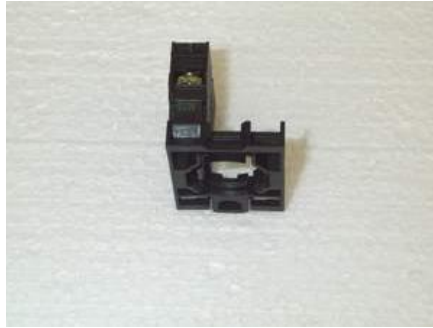

Part: Operating Foil honeywell

Part-Number: 400232

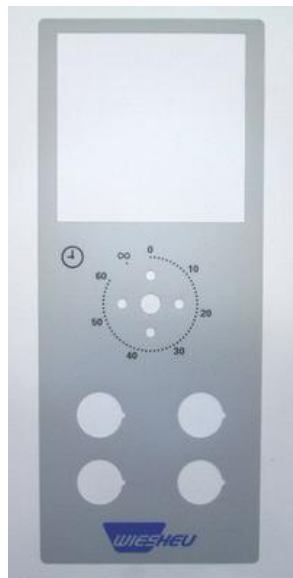

Part: Dial knob Honeywell -Regulator

Part-Number: 9040-155-001



Part: Honeywell control (max. 300°C)

Part-Number: 70046

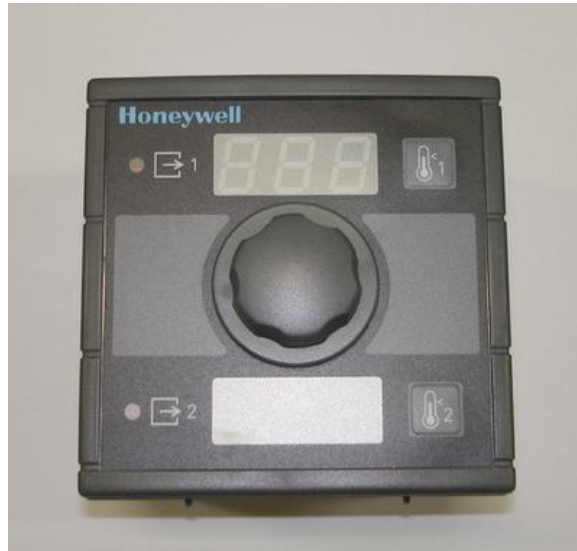

Part: Honeywell control (max. 400°C)

Part-Number: 70048

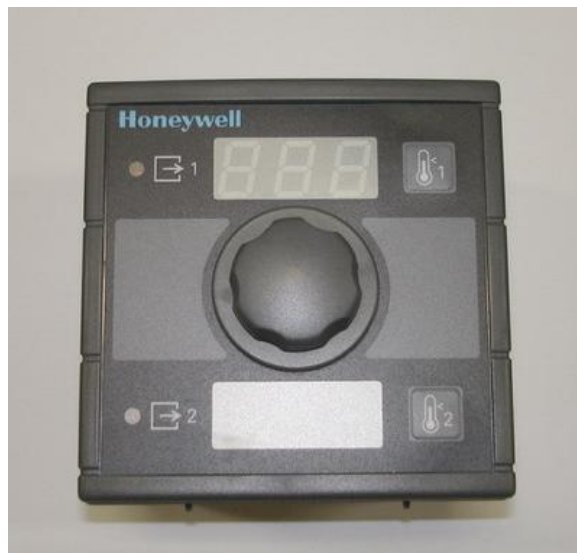

Part: Push button "baking chamber illuminating"

Part-Number: 400777

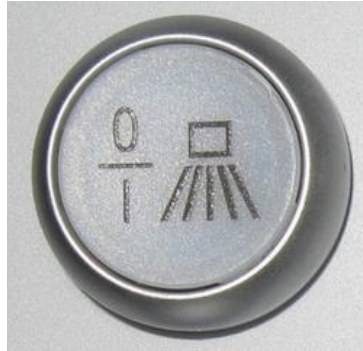

Part: Illuminated push button "steam"

Part-Number: 400778



Part: Illuminated push button "On-/Off"

Part-Number: 400774



Part: Push button "baking chamber illuminating"

Part-Number: 400776



Part: Knob timer

Part-Number: 36691



Service manual Operating Unit IS 400 (Panel-Format)

Version: 2.00

Ident: B1-EBO 128

Series: EBO

Part-Number: 500179

This part can be ordered.



Chapter

[010] - 105440 - Operating Foil IS400

[020] - 105725 - Circuit Board IS 400

Part: Operating Foil IS400

Part-Number: 105440

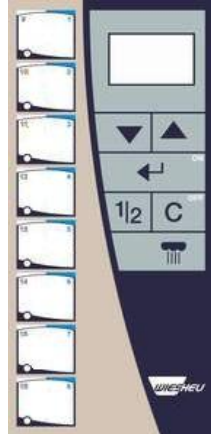

Part: Circuit Board IS 400

Part-Number: 105725

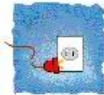

Vor Arbeitsbeginn bitte Netztrennung vornehmen.



Service manual Operating Unit IS 500 EBO

Version: 2.00

Ident: B1-EBO 128

Series: EBO

Part-Number: 400502

This part can be ordered.

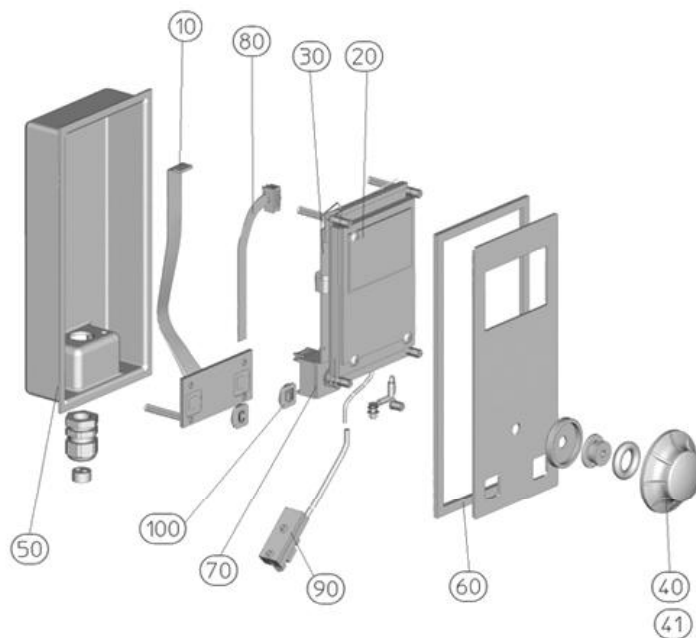

Chapter

- [010] - 101563 - Key block
- [020] - 100804 - Display IS500 with circuit board
- [030] - 105564 - Electronic Circuit Board IS500
- [040] - 102685 - Knob grey
- [041] - 101350 - Knob silver
- [050] - 102450 - Frame IS
- [060] - 102449 - Seal for frame IS
- [070] - 100591 - Incremental encoder
- [080] - 104353 - Ribbon cable for IS500
- [090] - 102806 - USB port with data wire
- [100] - 105849 - Key "C / door"

Part: Key block

Part-Number: 101563



Part: Display IS500 with circuit board

Part-Number: 100804



Part: Electronic Circuit Board IS500

Part-Number: 105564



Part: Knob grey

Part-Number: 102685



Part: Knob silver

Part-Number: 101350



Part: Frame IS

Part-Number: 102450



Part: Seal for frame IS

Part-Number: 102449

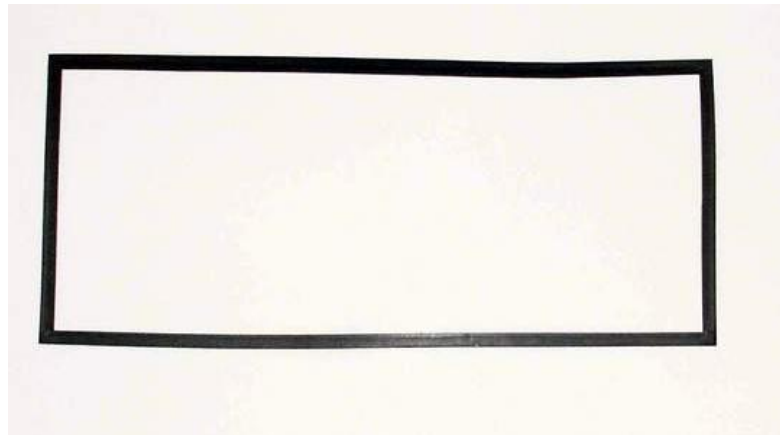

Part: Incremental encoder

Part-Number: 100591



Part: Ribbon cable for IS500

Part-Number: 104353



Part: USB port with data wire

Part-Number: 102806



Part: Key "C / door"

Part-Number: 105849

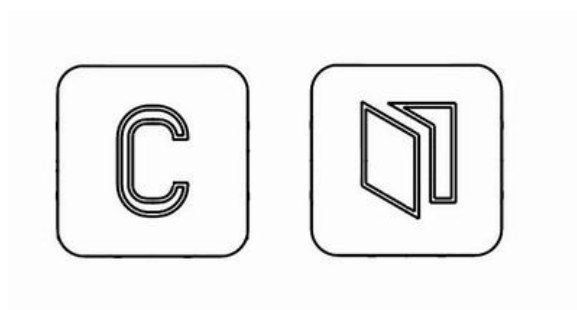

Service manual Operating Unit IS 600 EBO

Version: 2.00

Ident: B1-EBO 128

Series: EBO

Part-Number: 101347

This part can be ordered.

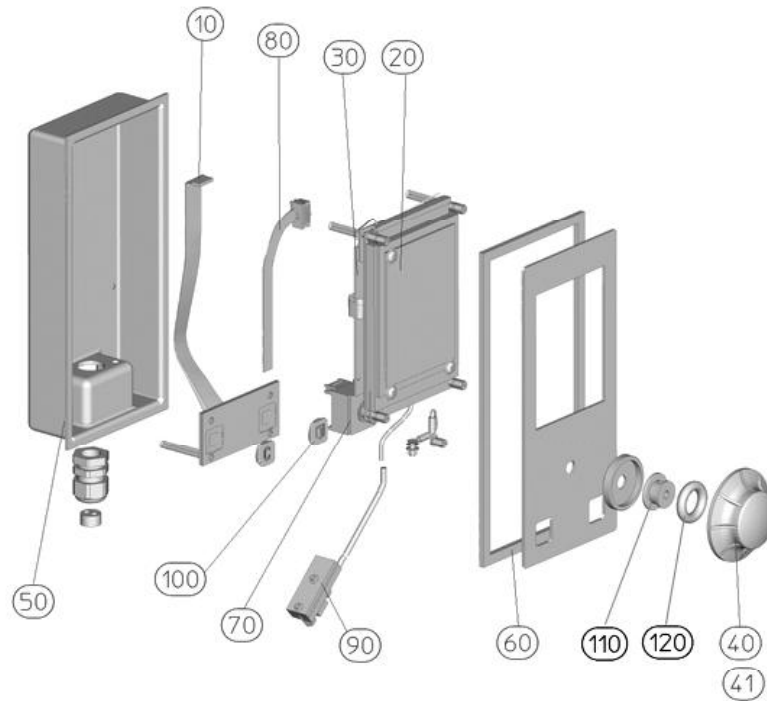

Chapter

- [010] - 101563 - Key block
- [020] - 100617 - Display IS600 with circuit board
- [030] - 101107 - Electronic Circuit Board IS600
- [040] - 102685 - Knob grey
- [041] - 101350 - Knob silver
- [050] - 102450 - Frame IS
- [060] - 102449 - Seal for frame IS
- [070] - 100591 - Incremental encoder
- [080] - 104354 - Ribbon cable for IS600
- [090] - 102806 - USB port with data wire
- [100] - 105849 - Key "C / door"
- [110] - 101434 - Adapter_D54x22
- [120] - 101435 - O-Ring_D16x7_NBR60

Part: Key block

Part-Number: 101563



Part: Display IS600 with circuit board

Part-Number: 100617



Part: Electronic Circuit Board IS600

Part-Number: 101107



Part: Knob grey

Part-Number: 102685



Part: Knob silver

Part-Number: 101350



Part: Frame IS

Part-Number: 102450



Part: Seal for frame IS

Part-Number: 102449

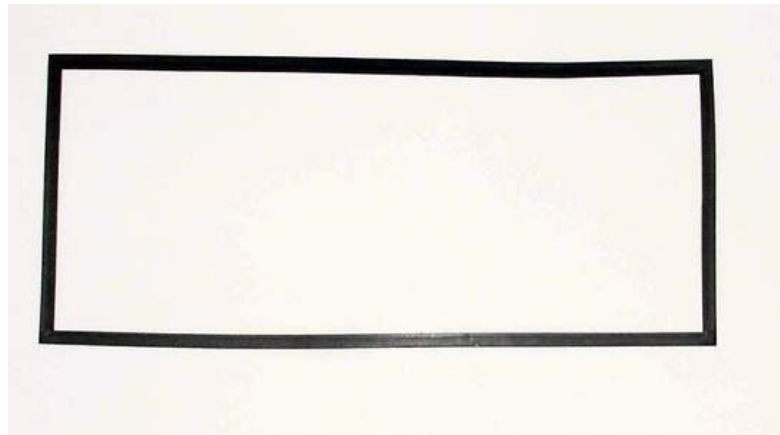

Part: Incremental encoder

Part-Number: 100591



Part: Ribbon cable for IS600

Part-Number: 104354



Part: USB port with data wire

Part-Number: 102806

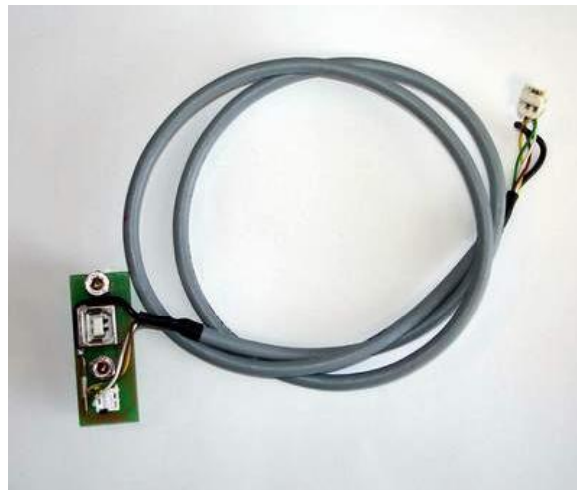

Part: Key "C / door"

Part-Number: 105849

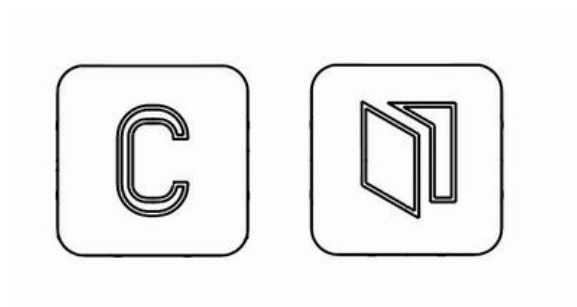

Part: Adapter_D54x22

Part-Number: 101434



Part: O-Ring_D16x7_NBR60

Part-Number: 101435

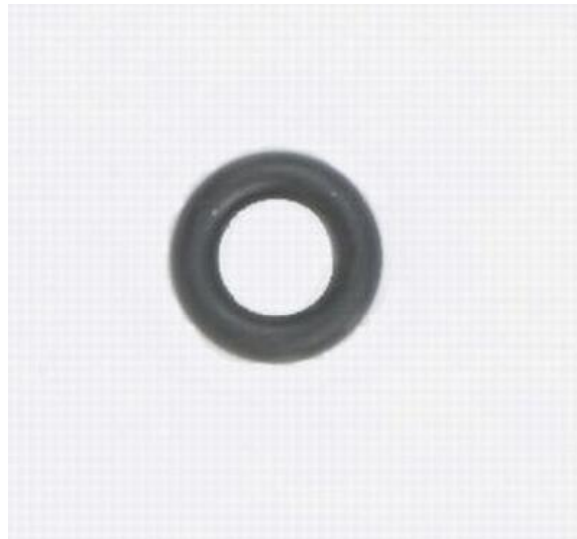

Service manual

Door EBO64/68

Version: 2.00

Ident: B1-EBO 064

Series: EBO

Part-Number: 500195

This part can be ordered.

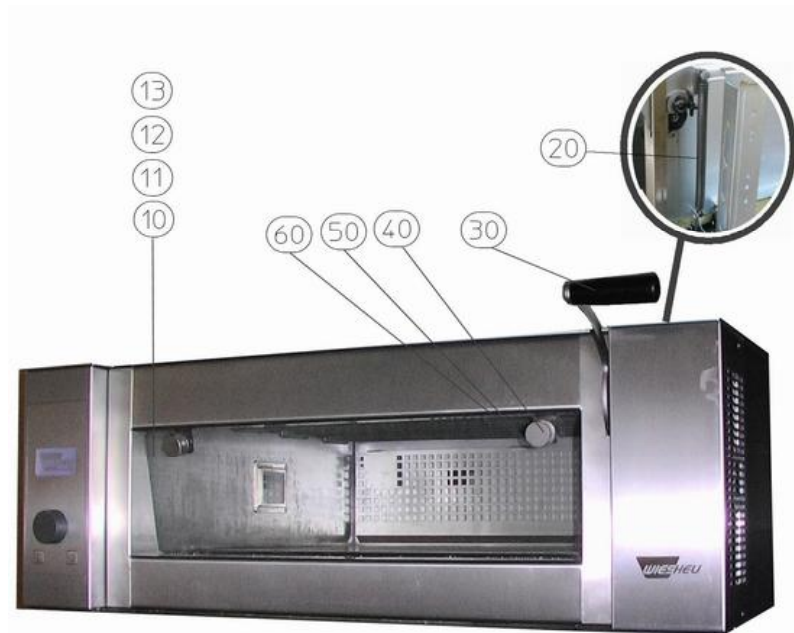

Chapter

- 36068 - Spring ring
- 400817 - Spring holder
- 403222 - Silicone pad
- 403232 - Bush
- 403240 - Door lever
- 431126 - Hexagon screw
- 435015 - Screw nut
- [010] - 402659 - Glass pane EBO64/68 high chamber, Pizza-version
- [011] - 402660 - Glass pane EBO64/68 low chamber, Pizza-version
- [012] - 70063 - Glass pane EBO64/68 high chamber
- [013] - 70064 - Glass pane EBO64/68 low chamber
- [020] - 400765 - Tension spring
- [030] - 70148 - Door handle black
- [040] - 70210 - Knurled screw DIN 635
- [050] - 33878 - Glass plate holder silicone
- [060] - 404235 - Washer DIN 9021 A2

Part: Spring ring

Part-Number: 36068

Part: Spring holder

Part-Number: 400817

Part: Silicone pad

Part-Number: 403222



Part: Bush

Part-Number: 403232

Part: Door lever

Part-Number: 403240

Part: Hexagon screw

Part-Number: 431126

Part: Screw nut

Part-Number: 435015

Part: Glass pane EBO64/68 high chamber, Pizza-version

Part-Number: 402659



Part: Glass pane EBO64/68 low chamber, Pizza-version

Part-Number: 402660



Part: Glass pane EBO64/68 high chamber

Part-Number: 70063



Part: Glass pane EBO64/68 low chamber

Part-Number: 70064

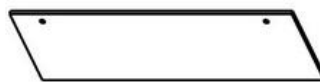

Part: Tension spring

Part-Number: 400765



Part: Door handle black

Part-Number: 70148



Part: Knurled screw DIN 635

Part-Number: 70210



Part: Glass plate holder silicone

Part-Number: 33878



Part: Washer DIN 9021 A2

Part-Number: 404235



Servicemanual

Electric-Installation digital/MAN

Version: 2.00

Ident: B1-EBO 064

Series: EBO

Part-Number: 500183

This part can be ordered.

Chapter

- [010] - 36058 - Buzzer
- [011] - 401523 - Loudspeaker
- [020] - 38086 - Knop thermostat
- [021] - 70355 - Safety limit switch
- [030] - 70511 - Transformer
- [040] - 33884 - Relay main switch
- [050] - 80131 - Time Relay EZ12AW-230V
- [060] - 70508 - EBO Frame for lamps-lower part
- [070] - 70509 - EBO protective glass f. lamps-lower part

Part: Buzzer

Part-Number: 36058



Part: Loudspeaker

Part-Number: 401523



Part: Knop thermostat

Part-Number: 38086



Part: Safety limit switch

Part-Number: 70355

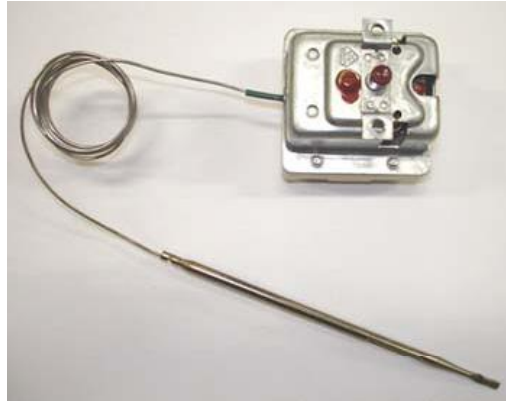

Part: Transformer

Part-Number: 70511



Part: Relay main switch

Part-Number: 33884



Part: Time Relay EZ12AW-230V

Part-Number: 80131

Part: EBO Frame for lamps-lower part

Part-Number: 70508

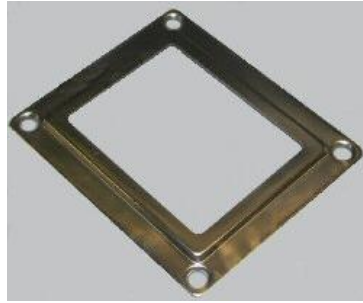

Part: EBO protective glass f. lamps-lower part

Part-Number: 70509



Service manual

Electric-Installation IS 500/600

Version: 2.00

Ident: B1-EBO 064

Series: EBO

Part-Number: 500184

This part can be ordered.



Chapter

- [010] - 101106 - Power board
- [020] - 401523 - Loudspeaker
- [050] - 70509 - EBO protective glass f. lamps-lower part
- [060] - 70508 - EBO Frame for lamps-lower part
- [070] - 33884 - Relay main switch
- [080] - 70511 - Transformer
- [090] - 70355 - Safety limit switch

Part: Power board

Part-Number: 101106



Part: Loudspeaker

Part-Number: 401523



Part: EBO protective glass f. lamps-lower part

Part-Number: 70509



Part: EBO Frame for lamps-lower part

Part-Number: 70508

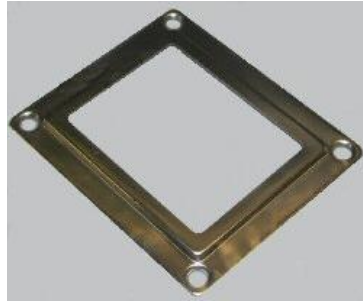

Part: Relay main switch

Part-Number: 33884



Part: Transformer

Part-Number: 70511



Part: Safety limit switch

Part-Number: 70355

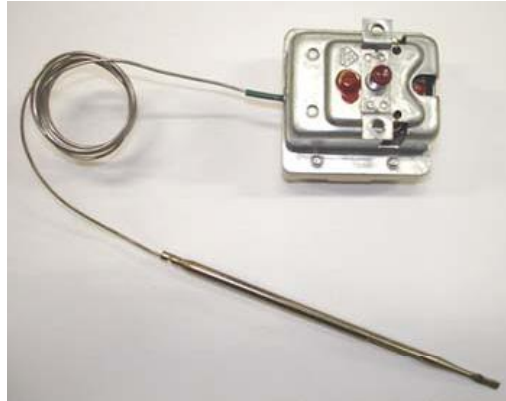

Service manual Frame EBO

Version: 2.00

Ident: B1-EBO 064

Series: EBO

Part-Number: 500176

This part can be ordered.

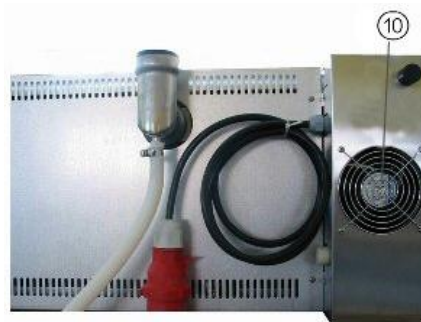

Chapter

[010] - 402662 - Axial Blower 19W heat resistance until 75°C

Part: Axial Blower 19W heat resistance until 75°C

Part-Number: 402662



Service manual Installation room EBO64 400V 50Hz

Version: 2.00

Ident: B1-EBO 064

Series: EBO

Part-Number: 500197

This part can be ordered.

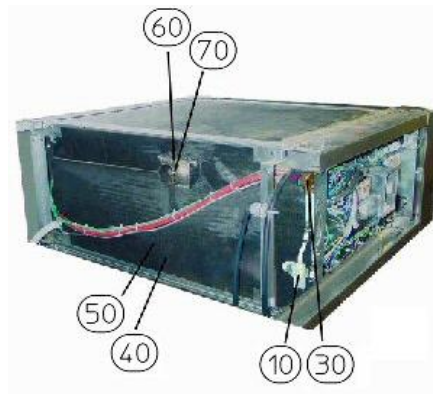

Chapter

57144 - Steam generator EBO64 400V 50Hz - V:2.00

- [010] - 403754 - Solenoid valve (flow restrictor)
- [030] - 36126 - Water flow detector flow meter FH20
- [050] - 03617 - Seal for steam generator
- [060] - 105684 - Seal for air case
- [070] - 105685 - Seal for air flap

Part: Solenoid valve (flow restrictor)

Part-Number: 403754



Part: Water flow detector flow meter FH20

Part-Number: 36126



Part: Seal for steam generator

Part-Number: 03617

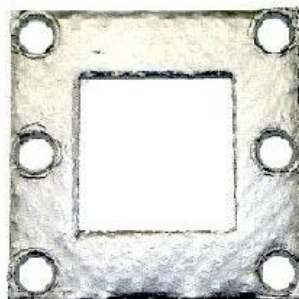

Part: Seal for air case

Part-Number: 105684

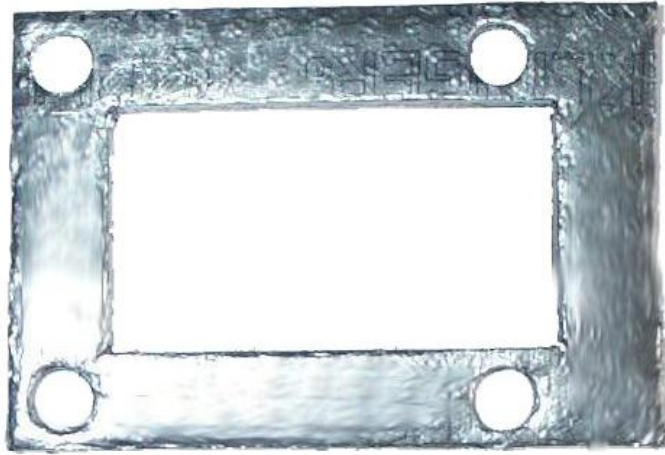

Part: Seal for air flap

Part-Number: 105685



Service manual

Steam generator EBO64 400V 50Hz

Version: 2.00

Ident: B1-EBO 064

Series: EBO

Part-Number: 57144

This part can be ordered.

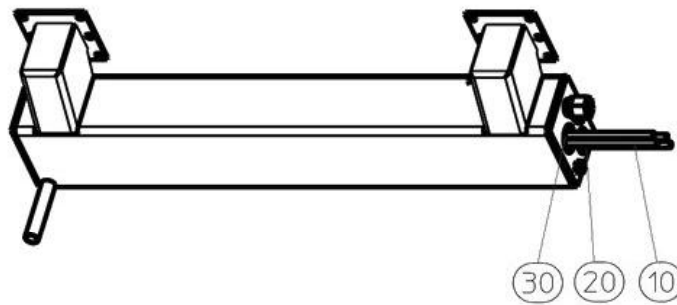

Chapter

402914 - Steam pipe connection EBO 68

402933 - Screwing

403116 - Cutting ring D12

[010] - 105680 - Tube Heater 1000W / 230V

[020] - 400263 - Type K thermocouple

[030] - 34352 - Thermostat

Part: Steam pipe connection EBO 68

Part-Number: 402914



Part: Screwing

Part-Number: 402933

Part: Cutting ring D12

Part-Number: 403116



Part: Tube Heater 1000W / 230V

Part-Number: 105680



Part: Type K thermocouple

Part-Number: 400263



Part: Thermostat

Part-Number: 34352



Urheberrecht:

Das Urheberrecht an diesem Servicehandbuch verbleibt bei der WIESHEU GmbH. Dieses Servicehandbuch ist nur für autorisierte Servicepartner und dessen Personal bestimmt. Sie enthält Vorschriften und Hinweise, die weder vollständig noch teilweise vervielfältigt, verbreitet oder anderweitig mitgeteilt werden dürfen.

Alle Darstellungen, Zeichnungen, Bilder Texte und Angaben sind urheberrechtlich geschützt. Sie unterliegen den gewerblichen Schutzrechten.

Zu diesem Servicehandbuch:

Alle Abbildungen in diesem Dokument sollen die Verständlichkeit unterstützen. Die Abbildungen sind nicht maßstabsgerecht. Teilweise sind dem Originalprodukt ähnelnde Abbildungen dargestellt, die geringfügig abweichen können.

Achtung!

Vermeiden Sie Fehlfunktionen oder Beschädigungen durch falsche Ersatzteile. Wir empfehlen die ausschließliche Verwendung von WIESHEU-Original-Ersatzteilen.

Wiesheu GmbH
Daimlerstrasse 10
DE-71563 Affalterbach
Telefon: +49 (0)7144 / 3 03-0
Fax: +49 (0)7144 / 3 03-11
Service-Telefon: 0800-WIESHEU
E-Mail: info@wiesheu.de
www.wiesheu.de

Stand: 08.06.2010